

# ELECTROMAGNETIC EMISSIONS COMPLIANCE REPORT

## INTENTIONAL RADIATOR CERTIFICATION TO FCC PART 15 SUBPART C REQUIREMENT

OF

**Product Name:** Bluetooth 4.0 USB Micro Adapter

**Brand Name:** IOGEAR

**Model No.:** GBU521

**Model Difference:** N/A

**FCC ID:** QLE-GBU521

**Report No.:** ER/2011/60018-04

**Issue Date:** Feb. 24, 2012

**FCC Rule Part:** §15.247, Cat: DSS

**Prepared for:** ATEN Technology Inc. dba IOGEAR.  
19641 Da Vinci, Foothill Ranch, CA92610, USA

**Prepared by:** SGS Taiwan Ltd.  
Electronics & Communication Laboratory  
No. 134, Wu Kung Rd., Wuku Industrial Zone,  
Taipei County, Taiwan

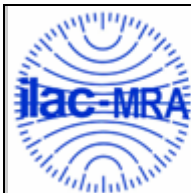

*Note: This report shall not be reproduced except in full, without the written approval of SGS Taiwan Ltd. This document may be altered or revised by SGS Taiwan Ltd. personnel only, and shall be noted in the revision section of the document.*

Unless otherwise stated the results shown in this test report refer only to the sample(s) tested and such sample(s) are retained for 90 days only.

除非另有說明，此報告結果僅對測試之樣品負責，同時此樣品僅保留90天。本報告未經本公司書面許可，不可部份複製。

This document is issued by the Company subject to its General Conditions of Service printed overleaf, available on request or accessible at [www.sgs.com/terms\\_and\\_conditions.htm](http://www.sgs.com/terms_and_conditions.htm) and for electronic format documents, subject to Terms and Conditions for Electronic Documents at [www.sgs.com/terms\\_e-document.htm](http://www.sgs.com/terms_e-document.htm). Attention is drawn to the limitation of liability, indemnification and jurisdiction issues defined therein. Any holder of this document is advised that information contained hereon reflects the Company's findings at the time of its intervention only and within the limits of Client's instructions, if any. The Company's sole responsibility is to its Client and this document does not exonerate parties to a transaction from exercising all their rights and obligations under the transaction documents. This document cannot be reproduced except in full, without prior written approval of the Company. Any unauthorized alteration, forgery or falsification of the content or appearance of this document is unlawful and offenders may be prosecuted to the fullest extent of the law.

SGS Taiwan Ltd. No.134, Wu Kung Road, Wuku Industrial Zone, Taipei County, Taiwan / 台北縣五股工業區五工路 134 號

台灣檢驗科技股份有限公司 t (886-2) 2299-3279

f (886-2) 2298-0488

[www.tw.sgs.com](http://www.tw.sgs.com)

Member of SGS Group

## VERIFICATION OF COMPLIANCE

**Applicant:** ATEN Technology Inc. dba IOGEAR.  
 19641 Da Vinci, Foothill Ranch, CA92610, USA

**Product Description:** Bluetooth 4.0 USB Micro Adapter

**Brand Name:** IOGEAR

**Model No.:** GBU521

**Model Difference:** N/A

**FCC ID:** QLE-GBU521

**File Number:** ER/2011/60018-04



**Date of test:** Feb. 22, 2012 ~ Feb. 23, 2012

**Date of EUT Received:** Feb. 22, 2012

**We hereby certify that:**

The above equipment was tested by SGS Taiwan Ltd. The test data, data evaluation, test procedures, and equipment configurations shown in this report were made in accordance with the procedures given in ANSI C63.4:2003 and the energy emitted by the sample EUT tested as described in this report is in compliance with conducted and radiated emission limits of FCC Rules Part 15.247.

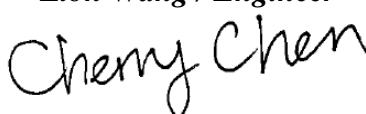
The test results of this report relate only to the tested sample identified in this report.

<b>Test By:</b>		<b>Date:</b>	Feb. 24, 2012
	_____ <i>Lion Wang / Engineer</i>		_____ 
<b>Prepared By:</b>		<b>Date:</b>	Feb. 24, 2012
	_____ <i>Cherry Chen / Clerk</i>		_____ 
<b>Approved By:</b>		<b>Date:</b>	Feb. 24, 2012
	_____ <i>Jim Chang / Supervisor</i>		_____ 

Unless otherwise stated the results shown in this test report refer only to the sample(s) tested and such sample(s) are retained for 90 days only.  
 除非另有說明，此報告結果僅對測試之樣品負責，同時此樣品僅保留90天。本報告未經本公司書面許可，不可部份複製。  
 This document is issued by the Company subject to its General Conditions of Service printed overleaf, available on request or accessible at [www.sgs.com/terms\\_and\\_conditions.htm](http://www.sgs.com/terms_and_conditions.htm) and for electronic format documents, subject to Terms and Conditions for Electronic Documents at [www.sgs.com/terms\\_e-document.htm](http://www.sgs.com/terms_e-document.htm). Attention is drawn to the limitation of liability, indemnification and jurisdiction issues defined therein. Any holder of this document is advised that information contained hereon reflects the Company's findings at the time of its intervention only and within the limits of Client's instructions, if any. The Company's sole responsibility is to its Client and this document does not exonerate parties to a transaction from exercising all their rights and obligations under the transaction documents. This document cannot be reproduced except in full, without prior written approval of the Company. Any unauthorized alteration, forgery or falsification of the content or appearance of this document is unlawful and offenders may be prosecuted to the fullest extent of the law.

## Version

Version No.	Date	Description
00	Feb. 24, 2012	Initial creation of document

Unless otherwise stated the results shown in this test report refer only to the sample(s) tested and such sample(s) are retained for 90 days only.

除非另有說明，此報告結果僅對測試之樣品負責，同時此樣品僅保留90天。本報告未經本公司書面許可，不可部份複製。

This document is issued by the Company subject to its General Conditions of Service printed overleaf, available on request or accessible at [www.sgs.com/terms\\_and\\_conditions.htm](http://www.sgs.com/terms_and_conditions.htm) and, for electronic format documents, subject to Terms and Conditions for Electronic Documents at [www.sgs.com/terms\\_e-document.htm](http://www.sgs.com/terms_e-document.htm). Attention is drawn to the limitation of liability, indemnification and jurisdiction issues defined therein. Any holder of this document is advised that information contained hereon reflects the Company's findings at the time of its intervention only and within the limits of Client's instructions, if any. The Company's sole responsibility is to its Client and this document does not exonerate parties to a transaction from exercising all their rights and obligations under the transaction documents. This document cannot be reproduced except in full, without prior written approval of the Company. Any unauthorized alteration, forgery or falsification of the content or appearance of this document is unlawful and offenders may be prosecuted to the fullest extent of the law.

SGS Taiwan Ltd. No.134, Wu Kung Road, Wuku Industrial Zone, Taipei County, Taiwan / 台北縣五股工業區五工路 134 號

台灣檢驗科技股份有限公司 t (886-2) 2299-3279

f (886-2) 2298-0488

[www.tw.sgs.com](http://www.tw.sgs.com)

Member of SGS Group

## Table of Contents

<b>1. GENERAL INFORMATION .....</b>	<b>6</b>
1.1. Related Submittal(s) / Grant (s) .....	7
1.2. Test Methodology .....	7
1.3. Test Facility .....	7
1.4. Special Accessories .....	7
1.5. Equipment Modifications .....	7
<b>2. SYSTEM TEST CONFIGURATION .....</b>	<b>8</b>
2.1. EUT Configuration .....	8
2.2. EUT Exercise .....	8
2.3. Test Procedure .....	8
2.4. Configuration of Tested System .....	9
<b>3. SUMMARY OF TEST RESULTS .....</b>	<b>10</b>
<b>4. DESCRIPTION OF TEST MODES .....</b>	<b>10</b>
<b>5. CONDUCTED EMISSION TEST .....</b>	<b>11</b>
5.1. Standard Applicable .....	11
5.2. EUT Setup .....	11
5.3. Measurement Procedure .....	11
5.4. Measurement Equipment Used: .....	12
5.5. Measurement Result .....	12
<b>6. PEAK OUTPUT POWER MEASUREMENT .....</b>	<b>13</b>
6.1. Standard Applicable .....	13
6.2. Measurement Equipment Used .....	13
6.3. Test Set-up: .....	13
6.4. Measurement Procedure: .....	14
6.5. Measurement Result .....	14
<b>7. 20dB BAND WIDTH .....</b>	<b>18</b>
7.1. Standard Applicable .....	18
7.2. Measurement Equipment Used .....	18
7.3. Test Set-up .....	18
7.4. Measurement Procedure: .....	18
7.5. Measurement Result: .....	19
<b>8. 100KHz BANDWIDTH OF BAND EDGES MEASUREMENT .....</b>	<b>23</b>
8.1. Standard Applicable .....	23
8.2. Measurement Equipment Used .....	23
8.3. Test SET-UP: .....	24
8.4. Measurement Procedure .....	25
8.5. Field Strength Calculation .....	25
8.6. Measurement Result .....	25
<b>9. SPURIOUS RADIATED EMISSION TEST .....</b>	<b>34</b>
9.1. Standard Applicable .....	34
9.2. Measurement Equipment Used: .....	34
9.3. Test SET-UP: .....	34
9.4. Measurement Procedure: .....	34
9.5. Field Strength Calculation .....	35
9.6. Measurement Result: .....	35

Unless otherwise stated the results shown in this test report refer only to the sample(s) tested and such sample(s) are retained for 90 days only.

除非另有說明，此報告結果僅對測試之樣品負責，同時此樣品僅保留90天。本報告未經本公司書面許可，不可部份複製。

This document is issued by the Company subject to its General Conditions of Service printed overleaf, available on request or accessible at [www.sgs.com/terms\\_and\\_conditions.htm](http://www.sgs.com/terms_and_conditions.htm) and for electronic format documents, subject to Terms and Conditions for Electronic Documents at [www.sgs.com/terms\\_e-document.htm](http://www.sgs.com/terms_e-document.htm). Attention is drawn to the limitation of liability, indemnification and jurisdiction issues defined therein. Any holder of this document is advised that information contained hereon reflects the Company's findings at the time of its intervention only and within the limits of Client's instructions, if any. The Company's sole responsibility is to its Client and this document does not exonerate parties to a transaction from exercising all their rights and obligations under the transaction documents. This document cannot be reproduced except in full, without prior written approval of the Company. Any unauthorized alteration, forgery or falsification of the content or appearance of this document is unlawful and offenders may be prosecuted to the fullest extent of the law.

SGS Taiwan Ltd. No.134, Wu Kung Road, Wuku Industrial Zone, Taipei County, Taiwan / 台北縣五股工業區五工路 134 號

台灣檢驗科技股份有限公司 t (886-2) 2299-3279

f (886-2) 2298-0488

[www.tw.sgs.com](http://www.tw.sgs.com)

Member of SGS Group

<b>10. FREQUENCY SEPARATION .....</b>	<b>48</b>
10.1. Standard Applicable .....	48
10.2. Measurement Equipment Used: .....	48
10.3. Test Set-up: .....	48
10.4. Measurement Procedure: .....	48
10.5. Measurement Result: .....	48
<b>11. NUMBER OF HOPPING FREQUENCY .....</b>	<b>50</b>
11.1. Standard Applicable .....	50
11.2. Measurement Equipment Used: .....	50
11.3. Test Set-up: .....	50
11.4. Measurement Procedure: .....	50
11.5. Measurement Result: .....	50
<b>12. TIME OF OCCUPANCY (DWELL TIME) .....</b>	<b>52</b>
12.1. Standard Applicable .....	52
12.2. Measurement Equipment Used: .....	52
12.3. Test Set-up: .....	52
12.4. Measurement Procedure: .....	52
12.5. Measurement Result .....	53
<b>13. ANTENNA REQUIREMENT .....</b>	<b>59</b>
13.1. Standard Applicable .....	59
13.2. Antenna Connected Construction .....	59
<b>14. RF EXPOSURE .....</b>	<b>60</b>
14.1. Standard Applicable .....	60
14.2. Measurement Result: .....	60

Unless otherwise stated the results shown in this test report refer only to the sample(s) tested and such sample(s) are retained for 90 days only.

除非另有說明，此報告結果僅對測試之樣品負責，同時此樣品僅保留90天。本報告未經本公司書面許可，不可部份複製。

This document is issued by the Company subject to its General Conditions of Service printed overleaf, available on request or accessible at [www.sgs.com/terms\\_and\\_conditions.htm](http://www.sgs.com/terms_and_conditions.htm) and, for electronic format documents, subject to Terms and Conditions for Electronic Documents at [www.sgs.com/terms\\_e-document.htm](http://www.sgs.com/terms_e-document.htm). Attention is drawn to the limitation of liability, indemnification and jurisdiction issues defined therein. Any holder of this document is advised that information contained hereon reflects the Company's findings at the time of its intervention only and within the limits of Client's instructions, if any. The Company's sole responsibility is to its Client and this document does not exonerate parties to a transaction from exercising all their rights and obligations under the transaction documents. This document cannot be reproduced except in full, without prior written approval of the Company. Any unauthorized alteration, forgery or falsification of the content or appearance of this document is unlawful and offenders may be prosecuted to the fullest extent of the law.

SGS Taiwan Ltd. No.134, Wu Kung Road, Wuku Industrial Zone, Taipei County, Taiwan / 台北縣五股工業區五工路 134 號

台灣檢驗科技股份有限公司 t (886-2) 2299-3279

f (886-2) 2298-0488

[www.tw.sgs.com](http://www.tw.sgs.com)

Member of SGS Group

## 1. GENERAL INFORMATION

### General:

Product Name:	Bluetooth 4.0 USB Micro Adapter
Brand Name:	IOGEAR
Model No.:	GBU521
Model Difference:	N/A
Hardware Version:	289G1D4300-A0
Software Version:	00-1D4300-03[F/W,BT-400][V 3]
Power Supply:	5Vdc form USB port

### Bluetooth:

Frequency Range:	2402 – 2480MHz
Bluetooth Version:	V2.1 + EDR (GFSK + $\pi/4$ DQPSK + 8DPSK)
Channel number:	79 channels
Modulation type:	Frequency Hopping Spread Spectrum
Transmit Power:	0.05 dBm (Peak)
Dwell Time:	$\leq 0.4$ s
Operating Mode:	Point-to-Point
Antenna Designation:	PCB Antenna , 0.6dBi

This test report applies for Bluetooth function.

Unless otherwise stated the results shown in this test report refer only to the sample(s) tested and such sample(s) are retained for 90 days only.

除非另有說明，此報告結果僅對測試之樣品負責，同時此樣品僅保留90天。本報告未經本公司書面許可，不可部份複製。

This document is issued by the Company subject to its General Conditions of Service printed overleaf, available on request or accessible at [www.sgs.com/terms\\_and\\_conditions.htm](http://www.sgs.com/terms_and_conditions.htm) and for electronic format documents, subject to Terms and Conditions for Electronic Documents at [www.sgs.com/terms\\_e-document.htm](http://www.sgs.com/terms_e-document.htm). Attention is drawn to the limitation of liability, indemnification and jurisdiction issues defined therein. Any holder of this document is advised that information contained hereon reflects the Company's findings at the time of its intervention only and within the limits of Client's instructions, if any. The Company's sole responsibility is to its Client and this document does not exonerate parties to a transaction from exercising all their rights and obligations under the transaction documents. This document cannot be reproduced except in full, without prior written approval of the Company. Any unauthorized alteration, forgery or falsification of the content or appearance of this document is unlawful and offenders may be prosecuted to the fullest extent of the law.

SGS Taiwan Ltd. No.134, Wu Kung Road, Wuku Industrial Zone, Taipei County, Taiwan / 台北縣五股工業區五工路 134 號

台灣檢驗科技股份有限公司 t (886-2) 2299-3279

f (886-2) 2298-0488

[www.tw.sgs.com](http://www.tw.sgs.com)

Member of SGS Group

### 1.1. Related Submittal(s) / Grant (s)

This submittal(s) (test report) is intended for **FCC ID: QLE-GBU521** filing to comply with Section 15.247 of the FCC Part 15, Subpart C Rules. The composite system (digital device) is compliance with Subpart B is authorized under a Doc procedure.

### 1.2. Test Methodology

Both conducted and radiated testing were performed according to the procedures in ANSI C63.4: 2003. Radiated testing was performed at an antenna to EUT distance 3 meters.

Tested in accordance with FCC Public Notice DA 00-705

### 1.3. Test Facility

The measurement facilities used to collect the 3m Radiated Emission and AC power line conducted data are located on the address of SGS Taiwan Ltd. Electronics & Communication Laboratory No. 134, Wu Kung Rd., Wuku Industrial Zone, Taipei Country, Taiwan which are constructed and calibrated to meet the FCC requirements in documents ANSI C63.4: 2003. FCC Registration Number are: 990257 and 236194, Canada Registration Number: 4620A-4

The 10 m Open Area Test Sites located on the address of SGS Taiwan Ltd. Electronics & Communication Laboratory No. 29, Pau-Tou-Tsuo Valley Chia-Pau Tsuen, Linkou Hsiang, Taipei county, which is constructed and calibrated to meet the CISPR 22/EN 55022 requirements. SGS Site No. 1(3 &10 meters) and FCC Registration Number: 94644.

### 1.4. Special Accessories

Not available for this EUT intended for grant.

### 1.5. Equipment Modifications

Not available for this EUT intended for grant.

Unless otherwise stated the results shown in this test report refer only to the sample(s) tested and such sample(s) are retained for 90 days only.

除非另有說明，此報告結果僅對測試之樣品負責，同時此樣品僅保留90天。本報告未經本公司書面許可，不可部份複製。

This document is issued by the Company subject to its General Conditions of Service printed overleaf, available on request or accessible at [www.sgs.com/terms\\_and\\_conditions.htm](http://www.sgs.com/terms_and_conditions.htm) and, for electronic format documents, subject to Terms and Conditions for Electronic Documents at [www.sgs.com/terms\\_e-document.htm](http://www.sgs.com/terms_e-document.htm). Attention is drawn to the limitation of liability, indemnification and jurisdiction issues defined therein. Any holder of this document is advised that information contained hereon reflects the Company's findings at the time of its intervention only and within the limits of Client's instructions, if any. The Company's sole responsibility is to its Client and this document does not exonerate parties to a transaction from exercising all their rights and obligations under the transaction documents. This document cannot be reproduced except in full, without prior written approval of the Company. Any unauthorized alteration, forgery or falsification of the content or appearance of this document is unlawful and offenders may be prosecuted to the fullest extent of the law.

SGS Taiwan Ltd. No.134, Wu Kung Road, Wuku Industrial Zone, Taipei County, Taiwan / 台北縣五股工業區五工路 134 號

台灣檢驗科技股份有限公司 t (886-2) 2299-3279

f (886-2) 2298-0488

[www.tw.sgs.com](http://www.tw.sgs.com)

Member of SGS Group

## 2. SYSTEM TEST CONFIGURATION

### 2.1. EUT Configuration

The EUT configuration for testing is installed on RF field strength measurement to meet the Commissions requirement and operating in a manner which intends to maximize its emission characteristics in a continuous normal application.

### 2.2. EUT Exercise

The EUT (Transmitter) was operated in the engineering mode to fix the Tx frequency that was for the purpose of the measurements.

### 2.3. Test Procedure

#### 2.3.1 Conducted Emissions

The EUT is a placed on as turn table which is 0.8 m above ground plane. According to the requirements in Section 7 and 13 of ANSI C63.4: 2003. Conducted emissions from the EUT measured in the frequency range between 0.15 MHz and 30MHz using CISPR Quasi-Peak and Average detector mode.

#### 2.3.2 Radiated Emissions

The EUT is a placed on as turn table which is 0.8 m above ground plane. The turn table shall rotate 360 degrees to determine the position of maximum emission level. EUT is set 3m away from the receiving antenna which varied from 1m to 4m to find out the highest emission. And also, each emission was to be maximized by changing the polarization of receiving antenna both horizontal and vertical. In order to find out the max. emission, the relative positions of this hand-held transmitter (EUT) was rotated through three orthogonal axes and measurement procedures for electric field radiated emissions above 1 GHz the EUT measurement is to be made “while keeping the antenna in the ‘cone of radiation’ from that area and pointed at the area both in azimuth and elevation, with polarization oriented for maximum response.” is still within the 3dB illumination BW of the measurement antenna. according to the requirements in Section 8 and 13 and Subclause 8.3.1.2 of ANSI C63.4: 2003.

Unless otherwise stated the results shown in this test report refer only to the sample(s) tested and such sample(s) are retained for 90 days only.

除非另有說明，此報告結果僅對測試之樣品負責，同時此樣品僅保留90天。本報告未經本公司書面許可，不可部份複製。

This document is issued by the Company subject to its General Conditions of Service printed overleaf, available on request or accessible at [www.sgs.com/terms\\_and\\_conditions.htm](http://www.sgs.com/terms_and_conditions.htm) and for electronic format documents, subject to Terms and Conditions for Electronic Documents at [www.sgs.com/terms\\_e-document.htm](http://www.sgs.com/terms_e-document.htm). Attention is drawn to the limitation of liability, indemnification and jurisdiction issues defined therein. Any holder of this document is advised that information contained hereon reflects the Company's findings at the time of its intervention only and within the limits of Client's instructions, if any. The Company's sole responsibility is to its Client and this document does not exonerate parties to a transaction from exercising all their rights and obligations under the transaction documents. This document cannot be reproduced except in full, without prior written approval of the Company. Any unauthorized alteration, forgery or falsification of the content or appearance of this document is unlawful and offenders may be prosecuted to the fullest extent of the law.

SGS Taiwan Ltd. No.134, Wu Kung Road, Wuku Industrial Zone, Taipei County, Taiwan / 台北縣五股工業區五工路 134 號

台灣檢驗科技股份有限公司 t (886-2) 2299-3279

f (886-2) 2298-0488

[www.tw.sgs.com](http://www.tw.sgs.com)

Member of SGS Group



## 2.4. Configuration of Tested System

Fig. 2-1 Configuration of Tested System

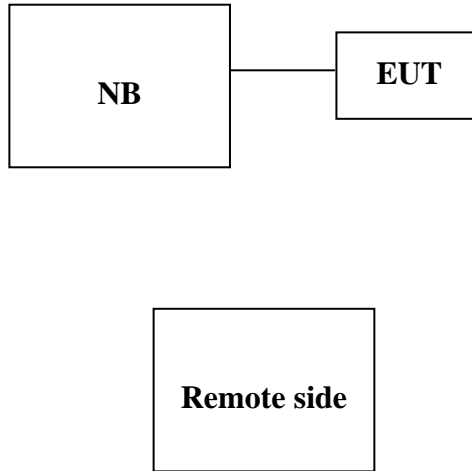

Table 2-1 Equipment Used in Tested System

Item	Equipment	Mfr/Brand	Model/Type No.	Series No.	Data Cable	Power Cord
1.	Notebook	DELL	E5400	3704625136	Un-shielding	Un-shielding
2.	Bluetooth Test Set	Anritsu	MT8852B	6k00006107	Un-shielding	Un-shielding

Unless otherwise stated the results shown in this test report refer only to the sample(s) tested and such sample(s) are retained for 90 days only.

除非另有說明，此報告結果僅對測試之樣品負責，同時此樣品僅保留90天。本報告未經本公司書面許可，不可部份複製。

This document is issued by the Company subject to its General Conditions of Service printed overleaf, available on request or accessible at [www.sgs.com/terms\\_and\\_conditions.htm](http://www.sgs.com/terms_and_conditions.htm) and for electronic format documents, subject to Terms and Conditions for Electronic Documents at [www.sgs.com/terms\\_e-document.htm](http://www.sgs.com/terms_e-document.htm). Attention is drawn to the limitation of liability, indemnification and jurisdiction issues defined therein. Any holder of this document is advised that information contained hereon reflects the Company's findings at the time of its intervention only and within the limits of Client's instructions, if any. The Company's sole responsibility is to its Client and this document does not exonerate parties to a transaction from exercising all their rights and obligations under the transaction documents. This document cannot be reproduced except in full, without prior written approval of the Company. Any unauthorized alteration, forgery or falsification of the content or appearance of this document is unlawful and offenders may be prosecuted to the fullest extent of the law.

SGS Taiwan Ltd. No.134, Wu Kung Road, Wuku Industrial Zone, Taipei County, Taiwan / 台北縣五股工業區五工路 134 號

台灣檢驗科技股份有限公司 t (886-2) 2299-3279

f (886-2) 2298-0488

[www.tw.sgs.com](http://www.tw.sgs.com)

Member of SGS Group

### 3. SUMMARY OF TEST RESULTS

FCC Rules	Description Of Test	Result
§15.207(a)	Conducted Emission	N/A
§15.247(b)(1)	Peak Output Power	Compliant
§15.247(a)	20dB Bandwidth	No Limit
§15.247I	100 KHz Bandwidth Of Frequency Band Edges	Compliant
§15.209(a) (f)	Spurious Emission	Compliant
§15.247(a)(1)	Frequency Separation	Compliant
§15.247(a)(1)(iii)	Number of hopping frequency	Compliant
§15.247(a)(1)(iii)	Time of Occupancy	Compliant
§15.203, §15.247(b)(4)(i)	Antenna Requirement	Compliant

### 4. DESCRIPTION OF TEST MODES

The EUT has been tested under operating condition.

Test program used to control the EUT for staying in continuous transmitting and receiving mode is programmed.

Channel low (2402MHz) 、mid (2441MHz) and high (2480MHz) with worst case EDR mode is chosen for full testing.

Unless otherwise stated the results shown in this test report refer only to the sample(s) tested and such sample(s) are retained for 90 days only.

除非另有說明，此報告結果僅對測試之樣品負責，同時此樣品僅保留90天。本報告未經本公司書面許可，不可部份複製。

This document is issued by the Company subject to its General Conditions of Service printed overleaf, available on request or accessible at [www.sgs.com/terms\\_and\\_conditions.htm](http://www.sgs.com/terms_and_conditions.htm) and for electronic format documents, subject to Terms and Conditions for Electronic Documents at [www.sgs.com/terms\\_e-document.htm](http://www.sgs.com/terms_e-document.htm). Attention is drawn to the limitation of liability, indemnification and jurisdiction issues defined therein. Any holder of this document is advised that information contained hereon reflects the Company's findings at the time of its intervention only and within the limits of Client's instructions, if any. The Company's sole responsibility is to its Client and this document does not exonerate parties to a transaction from exercising all their rights and obligations under the transaction documents. This document cannot be reproduced except in full, without prior written approval of the Company. Any unauthorized alteration, forgery or falsification of the content or appearance of this document is unlawful and offenders may be prosecuted to the fullest extent of the law.

SGS Taiwan Ltd. No.134, Wu Kung Road, Wuku Industrial Zone, Taipei County, Taiwan / 台北縣五股工業區五工路 134 號

台灣檢驗科技股份有限公司 t (886-2) 2299-3279

f (886-2) 2298-0488

[www.tw.sgs.com](http://www.tw.sgs.com)

Member of SGS Group

## 5. CONDUCTED EMISSION TEST

### 5.1. Standard Applicable

According to §15.207, frequency within 150KHz to 30MHz shall not exceed the limit table as below.

Frequency range MHz	Limits dB(uV)	
	Quasi-peak	Average
0.15 to 0.50	66 to 56	56 to 46
0.50 to 5	56	46
5 to 30	60	50

Note

- 1.The lower limit shall apply at the transition frequencies
- 2.The limit decreases linearly with the logarithm of the frequency in the range 0.15 MHz to 0.50 MHz.

### 5.2. EUT Setup

1. The conducted emission tests were performed in the test site, using the setup in accordance with the ANSI C63.4: 2003.
2. The EUT was plug-in the AC/DC Power adapter. The host system was placed on the center of the back edge on the test table. The peripherals was placed on the side of the host PC system. The rear of the EUT and peripherals were placed flushed with the rear of the tabletop.
3. The spacing between the peripherals was 10 centimeters.
4. External I/O cables were draped along the edge of the test table and bundle when necessary.
5. The host system was connected with 120Vac/60Hz power source.

### 5.3. Measurement Procedure

1. The EUT was placed on a table which is 0.8m above ground plane.
2. Maximum procedure was performed on the six highest emissions to ensure EUT compliance.
3. Repeat above procedures until all frequency measured were complete.

Unless otherwise stated the results shown in this test report refer only to the sample(s) tested and such sample(s) are retained for 90 days only.

除非另有說明，此報告結果僅對測試之樣品負責，同時此樣品僅保留90天。本報告未經本公司書面許可，不可部份複製。

This document is issued by the Company subject to its General Conditions of Service printed overleaf, available on request or accessible at [www.sgs.com/terms\\_and\\_conditions.htm](http://www.sgs.com/terms_and_conditions.htm) and for electronic format documents, subject to Terms and Conditions for Electronic Documents at [www.sgs.com/terms\\_e-document.htm](http://www.sgs.com/terms_e-document.htm). Attention is drawn to the limitation of liability, indemnification and jurisdiction issues defined therein. Any holder of this document is advised that information contained hereon reflects the Company's findings at the time of its intervention only and within the limits of Client's instructions, if any. The Company's sole responsibility is to its Client and this document does not exonerate parties to a transaction from exercising all their rights and obligations under the transaction documents. This document cannot be reproduced except in full, without prior written approval of the Company. Any unauthorized alteration, forgery or falsification of the content or appearance of this document is unlawful and offenders may be prosecuted to the fullest extent of the law.

SGS Taiwan Ltd. No.134, Wu Kung Road, Wuku Industrial Zone, Taipei County, Taiwan / 台北縣五股工業區五工路 134 號

台灣檢驗科技股份有限公司 t (886-2) 2299-3279

f (886-2) 2298-0488

[www.tw.sgs.com](http://www.tw.sgs.com)

Member of SGS Group

**5.4. Measurement Equipment Used:**

Conducted Emission Test Site					
EQUIPMENT TYPE	MFR	MODEL NUMBER	SERIAL NUMBER	LAST CAL.	CAL DUE.
EMI Test Receiver	R&S	ESCS30	828985/004	09/23/2010	09/22/2012
LISN	Rolf-Heine	NNB-2/16Z	99012	03/31/2011	03/30/2012
LISN	FCC	FCC-LISN-50/250-25-2-01	04034	03/31/2011	03/30/2012
Coaxial Cables	N/A	WK CE Cable	N/A	01/04/2011	01/05/2013

**5.5. Measurement Result**

The initial step in collecting conducted data is a spectrum analyzer peak scan of the measurement range. Significant peaks are then marked as shown on the following data page, and these signals are then quasi-peaked.

Test Result: 5V DC powered by USB port

Unless otherwise stated the results shown in this test report refer only to the sample(s) tested and such sample(s) are retained for 90 days only.

除非另有說明，此報告結果僅對測試之樣品負責，同時此樣品僅保留90天。本報告未經本公司書面許可，不可部份複製。

This document is issued by the Company subject to its General Conditions of Service printed overleaf, available on request or accessible at [www.sgs.com/terms\\_and\\_conditions.htm](http://www.sgs.com/terms_and_conditions.htm) and, for electronic format documents, subject to Terms and Conditions for Electronic Documents at [www.sgs.com/terms\\_e-document.htm](http://www.sgs.com/terms_e-document.htm). Attention is drawn to the limitation of liability, indemnification and jurisdiction issues defined therein. Any holder of this document is advised that information contained hereon reflects the Company's findings at the time of its intervention only and within the limits of Client's instructions, if any. The Company's sole responsibility is to its Client and this document does not exonerate parties to a transaction from exercising all their rights and obligations under the transaction documents. This document cannot be reproduced except in full, without prior written approval of the Company. Any unauthorized alteration, forgery or falsification of the content or appearance of this document is unlawful and offenders may be prosecuted to the fullest extent of the law.

## 6. PEAK OUTPUT POWER MEASUREMENT

### 6.1. Standard Applicable

For frequency hopping systems operating in the 2400-2483.5 MHz band employing at least 75 hopping channels, and all frequency hopping systems in the 5725-5850MHz band: 1Watt. For all other frequency hopping systems in the 2400 – 2483.5MHz band: 0.125 Watts.

### 6.2. Measurement Equipment Used

Conducted Emission Test Site					
EQUIPMENT TYPE	MFR	MODEL NUMBER	SERIAL NUMBER	LAST CAL.	CAL DUE.
Power Sensor	Anritsu	MA2411B	917032	01/16/2012	01/17/2014
Power Meter	Anritsu	ML2495A	1005007	02/17/2012	02/16/2014
Spectrum Analyzer	Agilent	E4446A	MY43360126	04/19/2010	04/18/2012
Spectrum Analyzer	Agilent	E4440A	MY45304525	01/25/2011	01/24/2013
DC Block	Agilent	BLK-18	155452	07/05/2012	07/04/2013
Low Loss Cable	HUBER+SUHNER	SUCOFLEX 104PEA	N/A	01/05/2012	01/04/2013
Attenuator	Mini-Circuit	BW-S6W5	001	01/05/2012	01/04/2013
Attenuator	Mini-Circuit	BW-S10W5	001	01/05/2012	01/04/2013
Attenuator	Mini-Circuit	BW-S20W5	001	01/05/2012	01/04/2013
Splitter	Agilent	11636B	N/A	01/05/2012	01/04/2013

### 6.3. Test Set-up:

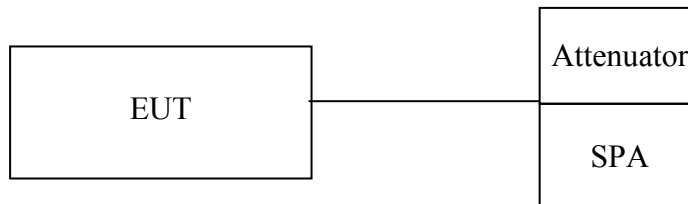

Unless otherwise stated the results shown in this test report refer only to the sample(s) tested and such sample(s) are retained for 90 days only.

除非另有說明，此報告結果僅對測試之樣品負責，同時此樣品僅保留90天。本報告未經本公司書面許可，不可部份複製。

This document is issued by the Company subject to its General Conditions of Service printed overleaf, available on request or accessible at [www.sgs.com/terms\\_and\\_conditions.htm](http://www.sgs.com/terms_and_conditions.htm) and, for electronic format documents, subject to Terms and Conditions for Electronic Documents at [www.sgs.com/terms\\_e-document.htm](http://www.sgs.com/terms_e-document.htm). Attention is drawn to the limitation of liability, indemnification and jurisdiction issues defined therein. Any holder of this document is advised that information contained hereon reflects the Company's findings at the time of its intervention only and within the limits of Client's instructions, if any. The Company's sole responsibility is to its Client and this document does not exonerate parties to a transaction from exercising all their rights and obligations under the transaction documents. This document cannot be reproduced except in full, without prior written approval of the Company. Any unauthorized alteration, forgery or falsification of the content or appearance of this document is unlawful and offenders may be prosecuted to the fullest extent of the law.

SGS Taiwan Ltd. No.134, Wu Kung Road, Wuku Industrial Zone, Taipei County, Taiwan / 台北縣五股工業區五工路 134 號

台灣檢驗科技股份有限公司 t (886-2) 2299-3279

f (886-2) 2298-0488

[www.tw.sgs.com](http://www.tw.sgs.com)

Member of SGS Group

**6.4. Measurement Procedure:**

1. Place the EUT on the table and set it in transmitting mode.
2. Remove the antenna from the EUT and then connect a low loss RF cable from the antenna port to the power meter or spectrum. (Max peak function, >20dB bandwidth, >=RBW)
3. Record the max. reading.
4. Repeat above procedures until all frequency measured were complete.

**6.5. Measurement Result**

**BDR mode:**

Frequency (MHz)	Reading Power (dBm)	Output Power (dBm)	Output Power (W)	Limit (W)
2402.00	-3.38	-3.38	0.00046	1
2441.00	-4.08	-4.08	0.00039	1
2480.00	-3.59	-3.59	0.00044	1

**EDR mode:**

Frequency (MHz)	Reading Power (dBm)	Output Power (dBm)	Output Power (W)	Limit (W)
2402.00	0.05	0.05	0.00101	1
2441.00	-0.81	-0.81	0.00083	1
2480.00	-0.24	-0.24	0.00095	1

*\*Note: offset 6dB*

Note: Refer to next page for plots.

Unless otherwise stated the results shown in this test report refer only to the sample(s) tested and such sample(s) are retained for 90 days only.

除非另有說明，此報告結果僅對測試之樣品負責，同時此樣品僅保留90天。本報告未經本公司書面許可，不可部份複製。

This document is issued by the Company subject to its General Conditions of Service printed overleaf, available on request or accessible at [www.sgs.com/terms\\_and\\_conditions.htm](http://www.sgs.com/terms_and_conditions.htm) and, for electronic format documents, subject to Terms and Conditions for Electronic Documents at [www.sgs.com/terms\\_e-document.htm](http://www.sgs.com/terms_e-document.htm). Attention is drawn to the limitation of liability, indemnification and jurisdiction issues defined therein. Any holder of this document is advised that information contained hereon reflects the Company's findings at the time of its intervention only and within the limits of Client's instructions, if any. The Company's sole responsibility is to its Client and this document does not exonerate parties to a transaction from exercising all their rights and obligations under the transaction documents. This document cannot be reproduced except in full, without prior written approval of the Company. Any unauthorized alteration, forgery or falsification of the content or appearance of this document is unlawful and offenders may be prosecuted to the fullest extent of the law.

**Peak Power Output Data Plot (CH Low) (BDR mode)**

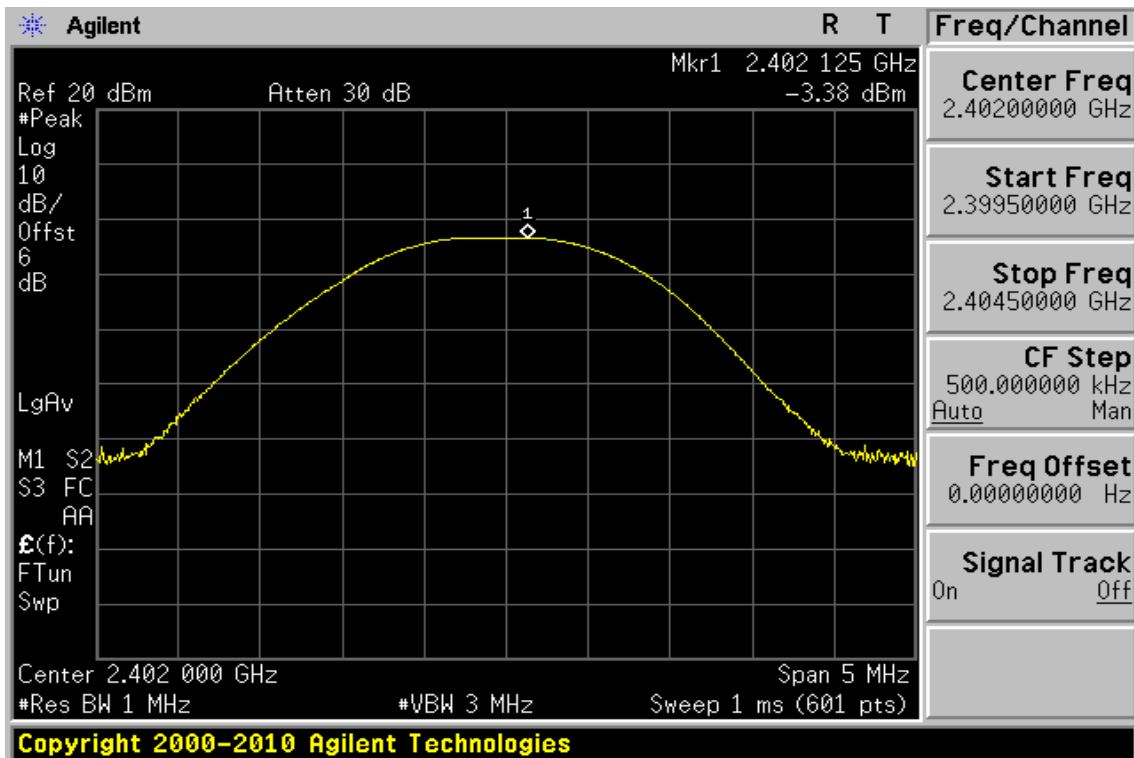

**Peak Power Output Data Plot (CH Mid) (BDR mode)**

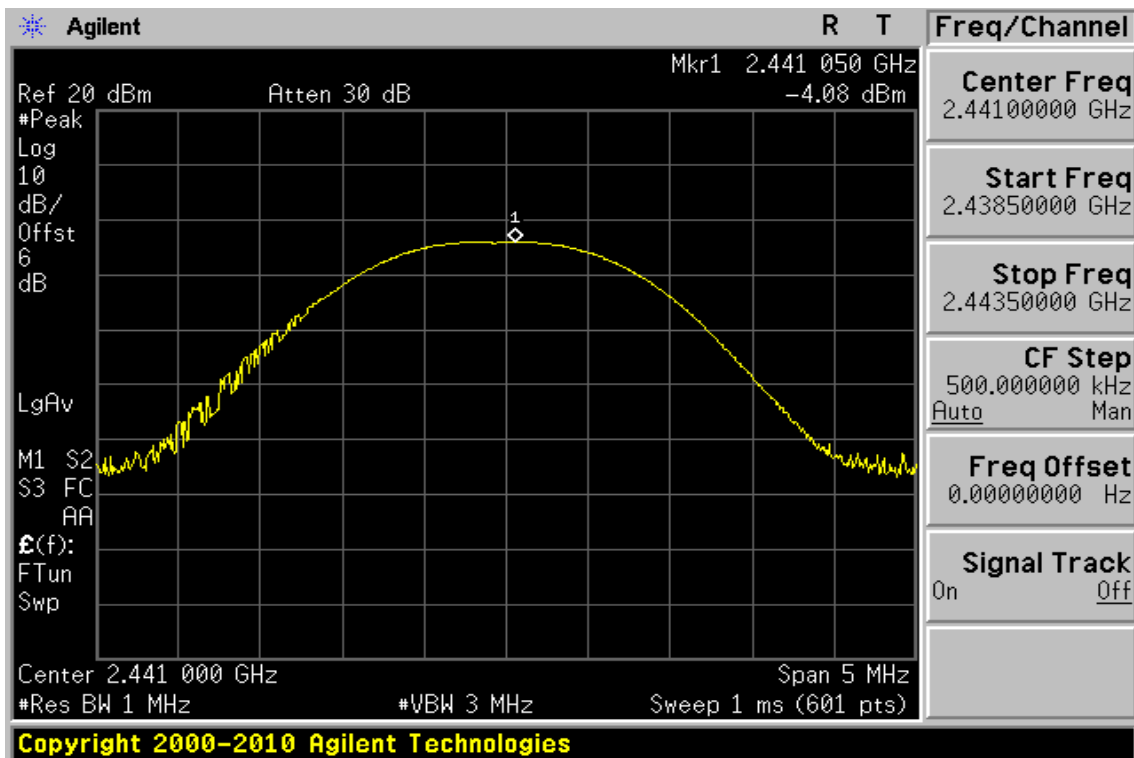

Unless otherwise stated the results shown in this test report refer only to the sample(s) tested and such sample(s) are retained for 90 days only.

除非另有說明，此報告結果僅對測試之樣品負責，同時此樣品僅保留90天。本報告未經本公司書面許可，不可部份複製。

This document is issued by the Company subject to its General Conditions of Service printed overleaf, available on request or accessible at [www.sgs.com/terms\\_and\\_conditions.htm](http://www.sgs.com/terms_and_conditions.htm) and for electronic format documents, subject to Terms and Conditions for Electronic Documents at [www.sgs.com/terms\\_e-document.htm](http://www.sgs.com/terms_e-document.htm). Attention is drawn to the limitation of liability, indemnification and jurisdiction issues defined therein. Any holder of this document is advised that information contained hereon reflects the Company's findings at the time of its intervention only and within the limits of Client's instructions, if any. The Company's sole responsibility is to its Client and this document does not exonerate parties to a transaction from exercising all their rights and obligations under the transaction documents. This document cannot be reproduced except in full, without prior written approval of the Company. Any unauthorized alteration, forgery or falsification of the content or appearance of this document is unlawful and offenders may be prosecuted to the fullest extent of the law.

SGS Taiwan Ltd. No.134, Wu Kung Road, Wuku Industrial Zone, Taipei County, Taiwan / 台北縣五股工業區五工路 134 號

**Peak Power Output Data Plot (CH High) (BDR mode)**

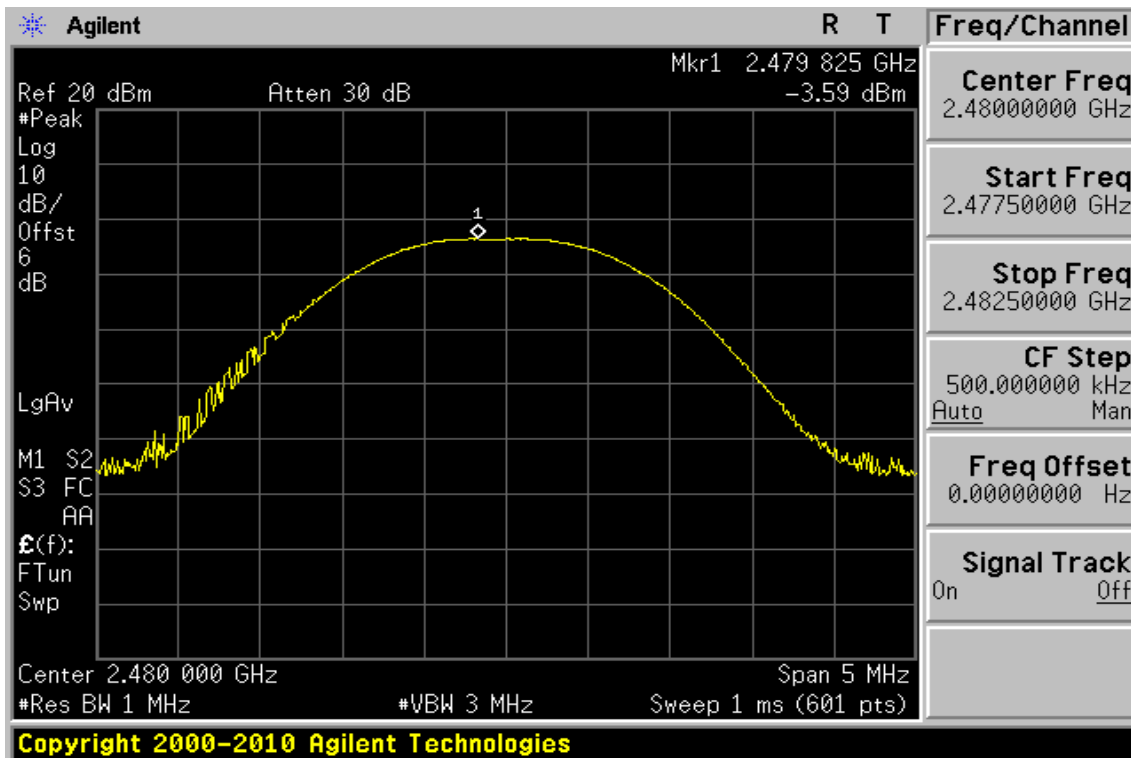

**Peak Power Output Data Plot (CH Low) (EDR mode)**

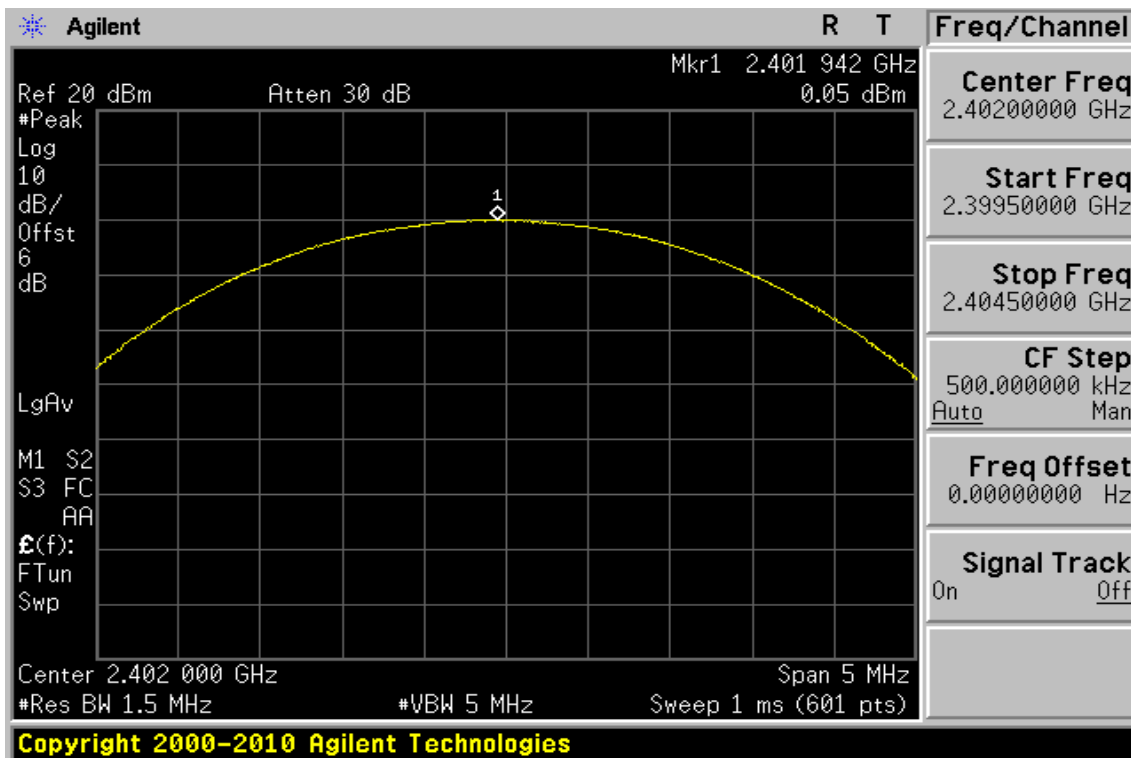

Unless otherwise stated the results shown in this test report refer only to the sample(s) tested and such sample(s) are retained for 90 days only.

除非另有說明，此報告結果僅對測試之樣品負責，同時此樣品僅保留90天。本報告未經本公司書面許可，不可部份複製。

This document is issued by the Company subject to its General Conditions of Service printed overleaf, available on request or accessible at [www.sgs.com/terms\\_and\\_conditions.htm](http://www.sgs.com/terms_and_conditions.htm) and for electronic format documents, subject to Terms and Conditions for Electronic Documents at [www.sgs.com/terms\\_e-document.htm](http://www.sgs.com/terms_e-document.htm). Attention is drawn to the limitation of liability, indemnification and jurisdiction issues defined therein. Any holder of this document is advised that information contained hereon reflects the Company's findings at the time of its intervention only and within the limits of Client's instructions, if any. The Company's sole responsibility is to its Client and this document does not exonerate parties to a transaction from exercising all their rights and obligations under the transaction documents. This document cannot be reproduced except in full, without prior written approval of the Company. Any unauthorized alteration, forgery or falsification of the content or appearance of this document is unlawful and offenders may be prosecuted to the fullest extent of the law.

SGS Taiwan Ltd. No.134, Wu Kung Road, Wuku Industrial Zone, Taipei County, Taiwan / 台北縣五股工業區五工路 134 號

台灣檢驗科技股份有限公司 t (886-2) 2299-3279

f (886-2) 2298-0488

[www.tw.sgs.com](http://www.tw.sgs.com)

Member of SGS Group



**Peak Power Output Data Plot (CH Mid) (EDR mode)**

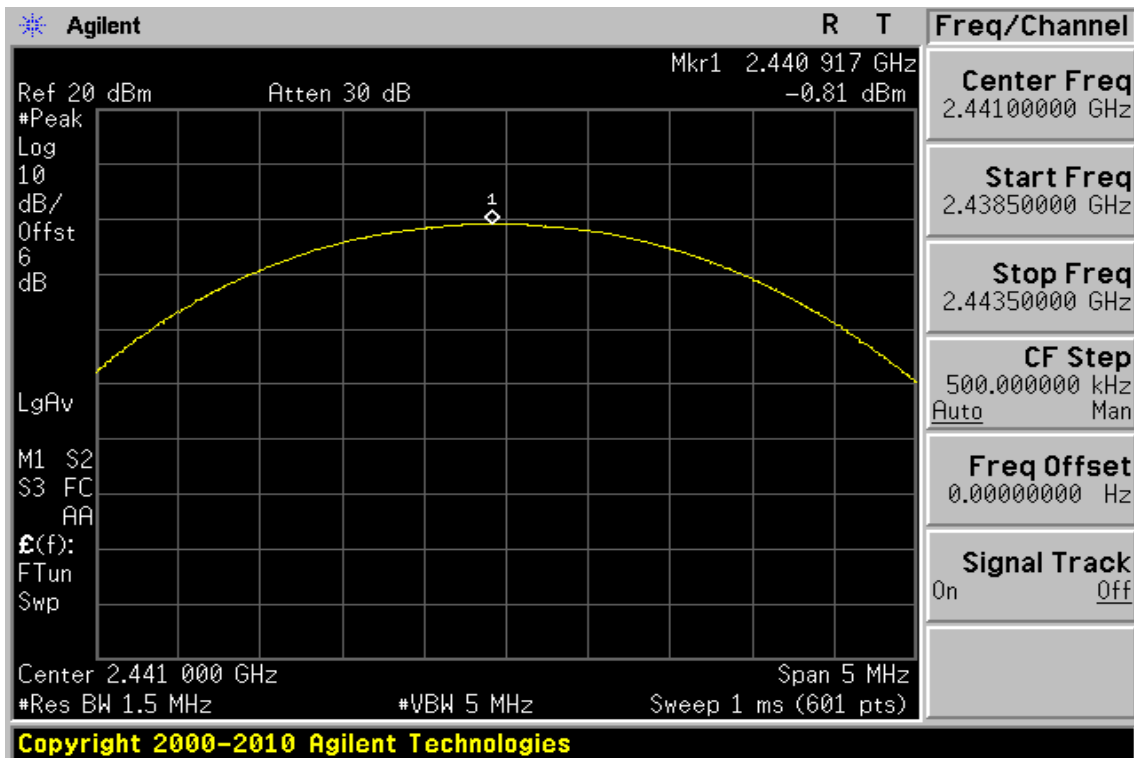

**Peak Power Output Data Plot (CH High) (EDR mode)**

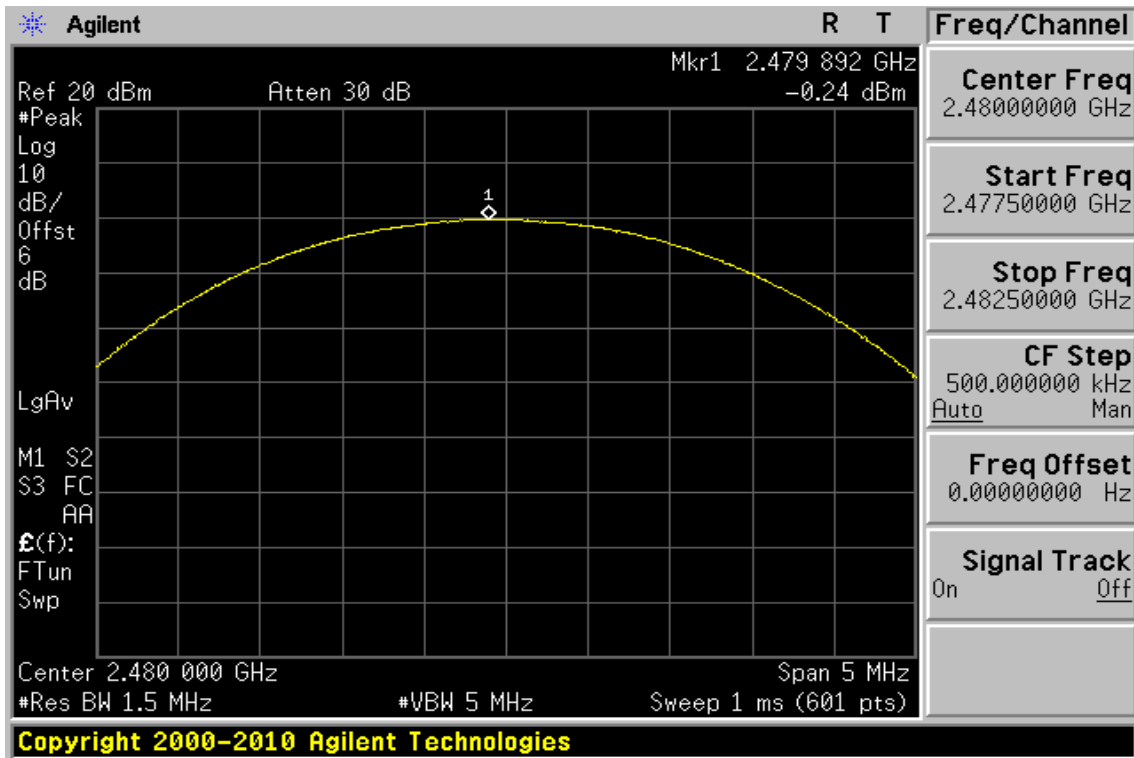

Unless otherwise stated the results shown in this test report refer only to the sample(s) tested and such sample(s) are retained for 90 days only.

除非另有說明，此報告結果僅對測試之樣品負責，同時此樣品僅保留90天。本報告未經本公司書面許可，不可部份複製。

This document is issued by the Company subject to its General Conditions of Service printed overleaf, available on request or accessible at [www.sgs.com/terms\\_and\\_conditions.htm](http://www.sgs.com/terms_and_conditions.htm) and for electronic format documents, subject to Terms and Conditions for Electronic Documents at [www.sgs.com/terms\\_e-document.htm](http://www.sgs.com/terms_e-document.htm). Attention is drawn to the limitation of liability, indemnification and jurisdiction issues defined therein. Any holder of this document is advised that information contained hereon reflects the Company's findings at the time of its intervention only and within the limits of Client's instructions, if any. The Company's sole responsibility is to its Client and this document does not exonerate parties to a transaction from exercising all their rights and obligations under the transaction documents. This document cannot be reproduced except in full, without prior written approval of the Company. Any unauthorized alteration, forgery or falsification of the content or appearance of this document is unlawful and offenders may be prosecuted to the fullest extent of the law.

SGS Taiwan Ltd. No.134, Wu Kung Road, Wuku Industrial Zone, Taipei County, Taiwan / 台北縣五股工業區五工路 134 號

## 7. 20dB BAND WIDTH

### 7.1. Standard Applicable

For frequency hopping systems operating in the 2400MHz-2483.5 MHz no limit for 20dB bandwidth.

### 7.2. Measurement Equipment Used

Refer to section 6.2 for details.

### 7.3. Test Set-up

Refer to section 6.3 for details.

### 7.4. Measurement Procedure:

1. Place the EUT on the table and set it in transmitting mode.
2. Remove the antenna from the EUT and then connect a low loss RF cable from the antenna port to the spectrum analyzer.
3. Set the spectrum analyzer as RBW=10KHz (1 % of Bandwidth.), Span= 3MHz, Sweep=auto
4. Mark the peak frequency and -20dB (upper and lower) frequency.
5. Repeat above procedures until all frequency measured were complete.

Unless otherwise stated the results shown in this test report refer only to the sample(s) tested and such sample(s) are retained for 90 days only.

除非另有說明，此報告結果僅對測試之樣品負責，同時此樣品僅保留90天。本報告未經本公司書面許可，不可部份複製。

This document is issued by the Company subject to its General Conditions of Service printed overleaf, available on request or accessible at [www.sgs.com/terms\\_and\\_conditions.htm](http://www.sgs.com/terms_and_conditions.htm) and, for electronic format documents, subject to Terms and Conditions for Electronic Documents at [www.sgs.com/terms\\_e-document.htm](http://www.sgs.com/terms_e-document.htm). Attention is drawn to the limitation of liability, indemnification and jurisdiction issues defined therein. Any holder of this document is advised that information contained hereon reflects the Company's findings at the time of its intervention only and within the limits of Client's instructions, if any. The Company's sole responsibility is to its Client and this document does not exonerate parties to a transaction from exercising all their rights and obligations under the transaction documents. This document cannot be reproduced except in full, without prior written approval of the Company. Any unauthorized alteration, forgery or falsification of the content or appearance of this document is unlawful and offenders may be prosecuted to the fullest extent of the law.

SGS Taiwan Ltd. No.134, Wu Kung Road, Wuku Industrial Zone, Taipei County, Taiwan / 台北縣五股工業區五工路 134 號

台灣檢驗科技股份有限公司 t (886-2) 2299-3279

f (886-2) 2298-0488

[www.tw.sgs.com](http://www.tw.sgs.com)

Member of SGS Group

### 7.5. Measurement Result:

#### BDR mode

CH	Bandwidth (kHz)
Lower	926.723
Mid	927.848
Higher	926.707

#### EDR mode

CH	Bandwidth (MHz)	2/3 Bandwidth (MHz)
Lower	1.282	0.855
Mid	1.288	0.859
Higher	1.309	0.873

Unless otherwise stated the results shown in this test report refer only to the sample(s) tested and such sample(s) are retained for 90 days only.

除非另有說明，此報告結果僅對測試之樣品負責，同時此樣品僅保留90天。本報告未經本公司書面許可，不可部份複製。

This document is issued by the Company subject to its General Conditions of Service printed overleaf, available on request or accessible at [www.sgs.com/terms\\_and\\_conditions.htm](http://www.sgs.com/terms_and_conditions.htm) and, for electronic format documents, subject to Terms and Conditions for Electronic Documents at [www.sgs.com/terms\\_e-document.htm](http://www.sgs.com/terms_e-document.htm). Attention is drawn to the limitation of liability, indemnification and jurisdiction issues defined therein. Any holder of this document is advised that information contained hereon reflects the Company's findings at the time of its intervention only and within the limits of Client's instructions, if any. The Company's sole responsibility is to its Client and this document does not exonerate parties to a transaction from exercising all their rights and obligations under the transaction documents. This document cannot be reproduced except in full, without prior written approval of the Company. Any unauthorized alteration, forgery or falsification of the content or appearance of this document is unlawful and offenders may be prosecuted to the fullest extent of the law.

SGS Taiwan Ltd. No.134, Wu Kung Road, Wuku Industrial Zone, Taipei County, Taiwan / 台北縣五股工業區五工路 134 號

台灣檢驗科技股份有限公司 t (886-2) 2299-3279

f (886-2) 2298-0488

[www.tw.sgs.com](http://www.tw.sgs.com)

Member of SGS Group

**BDR Mode**

**20dB Bandwidth Test Data CH-Low**

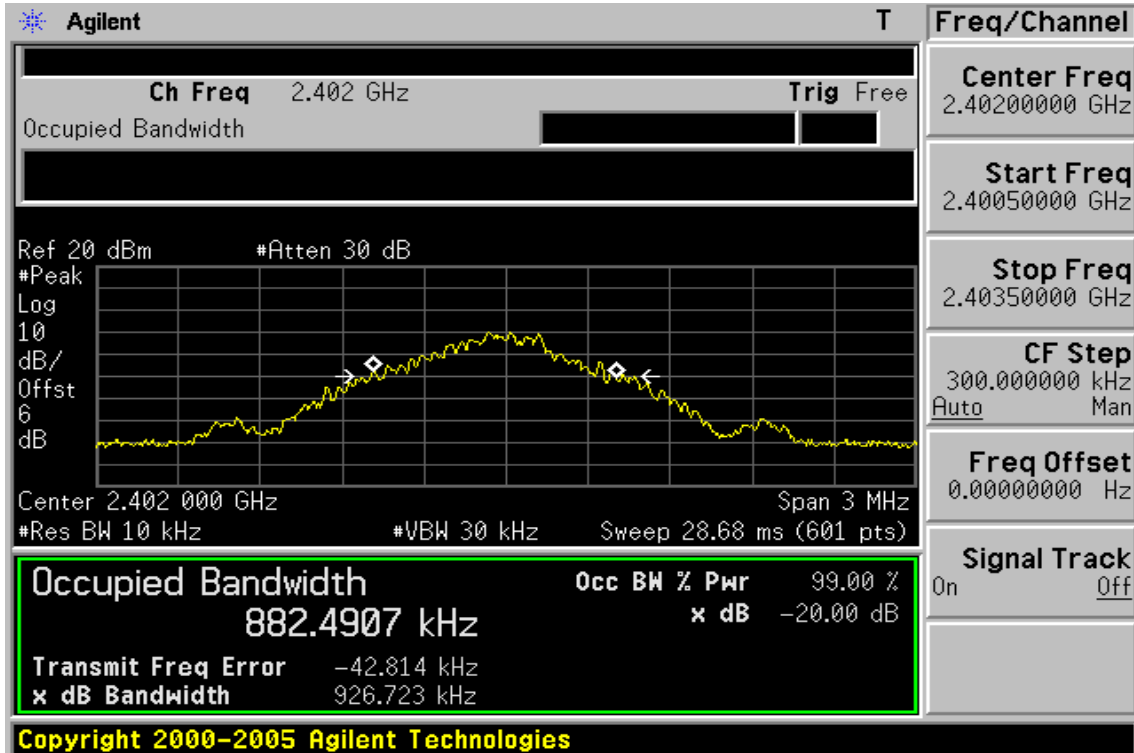

**20dB Bandwidth Test Data CH-Mid**

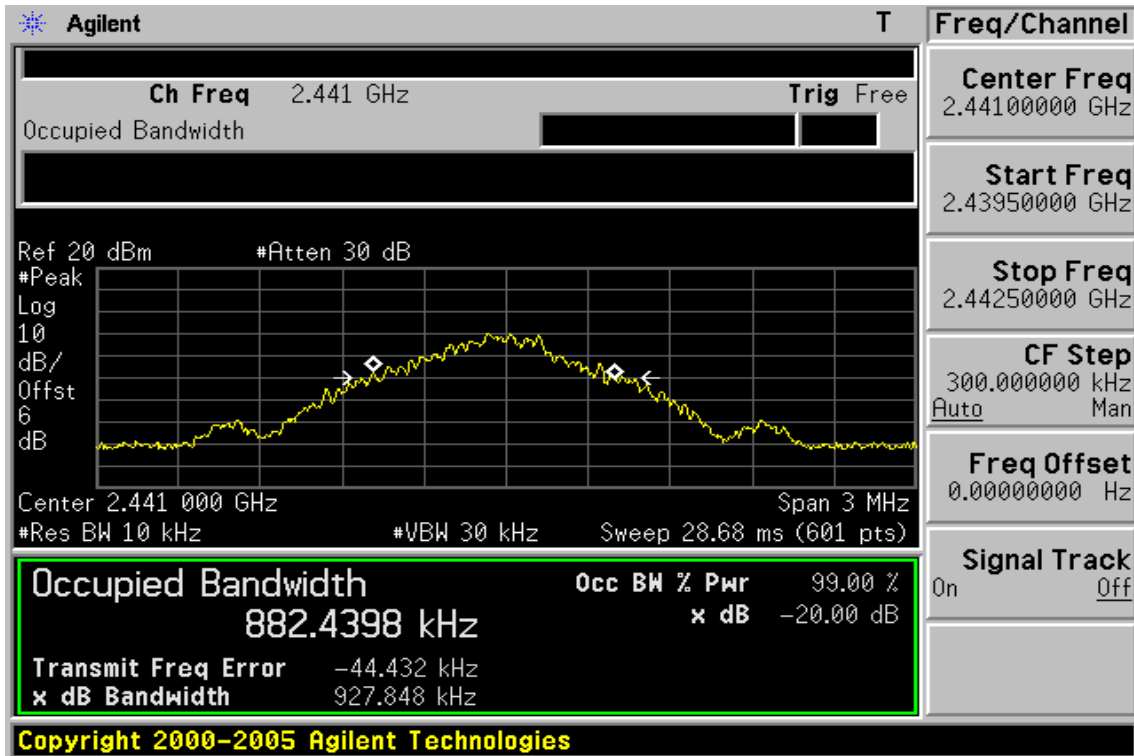

Unless otherwise stated the results shown in this test report refer only to the sample(s) tested and such sample(s) are retained for 90 days only.

除非另有說明，此報告結果僅對測試之樣品負責，同時此樣品僅保留90天。本報告未經本公司書面許可，不可部份複製。

This document is issued by the Company subject to its General Conditions of Service printed overleaf, available on request or accessible at [www.sgs.com/terms\\_and\\_conditions.htm](http://www.sgs.com/terms_and_conditions.htm) and for electronic format documents, subject to Terms and Conditions for Electronic Documents at [www.sgs.com/terms\\_e-document.htm](http://www.sgs.com/terms_e-document.htm). Attention is drawn to the limitation of liability, indemnification and jurisdiction issues defined therein. Any holder of this document is advised that information contained hereon reflects the Company's findings at the time of its intervention only and within the limits of Client's instructions, if any. The Company's sole responsibility is to its Client and this document does not exonerate parties to a transaction from exercising all their rights and obligations under the transaction documents. This document cannot be reproduced except in full, without prior written approval of the Company. Any unauthorized alteration, forgery or falsification of the content or appearance of this document is unlawful and offenders may be prosecuted to the fullest extent of the law.

SGS Taiwan Ltd. No.134, Wu Kung Road, Wuku Industrial Zone, Taipei County, Taiwan / 台北縣五股工業區五工路 134 號

台灣檢驗科技股份有限公司 t (886-2) 2299-3279

f (886-2) 2298-0488

[www.tw.sgs.com](http://www.tw.sgs.com)

Member of SGS Group

**20dB Bandwidth Test Data CH-High**

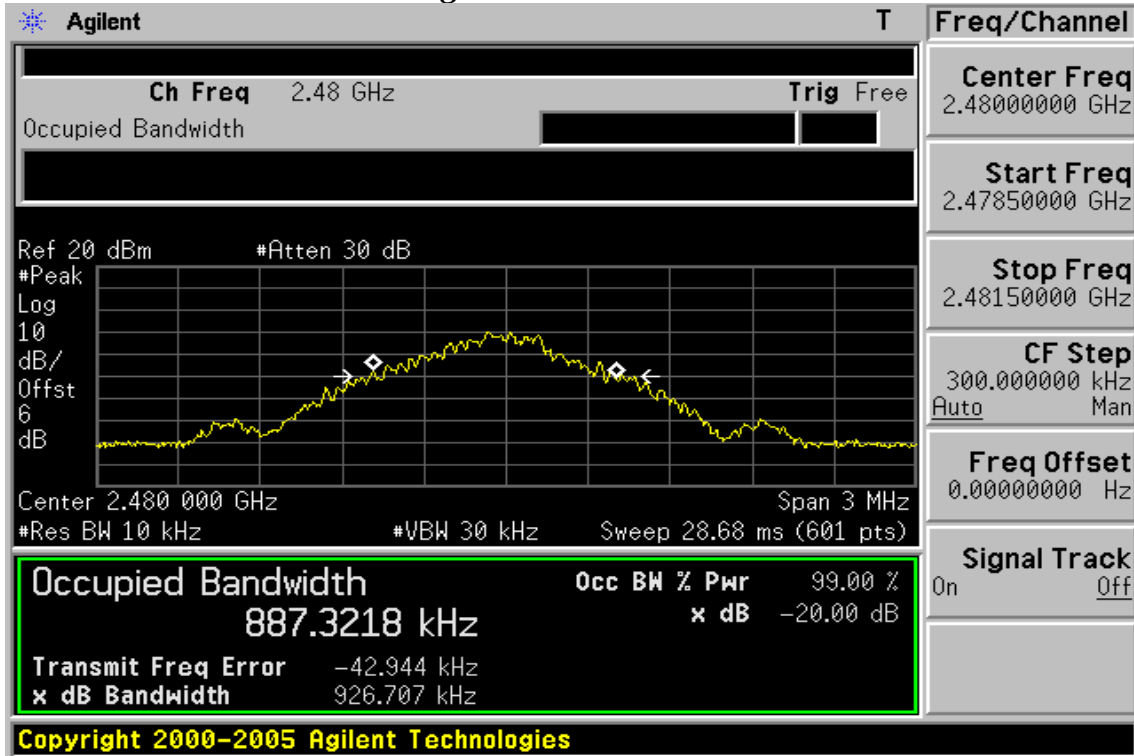

**EDR Mode**

**20dB Bandwidth Test Data CH-Low**

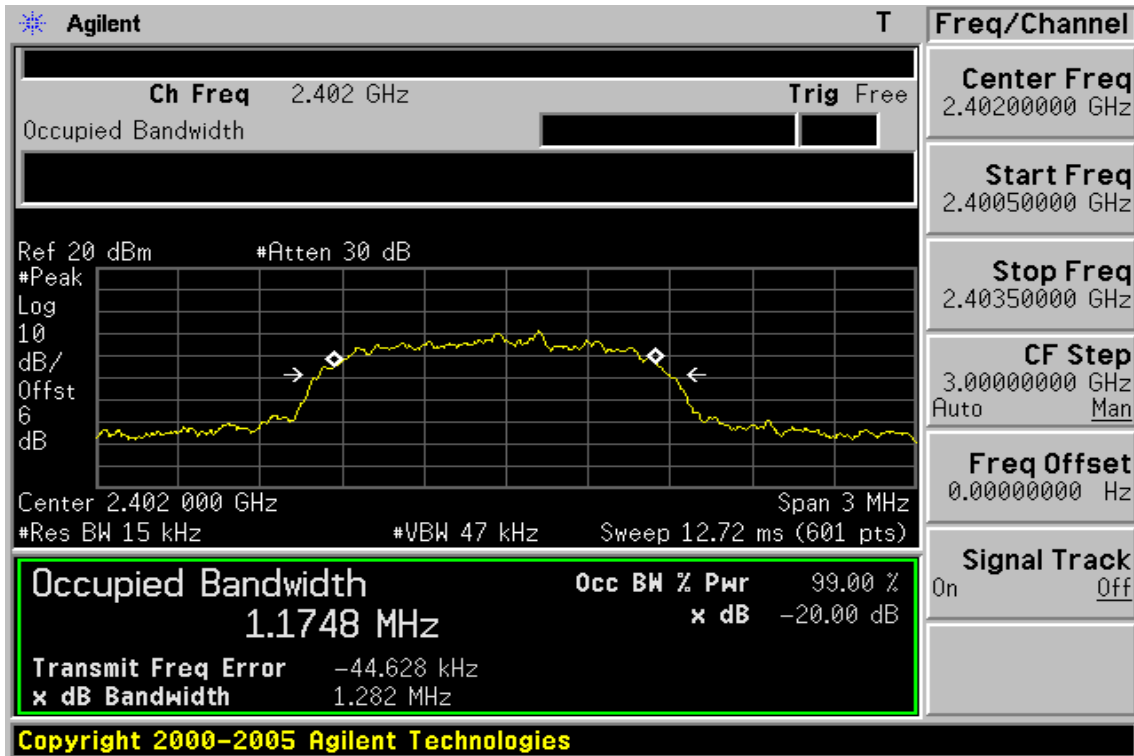

Unless otherwise stated the results in this test report refer only to the sample(s) tested and such sample(s) are retained for 90 days only.

除非另有說明，此報告結果僅對測試之樣品負責，同時此樣品僅保留90天。本報告未經本公司書面許可，不可部份複製。

This document is issued by the Company subject to its General Conditions of Service printed overleaf, available on request or accessible at [www.sgs.com/terms\\_and\\_conditions.htm](http://www.sgs.com/terms_and_conditions.htm) and for electronic format documents, subject to Terms and Conditions for Electronic Documents at [www.sgs.com/terms\\_e-document.htm](http://www.sgs.com/terms_e-document.htm). Attention is drawn to the limitation of liability, indemnification and jurisdiction issues defined therein. Any holder of this document is advised that information contained hereon reflects the Company's findings at the time of its intervention only and within the limits of Client's instructions, if any. The Company's sole responsibility is to its Client and this document does not exonerate parties to a transaction from exercising all their rights and obligations under the transaction documents. This document cannot be reproduced except in full, without prior written approval of the Company. Any unauthorized alteration, forgery or falsification of the content or appearance of this document is unlawful and offenders may be prosecuted to the fullest extent of the law.

SGS Taiwan Ltd. No.134, Wu Kung Road, Wuku Industrial Zone, Taipei County, Taiwan / 台北縣五股工業區五工路 134 號

台灣檢驗科技股份有限公司 t (886-2) 2299-3279

f (886-2) 2298-0488

[www.tw.sgs.com](http://www.tw.sgs.com)

Member of SGS Group

**20dB Bandwidth Test Data CH-Mid**

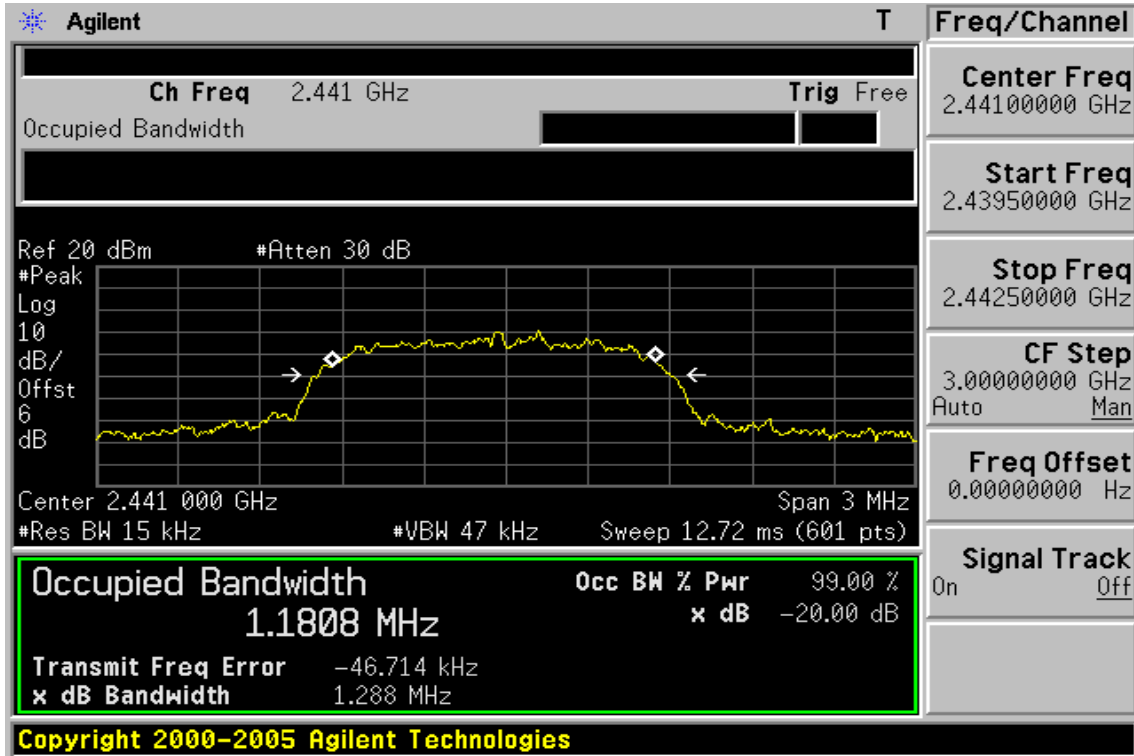

**20dB Bandwidth Test Data CH-High**

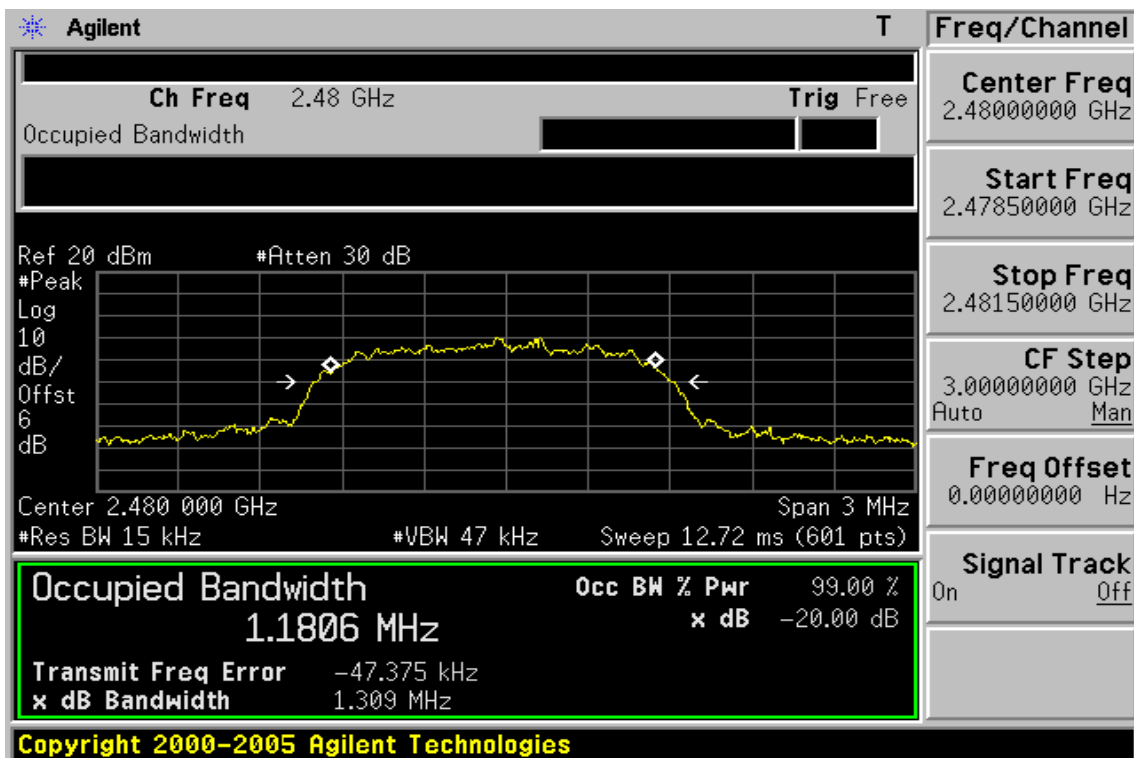

Unless otherwise stated the results shown in this test report refer only to the sample(s) tested and such sample(s) are retained for 90 days only.

除非另有說明，此報告結果僅對測試之樣品負責，同時此樣品僅保留90天。本報告未經本公司書面許可，不可部份複製。

This document is issued by the Company subject to its General Conditions of Service printed overleaf, available on request or accessible at [www.sgs.com/terms\\_and\\_conditions.htm](http://www.sgs.com/terms_and_conditions.htm) and for electronic format documents, subject to Terms and Conditions for Electronic Documents at [www.sgs.com/terms\\_e-document.htm](http://www.sgs.com/terms_e-document.htm). Attention is drawn to the limitation of liability, indemnification and jurisdiction issues defined therein. Any holder of this document is advised that information contained hereon reflects the Company's findings at the time of its intervention only and within the limits of Client's instructions, if any. The Company's sole responsibility is to its Client and this document does not exonerate parties to a transaction from exercising all their rights and obligations under the transaction documents. This document cannot be reproduced except in full, without prior written approval of the Company. Any unauthorized alteration, forgery or falsification of the content or appearance of this document is unlawful and offenders may be prosecuted to the fullest extent of the law.

SGS Taiwan Ltd. No.134, Wu Kung Road, Wuku Industrial Zone, Taipei County, Taiwan / 台北縣五股工業區五工路 134 號

## 8. 100KHz BANDWIDTH OF BAND EDGES MEASUREMENT

### 8.1. Standard Applicable

According to §15.247(c), in any 100 KHz bandwidth outside the frequency bands in which the spread spectrum intentional radiator in operating, the radio frequency power that is produced by the intentional radiator shall be at least 20dB below that in the 100KHz bandwidth within the band that contains the highest level of the desired power, In addition, radiated emissions which fall in the restricted bands, as defined in §15.205(a), must also comply with the radiated emission limits specified in 15.209(a).

### 8.2. Measurement Equipment Used

#### 8.2.1. Conducted Emission at antenna port:

Refer to section 6.2 for details.

#### 8.2.2. Radiated emission:

966 Chamber					
EQUIPMENT TYPE	MFR	MODEL NUMBER	SERIAL NUMBER	LAST CAL.	CAL DUE.
Spectrum Analyzer	R&S	FSP 40	100034	03/30/2011	03/29/2012
Bilog Antenna	SCHWAZBECK	VULB9160	3136	11/19/2011	11/18/2013
Horn antenna	ETS.LINDGREN	3117	123995	03/19/2011	03/18/2013
Pre-Amplifier	Agilent	8447D	1937A02834	11/28/2011	11/27/2013
Pre-Amplifier	Agilent	8449B	3008A01973	01/05/2012	01/04/2013
Turn Table	HD	DT420	N/A	N.C.R	N.C.R
Antenna Tower	HD	MA240-N	240/657	N.C.R	N.C.R
Controller	HD	HD100	N/A	N.C.R	N.C.R
Low Loss Cable	HUBER+SUHNER	SUCOFLEX 104PEA-10M	10m	01/04/2012	01/05/2013
Low Loss Cable	HUBER+SUHNER	SUCOFLEX 104PEA-3M	3m	01/04/2012	01/05/2013
3m Site	SGS	966 chamber	N/A	07/15/2011	07/15/2011

Unless otherwise stated the results shown in this test report refer only to the sample(s) tested and such sample(s) are retained for 90 days only.

除非另有說明，此報告結果僅對測試之樣品負責，同時此樣品僅保留90天。本報告未經本公司書面許可，不可部份複製。

This document is issued by the Company subject to its General Conditions of Service printed overleaf, available on request or accessible at [www.sgs.com/terms\\_and\\_conditions.htm](http://www.sgs.com/terms_and_conditions.htm) and for electronic format documents, subject to Terms and Conditions for Electronic Documents at [www.sgs.com/terms\\_e-document.htm](http://www.sgs.com/terms_e-document.htm). Attention is drawn to the limitation of liability, indemnification and jurisdiction issues defined therein. Any holder of this document is advised that information contained hereon reflects the Company's findings at the time of its intervention only and within the limits of Client's instructions, if any. The Company's sole responsibility is to its Client and this document does not exonerate parties to a transaction from exercising all their rights and obligations under the transaction documents. This document cannot be reproduced except in full, without prior written approval of the Company. Any unauthorized alteration, forgery or falsification of the content or appearance of this document is unlawful and offenders may be prosecuted to the fullest extent of the law.

SGS Taiwan Ltd. No.134, Wu Kung Road, Wuku Industrial Zone, Taipei County, Taiwan / 台北縣五股工業區五工路 134 號

台灣檢驗科技股份有限公司 t (886-2) 2299-3279

f (886-2) 2298-0488

[www.tw.sgs.com](http://www.tw.sgs.com)

Member of SGS Group

**8.3. Test SET-UP:**

**8.3.1. Conducted Emission at antenna port:**

Refer to section 6.3 for details.

**8.3.2. Radiated emission:**

**(A) Radiated Emission Test Set-Up, Frequency Below 1000MHz**

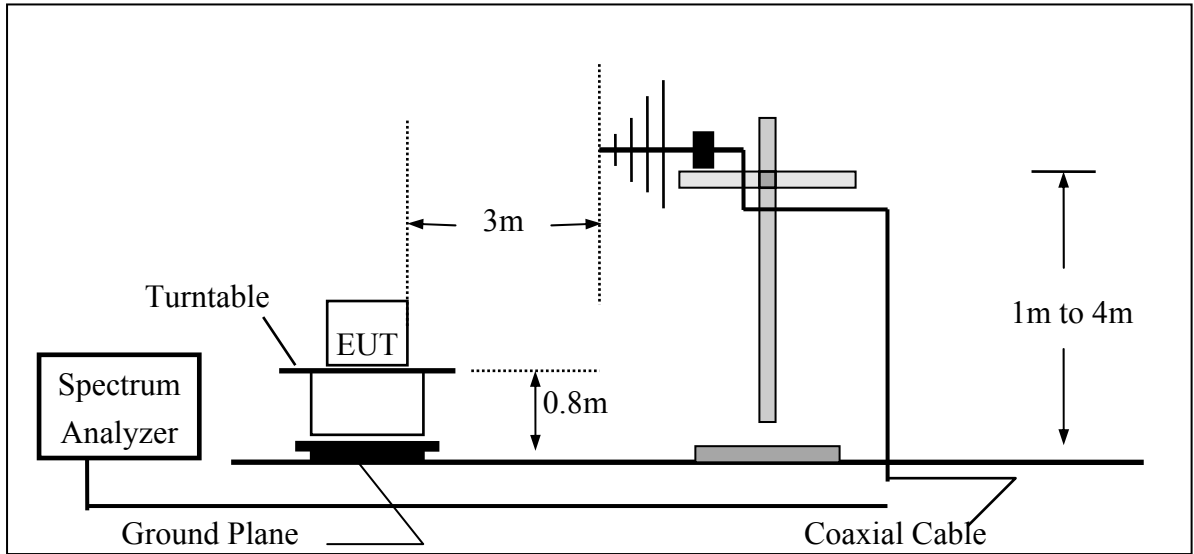

**(B) Radiated Emission Test Set-UP Frequency Over 1 GHz**

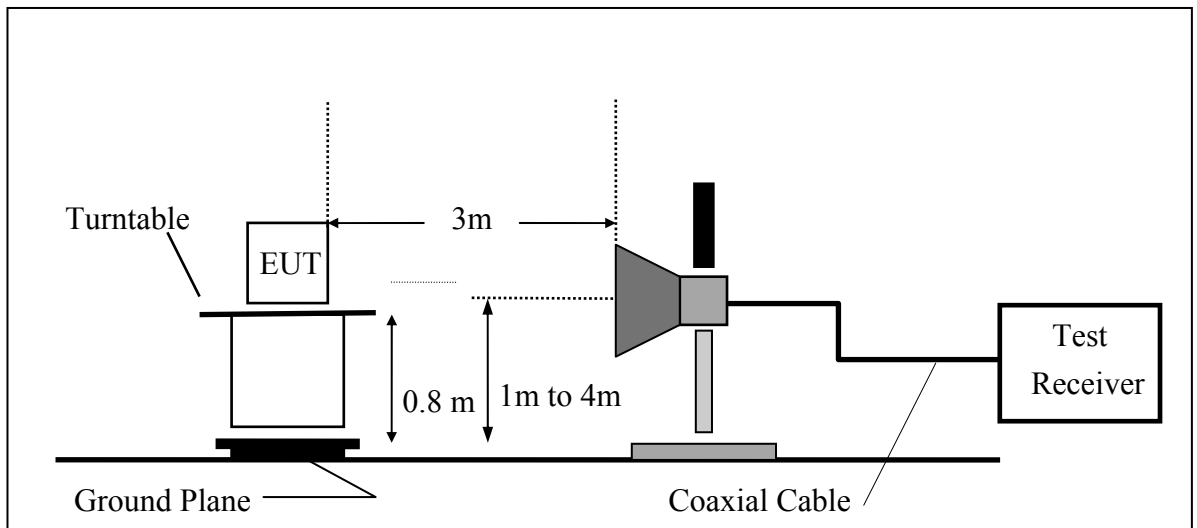

Unless otherwise stated the results shown in this test report refer only to the sample(s) tested and such sample(s) are retained for 90 days only.

除非另有說明，此報告結果僅對測試之樣品負責，同時此樣品僅保留90天。本報告未經本公司書面許可，不可部份複製。

This document is issued by the Company subject to its General Conditions of Service printed overleaf, available on request or accessible at [www.sgs.com/terms\\_and\\_conditions.htm](http://www.sgs.com/terms_and_conditions.htm) and, for electronic format documents, subject to Terms and Conditions for Electronic Documents at [www.sgs.com/terms\\_e-document.htm](http://www.sgs.com/terms_e-document.htm). Attention is drawn to the limitation of liability, indemnification and jurisdiction issues defined therein. Any holder of this document is advised that information contained hereon reflects the Company's findings at the time of its intervention only and within the limits of Client's instructions, if any. The Company's sole responsibility is to its Client and this document does not exonerate parties to a transaction from exercising all their rights and obligations under the transaction documents. This document cannot be reproduced except in full, without prior written approval of the Company. Any unauthorized alteration, forgery or falsification of the content or appearance of this document is unlawful and offenders may be prosecuted to the fullest extent of the law.

SGS Taiwan Ltd. No.134, Wu Kung Road, Wuku Industrial Zone, Taipei County, Taiwan / 台北縣五股工業區五工路 134 號



#### 8.4. Measurement Procedure

1. Place the EUT on the table and set it in transmitting mode.
2. Remove the antenna from the EUT and then connect a low loss RF cable from the antenna port to the spectrum analyzer.
3. Set center frequency of spectrum analyzer = operating frequency.
4. Set the spectrum analyzer as RBW, VBW=100KHz, Span=25MHz, Sweep = auto
5. Mark Peak, 2.390GHz and 2.4835GHz and record the max. level.
6. Repeat above procedures until all frequency measured were complete.
7. Radiated Emission refer to section 9.

#### 8.5. Field Strength Calculation

The field strength is calculated by adding the Antenna Factor and Cable Factor and subtracting the Amplifier Gain and Duty Cycle Correction Factor(if any) from the measured reading. The basic equation with a sample calculation is as follows:

$$FS = RA + AF + CL - AG$$

Where	FS = Field Strength	CL = Cable Attenuation Factor (Cable Loss)
	RA = Reading Amplitude	AG = Amplifier Gain
	AF = Antenna Factor	

#### 8.6. Measurement Result

Note: Refer to next page spectrum analyzer data chart and tabular data sheets.

Unless otherwise stated the results shown in this test report refer only to the sample(s) tested and such sample(s) are retained for 90 days only.

除非另有說明，此報告結果僅對測試之樣品負責，同時此樣品僅保留90天。本報告未經本公司書面許可，不可部份複製。

This document is issued by the Company subject to its General Conditions of Service printed overleaf, available on request or accessible at [www.sgs.com/terms\\_and\\_conditions.htm](http://www.sgs.com/terms_and_conditions.htm) and, for electronic format documents, subject to Terms and Conditions for Electronic Documents at [www.sgs.com/terms\\_e-document.htm](http://www.sgs.com/terms_e-document.htm). Attention is drawn to the limitation of liability, indemnification and jurisdiction issues defined therein. Any holder of this document is advised that information contained hereon reflects the Company's findings at the time of its intervention only and within the limits of Client's instructions, if any. The Company's sole responsibility is to its Client and this document does not exonerate parties to a transaction from exercising all their rights and obligations under the transaction documents. This document cannot be reproduced except in full, without prior written approval of the Company. Any unauthorized alteration, forgery or falsification of the content or appearance of this document is unlawful and offenders may be prosecuted to the fullest extent of the law.

SGS Taiwan Ltd. No.134, Wu Kung Road, Wuku Industrial Zone, Taipei County, Taiwan / 台北縣五股工業區五工路 134 號

台灣檢驗科技股份有限公司 t (886-2) 2299-3279

f (886-2) 2298-0488

[www.tw.sgs.com](http://www.tw.sgs.com)

Member of SGS Group

**BDR Mode**

**Band Edges Test Data CH-Low**

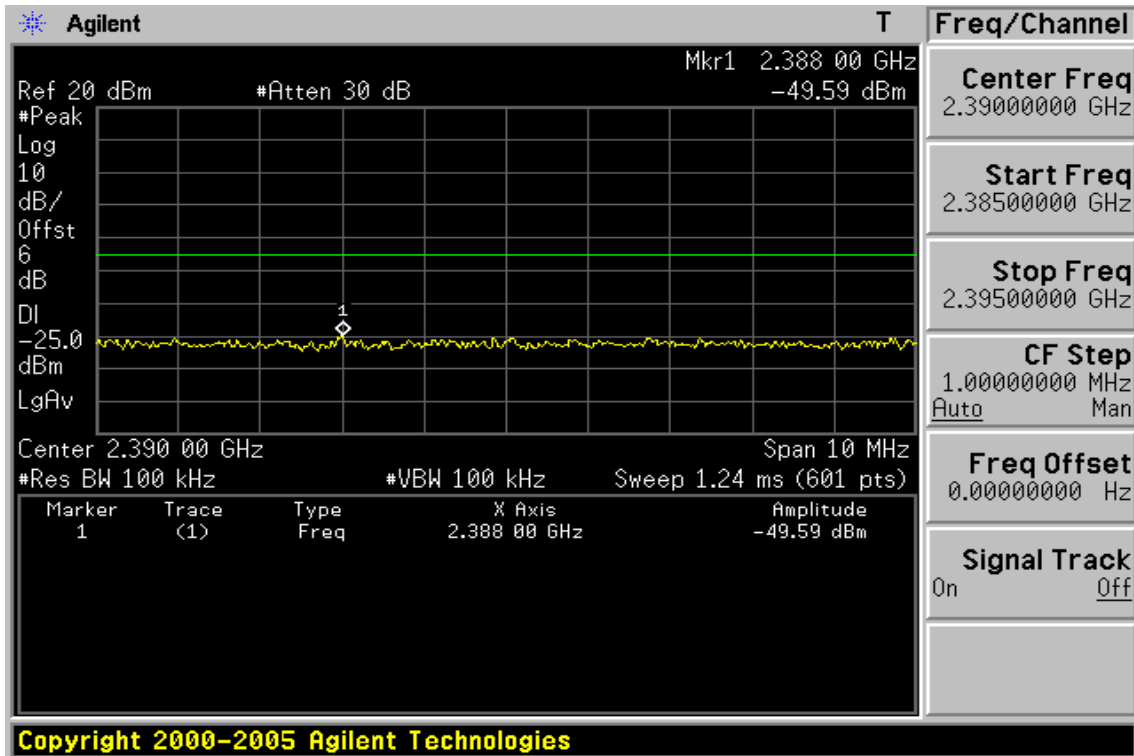
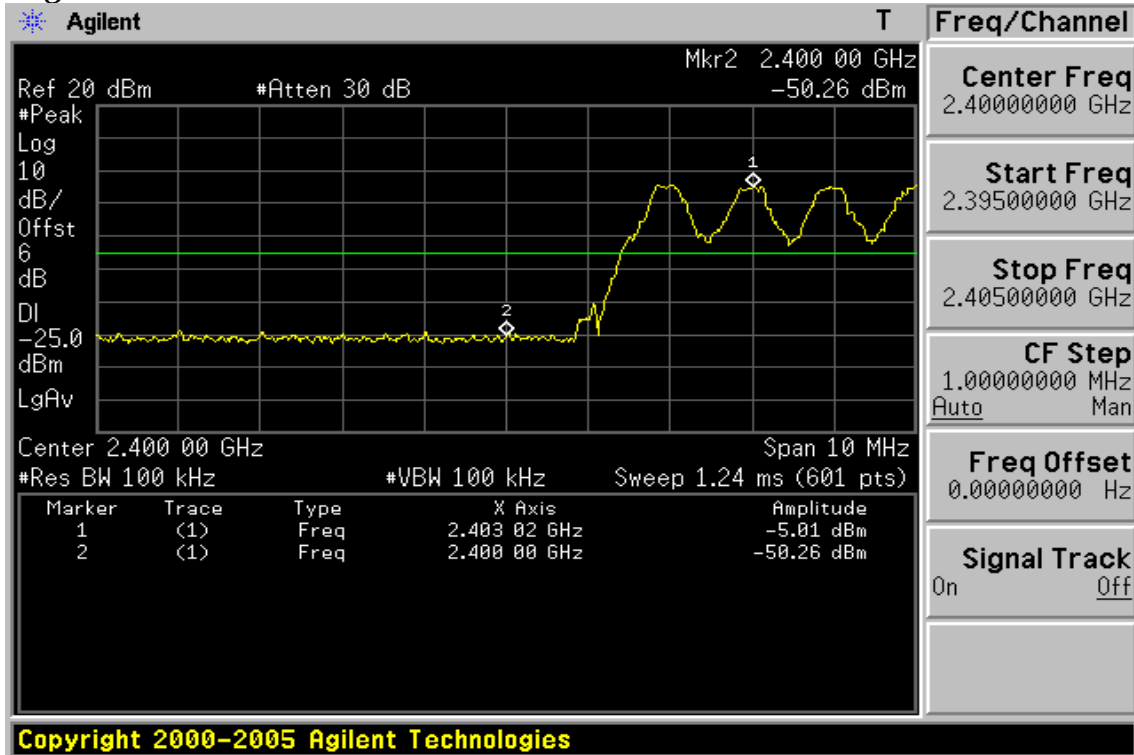

Unless otherwise stated the results shown in this test report refer only to the sample(s) tested and such sample(s) are retained for 90 days only.

除非另有說明，此報告結果僅對測試之樣品負責，同時此樣品僅保留90天。本報告未經本公司書面許可，不可部份複製。

This document is issued by the Company subject to its General Conditions of Service printed overleaf, available on request or accessible at [www.sgs.com/terms\\_and\\_conditions.htm](http://www.sgs.com/terms_and_conditions.htm) and, for electronic format documents, subject to Terms and Conditions for Electronic Documents at [www.sgs.com/terms\\_e-document.htm](http://www.sgs.com/terms_e-document.htm). Attention is drawn to the limitation of liability, indemnification and jurisdiction issues defined therein. Any holder of this document is advised that information contained hereon reflects the Company's findings at the time of its intervention only and within the limits of Client's instructions, if any. The Company's sole responsibility is to its Client and this document does not exonerate parties to a transaction from exercising all their rights and obligations under the transaction documents. This document cannot be reproduced except in full, without prior written approval of the Company. Any unauthorized alteration, forgery or falsification of the content or appearance of this document is unlawful and offenders may be prosecuted to the fullest extent of the law.

SGS Taiwan Ltd. No.134, Wu Kung Road, Wuku Industrial Zone, Taipei County, Taiwan / 台北縣五股工業區五工路 134 號

**Band Edges Test Data CH-High**

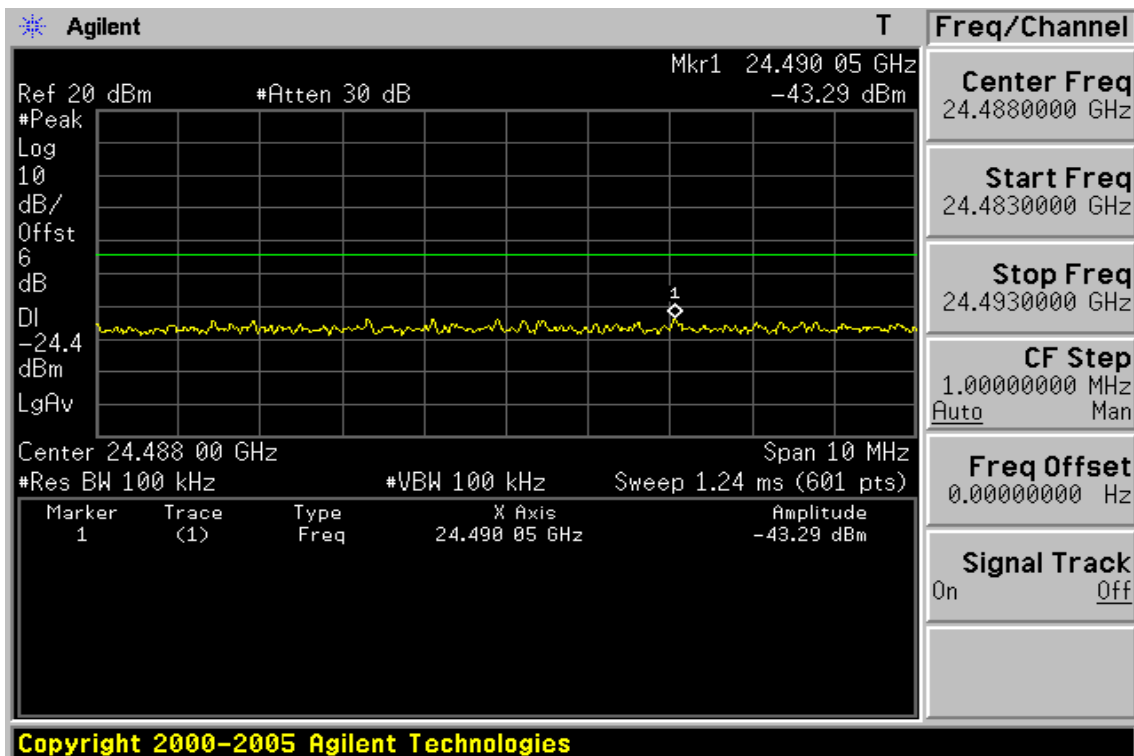
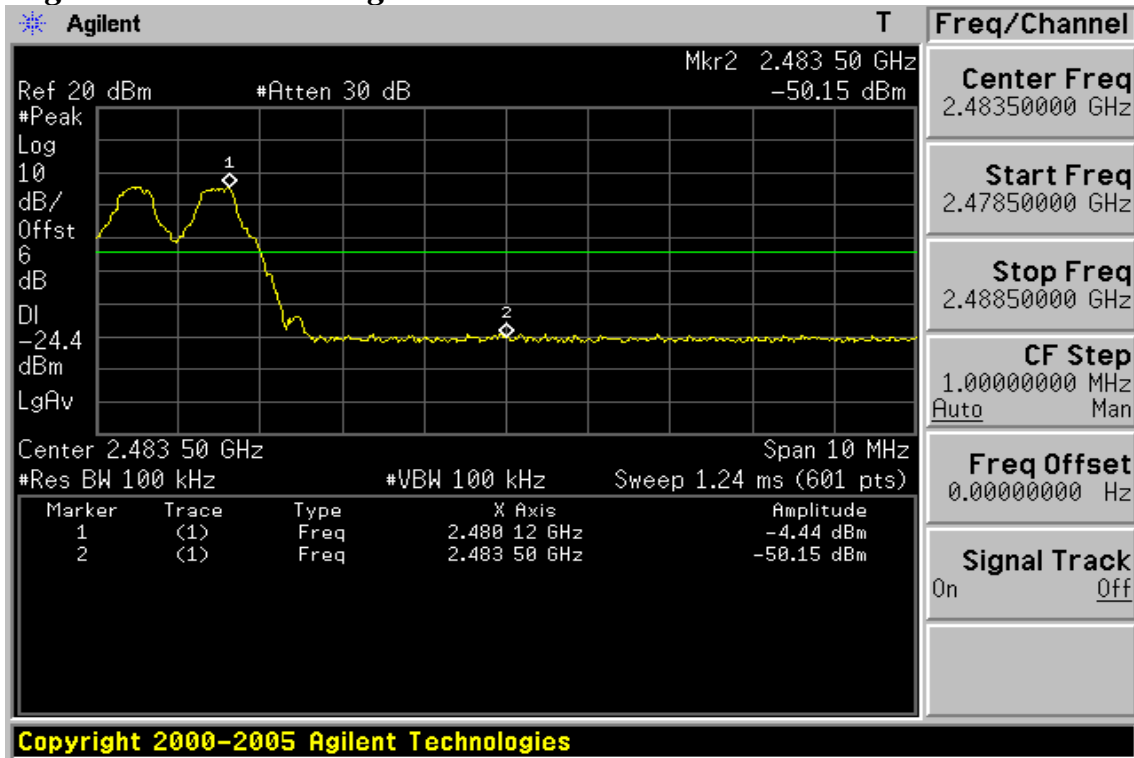

Unless otherwise stated the results shown in this test report refer only to the sample(s) tested and such sample(s) are retained for 90 days only.

除非另有說明，此報告結果僅對測試之樣品負責，同時此樣品僅保留90天。本報告未經本公司書面許可，不可部份複製。

This document is issued by the Company subject to its General Conditions of Service printed overleaf, available on request or accessible at [www.sgs.com/terms\\_and\\_conditions.htm](http://www.sgs.com/terms_and_conditions.htm) and for electronic format documents, subject to Terms and Conditions for Electronic Documents at [www.sgs.com/terms\\_e-document.htm](http://www.sgs.com/terms_e-document.htm). Attention is drawn to the limitation of liability, indemnification and jurisdiction issues defined therein. Any holder of this document is advised that information contained hereon reflects the Company's findings at the time of its intervention only and within the limits of Client's instructions, if any. The Company's sole responsibility is to its Client and this document does not exonerate parties to a transaction from exercising all their rights and obligations under the transaction documents. This document cannot be reproduced except in full, without prior written approval of the Company. Any unauthorized alteration, forgery or falsification of the content or appearance of this document is unlawful and offenders may be prosecuted to the fullest extent of the law.

SGS Taiwan Ltd. No.134, Wu Kung Road, Wuku Industrial Zone, Taipei County, Taiwan / 台北縣五股工業區五工路 134 號

**Radiated Emission: (BDR mode)**

Operation Mode TX CH Low  
 Fundamental Frequency 2402 MHz  
 Temperature 24 °C  
 Humidity 63 %

Test Date Feb. 22, 2012  
 Test By Lion  
 Pol Ver.

Freq. (MHz)	Peak	AV	Ant./CL CF (dB)	Actual FS		Peak	AV	Margin (dB)	Remark
	Reading (dBuV)	Reading (dBuV)		Peak (dBuV/m)	AV (dBuV/m)	Limit (dBuV/m)	Limit (dBuV/m)		
2390.00	46.10	---	-1.06	45.04	---	74.00	54.00	-8.96	Peak

Operation Mode TX CH Low  
 Fundamental Frequency 2402 MHz  
 Temperature 24 °C  
 Humidity 63 %

Test Date Feb. 22, 2012  
 Test By Lion  
 Pol Hor.

Freq. (MHz)	Peak	AV	Ant./CL CF (dB)	Actual FS		Peak	AV	Margin (dB)	Remark
	Reading (dBuV)	Reading (dBuV)		Peak (dBuV/m)	AV (dBuV/m)	Limit (dBuV/m)	Limit (dBuV/m)		
2390.00	45.30	---	-1.06	44.24	---	74.00	54.00	-9.76	Peak

Remark :

- (1) Data of measurement within this frequency range shown “ - ” in the table above means the reading of emissions are attenuated more than 20dB below the permissible limits or the field strength is too small to be measured.
- (2) Radiated emissions measured in frequency above 1000MHz were made with an instrument using Peak detector mode and average detector mode of the emission shown in Actual FS column.
- (3) Spectrum Peak Setting : 1GHz- 26GHz, RBW= 1MHz, VBW= 3MHz, Sweep time= 200 ms.
- (4) Spectrum AV Setting : 1GHz- 26GHz, RBW= 1MHz, VBW= 10Hz, Sweep time= 200 ms.

Unless otherwise stated the results shown in this test report refer only to the sample(s) tested and such sample(s) are retained for 90 days only.

除非另有說明，此報告結果僅對測試之樣品負責，同時此樣品僅保留90天。本報告未經本公司書面許可，不可部份複製。

This document is issued by the Company subject to its General Conditions of Service printed overleaf, available on request or accessible at [www.sgs.com/terms\\_and\\_conditions.htm](http://www.sgs.com/terms_and_conditions.htm) and for electronic format documents, subject to Terms and Conditions for Electronic Documents at [www.sgs.com/terms\\_e-document.htm](http://www.sgs.com/terms_e-document.htm). Attention is drawn to the limitation of liability, indemnification and jurisdiction issues defined therein. Any holder of this document is advised that information contained hereon reflects the Company's findings at the time of its intervention only and within the limits of Client's instructions, if any. The Company's sole responsibility is to its Client and this document does not exonerate parties to a transaction from exercising all their rights and obligations under the transaction documents. This document cannot be reproduced except in full, without prior written approval of the Company. Any unauthorized alteration, forgery or falsification of the content or appearance of this document is unlawful and offenders may be prosecuted to the fullest extent of the law.

Operation Mode TX CH High  
 Fundamental Frequency 2480 MHz  
 Temperature 25 °C  
 Humidity 65 %

Test Date Feb. 22, 2012  
 Test By Lion  
 Pol Ver.

Freq. (MHz)	Peak	AV	Ant./CL CF (dB)	Actual FS		Peak	AV	Margin (dB)	Remark
	Reading (dBuV)	Reading (dBuV)		Peak (dBuV/m)	AV (dBuV/m)	Limit (dBuV/m)	Limit (dBuV/m)		
2483.50	46.31	---	-0.59	45.72	---	74.00	54.00	-8.28	Peak

Operation Mode TX CH High  
 Fundamental Frequency 2480 MHz  
 Temperature 25 °C  
 Humidity 65 %

Test Date Feb. 22, 2012  
 Test By Lion  
 Pol Hor.

Freq. (MHz)	Peak	AV	Ant./CL CF (dB)	Actual FS		Peak	AV	Margin (dB)	Remark
	Reading (dBuV)	Reading (dBuV)		Peak (dBuV/m)	AV (dBuV/m)	Limit (dBuV/m)	Limit (dBuV/m)		
2483.50	45.59	---	-0.59	45.00	---	74.00	54.00	-9.00	Peak

Remark :

- (1) Data of measurement within this frequency range shown “ - ” in the table above means the reading of emissions are attenuated more than 20dB below the permissible limits or the field strength is too small to be measured.
- (2) Radiated emissions measured in frequency above 1000MHz were made with an instrument using Peak detector mode and average detector mode of the emission shown in Actual FS column.
- (3) Spectrum Peak Setting : 1GHz- 26GHz, RBW= 1MHz, VBW= 3MHz, Sweep time= 200 ms.
- (4) Spectrum AV Setting : 1GHz- 26GHz, RBW= 1MHz, VBW= 10Hz, Sweep time= 200 ms.

Unless otherwise stated the results shown in this test report refer only to the sample(s) tested and such sample(s) are retained for 90 days only.

除非另有說明，此報告結果僅對測試之樣品負責，同時此樣品僅保留90天。本報告未經本公司書面許可，不可部份複製。

This document is issued by the Company subject to its General Conditions of Service printed overleaf, available on request or accessible at [www.sgs.com/terms\\_and\\_conditions.htm](http://www.sgs.com/terms_and_conditions.htm) and for electronic format documents, subject to Terms and Conditions for Electronic Documents at [www.sgs.com/terms\\_e-document.htm](http://www.sgs.com/terms_e-document.htm). Attention is drawn to the limitation of liability, indemnification and jurisdiction issues defined therein. Any holder of this document is advised that information contained hereon reflects the Company's findings at the time of its intervention only and within the limits of Client's instructions, if any. The Company's sole responsibility is to its Client and this document does not exonerate parties to a transaction from exercising all their rights and obligations under the transaction documents. This document cannot be reproduced except in full, without prior written approval of the Company. Any unauthorized alteration, forgery or falsification of the content or appearance of this document is unlawful and offenders may be prosecuted to the fullest extent of the law.

SGS Taiwan Ltd. No.134, Wu Kung Road, Wuku Industrial Zone, Taipei County, Taiwan / 台北縣五股工業區五工路 134 號

台灣檢驗科技股份有限公司 t (886-2) 2299-3279

f (886-2) 2298-0488

[www.tw.sgs.com](http://www.tw.sgs.com)

Member of SGS Group

**EDR Mode**

**Band Edges Test Data CH-Low**

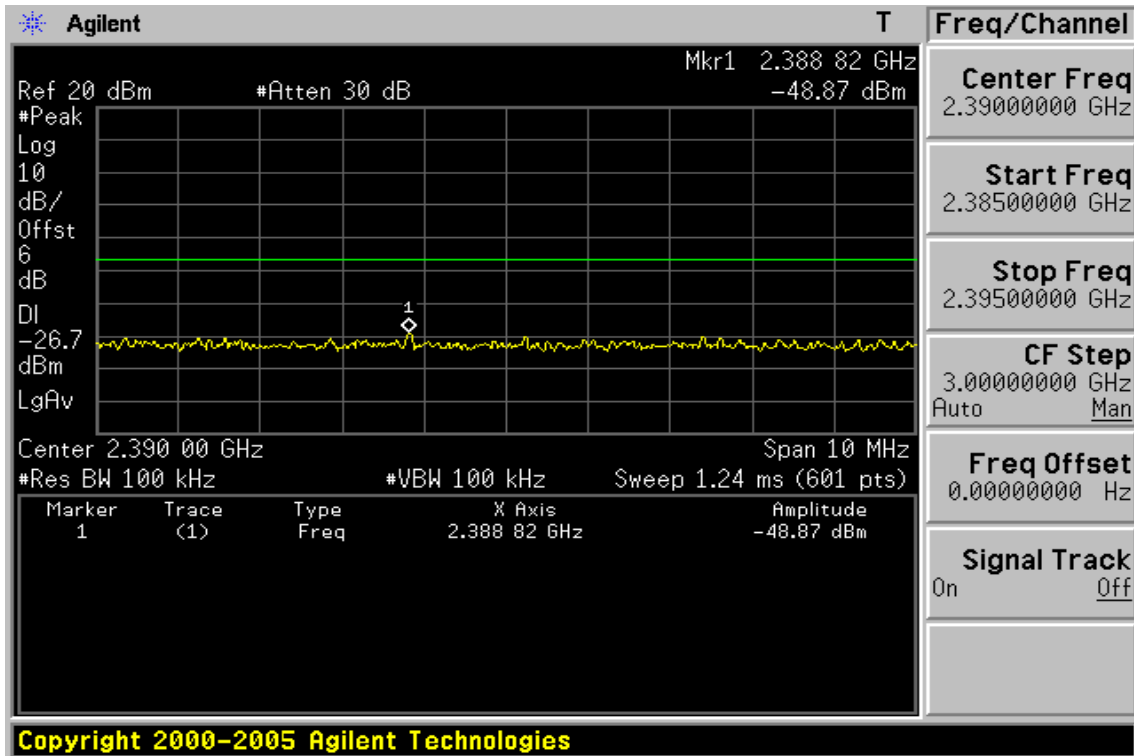
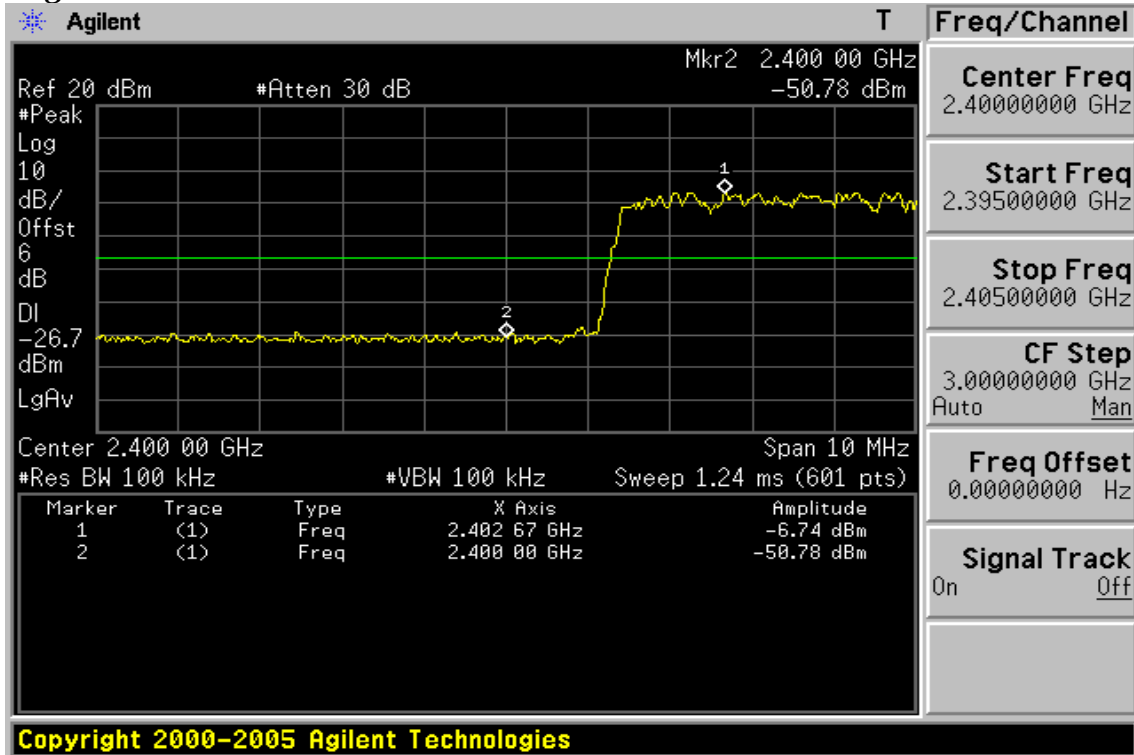

Unless otherwise stated the results shown in this test report refer only to the sample(s) tested and such sample(s) are retained for 90 days only.

除非另有說明，此報告結果僅對測試之樣品負責，同時此樣品僅保留90天。本報告未經本公司書面許可，不可部份複製。

This document is issued by the Company subject to its General Conditions of Service printed overleaf, available on request or accessible at [www.sgs.com/terms\\_and\\_conditions.htm](http://www.sgs.com/terms_and_conditions.htm) and, for electronic format documents, subject to Terms and Conditions for Electronic Documents at [www.sgs.com/terms\\_e-document.htm](http://www.sgs.com/terms_e-document.htm). Attention is drawn to the limitation of liability, indemnification and jurisdiction issues defined therein. Any holder of this document is advised that information contained hereon reflects the Company's findings at the time of its intervention only and within the limits of Client's instructions, if any. The Company's sole responsibility is to its Client and this document does not exonerate parties to a transaction from exercising all their rights and obligations under the transaction documents. This document cannot be reproduced except in full, without prior written approval of the Company. Any unauthorized alteration, forgery or falsification of the content or appearance of this document is unlawful and offenders may be prosecuted to the fullest extent of the law.

SGS Taiwan Ltd. No.134, Wu Kung Road, Wuku Industrial Zone, Taipei County, Taiwan / 台北縣五股工業區五工路 134 號

**Band Edges Test Data CH-High**

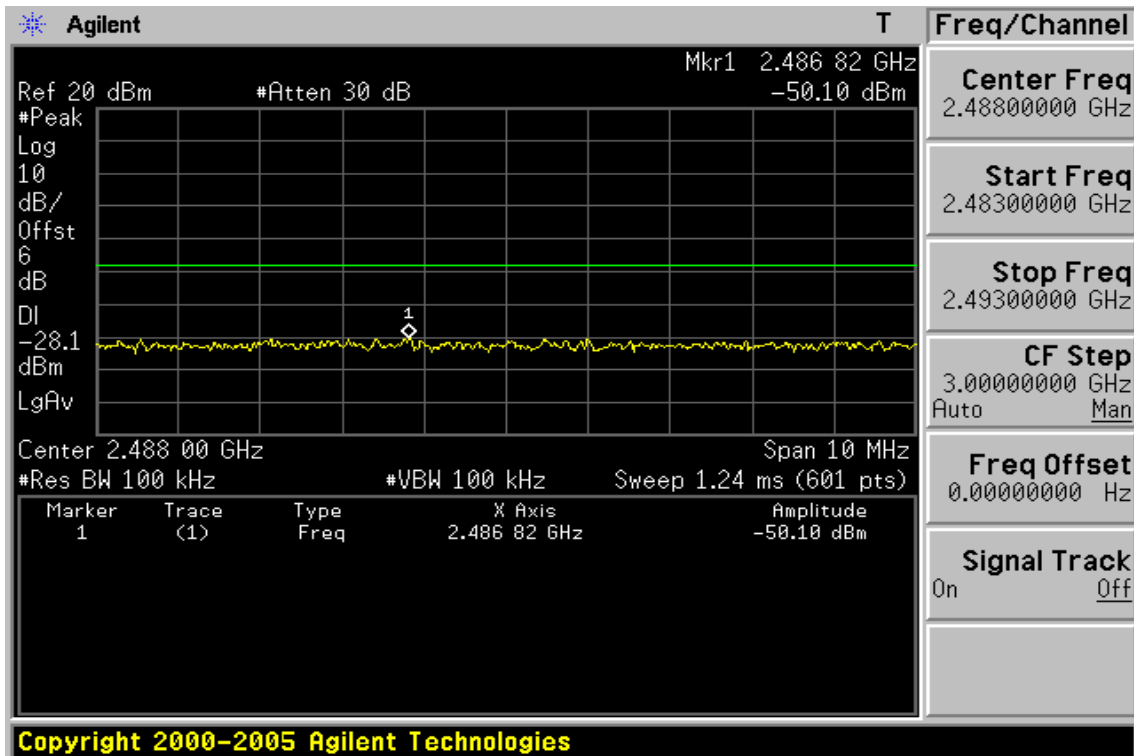
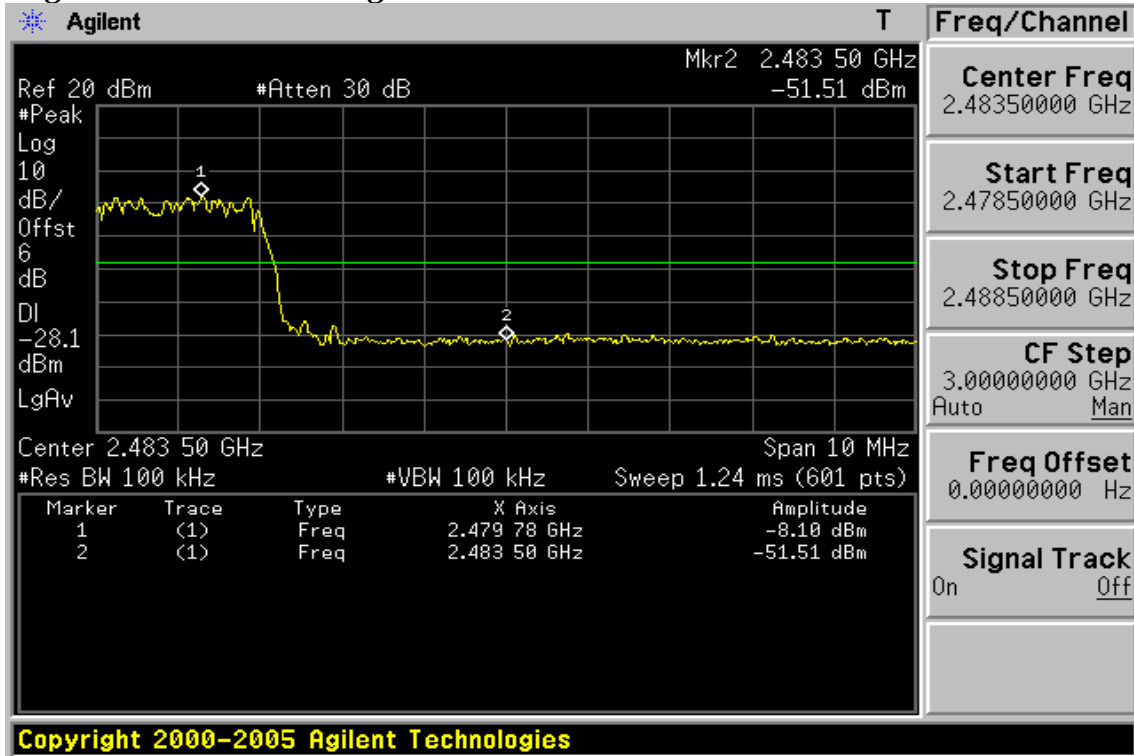

Unless otherwise stated the results shown in this test report refer only to the sample(s) tested and such sample(s) are retained for 90 days only.

除非另有說明，此報告結果僅對測試之樣品負責，同時此樣品僅保留90天。本報告未經本公司書面許可，不可部份複製。

This document is issued by the Company subject to its General Conditions of Service printed overleaf, available on request or accessible at [www.sgs.com/terms\\_and\\_conditions.htm](http://www.sgs.com/terms_and_conditions.htm) and for electronic format documents, subject to Terms and Conditions for Electronic Documents at [www.sgs.com/terms\\_e-document.htm](http://www.sgs.com/terms_e-document.htm). Attention is drawn to the limitation of liability, indemnification and jurisdiction issues defined therein. Any holder of this document is advised that information contained hereon reflects the Company's findings at the time of its intervention only and within the limits of Client's instructions, if any. The Company's sole responsibility is to its Client and this document does not exonerate parties to a transaction from exercising all their rights and obligations under the transaction documents. This document cannot be reproduced except in full, without prior written approval of the Company. Any unauthorized alteration, forgery or falsification of the content or appearance of this document is unlawful and offenders may be prosecuted to the fullest extent of the law.

SGS Taiwan Ltd. No.134, Wu Kung Road, Wuku Industrial Zone, Taipei County, Taiwan / 台北縣五股工業區五工路 134 號

**Radiated Emission: (EDR mode)**

Operation Mode TX CH Low  
 Fundamental Frequency 2402 MHz  
 Temperature 25 °C  
 Humidity 65 %

Test Date Feb. 22, 2012  
 Test By Lion  
 Pol Ver.

Freq. (MHz)	Peak Reading (dBuV)	AV Reading (dBuV)	Ant./CL CF (dB)	Actual FS		Peak Limit (dBuV/m)	AV Limit (dBuV/m)	Margin (dB)	Remark
				Peak (dBuV/m)	AV (dBuV/m)				
2390.00	46.32	---	-1.06	45.26	---	74.00	54.00	-8.74	Peak

Operation Mode TX CH Low  
 Fundamental Frequency 2402 MHz  
 Temperature 25 °C  
 Humidity 65 %

Test Date Feb. 22, 2012  
 Test By Lion  
 Pol Hor.

Freq. (MHz)	Peak Reading (dBuV)	AV Reading (dBuV)	Ant./CL CF (dB)	Actual FS		Peak Limit (dBuV/m)	AV Limit (dBuV/m)	Margin (dB)	Remark
				Peak (dBuV/m)	AV (dBuV/m)				
2390.00	44.61	---	-1.06	43.55	---	74.00	54.00	-10.45	Peak

Remark :

- (1) Data of measurement within this frequency range shown “ - ” in the table above means the reading of emissions are attenuated more than 20dB below the permissible limits or the field strength is too small to be measured.
- (2) Radiated emissions measured in frequency above 1000MHz were made with an instrument using Peak detector mode and average detector mode of the emission shown in Actual FS column.
- (3) Spectrum Peak Setting : 1GHz- 26GHz, RBW= 1MHz, VBW= 3MHz, Sweep time= 200 ms.
- (4) Spectrum AV Setting : 1GHz- 26GHz, RBW= 1MHz, VBW= 10Hz, Sweep time= 200 ms.

Unless otherwise stated the results shown in this test report refer only to the sample(s) tested and such sample(s) are retained for 90 days only.

除非另有說明，此報告結果僅對測試之樣品負責，同時此樣品僅保留90天。本報告未經本公司書面許可，不可部份複製。

This document is issued by the Company subject to its General Conditions of Service printed overleaf, available on request or accessible at [www.sgs.com/terms\\_and\\_conditions.htm](http://www.sgs.com/terms_and_conditions.htm) and for electronic format documents, subject to Terms and Conditions for Electronic Documents at [www.sgs.com/terms\\_e-document.htm](http://www.sgs.com/terms_e-document.htm). Attention is drawn to the limitation of liability, indemnification and jurisdiction issues defined therein. Any holder of this document is advised that information contained hereon reflects the Company's findings at the time of its intervention only and within the limits of Client's instructions, if any. The Company's sole responsibility is to its Client and this document does not exonerate parties to a transaction from exercising all their rights and obligations under the transaction documents. This document cannot be reproduced except in full, without prior written approval of the Company. Any unauthorized alteration, forgery or falsification of the content or appearance of this document is unlawful and offenders may be prosecuted to the fullest extent of the law.



Operation Mode TX CH High  
 Fundamental Frequency 2480 MHz  
 Temperature 25 °C  
 Humidity 65 %

Test Date Feb. 22, 2012  
 Test By Lion  
 Pol Ver.

Freq. (MHz)	Peak	AV	Ant./CL CF (dB)	Actual FS		Peak	AV	Margin (dB)	Remark
	Reading (dBuV)	Reading (dBuV)		Peak (dBuV/m)	AV (dBuV/m)	Limit (dBuV/m)	Limit (dBuV/m)		
2483.50	45.75	---	-0.59	45.16	---	74.00	54.00	-8.84	Peak

Operation Mode TX CH High  
 Fundamental Frequency 2480 MHz  
 Temperature 25 °C  
 Humidity 65 %

Test Date Feb. 22, 2012  
 Test By Lion  
 Pol Hor.

Freq. (MHz)	Peak	AV	Ant./CL CF (dB)	Actual FS		Peak	AV	Margin (dB)	Remark
	Reading (dBuV)	Reading (dBuV)		Peak (dBuV/m)	AV (dBuV/m)	Limit (dBuV/m)	Limit (dBuV/m)		
2483.50	45.91	---	-0.59	45.32	---	74.00	54.00	-8.68	Peak

Remark :

- (1) Data of measurement within this frequency range shown “ - ” in the table above means the reading of emissions are attenuated more than 20dB below the permissible limits or the field strength is too small to be measured.
- (2) Radiated emissions measured in frequency above 1000MHz were made with an instrument using Peak detector mode and average detector mode of the emission shown in Actual FS column.
- (3) Spectrum Peak Setting : 1GHz- 26GHz, RBW= 1MHz, VBW= 3MHz, Sweep time= 200 ms.
- (4) Spectrum AV Setting : 1GHz- 26GHz, RBW= 1MHz, VBW= 10Hz, Sweep time= 200 ms.

Unless otherwise stated the results shown in this test report refer only to the sample(s) tested and such sample(s) are retained for 90 days only.

除非另有說明，此報告結果僅對測試之樣品負責，同時此樣品僅保留90天。本報告未經本公司書面許可，不可部份複製。

This document is issued by the Company subject to its General Conditions of Service printed overleaf, available on request or accessible at [www.sgs.com/terms\\_and\\_conditions.htm](http://www.sgs.com/terms_and_conditions.htm) and for electronic format documents, subject to Terms and Conditions for Electronic Documents at [www.sgs.com/terms\\_e-document.htm](http://www.sgs.com/terms_e-document.htm). Attention is drawn to the limitation of liability, indemnification and jurisdiction issues defined therein. Any holder of this document is advised that information contained hereon reflects the Company's findings at the time of its intervention only and within the limits of Client's instructions, if any. The Company's sole responsibility is to its Client and this document does not exonerate parties to a transaction from exercising all their rights and obligations under the transaction documents. This document cannot be reproduced except in full, without prior written approval of the Company. Any unauthorized alteration, forgery or falsification of the content or appearance of this document is unlawful and offenders may be prosecuted to the fullest extent of the law.

SGS Taiwan Ltd. No.134, Wu Kung Road, Wuku Industrial Zone, Taipei County, Taiwan / 台北縣五股工業區五工路 134 號

台灣檢驗科技股份有限公司 t (886-2) 2299-3279

f (886-2) 2298-0488

[www.tw.sgs.com](http://www.tw.sgs.com)

Member of SGS Group

## 9. SPURIOUS RADIATED EMISSION TEST

### 9.1. Standard Applicable

According to §15.247(c), all other emissions outside these bands shall not exceed the general radiated emission limits specified in §15.209(a). And according to §15.33(a)(1), for an intentional radiator operates below 10GHz, the frequency range of measurements: to the tenth harmonic of the highest fundamental frequency or to 40GHz, whichever is lower.

### 9.2. Measurement Equipment Used:

#### 9.2.1. Conducted Emission at antenna port:

Refer to section 6.2 for details.

#### 9.2.2. Radiated emission:

Refer to section 7.2 for details.

### 9.3. Test SET-UP:

#### 9.3.1. Conducted Emission at antenna port:

Refer to section 6.3 for details.

#### 9.3.2. Radiated emission:

Refer to section 7.3 for details.

### 9.4. Measurement Procedure:

1. The EUT was placed on a turn table which is 0.8m above ground plane.
2. The turn table shall rotate 360 degrees to determine the position of maximum emission level.
3. EUT is set 3m away from the receiving antenna which varied from 1m to 4m to find out the highest emissions.
4. When measurement procedures for electric field radiated emissions above 1 GHz the EUT measurement is to be made “while keeping the antenna in the ‘cone of radiation’ from that area and pointed at the area both in azimuth and elevation, with polarization oriented for maximum response.” is still within the 3dB illumination BW of the measurement antenna.
5. Maximum procedure was performed on the six highest emissions to ensure EUT compliance.
6. And also, each emission was to be maximized by changing the polarization of receiving antenna both horizontal and vertical.
7. Repeat above procedures until all frequency measured were complete.

Unless otherwise stated the results shown in this test report refer only to the sample(s) tested and such sample(s) are retained for 90 days only.

除非另有說明，此報告結果僅對測試之樣品負責，同時此樣品僅保留90天。本報告未經本公司書面許可，不可部份複製。

This document is issued by the Company subject to its General Conditions of Service printed overleaf, available on request or accessible at [www.sgs.com/terms\\_and\\_conditions.htm](http://www.sgs.com/terms_and_conditions.htm) and for electronic format documents, subject to Terms and Conditions for Electronic Documents at [www.sgs.com/terms\\_e-document.htm](http://www.sgs.com/terms_e-document.htm). Attention is drawn to the limitation of liability, indemnification and jurisdiction issues defined therein. Any holder of this document is advised that information contained hereon reflects the Company's findings at the time of its intervention only and within the limits of Client's instructions, if any. The Company's sole responsibility is to its Client and this document does not exonerate parties to a transaction from exercising all their rights and obligations under the transaction documents. This document cannot be reproduced except in full, without prior written approval of the Company. Any unauthorized alteration, forgery or falsification of the content or appearance of this document is unlawful and offenders may be prosecuted to the fullest extent of the law.

SGS Taiwan Ltd. No.134, Wu Kung Road, Wuku Industrial Zone, Taipei County, Taiwan / 台北縣五股工業區五工路 134 號

台灣檢驗科技股份有限公司 t (886-2) 2299-3279

f (886-2) 2298-0488

[www.tw.sgs.com](http://www.tw.sgs.com)

Member of SGS Group

### 9.5. Field Strength Calculation

The field strength is calculated by adding the Antenna Factor and Cable Factor and subtracting the Amplifier Gain and Duty Cycle Correction Factor(if any) from the measured reading. The basic equation with a sample calculation is as follows:

$$FS = RA + AF + CL - AG$$

Where	FS = Field Strength	CL = Cable Attenuation Factor (Cable Loss)
	RA = Reading Amplitude	AG = Amplifier Gain
	AF = Antenna Factor	

### 9.6. Measurement Result:

Note: Refer to next page spectrum analyzer data chart and tabular data sheets.

Unless otherwise stated the results shown in this test report refer only to the sample(s) tested and such sample(s) are retained for 90 days only.

除非另有說明，此報告結果僅對測試之樣品負責，同時此樣品僅保留90天。本報告未經本公司書面許可，不可部份複製。

This document is issued by the Company subject to its General Conditions of Service printed overleaf, available on request or accessible at [www.sgs.com/terms\\_and\\_conditions.htm](http://www.sgs.com/terms_and_conditions.htm) and, for electronic format documents, subject to Terms and Conditions for Electronic Documents at [www.sgs.com/terms\\_e-document.htm](http://www.sgs.com/terms_e-document.htm). Attention is drawn to the limitation of liability, indemnification and jurisdiction issues defined therein. Any holder of this document is advised that information contained hereon reflects the Company's findings at the time of its intervention only and within the limits of Client's instructions, if any. The Company's sole responsibility is to its Client and this document does not exonerate parties to a transaction from exercising all their rights and obligations under the transaction documents. This document cannot be reproduced except in full, without prior written approval of the Company. Any unauthorized alteration, forgery or falsification of the content or appearance of this document is unlawful and offenders may be prosecuted to the fullest extent of the law.

SGS Taiwan Ltd. No.134, Wu Kung Road, Wuku Industrial Zone, Taipei County, Taiwan / 台北縣五股工業區五工路 134 號

台灣檢驗科技股份有限公司 t (886-2) 2299-3279

f (886-2) 2298-0488

[www.tw.sgs.com](http://www.tw.sgs.com)

Member of SGS Group

**EDR Mode Conducted Spurious Emission Measurement Result**  
**Ch Low 30MHz – 3GHz**

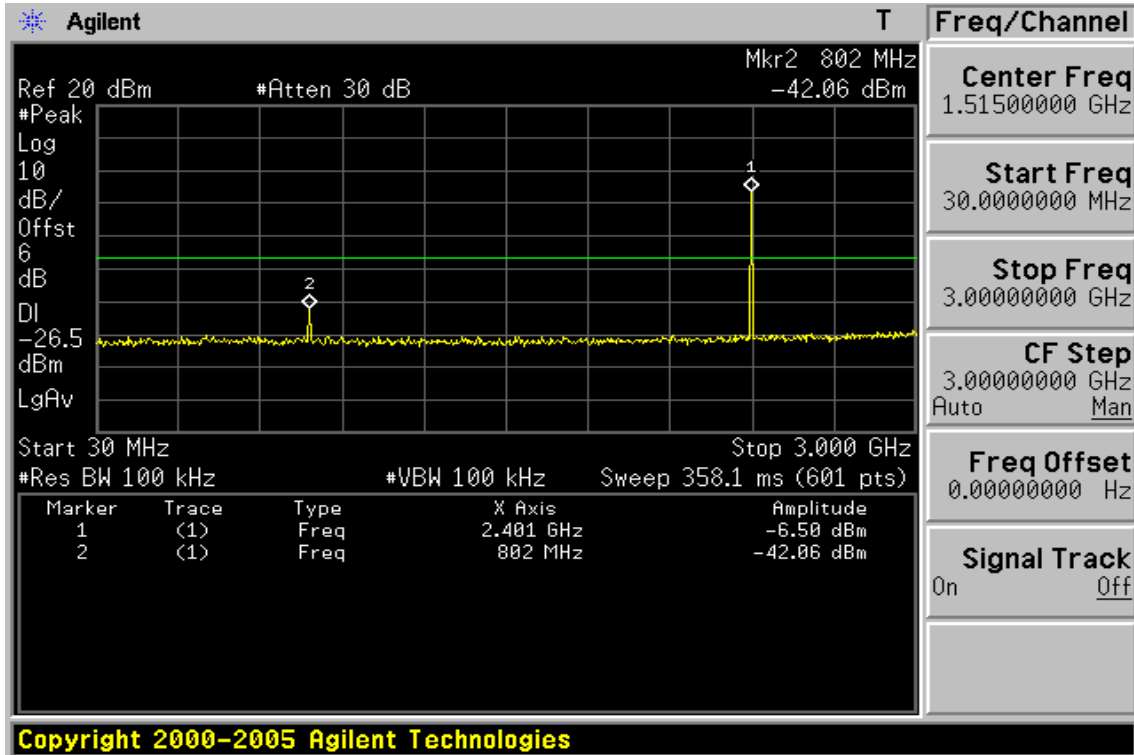

**Ch Low 3GHz – 26.5GHz**

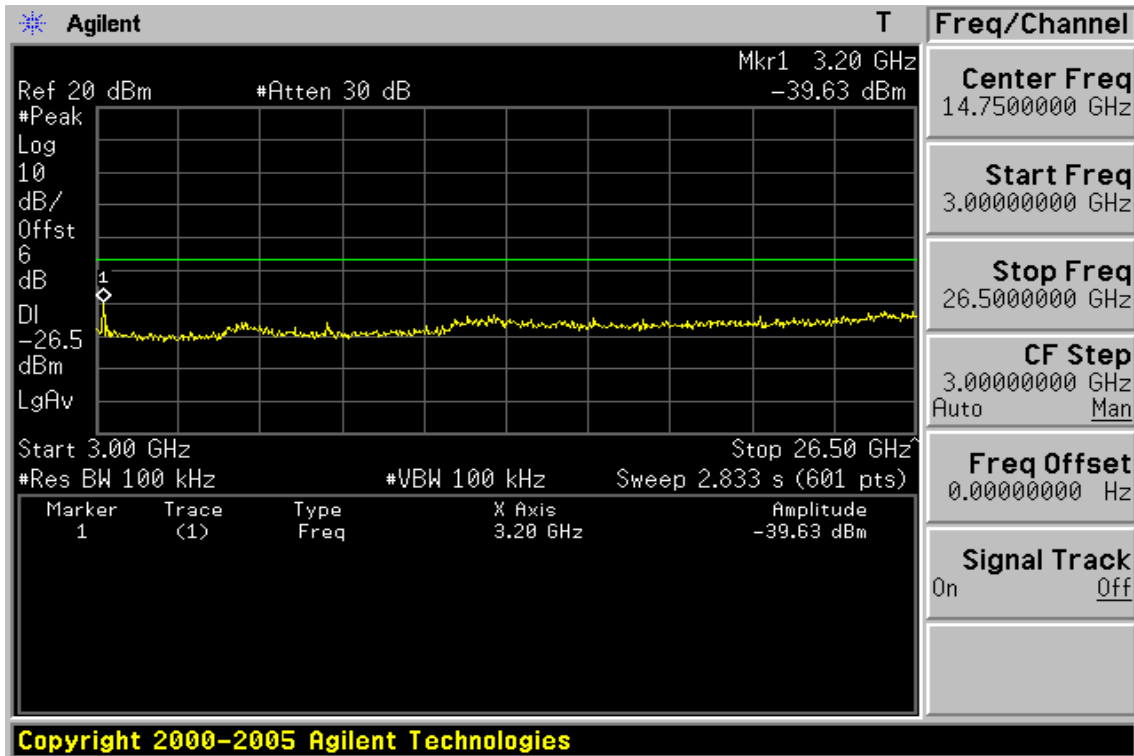

Unless otherwise stated the results shown in this test report refer only to the sample(s) tested and such sample(s) are retained for 90 days only.

除非另有說明，此報告結果僅對測試之樣品負責，同時此樣品僅保留90天。本報告未經本公司書面許可，不可部份複製。

This document is issued by the Company subject to its General Conditions of Service printed overleaf, available on request or accessible at [www.sgs.com/terms\\_and\\_conditions.htm](http://www.sgs.com/terms_and_conditions.htm) and, for electronic format documents, subject to Terms and Conditions for Electronic Documents at [www.sgs.com/terms\\_e-document.htm](http://www.sgs.com/terms_e-document.htm). Attention is drawn to the limitation of liability, indemnification and jurisdiction issues defined therein. Any holder of this document is advised that information contained hereon reflects the Company's findings at the time of its intervention only and within the limits of Client's instructions, if any. The Company's sole responsibility is to its Client and this document does not exonerate parties to a transaction from exercising all their rights and obligations under the transaction documents. This document cannot be reproduced except in full, without prior written approval of the Company. Any unauthorized alteration, forgery or falsification of the content or appearance of this document is unlawful and offenders may be prosecuted to the fullest extent of the law.

SGS Taiwan Ltd. No.134, Wu Kung Road, Wuku Industrial Zone, Taipei County, Taiwan / 台北縣五股工業區五工路 134 號

Ch Mid 30MHz – 3GHz

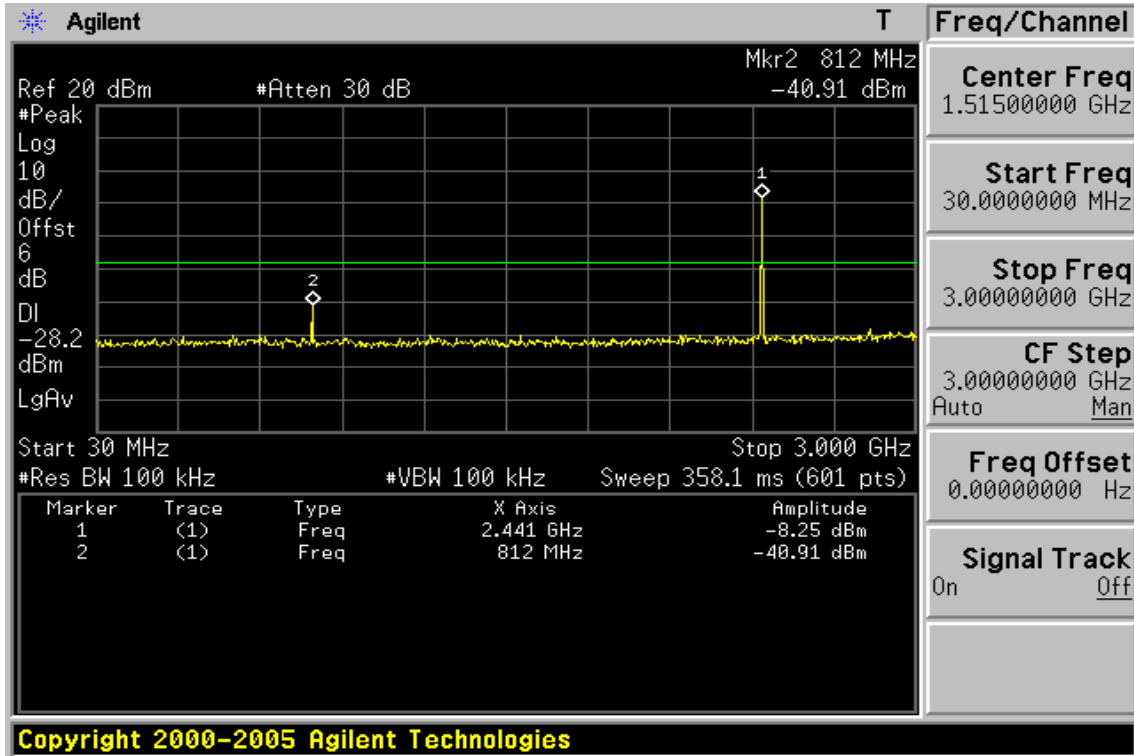

Ch Mid 3GHz – 26.5GHz

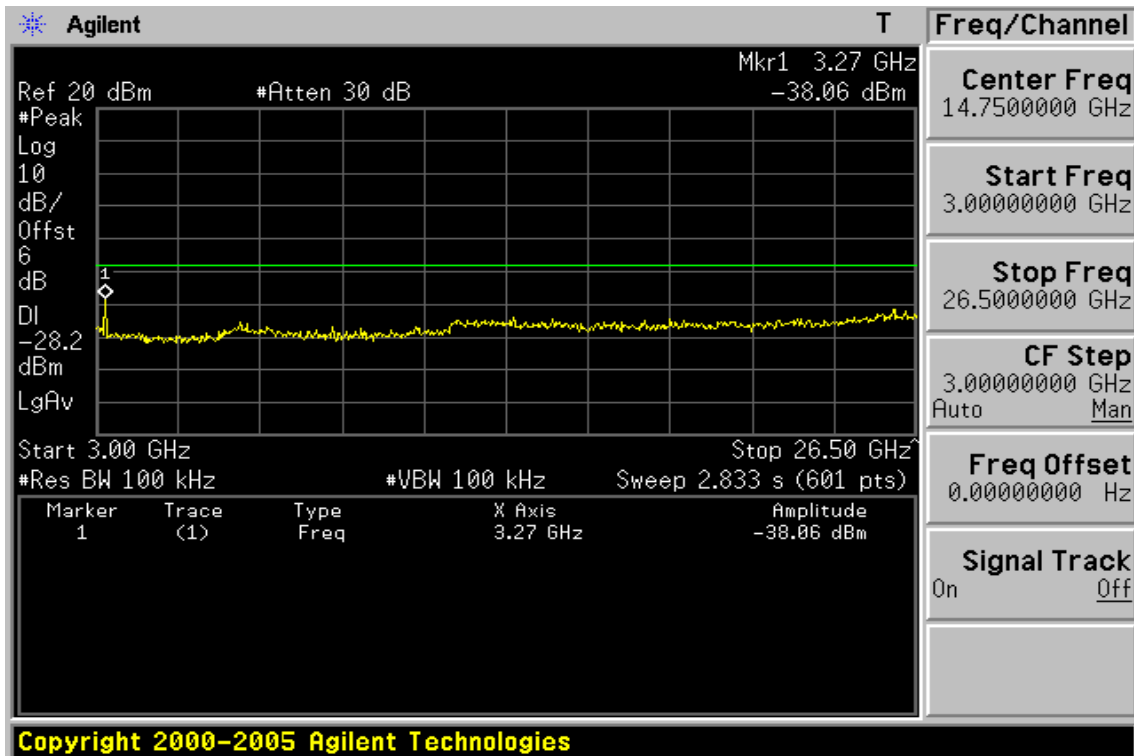

Unless otherwise stated the results shown in this test report refer only to the sample(s) tested and such sample(s) are retained for 90 days only.

除非另有說明，此報告結果僅對測試之樣品負責，同時此樣品僅保留90天。本報告未經本公司書面許可，不可部份複製。

This document is issued by the Company subject to its General Conditions of Service printed overleaf, available on request or accessible at [www.sgs.com/terms\\_and\\_conditions.htm](http://www.sgs.com/terms_and_conditions.htm) and for electronic format documents, subject to Terms and Conditions for Electronic Documents at [www.sgs.com/terms\\_e-document.htm](http://www.sgs.com/terms_e-document.htm). Attention is drawn to the limitation of liability, indemnification and jurisdiction issues defined therein. Any holder of this document is advised that information contained hereon reflects the Company's findings at the time of its intervention only and within the limits of Client's instructions, if any. The Company's sole responsibility is to its Client and this document does not exonerate parties to a transaction from exercising all their rights and obligations under the transaction documents. This document cannot be reproduced except in full, without prior written approval of the Company. Any unauthorized alteration, forgery or falsification of the content or appearance of this document is unlawful and offenders may be prosecuted to the fullest extent of the law.

SGS Taiwan Ltd. No.134, Wu Kung Road, Wuku Industrial Zone, Taipei County, Taiwan / 台北縣五股工業區五工路 134 號

Ch High 30MHz – 3GHz

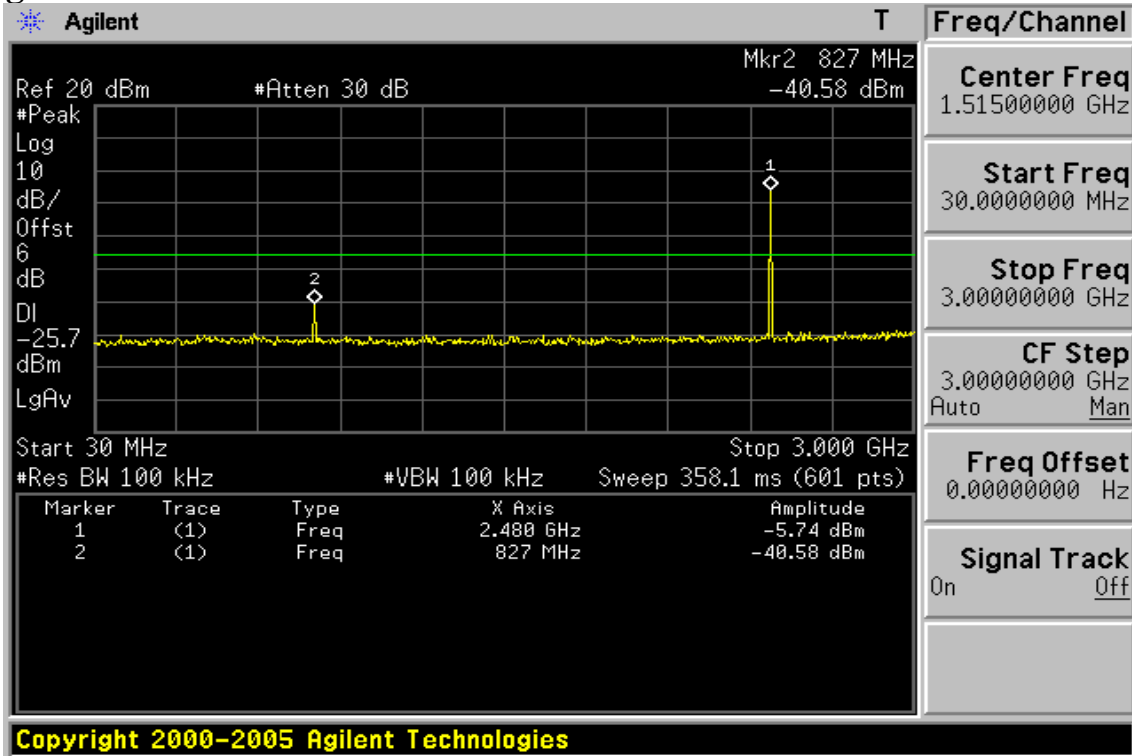

Ch High 3GHz – 26.5GHz

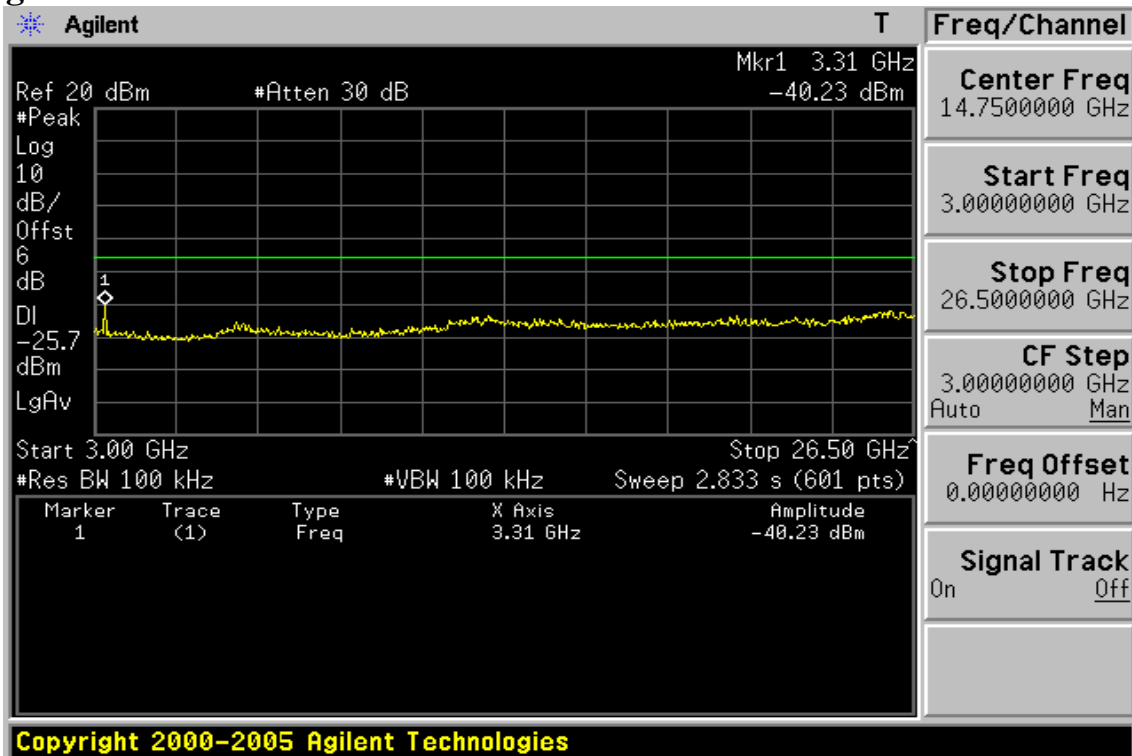

Unless otherwise stated the results shown in this test report refer only to the sample(s) tested and such sample(s) are retained for 90 days only.

除非另有說明，此報告結果僅對測試之樣品負責，同時此樣品僅保留90天。本報告未經本公司書面許可，不可部份複製。

This document is issued by the Company subject to its General Conditions of Service printed overleaf, available on request or accessible at [www.sgs.com/terms\\_and\\_conditions.htm](http://www.sgs.com/terms_and_conditions.htm) and for electronic format documents, subject to Terms and Conditions for Electronic Documents at [www.sgs.com/terms\\_e-document.htm](http://www.sgs.com/terms_e-document.htm). Attention is drawn to the limitation of liability, indemnification and jurisdiction issues defined therein. Any holder of this document is advised that information contained hereon reflects the Company's findings at the time of its intervention only and within the limits of Client's instructions, if any. The Company's sole responsibility is to its Client and this document does not exonerate parties to a transaction from exercising all their rights and obligations under the transaction documents. This document cannot be reproduced except in full, without prior written approval of the Company. Any unauthorized alteration, forgery or falsification of the content or appearance of this document is unlawful and offenders may be prosecuted to the fullest extent of the law.

SGS Taiwan Ltd. No.134, Wu Kung Road, Wuku Industrial Zone, Taipei County, Taiwan / 台北縣五股工業區五工路 134 號

台灣檢驗科技股份有限公司 t (886-2) 2299-3279

f (886-2) 2298-0488

[www.tw.sgs.com](http://www.tw.sgs.com)

Member of SGS Group

**Radiated Spurious Emission Measurement Result (below 1GHz) (Worst EDR mode)**

Operation Mode	TX CH Low	Test Date	Feb. 22, 2012
Fundamental Frequency	2402MHz	Test By	Lion
Temperature	25 °C	Pol	Ver./Hor.
Humidity	65 %		

Freq. (MHz)	Ant.Pol. H/V	Detector Mode (PK/QP)	Reading (dBuV)	Factor (dB)	Actual FS (dBuV/m)	Limit3m (dBuV/m)	Safe Margin (dB)
30.97	V	Peak	45.66	-14.19	31.47	40.00	-8.53
162.89	V	Peak	42.95	-12.16	30.79	43.50	-12.71
298.69	V	Peak	39.99	-12.45	27.54	46.00	-18.46
453.89	V	Peak	37.03	-9.74	27.29	46.00	-18.71
527.61	V	Peak	35.91	-8.58	27.33	46.00	-18.67
630.43	V	Peak	35.76	-6.40	29.36	46.00	-16.64
36.79	H	Peak	32.05	-14.07	17.98	40.00	-22.02
168.71	H	Peak	41.47	-12.72	28.75	43.50	-14.75
298.69	H	Peak	50.53	-12.45	38.08	46.00	-7.92
366.59	H	Peak	48.40	-11.34	37.06	46.00	-8.94
431.58	H	Peak	38.85	-10.20	28.65	46.00	-17.35
799.21	H	Peak	30.50	-3.66	26.84	46.00	-19.16

Remark :

- 1 Measuring frequencies from 30 MHz to the 1GHz ◦
- 2 Radiated emissions measured in frequency range from 30 MHz to 1000MHz were made with an instrument using Peak/QP detector mode.
- 3 Data of measurement within this frequency range shown “ - ” in the table above means the reading of emissions are attenuated more than 20dB below the permissible limits or the field strength is too small to be measured.
- 4 The IF bandwidth of SPA between 30MHz to 1GHz was 100KHz.

Unless otherwise stated the results shown in this test report refer only to the sample(s) tested and such sample(s) are retained for 90 days only.

除非另有說明，此報告結果僅對測試之樣品負責，同時此樣品僅保留90天。本報告未經本公司書面許可，不可部份複製。

This document is issued by the Company subject to its General Conditions of Service printed overleaf, available on request or accessible at [www.sgs.com/terms\\_and\\_conditions.htm](http://www.sgs.com/terms_and_conditions.htm) and, for electronic format documents, subject to Terms and Conditions for Electronic Documents at [www.sgs.com/terms\\_e-document.htm](http://www.sgs.com/terms_e-document.htm). Attention is drawn to the limitation of liability, indemnification and jurisdiction issues defined therein. Any holder of this document is advised that information contained hereon reflects the Company's findings at the time of its intervention only and within the limits of Client's instructions, if any. The Company's sole responsibility is to its Client and this document does not exonerate parties to a transaction from exercising all their rights and obligations under the transaction documents. This document cannot be reproduced except in full, without prior written approval of the Company. Any unauthorized alteration, forgery or falsification of the content or appearance of this document is unlawful and offenders may be prosecuted to the fullest extent of the law.

SGS Taiwan Ltd. No.134, Wu Kung Road, Wuku Industrial Zone, Taipei County, Taiwan / 台北縣五股工業區五工路 134 號

台灣檢驗科技股份有限公司 t (886-2) 2299-3279

f (886-2) 2298-0488

[www.tw.sgs.com](http://www.tw.sgs.com)

Member of SGS Group

Operation Mode	TX CH Mid	Test Date	Feb. 22, 2012
Fundamental Frequency	2441MHz	Test By	Lion
Temperature	25 °C	Pol	Ver./Hor.
Humidity	65 %		

Freq. (MHz)	Ant.Pol. H/V	Detector Mode (PK/QP)	Reading (dBuV)	Factor (dB)	Actual FS (dBuV/m)	Limit3m (dBuV/m)	Safe Margin (dB)
31.94	V	Peak	44.92	-14.19	30.73	40.00	-9.27
160.95	V	Peak	42.33	-11.98	30.35	43.50	-13.15
299.66	V	Peak	40.97	-12.45	28.52	46.00	-17.48
497.54	V	Peak	37.96	-9.19	28.77	46.00	-17.23
632.37	V	Peak	35.43	-6.37	29.06	46.00	-16.94
698.33	V	Peak	34.25	-5.31	28.94	46.00	-17.06
35.82	H	Peak	32.29	-14.08	18.21	40.00	-21.79
162.89	H	Peak	40.59	-12.16	28.43	43.50	-15.07
298.69	H	Peak	50.34	-12.45	37.89	46.00	-8.11
364.65	H	Peak	47.32	-11.38	35.94	46.00	-10.06
431.58	H	Peak	39.06	-10.20	28.86	46.00	-17.14
697.36	H	Peak	32.78	-5.33	27.45	46.00	-18.55

Remark :

- 1 Measuring frequencies from 30 MHz to the 1GHz .
- 2 Radiated emissions measured in frequency range from 30 MHz to 1000MHz were made with an instrument using Peak/QP detector mode.
- 3 Data of measurement within this frequency range shown “ - ” in the table above means the reading of emissions are attenuated more than 20dB below the permissible limits or the field strength is too small to be measured.
- 4 The IF bandwidth of SPA between 30MHz to 1GHz was 100KHz.

Unless otherwise stated the results shown in this test report refer only to the sample(s) tested and such sample(s) are retained for 90 days only.

除非另有說明，此報告結果僅對測試之樣品負責，同時此樣品僅保留90天。本報告未經本公司書面許可，不可部份複製。

This document is issued by the Company subject to its General Conditions of Service printed overleaf, available on request or accessible at [www.sgs.com/terms\\_and\\_conditions.htm](http://www.sgs.com/terms_and_conditions.htm) and for electronic format documents, subject to Terms and Conditions for Electronic Documents at [www.sgs.com/terms\\_e-document.htm](http://www.sgs.com/terms_e-document.htm). Attention is drawn to the limitation of liability, indemnification and jurisdiction issues defined therein. Any holder of this document is advised that information contained hereon reflects the Company's findings at the time of its intervention only and within the limits of Client's instructions, if any. The Company's sole responsibility is to its Client and this document does not exonerate parties to a transaction from exercising all their rights and obligations under the transaction documents. This document cannot be reproduced except in full, without prior written approval of the Company. Any unauthorized alteration, forgery or falsification of the content or appearance of this document is unlawful and offenders may be prosecuted to the fullest extent of the law.

SGS Taiwan Ltd. No.134, Wu Kung Road, Wuku Industrial Zone, Taipei County, Taiwan / 台北縣五股工業區五工路 134 號

台灣檢驗科技股份有限公司 t (886-2) 2299-3279

f (886-2) 2298-0488

[www.tw.sgs.com](http://www.tw.sgs.com)

Member of SGS Group



Operation Mode TX CH High  
 Fundamental Frequency 2480MHz  
 Temperature 25 °C  
 Humidity 65 %

Test Date Feb. 22, 2012  
 Test By Lion  
 Pol Ver./Hor.

Freq. (MHz)	Ant.Pol. H/V	Detector Mode (PK/QP)	Reading (dBuV)	Factor (dB)	Actual FS (dBuV/m)	Limit3m (dBuV/m)	Safe Margin (dB)
31.94	V	Peak	45.52	-14.19	31.33	40.00	-8.67
159.98	V	Peak	42.53	-11.98	30.55	43.50	-12.95
298.69	V	Peak	39.50	-12.45	27.05	46.00	-18.95
453.89	V	Peak	35.33	-9.74	25.59	46.00	-20.41
527.61	V	Peak	35.56	-8.58	26.98	46.00	-19.02
623.64	V	Peak	34.42	-6.51	27.91	46.00	-18.09
35.82	H	Peak	32.31	-14.08	18.23	40.00	-21.77
166.77	H	Peak	41.14	-12.54	28.60	43.50	-14.90
299.66	H	Peak	50.75	-12.45	38.30	46.00	-7.70
364.65	H	Peak	47.44	-11.38	36.06	46.00	-9.94
431.58	H	Peak	39.46	-10.20	29.26	46.00	-16.74
797.27	H	Peak	30.95	-3.68	27.27	46.00	-18.73

Remark :

- 1 Measuring frequencies from 30 MHz to the 1GHz .
- 2 Radiated emissions measured in frequency range from 30 MHz to 1000MHz were made with an instrument using Peak/QP detector mode.
- 3 Data of measurement within this frequency range shown “ - ” in the table above means the reading of emissions are attenuated more than 20dB below the permissible limits or the field strength is too small to be measured.
- 4 The IF bandwidth of SPA between 30MHz to 1GHz was 100KHz.

Unless otherwise stated the results shown in this test report refer only to the sample(s) tested and such sample(s) are retained for 90 days only.

除非另有說明，此報告結果僅對測試之樣品負責，同時此樣品僅保留90天。本報告未經本公司書面許可，不可部份複製。

This document is issued by the Company subject to its General Conditions of Service printed overleaf, available on request or accessible at [www.sgs.com/terms\\_and\\_conditions.htm](http://www.sgs.com/terms_and_conditions.htm) and for electronic format documents, subject to Terms and Conditions for Electronic Documents at [www.sgs.com/terms\\_e-document.htm](http://www.sgs.com/terms_e-document.htm). Attention is drawn to the limitation of liability, indemnification and jurisdiction issues defined therein. Any holder of this document is advised that information contained hereon reflects the Company's findings at the time of its intervention only and within the limits of Client's instructions, if any. The Company's sole responsibility is to its Client and this document does not exonerate parties to a transaction from exercising all their rights and obligations under the transaction documents. This document cannot be reproduced except in full, without prior written approval of the Company. Any unauthorized alteration, forgery or falsification of the content or appearance of this document is unlawful and offenders may be prosecuted to the fullest extent of the law.

SGS Taiwan Ltd. No.134, Wu Kung Road, Wuku Industrial Zone, Taipei County, Taiwan / 台北縣五股工業區五工路 134 號

台灣檢驗科技股份有限公司 t (886-2) 2299-3279

f (886-2) 2298-0488

[www.tw.sgs.com](http://www.tw.sgs.com)

Member of SGS Group

**Radiated Spurious Emission Measurement Result (above 1GHz) (Worst EDR mode)**

Operation Mode	TX CH Low	Test Date	Feb. 22, 2012
Fundamental Frequency	2402 MHz	Test By	Lion
Temperature	25 °C	Pol	Ver.
Humidity	65 %		

Freq. (MHz)	Peak	AV	Ant./CL CF(dB)	Actual FS		Peak	AV	Margin (dB)
	Reading (dBuV)	Reading (dBuV)		Peak (dBuV/m)	AV (dBuV/m)	Limit (dBuV/m)	Limit (dBuV/m)	
3203.5	47.56	---	0.78	48.34	---	74.00	54.00	-5.66
4804.0	----					74.00	54.00	
7206.0	----					74.00	54.00	
9608.0	----					74.00	54.00	
12010.0	----					74.00	54.00	
14412.0	----					74.00	54.00	
16814.0	----					74.00	54.00	
19216.0	----					74.00	54.00	
21618.0	----					74.00	54.00	
24020.0	----					74.00	54.00	

Remark:

- (1) Measuring frequencies from 1GHz to the 10th harmonic of highest fundamental frequency.
- (2) Data of measurement within this frequency range shown “ - ” in the table above means the reading of emissions are attenuated more than 20dB below the permissible limits or the field strength is too small to be measured.
- (3) Radiated emissions measured in frequency above 1000MHz were made with an instrument using Peak detector mode and average detector mode of the emission shown in Actual FS column.
- (4) Spectrum Peak Setting : 1GHz- 26GHz, RBW= 1MHz, VBW= 3MHz, Sweep time= 200 ms.
- (5) Spectrum AV Setting : 1GHz- 26GHz, RBW= 1MHz, VBW= 10Hz, Sweep time= 200 ms.

Unless otherwise stated the results shown in this test report refer only to the sample(s) tested and such sample(s) are retained for 90 days only.

除非另有說明，此報告結果僅對測試之樣品負責，同時此樣品僅保留90天。本報告未經本公司書面許可，不可部份複製。

This document is issued by the Company subject to its General Conditions of Service printed overleaf, available on request or accessible at [www.sgs.com/terms\\_and\\_conditions.htm](http://www.sgs.com/terms_and_conditions.htm) and for electronic format documents, subject to Terms and Conditions for Electronic Documents at [www.sgs.com/terms\\_e-document.htm](http://www.sgs.com/terms_e-document.htm). Attention is drawn to the limitation of liability, indemnification and jurisdiction issues defined therein. Any holder of this document is advised that information contained hereon reflects the Company's findings at the time of its intervention only and within the limits of Client's instructions, if any. The Company's sole responsibility is to its Client and this document does not exonerate parties to a transaction from exercising all their rights and obligations under the transaction documents. This document cannot be reproduced except in full, without prior written approval of the Company. Any unauthorized alteration, forgery or falsification of the content or appearance of this document is unlawful and offenders may be prosecuted to the fullest extent of the law.

SGS Taiwan Ltd. No.134, Wu Kung Road, Wuku Industrial Zone, Taipei County, Taiwan / 台北縣五股工業區五工路 134 號

Operation Mode	TX CH Low	Test Date	Feb. 22, 2012
Fundamental Frequency	2402 MHz	Test By	Lion
Temperature	25 °C	Pol	Hor.
Humidity	65 %		

Freq. (MHz)	Peak	AV	Ant./CL CF(dB)	Actual FS		Peak	AV	Margin (dB)
	Reading (dBuV)	Reading (dBuV)		Peak (dBuV/m)	AV (dBuV/m)	Limit (dBuV/m)	Limit (dBuV/m)	
3203.5	43.25	---	0.78	44.03	---	74.00	54.00	-9.97
4804.0	----					74.00	54.00	
7206.0	----					74.00	54.00	
9608.0	----					74.00	54.00	
12010.0	----					74.00	54.00	
14412.0	----					74.00	54.00	
16814.0	----					74.00	54.00	
19216.0	----					74.00	54.00	
21618.0	----					74.00	54.00	
24020.0	----					74.00	54.00	

Remark:

- (1) Measuring frequencies from 1GHz to the 10th harmonic of highest fundamental frequency.
- (2) Data of measurement within this frequency range shown “ - ” in the table above means the reading of emissions are attenuated more than 20dB below the permissible limits or the field strength is too small to be measured.
- (3) Radiated emissions measured in frequency above 1000MHz were made with an instrument using Peak detector mode and average detector mode of the emission shown in Actual FS column.
- (4) Spectrum Peak Setting : 1GHz- 26GHz, RBW= 1MHz, VBW= 3MHz, Sweep time= 200 ms.
- (5) Spectrum AV Setting : 1GHz- 26GHz, RBW= 1MHz, VBW= 10Hz, Sweep time= 200 ms.

Unless otherwise stated the results shown in this test report refer only to the sample(s) tested and such sample(s) are retained for 90 days only.

除非另有說明，此報告結果僅對測試之樣品負責，同時此樣品僅保留90天。本報告未經本公司書面許可，不可部份複製。

This document is issued by the Company subject to its General Conditions of Service printed overleaf, available on request or accessible at [www.sgs.com/terms\\_and\\_conditions.htm](http://www.sgs.com/terms_and_conditions.htm) and for electronic format documents, subject to Terms and Conditions for Electronic Documents at [www.sgs.com/terms\\_e-document.htm](http://www.sgs.com/terms_e-document.htm). Attention is drawn to the limitation of liability, indemnification and jurisdiction issues defined therein. Any holder of this document is advised that information contained hereon reflects the Company's findings at the time of its intervention only and within the limits of Client's instructions, if any. The Company's sole responsibility is to its Client and this document does not exonerate parties to a transaction from exercising all their rights and obligations under the transaction documents. This document cannot be reproduced except in full, without prior written approval of the Company. Any unauthorized alteration, forgery or falsification of the content or appearance of this document is unlawful and offenders may be prosecuted to the fullest extent of the law.

SGS Taiwan Ltd. No.134, Wu Kung Road, Wuku Industrial Zone, Taipei County, Taiwan / 台北縣五股工業區五工路 134 號

台灣檢驗科技股份有限公司 t (886-2) 2299-3279

f (886-2) 2298-0488

[www.tw.sgs.com](http://www.tw.sgs.com)

Member of SGS Group

Operation Mode	TX CH Mid	Test Date	Feb. 22, 2012
Fundamental Frequency	2441 MHz	Test By	Lion
Temperature	25 °C	Pol	Ver.
Humidity	65 %		

Freq. (MHz)	Peak	AV	Ant./CL CF(dB)	Actual FS		Peak	AV	Margin (dB)
	Reading (dBuV)	Reading (dBuV)		Peak (dBuV/m)	AV (dBuV/m)	Limit (dBuV/m)	Limit (dBuV/m)	
3255.5	47.78	---	0.61	48.39	---	74.00	54.00	-5.61
4882.0	----					74.00	54.00	
7323.0	----					74.00	54.00	
9764.0	----					74.00	54.00	
12205.0	----					74.00	54.00	
14646.0	----					74.00	54.00	
17087.0	----					74.00	54.00	
19528.0	----					74.00	54.00	
21969.0	----					74.00	54.00	
24410.0	----					74.00	54.00	

Remark:

- (1) Measuring frequencies from 1GHz to the 10th harmonic of highest fundamental frequency.
- (2) Data of measurement within this frequency range shown “ - ” in the table above means the reading of emissions are attenuated more than 20dB below the permissible limits or the field strength is too small to be measured.
- (3) Radiated emissions measured in frequency above 1000MHz were made with an instrument using Peak detector mode and average detector mode of the emission shown in Actual FS column.
- (4) Spectrum Peak Setting : 1GHz- 26GHz, RBW= 1MHz, VBW= 3MHz, Sweep time= 200 ms.
- (5) Spectrum AV Setting : 1GHz- 26GHz, RBW= 1MHz, VBW= 10Hz, Sweep time= 200 ms.

Unless otherwise stated the results shown in this test report refer only to the sample(s) tested and such sample(s) are retained for 90 days only.

除非另有說明，此報告結果僅對測試之樣品負責，同時此樣品僅保留90天。本報告未經本公司書面許可，不可部份複製。

This document is issued by the Company subject to its General Conditions of Service printed overleaf, available on request or accessible at [www.sgs.com/terms\\_and\\_conditions.htm](http://www.sgs.com/terms_and_conditions.htm) and for electronic format documents, subject to Terms and Conditions for Electronic Documents at [www.sgs.com/terms\\_e-document.htm](http://www.sgs.com/terms_e-document.htm). Attention is drawn to the limitation of liability, indemnification and jurisdiction issues defined therein. Any holder of this document is advised that information contained hereon reflects the Company's findings at the time of its intervention only and within the limits of Client's instructions, if any. The Company's sole responsibility is to its Client and this document does not exonerate parties to a transaction from exercising all their rights and obligations under the transaction documents. This document cannot be reproduced except in full, without prior written approval of the Company. Any unauthorized alteration, forgery or falsification of the content or appearance of this document is unlawful and offenders may be prosecuted to the fullest extent of the law.

SGS Taiwan Ltd. No.134, Wu Kung Road, Wuku Industrial Zone, Taipei County, Taiwan / 台北縣五股工業區五工路 134 號

台灣檢驗科技股份有限公司 t (886-2) 2299-3279

f (886-2) 2298-0488

[www.tw.sgs.com](http://www.tw.sgs.com)

Member of SGS Group

Operation Mode	TX CH Mid	Test Date	Feb. 22, 2012
Fundamental Frequency	2441 MHz	Test By	Lion
Temperature	25 °C	Pol	Hor.
Humidity	65 %		

Freq. (MHz)	Peak	AV	Ant./CL CF(dB)	Actual FS		Peak	AV	Margin (dB)
	Reading (dBuV)	Reading (dBuV)		Peak (dBuV/m)	AV (dBuV/m)	Limit (dBuV/m)	Limit (dBuV/m)	
3255.5	45.84	---	0.61	46.45	---	74.00	54.00	-7.55
4882.0	----					74.00	54.00	
7323.0	----					74.00	54.00	
9764.0	----					74.00	54.00	
12205.0	----					74.00	54.00	
14646.0	----					74.00	54.00	
17087.0	----					74.00	54.00	
19528.0	----					74.00	54.00	
21969.0	----					74.00	54.00	
24410.0	----					74.00	54.00	

Remark:

- (1) Measuring frequencies from 1GHz to the 10th harmonic of highest fundamental frequency.
- (2) Data of measurement within this frequency range shown “ - ” in the table above means the reading of emissions are attenuated more than 20dB below the permissible limits or the field strength is too small to be measured.
- (3) Radiated emissions measured in frequency above 1000MHz were made with an instrument using Peak detector mode and average detector mode of the emission shown in Actual FS column.
- (4) Spectrum Peak Setting : 1GHz- 26GHz, RBW= 1MHz, VBW= 3MHz, Sweep time= 200 ms.
- (5) Spectrum AV Setting : 1GHz- 26GHz, RBW= 1MHz, VBW= 10Hz, Sweep time= 200 ms.

Unless otherwise stated the results shown in this test report refer only to the sample(s) tested and such sample(s) are retained for 90 days only.

除非另有說明，此報告結果僅對測試之樣品負責，同時此樣品僅保留90天。本報告未經本公司書面許可，不可部份複製。

This document is issued by the Company subject to its General Conditions of Service printed overleaf, available on request or accessible at [www.sgs.com/terms\\_and\\_conditions.htm](http://www.sgs.com/terms_and_conditions.htm) and for electronic format documents, subject to Terms and Conditions for Electronic Documents at [www.sgs.com/terms\\_e-document.htm](http://www.sgs.com/terms_e-document.htm). Attention is drawn to the limitation of liability, indemnification and jurisdiction issues defined therein. Any holder of this document is advised that information contained hereon reflects the Company's findings at the time of its intervention only and within the limits of Client's instructions, if any. The Company's sole responsibility is to its Client and this document does not exonerate parties to a transaction from exercising all their rights and obligations under the transaction documents. This document cannot be reproduced except in full, without prior written approval of the Company. Any unauthorized alteration, forgery or falsification of the content or appearance of this document is unlawful and offenders may be prosecuted to the fullest extent of the law.

SGS Taiwan Ltd. No.134, Wu Kung Road, Wuku Industrial Zone, Taipei County, Taiwan / 台北縣五股工業區五工路 134 號

台灣檢驗科技股份有限公司 t (886-2) 2299-3279

f (886-2) 2298-0488

[www.tw.sgs.com](http://www.tw.sgs.com)

Member of SGS Group

Operation Mode	TX CH High	Test Date	Feb. 22, 2012
Fundamental Frequency	2480 MHz	Test By	Lion
Temperature	25 °C	Pol	Ver.
Humidity	65 %		

Freq. (MHz)	Peak	AV	Ant./CL CF(dB)	Actual FS		Peak	AV	Margin (dB)
	Reading (dBuV)	Reading (dBuV)		Peak (dBuV/m)	AV (dBuV/m)	Limit (dBuV/m)	Limit (dBuV/m)	
3307.5	48.77	---	0.41	49.18	---	74.00	54.00	-4.82
4960.0	----					74.00	54.00	
7440.0	----					74.00	54.00	
9920.0	----					74.00	54.00	
12400.0	----					74.00	54.00	
14880.0	----					74.00	54.00	
17360.0	----					74.00	54.00	
19840.0	----					74.00	54.00	
22320.0	----					74.00	54.00	
24800.0	----					74.00	54.00	

Remark:

- (1) Measuring frequencies from 1GHz to the 10th harmonic of highest fundamental frequency.
- (2) Data of measurement within this frequency range shown “ - ” in the table above means the reading of emissions are attenuated more than 20dB below the permissible limits or the field strength is too small to be measured.
- (3) Radiated emissions measured in frequency above 1000MHz were made with an instrument using Peak detector mode and average detector mode of the emission shown in Actual FS column.
- (4) Spectrum Peak Setting : 1GHz- 26GHz, RBW= 1MHz, VBW= 3MHz, Sweep time= 200 ms.
- (5) Spectrum AV Setting : 1GHz- 26GHz, RBW= 1MHz, VBW= 10Hz, Sweep time= 200 ms.

Unless otherwise stated the results shown in this test report refer only to the sample(s) tested and such sample(s) are retained for 90 days only.

除非另有說明，此報告結果僅對測試之樣品負責，同時此樣品僅保留90天。本報告未經本公司書面許可，不可部份複製。

This document is issued by the Company subject to its General Conditions of Service printed overleaf, available on request or accessible at [www.sgs.com/terms\\_and\\_conditions.htm](http://www.sgs.com/terms_and_conditions.htm) and for electronic format documents, subject to Terms and Conditions for Electronic Documents at [www.sgs.com/terms\\_e-document.htm](http://www.sgs.com/terms_e-document.htm). Attention is drawn to the limitation of liability, indemnification and jurisdiction issues defined therein. Any holder of this document is advised that information contained hereon reflects the Company's findings at the time of its intervention only and within the limits of Client's instructions, if any. The Company's sole responsibility is to its Client and this document does not exonerate parties to a transaction from exercising all their rights and obligations under the transaction documents. This document cannot be reproduced except in full, without prior written approval of the Company. Any unauthorized alteration, forgery or falsification of the content or appearance of this document is unlawful and offenders may be prosecuted to the fullest extent of the law.

SGS Taiwan Ltd. No.134, Wu Kung Road, Wuku Industrial Zone, Taipei County, Taiwan / 台北縣五股工業區五工路 134 號

台灣檢驗科技股份有限公司 t (886-2) 2299-3279

f (886-2) 2298-0488

[www.tw.sgs.com](http://www.tw.sgs.com)

Member of SGS Group

Operation Mode	TX CH High	Test Date	Feb. 22, 2012
Fundamental Frequency	2480 MHz	Test By	Lion
Temperature	25 °C	Pol	Hor.
Humidity	65 %		

Freq. (MHz)	Peak	AV	Ant./CL CF(dB)	Actual FS		Peak	AV	Margin (dB)
	Reading (dBuV)	Reading (dBuV)		Peak (dBuV/m)	AV (dBuV/m)	Limit (dBuV/m)	Limit (dBuV/m)	
3307.5	46.11	---	0.41	46.52	---	74.00	54.00	-7.48
4960.0	----					74.00	54.00	
7440.0	----					74.00	54.00	
9920.0	----					74.00	54.00	
12400.0	----					74.00	54.00	
14880.0	----					74.00	54.00	
17360.0	----					74.00	54.00	
19840.0	----					74.00	54.00	
22320.0	----					74.00	54.00	
24800.0	----					74.00	54.00	

Remark:

- (1) Measuring frequencies from 1GHz to the 10th harmonic of highest fundamental frequency.
- (2) Data of measurement within this frequency range shown “ - ” in the table above means the reading of emissions are attenuated more than 20dB below the permissible limits or the field strength is too small to be measured.
- (3) Radiated emissions measured in frequency above 1000MHz were made with an instrument using Peak detector mode and average detector mode of the emission shown in Actual FS column.
- (4) Spectrum Peak Setting : 1GHz- 26GHz, RBW= 1MHz, VBW= 3MHz, Sweep time= 200 ms.
- (5) Spectrum AV Setting : 1GHz- 26GHz, RBW= 1MHz, VBW= 10Hz, Sweep time= 200 ms.

Unless otherwise stated the results shown in this test report refer only to the sample(s) tested and such sample(s) are retained for 90 days only.

除非另有說明，此報告結果僅對測試之樣品負責，同時此樣品僅保留90天。本報告未經本公司書面許可，不可部份複製。

This document is issued by the Company subject to its General Conditions of Service printed overleaf, available on request or accessible at [www.sgs.com/terms\\_and\\_conditions.htm](http://www.sgs.com/terms_and_conditions.htm) and for electronic format documents, subject to Terms and Conditions for Electronic Documents at [www.sgs.com/terms\\_e-document.htm](http://www.sgs.com/terms_e-document.htm). Attention is drawn to the limitation of liability, indemnification and jurisdiction issues defined therein. Any holder of this document is advised that information contained hereon reflects the Company's findings at the time of its intervention only and within the limits of Client's instructions, if any. The Company's sole responsibility is to its Client and this document does not exonerate parties to a transaction from exercising all their rights and obligations under the transaction documents. This document cannot be reproduced except in full, without prior written approval of the Company. Any unauthorized alteration, forgery or falsification of the content or appearance of this document is unlawful and offenders may be prosecuted to the fullest extent of the law.

SGS Taiwan Ltd. No.134, Wu Kung Road, Wuku Industrial Zone, Taipei County, Taiwan / 台北縣五股工業區五工路 134 號

台灣檢驗科技股份有限公司 t (886-2) 2299-3279

f (886-2) 2298-0488

[www.tw.sgs.com](http://www.tw.sgs.com)

Member of SGS Group

## 10. FREQUENCY SEPARATION

### 10.1. Standard Applicable

According to §15.247(a)(1), Frequency hopping systems shall have hopping channel carrier frequencies separated by minimum of 25KHz or the  $2/3 * 20\text{dB}$  bandwidth of the hopping channel, whichever is greater.

### 10.2. Measurement Equipment Used:

Refer to section 6.2 for details.

### 10.3. Test Set-up:

Refer to section 6.3 for details.

### 10.4. Measurement Procedure:

1. Place the EUT on the table and set it in transmitting mode.
2. Remove the antenna from the EUT and then connect a low loss RF cable from the antenna port to the spectrum analyzer.
3. Set center frequency of spectrum analyzer = middle of hopping channel .
4. Set the spectrum analyzer as RBW,VBW=100KHz, Adjust Span to 3.0 MHz, Sweep = auto.
5. Max hold. Mark 3 Peaks of hopping channel and record the 3 peaks frequency.

### 10.5. Measurement Result:

Channel separation (MHz)	Limit	Result
1	$\geq 25\text{KHz}$ or $2/3$ times 20dB bandwidth	PASS

Note: Refer to next page for plots.

Unless otherwise stated the results shown in this test report refer only to the sample(s) tested and such sample(s) are retained for 90 days only.

除非另有說明，此報告結果僅對測試之樣品負責，同時此樣品僅保留90天。本報告未經本公司書面許可，不可部份複製。

This document is issued by the Company subject to its General Conditions of Service printed overleaf, available on request or accessible at [www.sgs.com/terms\\_and\\_conditions.htm](http://www.sgs.com/terms_and_conditions.htm) and for electronic format documents, subject to Terms and Conditions for Electronic Documents at [www.sgs.com/terms\\_e-document.htm](http://www.sgs.com/terms_e-document.htm). Attention is drawn to the limitation of liability, indemnification and jurisdiction issues defined therein. Any holder of this document is advised that information contained hereon reflects the Company's findings at the time of its intervention only and within the limits of Client's instructions, if any. The Company's sole responsibility is to its Client and this document does not exonerate parties to a transaction from exercising all their rights and obligations under the transaction documents. This document cannot be reproduced except in full, without prior written approval of the Company. Any unauthorized alteration, forgery or falsification of the content or appearance of this document is unlawful and offenders may be prosecuted to the fullest extent of the law.

SGS Taiwan Ltd. No.134, Wu Kung Road, Wuku Industrial Zone, Taipei County, Taiwan / 台北縣五股工業區五工路 134 號

台灣檢驗科技股份有限公司 t (886-2) 2299-3279

f (886-2) 2298-0488

[www.tw.sgs.com](http://www.tw.sgs.com)

Member of SGS Group



### Frequency Separation Test Data

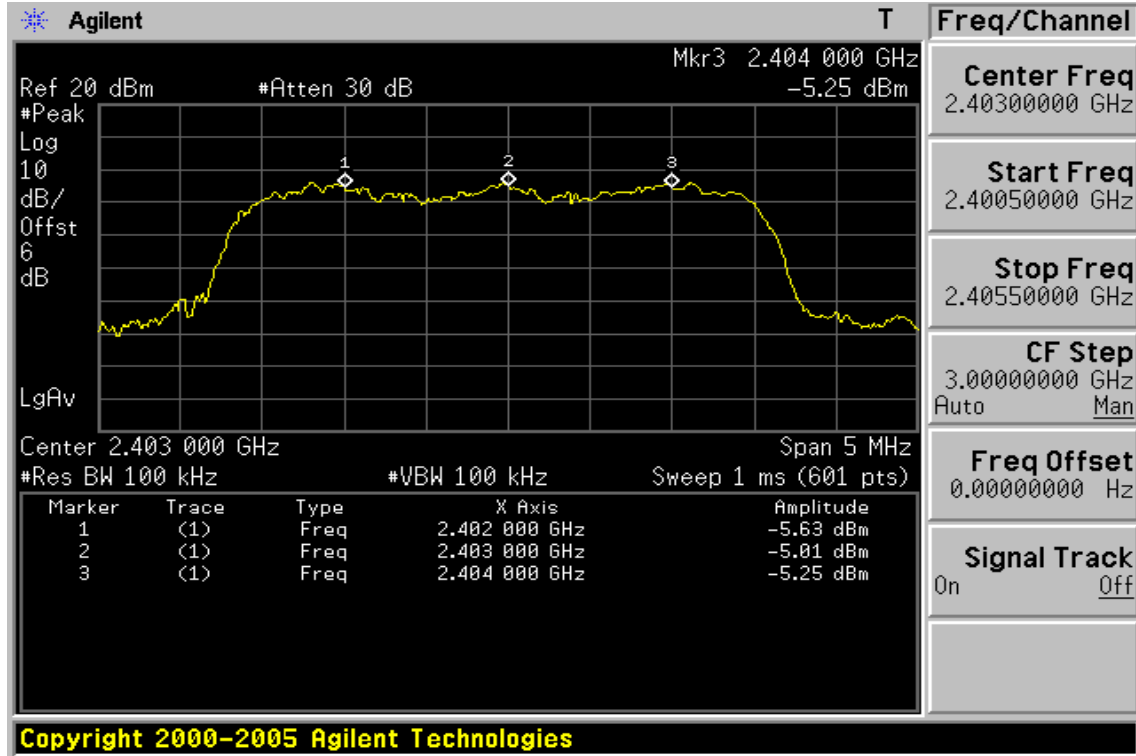

Unless otherwise stated the results shown in this test report refer only to the sample(s) tested and such sample(s) are retained for 90 days only.

除非另有說明，此報告結果僅對測試之樣品負責，同時此樣品僅保留90天。本報告未經本公司書面許可，不可部份複製。

This document is issued by the Company subject to its General Conditions of Service printed overleaf, available on request or accessible at [www.sgs.com/terms\\_and\\_conditions.htm](http://www.sgs.com/terms_and_conditions.htm) and for electronic format documents, subject to Terms and Conditions for Electronic Documents at [www.sgs.com/terms\\_e-document.htm](http://www.sgs.com/terms_e-document.htm). Attention is drawn to the limitation of liability, indemnification and jurisdiction issues defined therein. Any holder of this document is advised that information contained hereon reflects the Company's findings at the time of its intervention only and within the limits of Client's instructions, if any. The Company's sole responsibility is to its Client and this document does not exonerate parties to a transaction from exercising all their rights and obligations under the transaction documents. This document cannot be reproduced except in full, without prior written approval of the Company. Any unauthorized alteration, forgery or falsification of the content or appearance of this document is unlawful and offenders may be prosecuted to the fullest extent of the law.

SGS Taiwan Ltd. No.134, Wu Kung Road, Wuku Industrial Zone, Taipei County, Taiwan / 台北縣五股工業區五工路 134 號

台灣檢驗科技股份有限公司 t (886-2) 2299-3279

f (886-2) 2298-0488

[www.tw.sgs.com](http://www.tw.sgs.com)

Member of SGS Group

## 11. NUMBER OF HOPPING FREQUENCY

### 11.1. Standard Applicable

According to §15.247(a)(1)(iii), Frequency hopping systems operating in the 2400MHz-2483.5 MHz bands shall use at least 15 hopping frequencies.

### 11.2. Measurement Equipment Used:

Refer to section 6.2 for details.

### 11.3. Test Set-up:

Refer to section 6.3 for details.

### 11.4. Measurement Procedure:

1. Place the EUT on the table and set it in transmitting mode.
2. Remove the antenna from the EUT and then connect a low loss RF cable from the antenna port to the spectrum analyzer.
3. Set spectrum analyzer Start=2400MHz, Stop = 2483.5MHz, Sweep = auto.
4. Set the spectrum analyzer as RBW=430KHz,, VBW=1MHz.
5. Max hold, view and count how many channel in the band.

### 11.5. Measurement Result:

Note: Refer to next page for plots.

Unless otherwise stated the results shown in this test report refer only to the sample(s) tested and such sample(s) are retained for 90 days only.

除非另有說明，此報告結果僅對測試之樣品負責，同時此樣品僅保留90天。本報告未經本公司書面許可，不可部份複製。

This document is issued by the Company subject to its General Conditions of Service printed overleaf, available on request or accessible at [www.sgs.com/terms\\_and\\_conditions.htm](http://www.sgs.com/terms_and_conditions.htm) and for electronic format documents, subject to Terms and Conditions for Electronic Documents at [www.sgs.com/terms\\_e-document.htm](http://www.sgs.com/terms_e-document.htm). Attention is drawn to the limitation of liability, indemnification and jurisdiction issues defined therein. Any holder of this document is advised that information contained hereon reflects the Company's findings at the time of its intervention only and within the limits of Client's instructions, if any. The Company's sole responsibility is to its Client and this document does not exonerate parties to a transaction from exercising all their rights and obligations under the transaction documents. This document cannot be reproduced except in full, without prior written approval of the Company. Any unauthorized alteration, forgery or falsification of the content or appearance of this document is unlawful and offenders may be prosecuted to the fullest extent of the law.

SGS Taiwan Ltd. No.134, Wu Kung Road, Wuku Industrial Zone, Taipei County, Taiwan / 台北縣五股工業區五工路 134 號

台灣檢驗科技股份有限公司 t (886-2) 2299-3279

f (886-2) 2298-0488

[www.tw.sgs.com](http://www.tw.sgs.com)

Member of SGS Group

Channel Number

2.4 GHz – 2.441GHz

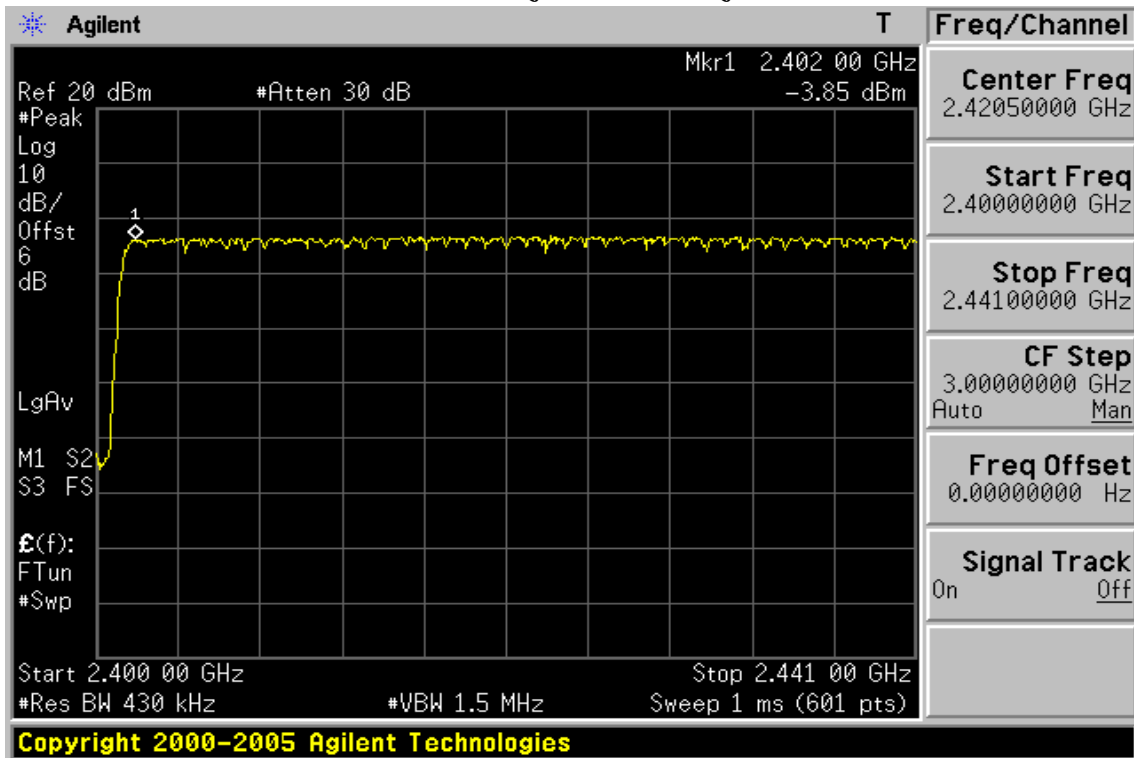

2.441 GHz – 2.4835GHz

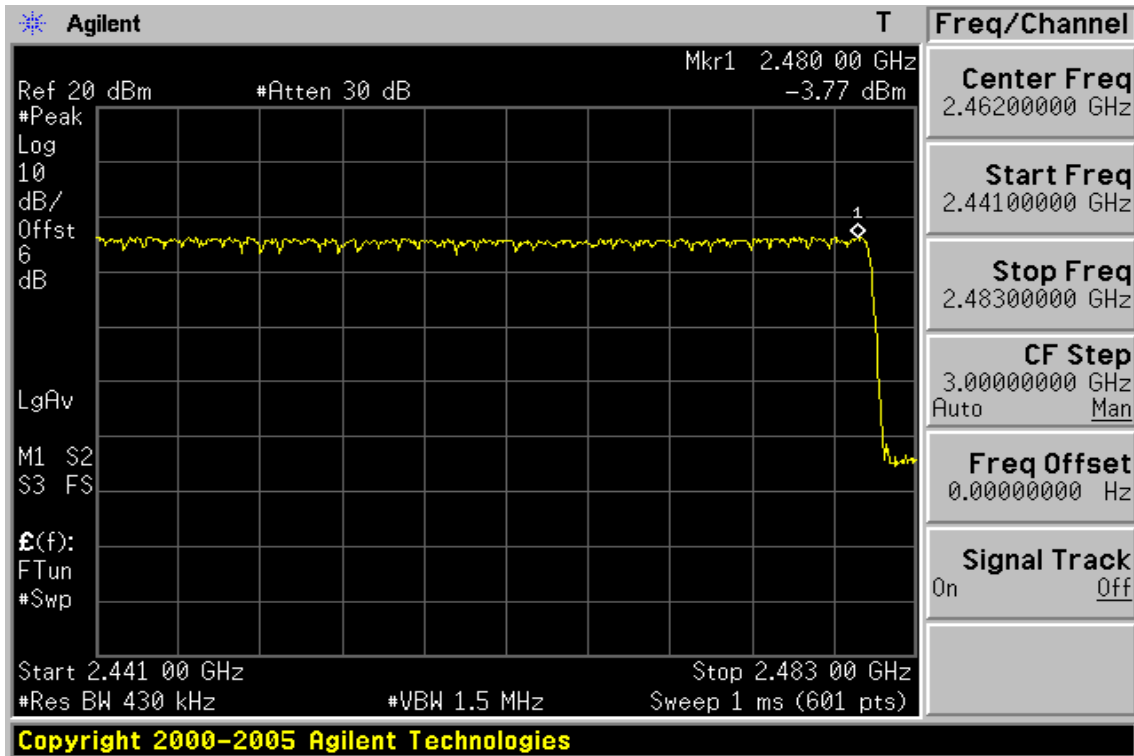

Unless otherwise stated the results shown in this test report refer only to the sample(s) tested and such sample(s) are retained for 90 days only.

除非另有說明，此報告結果僅對測試之樣品負責，同時此樣品僅保留90天。本報告未經本公司書面許可，不可部份複製。

This document is issued by the Company subject to its General Conditions of Service printed overleaf, available on request or accessible at [www.sgs.com/terms\\_and\\_conditions.htm](http://www.sgs.com/terms_and_conditions.htm) and for electronic format documents, subject to Terms and Conditions for Electronic Documents at [www.sgs.com/terms\\_e-document.htm](http://www.sgs.com/terms_e-document.htm). Attention is drawn to the limitation of liability, indemnification and jurisdiction issues defined therein. Any holder of this document is advised that information contained hereon reflects the Company's findings at the time of its intervention only and within the limits of Client's instructions, if any. The Company's sole responsibility is to its Client and this document does not exonerate parties to a transaction from exercising all their rights and obligations under the transaction documents. This document cannot be reproduced except in full, without prior written approval of the Company. Any unauthorized alteration, forgery or falsification of the content or appearance of this document is unlawful and offenders may be prosecuted to the fullest extent of the law.

SGS Taiwan Ltd. No.134, Wu Kung Road, Wuku Industrial Zone, Taipei County, Taiwan / 台北縣五股工業區五工路 134 號

## 12. TIME OF OCCUPANCY (DWELL TIME)

### 12.1. Standard Applicable

According to §15.247(a)(1)(iii), Frequency hopping systems operating in the 2400MHz-2483.5 MHz. The average time of occupancy on any frequency shall not greater than 0.4 s within period of 0.4 seconds multiplied by the number of hopping channel employed.

### 12.2. Measurement Equipment Used:

Refer to section 6.2 for details.

### 12.3. Test Set-up:

Refer to section 6.3 for details.

### 12.4. Measurement Procedure:

1. Place the EUT on the table and set it in transmitting mode.
2. Remove the antenna from the EUT and then connect a low loss RF cable from the antenna port to the spectrum analyzer.
3. Set center frequency of spectrum analyzer = operating frequency.
4. Set the spectrum analyzer as RBW,VBW=100KHz, Span = 0Hz , Adjust Sweep = 2~7ms.
5. Repeat above procedures until all frequency measured were complete.

Unless otherwise stated the results shown in this test report refer only to the sample(s) tested and such sample(s) are retained for 90 days only.

除非另有說明，此報告結果僅對測試之樣品負責，同時此樣品僅保留90天。本報告未經本公司書面許可，不可部份複製。

This document is issued by the Company subject to its General Conditions of Service printed overleaf, available on request or accessible at [www.sgs.com/terms\\_and\\_conditions.htm](http://www.sgs.com/terms_and_conditions.htm) and for electronic format documents, subject to Terms and Conditions for Electronic Documents at [www.sgs.com/terms\\_e-document.htm](http://www.sgs.com/terms_e-document.htm). Attention is drawn to the limitation of liability, indemnification and jurisdiction issues defined therein. Any holder of this document is advised that information contained hereon reflects the Company's findings at the time of its intervention only and within the limits of Client's instructions, if any. The Company's sole responsibility is to its Client and this document does not exonerate parties to a transaction from exercising all their rights and obligations under the transaction documents. This document cannot be reproduced except in full, without prior written approval of the Company. Any unauthorized alteration, forgery or falsification of the content or appearance of this document is unlawful and offenders may be prosecuted to the fullest extent of the law.

SGS Taiwan Ltd. No.134, Wu Kung Road, Wuku Industrial Zone, Taipei County, Taiwan / 台北縣五股工業區五工路 134 號

台灣檢驗科技股份有限公司 t (886-2) 2299-3279

f (886-2) 2298-0488

[www.tw.sgs.com](http://www.tw.sgs.com)

Member of SGS Group

## 12.5. Measurement Result

A period time = 0.4 (sec) \* 79 = 31.6 (s)

CH Low: DH1 time slot = 0.390 (ms) \* (1600/(2\*79)) \* 31.6 = 126.40 (ms)

DH3 time slot = 1.642 (ms) \* (1600/(4\*79)) \* 31.6 = 262.72 (ms)

DH5 time slot = 2.883 (ms) \* (1600/(6\*79)) \* 31.6 = 307.52 (ms)

CH Mid: DH1 time slot = 0.3867 (ms) \* (1600/(2\*79)) \* 31.6 = 123.74 (ms)

DH3 time slot = 1.633 (ms) \* (1600/(4\*79)) \* 31.6 = 261.28 (ms)

DH5 time slot = 2.870 (ms) \* (1600/(6\*79)) \* 31.6 = 306.13 (ms)

CH High: DH1 time slot = 0.3867 (ms) \* (1600/(2\*79)) \* 31.6 = 123.74(ms)

DH3 time slot = 1.642 (ms) \* (1600/(4\*79)) \* 31.6 = 262.72 (ms)

DH5 time slot = 2.895 (ms) \* (1600/(6\*79)) \* 31.6 = 308.80 (ms)

Note: Refer to next page for plots.

Unless otherwise stated the results shown in this test report refer only to the sample(s) tested and such sample(s) are retained for 90 days only.

除非另有說明，此報告結果僅對測試之樣品負責，同時此樣品僅保留90天。本報告未經本公司書面許可，不可部份複製。

This document is issued by the Company subject to its General Conditions of Service printed overleaf, available on request or accessible at [www.sgs.com/terms\\_and\\_conditions.htm](http://www.sgs.com/terms_and_conditions.htm) and for electronic format documents, subject to Terms and Conditions for Electronic Documents at [www.sgs.com/terms\\_e-document.htm](http://www.sgs.com/terms_e-document.htm). Attention is drawn to the limitation of liability, indemnification and jurisdiction issues defined therein. Any holder of this document is advised that information contained hereon reflects the Company's findings at the time of its intervention only and within the limits of Client's instructions, if any. The Company's sole responsibility is to its Client and this document does not exonerate parties to a transaction from exercising all their rights and obligations under the transaction documents. This document cannot be reproduced except in full, without prior written approval of the Company. Any unauthorized alteration, forgery or falsification of the content or appearance of this document is unlawful and offenders may be prosecuted to the fullest extent of the law.

SGS Taiwan Ltd. No.134, Wu Kung Road, Wuku Industrial Zone, Taipei County, Taiwan / 台北縣五股工業區五工路 134 號

台灣檢驗科技股份有限公司 t (886-2) 2299-3279

f (886-2) 2298-0488

[www.tw.sgs.com](http://www.tw.sgs.com)

Member of SGS Group

**CH-Low**

**DH1**

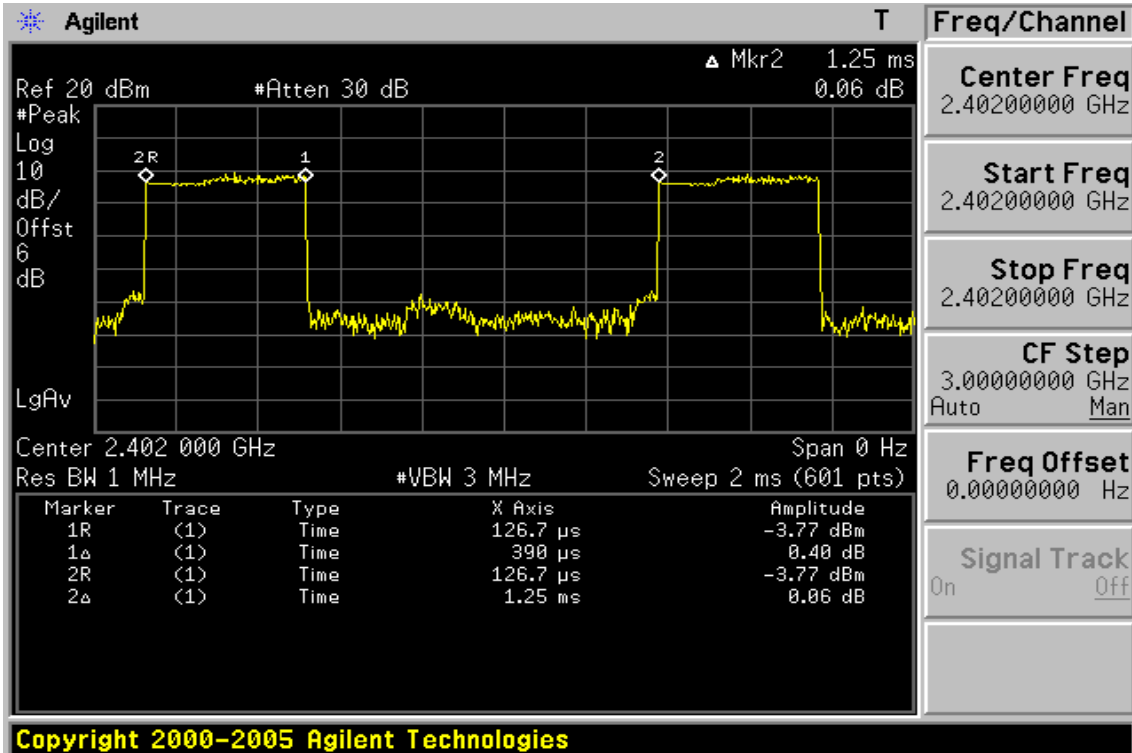

**DH3**

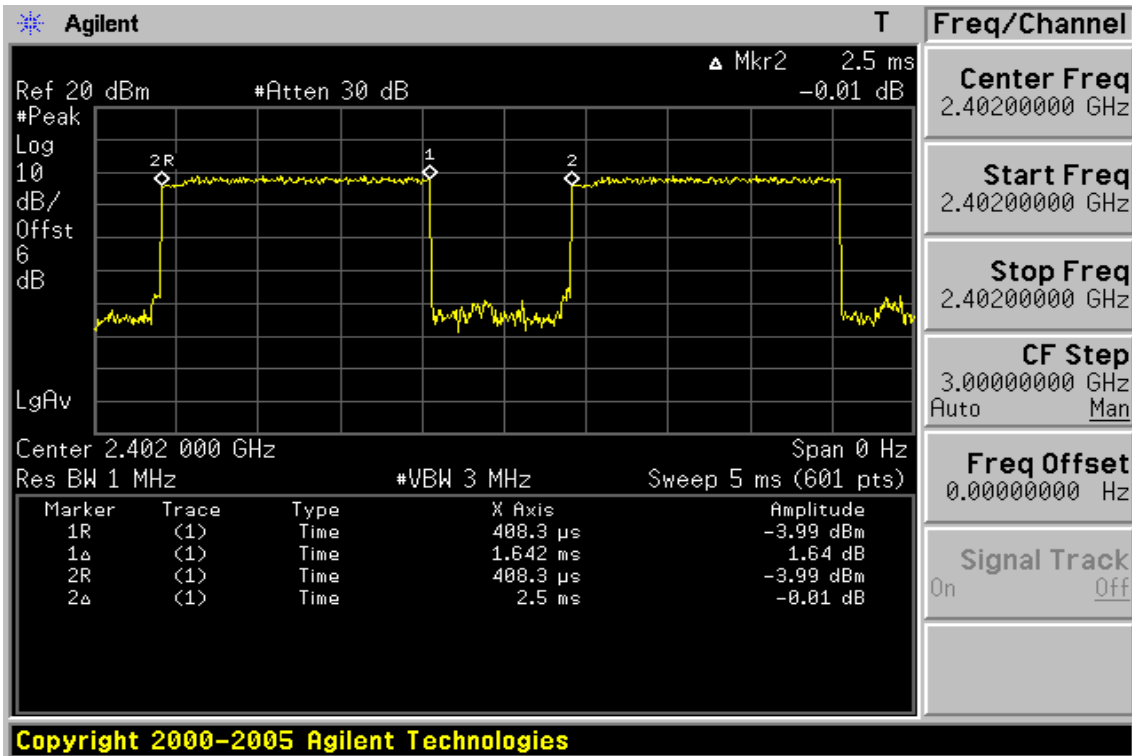

Unless otherwise stated the results shown in this test report refer only to the sample(s) tested and such sample(s) are retained for 90 days only.

除非另有說明，此報告結果僅對測試之樣品負責，同時此樣品僅保留90天。本報告未經本公司書面許可，不可部份複製。

This document is issued by the Company subject to its General Conditions of Service printed overleaf, available on request or accessible at [www.sgs.com/terms\\_and\\_conditions.htm](http://www.sgs.com/terms_and_conditions.htm) and for electronic format documents, subject to Terms and Conditions for Electronic Documents at [www.sgs.com/terms\\_e-document.htm](http://www.sgs.com/terms_e-document.htm). Attention is drawn to the limitation of liability, indemnification and jurisdiction issues defined therein. Any holder of this document is advised that information contained hereon reflects the Company's findings at the time of its intervention only and within the limits of Client's instructions, if any. The Company's sole responsibility is to its Client and this document does not exonerate parties to a transaction from exercising all their rights and obligations under the transaction documents. This document cannot be reproduced except in full, without prior written approval of the Company. Any unauthorized alteration, forgery or falsification of the content or appearance of this document is unlawful and offenders may be prosecuted to the fullest extent of the law.

SGS Taiwan Ltd. No.134, Wu Kung Road, Wuku Industrial Zone, Taipei County, Taiwan / 台北縣五股工業區五工路 134 號

## DH5

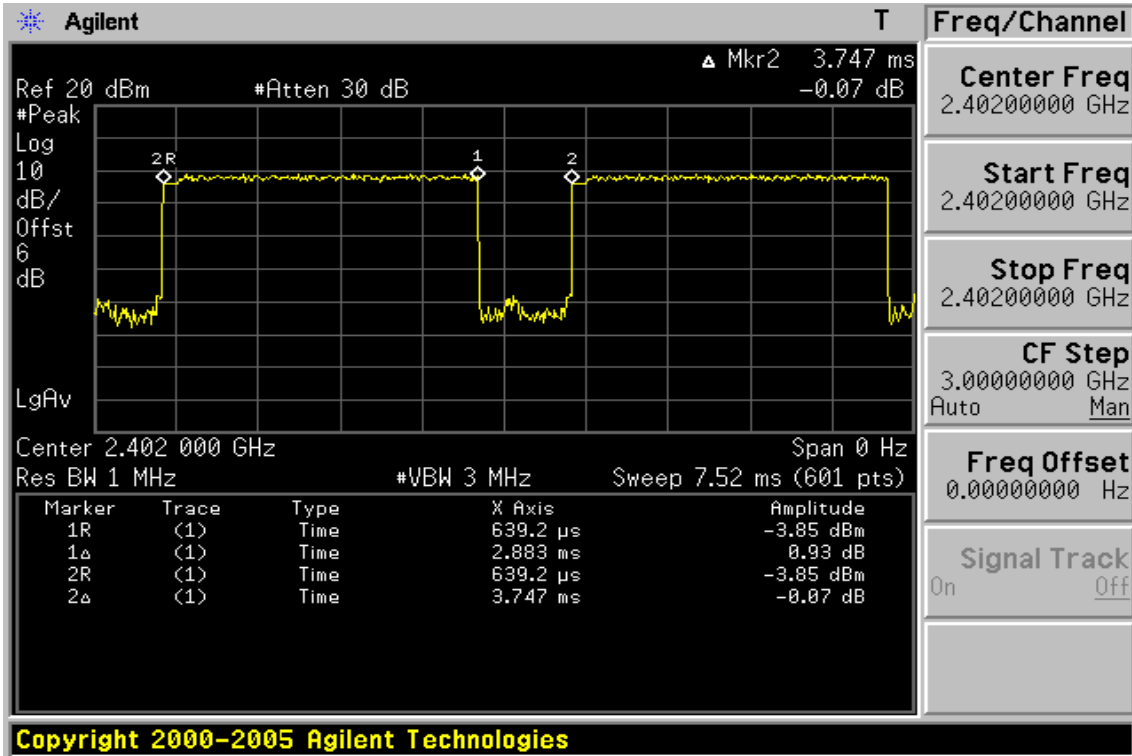

## CH-Mid

## DH1

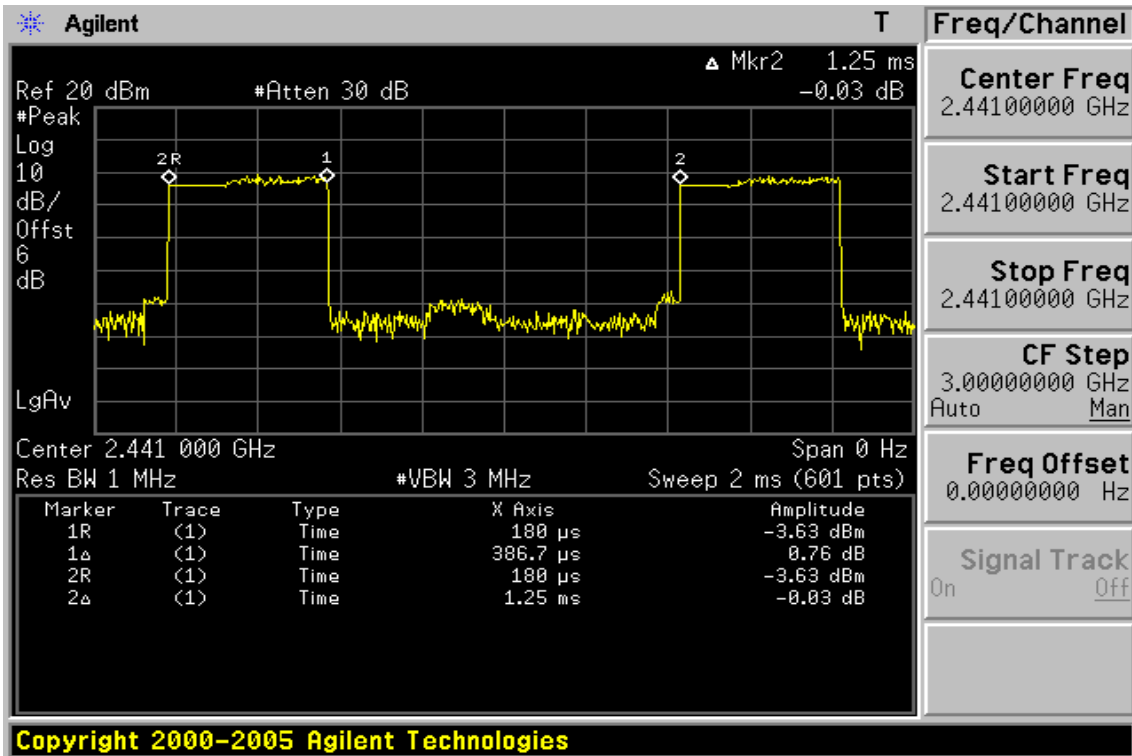

Unless otherwise stated the results shown in this test report refer only to the sample(s) tested and such sample(s) are retained for 90 days only.

除非另有說明，此報告結果僅對測試之樣品負責，同時此樣品僅保留90天。本報告未經本公司書面許可，不可部份複製。

This document is issued by the Company subject to its General Conditions of Service printed overleaf, available on request or accessible at [www.sgs.com/terms\\_and\\_conditions.htm](http://www.sgs.com/terms_and_conditions.htm) and for electronic format documents, subject to Terms and Conditions for Electronic Documents at [www.sgs.com/terms\\_e-document.htm](http://www.sgs.com/terms_e-document.htm). Attention is drawn to the limitation of liability, indemnification and jurisdiction issues defined therein. Any holder of this document is advised that information contained hereon reflects the Company's findings at the time of its intervention only and within the limits of Client's instructions, if any. The Company's sole responsibility is to its Client and this document does not exonerate parties to a transaction from exercising all their rights and obligations under the transaction documents. This document cannot be reproduced except in full, without prior written approval of the Company. Any unauthorized alteration, forgery or falsification of the content or appearance of this document is unlawful and offenders may be prosecuted to the fullest extent of the law.

SGS Taiwan Ltd. No.134, Wu Kung Road, Wuku Industrial Zone, Taipei County, Taiwan / 台北縣五股工業區五工路 134 號

### DH3

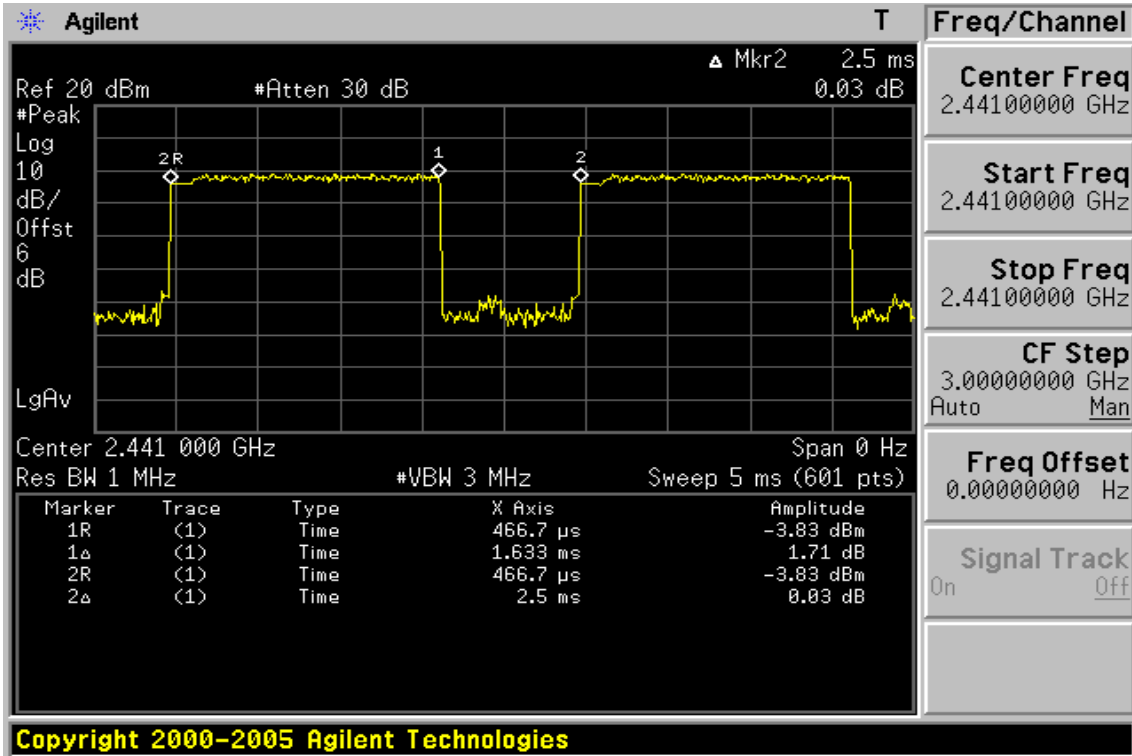

### DH5

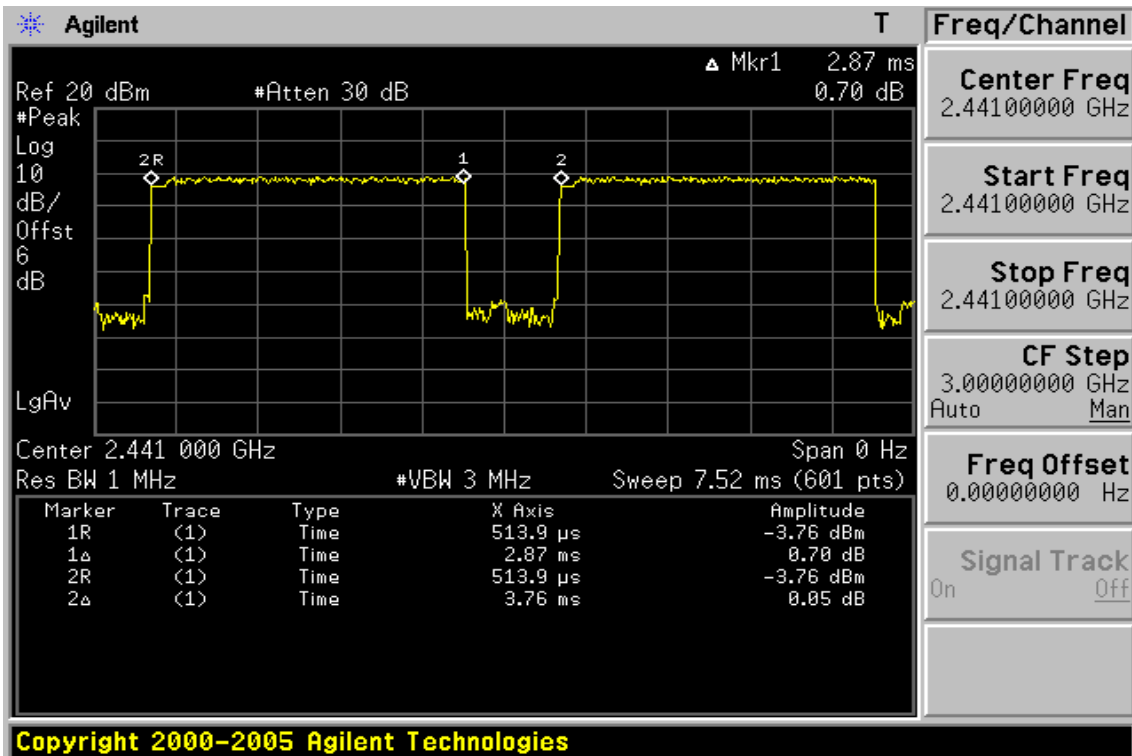

Unless otherwise stated the results shown in this test report refer only to the sample(s) tested and such sample(s) are retained for 90 days only.

除非另有說明，此報告結果僅對測試之樣品負責，同時此樣品僅保留90天。本報告未經本公司書面許可，不可部份複製。

This document is issued by the Company subject to its General Conditions of Service printed overleaf, available on request or accessible at [www.sgs.com/terms\\_and\\_conditions.htm](http://www.sgs.com/terms_and_conditions.htm) and for electronic format documents, subject to Terms and Conditions for Electronic Documents at [www.sgs.com/terms\\_e-document.htm](http://www.sgs.com/terms_e-document.htm). Attention is drawn to the limitation of liability, indemnification and jurisdiction issues defined therein. Any holder of this document is advised that information contained hereon reflects the Company's findings at the time of its intervention only and within the limits of Client's instructions, if any. The Company's sole responsibility is to its Client and this document does not exonerate parties to a transaction from exercising all their rights and obligations under the transaction documents. This document cannot be reproduced except in full, without prior written approval of the Company. Any unauthorized alteration, forgery or falsification of the content or appearance of this document is unlawful and offenders may be prosecuted to the fullest extent of the law.

SGS Taiwan Ltd. No.134, Wu Kung Road, Wuku Industrial Zone, Taipei County, Taiwan / 台北縣五股工業區五工路 134 號



## CH-High DH1

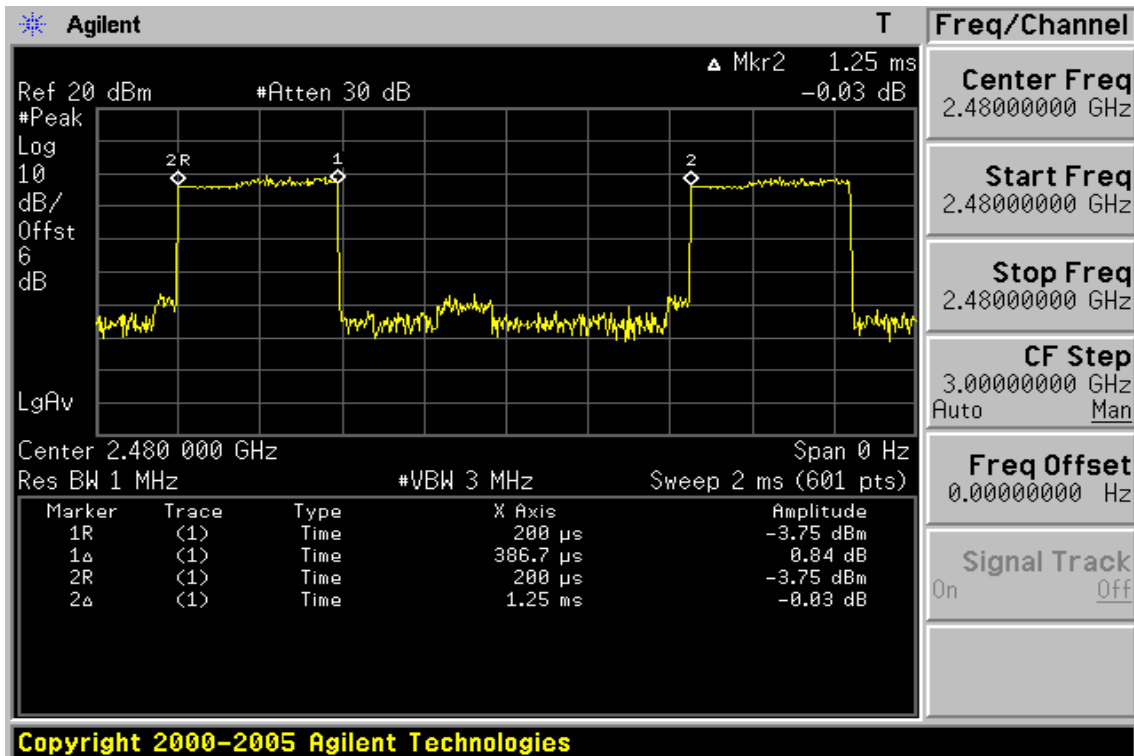

## DH3

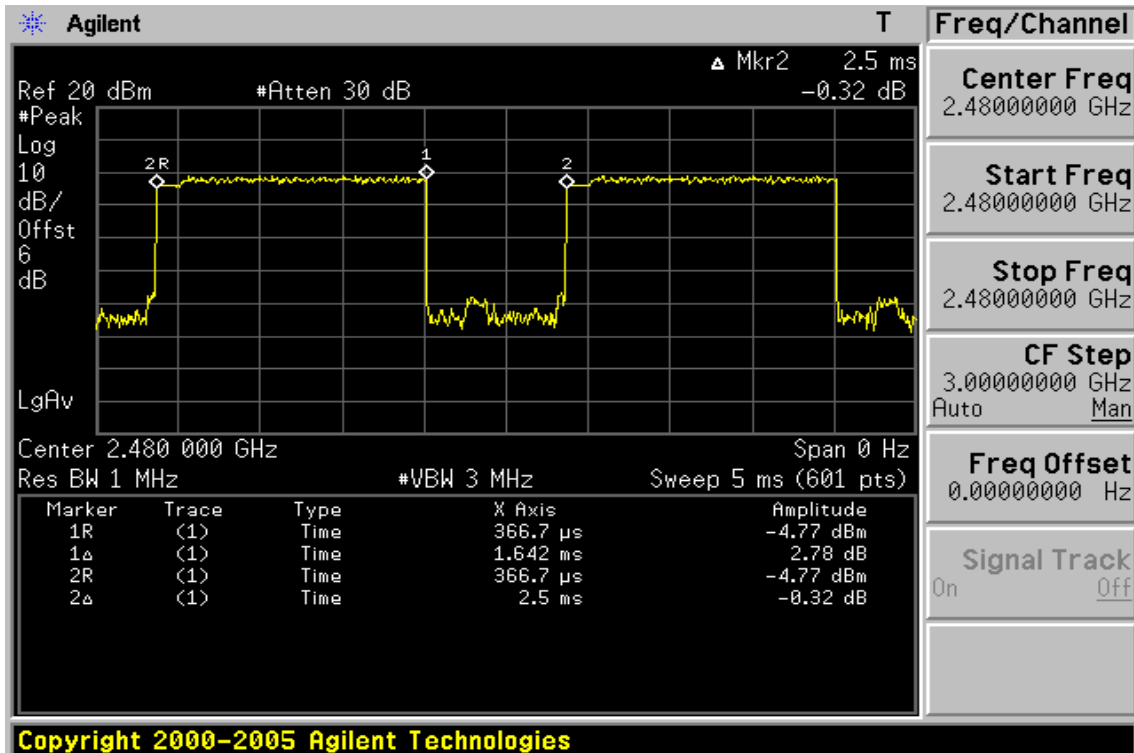

Unless otherwise stated the results shown in this test report refer only to the sample(s) tested and such sample(s) are retained for 90 days only.

除非另有說明，此報告結果僅對測試之樣品負責，同時此樣品僅保留90天。本報告未經本公司書面許可，不可部份複製。

This document is issued by the Company subject to its General Conditions of Service printed overleaf, available on request or accessible at [www.sgs.com/terms\\_and\\_conditions.htm](http://www.sgs.com/terms_and_conditions.htm) and for electronic format documents, subject to Terms and Conditions for Electronic Documents at [www.sgs.com/terms\\_e-document.htm](http://www.sgs.com/terms_e-document.htm). Attention is drawn to the limitation of liability, indemnification and jurisdiction issues defined therein. Any holder of this document is advised that information contained hereon reflects the Company's findings at the time of its intervention only and within the limits of Client's instructions, if any. The Company's sole responsibility is to its Client and this document does not exonerate parties to a transaction from exercising all their rights and obligations under the transaction documents. This document cannot be reproduced except in full, without prior written approval of the Company. Any unauthorized alteration, forgery or falsification of the content or appearance of this document is unlawful and offenders may be prosecuted to the fullest extent of the law.

SGS Taiwan Ltd. No.134, Wu Kung Road, Wuku Industrial Zone, Taipei County, Taiwan / 台北縣五股工業區五工路 134 號

台灣檢驗科技股份有限公司 t (886-2) 2299-3279

f (886-2) 2298-0488

[www.tw.sgs.com](http://www.tw.sgs.com)

Member of SGS Group

## DH5

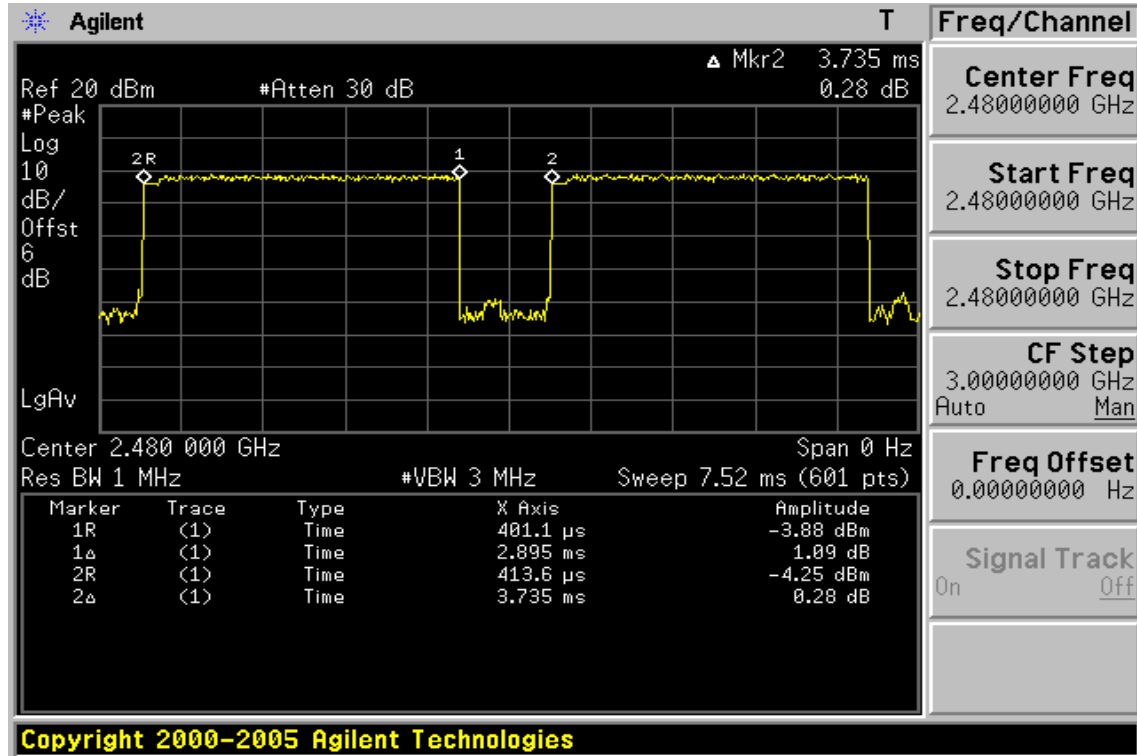

Unless otherwise stated the results shown in this test report refer only to the sample(s) tested and such sample(s) are retained for 90 days only.

除非另有說明，此報告結果僅對測試之樣品負責，同時此樣品僅保留90天。本報告未經本公司書面許可，不可部份複製。

This document is issued by the Company subject to its General Conditions of Service printed overleaf, available on request or accessible at [www.sgs.com/terms\\_and\\_conditions.htm](http://www.sgs.com/terms_and_conditions.htm) and, for electronic format documents, subject to Terms and Conditions for Electronic Documents at [www.sgs.com/terms\\_e-document.htm](http://www.sgs.com/terms_e-document.htm). Attention is drawn to the limitation of liability, indemnification and jurisdiction issues defined therein. Any holder of this document is advised that information contained hereon reflects the Company's findings at the time of its intervention only and within the limits of Client's instructions, if any. The Company's sole responsibility is to its Client and this document does not exonerate parties to a transaction from exercising all their rights and obligations under the transaction documents. This document cannot be reproduced except in full, without prior written approval of the Company. Any unauthorized alteration, forgery or falsification of the content or appearance of this document is unlawful and offenders may be prosecuted to the fullest extent of the law.

SGS Taiwan Ltd. No.134, Wu Kung Road, Wuku Industrial Zone, Taipei County, Taiwan / 台北縣五股工業區五工路 134 號

台灣檢驗科技股份有限公司 t (886-2) 2299-3279

f (886-2) 2298-0488

[www.tw.sgs.com](http://www.tw.sgs.com)

Member of SGS Group

## 13. ANTENNA REQUIREMENT

### 13.1. Standard Applicable

For intentional device, according to §15.203, an intentional radiator shall be designed to ensure that no antenna other than furnished by the responsible party shall be used with the device.

And according to §15.247(4)(1), system operating in the 2400-2483.5MHz bands that are used exclusively for fixed, point-to-point operations may employ transmitting antennas with directional gain greater than 6dBi provided the maximum peak output power of the intentional radiator is reduced by 1 dB for every 3 dB that the directional gain of the antenna exceeds 6 dBi.

### 13.2. Antenna Connected Construction

The directional gains of antenna used for transmitting is 0.6 dBi, and the antenna connector is designed with permanent attachment and no consideration of replacement. Please see EUT photo for details.

Unless otherwise stated the results shown in this test report refer only to the sample(s) tested and such sample(s) are retained for 90 days only.

除非另有說明，此報告結果僅對測試之樣品負責，同時此樣品僅保留90天。本報告未經本公司書面許可，不可部份複製。

This document is issued by the Company subject to its General Conditions of Service printed overleaf, available on request or accessible at [www.sgs.com/terms\\_and\\_conditions.htm](http://www.sgs.com/terms_and_conditions.htm) and, for electronic format documents, subject to Terms and Conditions for Electronic Documents at [www.sgs.com/terms\\_e-document.htm](http://www.sgs.com/terms_e-document.htm). Attention is drawn to the limitation of liability, indemnification and jurisdiction issues defined therein. Any holder of this document is advised that information contained hereon reflects the Company's findings at the time of its intervention only and within the limits of Client's instructions, if any. The Company's sole responsibility is to its Client and this document does not exonerate parties to a transaction from exercising all their rights and obligations under the transaction documents. This document cannot be reproduced except in full, without prior written approval of the Company. Any unauthorized alteration, forgery or falsification of the content or appearance of this document is unlawful and offenders may be prosecuted to the fullest extent of the law.

SGS Taiwan Ltd. No.134, Wu Kung Road, Wuku Industrial Zone, Taipei County, Taiwan / 台北縣五股工業區五工路 134 號

台灣檢驗科技股份有限公司 t (886-2) 2299-3279

f (886-2) 2298-0488

[www.tw.sgs.com](http://www.tw.sgs.com)

Member of SGS Group

## 14. RF EXPOSURE

### 14.1. Standard Applicable

According to §1.1307(b)(1), systems operating under the provisions of this section shall be operated in a manner that ensure that the public is not exposed to radio frequency energy level in excess of the Commission's guideline.

This is a portable device.

### 14.2. Measurement Result:

This is a portable device and the Max peak output power is 0.05 dBm (0.00101W) lower than low threshold 60/fGHz mW (24.48mW),  $d < 2.5\text{cm}$  in general population category ;

The SAR measurement is not necessary.

*~ End of Report ~*

Unless otherwise stated the results shown in this test report refer only to the sample(s) tested and such sample(s) are retained for 90 days only.

除非另有說明，此報告結果僅對測試之樣品負責，同時此樣品僅保留90天。本報告未經本公司書面許可，不可部份複製。

This document is issued by the Company subject to its General Conditions of Service printed overleaf, available on request or accessible at [www.sgs.com/terms\\_and\\_conditions.htm](http://www.sgs.com/terms_and_conditions.htm) and, for electronic format documents, subject to Terms and Conditions for Electronic Documents at [www.sgs.com/terms\\_e-document.htm](http://www.sgs.com/terms_e-document.htm). Attention is drawn to the limitation of liability, indemnification and jurisdiction issues defined therein. Any holder of this document is advised that information contained hereon reflects the Company's findings at the time of its intervention only and within the limits of Client's instructions, if any. The Company's sole responsibility is to its Client and this document does not exonerate parties to a transaction from exercising all their rights and obligations under the transaction documents. This document cannot be reproduced except in full, without prior written approval of the Company. Any unauthorized alteration, forgery or falsification of the content or appearance of this document is unlawful and offenders may be prosecuted to the fullest extent of the law.

SGS Taiwan Ltd. No.134, Wu Kung Road, Wuku Industrial Zone, Taipei County, Taiwan / 台北縣五股工業區五工路 134 號

台灣檢驗科技股份有限公司 t (886-2) 2299-3279

f (886-2) 2298-0488

[www.tw.sgs.com](http://www.tw.sgs.com)

Member of SGS Group