



# 5 GHz RLAN Test Report

**FCC ID: QKMQDSP2060INF**

This report concerns (check one) :  Original Grant  Class II Change

Issued Date : Oct. 04, 2012  
Project No. : 1208149  
Equipment : MONDOCENTER  
Model Name : INF-MCENTER

Applicant : Quanmax Inc.  
Address : 5F, No. 415, Ti-Ding Blvd., Sec. 2, NeiHu  
District, Taipei 114, Taiwan

Tested by: Neutron Engineering Inc. EMC Laboratory

Date of Receipt: Aug. 23, 2012

Date of Test: Aug. 23, 2012 ~ Sep. 26, 2012

Testing Engineer: Rush Kao  
(Rush Kao)

Technical Manager: Jeff Yang  
(Jeff Yang)

Authorized Signatory: Andy Chiu  
(Andy Chiu)

Neutron Engineering Inc.  
B1, No. 37, Lane 365, YangGuang St.,  
NeiHu District 114, Taipei, Taiwan.  
TEL: +886-2-2657-3299  
FAX: +886-2-2657-3331





### **Declaration**

**Neutron** represents to the client that testing is done in accordance with standard procedures as applicable and that test instruments used has been calibrated with the standards traceable to National Measurement Laboratory (**NML**) of **R.O.C.**, or National Institute of Standards and Technology (**NIST**) of **U.S.A.**

**Neutron's** reports apply only to the specific samples tested under conditions. It is manufacture's responsibility to ensure that additional production units of this model are manufactured with the identical electrical and mechanical components. **Neutron** shall have no liability for any declarations, inferences or generalizations drawn by the client or others from **Neutron** issued reports.

**Neutron's** reports must not be used by the client to claim product endorsement by the authorities or any agency of the Government.

This report is the confidential property of the client. As a mutual protection to the clients, the public and **Neutron-self**, extracts from the test report shall not be reproduced except in full with **Neutron's** authorized written approval.

**Neutron's** laboratory quality assurance procedures are in compliance with the **ISO Guide 17025** requirements, and accredited by the conformity assessment authorities listed in this test report.

### **Limitation**

For the use of the authority's logo is limited unless the Test Standard(s)/Scope(s)/Item(s) mentioned in this test report is (are) included in the conformity assessment authorities acceptance respective.



## Table of Contents

REPORT ISSUED HISTORY	7
1 CERTIFICATION	8
2 . SUMMARY OF TEST RESULTS	9
2.1 TEST FACILITY	10
2.2 MEASUREMENT UNCERTAINTY	10
3 GENERAL INFORMATION	11
3.1 GENERAL DESCRIPTION OF EUT	11
3.2 DESCRIPTION OF TEST MODES	13
3.3 TABLE OF PARAMETERS OF TEXT SOFTWARE SETTING	15
3.4 BLOCK DIAGRAM SHOWING THE CONFIGURATION OF SYSTEM TESTED	16
3.5 DESCRIPTION OF SUPPORT UNITS	17
4 CONDUCTED EMISSION	18
4.1 LIMIT	18
4.2 MEASUREMENT INSTRUMENTS LIST	18
4.3 TEST PROCEDURES	19
4.4 TEST SETUP LAYOUT	19
4.5 DEVIATION FROM TEST STANDARD	19
4.6 EUT OPERATING CONDITIONS	20
4.7 TEST RESULTS	21
5 ANTENNA CONDUCTED SPURIOUS EMISSION	23
5.1 LIMIT	23
5.2 MEASUREMENT INSTRUMENTS LIST	23
5.3 TEST PROCEDURES	23
5.4 TEST SETUP LAYOUT	23
5.5 DEVIATION FROM TEST STANDARD	23
5.6 EUT OPERATING CONDITIONS	23
5.7 TEST RESULTS - 5150-5350 MHZ BAND	24
5.8 TEST RESULTS - 5470-5725 MHZ BAND	47
6 26 DB BANDWIDTH	67
6.1 LIMIT	67
6.2 MEASUREMENT INSTRUMENTS LIST	67
6.3 MEASURING INSTRUMENTS SETTING	67
6.4 TEST PROCEDURES	67
6.5 TEST SETUP LAYOUT	67
6.6 DEVIATION FROM TEST STANDARD	67
6.7 EUT OPERATING CONDITIONS	67
6.8 TEST RESULTS - 5150-5250 MHZ	68
6.9 TEST RESULTS - 5250-5350 MHZ	78



## Table of Contents

6.10	TEST RESULTS - 5470-5725 MHZ	88
7	MAXIMUM PEAK CONDUCTED OUTPUT POWER	98
7.1	LIMIT	98
7.2	MEASUREMENT INSTRUMENTS LIST	98
7.3	MEASURING INSTRUMENTS SETTING	98
7.4	TEST PROCEDURES	98
7.5	TEST SETUP LAYOUT	98
7.6	DEVIATION FROM TEST STANDARD	98
7.7	EUT OPERATING CONDITIONS	99
7.8	TEST RESULTS - 5150-5250 MHZ	100
7.9	TEST RESULTS - 5250-5350 MHZ	112
7.10	TEST RESULTS - 5470-5725 MHZ	124
8	RADIATED SPURIOUS EMISSION (9 KHZ TO 1 GHZ)	136
8.1	LIMIT	136
8.2	MEASUREMENT INSTRUMENTS LIST	137
8.3	MEASURING INSTRUMENTS SETTING	137
8.4	TEST PROCEDURES	138
8.5	DEVIATION FROM TEST STANDARD	138
8.6	TEST SETUP LAYOUT	138
8.7	EUT OPERATING CONDITIONS	139
8.8	TEST RESULTS - 5150-5250 MHZ	140
8.9	TEST RESULTS - 5250-5350 MHZ	142
8.10	TEST RESULTS - 5470-5725 MHZ	144
9	RADIATED SPURIOUS EMISSION (ABOVE 1 GHZ)	146
9.1	LIMIT	146
9.2	MEASUREMENT INSTRUMENTS LIST	147
9.3	MEASURING INSTRUMENTS SETTING	147
9.4	TEST PROCEDURES	148
9.5	DEVIATION FROM TEST STANDARD	148
9.6	TEST SETUP LAYOUT	148
9.7	EUT OPERATING CONDITIONS	149
9.8	TEST RESULTS - 5150-5250 MHZ	150
9.9	TEST RESULTS - 5250-5350 MHZ	182
9.10	TEST RESULTS - 5470-5725 MHZ	214
9.11	TEST RESULTS (RESTRICTED BANDS)	250
10	POWER SPECTRAL DENSITY	268
10.1	LIMIT	268
10.2	MEASUREMENT INSTRUMENTS LIST	268



## Table of Contents

10.3	MEASURING INSTRUMENTS SETTING	268
10.4	TEST PROCEDURES	268
10.5	TEST SETUP LAYOUT	268
10.6	DEVIATION FROM TEST STANDARD	268
10.7	EUT OPERATING CONDITIONS	269
10.8	TEST RESULTS - 5150-5250 MHZ	270
10.9	TEST RESULTS - 5250-5350 MHZ	282
10.10	TEST RESULTS - 5470-5725 MHZ	294
11	PEAK EXCURSION	306
11.1	LIMIT	306
11.2	MEASUREMENT INSTRUMENTS LIST	306
11.3	MEASURING INSTRUMENTS SETTING	306
11.4	TEST PROCEDURES	306
11.5	TEST SETUP LAYOUT	306
11.6	DEVIATION FROM TEST STANDARD	307
11.7	EUT OPERATING CONDITIONS	307
11.8	TEST RESULTS - 5150-5250 MHZ	308
11.9	TEST RESULTS - 5250-5350 MHZ	318
11.10	TEST RESULTS - 5470-5725 MHZ	328
12	FREQUENCY STABILITY	338
12.1	LIMIT	338
12.2	MEASUREMENT INSTRUMENTS LIST	338
12.3	MEASURING INSTRUMENTS SETTING	338
12.4	TEST PROCEDURES	338
12.5	TEST SETUP LAYOUT	338
12.6	DEVIATION FROM TEST STANDARD	338
12.7	EUT OPERATING CONDITIONS	339
12.8	TEST RESULTS	340
13	RF EXPOSURE COMPLIANCE	341
13.1	LIMIT	341
13.2	MEASUREMENT INSTRUMENTS LIST	341
13.3	MPE CALCULATION METHOD	341
13.4	TEST SETUP LAYOUT	342
13.5	DEVIATION FROM TEST STANDARD	342
13.6	EUT OPERATING CONDITIONS	342
13.7	TEST RESULTS - 5150-5250 MHZ	343
13.8	TEST RESULTS - 5250-5230 MHZ	350
13.9	TEST RESULTS - 5470-5725 MHZ	357



## Table of Contents

14	EUT TEST PHOTO	364
----	----------------	-----



**REPORT ISSUED HISTORY**

Revised Version No.	Description	Issued Date
-	Initial Issue.	Oct. 04, 2012



## 1 CERTIFICATION

Equipment : MONDOCENTER  
Brand Name : InFocus  
Model Name : INF-MCENTER  
Applicant : Quanmax Inc.  
Date of Test : Aug. 23, 2012 ~ Sep. 26, 2012  
Standards : FCC Part 15, Subpart E: 2010  
ANSI C63.4: 2009

The above equipment has been tested and found compliance with the requirement of the relative standards by Neutron Engineering Inc. EMC Laboratory.  
The test data, data evaluation, and equipment configuration contained in our test report (Ref No. NEI-FCCP-2-1208149) were obtained utilizing the test procedures, test instruments, test sites that has been accredited by the Authority of NVLAP and TAF according to the ISO-17025 quality assessment standard and technical standard(s).





**2. SUMMARY OF TEST RESULTS**

Standard Clause	Test Item	Result
15.207	Conducted Emission	<b>PASS</b>
15.407 (a)	Antenna conducted Spurious Emission	<b>PASS</b>
15.407 (a)	26 dB Bandwidth	<b>PASS</b>
15.407 (a)	Maximum Peak Conducted Output Power	<b>PASS</b>
15.407 (a)	Radiated Spurious Emission	<b>PASS</b>
15.407 (a)	Power Spectral Density	<b>PASS</b>
15.407 (a)	Peak Excursion	<b>PASS</b>
15.407 (b)	Band Edge Emissions	<b>PASS</b>
15.407 (b)	Frequency Stability	<b>PASS</b>
15.205	Restricted Bands	<b>PASS</b>
15.203	Antenna Requirement	<b>PASS</b>
1.1307 1.1310 2.1091 2.1093	RF Exposure Compliance	<b>PASS</b>

**NOTE:**

1. **N/A:** denotes test is not applicable in this Test Report
2. Portable device; SAR report is required.
3. This test report only covers radio operating bands: 5150-5250 MHz, 5250-5350 MHz and 5470-5725 MHz (IEEE 802.11a/n).  
The test for radio operating bands: 2400-2483.5 MHz (IEEE 802.11b/g/n) and 5725-5825 MHz (IEEE 802.11a/n) is covered in another test report: NEI-FCCP-2-1-1208149.
4. (4) The EUT has two modes of operation:
  - 1) client also known as 802.11 station mode (Slave).
  - 2) bridge also known as 802.11 AP/infrastructure mode (Master).
 The mode of operation is selected by a physical switch which is located on the bottom of the unit.  
 In station mode(Slave), the EUT will operate in all UNII bands:  
 5150-5250MHz,5250-5350MHz,5470-5725MHz,5725-5825MHz.  
 In bridge or infrastructure mode(Master), the EUT will operate only in the non-DFS bands:  
 5150-5250MHz,5725-5825MHz



**2.1 TEST FACILITY**

The test facilities used to collect the test data in this report:

**Conducted emission Test:**

**C02:** (VCCI RN: C-3477; FCC RN: 614388; FCC DN: TW1054)  
1F., No. 61, Ln. 77, Sing-ai Rd., Neihu Dist., Taipei City 114, Taiwan (R.O.C.)

**Radiated emission Test (Below 1 GHz):**

**CB08:** (FCC RN: 614388; FCC DN: TW1054; IC Assigned Code: 4428C-1)  
1F., No. 61, Ln. 77, Sing-ai Rd., Neihu Dist., Taipei City 114, Taiwan (R.O.C.)

**Radiated emission Test (Above 1 GHz):**

**CB08:** (VCCI RN: G-91; FCC RN: 614388; FCC DN: TW1054; IC Assigned Code: 4428C-1)  
1F., No. 61, Ln. 77, Sing-ai Rd., Neihu Dist., Taipei City 114, Taiwan (R.O.C.)

**2.2 MEASUREMENT UNCERTAINTY**

**The measurement uncertainty is not specified by FCC/Industry Canada rules and for reference only.**

The reported uncertainty of measurement  $y \pm U$ , where expanded uncertainty  $U$  is based on a standard uncertainty multiplied by a coverage factor of  $k=2$ , providing a level of confidence of approximately **95%**.

The measurement instrumentation uncertainty considerations contained in CISPR 16-4-2.

**A. Conducted emission test:**

Test Site	Measurement Frequency Range	U , (dB)	NOTE
C02	150 kHz ~ 30 MHz	2.59	

**B. Radiated emission test:**

Test Site	Item	Measurement Frequency Range	Uncertainty	NOTE	
CB08	Radiated emission at 3m	Horizontal Polarization	30 - 200MHz	3.35 dB	
			200 - 1000MHz	3.11 dB	
			1 - 18GHz	3.97 dB	
			18 - 40GHz	4.01 dB	
		Vertical Polarization	30 - 200MHz	3.22 dB	
			200 - 1000MHz	3.24 dB	
			1 - 18GHz	4.05 dB	
			18 - 40GHz	4.04 dB	

Our calculated Measurement Instrumentation Uncertainty is shown in the tables above. These are our  $U_{lab}$  values in CISPR 16-4-2 terminology.

Since Table 1 of CISPR 16-4-2 has values of measurement instrumentation uncertainty, called  $U_{CISPR}$ , as follows:

Conducted Disturbance (mains port) – 150 kHz – 30 MHz : 3.6 dB

Radiated Disturbance (electric field strength on an open area test site or alternative test site) – 30 MHz – 1000 MHz : 5.2 dB

It can be seen that our  $U_{lab}$  values are smaller than  $U_{CISPR}$ .



**3 GENERAL INFORMATION**

**3.1 GENERAL DESCRIPTION OF EUT**

Equipment	MONDOCENTER	
Brand Name	InFocus	
Model Name	INF-MCENTER	
OEM Brand/Model Name	N/A	
Model Difference	N/A	
Product Description	The EUT is a MONDOCENTER.	
	Operation Frequency	5180~5240 MHz, 5260~5320 MHz, 5500~5700 MHz,
	Modulation Type	DBPSK, DQPSK, CCK, BPSK, QPSK, 16QAM, 64QAM, MIMO IEEE 802.11a: OFDM IEEE 802.11n: BPSK (2 TX & 2 RX)
	Bit Rate of Transmitter	IEEE 802.11a: 6, 9, 12, 18, 24, 36, 48, 54 Mbps IEEE 802.11n: HT20: 130 Mbps (max.) IEEE 802.11n: HT40: 300 Mbps (max.)
	Number Of Channel	Please refer to the Note 2.
	Antenna Designation	Please refer to the Note 3.
	Antenna Gain(Peak)	Please refer to the Note 3.
	Maximum Peak Conducted Output Power:	5180-5240 MHz Band: IEEE 802.11a: 16.59 dBm IEEE 802.11n(20 MHz): 16.84 dBm 5190-5230 MHz Band: IEEE 802.11n(40 MHz): 16.58 dBm 5260-5320 MHz Band: IEEE 802.11a: 17.59 dBm IEEE 802.11n(20 MHz): 18.41 dBm 5270-5310 MHz Band: IEEE 802.11n(40 MHz): 18.57 dBm 5500-5700 MHz Band: IEEE 802.11a: 17.91 dBm IEEE 802.11n(20 MHz): 18.94 dBm 5510-5670 MHz Band: IEEE 802.11n(40 MHz): 19.57 dBm
	Based on the application, features, or specification exhibited in User's Manual, the EUT is considered as an ITE/Computing Device. More details of EUT technical specification, please refer to the User's Manual.	
	Power Source	DC Voltage supplied from External Power Supply.
Power Rating	I/P: AC 100-240V 1.5A 50-60Hz / O/P: DC 19V 3.95A	
Connecting I/O Port(s)	Please refer to the User's Manual	
Products Covered	1 * CPU: Intel, Core i5-2520M Processor, 2.5GHz 2 * Memory: TLA, 2 GB, DDR3-1333 1 * SSD: Intel, SSDSC2CW120A3, 120 GB 1 * 2.4 GHz and 5 GHz WLAN Module: Intel, INT-62205ANHMW 1 * AC ADAPTER: AcBel, AD9013 2 * Antenna: ARISTOTLE, PFA-25-C2M2-M10-1	
EUT Modification(s)	N/A	



**NOTE:**

1. For a more detailed features description, please refer to the manufacturer's specifications or the User's Manual.
2. Channel List:

5180-5240 MHz Band (IEEE 802.11a/n (20MHz))					
Channel	Frequency (MHz)	Channel	Frequency (MHz)	Channel	Frequency (MHz)
36	5180	44	5220		
40	5200	48	5240		

5190-5230 MHz Band (IEEE 802.11n (40MHz))					
Channel	Frequency (MHz)	Channel	Frequency (MHz)	Channel	Frequency (MHz)
38	5190	46	5230		

5260-5320 MHz Band (IEEE 802.11a/n (20MHz))					
Channel	Frequency (MHz)	Channel	Frequency (MHz)	Channel	Frequency (MHz)
52	5260	60	5300		
56	5280	64	5320		

5270-5310 MHz Band (IEEE 802.11n (40MHz))					
Channel	Frequency (MHz)	Channel	Frequency (MHz)	Channel	Frequency (MHz)
54	5270	62	5310		

5500-5700 MHz Band (IEEE 802.11a/n (20MHz))					
Channel	Frequency (MHz)	Channel	Frequency (MHz)	Channel	Frequency (MHz)
100	5500	112	5560	140	5700
104	5520	116	5580		
108	5540	136	5680		

5510-5670 MHz Band (IEEE 802.11n (40MHz))					
Channel	Frequency (MHz)	Channel	Frequency (MHz)	Channel	Frequency (MHz)
102	5510	110	5550	134	5670

3. Table for Filed Antenna

Ant.	Brand	Model Name	Antenna Type	Connector	Gain (dBi)
1	ARISTOTLE	PFA-25-C2M2-M10-1	Dipole	R SMA PLUG	2.00
2	ARISTOTLE	PFA-25-C2M2-M10-1	Dipole	R SMA PLUG	2.00

4. The EUT incorporates MIMO function. Physically, the EUT provides two completed transmitters and two receivers (2T2R).

Modulated type	TX Function
IEEE 802.11a	1 TX
IEEE 802.11n (20MHz)	2 TX
IEEE 802.11n (40MHz)	2 TX



**3.2 DESCRIPTION OF TEST MODES**

To investigate the maximum EMI emission characteristics generates from EUT, the test system was pre-scanning tested base on the consideration of following EUT operation mode or test configuration mode which possible have effect on EMI emission level. Each of these EUT operation mode(s) or test configuration mode(s) mentioned above was evaluated respectively.

Test Items	IEEE	Mode	Data Rate	Channel	Note
Conducted Emission	802.11a	OFDM	6 Mbps	---	
Antenna conducted Spurious Emission	802.11a	OFDM	6 Mbps	36/40/48/52/60/64/100/116/140	
	802.11n (20 MHz)	BPSK	13 Mbps	36/40/48/52/60/64/100/116/140	
	802.11n (40 MHz)	BPSK	26 Mbps	38/46/54/62/102/110/134	
26 dB Bandwidth	802.11a	OFDM	6 Mbps	36/40/48/52/60/64/100/116/140	
	802.11n (20 MHz)	BPSK	13 Mbps	36/40/48/52/60/64/100/116/140	
	802.11n (40 MHz)	BPSK	26 Mbps	38/46/54/62/102/110/134	
Maximum Peak Conducted Output Power	802.11a	OFDM	6 Mbps	36/40/48/52/60/64/100/116/140	
	802.11n (20 MHz)	BPSK	13 Mbps	36/40/48/52/60/64/100/116/140	
	802.11n (40 MHz)	BPSK	26 Mbps	38/46/54/62/102/110/134	
Radiated Spurious Emission (30 MHz to 1 GHz)	802.11a	OFDM	6 Mbps	40	
	802.11n (20 MHz)	BPSK	26 Mbps	60/116	
Radiated Spurious Emission (above 1 GHz)	802.11a	OFDM	6 Mbps	36/40/48/52/60/64/100/116/140	
	802.11n (20 MHz)	BPSK	13 Mbps	36/40/48/52/60/64/100/116/140	
	802.11n (40 MHz)	BPSK	26 Mbps	38/46/54/62/102/110/134	
Restricted Bands	802.11a	OFDM	6 Mbps	36/48/52/64/100/140	
	802.11n (20 MHz)	BPSK	13 Mbps	36/48/52/64/100/140	
	802.11n (40 MHz)	BPSK	26 Mbps	38/46/54/62/102/134	
Power Spectral Density	802.11a	OFDM	6 Mbps	36/40/48/52/60/64/100/116/140	
	802.11n (20 MHz)	BPSK	13 Mbps	36/40/48/52/60/64/100/116/140	
	802.11n (40 MHz)	BPSK	26 Mbps	38/46/54/62/102/110/134	
Peak Excursion	802.11a	OFDM	6 Mbps	36/40/48/52/60/64/100/116/140	
	802.11n (20 MHz)	BPSK	13 Mbps	36/40/48/52/60/64/100/116/140	
	802.11n (40 MHz)	BPSK	26 Mbps	38/46/54/62/102/110/134	



Test Items	IEEE	Mode	Data Rate	Channel	Note
Band Edge Emissions	802.11a	OFDM	6 Mbps	36/64/100	
	802.11n (20 MHz)	BPSK	13 Mbps	36/64/100	
	802.11n (40 MHz)	BPSK	26 Mbps	38/62/102	
Frequency Stability	802.11a	OFDM	6 Mbps	40	
Antenna Requirement	---	---	---	---	
RF Exposure Compliance	---	---	---	---	

NOTE: The measurements are performed at the highest, middle, lowest available channels.



**3.3 TABLE OF PARAMETERS OF TEXT SOFTWARE SETTING**

During testing channel & power controlling software provided by the customer was used to control the operating channel as well as the output power level. The RF output power selection is for the setting of RF output power expected by the customer and is going to be fixed on the firmware of the final end product.

5180-5240 MHz Band						
IEEE	802.11a					
Test software Version	DRTU					
Frequency	5180 MHz	5200 MHz	5240 MHz			
Parameter	14.5	14.5	14.5			

5180-5240 MHz Band				5190-5230 MHz Band		
IEEE	802.11n (20 MHz)			802.11n (40 MHz)		
Test software Version	DRTU			DRTU		
Frequency	5180 MHz	5200 MHz	5240 MHz	5190 MHz	5230 MHz	
Parameter	11.5	11.5	11	8.5	10	

5260-5320 MHz Band						
IEEE	802.11a					
Test software Version	DRTU					
Frequency	5260 MHz	5300 MHz	5320 MHz			
Parameter	14.5	14.5	14.5			

5260-5320 MHz Band				5270-5310 MHz Band		
IEEE	802.11n (20 MHz)			802.11n (40 MHz)		
Test software Version	DRTU			DRTU		
Frequency	5260 MHz	5300 MHz	5320 MHz	5270 MHz	5310 MHz	
Parameter	11.5	11.5	11.5	11.5	8.5	

5500-5700 MHz Band						
IEEE	802.11a					
Test software Version	DRTU					
Frequency	5500 MHz	5580 MHz	5700 MHz			
Parameter	14.5	14.5	14			

5500-5700 MHz Band				5510-5670 MHz Band		
IEEE	802.11n (20 MHz)			802.11n (40 MHz)		
Test software Version	DRTU			DRTU		
Frequency	5500 MHz	5580 MHz	5700 MHz	5510 MHz	5550 MHz	5670 MHz
Parameter	12	11.5	12	11	11.5	11.5



**3.4 BLOCK DIAGRAM SHOWING THE CONFIGURATION OF SYSTEM TESTED**

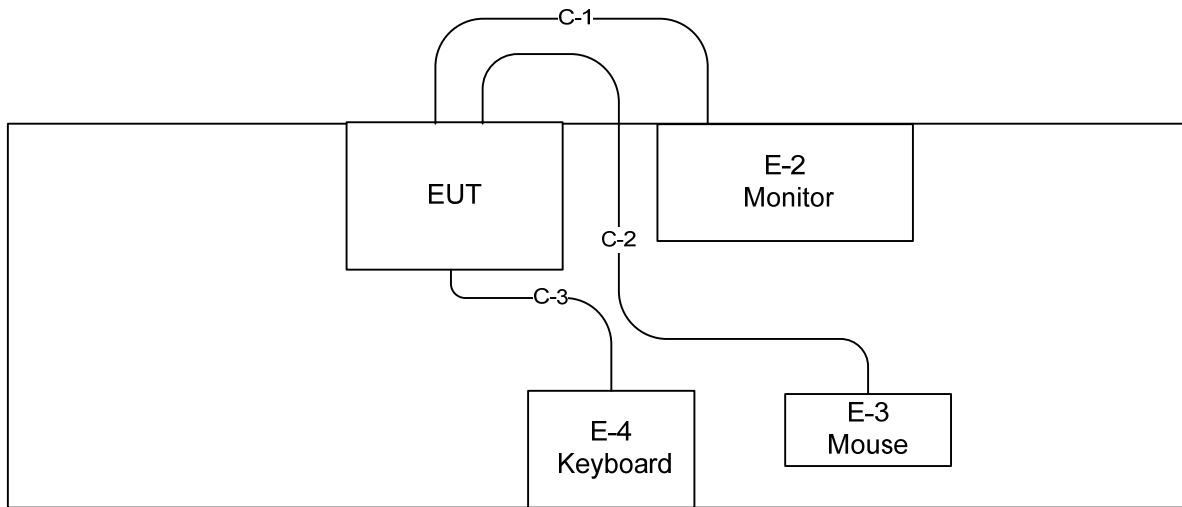





**3.5 DESCRIPTION OF SUPPORT UNITS**

The EUT has been tested as an independent unit together with other necessary accessories or support units. The following support units or accessories were used to form a representative test configuration during the tests.

Item	Equipment	Mfr/Brand	Model/Type No.	FCC ID	Series No.	Note
E-1	MONDOCENTER	InFocus	INF-MCENTER	QKMQDSP2060INF	N/A	EUT
E-2	24" LCD Monitor	DELL	2408WFPb	DOC	071863-11	
E-3	USB Mouse	Logitech	M-BT83	DOC	810000361	
E-4	USB K/B	Logitech	Y-UR83	DOC	868017-0121	

Item	Shielded Type	Ferrite Core	Length	Note
C-1	YES	YES	1.5M	VGA
C-2	NO	NO	1.7M	USB
C-3	NO	NO	1.5M	USB

NOTE: The support equipment was authorized by Declaration of Conformity (DOC).



**4 CONDUCTED EMISSION**

**4.1 LIMIT**

FREQUENCY (MHz)	Class A (dBuV)		Class B (dBuV)	
	Quasi-peak	Average	Quasi-peak	Average
0.15 - 0.5	79.00	66.00	66 - 56 *	56 - 46 *
0.50 - 5.0	73.00	60.00	56.00	46.00
5.0 - 30.0	73.00	60.00	60.00	50.00

**NOTE:**

1. The tighter limit applies at the band edges.
2. The limit of " \* " marked band means the limitation decreases linearly with the logarithm of the frequency in the range.
3. The test result calculated as following:  
 Measurement Value = Reading Level + Correct Factor  
 Correct Factor = Insertion Loss + Cable Loss + Attenuator Factor(if use)  
 Margin Level = Measurement Value – Limit Value

**4.2 MEASUREMENT INSTRUMENTS LIST**

Item	Kind of Equipment	Manufacturer	Type No.	Serial No.	Calibrated until
1	TWO-LINE V-NETWORK	R&S	ENV216	101050	Apr. 24, 2013
2	LISN	EMCO	3816/2	00066528	Mar. 26, 2013
3	Test Cable	TIMES	CFD300-NL	130	Jun. 14, 2013
4	EMI Test Receiver	Agilent	N9038A	MY51210215	Jan. 26, 2013

NOTE: **N/A:** denotes No Model Name, No Serial No. or No Calibration specified.

**4.3 TEST PROCEDURES**

- a. The EUT was placed 0.8 meters from the horizontal ground plane with EUT being connected to the power mains through a line impedance stabilization network (LISN). All other support equipments powered from additional LISN(s). The LISN provide 50 Ohm/ 50uH of coupling impedance for the measuring instrument.
- b. Interconnecting cables that hang closer than 40 cm to the ground plane shall be folded back and forth in the center forming a bundle 30 to 40 cm long.
- c. I/O cables that are not connected to a peripheral shall be bundled in the center. The end of the cable may be terminated, if required, using the correct terminating impedance. The overall length shall not exceed 1 m.
- d. LISN at least 80 cm from nearest part of EUT chassis.
- e. For the actual test configuration, please refer to the related Item –EUT Test Photos.

**NOTE:**

- a. Reading in which marked as Peak, QP or AVG means measurements by using are Quasi-Peak or Average Mode with Detector BW=9 kHz (6 dB Bandwidth).
- b. All readings are Peak Mode value unless otherwise stated QP or AVG in column of Note. If the Peak or QP Mode Measured value compliance with the QP Limits and lower than AVG Limits, the EUT shall be deemed to meet both QP & AVG Limits and then only Peak or QP Mode was measured, but AVG Mode didn't perform.

**4.4 TEST SETUP LAYOUT**

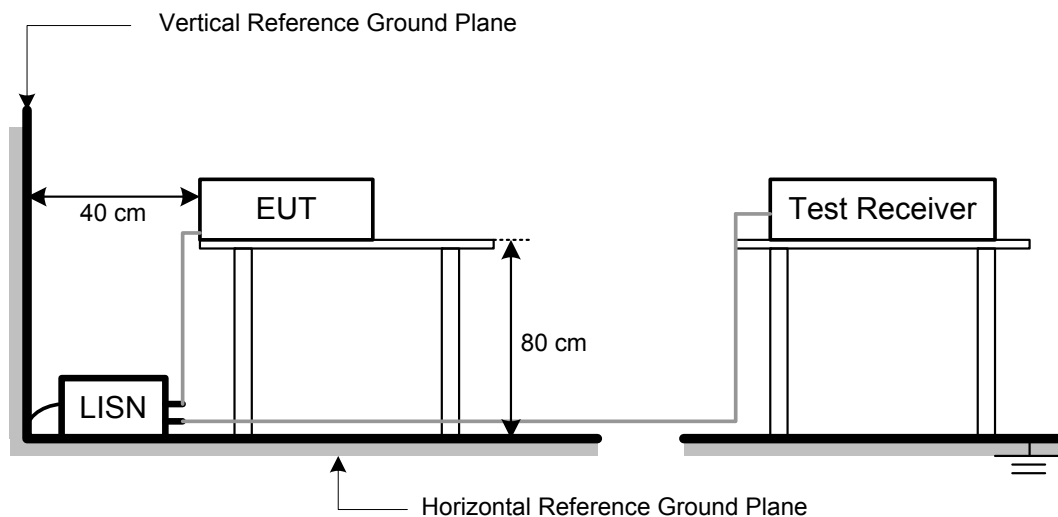

**4.5 DEVIATION FROM TEST STANDARD**

No deviation



#### **4.6 EUT OPERATING CONDITIONS**

The EUT was configured for testing in a typical fashion (as a customer would normally use it). The EUT has been programmed to continuously transmit during test. This operating condition was tested and used to collect the included data.



**4.7 TEST RESULTS**

E.U.T	MONDOCENTER	Model Name	INF-MCENTER
Temperature	24°C	Relative Humidity	48%
Test Voltage	AC 120V/60Hz		
Test Mode	TX 5200 MHz		

**Phase: Line**



No.	Mk.	Freq. MHz	Reading Level dBuV	Correct Factor dB	Measure- ment dBuV	Limit dBuV	Over dB	Detector	Comment
1		0.1631	35.06	9.59	44.65	65.30	-20.65	peak	
2		0.4396	23.07	9.61	32.68	57.07	-24.39	peak	
3		3.7963	29.90	9.67	39.57	56.00	-16.43	peak	
4	*	4.7862	30.20	9.69	39.89	56.00	-16.11	peak	
5		14.1875	29.11	9.86	38.97	60.00	-21.03	peak	
6		23.1250	30.02	9.91	39.93	60.00	-20.07	peak	



E.U.T	MONDOCENTER	Model Name	INF-MCENTER
Temperature	24°C	Relative Humidity	48%
Test Voltage	AC 120V/60Hz		
Test Mode	TX 5200 MHz		

**Phase: Neutral**



No.	Mk.	Freq. MHz	Reading Level dBuV	Correct Factor dB	Measure- ment dBuV	Limit dBuV	Over dB	Detector	Comment
1		0.4396	23.47	9.60	33.07	57.07	-24.00	peak	
2		2.1538	24.50	9.63	34.13	56.00	-21.87	peak	
3		2.7725	27.45	9.64	37.09	56.00	-18.91	peak	
4		3.2225	30.61	9.65	40.26	56.00	-15.74	peak	
5	*	4.7750	30.88	9.68	40.56	56.00	-15.44	peak	
6		27.1875	32.86	9.97	42.83	60.00	-17.17	peak	



## 5 ANTENNA CONDUCTED SPURIOUS EMISSION

### 5.1 LIMIT

Test Item	Frequency Range (MHz)	Limit
Antenna conducted Spurious Emission	30-40000	20 dB less than the peak value of fundamental frequency

### 5.2 MEASUREMENT INSTRUMENTS LIST

Item	Kind of Equipment	Manufacturer	Type No.	Serial No.	Calibrated until
1	Spectrum Analyzer	R&S	FSP-40	100129	Oct. 06, 2012

NOTE: **N/A**: denotes No Model Name, No Serial No. or No Calibration specified.

### 5.3 TEST PROCEDURES

- a. The EUT was directly connected to the spectrum analyzer and antenna output port as show in the block diagram below,
- b. Spectrum Setting: RBW= 1000KHz, VBW=1000KHz, Sweep time = Auto.

### 5.4 TEST SETUP LAYOUT

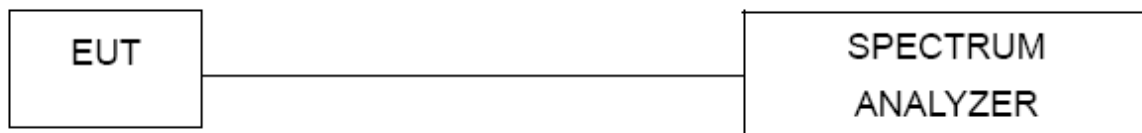

### 5.5 DEVIATION FROM TEST STANDARD

No deviation

### 5.6 EUT OPERATING CONDITIONS

The software provided by client to enable the EUT under transmission condition continuously at lowest and highest channel frequencies individually.



**5.7 TEST RESULTS - 5150-5350 MHZ BAND**

E.U.T	MONDOCENTER	Model Name	INF-MCENTER
Temperature	26°C	Relative Humidity	46%
Test Voltage	AC 120V/60Hz		
Test Mode	IEEE 802.11a		

Channel of Worst Data			
The max. radio frequency power in any 100kHz bandwidth outside the frequency band		The max. radio frequency power in any 100 kHz bandwidth within the frequency band.	
FREQUENCY(MHz)	POWER(dBm)	FREQUENCY(MHz)	POWER(dBm)
5148.40	-36.52	5350.20	-37.79
Result			
In any 100kHz bandwidth outside the frequency band, the radio frequency power is at least 20dB below that in the 100kHz bandwidth within the band that contains the highest level of the desired power.			





### IEEE 802.11a/The max. radio frequency power in any 100kHz bandwidth outside the frequency band

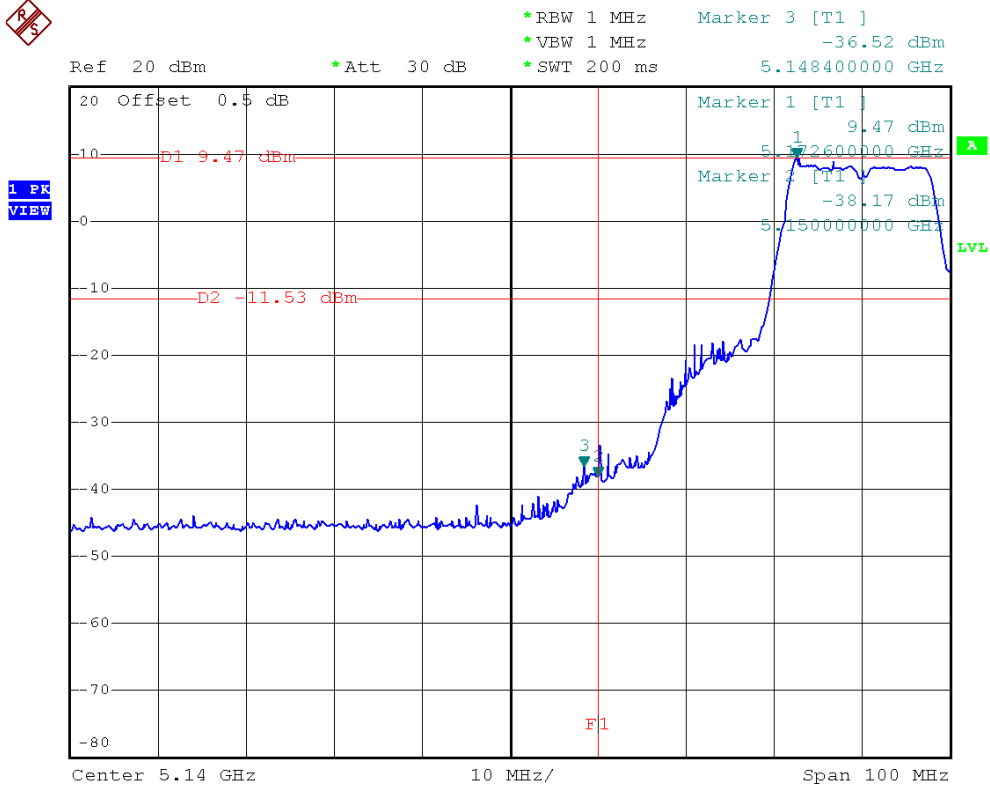

### IEEE 802.11a/The max. radio frequency power in any 100 kHz bandwidth within the frequency band

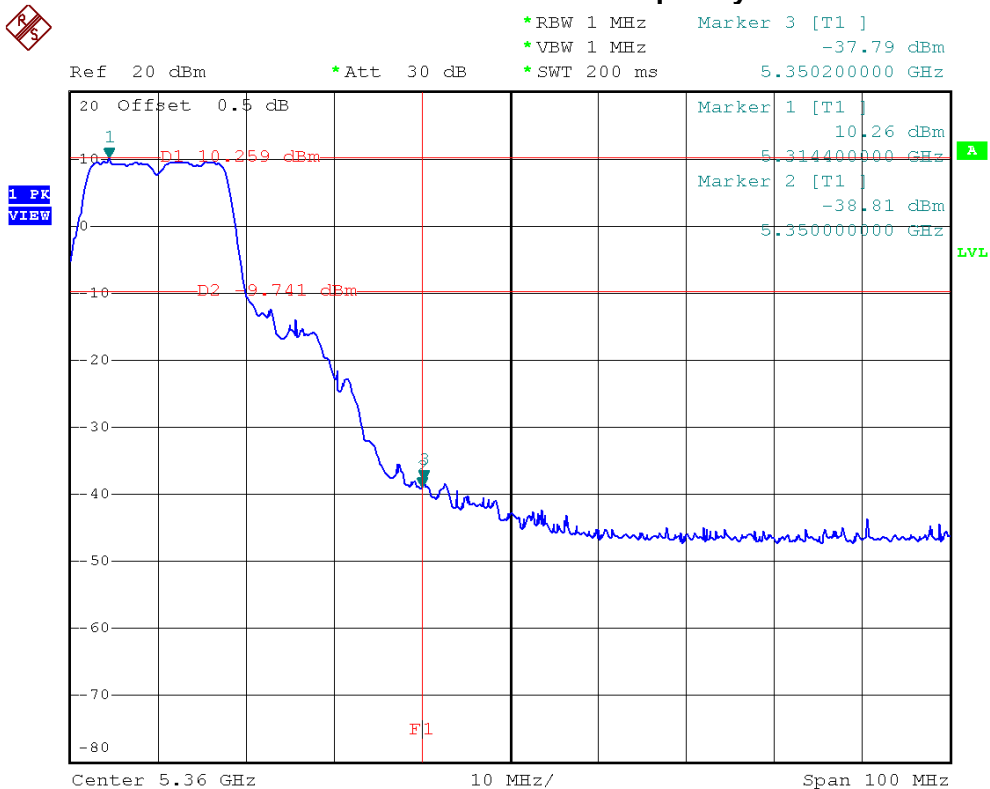



### IEEE 802.11a/5180 MHz/10 Harmonic of the frequency



\*RBW 1 MHz    Marker 2 [T1 ]  
\*VBW 1 MHz    -21.45 dBm  
SWT 800 ms    40.000000000 GHz

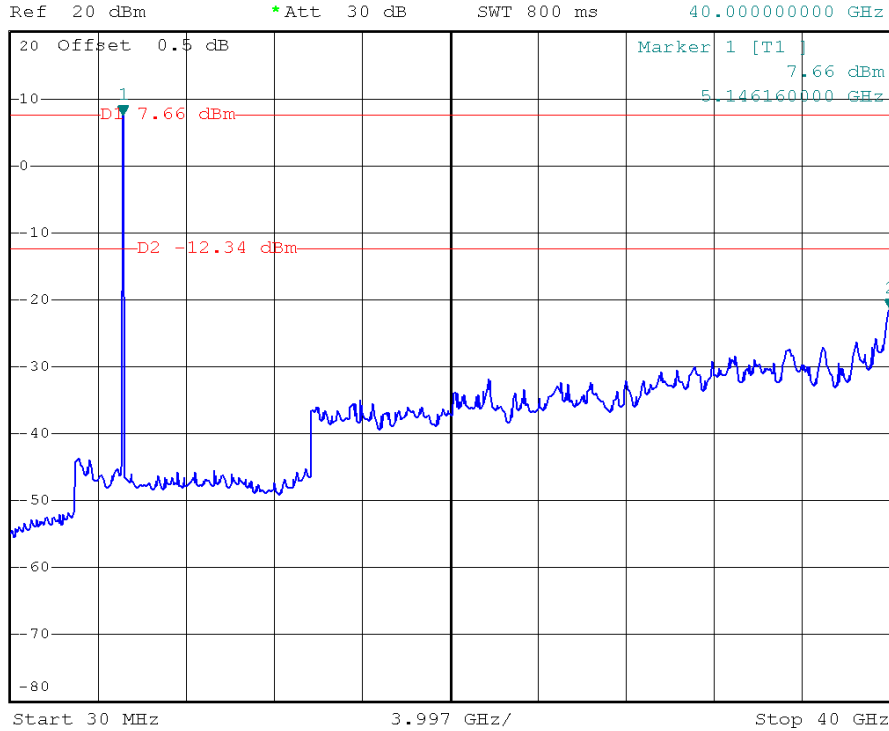

### IEEE 802.11a/5200 MHz/10 Harmonic of the frequency



\*RBW 1 MHz    Marker 1 [T1 ]  
\*VBW 1 MHz    7.77 dBm  
SWT 800 ms    5.146160000 GHz

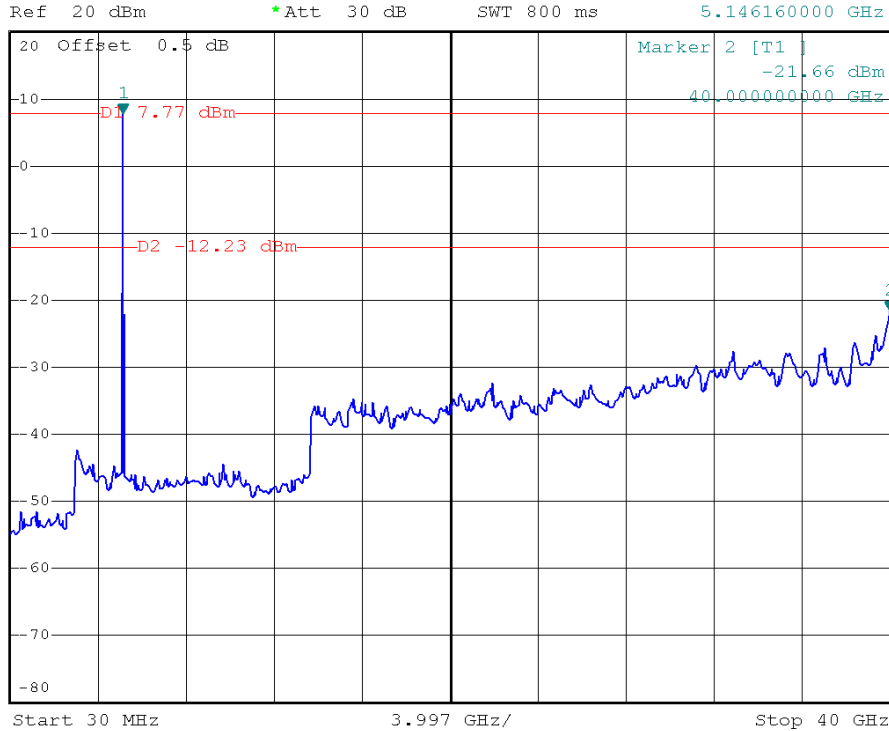



### IEEE 802.11a/5240 MHz/10 Harmonic of the frequency



\*RBW 1 MHz    Marker 1 [T1 ]  
\*VBW 1 MHz    7.43 dBm  
SWT 800 ms    5.226100000 GHz

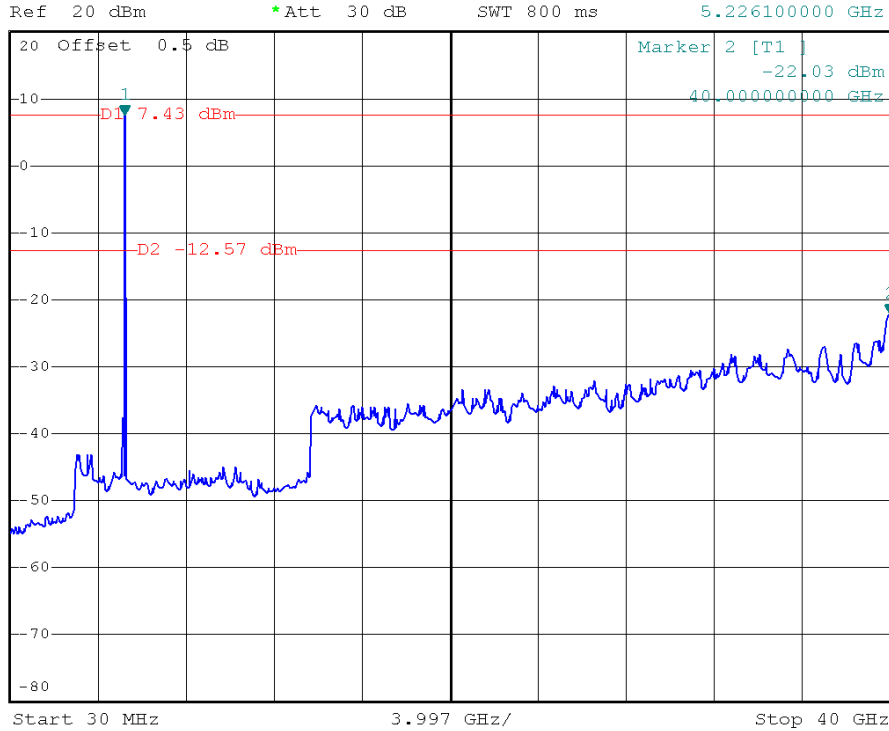

### IEEE 802.11a/5260 MHz/10 Harmonic of the frequency



\*RBW 1 MHz    Marker 2 [T1 ]  
\*VBW 1 MHz    -22.19 dBm  
SWT 800 ms    40.000000000 GHz

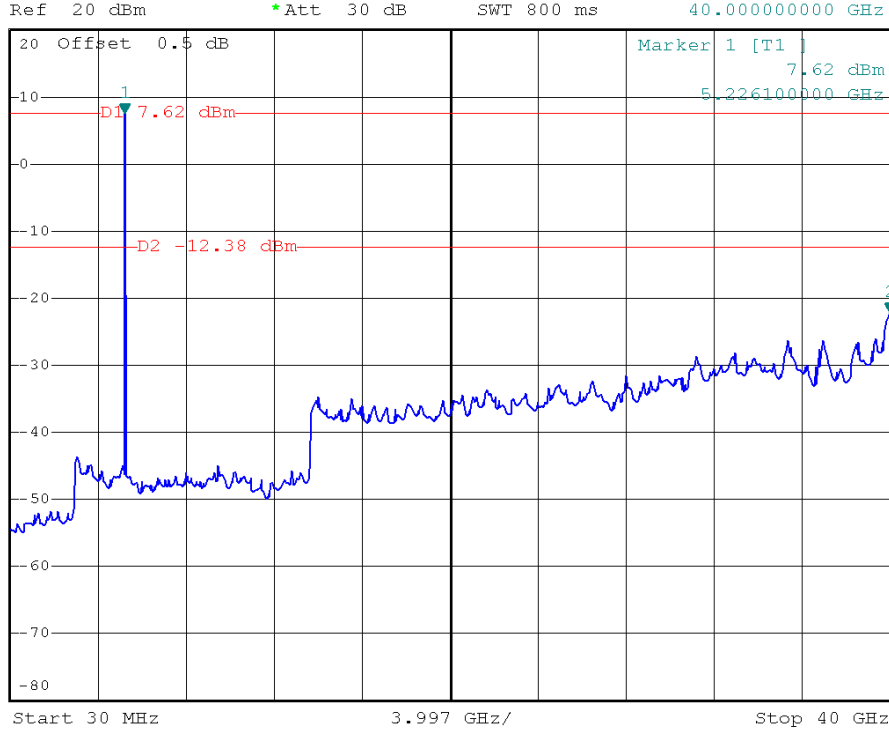



### IEEE 802.11a/5300 MHz/10 Harmonic of the frequency



\*RBW 1 MHz    Marker 2 [T1 ]  
\*VBW 1 MHz    -22.31 dBm  
SWT 800 ms    40.000000000 GHz

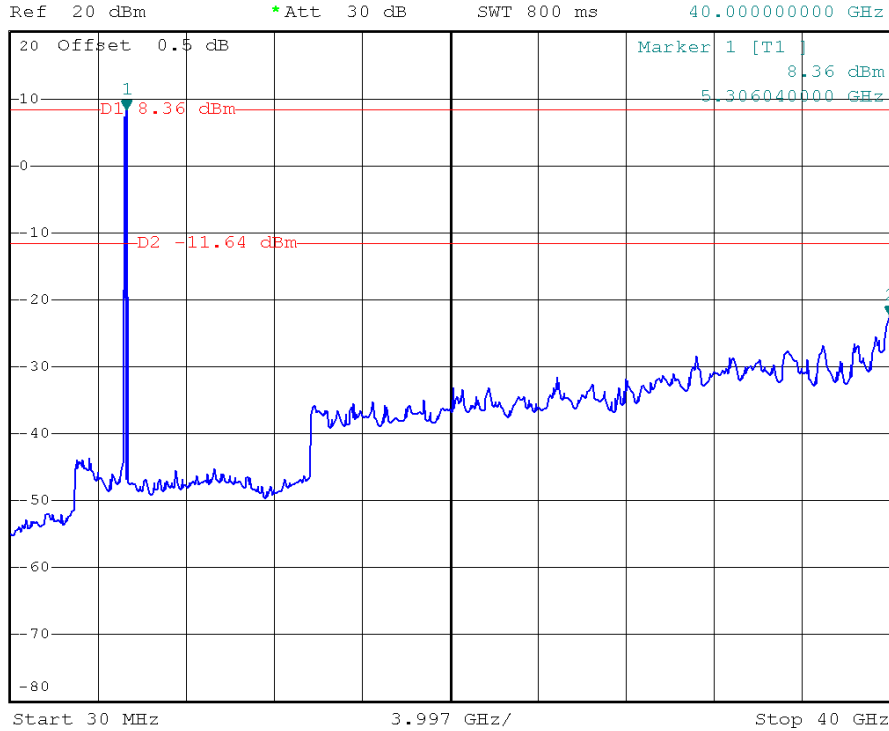

### IEEE 802.11a/5320 MHz/10 Harmonic of the frequency



\*RBW 1 MHz    Marker 2 [T1 ]  
\*VBW 1 MHz    -21.30 dBm  
SWT 800 ms    40.000000000 GHz

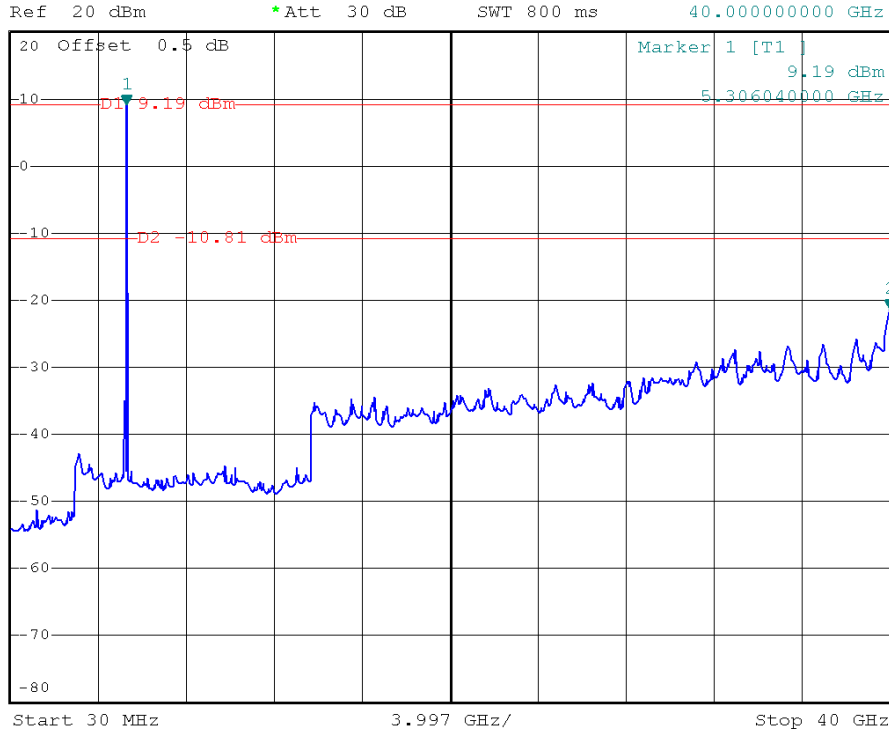



E.U.T	MONDOCENTER	Model Name	INF-MCENTER
Temperature	26°C	Relative Humidity	46%
Test Voltage	AC 120V/60Hz		
Test Mode	IEEE 802.11n (20 MHz)/ANT.1		

Channel of Worst Data			
The max. radio frequency power in any 100kHz bandwidth outside the frequency band		The max. radio frequency power in any 100 kHz bandwidth within the frequency band.	
FREQUENCY(MHz)	POWER(dBm)	FREQUENCY(MHz)	POWER(dBm)
5149.80	-43.07	5350.80	-42.56
Result			
In any 100kHz bandwidth outside the frequency band, the radio frequency power is at least 20dB below that in the 100kHz bandwidth within the band that contains the highest level of the desired power.			



IEEE 802.11n (20 MHz)/ANT.1/The max. radio frequency power in any 100kHz bandwidth outside the frequency band

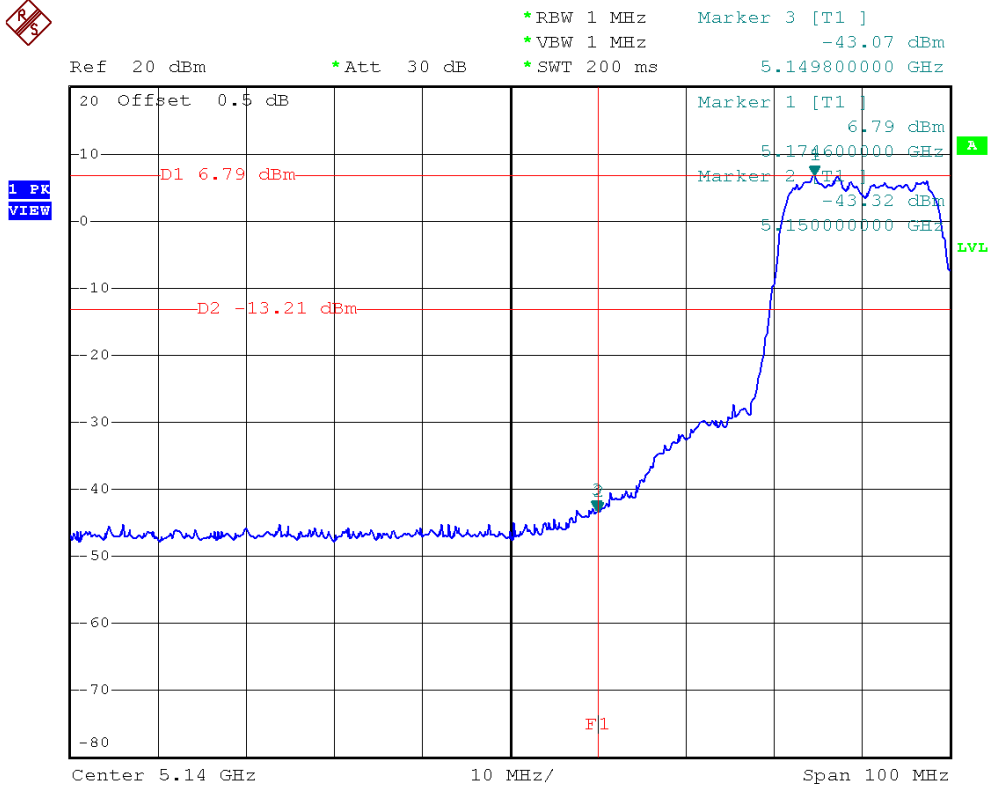

IEEE 802.11n (20 MHz)/ANT.1/The max. radio frequency power in any 100 kHz bandwidth within the frequency band

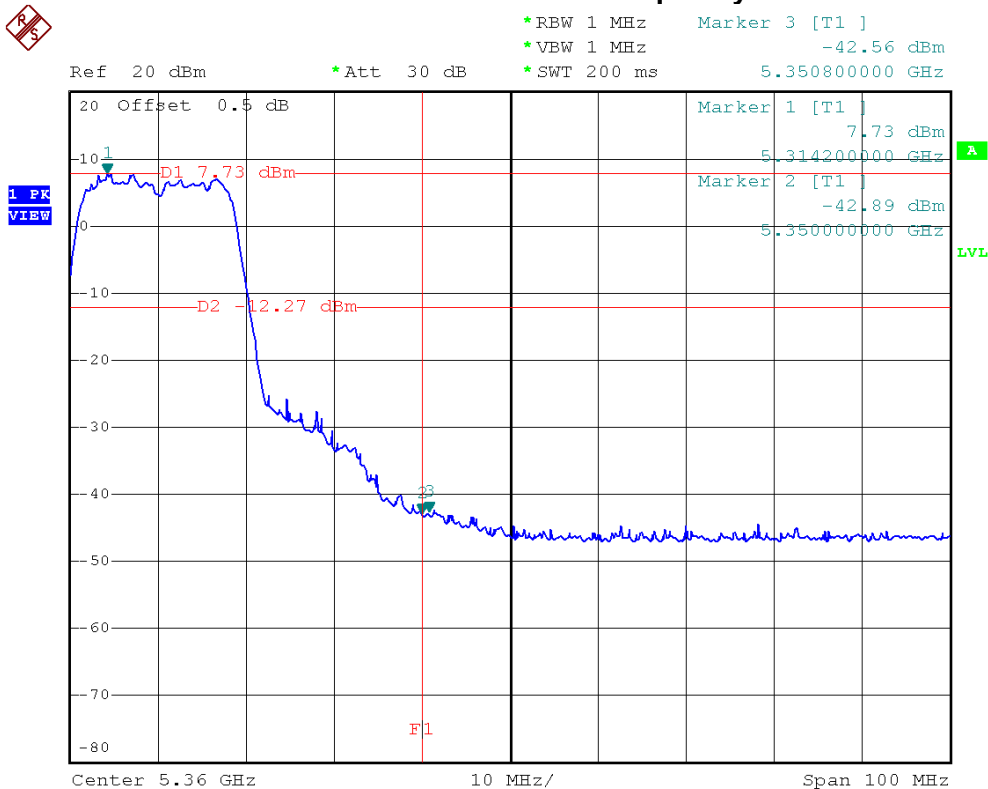



### IEEE 802.11n (20 MHz)/ANT.1/5180 MHz/10 Harmonic of the frequency

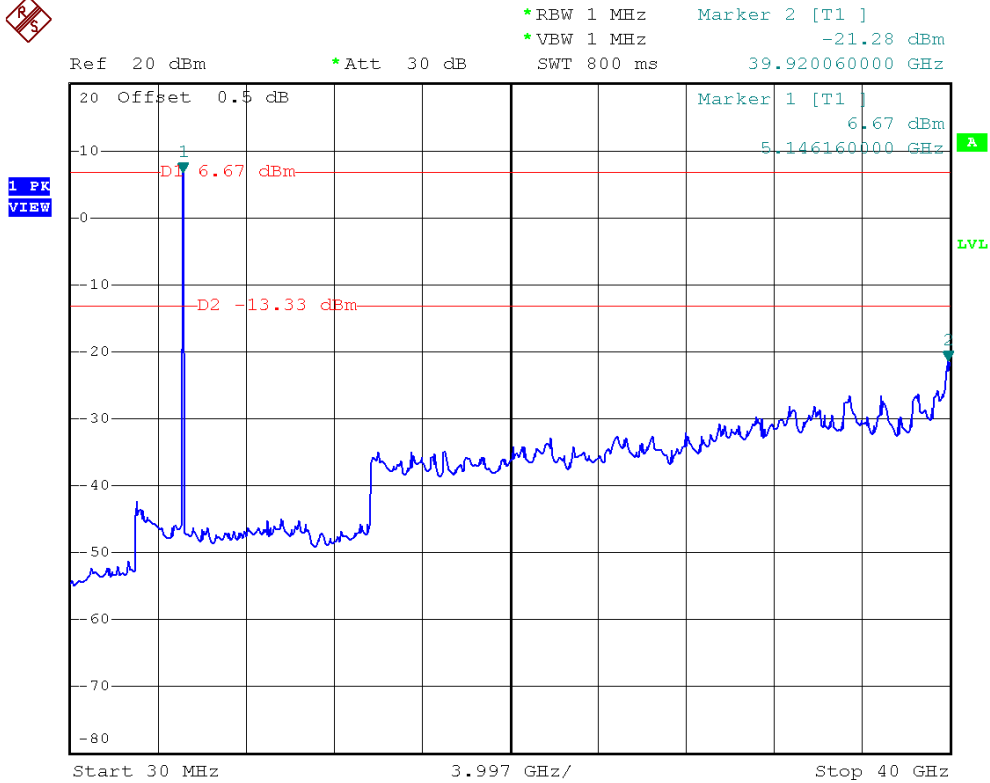

### IEEE 802.11n (20 MHz)/ANT.1/5200 MHz/10 Harmonic of the frequency

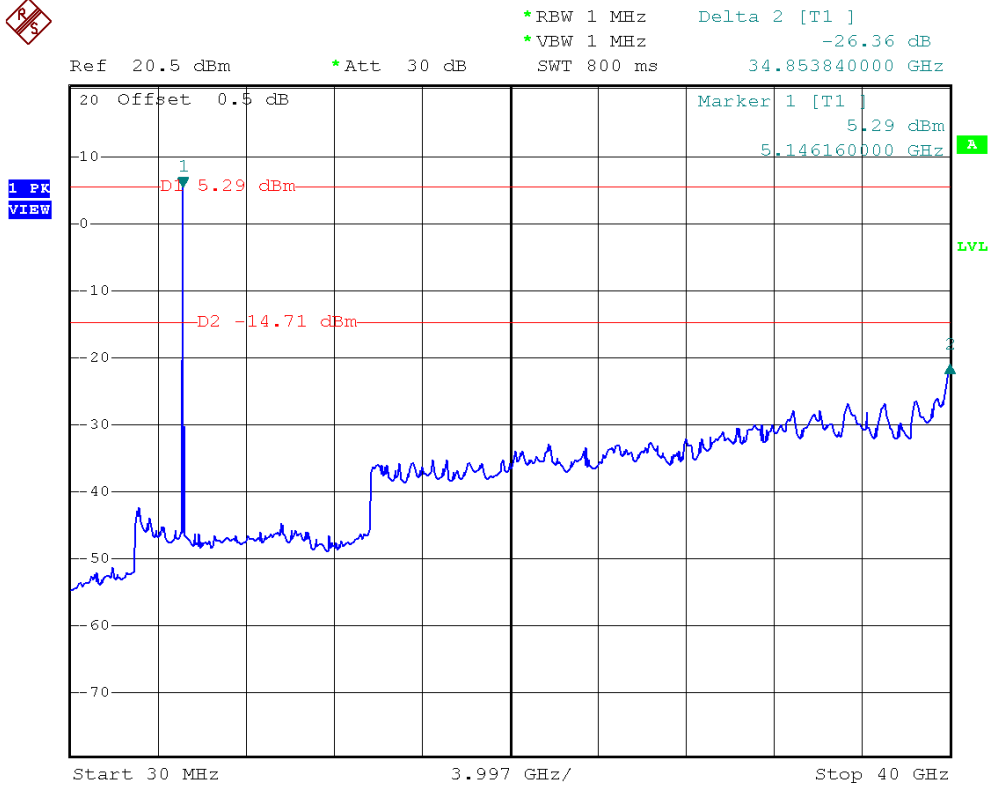



### IEEE 802.11n (20 MHz)/ANT.1/5240 MHz/10 Harmonic of the frequency



\*RBW 1 MHz    Marker 2 [T1 ]  
\*VBW 1 MHz    -21.42 dBm  
SWT 800 ms    40.000000000 GHz

Ref 20.5 dBm    \*Att 30 dB

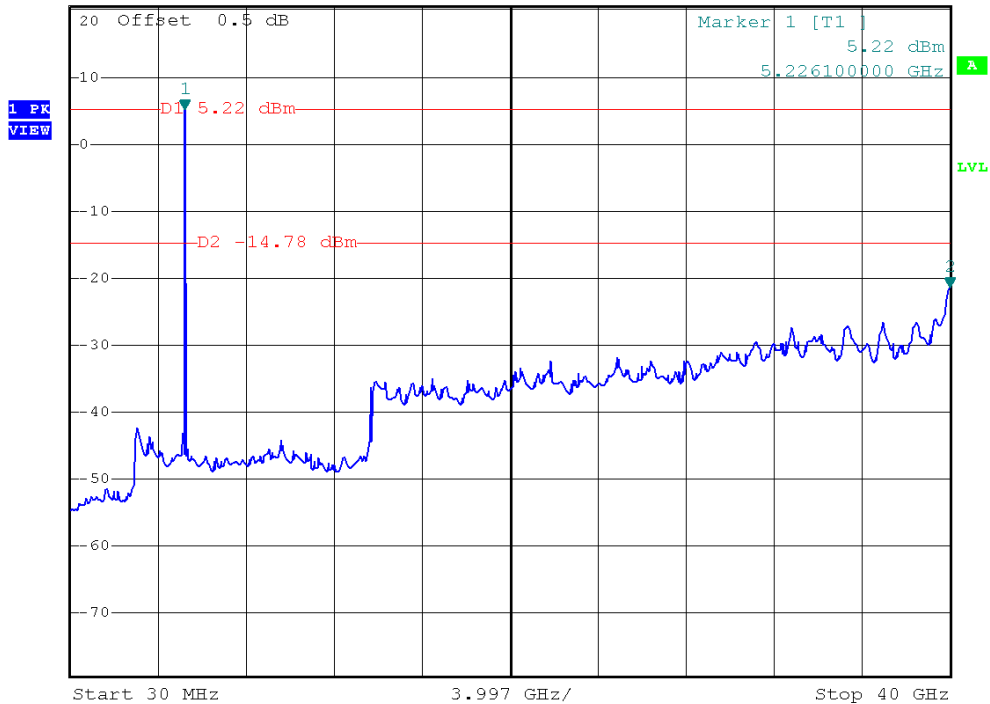

### IEEE 802.11n (20 MHz)/ANT.1/5260 MHz/10 Harmonic of the frequency



\*RBW 1 MHz    Marker 1 [T1 ]  
\*VBW 1 MHz    4.36 dBm  
SWT 800 ms    5.226100000 GHz

Ref 20.5 dBm    \*Att 30 dB

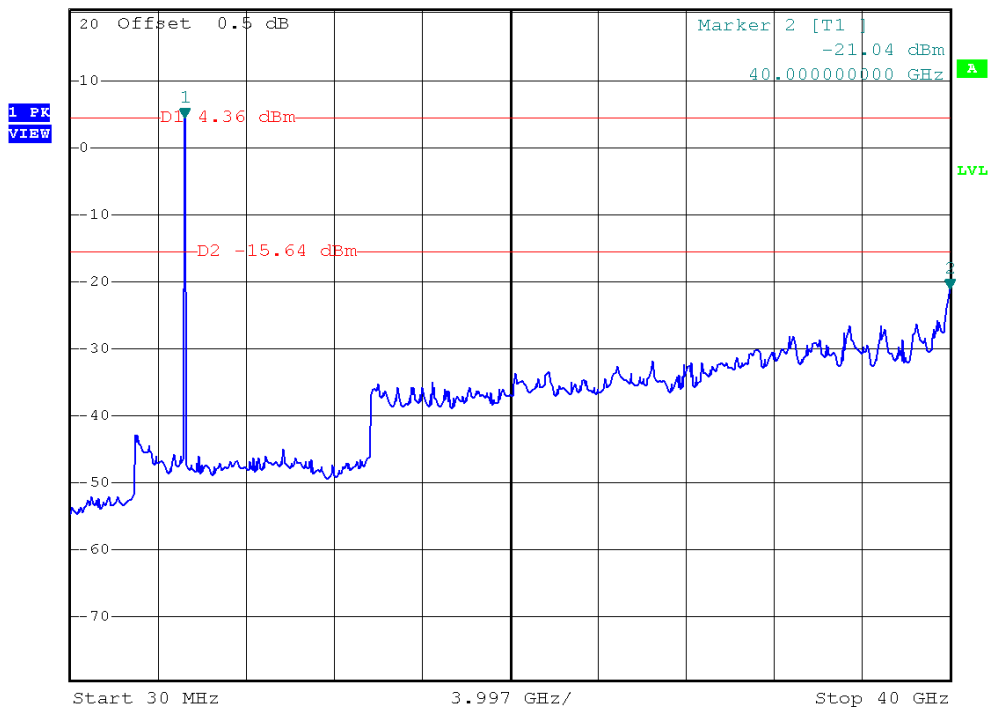





### IEEE 802.11n (20 MHz)/ANT.1/5300 MHz/10 Harmonic of the frequency

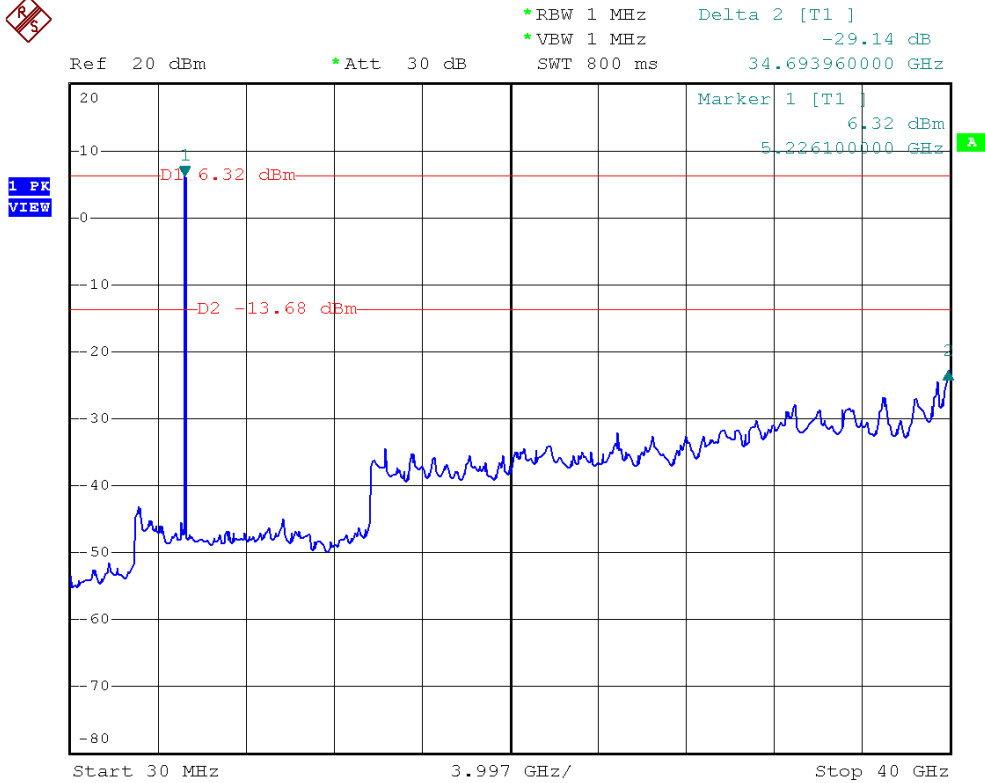

### IEEE 802.11n (20 MHz)/ANT.1/5320 MHz/10 Harmonic of the frequency

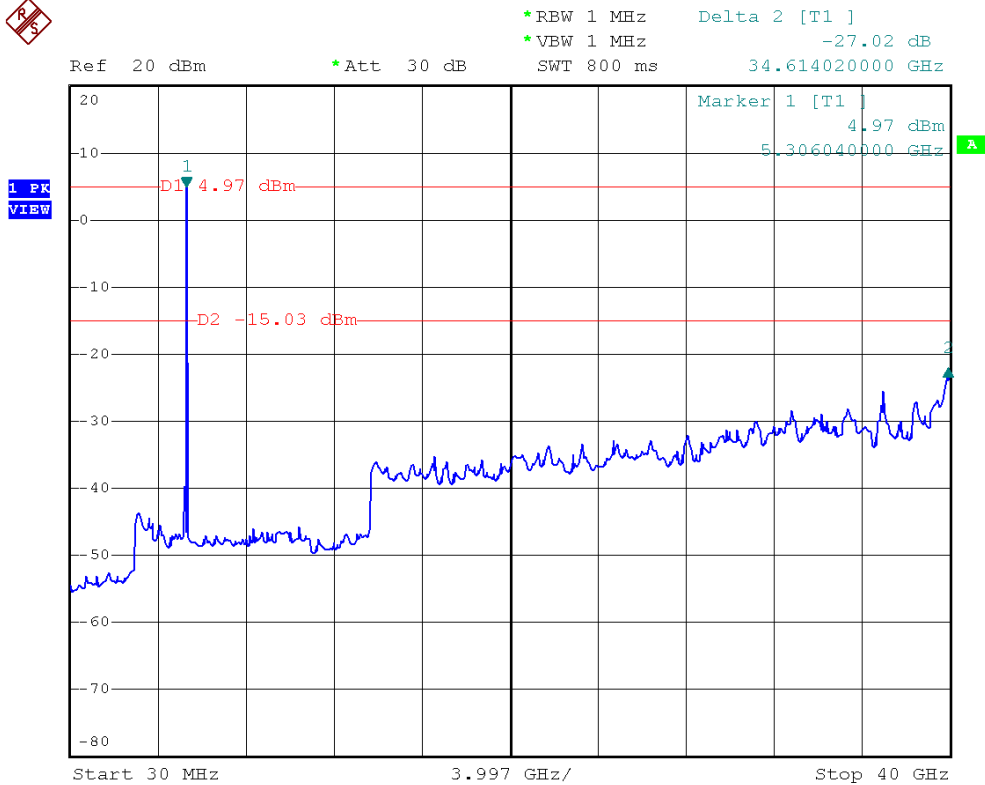



E.U.T	MONDOCENTER	Model Name	INF-MCENTER
Temperature	26°C	Relative Humidity	46%
Test Voltage	AC 120V/60Hz		
Test Mode	IEEE 802.11n (20 MHz)/ANT.2		

Channel of Worst Data			
The max. radio frequency power in any 100kHz bandwidth outside the frequency band		The max. radio frequency power in any 100 kHz bandwidth within the frequency band.	
FREQUENCY(MHz)	POWER(dBm)	FREQUENCY(MHz)	POWER(dBm)
5149.60	-41.78	5351.00	-40.43
Result			
In any 100kHz bandwidth outside the frequency band, the radio frequency power is at least 20dB below that in the 100kHz bandwidth within the band that contains the highest level of the desired power.			



IEEE 802.11n (20 MHz)/ANT.2/The max. radio frequency power in any 100kHz bandwidth outside the frequency band

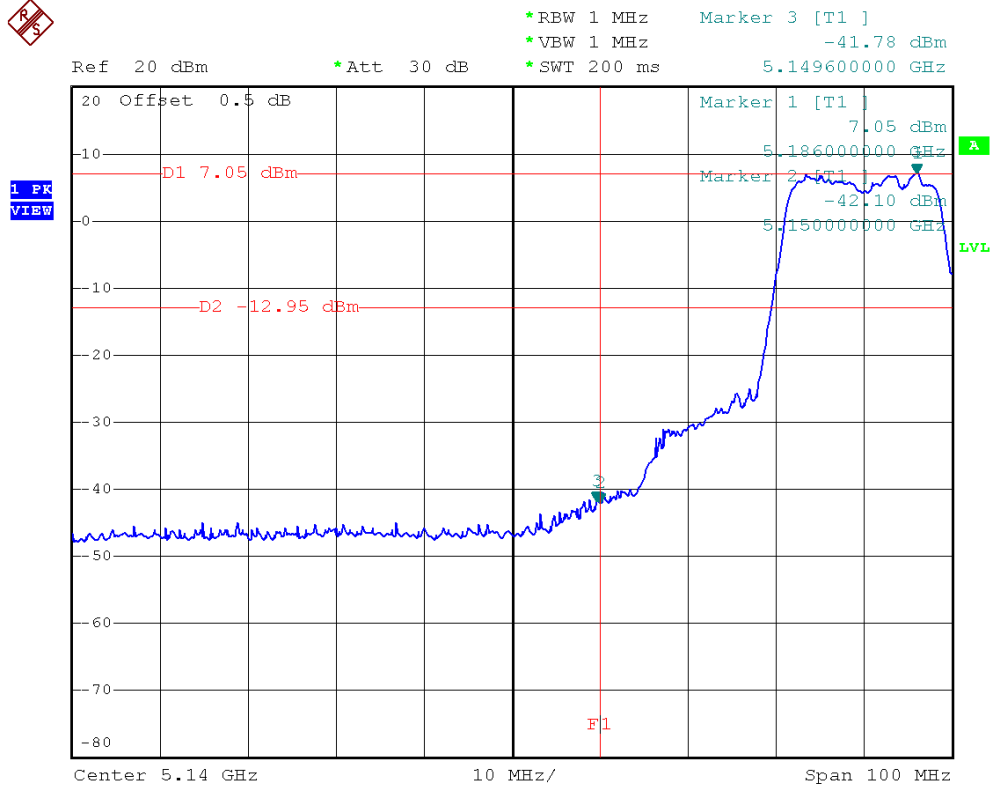

IEEE 802.11n (20 MHz)/ANT.2/The max. radio frequency power in any 100 kHz bandwidth within the frequency band

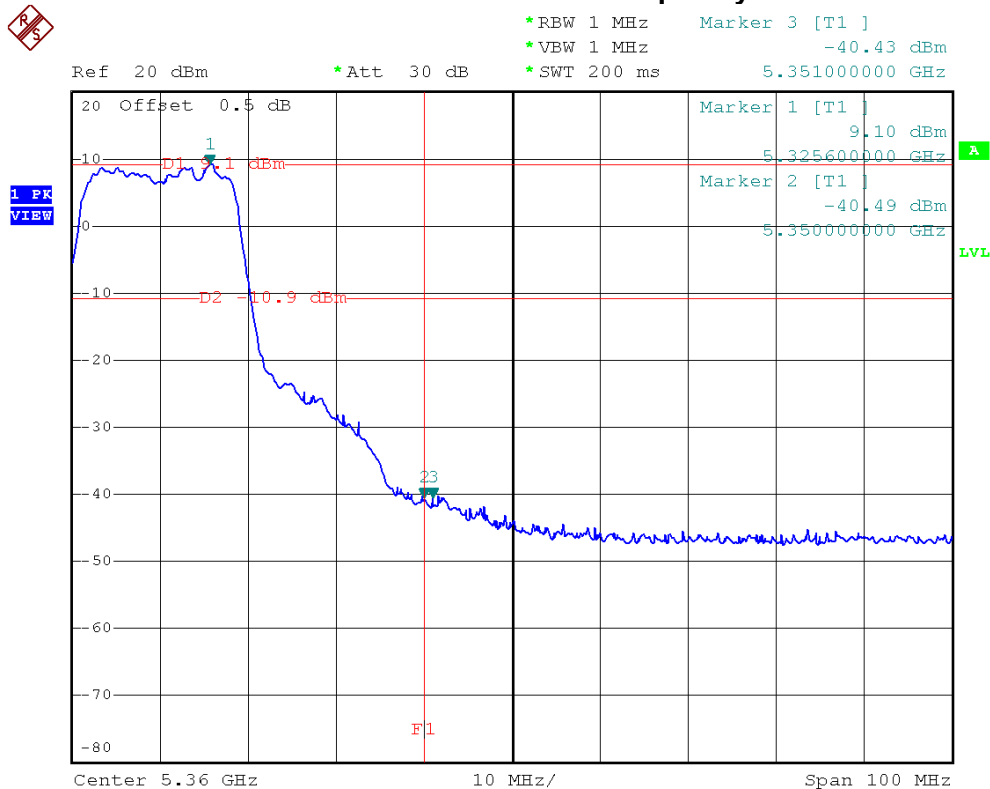



### IEEE 802.11n (20 MHz)/ANT.2/5180 MHz/10 Harmonic of the frequency

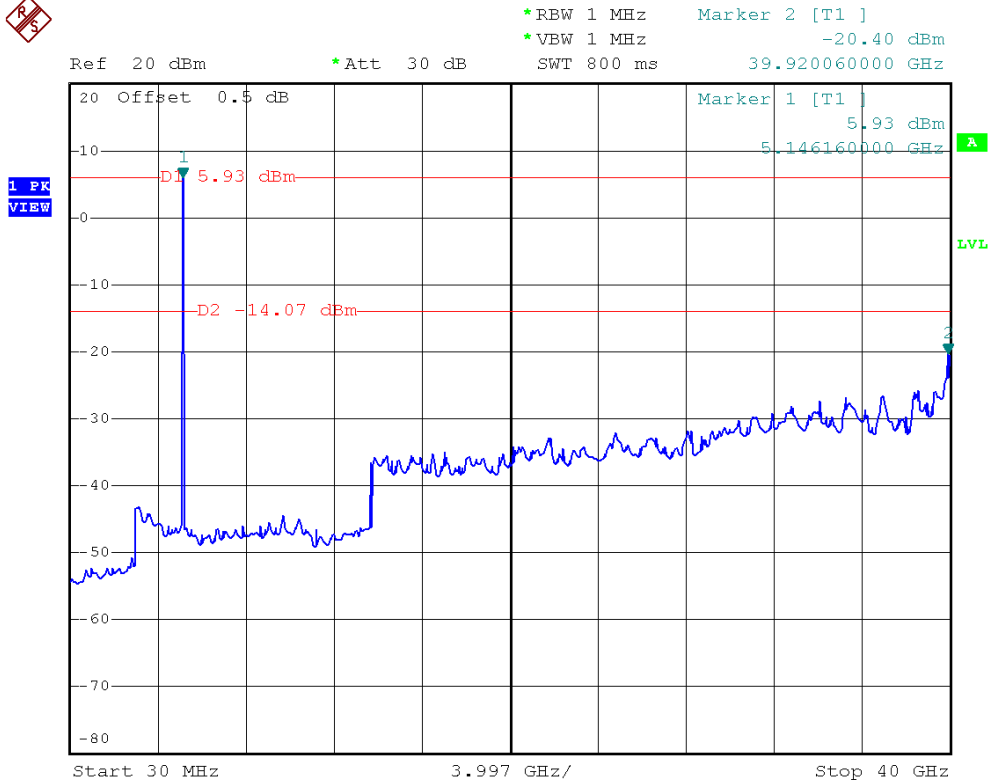

### IEEE 802.11n (20 MHz)/ANT.2/5200 MHz/10 Harmonic of the frequency

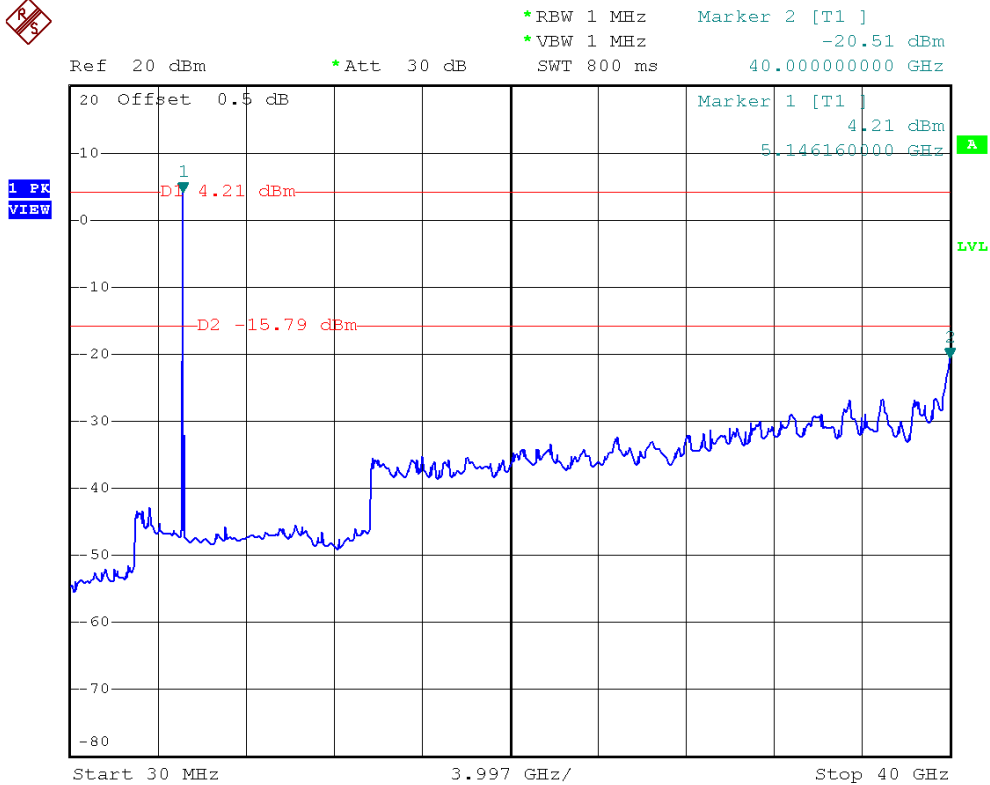



### IEEE 802.11n (20 MHz)/ANT.2/5240 MHz/10 Harmonic of the frequency

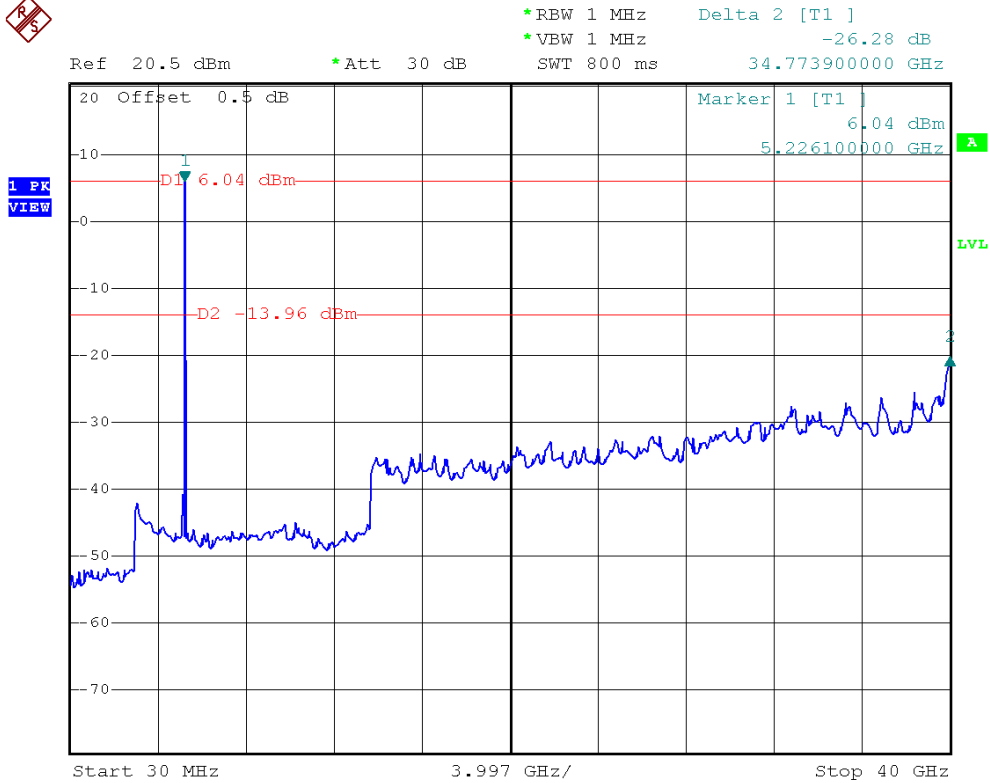

### IEEE 802.11n (20 MHz)/ANT.2/5260 MHz/10 Harmonic of the frequency

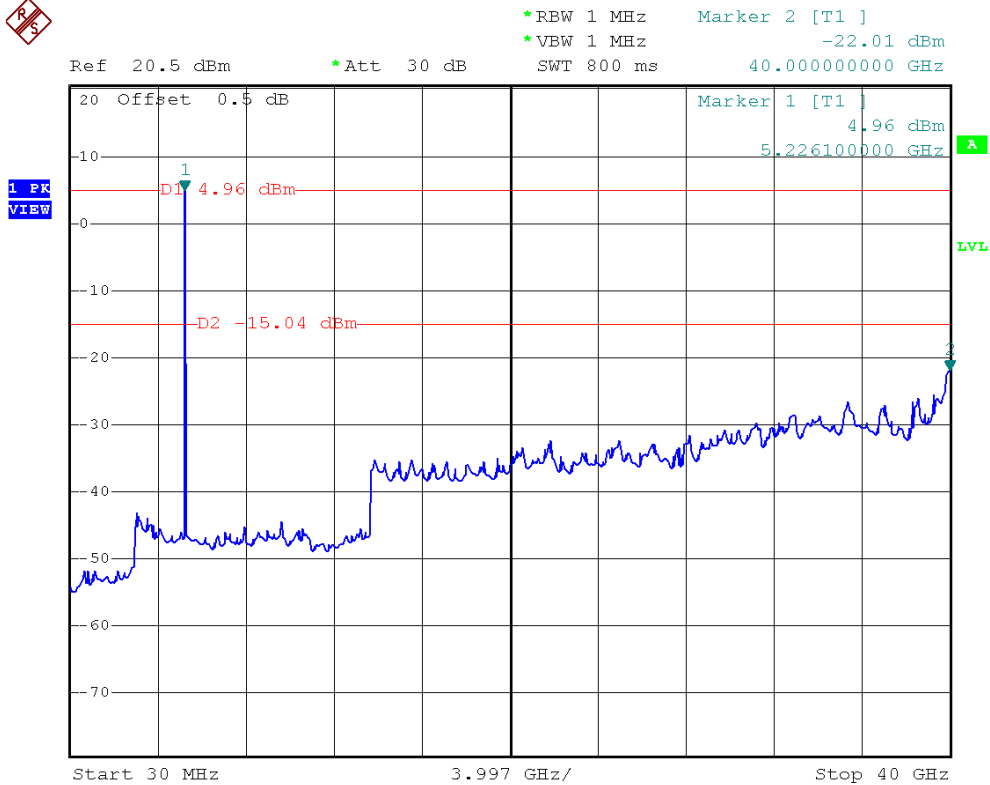



### IEEE 802.11n (20 MHz)/ANT.2/5300 MHz/10 Harmonic of the frequency

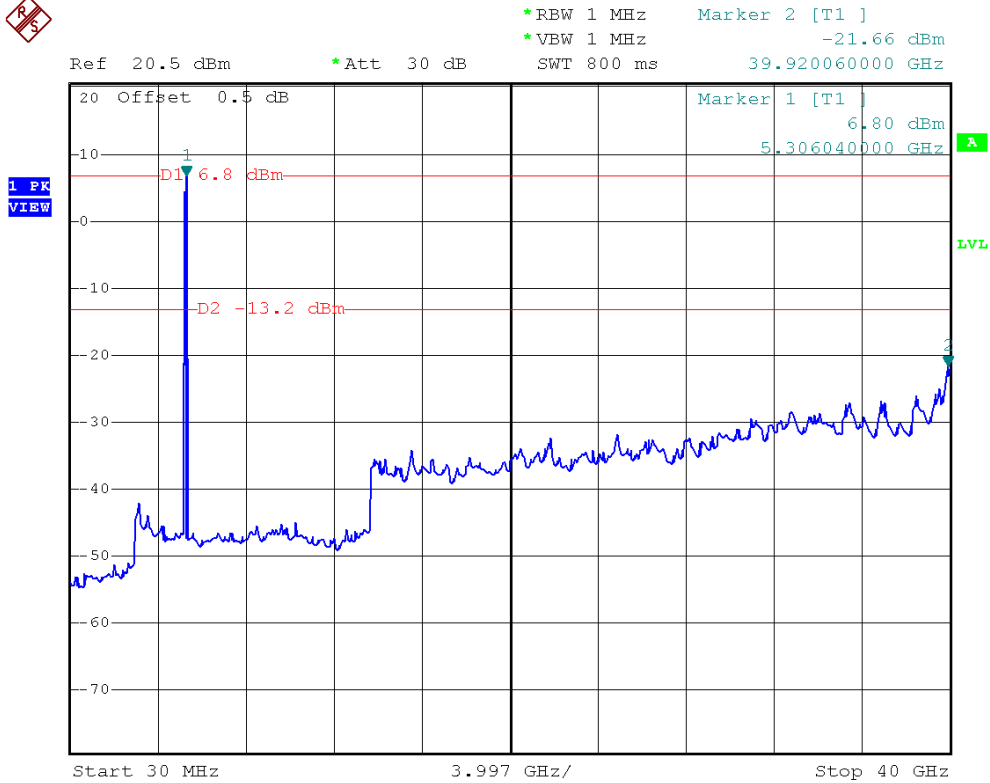

### IEEE 802.11n (20 MHz)/ANT.2/5320 MHz/10 Harmonic of the frequency

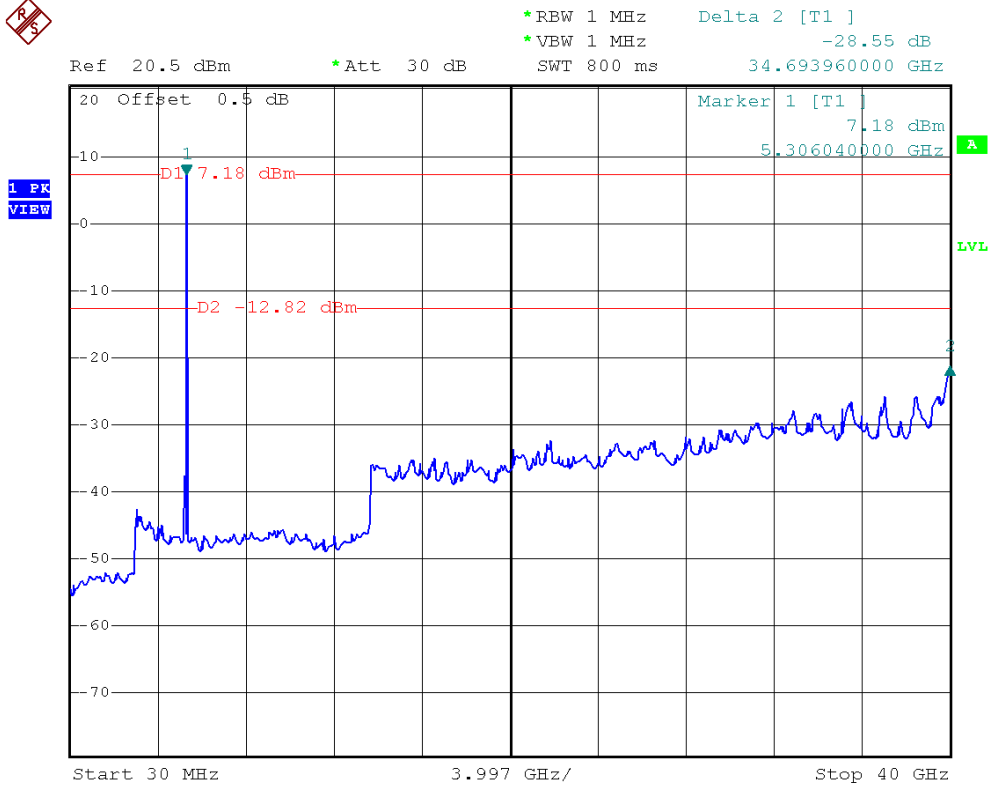



E.U.T	MONDOCENTER	Model Name	INF-MCENTER
Temperature	26°C	Relative Humidity	46%
Test Voltage	AC 120V/60Hz		
Test Mode	IEEE 802.11n (40 MHz)/ANT.1		

Channel of Worst Data			
The max. radio frequency power in any 100kHz bandwidth outside the frequency band		The max. radio frequency power in any 100 kHz bandwidth within the frequency band.	
FREQUENCY(MHz)	POWER(dBm)	FREQUENCY(MHz)	POWER(dBm)
5149.60	-38.19	5351.20	-40.42
Result			
In any 100kHz bandwidth outside the frequency band, the radio frequency power is at least 20dB below that in the 100kHz bandwidth within the band that contains the highest level of the desired power.			



IEEE 802.11n (40 MHz)/ANT.1/The max. radio frequency power in any 100kHz bandwidth outside the frequency band

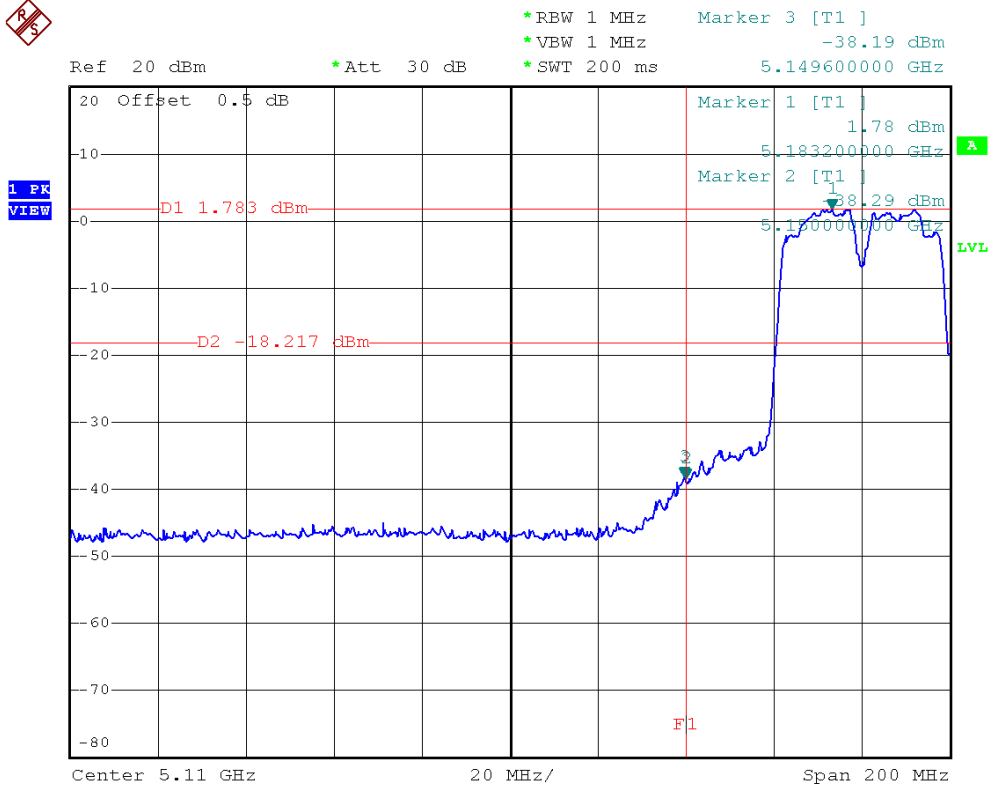

IEEE 802.11n (40 MHz)/ANT.1/The max. radio frequency power in any 100 kHz bandwidth within the frequency band

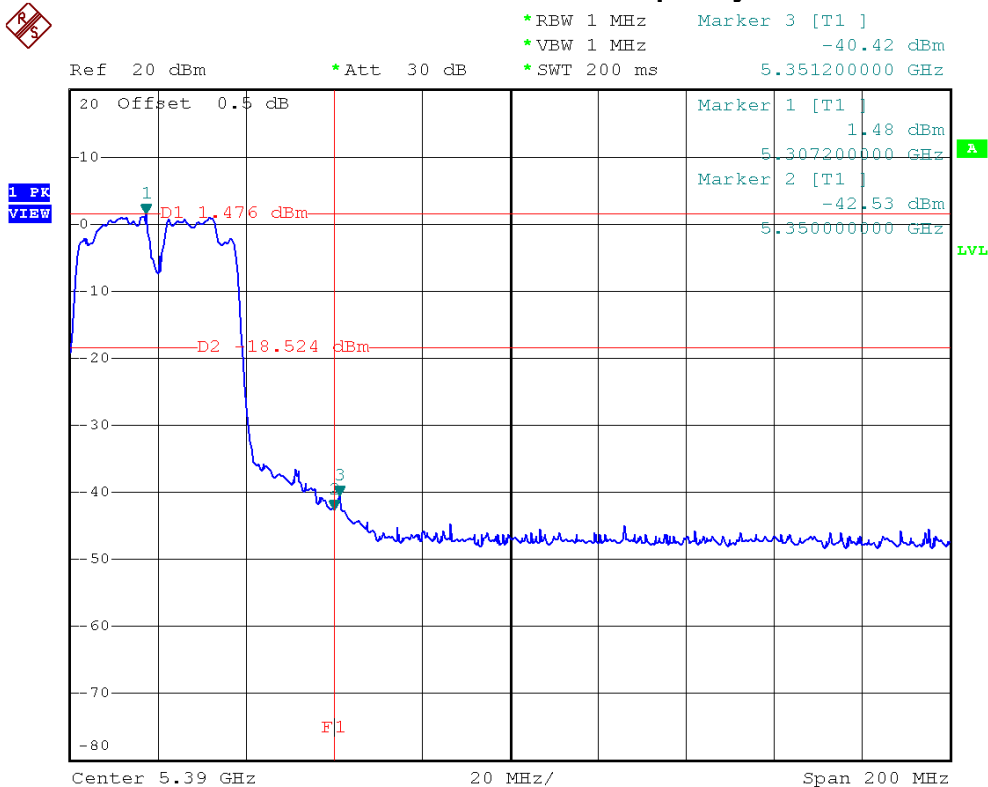





### IEEE 802.11n (40 MHz)/ANT.1/5190 MHz/10 Harmonic of the frequency

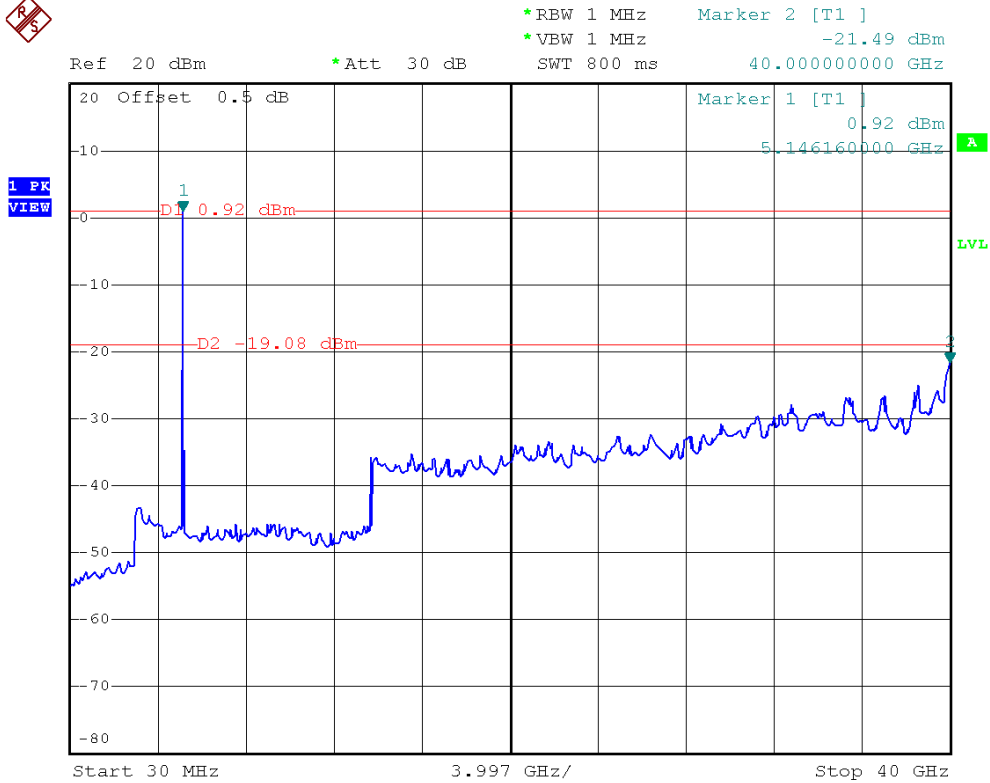

### IEEE 802.11n (40 MHz)/ANT.1/5230 MHz/10 Harmonic of the frequency

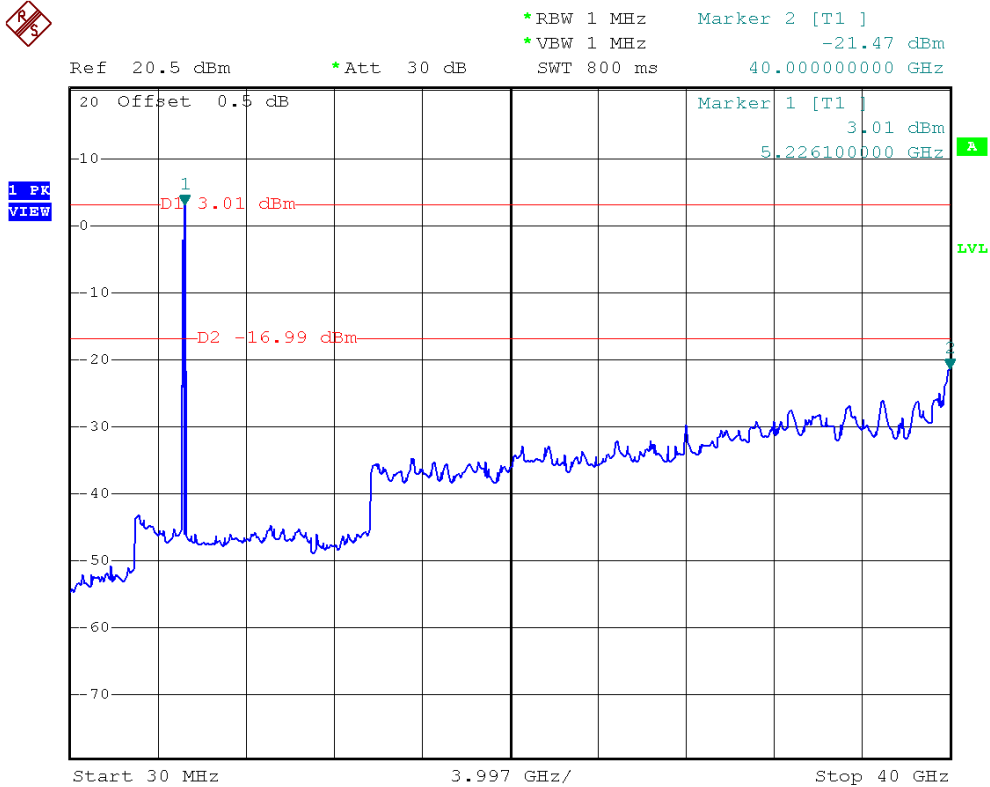



### IEEE 802.11n (40 MHz)/ANT.1/5270 MHz/10 Harmonic of the frequency

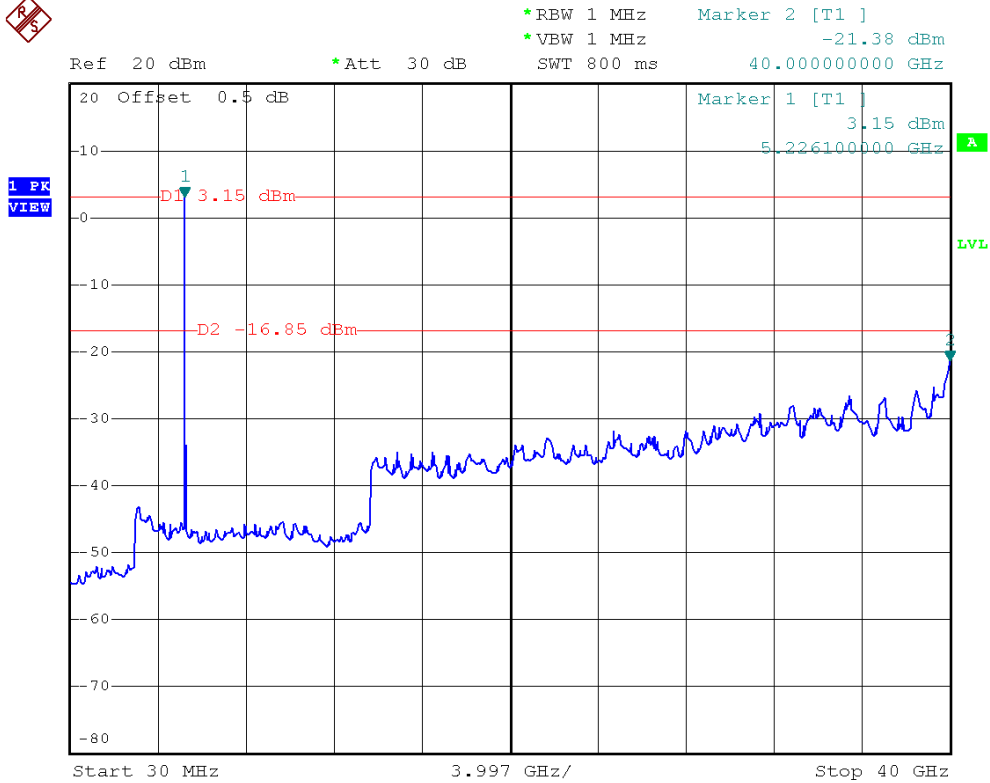

### IEEE 802.11n (40 MHz)/ANT.1/5310 MHz/10 Harmonic of the frequency

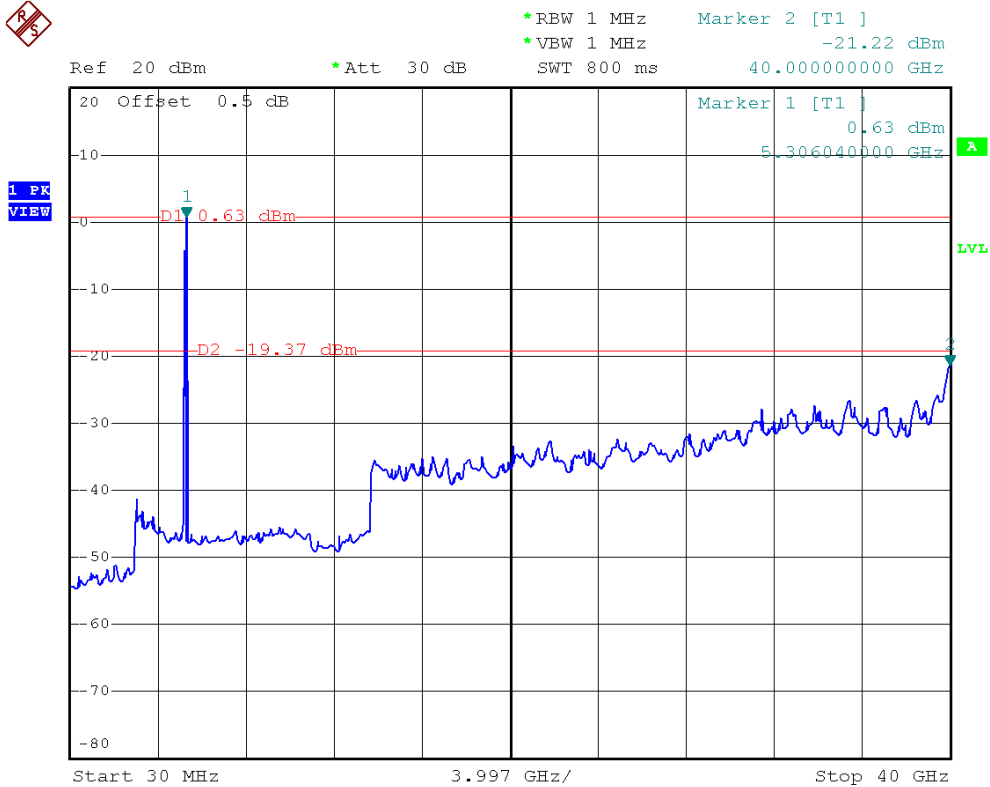



E.U.T	MONDOCENTER	Model Name	INF-MCENTER
Temperature	26°C	Relative Humidity	46%
Test Voltage	AC 120V/60Hz		
Test Mode	IEEE 802.11n (40 MHz)/ANT.2		

Channel of Worst Data			
The max. radio frequency power in any 100kHz bandwidth outside the frequency band		The max. radio frequency power in any 100 kHz bandwidth within the frequency band.	
FREQUENCY(MHz)	POWER(dBm)	FREQUENCY(MHz)	POWER(dBm)
5149.60	-37.89	5350.40	-43.19
Result			
In any 100kHz bandwidth outside the frequency band, the radio frequency power is at least 20dB below that in the 100kHz bandwidth within the band that contains the highest level of the desired power.			



IEEE 802.11n (40 MHz)/ANT.2/The max. radio frequency power in any 100kHz bandwidth outside the frequency band

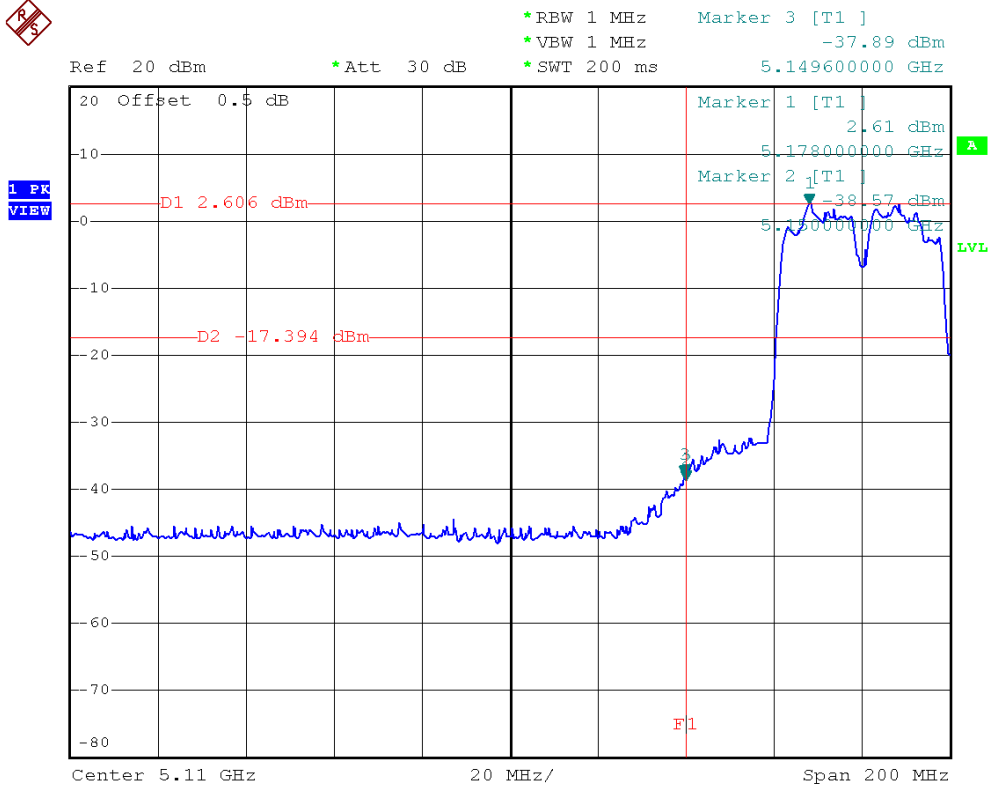

IEEE 802.11n (40 MHz)/ANT.2/The max. radio frequency power in any 100 kHz bandwidth within the frequency band

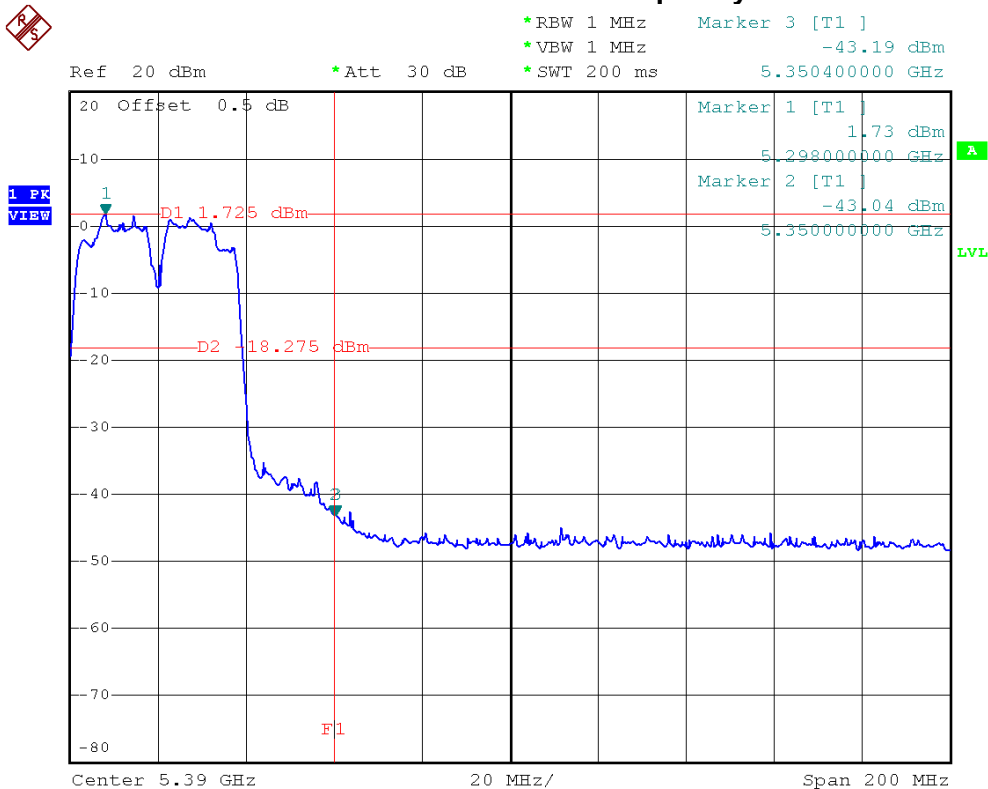



### IEEE 802.11n (40 MHz)/ANT.2/5190 MHz/10 Harmonic of the frequency

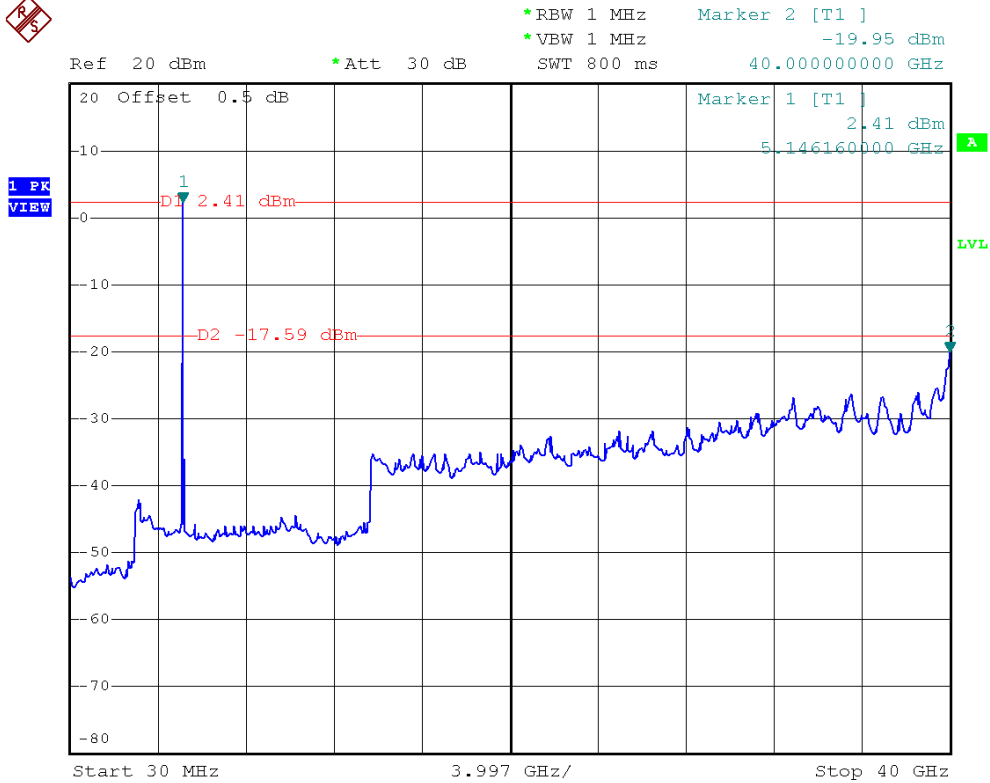

### IEEE 802.11n (40 MHz)/ANT.2/5230 MHz/10 Harmonic of the frequency

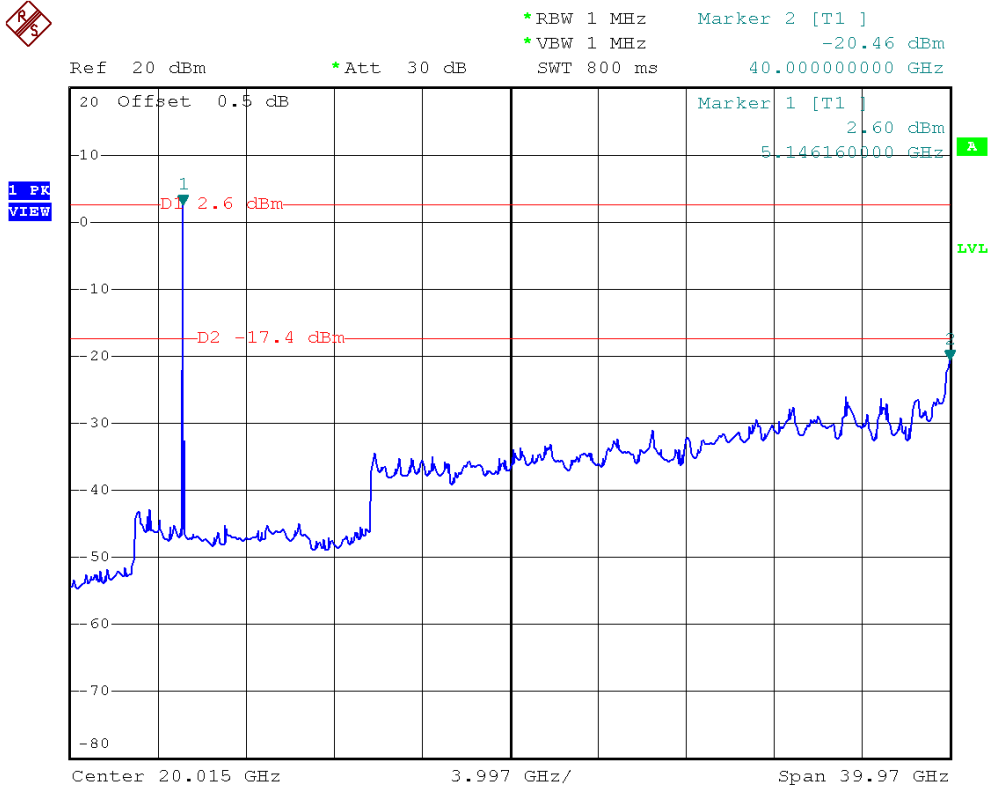



### IEEE 802.11n (40 MHz)/ANT.2/5270 MHz/10 Harmonic of the frequency

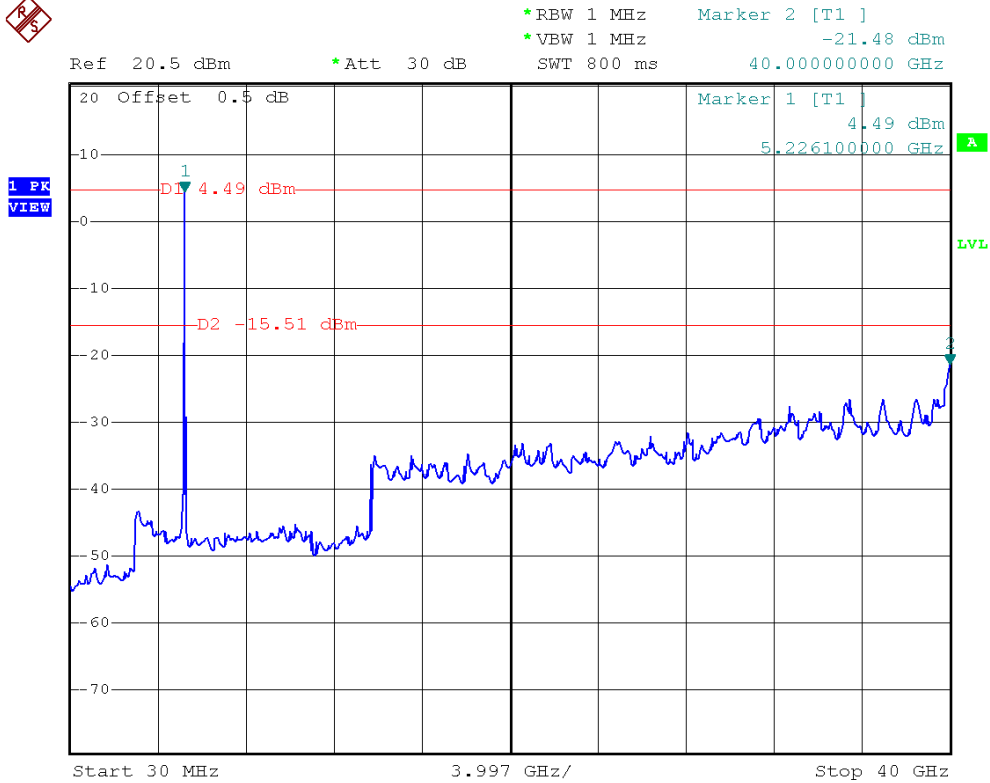

### IEEE 802.11n (40 MHz)/ANT.2/5310 MHz/10 Harmonic of the frequency

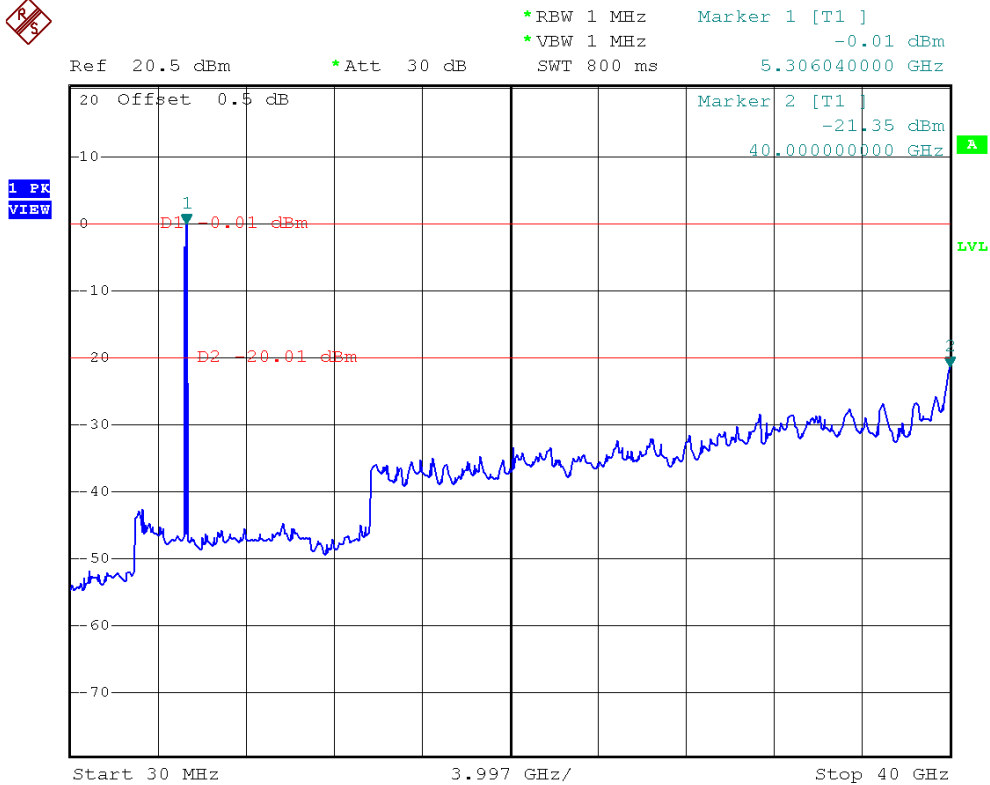



**5.8 TEST RESULTS - 5470-5725 MHZ BAND**

E.U.T	MONDOCENTER	Model Name	INF-MCENTER
Temperature	26°C	Relative Humidity	46%
Test Voltage	AC 120V/60Hz		
Test Mode	IEEE 802.11a		

Channel of Worst Data			
The max. radio frequency power in any 100kHz bandwidth outside the frequency band		The max. radio frequency power in any 100 kHz bandwidth within the frequency band.	
FREQUENCY(MHz)	POWER(dBm)	FREQUENCY(MHz)	POWER(dBm)
5469.60	-35.19	5726.00	-35.60
Result			
In any 100kHz bandwidth outside the frequency band, the radio frequency power is at least 20dB below that in the 100kHz bandwidth within the band that contains the highest level of the desired power.			



IEEE 802.11a/The max. radio frequency power in any 100kHz bandwidth outside the frequency band

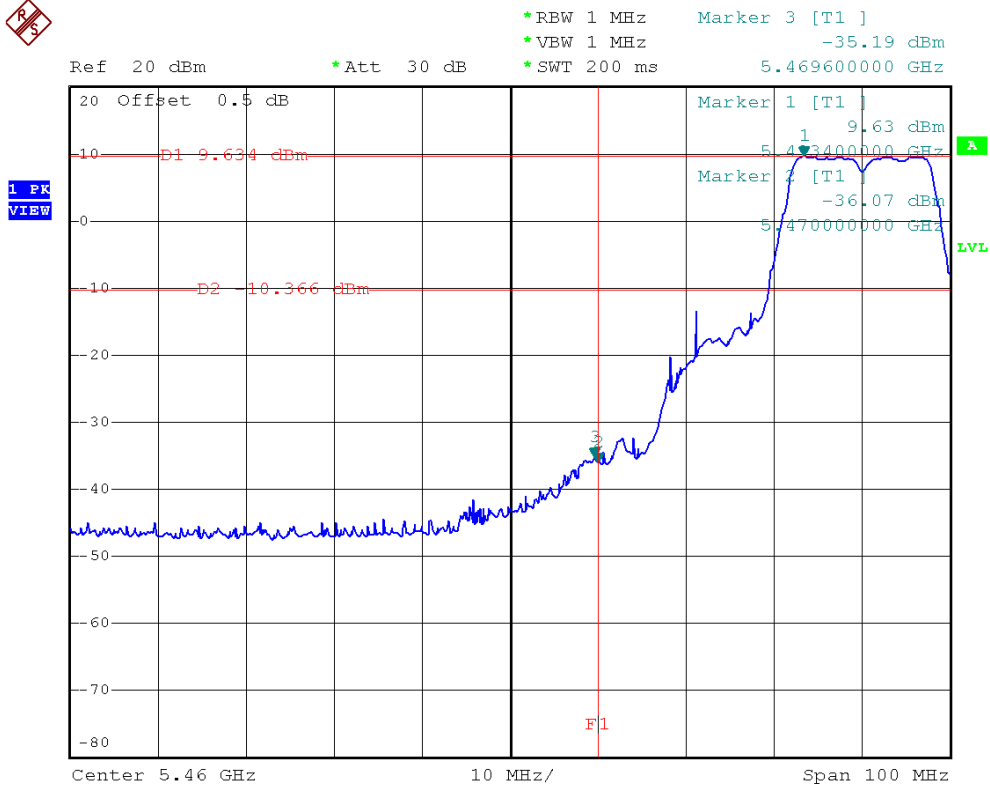

IEEE 802.11a/The max. radio frequency power in any 100 kHz bandwidth within the frequency band

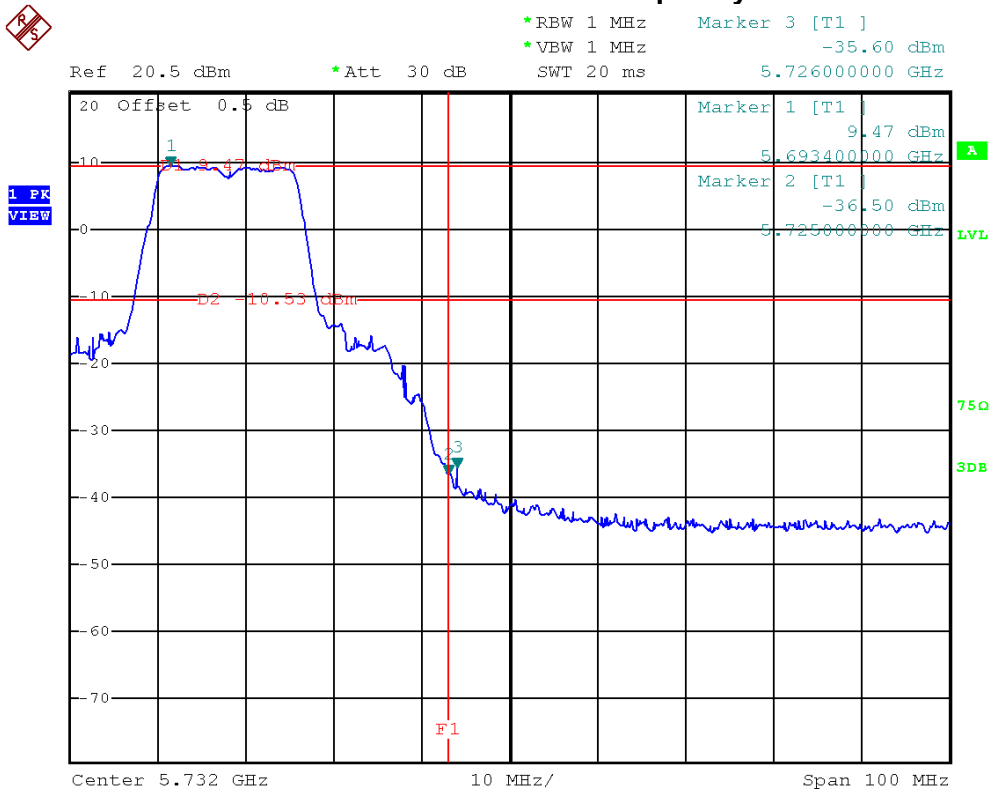





### IEEE 802.11a/5500 MHz/10 Harmonic of the frequency



\*RBW 1 MHz    Marker 2 [T1 ]  
\*VBW 1 MHz    -21.31 dBm  
SWT 800 ms    40.000000000 GHz

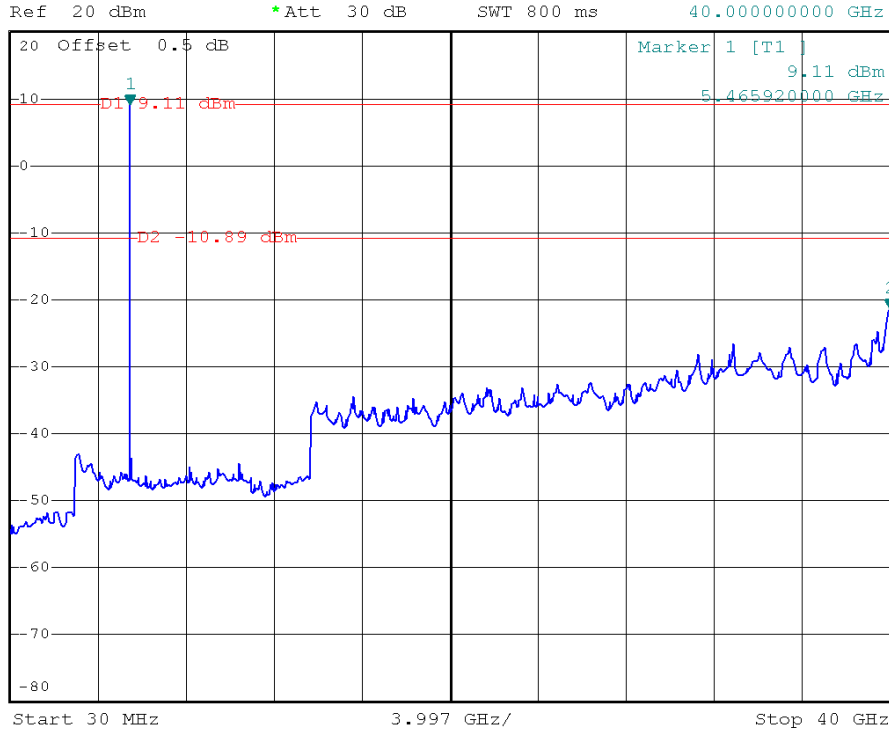

### IEEE 802.11a/5580 MHz/10 Harmonic of the frequency



\*RBW 1 MHz    Delta 2 [T1 ]  
\*VBW 1 MHz    -30.15 dB  
SWT 800 ms    34.454140000 GHz

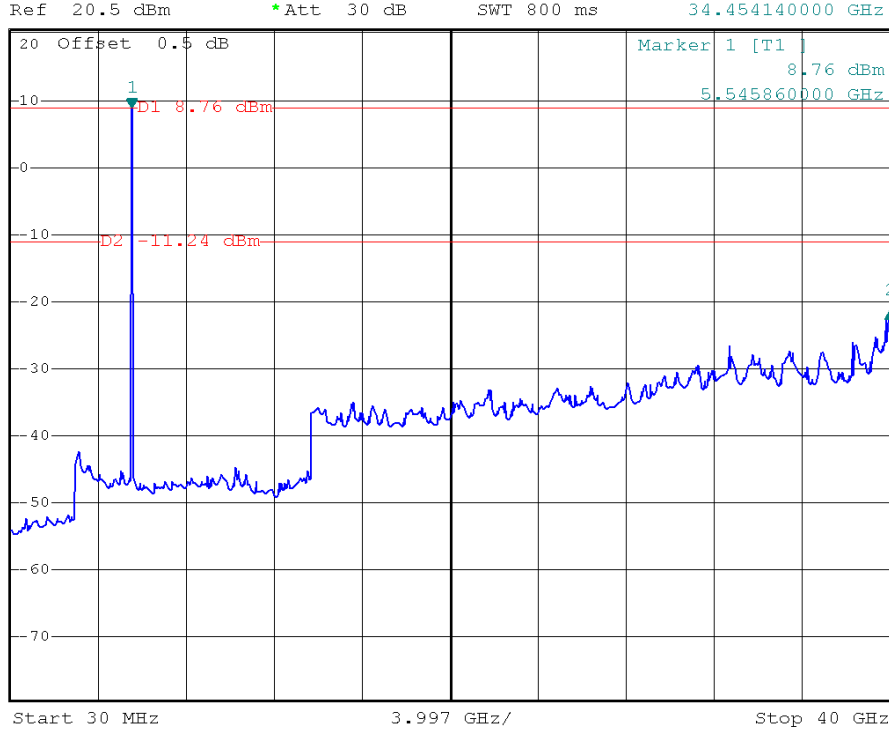



### IEEE 802.11a/5700 MHz/10 Harmonic of the frequency



\*RBW 1 MHz    Marker 2 [T1 ]  
\*VBW 1 MHz    -22.43 dBm  
SWT 800 ms    40.000000000 GHz

Ref 20.5 dBm    \*Att 30 dB

1 PK  
VIEW

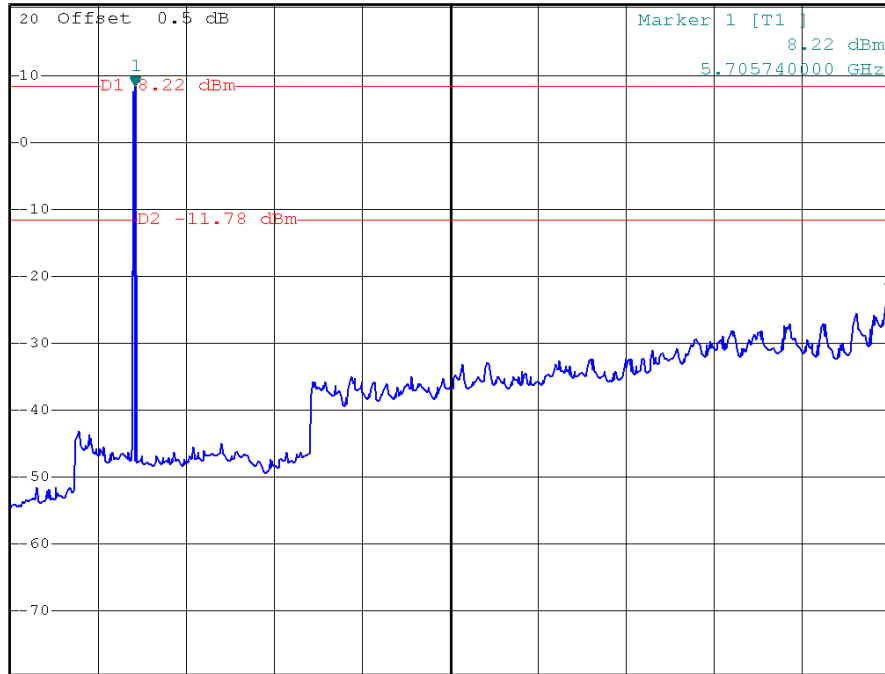

Start 30 MHz    3.997 GHz/    Stop 40 GHz



E.U.T	MONDOCENTER	Model Name	INF-MCENTER
Temperature	26°C	Relative Humidity	46%
Test Voltage	AC 120V/60Hz		
Test Mode	IEEE 802.11n (20 MHz)/ANT.1		

Channel of Worst Data			
The max. radio frequency power in any 100kHz bandwidth outside the frequency band		The max. radio frequency power in any 100 kHz bandwidth within the frequency band.	
FREQUENCY(MHz)	POWER(dBm)	FREQUENCY(MHz)	POWER(dBm)
2469.80	-38.95	5725.20	-37.48
Result			
In any 100kHz bandwidth outside the frequency band, the radio frequency power is at least 20dB below that in the 100kHz bandwidth within the band that contains the highest level of the desired power.			



IEEE 802.11n (20 MHz)/ANT.1/The max. radio frequency power in any 100kHz bandwidth outside the frequency band

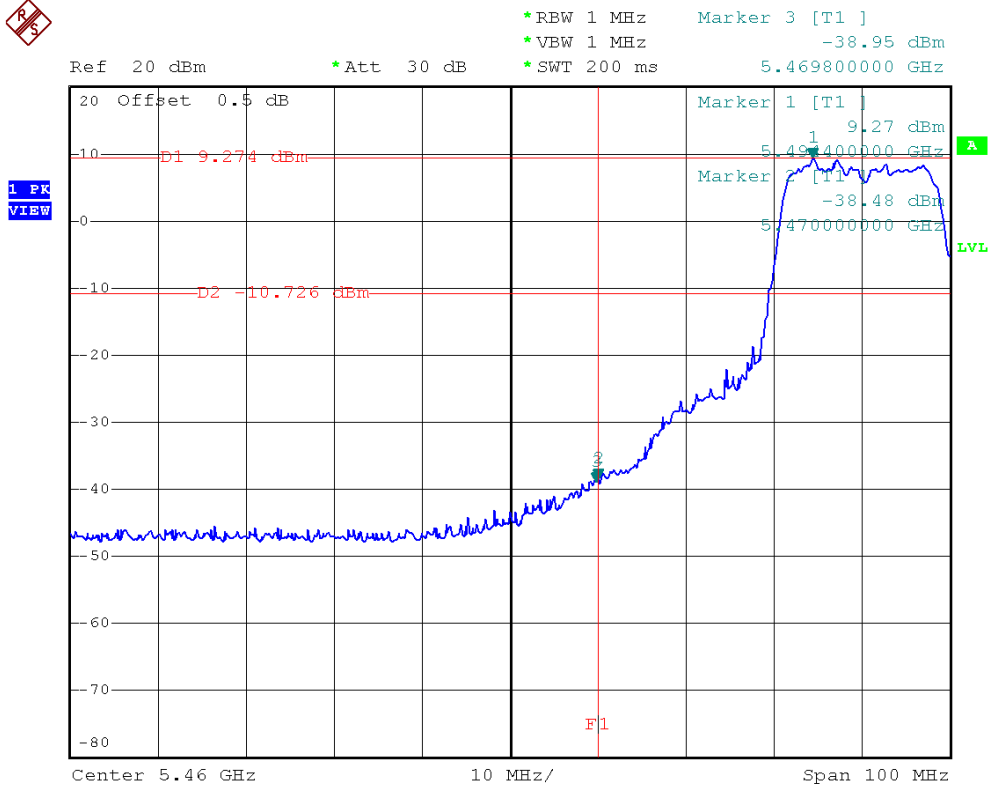

IEEE 802.11n (20 MHz)/ANT.1/The max. radio frequency power in any 100 kHz bandwidth within the frequency band

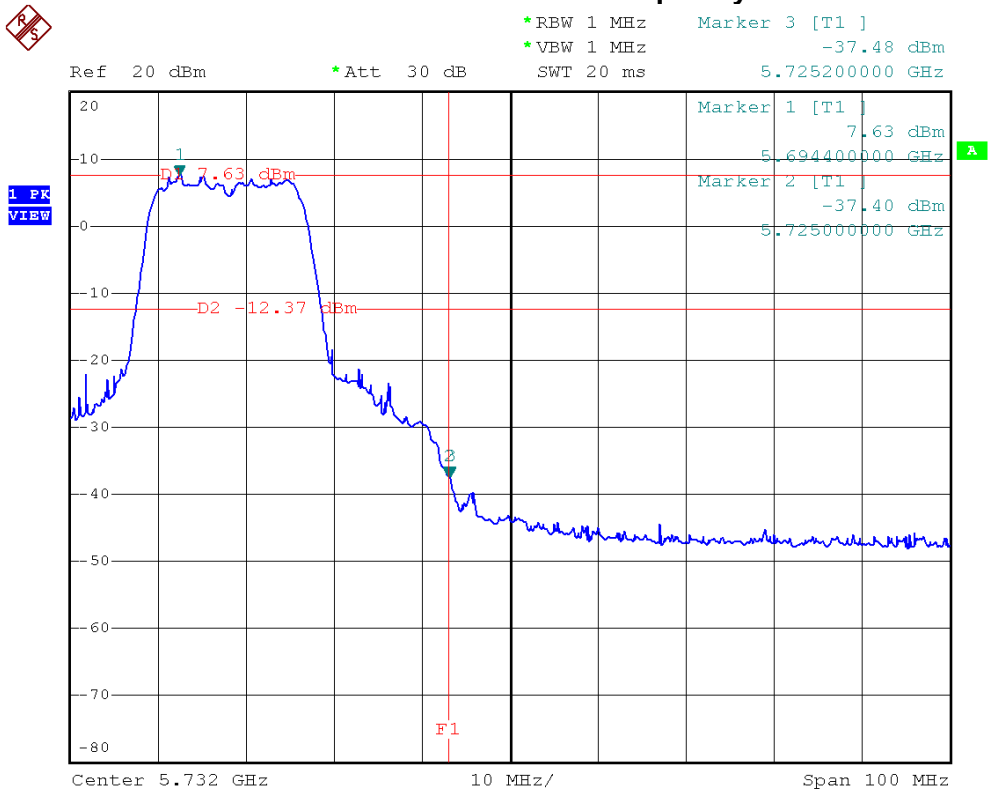



### IEEE 802.11n (20 MHz)/ANT.1/5500 MHz/10 Harmonic of the frequency

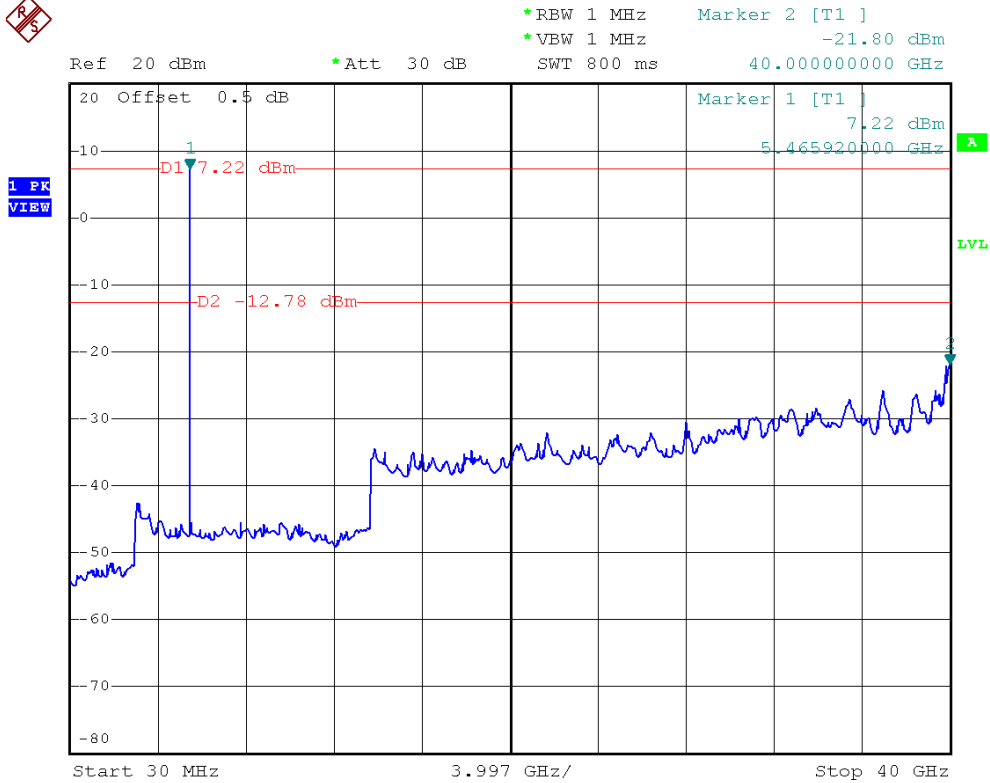

### IEEE 802.11n (20 MHz)/ANT.1/5580 MHz/10 Harmonic of the frequency

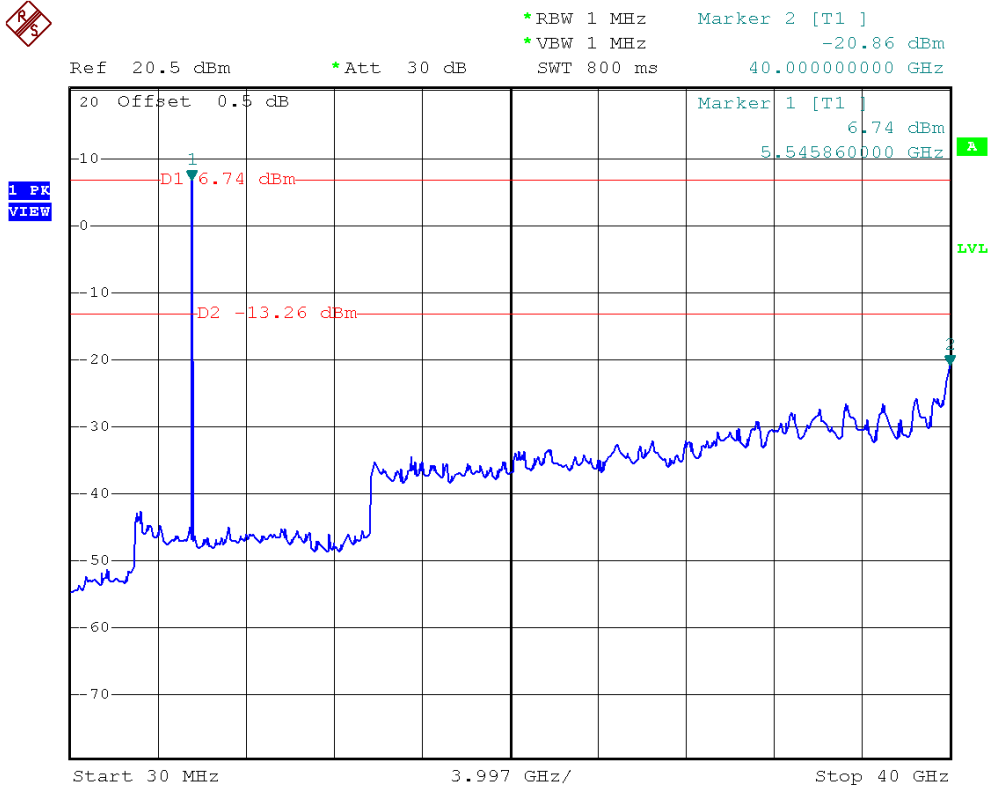



IEEE 802.11n (20 MHz)/ANT.1/5700 MHz/10 Harmonic of the frequency



\*RBW 1 MHz    Marker 2 [T1 ]  
\*VBW 1 MHz    -21.80 dBm  
SWT 800 ms    40.000000000 GHz

Ref 20.5 dBm    \*Att 30 dB

1 PK  
VIEW

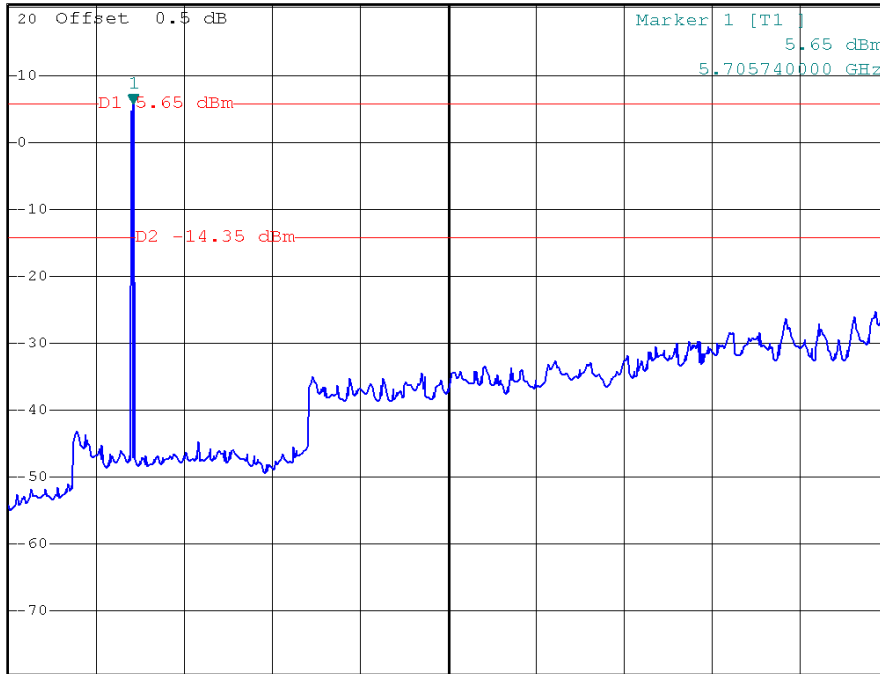

Start 30 MHz    3.997 GHz/    Stop 40 GHz



E.U.T	MONDOCENTER	Model Name	INF-MCENTER
Temperature	26°C	Relative Humidity	46%
Test Voltage	AC 120V/60Hz		
Test Mode	IEEE 802.11n (20 MHz)/ANT.2		

Channel of Worst Data			
The max. radio frequency power in any 100kHz bandwidth outside the frequency band		The max. radio frequency power in any 100 kHz bandwidth within the frequency band.	
FREQUENCY(MHz)	POWER(dBm)	FREQUENCY(MHz)	POWER(dBm)
5469.80	-37.61	5725.20	-37.61
Result			
In any 100kHz bandwidth outside the frequency band, the radio frequency power is at least 20dB below that in the 100kHz bandwidth within the band that contains the highest level of the desired power.			



IEEE 802.11n (20 MHz)/ANT.2/The max. radio frequency power in any 100kHz bandwidth outside the frequency band

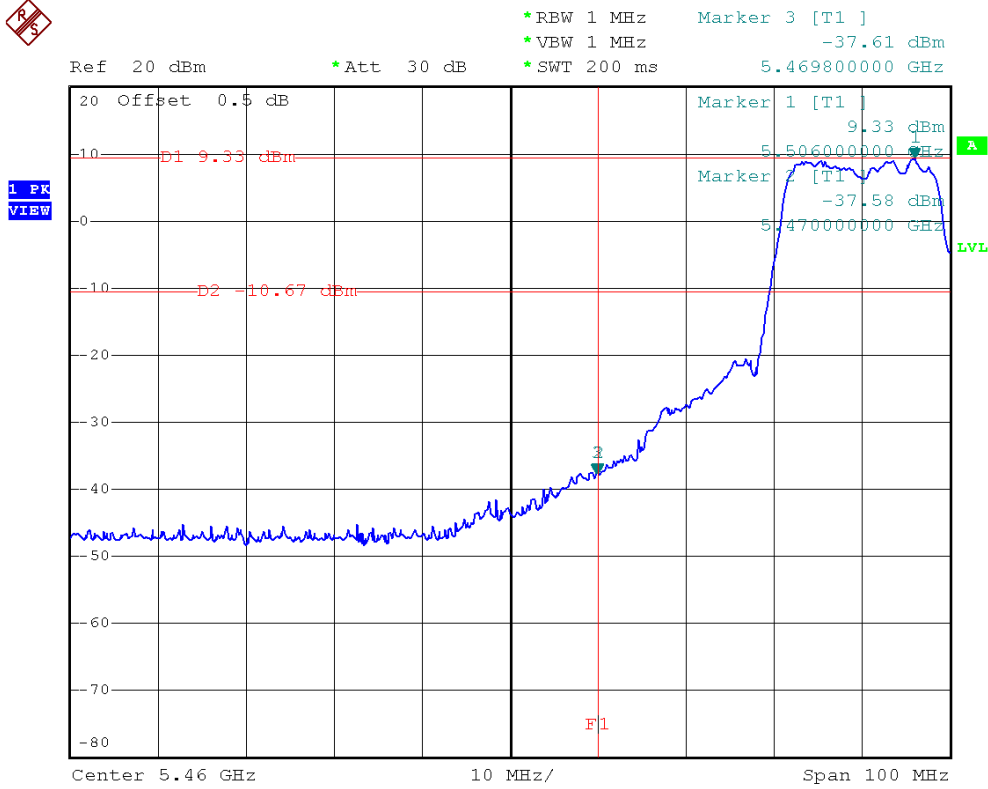

IEEE 802.11n (20 MHz)/ANT.2/The max. radio frequency power in any 100 kHz bandwidth within the frequency band

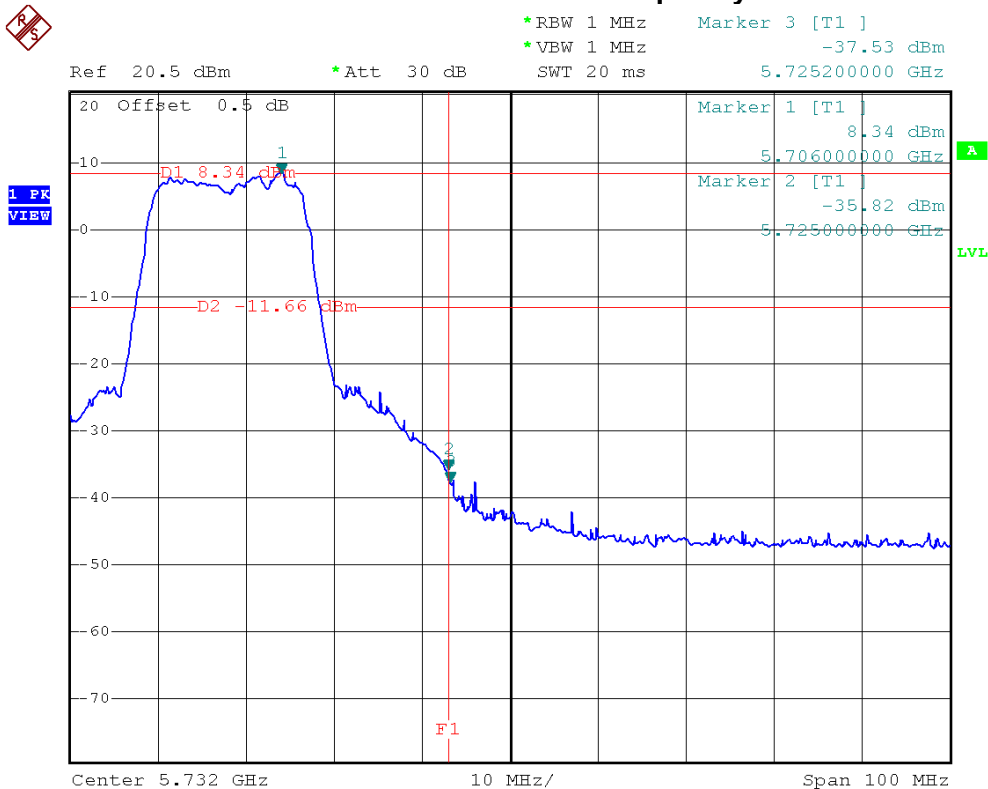





### IEEE 802.11n (20 MHz)/ANT.2/5500 MHz/10 Harmonic of the frequency

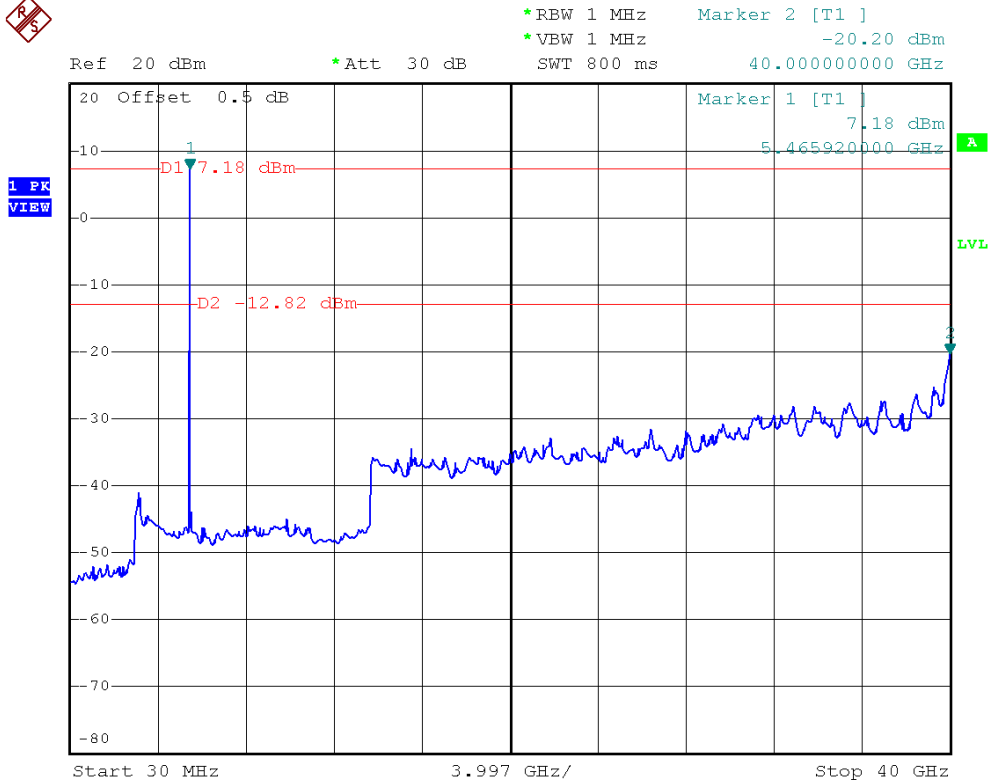

### IEEE 802.11n (20 MHz)/ANT.2/5580 MHz/10 Harmonic of the frequency

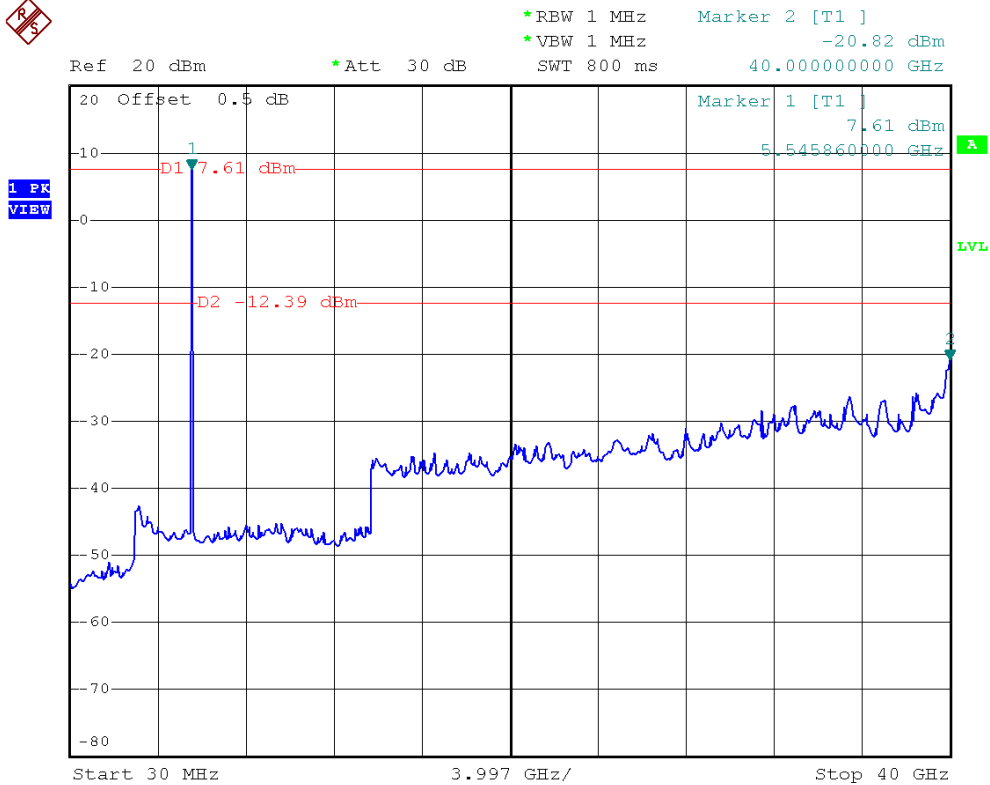



### IEEE 802.11n (20 MHz)/ANT.2/5700 MHz/10 Harmonic of the frequency



\*RBW 1 MHz    Marker 2 [T1 ]  
\*VBW 1 MHz    -21.14 dBm  
SWT 800 ms    40.000000000 GHz

Ref 20.5 dBm    \*Att 30 dB

1 PK  
VIEW

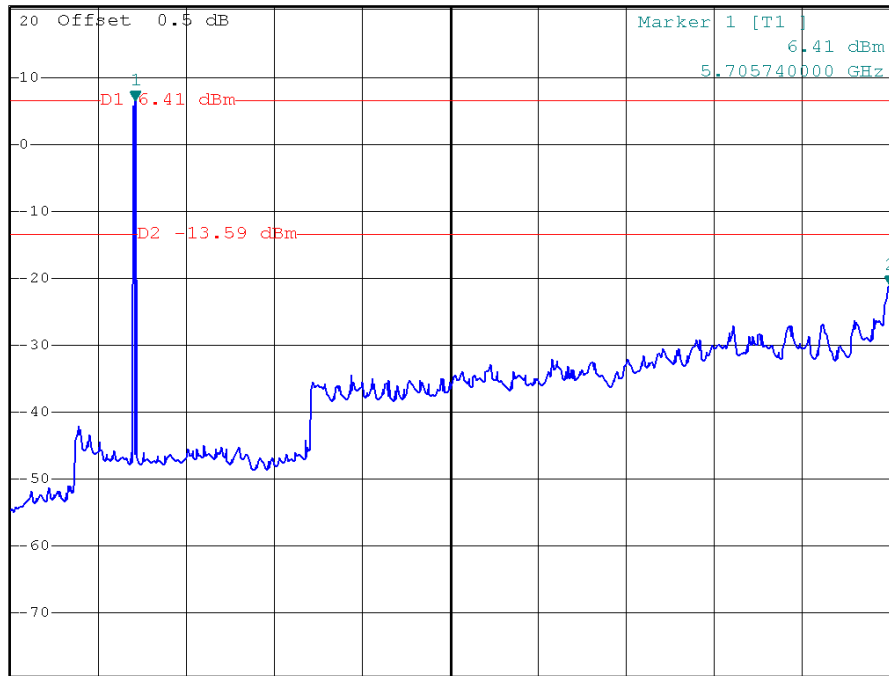

Start 30 MHz    3.997 GHz/    Stop 40 GHz



E.U.T	MONDOCENTER	Model Name	INF-MCENTER
Temperature	26°C	Relative Humidity	46%
Test Voltage	AC 120V/60Hz		
Test Mode	IEEE 802.11n (40 MHz)/ANT.1		

Channel of Worst Data			
The max. radio frequency power in any 100kHz bandwidth outside the frequency band		The max. radio frequency power in any 100 kHz bandwidth within the frequency band.	
FREQUENCY(MHz)	POWER(dBm)	FREQUENCY(MHz)	POWER(dBm)
5469.60	-31.88	5726.60	-39.59
Result			
In any 100kHz bandwidth outside the frequency band, the radio frequency power is at least 20dB below that in the 100kHz bandwidth within the band that contains the highest level of the desired power.			



IEEE 802.11n (40 MHz)/ANT.1/The max. radio frequency power in any 100kHz bandwidth outside the frequency band

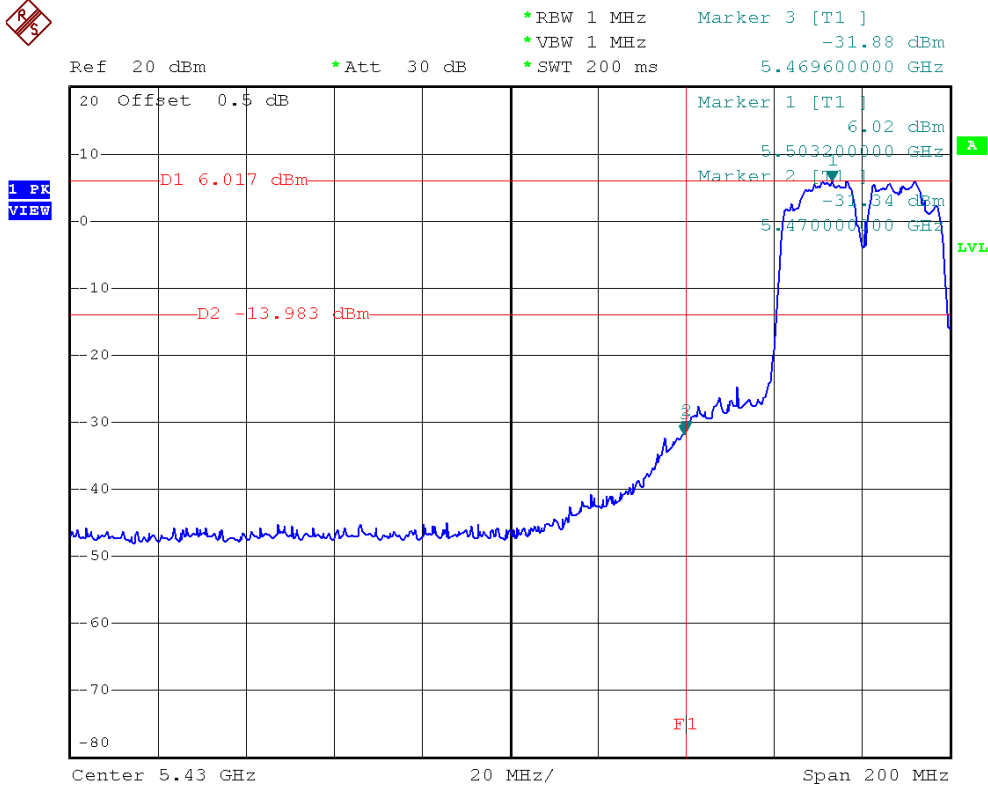

IEEE 802.11n (40 MHz)/ANT.1/The max. radio frequency power in any 100 kHz bandwidth within the frequency band

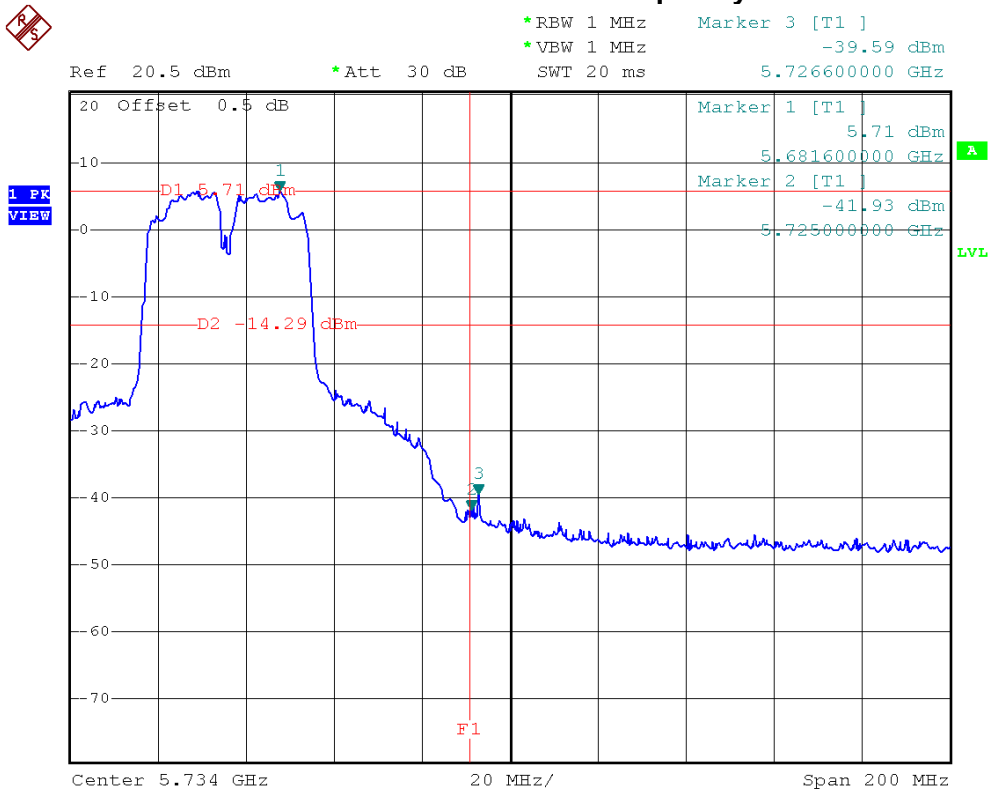



### IEEE 802.11n (40 MHz)/ANT.1/5510 MHz/10 Harmonic of the frequency

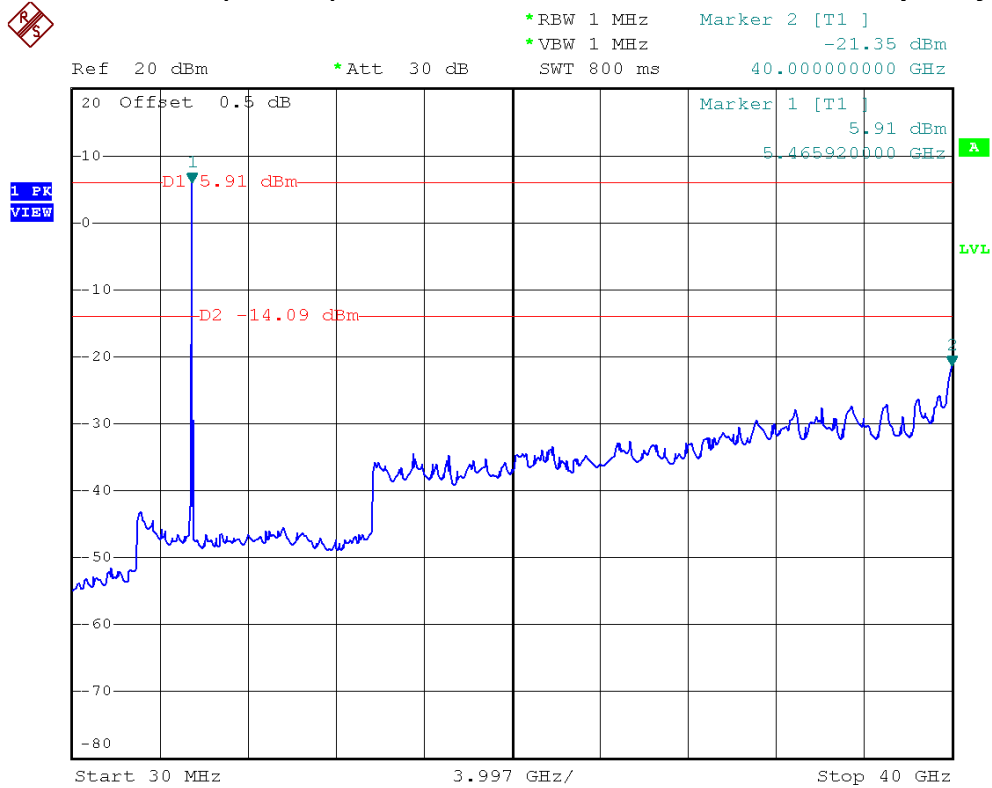

### IEEE 802.11n (40 MHz)/ANT.1/5550 MHz/10 Harmonic of the frequency

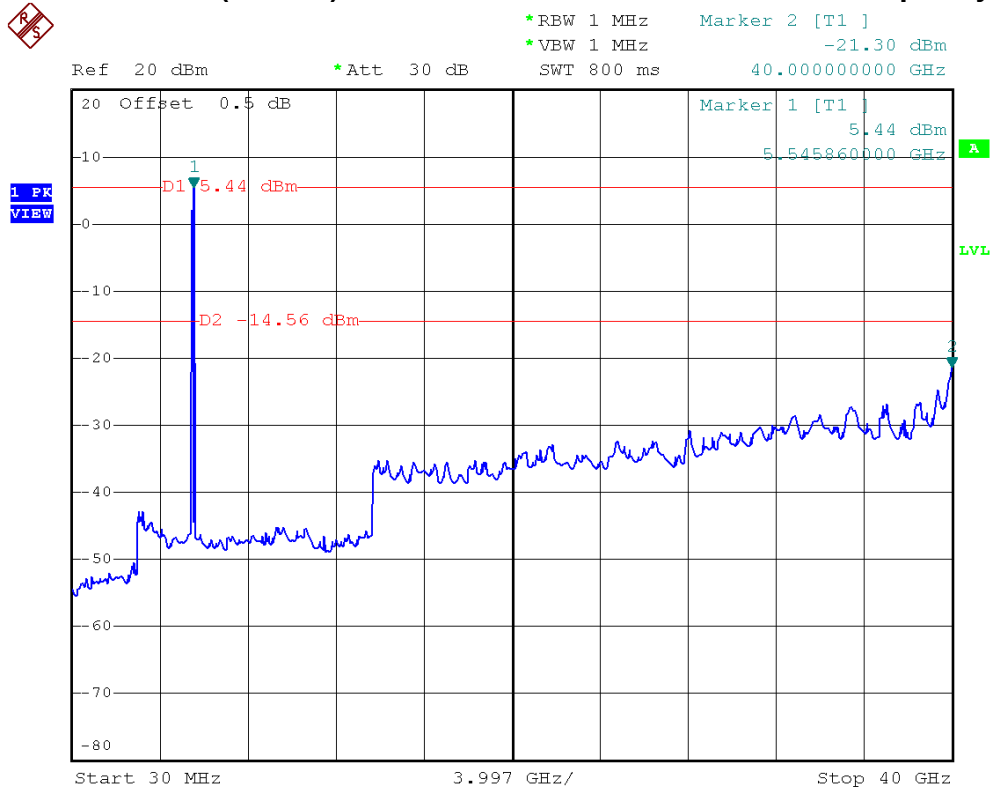



### IEEE 802.11n (40 MHz)/ANT.1/5670 MHz/10 Harmonic of the frequency



\*RBW 1 MHz    Marker 2 [T1 ]  
\*VBW 1 MHz    -21.76 dBm  
SWT 800 ms    40.000000000 GHz

Ref 20.5 dBm    \*Att 30 dB

1 PK  
VIEW

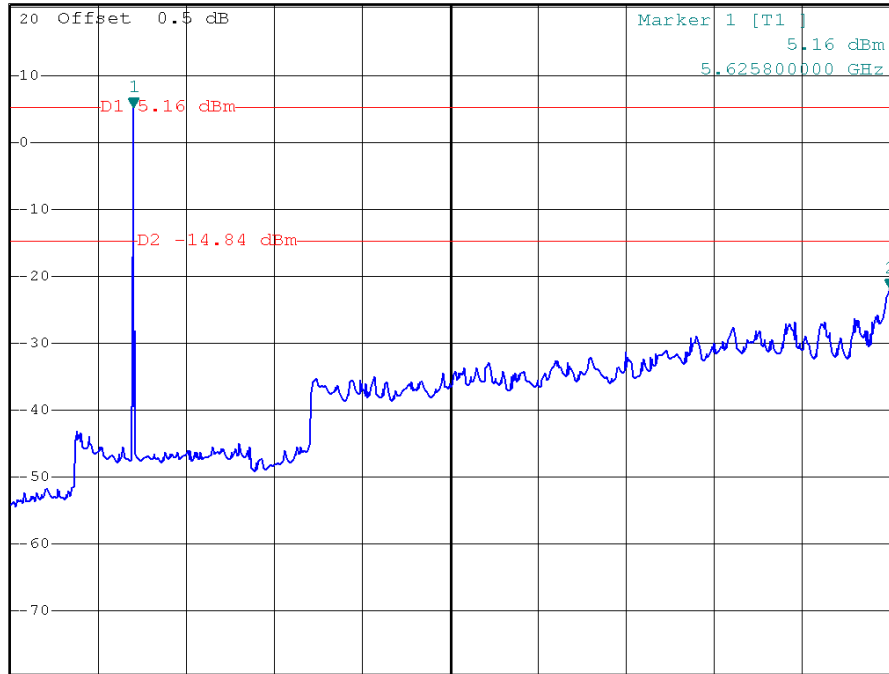

Start 30 MHz    3.997 GHz/    Stop 40 GHz



E.U.T	MONDOCENTER	Model Name	INF-MCENTER
Temperature	26°C	Relative Humidity	46%
Test Voltage	AC 120V/60Hz		
Test Mode	IEEE 802.11n (40 MHz)/ANT.2		

Channel of Worst Data			
The max. radio frequency power in any 100kHz bandwidth outside the frequency band		The max. radio frequency power in any 100 kHz bandwidth within the frequency band.	
FREQUENCY(MHz)	POWER(dBm)	FREQUENCY(MHz)	POWER(dBm)
5469.20	-28.30	5725.40	-41.58
Result			
In any 100kHz bandwidth outside the frequency band, the radio frequency power is at least 20dB below that in the 100kHz bandwidth within the band that contains the highest level of the desired power.			



IEEE 802.11n (40 MHz)/ANT.2/The max. radio frequency power in any 100kHz bandwidth outside the frequency band

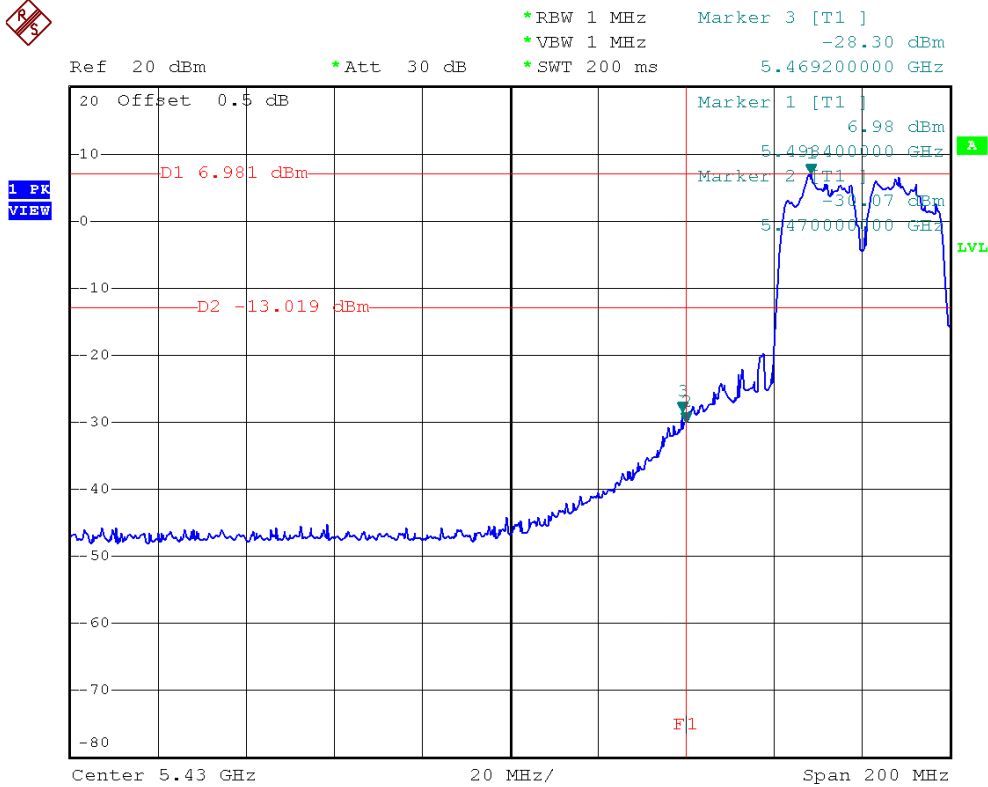

IEEE 802.11n (40 MHz)/ANT.2/The max. radio frequency power in any 100 kHz bandwidth within the frequency band

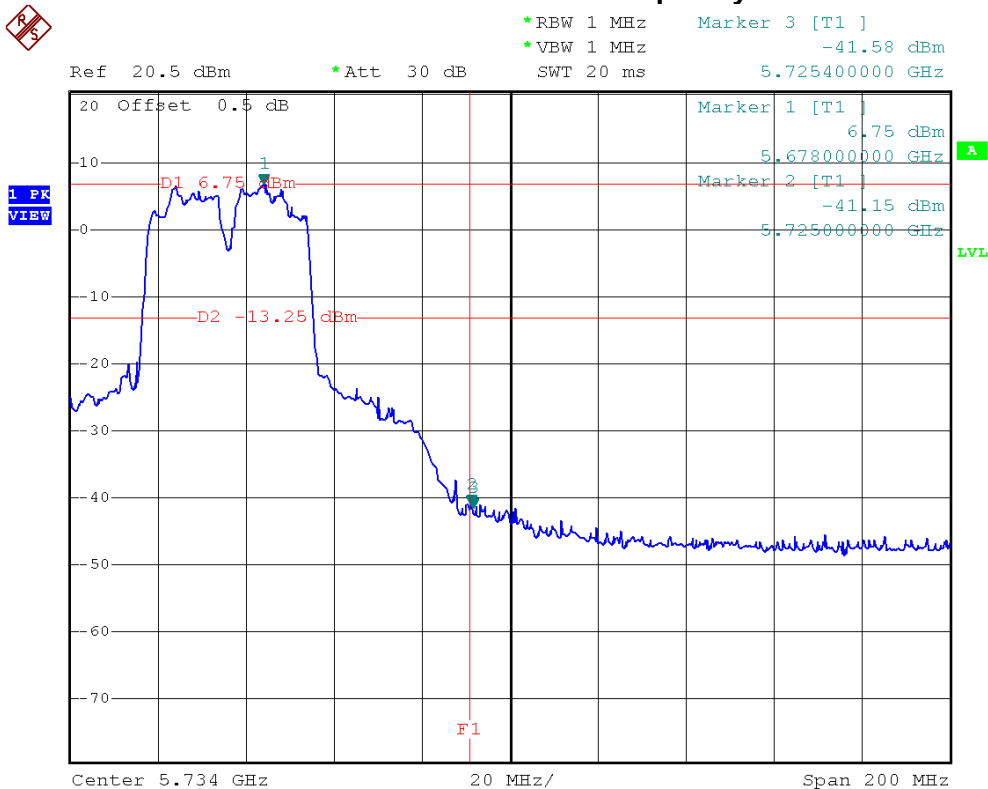





### IEEE 802.11n (40 MHz)/ANT.2/5510 MHz/10 Harmonic of the frequency

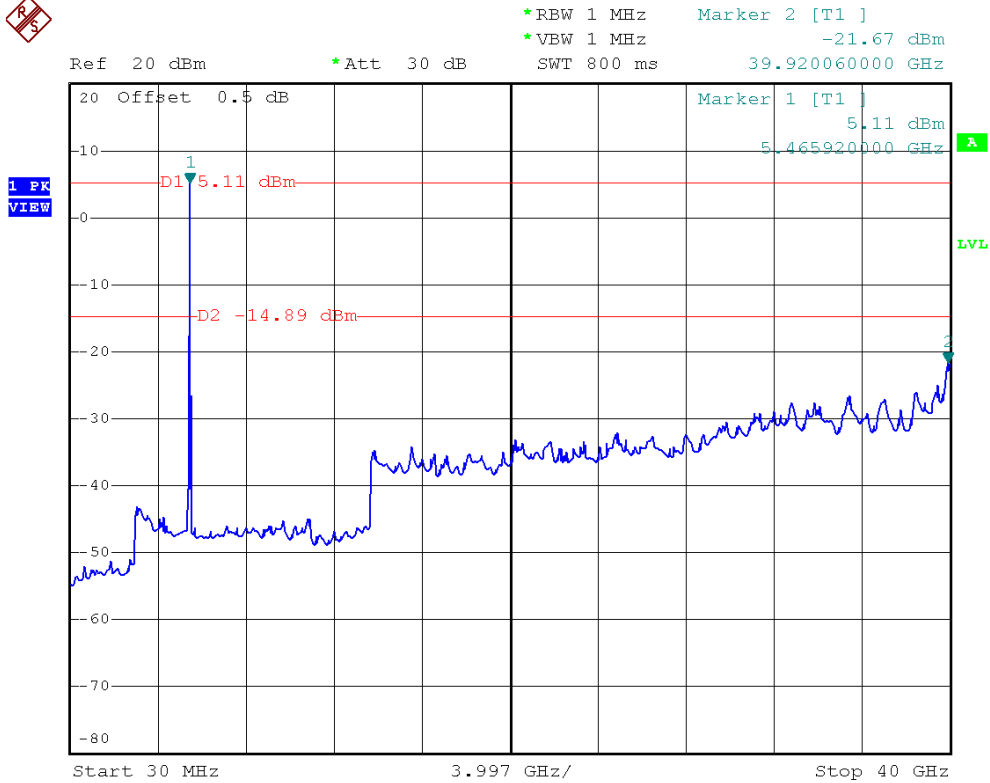

### IEEE 802.11n (40 MHz)/ANT.2/5550 MHz/10 Harmonic of the frequency

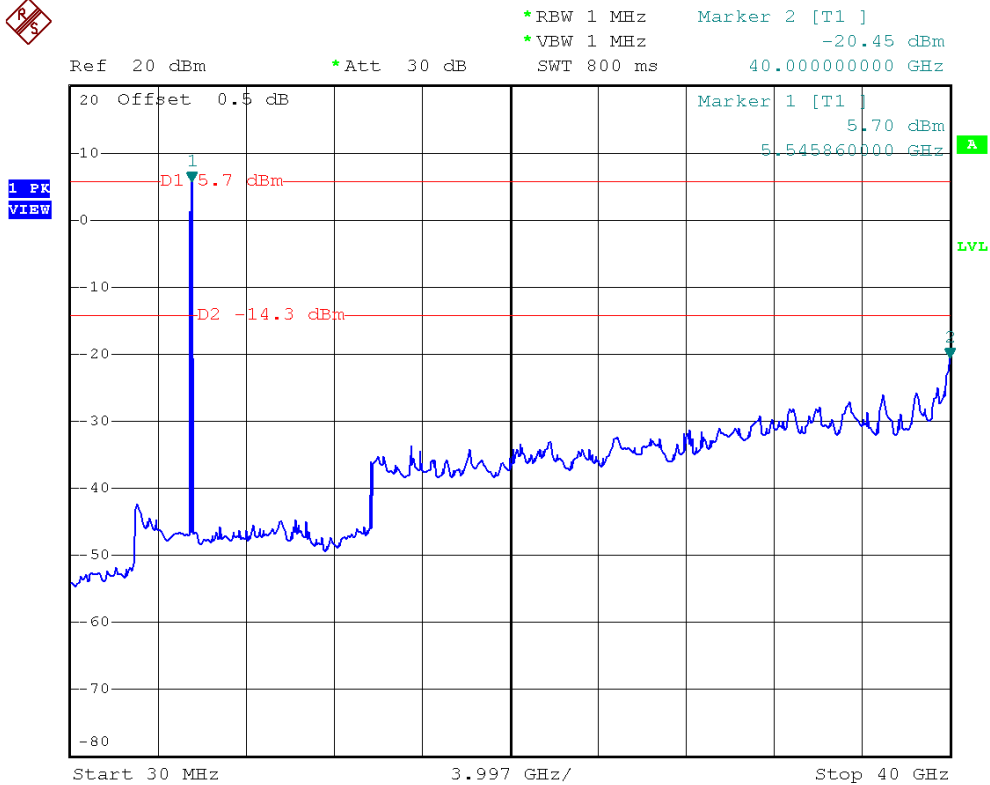



IEEE 802.11n (40 MHz)/ANT.2/5670 MHz/10 Harmonic of the frequency



\*RBW 1 MHz    Marker 2 [T1 ]  
\*VBW 1 MHz    -21.46 dBm  
SWT 800 ms    40.000000000 GHz

Ref 20.5 dBm    \*Att 30 dB

1 PK  
VIEW

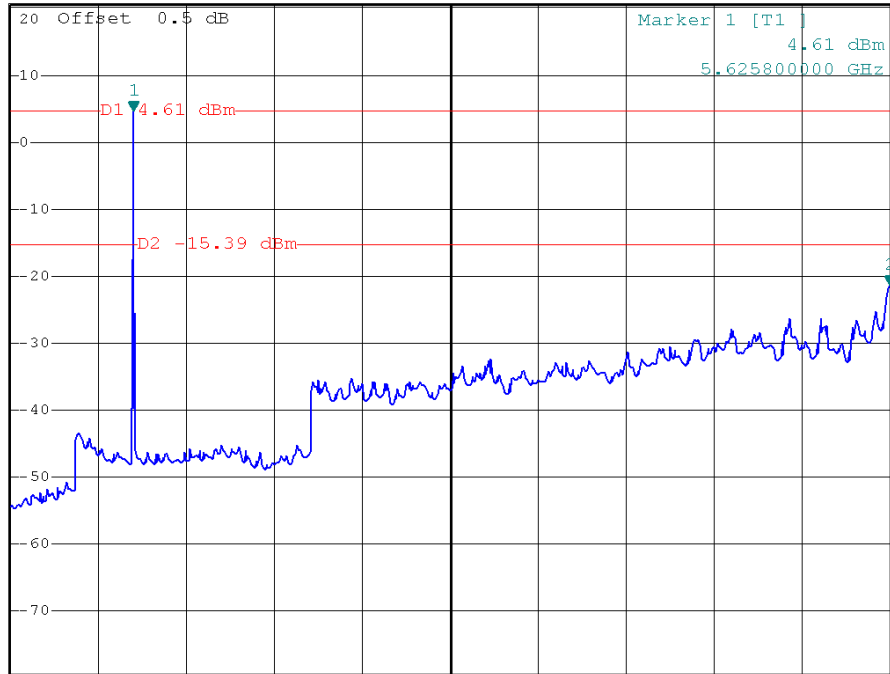

Start 30 MHz    3.997 GHz/    Stop 40 GHz



**6 26 DB BANDWIDTH**

**6.1 LIMIT**

Test Item	Frequency Range (MHz)	Limit
26 dB Bandwidth	5150 - 5250	---
	5250 - 5350	
	5470 - 5725	
	5725 - 5825	

**6.2 MEASUREMENT INSTRUMENTS LIST**

Item	Kind of Equipment	Manufacturer	Type No.	Serial No.	Calibrated until
1	Spectrum Analyzer	R&S	FSP-40	100129	Oct. 06, 2012

NOTE: **N/A**: denotes No Model Name, No Serial No. or No Calibration specified.

**6.3 MEASURING INSTRUMENTS SETTING**

Spectrum Analyzer	Parameter Setting
Attenuation	Auto
Span Frequency	> 26dB Bandwidth
RB	300 kHz
VB	1000 kHz
Detector	Peak
Trace	Max Hold
Sweep Time	Auto

**6.4 TEST PROCEDURES**

- a. The EUT was directly connected to the spectrum analyzer and antenna output port as show in the block diagram below
- b. Measured the spectrum width with power higher than 26dB below carrier

**6.5 TEST SETUP LAYOUT**

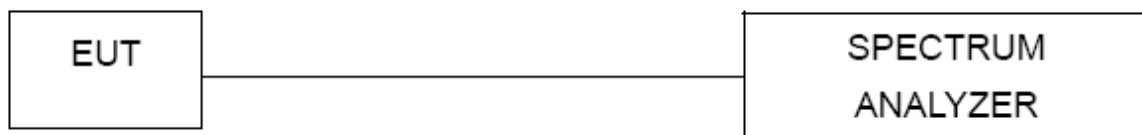

**6.6 DEVIATION FROM TEST STANDARD**

No deviation

**6.7 EUT OPERATING CONDITIONS**

The EUT tested system was configured as the statements of 5.6 Unless otherwise a special operating condition is specified in the follows during the testing.



**6.8 TEST RESULTS - 5150-5250 MHZ**

E.U.T	MONDOCENTER	Model Name	INF-MCENTER
Temperature	26°C	Relative Humidity	46%
Test Voltage	AC 120V/60Hz		
Test Mode	IEEE 802.11a/5180 MHz, 5200 MHz, 5240 MHz		

Frequency	26 dB Bandwidth (MHz)	99% Occupied Bandwidth (MHz)
5180 MHz	23.68	16.88
5200 MHz	20.96	16.88
5240 MHz	24.40	16.88

**IEEE 802.11a/5180 MHz/26 dB and 99% Occupied Bandwidth**

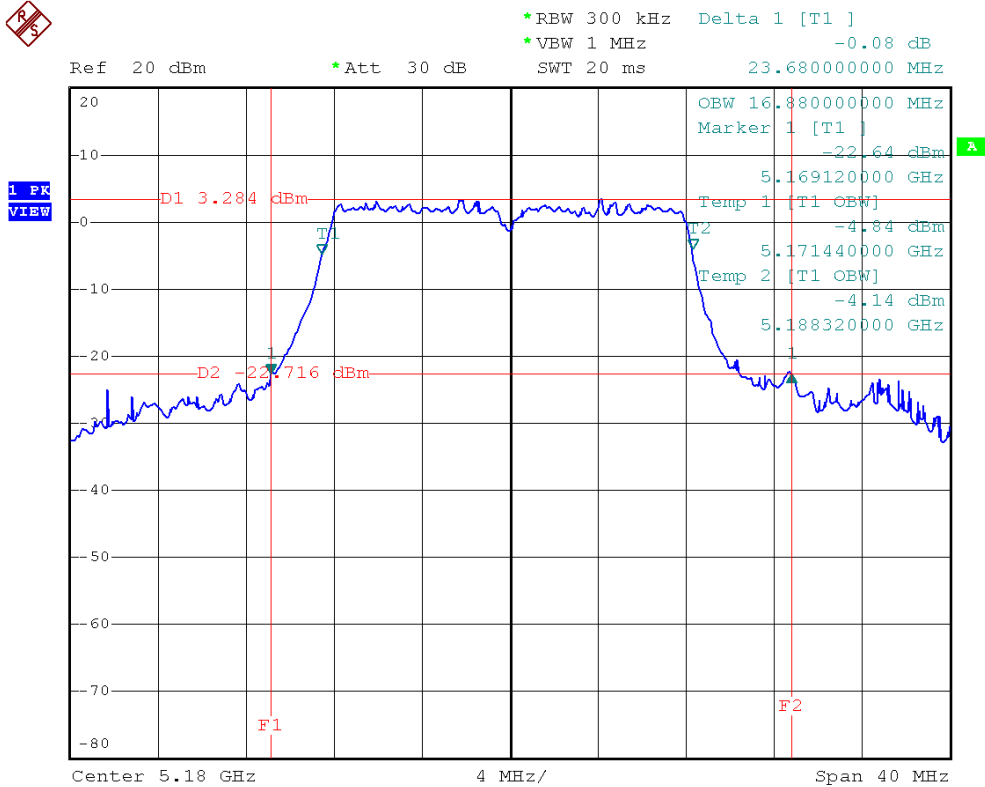



**IEEE 802.11a/5200 MHz/26 dB and 99% Occupied Bandwidth**



\*RBW 300 kHz Delta 1 [T1 ]  
 \*VBW 1 MHz -0.16 dB  
 \*Att 30 dB  
 SWT 20 ms 20.960000000 MHz

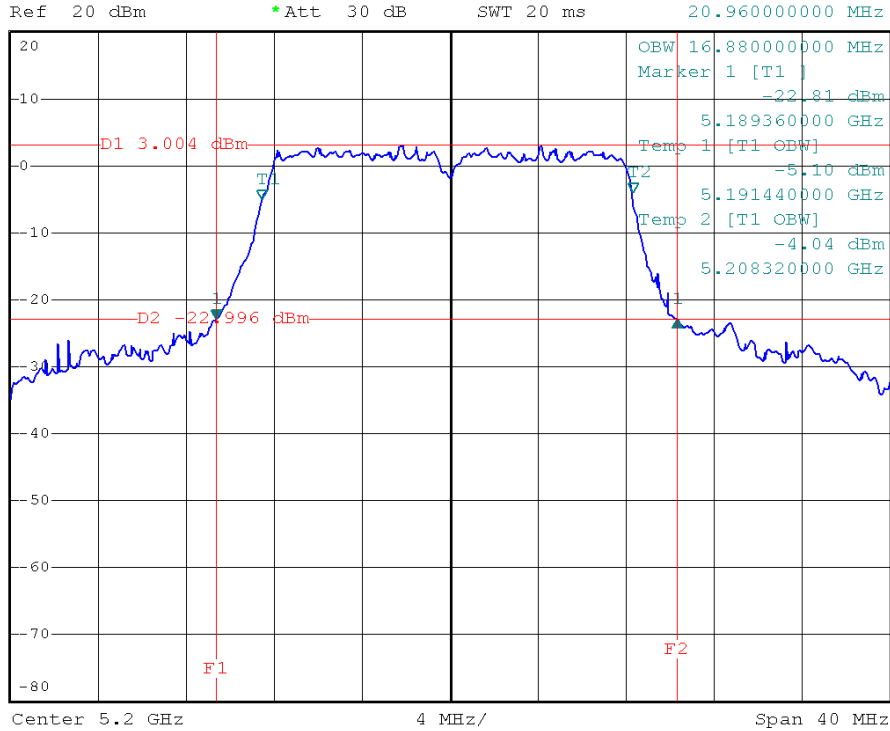

**IEEE 802.11a/5240 MHz/26 dB and 99% Occupied Bandwidth**



\*RBW 300 kHz Delta 1 [T1 ]  
 \*VBW 1 MHz 0.06 dB  
 \*Att 30 dB  
 SWT 20 ms 24.400000000 MHz

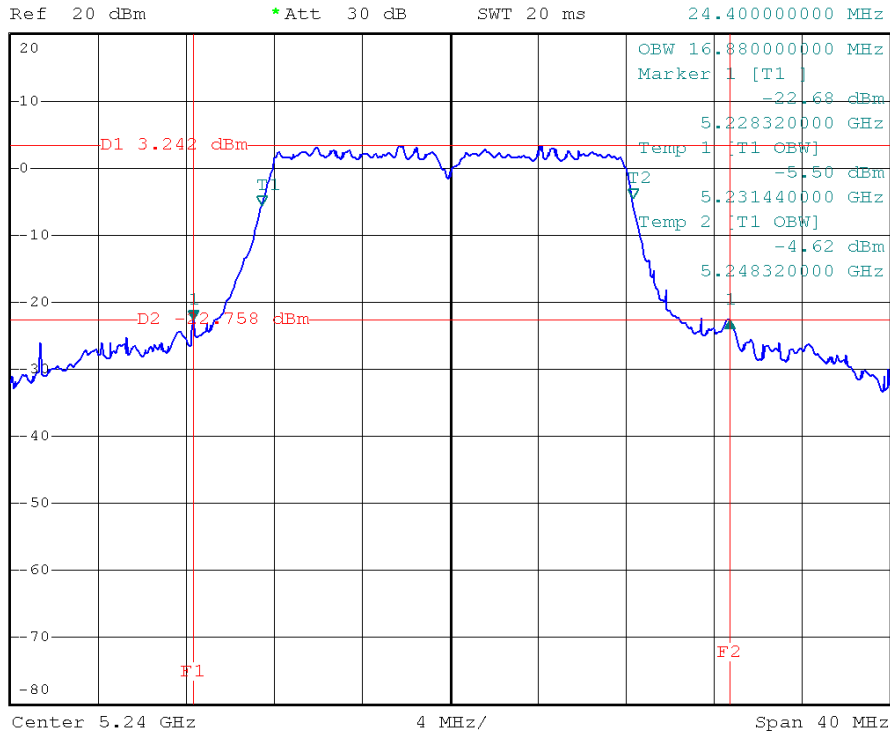



E.U.T	MONDOCENTER	Model Name	INF-MCENTER
Temperature	26°C	Relative Humidity	46%
Test Voltage	AC 120V/60Hz		
Test Mode	IEEE 802.11n (20 MHz)/ANT.1/5180 MHz, 5200 MHz, 5240 MHz		

Frequency	26 dB Bandwidth (MHz)	99% Occupied Bandwidth (MHz)
5180 MHz	21.04	17.84
5200 MHz	20.80	17.84
5240 MHz	20.96	17.84

**IEEE 802.11n (20 MHz)/ANT.1/5180 MHz/26 dB and 99% Occupied Bandwidth**

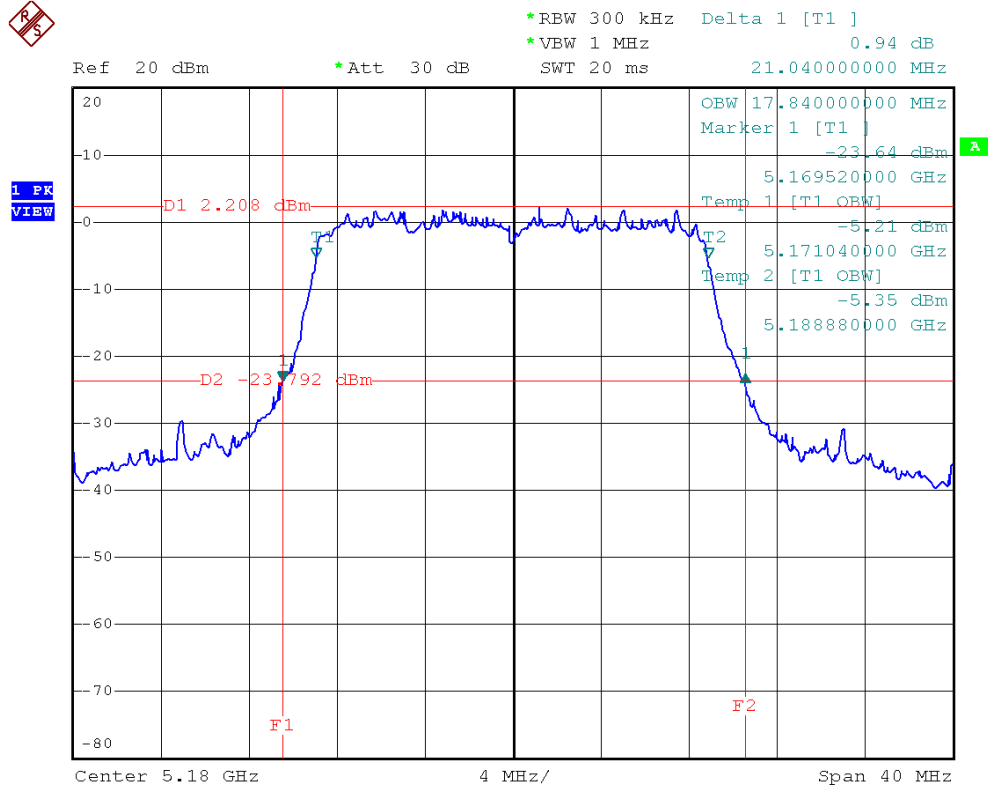



**IEEE 802.11n (20 MHz)/ANT.1/5200 MHz/26 dB and 99% Occupied Bandwidth**



\*RBW 300 kHz Delta 1 [T1 ]  
 \*VBW 1 MHz 0.21 dB  
 \*Att 30 dB  
 Ref 20 dBm  
 SWT 20 ms 20.800000000 MHz

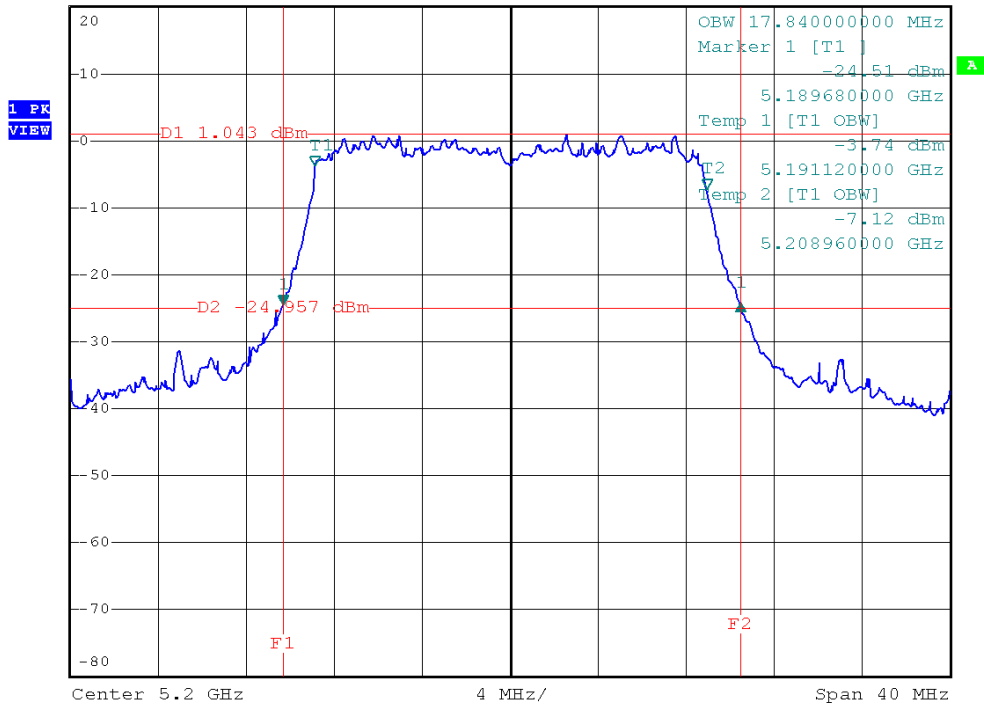

**IEEE 802.11n (20 MHz)/ANT.1/5240 MHz/26 dB and 99% Occupied Bandwidth**



\*RBW 300 kHz Delta 1 [T1 ]  
 \*VBW 1 MHz 0.12 dB  
 \*Att 30 dB  
 Ref 20 dBm  
 SWT 20 ms 20.960000000 MHz

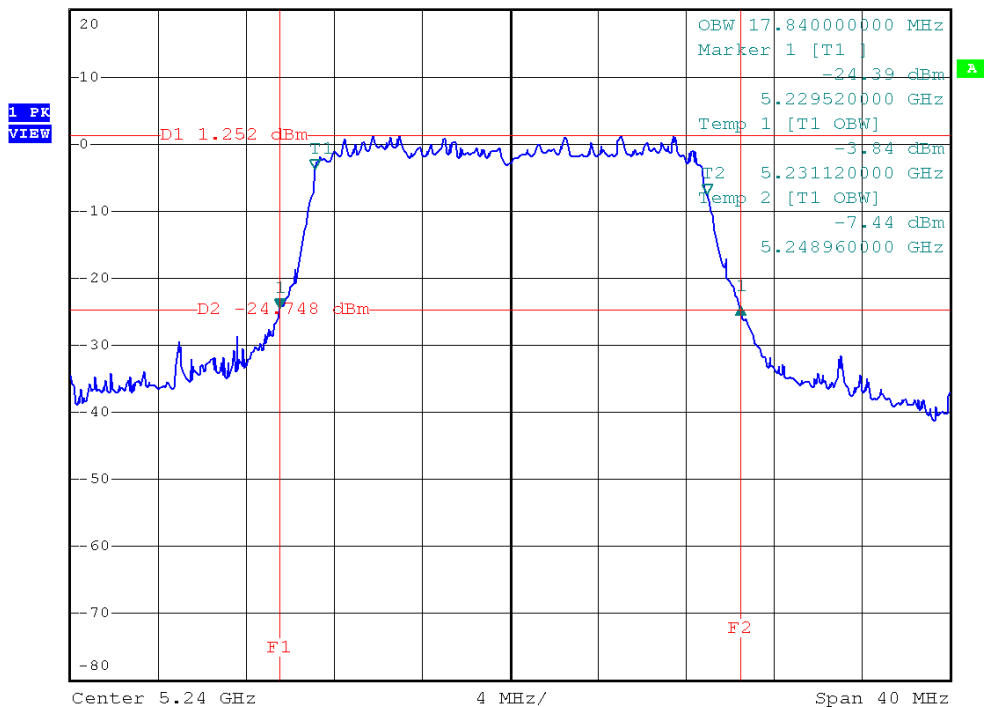



E.U.T	MONDOCENTER	Model Name	INF-MCENTER
Temperature	26°C	Relative Humidity	46%
Test Voltage	AC 120V/60Hz		
Test Mode	IEEE 802.11n (20 MHz)/ANT.2/5180 MHz, 5200 MHz, 5240 MHz		

Frequency	26 dB Bandwidth (MHz)	99% Occupied Bandwidth (MHz)
5180 MHz	20.88	17.92
5200 MHz	20.88	17.84
5240 MHz	20.88	17.92

**IEEE 802.11n (20 MHz)/ANT.2/5180 MHz/26 dB and 99% Occupied Bandwidth**

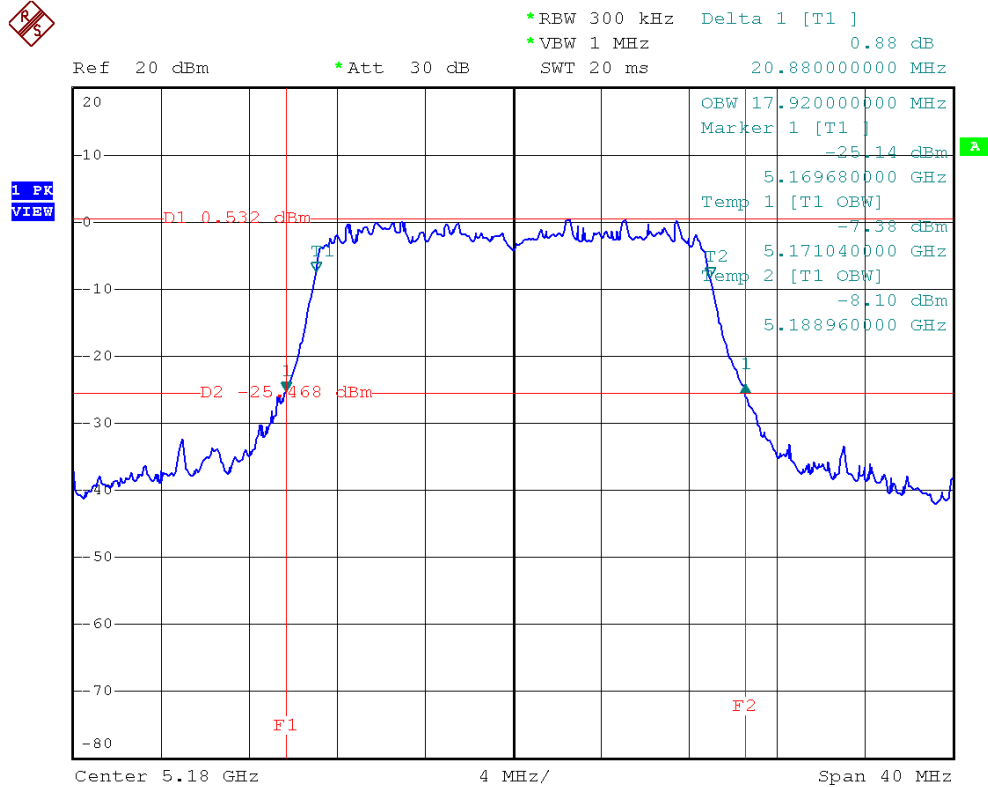





### IEEE 802.11n (20 MHz)/ANT.2/5200 MHz/26 dB and 99% Occupied Bandwidth



\*RBW 300 kHz Delta 1 [T1 ]  
\*VBW 1 MHz 1.24 dB  
SWT 20 ms 20.800000000 MHz

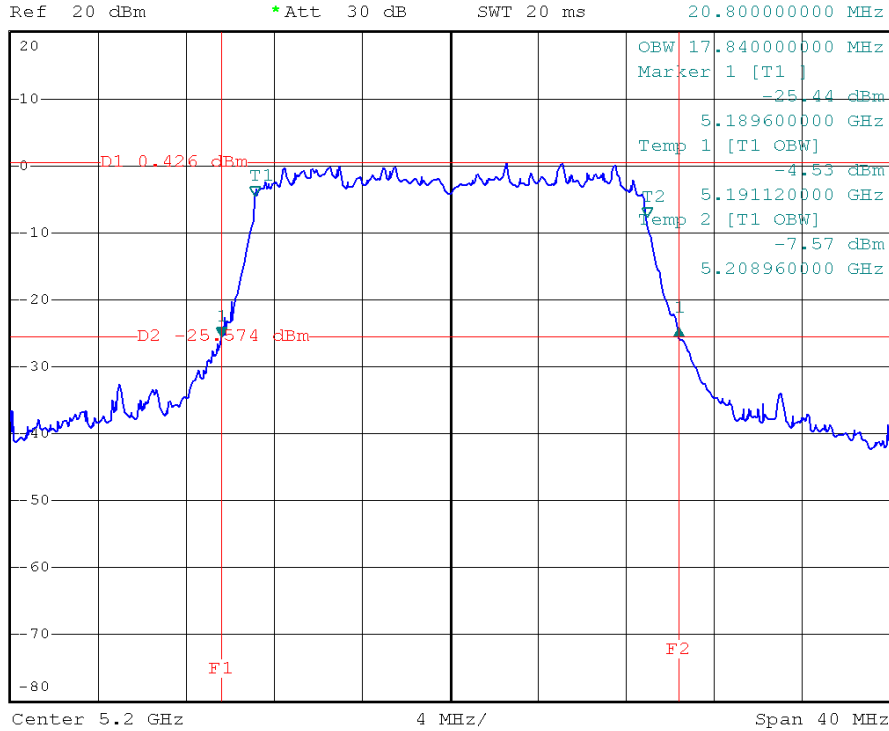

### IEEE 802.11n (20 MHz)/ANT.2/5240 MHz/26 dB and 99% Occupied Bandwidth



\*RBW 300 kHz Delta 1 [T1 ]  
\*VBW 1 MHz 0.43 dB  
SWT 20 ms 20.800000000 MHz

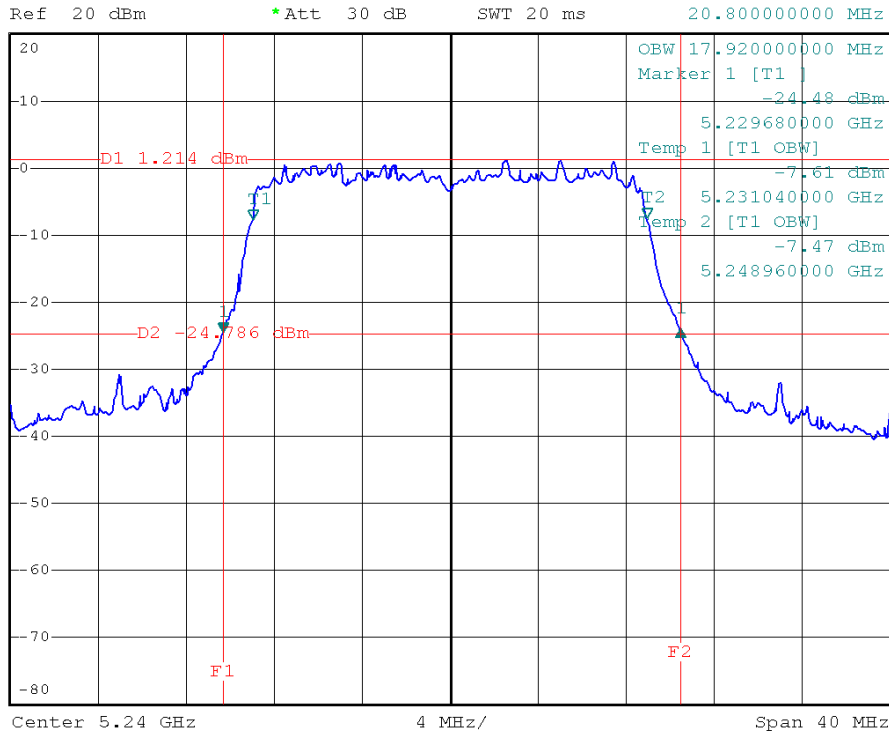



E.U.T	MONDOCENTER	Model Name	INF-MCENTER
Temperature	26°C	Relative Humidity	46%
Test Voltage	AC 120V/60Hz		
Test Mode	IEEE 802.11n (40 MHz)/ANT.1/5190 MHz, 5230 MHz		

Frequency	26 dB Bandwidth (MHz)	99% Occupied Bandwidth (MHz)
5190 MHz	38.56	36.16
5230 MHz	38.72	36.00



**IEEE 802.11n (40 MHz)/ANT.1/5190 MHz/26 dB and 99% Occupied Bandwidth**



\*RBW 300 kHz Delta 1 [T1 ]  
 \*VBW 1 MHz 0.17 dB  
 \*Att 30 dB  
 SWT 20 ms 38.560000000 MHz

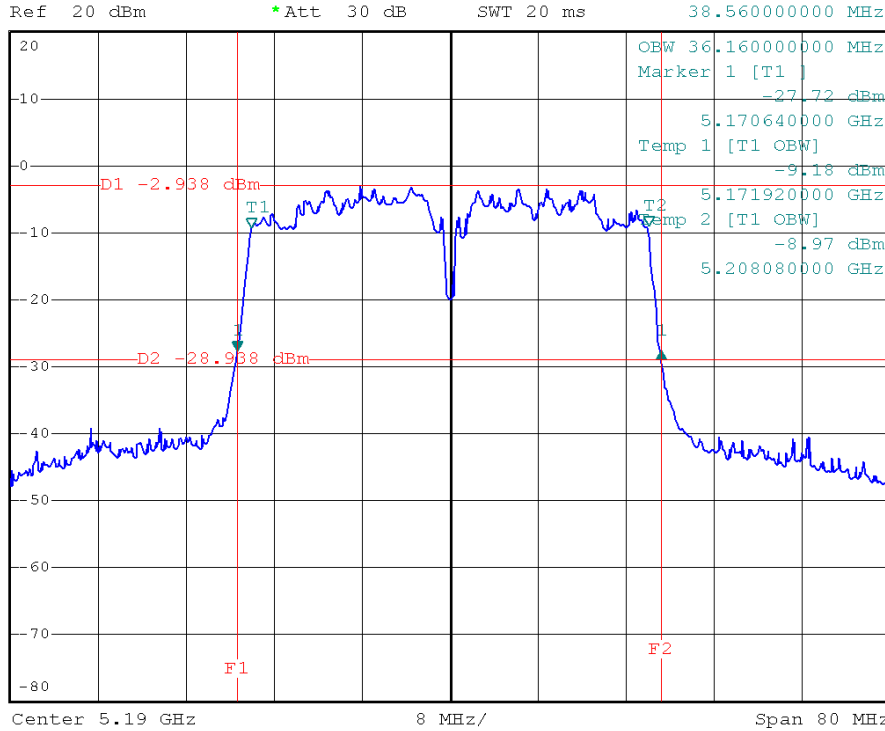

**IEEE 802.11n (40 MHz)/ANT.1/5230 MHz/26 dB and 99% Occupied Bandwidth**



\*RBW 300 kHz Delta 1 [T1 ]  
 \*VBW 1 MHz -0.05 dB  
 \*Att 30 dB  
 SWT 20 ms 38.720000000 MHz

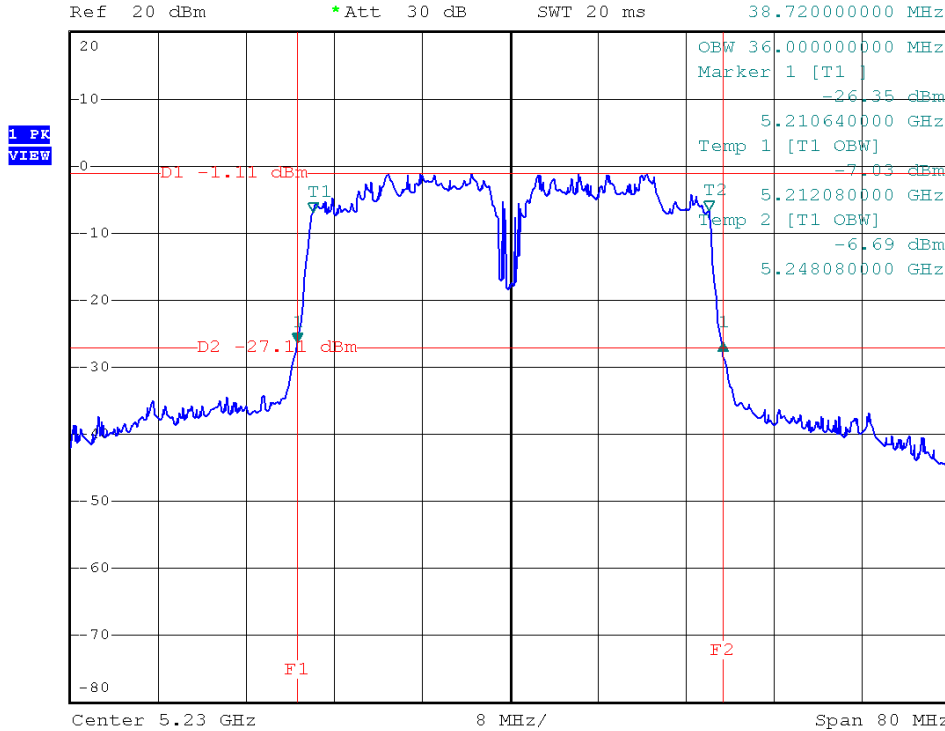



E.U.T	MONDOCENTER	Model Name	INF-MCENTER
Temperature	26°C	Relative Humidity	46%
Test Voltage	AC 120V/60Hz		
Test Mode	IEEE 802.11n (40 MHz)/ANT.2/5190 MHz, 5230 MHz		

Frequency	26 dB Bandwidth (MHz)	99% Occupied Bandwidth (MHz)
5190 MHz	38.72	36.16
5230 MHz	38.88	36.16



**IEEE 802.11n (40 MHz)/ANT.2/5190 MHz/26 dB and 99% Occupied Bandwidth**



\*RBW 300 kHz Delta 1 [T1 ]  
 \*VBW 1 MHz -0.37 dB  
 Ref 20 dBm \*Att 30 dB SWT 20 ms 38.720000000 MHz

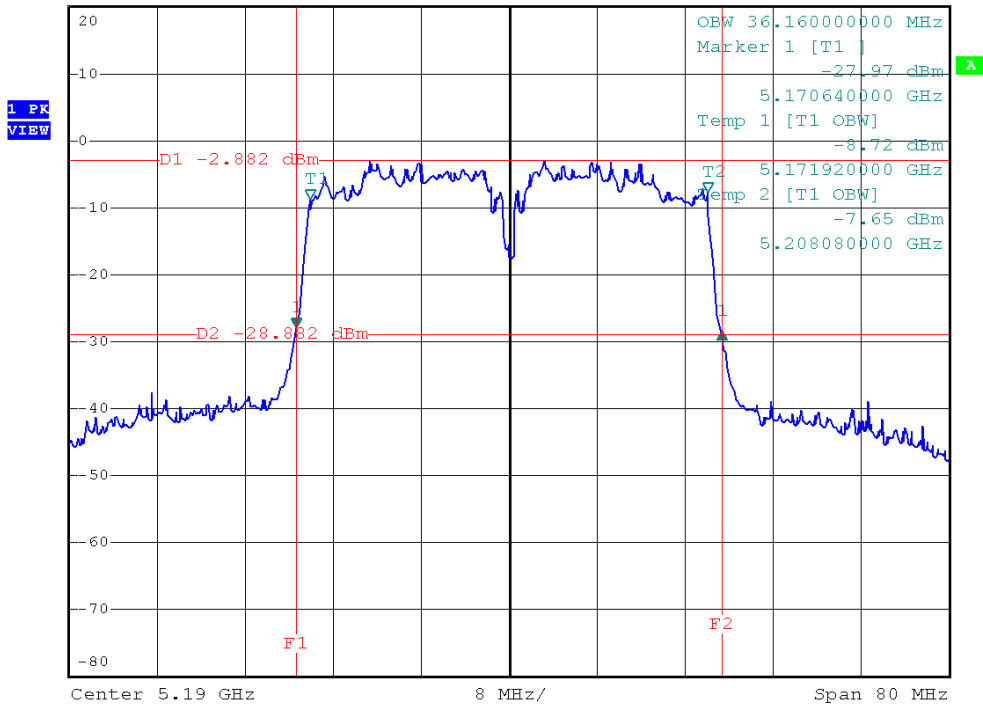

**IEEE 802.11n (40 MHz)/ANT.2/5230 MHz/26 dB and 99% Occupied Bandwidth**



\*RBW 300 kHz Delta 1 [T1 ]  
 \*VBW 1 MHz -0.44 dB  
 Ref 20 dBm \*Att 30 dB SWT 20 ms 38.880000000 MHz

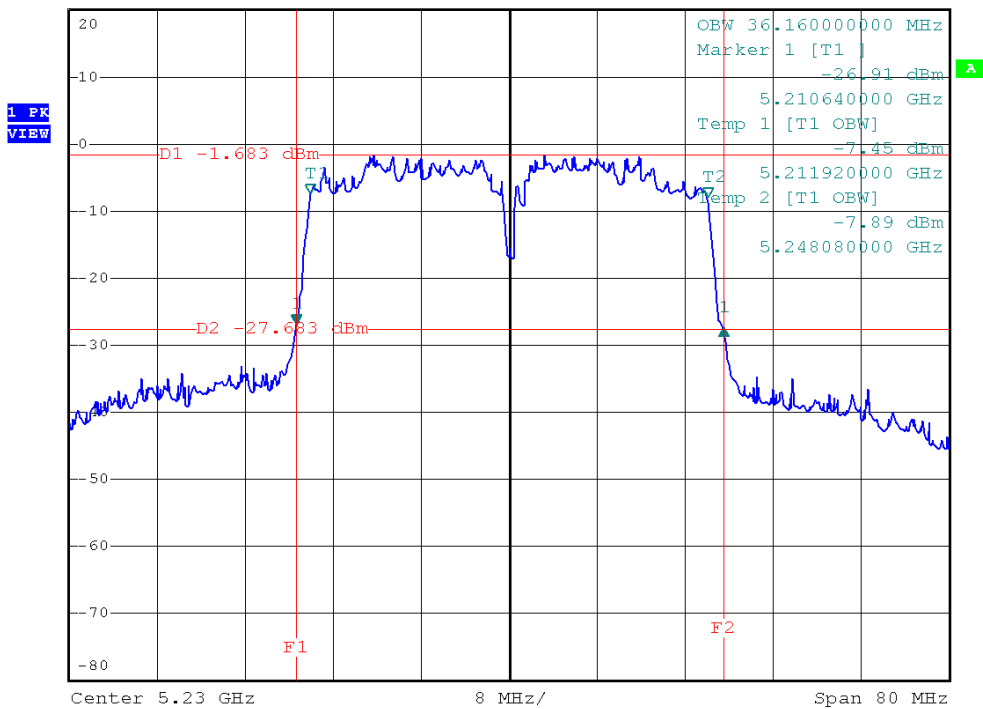



**6.9 TEST RESULTS - 5250-5350 MHZ**

E.U.T	MONDOCENTER	Model Name	INF-MCENTER
Temperature	26°C	Relative Humidity	46%
Test Voltage	AC 120V/60Hz		
Test Mode	IEEE 802.11a/5260 MHz, 5300 MHz, 5320 MHz		

Frequency	26 dB Bandwidth (MHz)	99% Occupied Bandwidth (MHz)
5260 MHz	23.52	16.88
5300 MHz	23.68	17.04
5320 MHz	26.16	16.96

**IEEE 802.11a/5260 MHz/26 dB and 99% Occupied Bandwidth**

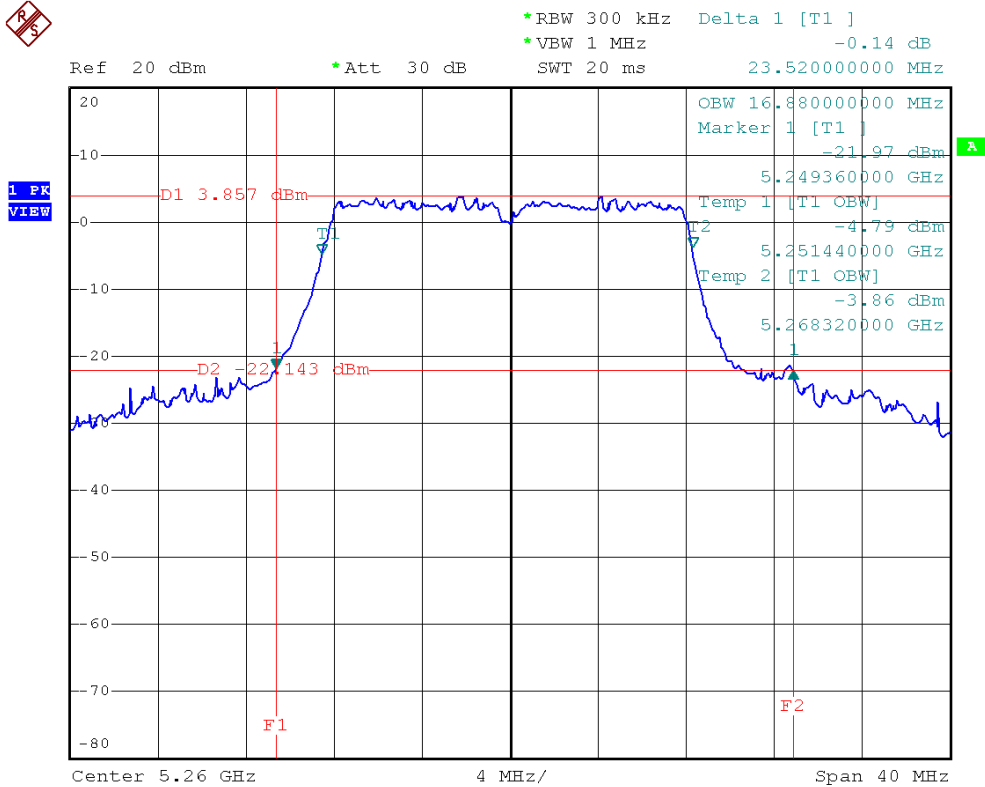



**IEEE 802.11a/5300 MHz/26 dB and 99% Occupied Bandwidth**



\*RBW 300 kHz Delta 1 [T1 ]  
 \*VBW 1 MHz -0.65 dB  
 \*Att 30 dB  
 SWT 20 ms 23.680000000 MHz

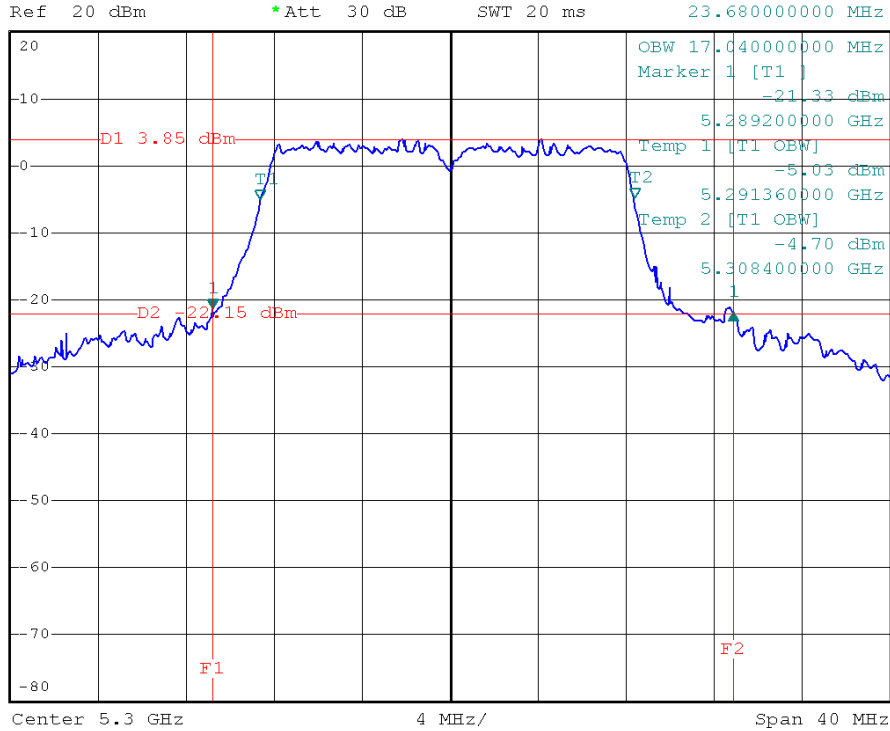

**IEEE 802.11a/5320 MHz/26 dB and 99% Occupied Bandwidth**



\*RBW 300 kHz Delta 1 [T1 ]  
 \*VBW 1 MHz 0.37 dB  
 \*Att 30 dB  
 SWT 20 ms 26.160000000 MHz

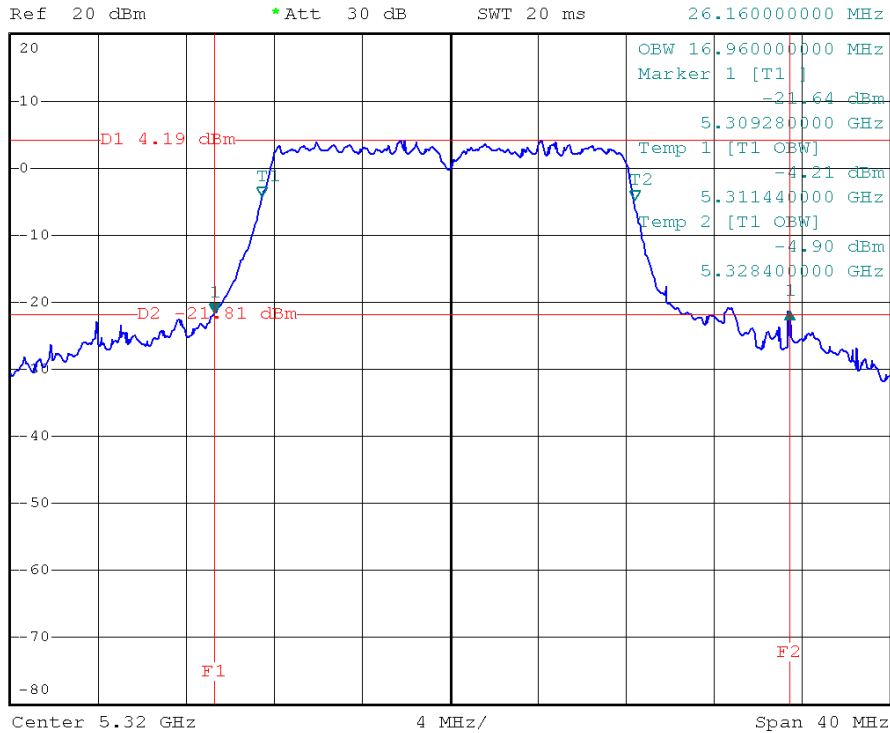



E.U.T	MONDOCENTER	Model Name	INF-MCENTER
Temperature	26°C	Relative Humidity	46%
Test Voltage	AC 120V/60Hz		
Test Mode	IEEE 802.11n (20 MHz)/ANT.1/5260 MHz, 5300 MHz, 5320 MHz		

Frequency	26 dB Bandwidth (MHz)	99% Occupied Bandwidth (MHz)
5260 MHz	20.80	17.92
5300 MHz	20.88	17.92
5320 MHz	20.72	17.92

**IEEE 802.11n (20 MHz)/ANT.1/5260 MHz/26 dB and 99% Occupied Bandwidth**

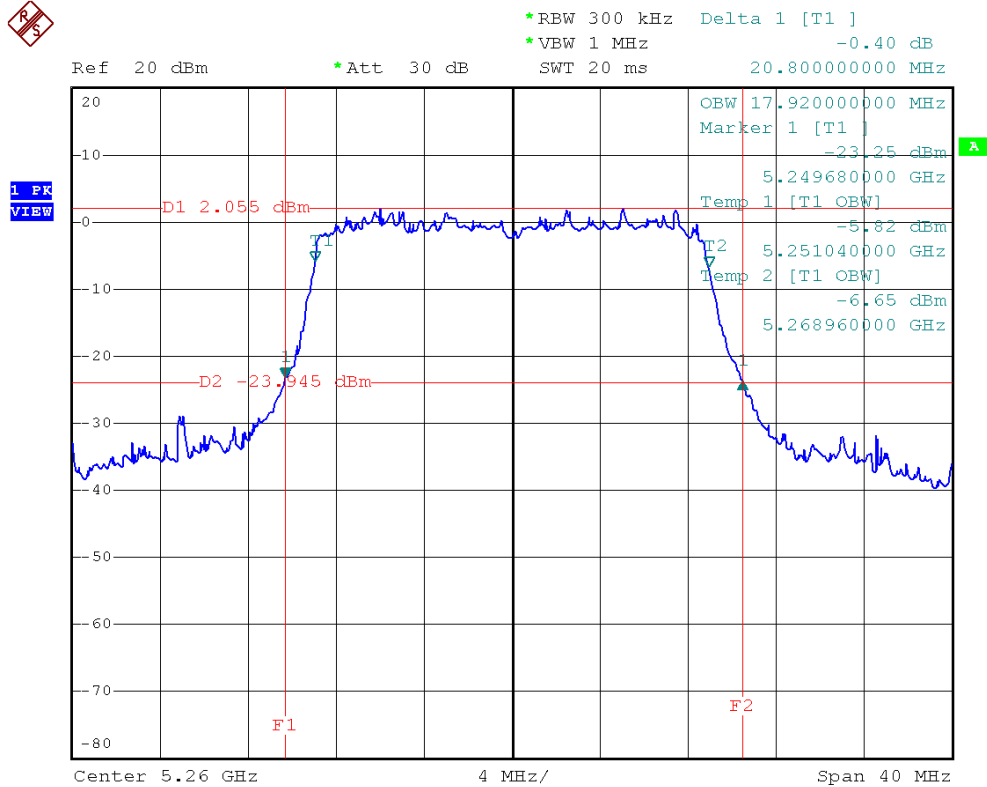





IEEE 802.11n (20 MHz)/ANT.1/5300 MHz/26 dB and 99% Occupied Bandwidth



\*RBW 300 kHz Delta 1 [T1 ]  
 \*VBW 1 MHz 0.63 dB  
 Ref 20 dBm \*Att 30 dB  
 SWT 20 ms 20.880000000 MHz

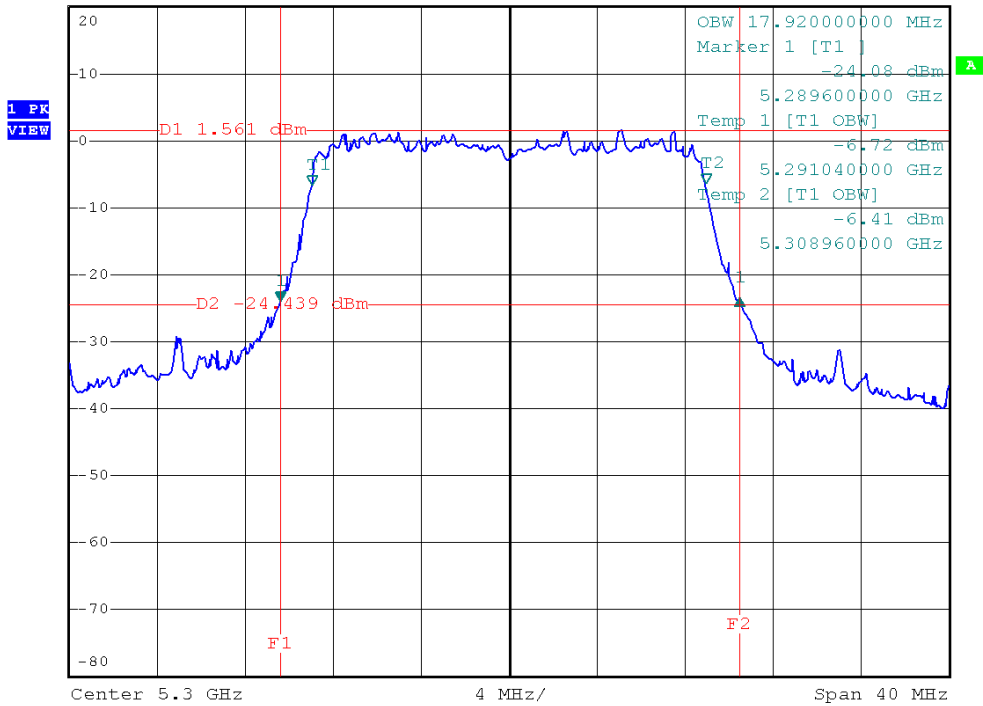

IEEE 802.11n (20 MHz)/ANT.1/5320 MHz/26 dB and 99% Occupied Bandwidth



\*RBW 300 kHz Delta 1 [T1 ]  
 \*VBW 1 MHz -2.04 dB  
 Ref 20 dBm \*Att 30 dB  
 SWT 20 ms 20.720000000 MHz

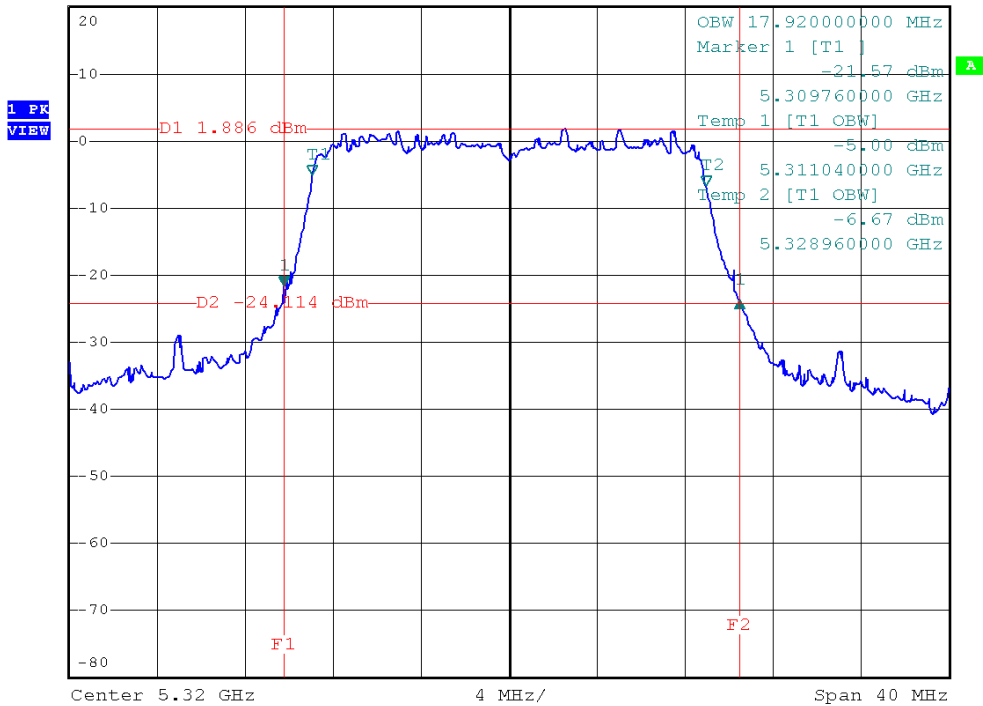



E.U.T	MONDOCENTER	Model Name	INF-MCENTER
Temperature	26°C	Relative Humidity	46%
Test Voltage	AC 120V/60Hz		
Test Mode	IEEE 802.11n (20 MHz)/ANT.2/5260 MHz, 5300 MHz, 5320 MHz		

Frequency	26 dB Bandwidth (MHz)	99% Occupied Bandwidth (MHz)
5260 MHz	21.04	17.92
5300 MHz	20.96	17.92
5320 MHz	21.04	17.92

**IEEE 802.11n (20 MHz)/ANT.2/5260 MHz/26 dB and 99% Occupied Bandwidth**

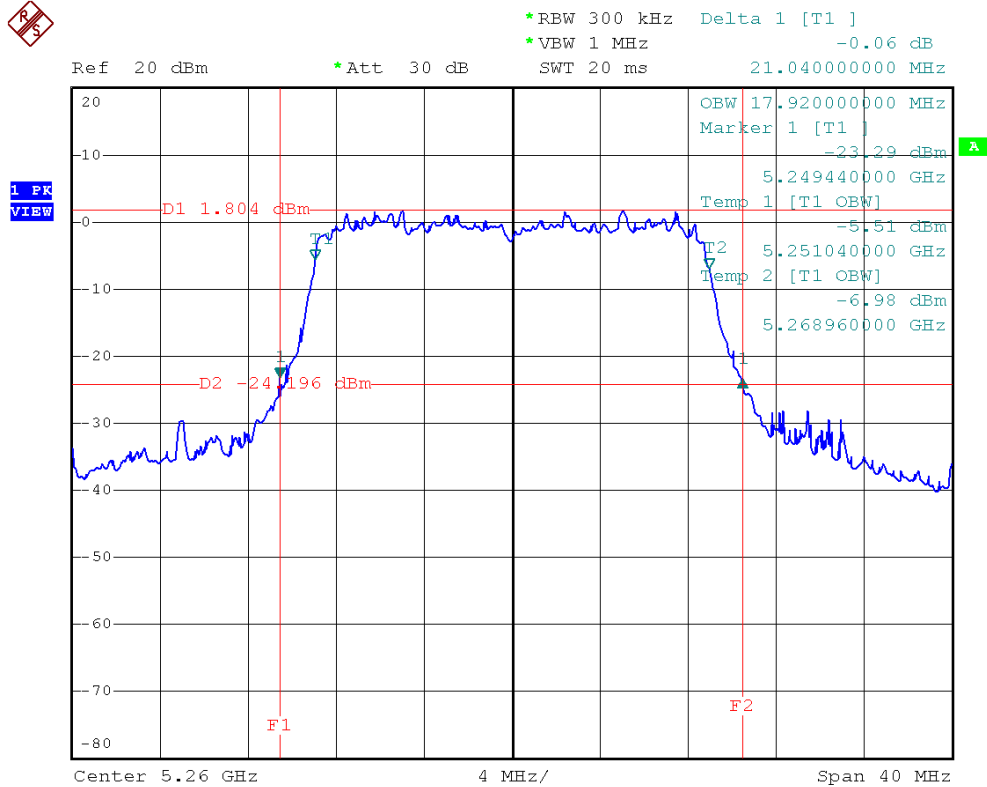



IEEE 802.11n (20 MHz)/ANT.2/5300 MHz/26 dB and 99% Occupied Bandwidth



\*RBW 300 kHz Delta 1 [T1 ]  
 \*VBW 1 MHz 0.18 dB  
 \*Att 30 dB  
 SWT 20 ms 20.960000000 MHz

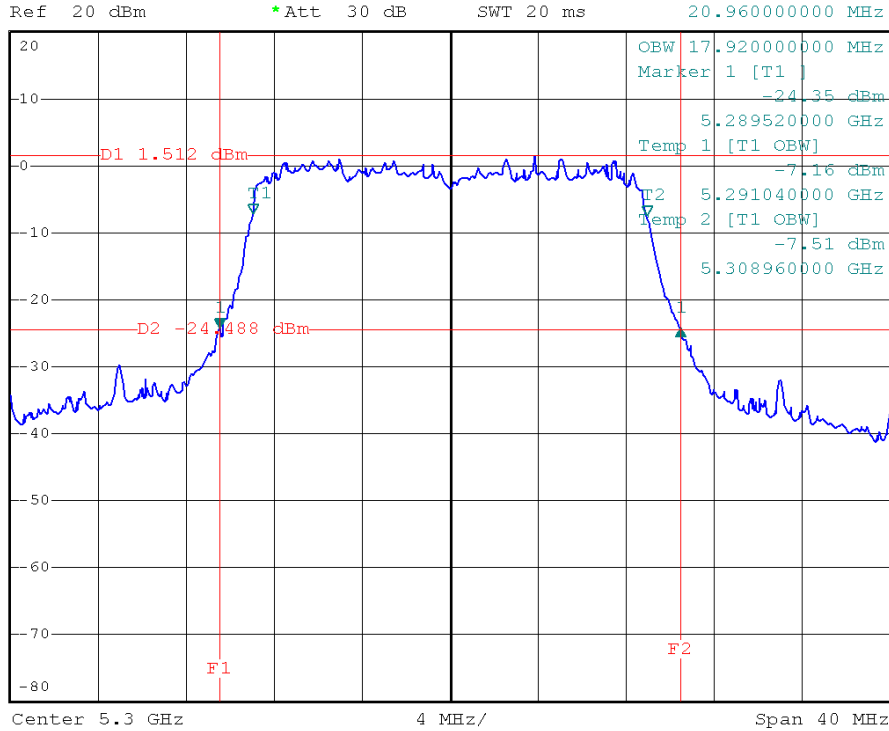

IEEE 802.11n (20 MHz)/ANT.2/5320 MHz/26 dB and 99% Occupied Bandwidth



\*RBW 300 kHz Delta 1 [T1 ]  
 \*VBW 1 MHz 0.63 dB  
 \*Att 30 dB  
 SWT 20 ms 21.040000000 MHz

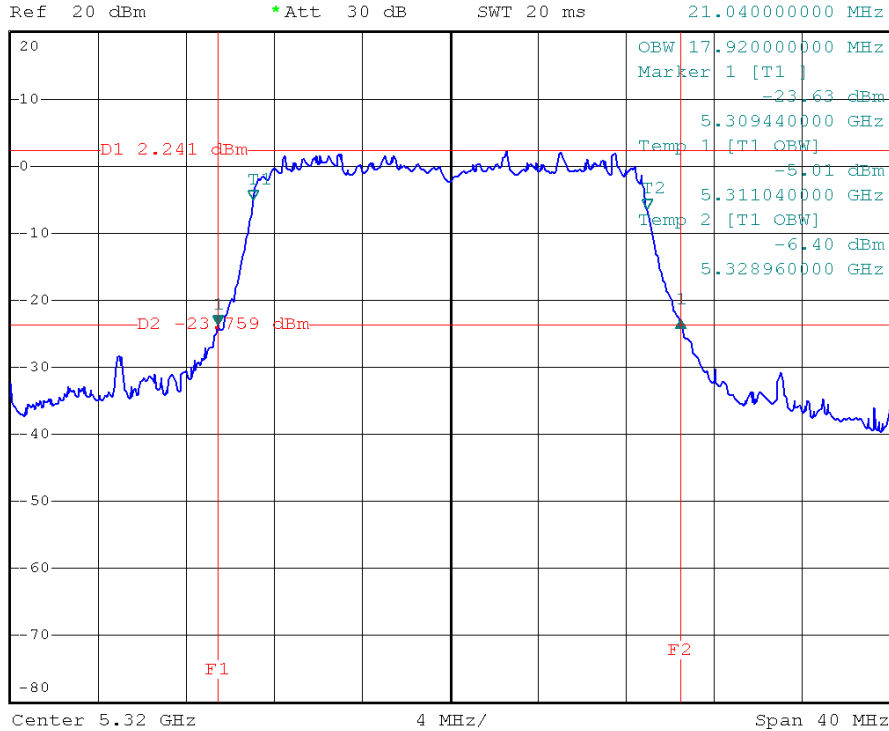



E.U.T	MONDOCENTER	Model Name	INF-MCENTER
Temperature	26°C	Relative Humidity	46%
Test Voltage	AC 120V/60Hz		
Test Mode	IEEE 802.11n (40 MHz)/ANT.1/5270 MHz, 5310 MHz		

Frequency	26 dB Bandwidth (MHz)	99% Occupied Bandwidth (MHz)
5270 MHz	38.56	36.16
5310 MHz	38.56	36.16



**IEEE 802.11n (40 MHz)/ANT.1/5270 MHz/26 dB and 99% Occupied Bandwidth**



\*RBW 300 kHz Delta 1 [T1 ]  
 \*VBW 1 MHz -1.38 dB  
 \*Att 30 dB  
 SWT 20 ms 38.560000000 MHz

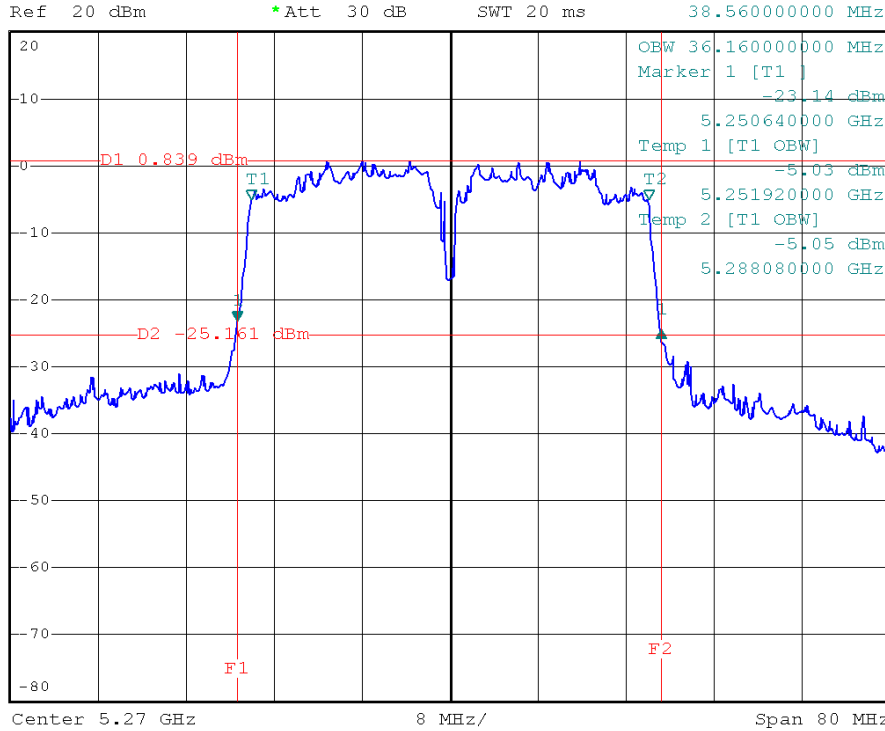

**IEEE 802.11n (40 MHz)/ANT.1/5310 MHz/26 dB and 99% Occupied Bandwidth**



\*RBW 300 kHz Delta 1 [T1 ]  
 \*VBW 1 MHz 1.78 dB  
 \*Att 30 dB  
 SWT 20 ms 38.560000000 MHz

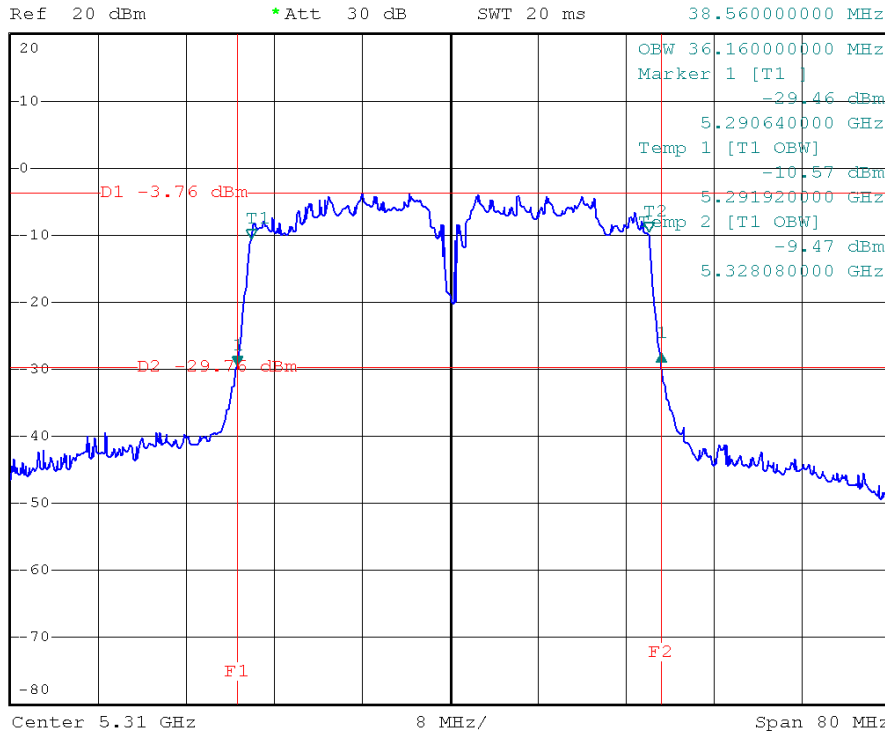



E.U.T	MONDOCENTER	Model Name	INF-MCENTER
Temperature	26°C	Relative Humidity	46%
Test Voltage	AC 120V/60Hz		
Test Mode	IEEE 802.11n (40 MHz)/ANT.2/5270 MHz, 5310 MHz		

Frequency	26 dB Bandwidth (MHz)	99% Occupied Bandwidth (MHz)
5270 MHz	38.88	36.16
5310 MHz	38.56	36.16



IEEE 802.11n (40 MHz)/ANT.2/5270 MHz/26 dB and 99% Occupied Bandwidth



\*RBW 300 kHz Delta 1 [T1 ]  
 \*VBW 1 MHz 0.11 dB  
 Ref 20 dBm \*Att 30 dB SWT 20 ms 38.880000000 MHz

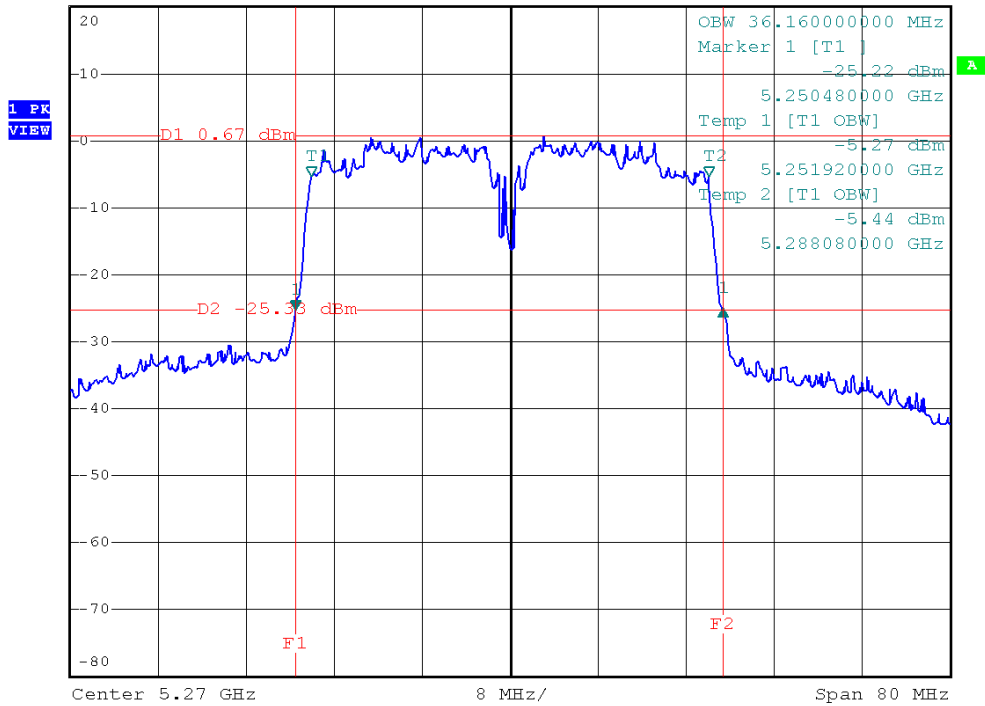

IEEE 802.11n (40 MHz)/ANT.2/5310 MHz/26 dB and 99% Occupied Bandwidth



\*RBW 300 kHz Delta 1 [T1 ]  
 \*VBW 1 MHz 1.04 dB  
 Ref 20 dBm \*Att 30 dB SWT 20 ms 38.560000000 MHz

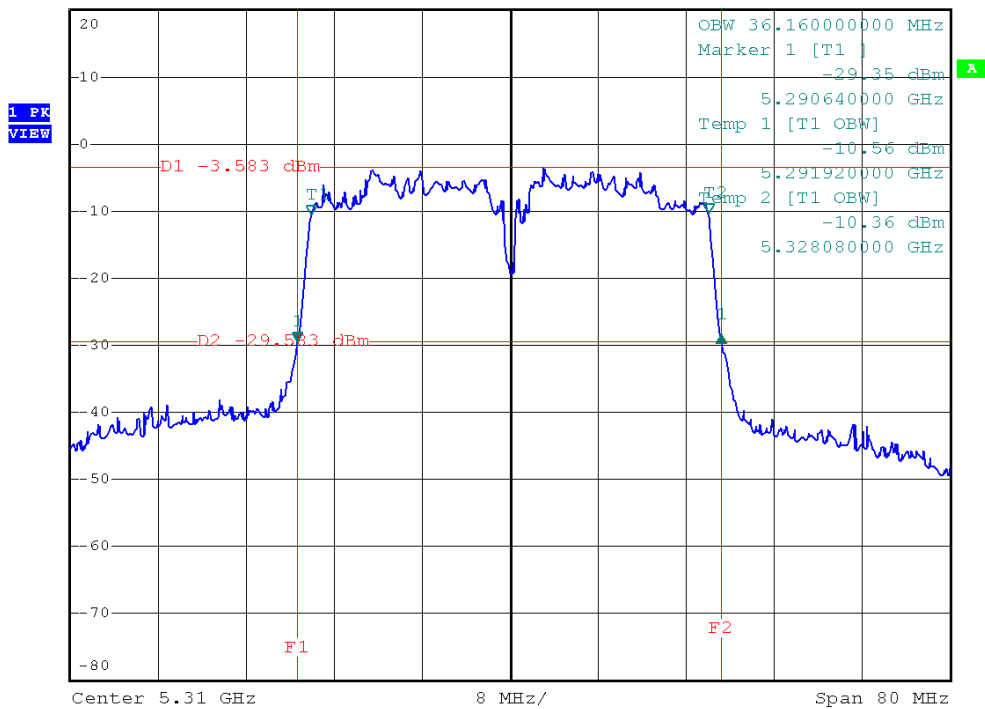



**6.10 TEST RESULTS - 5470-5725 MHZ**

E.U.T	MONDOCENTER	Model Name	INF-MCENTER
Temperature	26°C	Relative Humidity	46%
Test Voltage	AC 120V/60Hz		
Test Mode	IEEE 802.11a/5500 MHz, 5580 MHz, 5700 MHz		

Frequency	26 dB Bandwidth (MHz)	99% Occupied Bandwidth (MHz)
5500 MHz	21.20	16.88
5580 MHz	23.60	16.88
5700 MHz	28.80	17.04

**IEEE 802.11a/5500 MHz/26 dB and 99% Occupied Bandwidth**

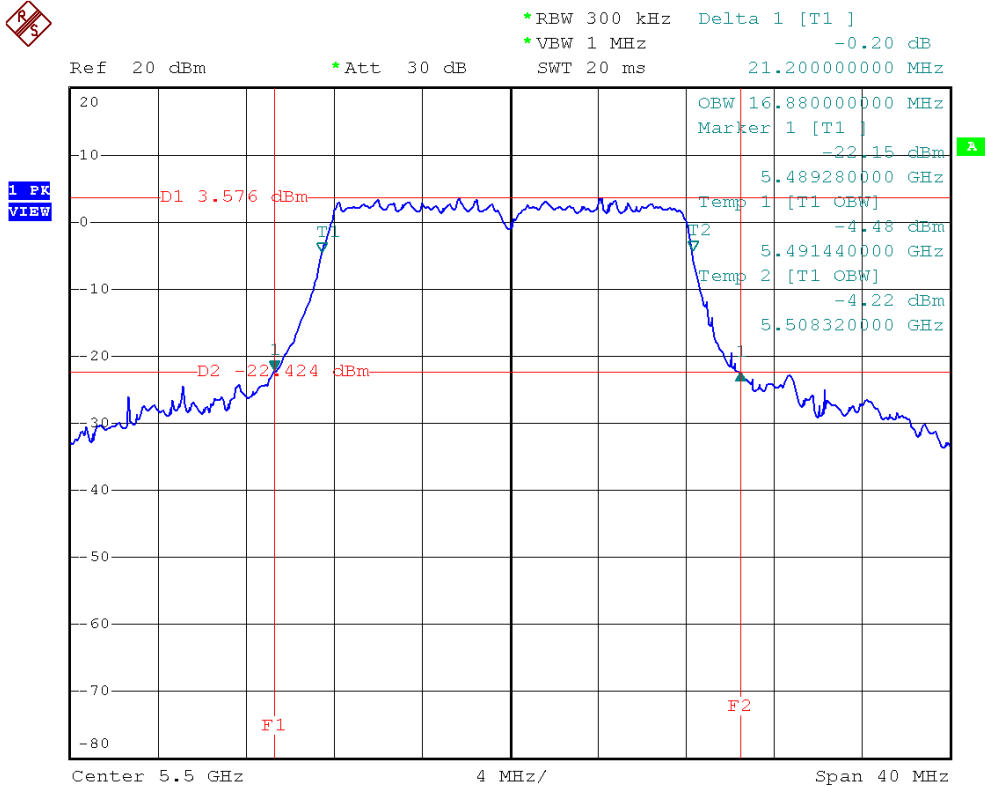





### IEEE 802.11a/5580 MHz/26 dB and 99% Occupied Bandwidth



\*RBW 300 kHz Delta 1 [T1 ]  
\*VBW 1 MHz 0.18 dB  
SWT 20 ms 23.600000000 MHz

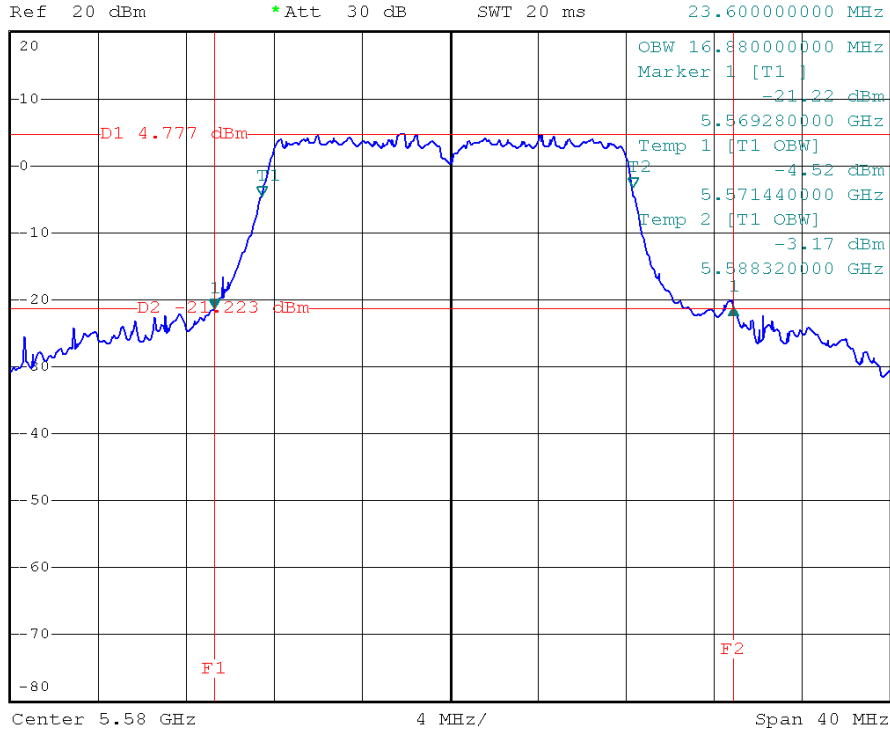

### IEEE 802.11a/5700 MHz/26 dB and 99% Occupied Bandwidth



\*RBW 300 kHz Delta 1 [T1 ]  
\*VBW 1 MHz -0.33 dB  
SWT 20 ms 28.800000000 MHz

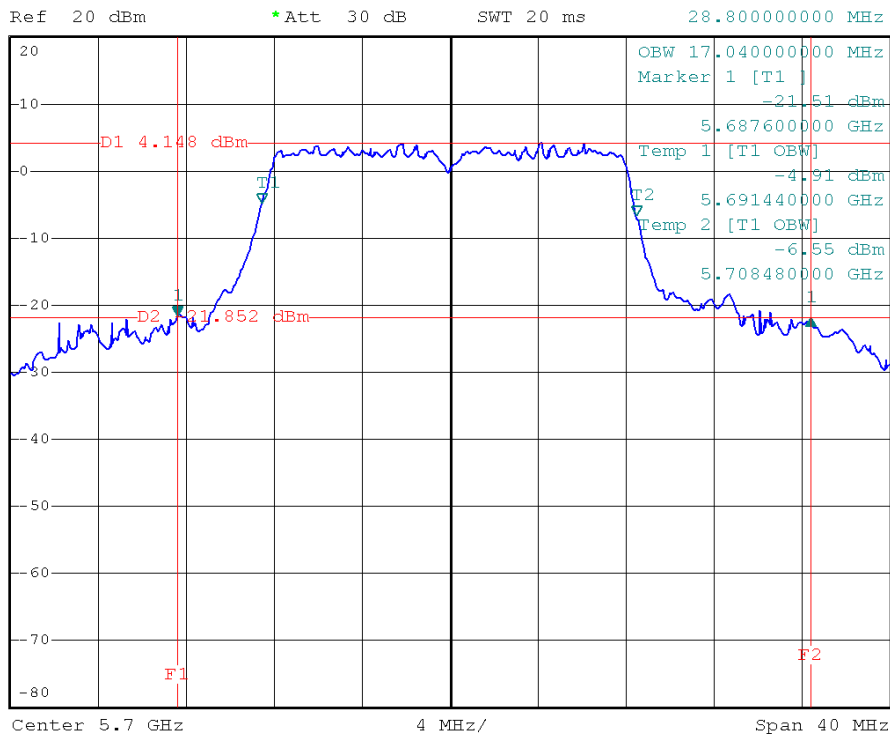



E.U.T	MONDOCENTER	Model Name	INF-MCENTER
Temperature	26°C	Relative Humidity	46%
Test Voltage	AC 120V/60Hz		
Test Mode	IEEE 802.11n (20 MHz)/ANT.1/5500 MHz, 5580 MHz, 5700 MHz		

Frequency	26 dB Bandwidth (MHz)	99% Occupied Bandwidth (MHz)
5500 MHz	20.96	17.84
5580 MHz	20.88	17.92
5700 MHz	20.88	17.92

**IEEE 802.11n (20 MHz)/ANT.1/5500 MHz/26 dB and 99% Occupied Bandwidth**

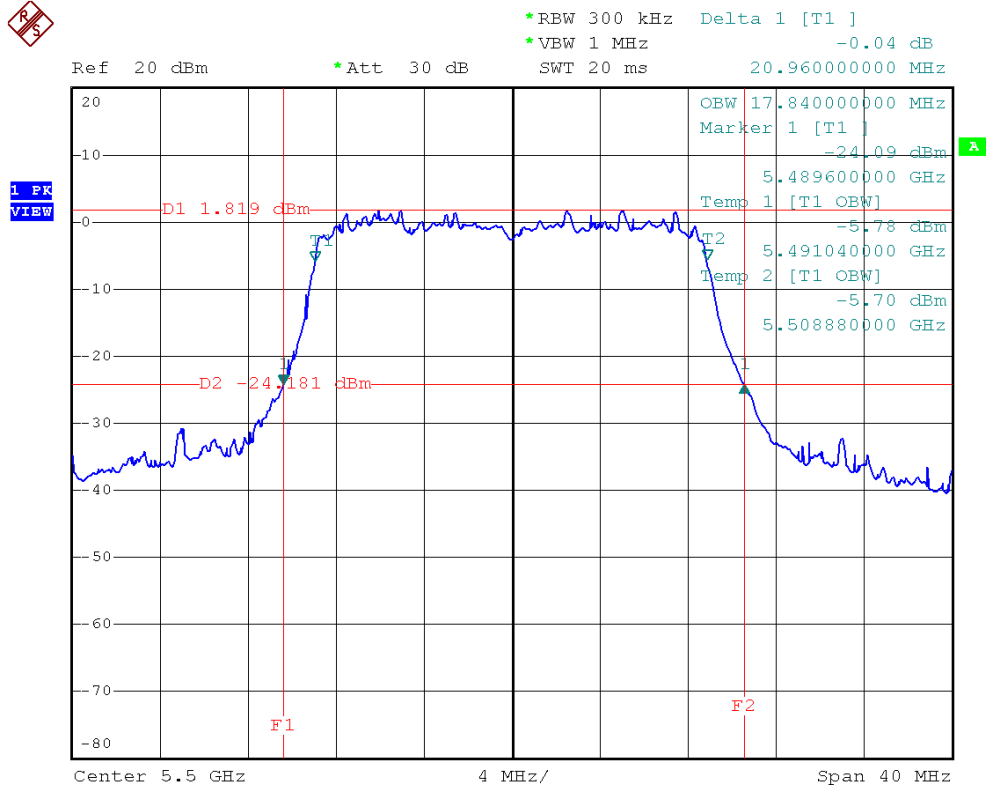



**IEEE 802.11n (20 MHz)/ANT.1/5580 MHz/26 dB and 99% Occupied Bandwidth**



\*RBW 300 kHz Delta 1 [T1 ]  
 \*VBW 1 MHz -0.02 dB  
 Ref 20 dBm \*Att 30 dB SWT 20 ms 20.880000000 MHz

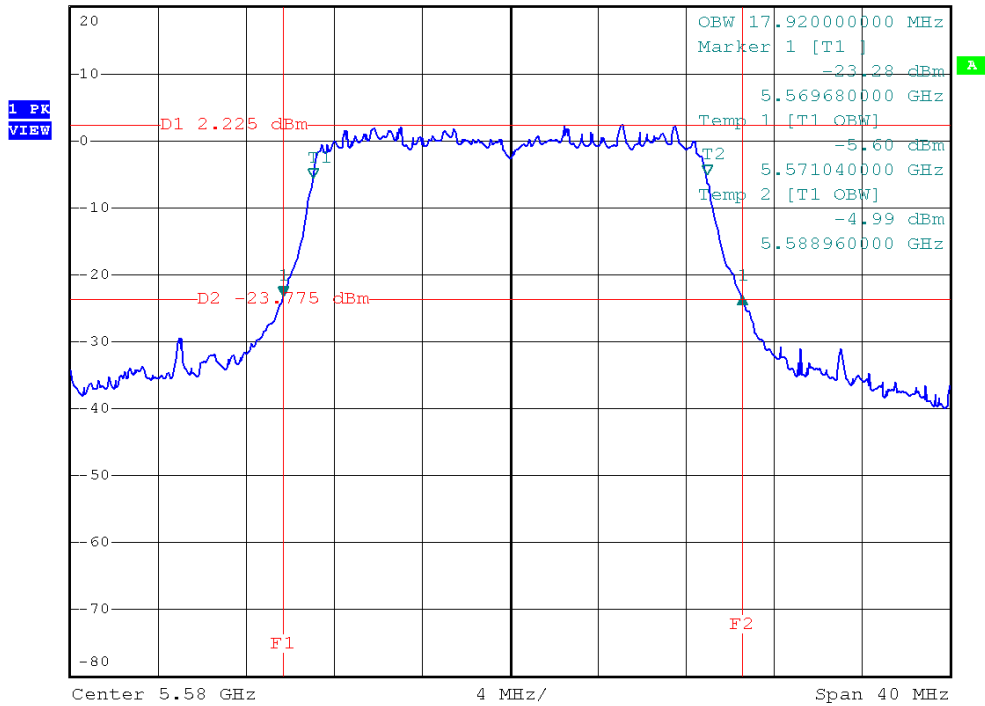

**IEEE 802.11n (20 MHz)/ANT.1/5700 MHz/26 dB and 99% Occupied Bandwidth**



\*RBW 300 kHz Delta 1 [T1 ]  
 \*VBW 1 MHz -0.98 dB  
 Ref 20 dBm \*Att 30 dB SWT 20 ms 20.880000000 MHz

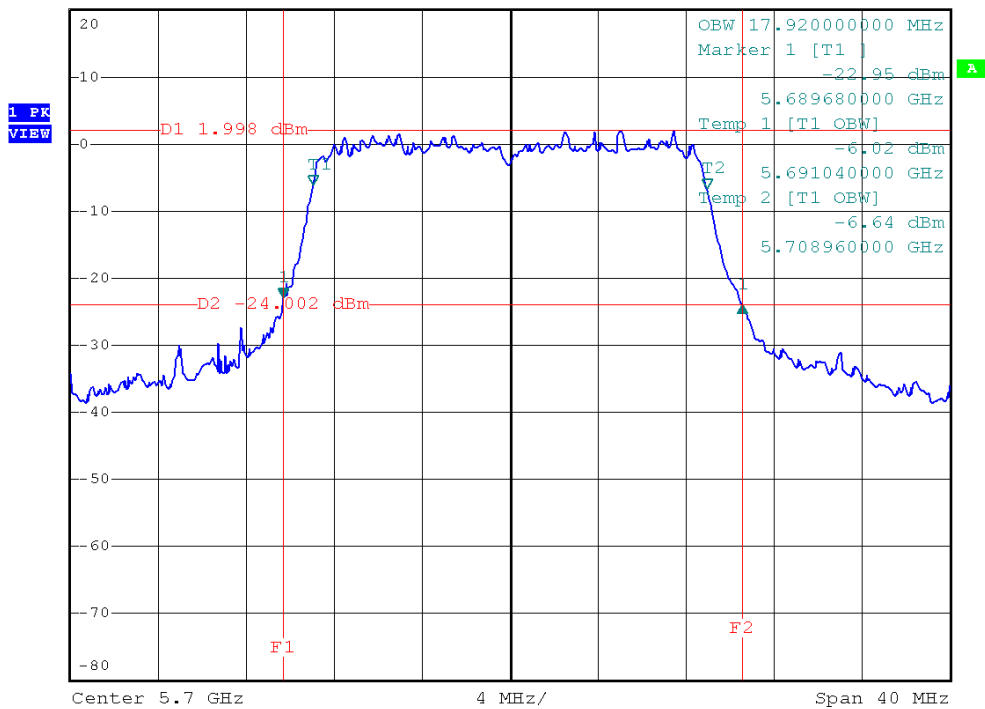



E.U.T	MONDOCENTER	Model Name	INF-MCENTER
Temperature	26°C	Relative Humidity	46%
Test Voltage	AC 120V/60Hz		
Test Mode	IEEE 802.11n (20 MHz)/ANT.2/5500 MHz, 5580 MHz, 5700 MHz		

Frequency	26 dB Bandwidth (MHz)	99% Occupied Bandwidth (MHz)
5500 MHz	20.88	17.92
5580 MHz	21.12	17.92
5700 MHz	20.88	17.84

**IEEE 802.11n (20 MHz)/ANT.2/5500 MHz/26 dB and 99% Occupied Bandwidth**

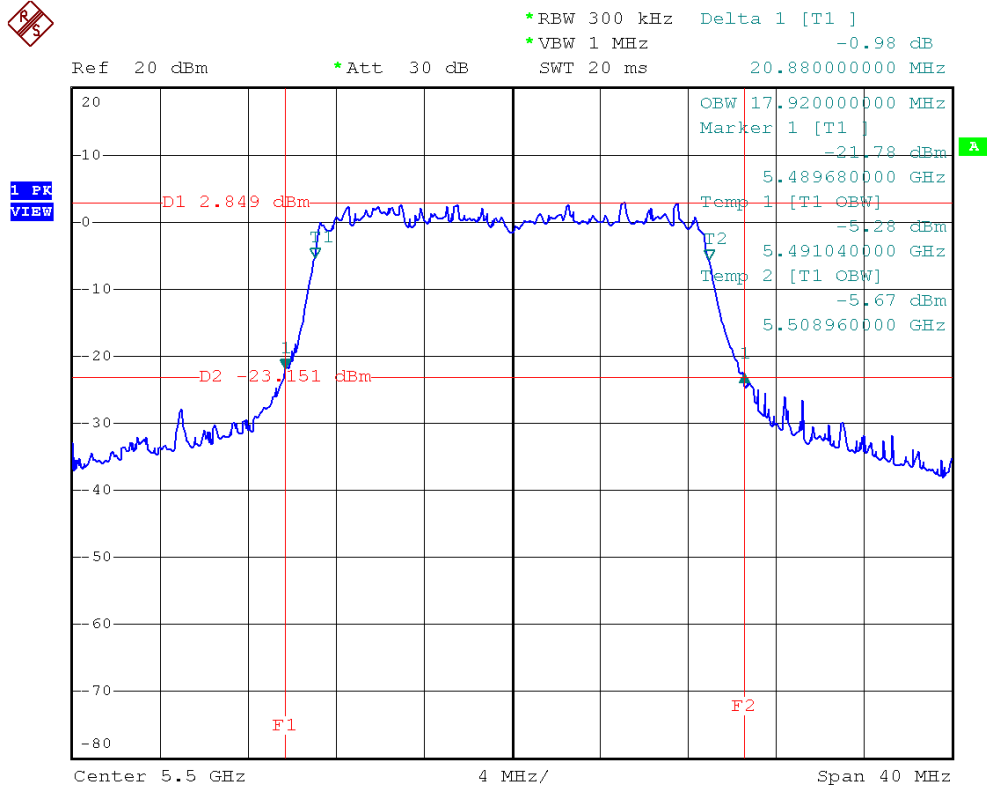



IEEE 802.11n (20 MHz)/ANT.2/5580 MHz/26 dB and 99% Occupied Bandwidth



\*RBW 300 kHz Delta 1 [T1 ]  
 \*VBW 1 MHz 0.60 dB  
 Ref 20 dBm \*Att 30 dB  
 SWT 20 ms 21.120000000 MHz

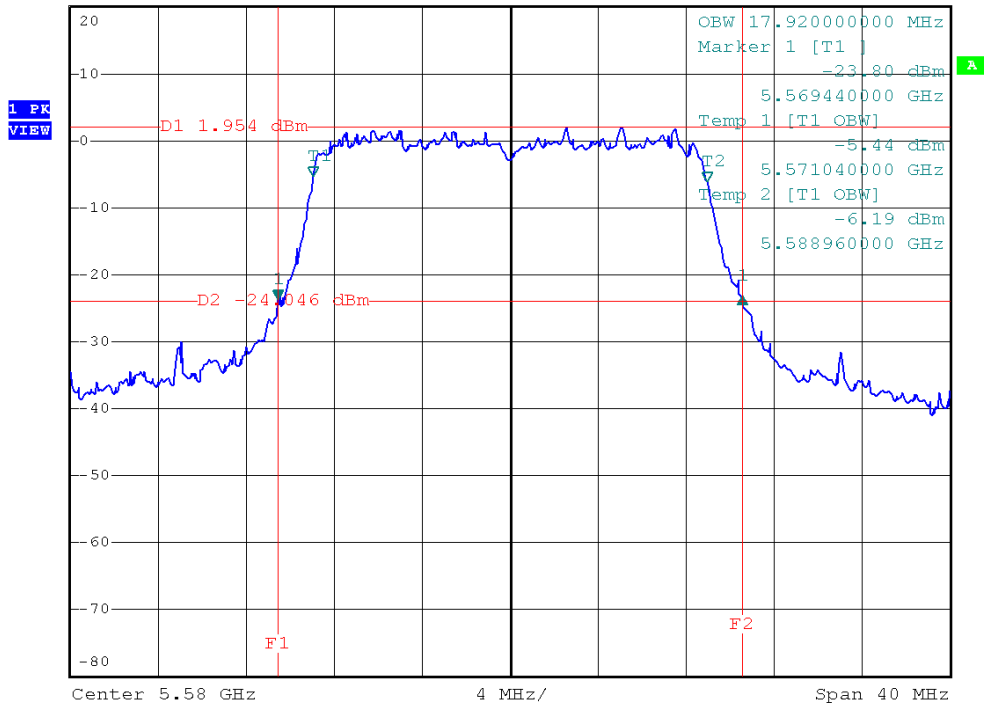

IEEE 802.11n (20 MHz)/ANT.2/5700 MHz/26 dB and 99% Occupied Bandwidth



\*RBW 300 kHz Delta 1 [T1 ]  
 \*VBW 1 MHz -0.55 dB  
 Ref 20 dBm \*Att 30 dB  
 SWT 20 ms 20.880000000 MHz

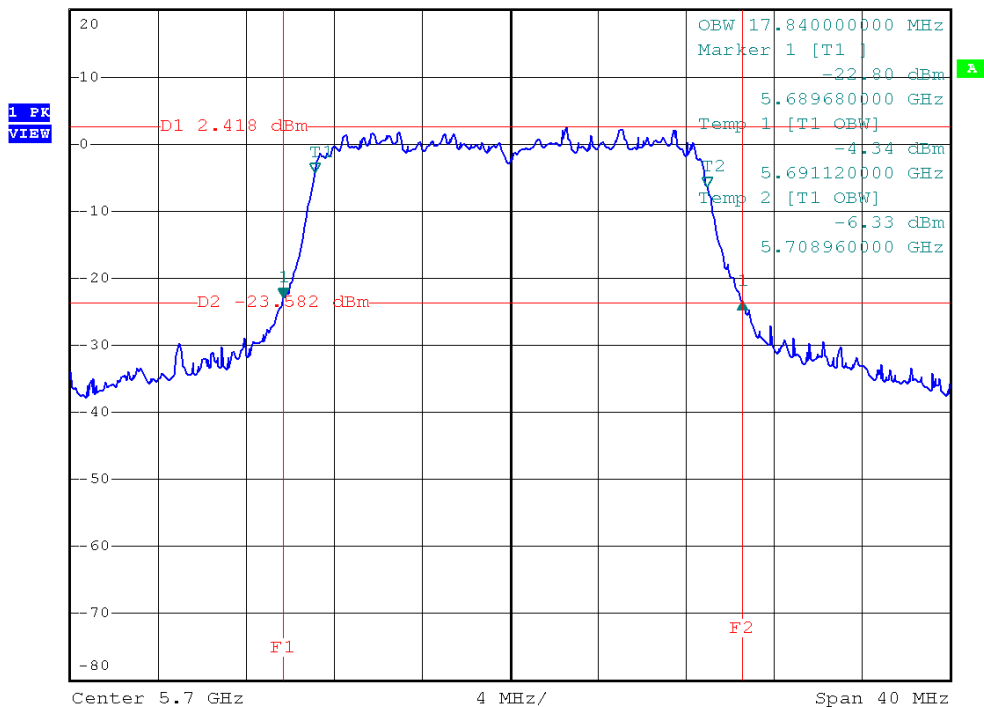



E.U.T	MONDOCENTER	Model Name	INF-MCENTER
Temperature	26°C	Relative Humidity	46%
Test Voltage	AC 120V/60Hz		
Test Mode	IEEE 802.11n (40 MHz)/ANT.1/5510 MHz, 5550 MHz, 5670 MHz		

Frequency	26 dB Bandwidth (MHz)	99% Occupied Bandwidth (MHz)
5510 MHz	28.88	36.16
5550 MHz	38.56	36.00
5670 MHz	38.56	36.16

**IEEE 802.11n (40 MHz)/ANT.1/5510 MHz/26 dB and 99% Occupied Bandwidth**

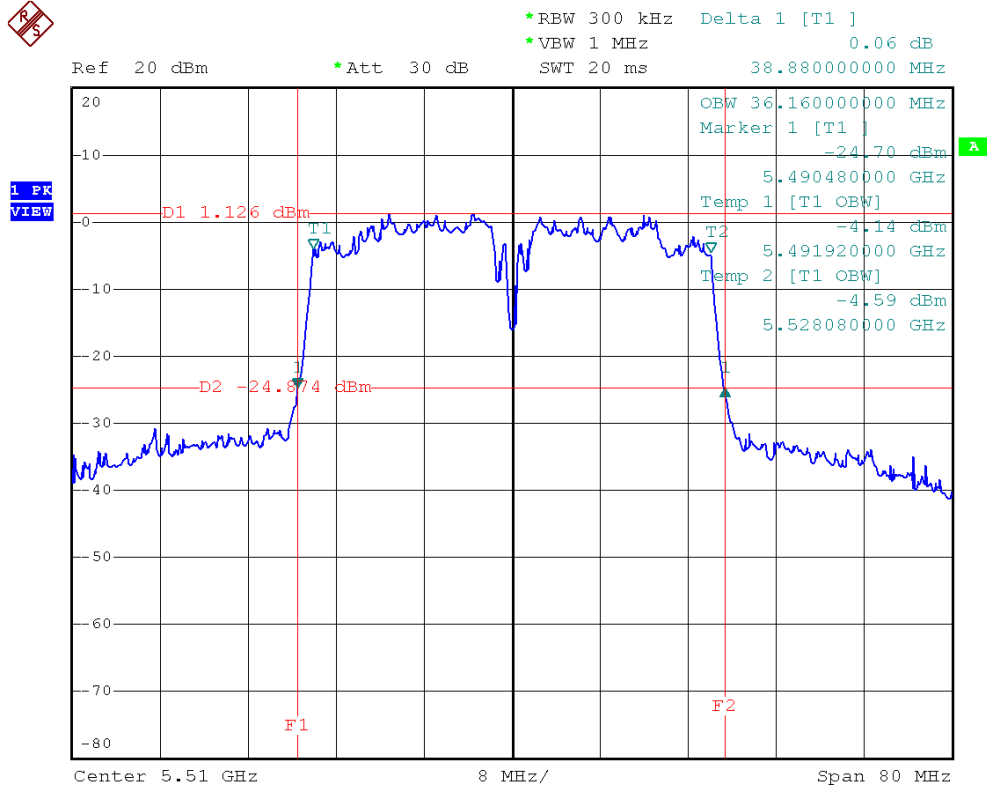



### IEEE 802.11n (40 MHz)/ANT.1/5550 MHz/26 dB and 99% Occupied Bandwidth



\*RBW 300 kHz Delta 1 [T1 ]  
\*VBW 1 MHz -0.80 dB  
SWT 20 ms 38.560000000 MHz

Ref 20 dBm

\*Att 30 dB

1 PK  
VIEW

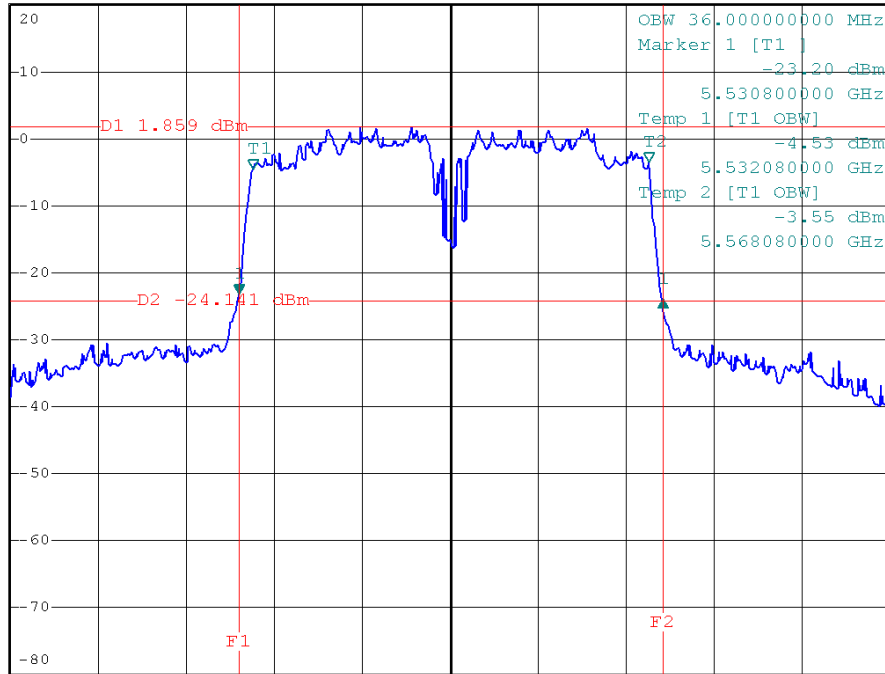

Center 5.55 GHz

8 MHz/

Span 80 MHz

### IEEE 802.11n (40 MHz)/ANT.1/5670 MHz/26 dB and 99% Occupied Bandwidth



\*RBW 300 kHz Delta 1 [T1 ]  
\*VBW 1 MHz 0.03 dB  
SWT 20 ms 38.560000000 MHz

Ref 20 dBm

\*Att 30 dB

1 PK  
VIEW

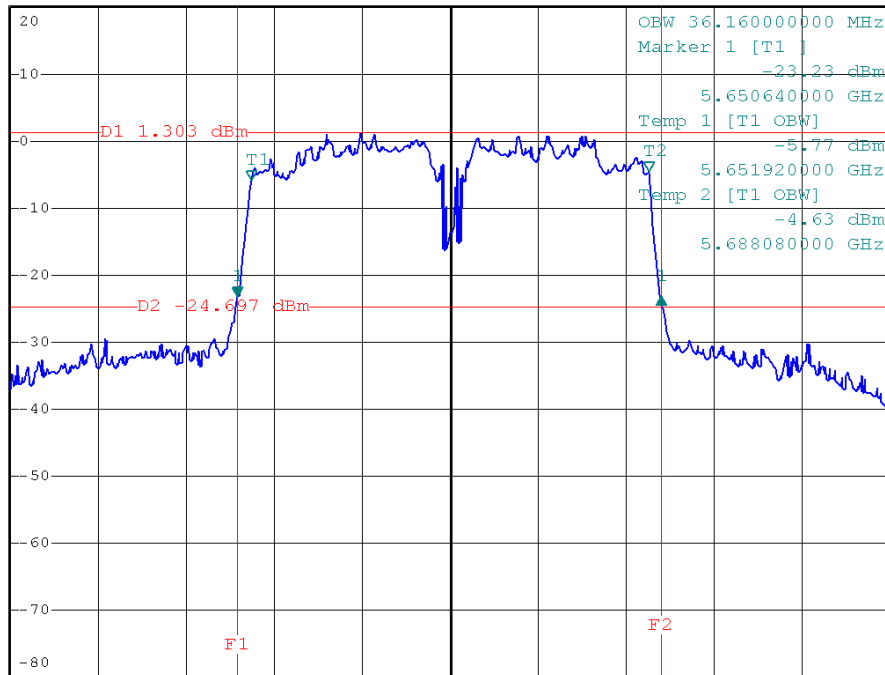

Center 5.67 GHz

8 MHz/

Span 80 MHz



E.U.T	MONDOCENTER	Model Name	INF-MCENTER
Temperature	26°C	Relative Humidity	46%
Test Voltage	AC 120V/60Hz		
Test Mode	IEEE 802.11n (40 MHz)/ANT.2/5510 MHz, 5550 MHz, 5670 MHz		

Frequency	26 dB Bandwidth (MHz)	99% Occupied Bandwidth (MHz)
5510 MHz	38.40	36.00
5550 MHz	38.56	36.16
5670 MHz	38.56	36.16

**IEEE 802.11n (40 MHz)/ANT.2/5510 MHz/26 dB and 99% Occupied Bandwidth**

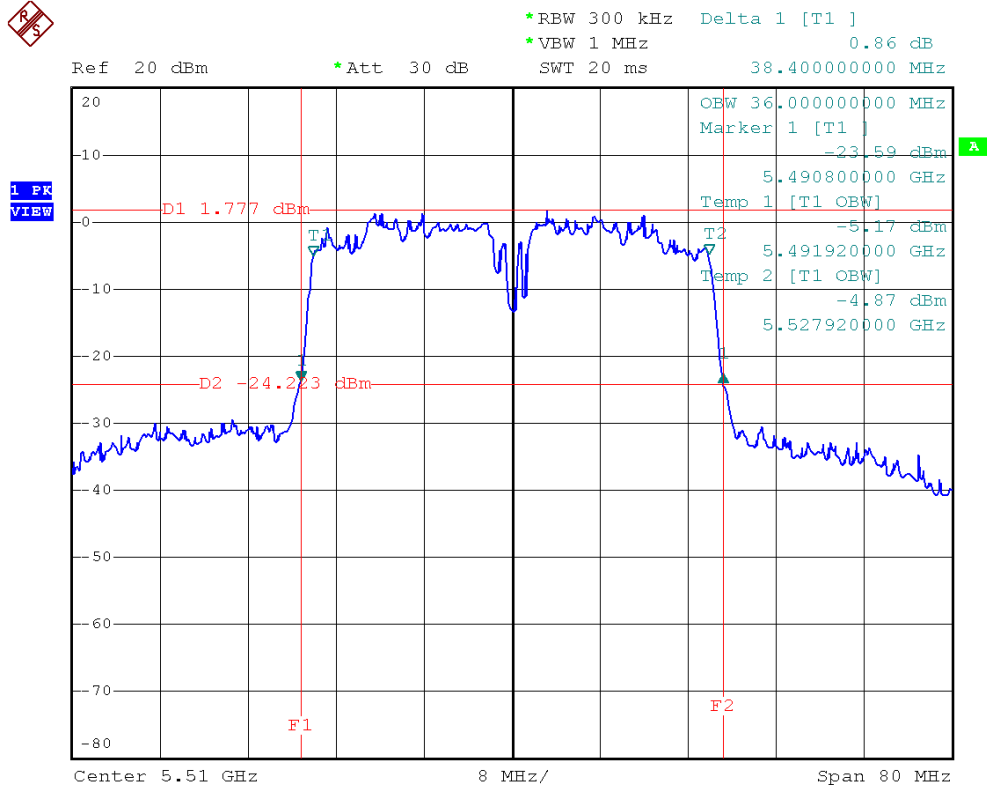





IEEE 802.11n (40 MHz)/ANT.2/5550 MHz/26 dB and 99% Occupied Bandwidth



\*RBW 300 kHz Delta 1 [T1 ]  
 \*VBW 1 MHz -0.72 dB  
 Ref 20 dBm \*Att 30 dB SWT 20 ms 38.560000000 MHz

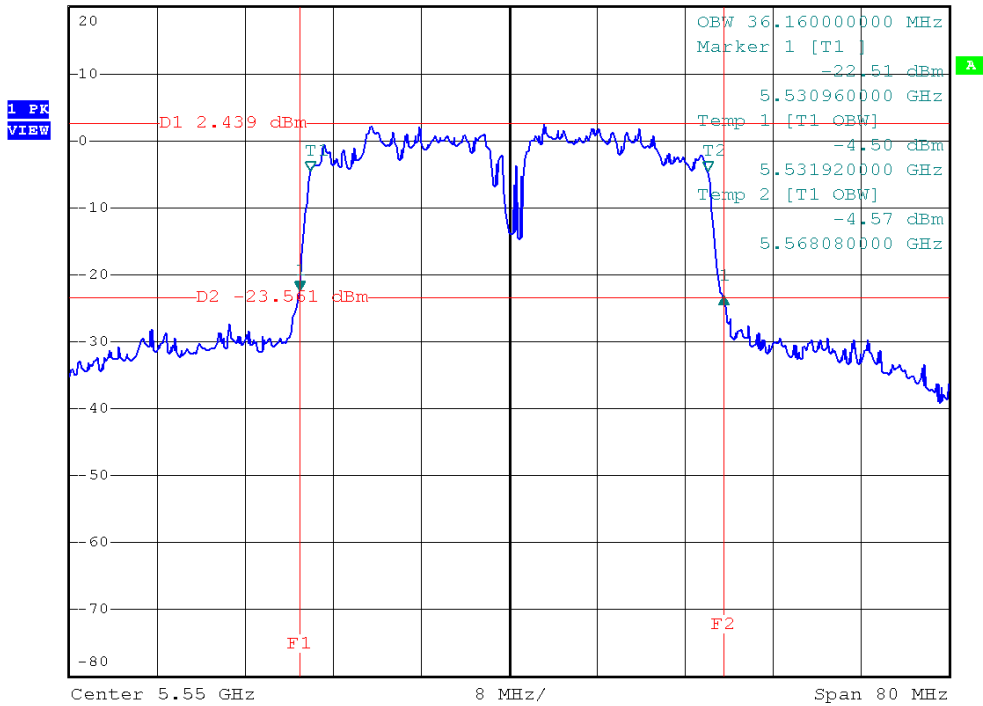

IEEE 802.11n (40 MHz)/ANT.2/5670 MHz/26 dB and 99% Occupied Bandwidth



\*RBW 300 kHz Delta 1 [T1 ]  
 \*VBW 1 MHz -0.05 dB  
 Ref 20 dBm \*Att 30 dB SWT 20 ms 38.560000000 MHz

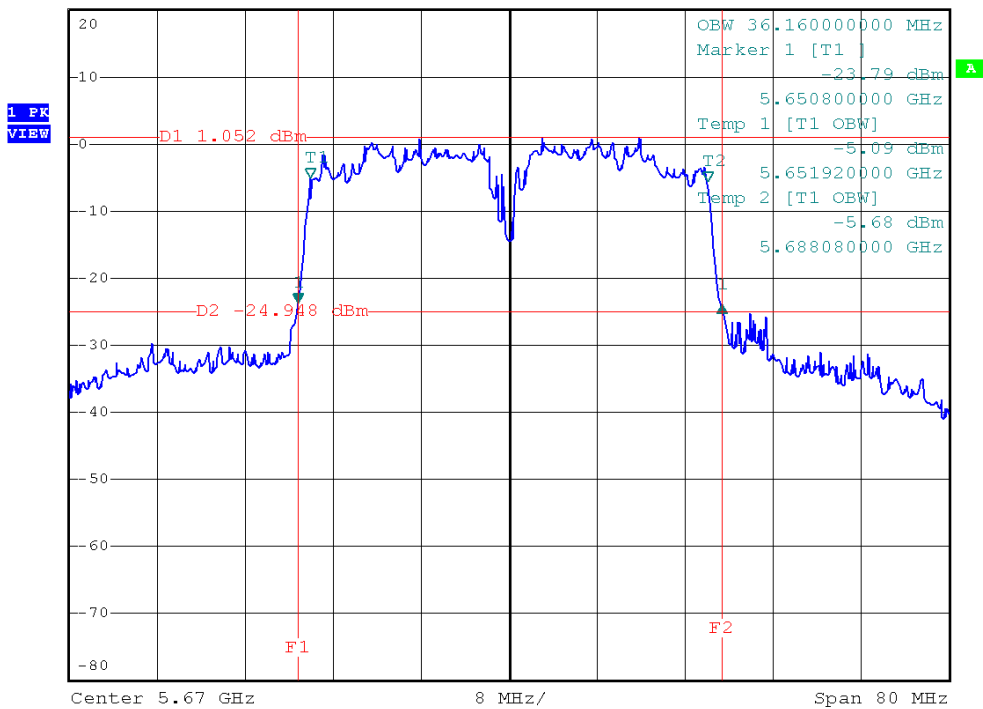



**7 MAXIMUM PEAK CONDUCTED OUTPUT POWER**

**7.1 LIMIT**

Test Item	Frequency Range (MHz)	Limit
Maximum Peak Conducted Output Power	5150 - 5250	not exceed the lesser of 50 mW (17dBm) or 4 dBm + 10log B
	5250 - 5350	not exceed the lesser of 250 mW (24dBm) or 11 dBm + 10log B
	5470 - 5725	not exceed the lesser of 250 mW (24dBm) or 11 dBm + 10log B
	5725 - 5825	not exceed the lesser of 1 W (30dBm) or 17 dBm + 10log B.

**7.2 MEASUREMENT INSTRUMENTS LIST**

Item	Kind of Equipment	Manufacturer	Type No.	Serial No.	Calibrated until
1	Spectrum Analyzer	R&S	FSP-40	100129	Oct. 06, 2012

NOTE: **N/A**: denotes No Model Name, No Serial No. or No Calibration specified.

**7.3 MEASURING INSTRUMENTS SETTING**

Spectrum Analyzer	Parameter Setting
Attenuation	Auto
Span Frequency	Encompass the entire emissions bandwidth (EBW) of the signal
RB	1000 kHz
VB	300 kHz
Detector	Sample
Trace	Max Hold
Sweep Time	60s

**7.4 TEST PROCEDURES**

- a. The EUT was directly connected to the spectrum analyzer and antenna output port as show in the block diagram below.
- b. Test was performed in accordance with method #3 of FCC Public Notice DA-02-2138.

**7.5 TEST SETUP LAYOUT**



**7.6 DEVIATION FROM TEST STANDARD**

No deviation



## **7.7 EUT OPERATING CONDITIONS**

The EUT tested system was configured as the statements of 5.6 Unless otherwise a special operating condition is specified in the follows during the testing.



**7.8 TEST RESULTS - 5150-5250 MHZ**

E.U.T	MONDOCENTER	Model Name	INF-MCENTER
Temperature	26°C	Relative Humidity	46%
Test Voltage	AC 120V/60Hz		
Test Mode	IEEE 802.11a/5180 MHz, 5200 MHz, 5240 MHz		

Frequency	Peak Output Power (dBm)	LIMIT (dBm)	Result
5180 MHz	16.10	17.00	PASS
5200 MHz	16.37	17.00	PASS
5240 MHz	16.59	17.00	PASS



### IEEE 802.11a/5180 MHz/Maximum Peak Conducted Output Power

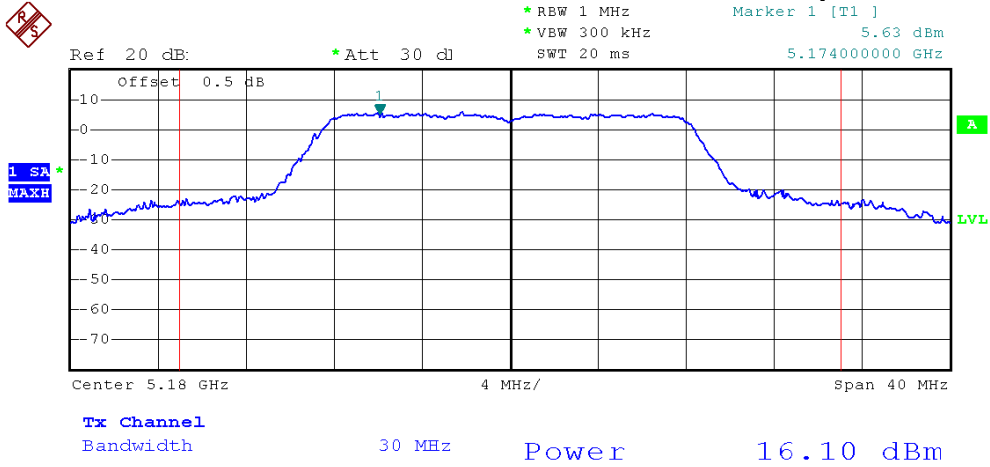

### IEEE 802.11a/5200 MHz/Maximum Peak Conducted Output Power

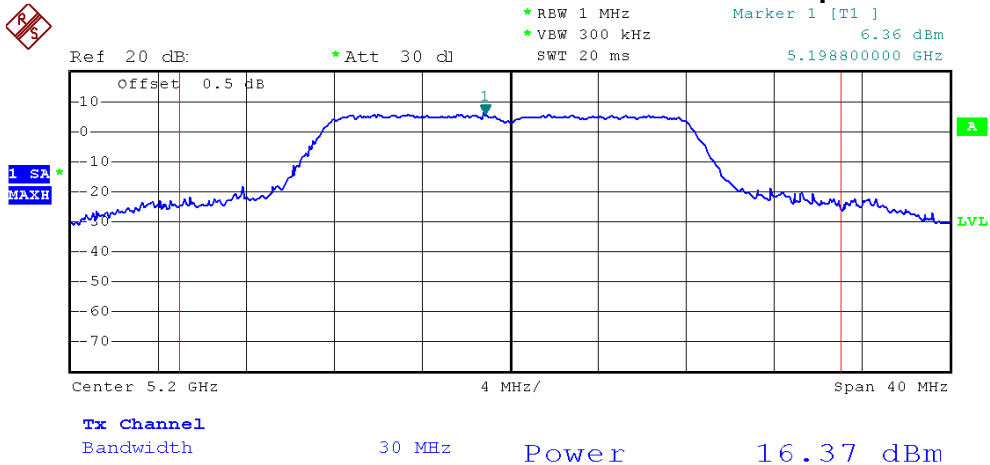

### IEEE 802.11a/5240 MHz/Maximum Peak Conducted Output Power

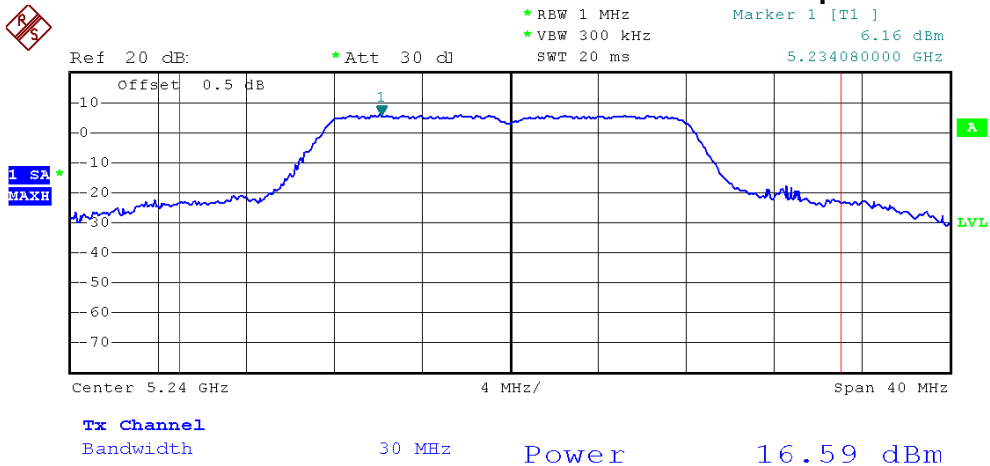



E.U.T	MONDOCENTER	Model Name	INF-MCENTER
Temperature	26°C	Relative Humidity	46%
Test Voltage	AC 120V/60Hz		
Test Mode	IEEE 802.11n (20 MHz)/ANT.1/5180 MHz, 5200 MHz, 5240 MHz		

Frequency	Peak Output Power		LIMIT (dBm)	LIMIT (W)	Result
	(dBm)	(W)			
5180 MHz	13.61	0.0230	17.00	0.0501	PASS
5200 MHz	13.48	0.0223	17.00	0.0501	PASS
5240 MHz	13.61	0.0230	17.00	0.0501	PASS



### IEEE 802.11n (20 MHz)/ANT.1/5180 MHz/Maximum Peak Conducted Output Power

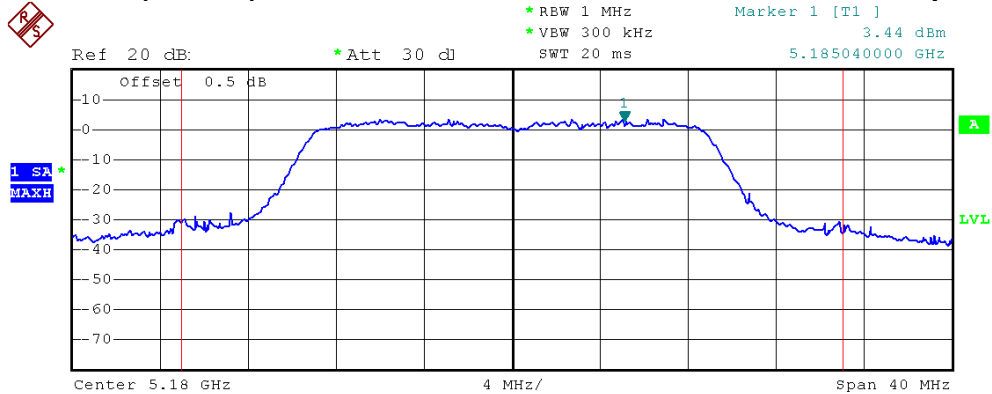

Tx Channel  
 Bandwidth 30 MHz Power 13.61 dBm

### IEEE 802.11n (20 MHz)/ANT.1/5200 MHz/Maximum Peak Conducted Output Power

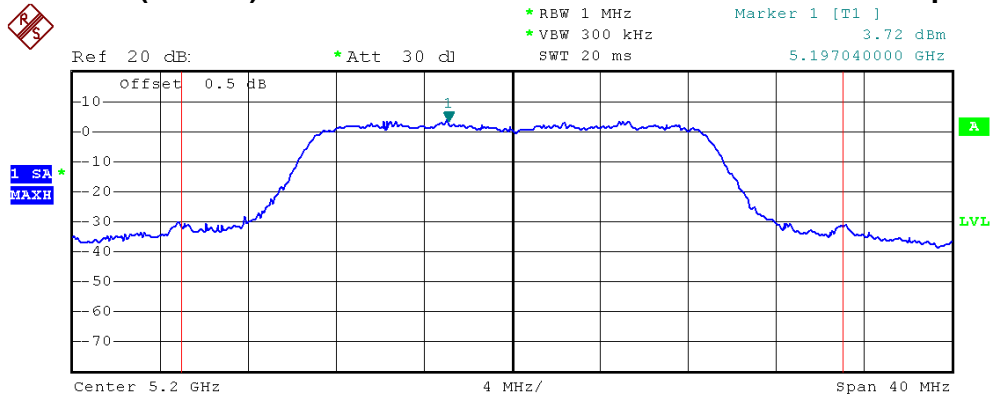

Tx Channel  
 Bandwidth 30 MHz Power 13.48 dBm

### IEEE 802.11n (20 MHz)/ANT.1/5240 MHz/Maximum Peak Conducted Output Power

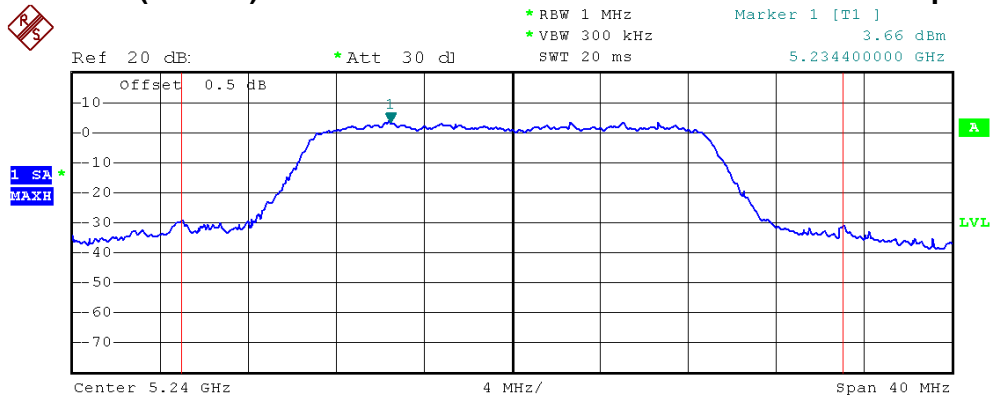

Tx Channel  
 Bandwidth 30 MHz Power 13.61 dBm



E.U.T	MONDOCENTER	Model Name	INF-MCENTER
Temperature	26°C	Relative Humidity	46%
Test Voltage	AC 120V/60Hz		
Test Mode	IEEE 802.11n (20 MHz)/ANT.2/5180 MHz, 5200 MHz, 5240 MHz		

Frequency	Peak Output Power		LIMIT (dBm)	LIMIT (W)	Result
	(dBm)	(W)			
5180 MHz	13.97	0.0249	17.00	0.0501	PASS
5200 MHz	14.16	0.0261	17.00	0.0501	PASS
5240 MHz	13.65	0.0232	17.00	0.0501	PASS





### IEEE 802.11n (20 MHz)/ANT.2/5180 MHz/Maximum Peak Conducted Output Power

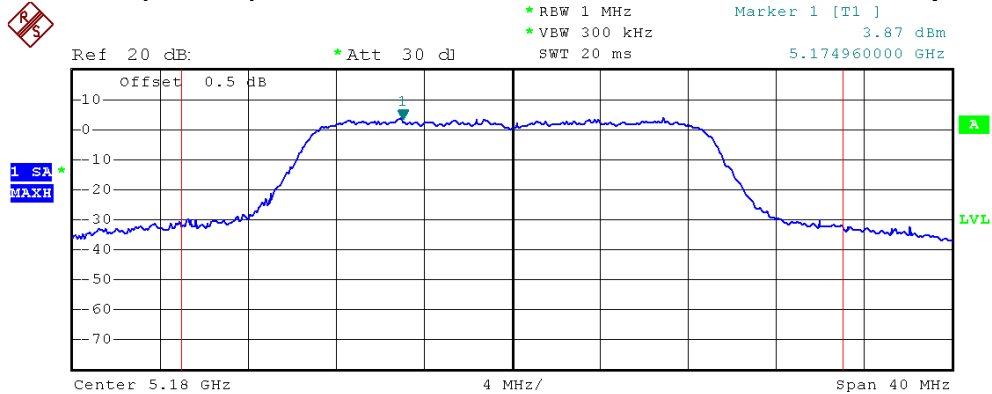

Tx Channel  
 Bandwidth 30 MHz Power 13.97 dBm

### IEEE 802.11n (20 MHz)/ANT.2/5200 MHz/Maximum Peak Conducted Output Power

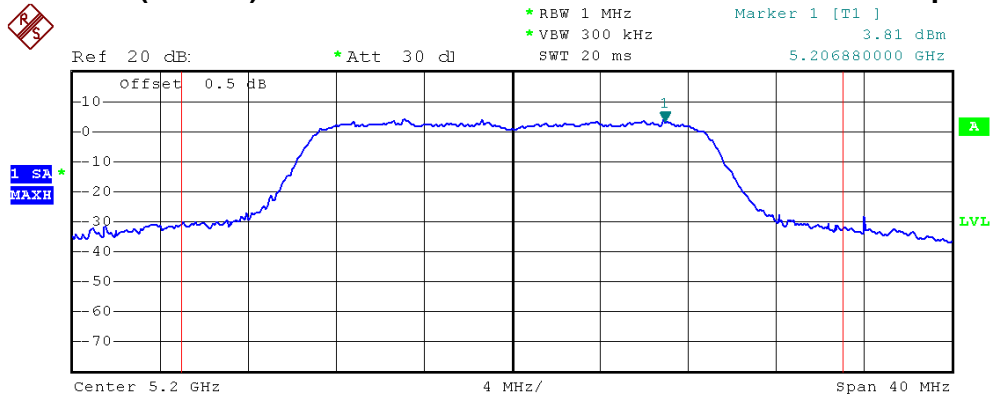

Tx Channel  
 Bandwidth 30 MHz Power 14.16 dBm

### IEEE 802.11n (20 MHz)/ANT.2/5240 MHz/Maximum Peak Conducted Output Power

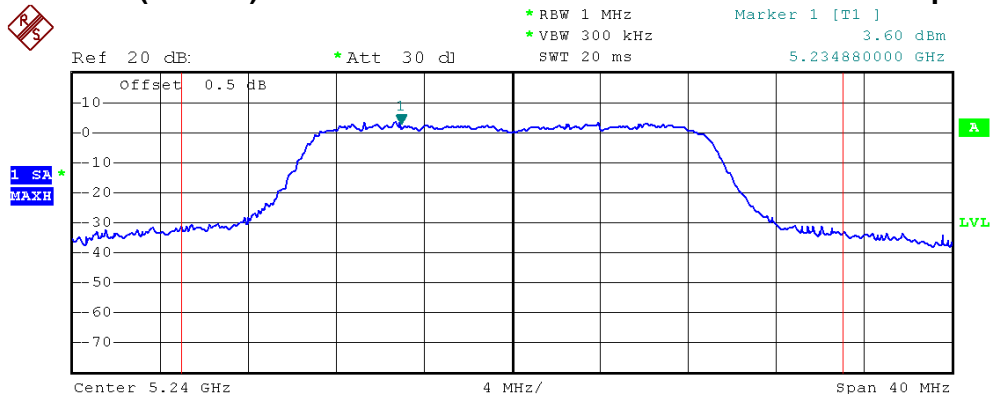

Tx Channel  
 Bandwidth 30 MHz Power 13.65 dBm



E.U.T	MONDOCENTER	Model Name	INF-MCENTER
Temperature	26°C	Relative Humidity	46%
Test Voltage	AC 120V/60Hz		
Test Mode	IEEE 802.11n (20 MHz)/ANT.Total/5180 MHz, 5200 MHz, 5240 MHz		

Frequency	Peak Output Power		LIMIT (dBm)	LIMIT (W)	Result
	(dBm)	(W)			
5180 MHz	16.80	0.0479	17.00	0.0501	PASS
5200 MHz	16.84	0.0483	17.00	0.0501	PASS
5240 MHz	16.64	0.0461	17.00	0.0501	PASS

**NOTE:**

- The MIMO test requirement, RF conducted output power shall measure each transmitter chain by using channel power method.  
And after obtain each individual transmitter chain power, then sum the output power by using the following formula:  

$$((\text{dBm}/\text{Chain 1})/10^{\text{Log}}) + ((\text{dBm}/\text{Chain 2})/10^{\text{log}}) + ((\text{dBm}/\text{ChainN})/10^{\text{log}}) = \text{Combined peak output power in mW.}$$
- Antenna 1 Gain=2 dBi.  
Antenna 2 Gain=2 dBi.



E.U.T	MONDOCENTER	Model Name	INF-MCENTER
Temperature	26°C	Relative Humidity	46%
Test Voltage	AC 120V/60Hz		
Test Mode	IEEE 802.11n (40 MHz)/ANT.1/5190 MHz, 5230 MHz		

Frequency	Peak Output Power		LIMIT (dBm)	LIMIT (W)	Result
	(dBm)	(W)			
5190 MHz	11.95	0.0157	17.00	0.0501	PASS
5230 MHz	13.55	0.0226	17.00	0.0501	PASS



### IEEE 802.11n (40 MHz)/ANT.1/5190 MHz/Maximum Peak Conducted Output Power

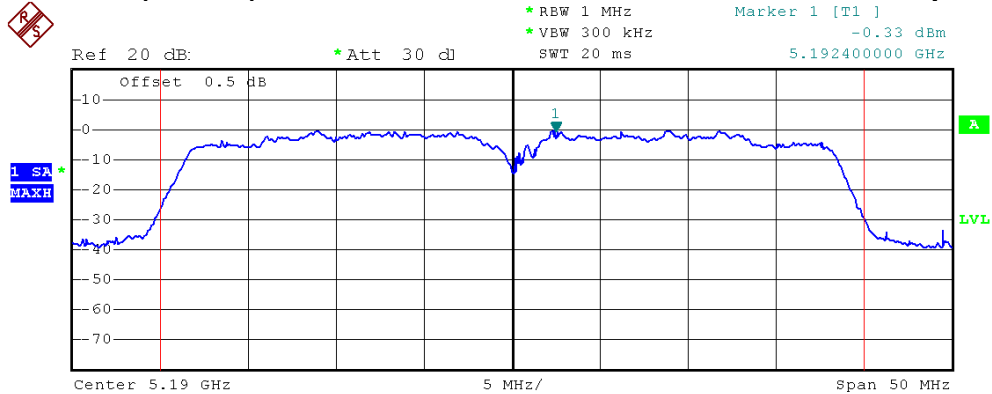

**Tx Channel**  
Bandwidth 40 MHz Power 11.95 dBm

### IEEE 802.11n (40 MHz)/ANT.1/5230 MHz/Maximum Peak Conducted Output Power

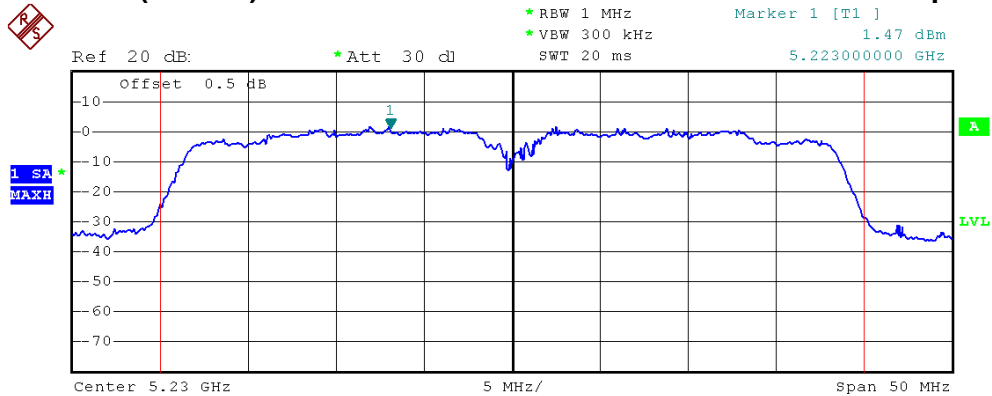

**Tx Channel**  
Bandwidth 40 MHz Power 13.55 dBm



E.U.T	MONDOCENTER	Model Name	INF-MCENTER
Temperature	26°C	Relative Humidity	46%
Test Voltage	AC 120V/60Hz		
Test Mode	IEEE 802.11n (40 MHz)/ANT.2/5190 MHz, 5230 MHz		

Frequency	Peak Output Power		LIMIT (dBm)	LIMIT (W)	Result
	(dBm)	(W)			
5190 MHz	11.60	0.0145	17.00	0.0501	PASS
5230 MHz	13.59	0.0229	17.00	0.0501	PASS



### IEEE 802.11n (40 MHz)/ANT.2/5190 MHz/Maximum Peak Conducted Output Power

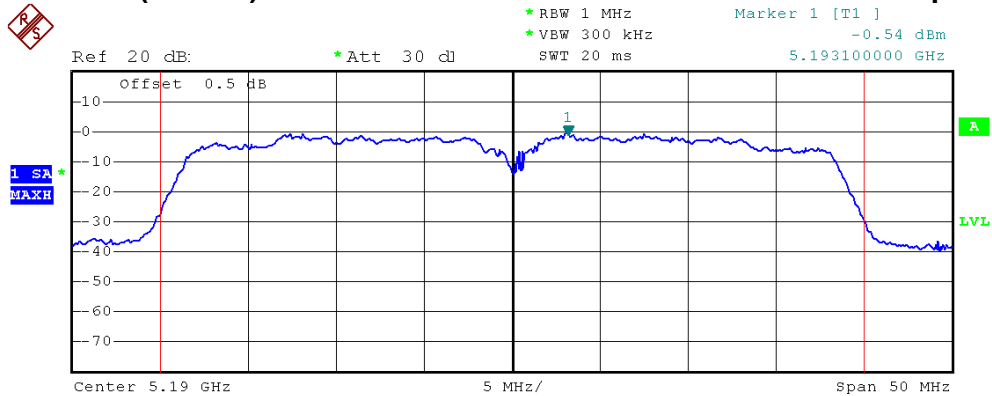

**Tx Channel**  
Bandwidth 40 MHz Power 11.60 dBm

### IEEE 802.11n (40 MHz)/ANT.2/5230 MHz/Maximum Peak Conducted Output Power

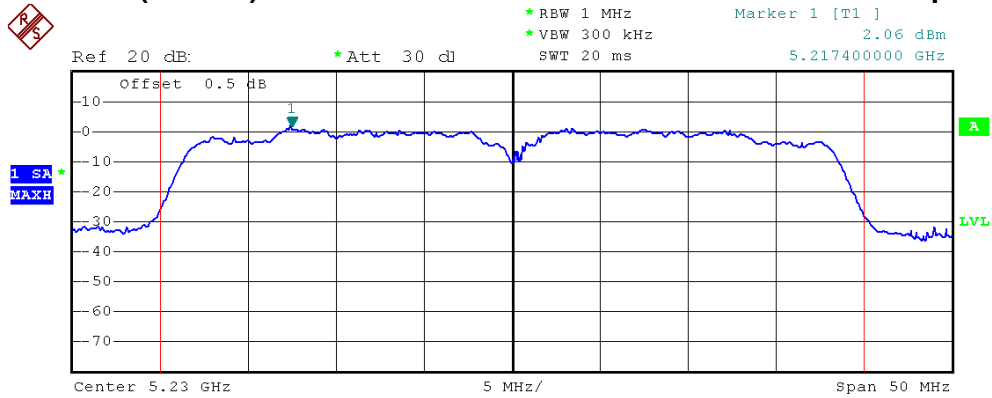

**Tx Channel**  
Bandwidth 40 MHz Power 13.59 dBm



E.U.T	MONDOCENTER	Model Name	INF-MCENTER
Temperature	26°C	Relative Humidity	46%
Test Voltage	AC 120V/60Hz		
Test Mode	IEEE 802.11n (40 MHz)/ANT.Total/5190 MHz, 5230 MHz		

Frequency	Peak Output Power		LIMIT (dBm)	LIMIT (W)	Result
	(dBm)	(W)			
5190 MHz	14.79	0.0301	17.00	0.0501	PASS
5230 MHz	16.58	0.0455	17.00	0.0501	PASS

**NOTE:**

- The MIMO test requirement, RF conducted output power shall measure each transmitter chain by using channel power method.  
And after obtain each individual transmitter chain power, then sum the output power by using the following formula:  

$$((\text{dBm}/\text{Chain 1})/10^{\wedge}\text{Log}) + ((\text{dBm}/\text{Chain 2})/10^{\wedge}\text{log}) + ((\text{dBm}/\text{ChainN})/10^{\wedge}\text{log}) = \text{Combined peak output power in mW.}$$
- Antenna 1 Gain=2 dBi.  
Antenna 2 Gain=2 dBi.



**7.9 TEST RESULTS - 5250-5350 MHZ**

E.U.T	MONDOCENTER	Model Name	INF-MCENTER
Temperature	26°C	Relative Humidity	46%
Test Voltage	AC 120V/60Hz		
Test Mode	IEEE 802.11a/5260 MHz, 5300 MHz, 5320 MHz		

Frequency	Peak Output Power (dBm)	LIMIT (dBm)	Result
5260 MHz	16.87	24.00	PASS
5300 MHz	17.13	24.00	PASS
5320 MHz	17.59	24.00	PASS





### IEEE 802.11a/5260 MHz/Maximum Peak Conducted Output Power

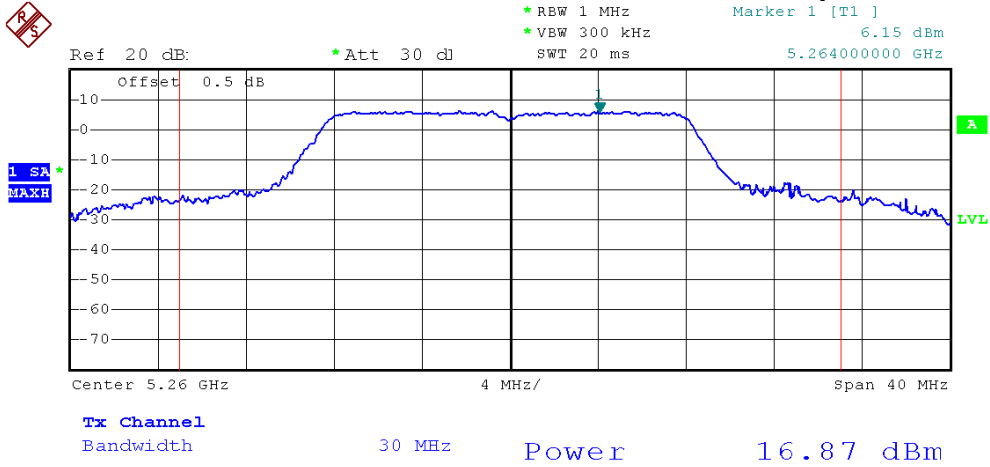

### IEEE 802.11a/5300 MHz/Maximum Peak Conducted Output Power

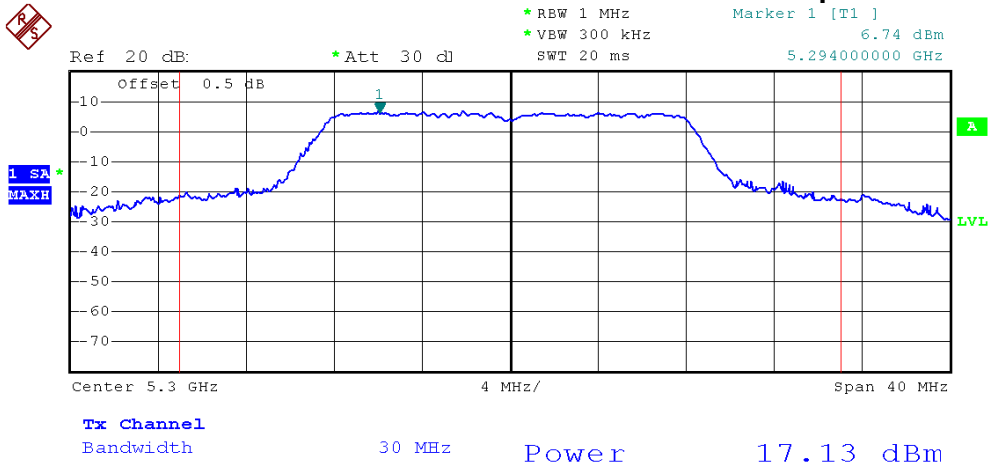

### IEEE 802.11a/5320 MHz/Maximum Peak Conducted Output Power

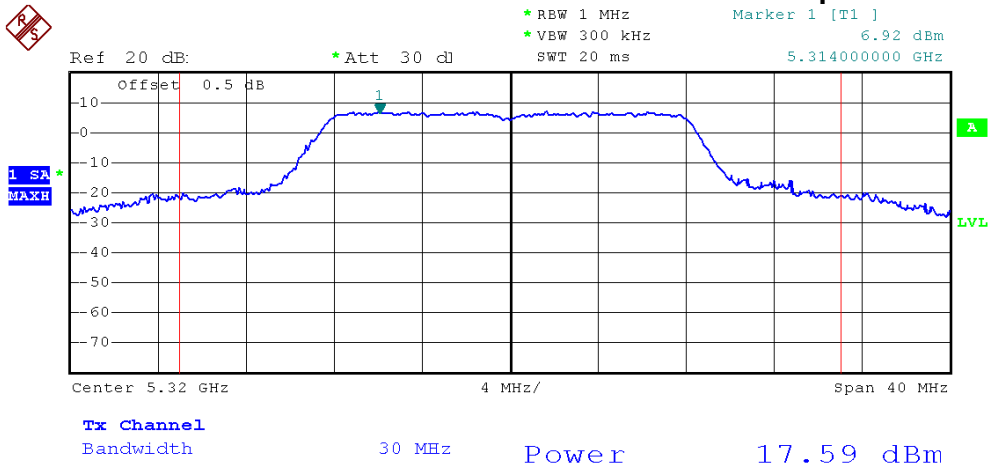



E.U.T	MONDOCENTER	Model Name	INF-MCENTER
Temperature	26°C	Relative Humidity	46%
Test Voltage	AC 120V/60Hz		
Test Mode	IEEE 802.11n (20 MHz)/ANT.1/5260 MHz, 5300 MHz, 5320 MHz		

Frequency	Peak Output Power		LIMIT (dBm)	LIMIT (W)	Result
	(dBm)	(W)			
5260 MHz	14.37	0.0274	24.00	0.2512	PASS
5300 MHz	14.43	0.0277	24.00	0.2512	PASS
5320 MHz	14.98	0.0315	24.00	0.2512	PASS



IEEE 802.11n (20 MHz)/ANT.1/5260 MHz/Maximum Peak Conducted Output Power

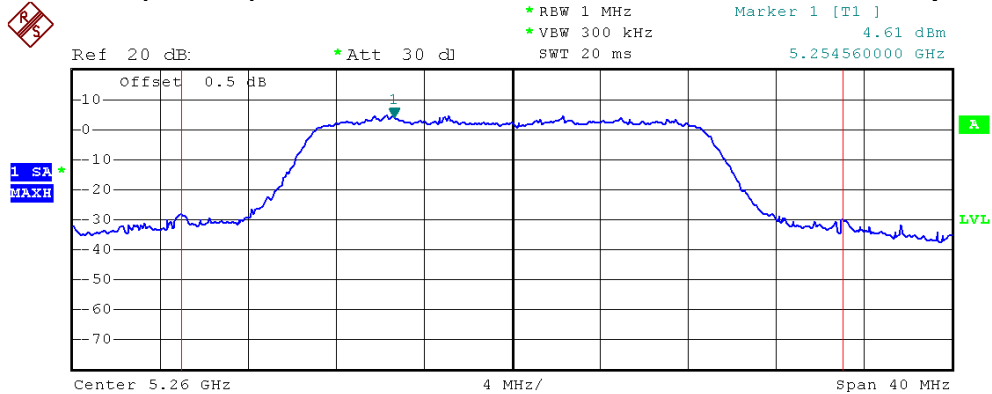

Tx Channel Bandwidth 30 MHz Power 14.37 dBm

IEEE 802.11n (20 MHz)/ANT.1/5300 MHz/Maximum Peak Conducted Output Power

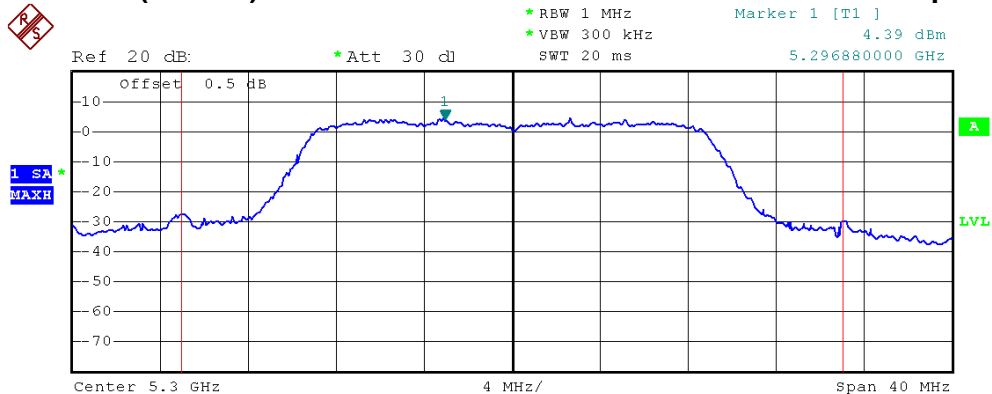

Tx Channel Bandwidth 30 MHz Power 14.43 dBm

IEEE 802.11n (20 MHz)/ANT.1/5320 MHz/Maximum Peak Conducted Output Power

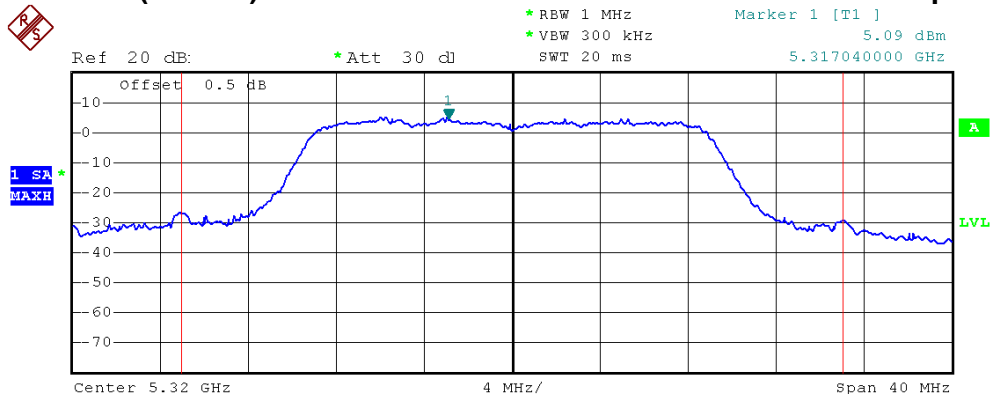

Tx Channel Bandwidth 30 MHz Power 14.98 dBm



E.U.T	MONDOCENTER	Model Name	INF-MCENTER
Temperature	26°C	Relative Humidity	46%
Test Voltage	AC 120V/60Hz		
Test Mode	IEEE 802.11n (20 MHz)/ANT.2/5260 MHz, 5300 MHz, 5320 MHz		

Frequency	Peak Output Power		LIMIT (dBm)	LIMIT (W)	Result
	(dBm)	(W)			
5260 MHz	14.58	0.0287	24.00	0.2512	PASS
5300 MHz	15.44	0.0350	24.00	0.2512	PASS
5320 MHz	15.78	0.0378	24.00	0.2512	PASS



### IEEE 802.11n (20 MHz)/ANT.2/5260 MHz/Maximum Peak Conducted Output Power

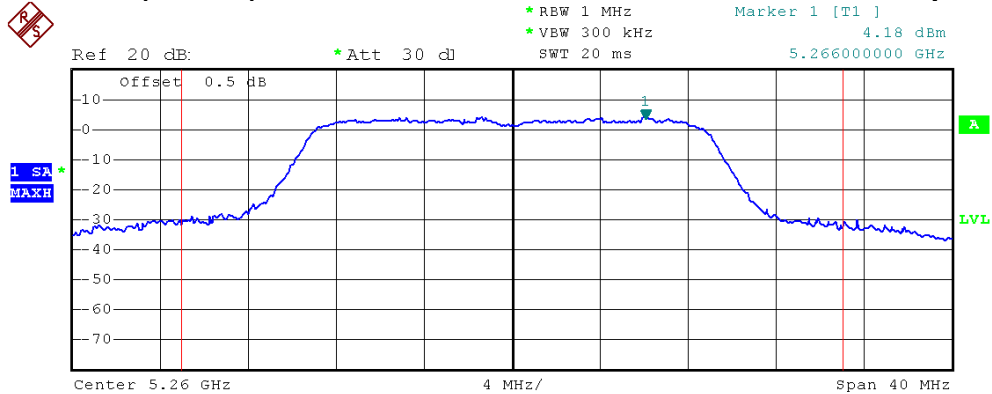

Tx Channel  
Bandwidth 30 MHz Power 14.58 dBm

### IEEE 802.11n (20 MHz)/ANT.2/5300 MHz/Maximum Peak Conducted Output Power

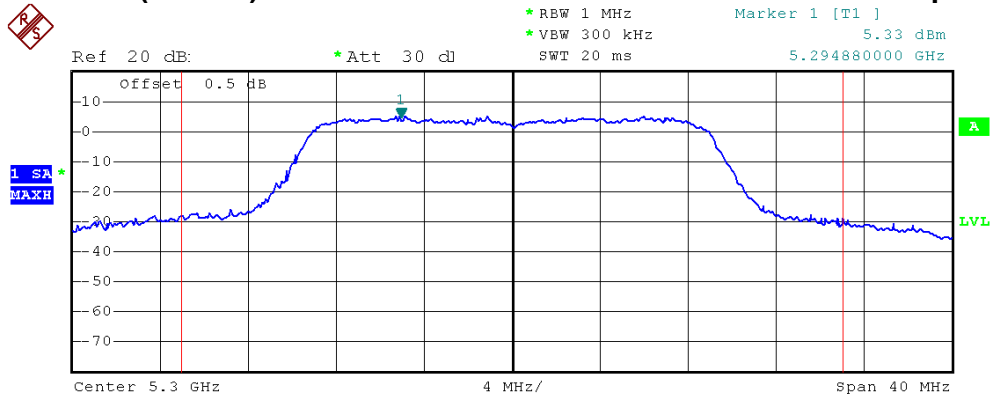

Tx Channel  
Bandwidth 30 MHz Power 15.44 dBm

### IEEE 802.11n (20 MHz)/ANT.2/5320 MHz/Maximum Peak Conducted Output Power

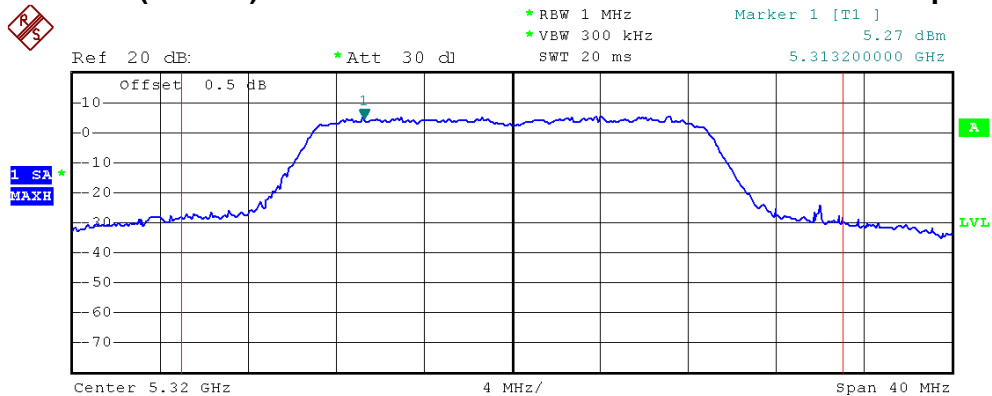

Tx Channel  
Bandwidth 30 MHz Power 15.78 dBm



E.U.T	MONDOCENTER	Model Name	INF-MCENTER
Temperature	26°C	Relative Humidity	46%
Test Voltage	AC 120V/60Hz		
Test Mode	IEEE 802.11n (20 MHz)/ANT.Total/5260 MHz, 5300 MHz, 5320 MHz		

Frequency	Peak Output Power		LIMIT (dBm)	LIMIT (W)	Result
	(dBm)	(W)			
5260 MHz	17.49	0.0561	24.00	0.2512	PASS
5300 MHz	17.97	0.0627	24.00	0.2512	PASS
5320 MHz	18.41	0.0693	24.00	0.2512	PASS

**NOTE:**

- The MIMO test requirement, RF conducted output power shall measure each transmitter chain by using channel power method.  
And after obtain each individual transmitter chain power, then sum the output power by using the following formula:  

$$((\text{dBm}/\text{Chain 1})/10^{\text{Log}}) + ((\text{dBm}/\text{Chain 2})/10^{\text{Log}}) + ((\text{dBm}/\text{ChainN})/10^{\text{Log}}) = \text{Combined peak output power in mW.}$$
- Antenna 1 Gain=2 dBi.  
Antenna 2 Gain=2 dBi.



E.U.T	MONDOCENTER	Model Name	INF-MCENTER
Temperature	26°C	Relative Humidity	46%
Test Voltage	AC 120V/60Hz		
Test Mode	IEEE 802.11n (40 MHz)/ANT.1/5270 MHz, 5310 MHz		

Frequency	Peak Output Power		LIMIT (dBm)	LIMIT (W)	Result
	(dBm)	(W)			
5270 MHz	15.26	0.0336	24.00	0.2512	PASS
5310 MHz	11.22	0.0132	24.00	0.2512	PASS



### IEEE 802.11n (40 MHz)/ANT.1/5270 MHz/Maximum Peak Conducted Output Power

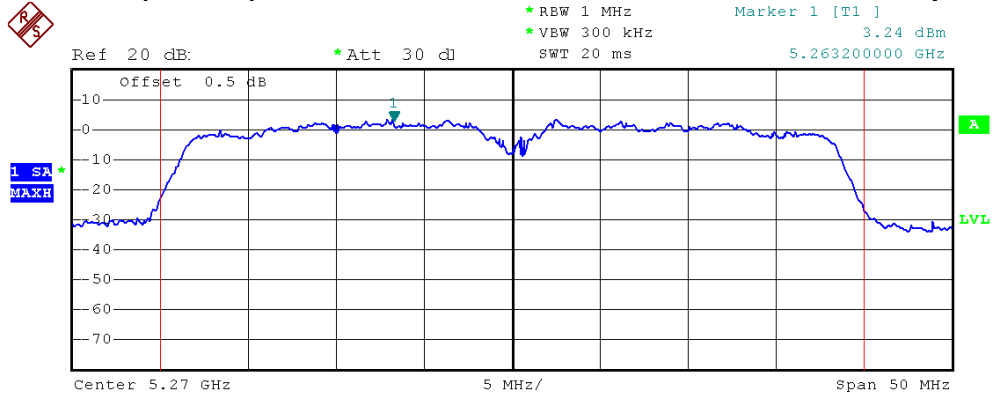

**Tx Channel**  
Bandwidth 40 MHz Power 15.26 dBm

### IEEE 802.11n (40 MHz)/ANT.1/5310 MHz/Maximum Peak Conducted Output Power

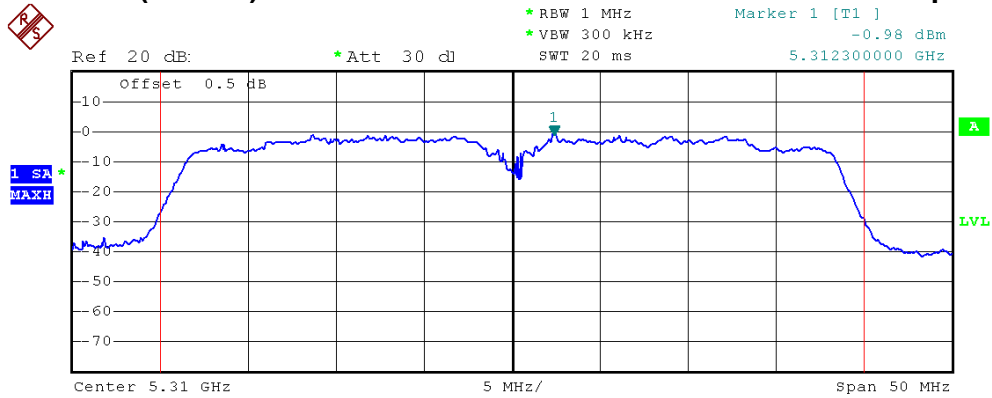

**Tx Channel**  
Bandwidth 40 MHz Power 11.22 dBm





E.U.T	MONDOCENTER	Model Name	INF-MCENTER
Temperature	26°C	Relative Humidity	46%
Test Voltage	AC 120V/60Hz		
Test Mode	IEEE 802.11n (40 MHz)/ANT.2/5270 MHz, 5310 MHz		

Frequency	Peak Output Power		LIMIT (dBm)	LIMIT (W)	Result
	(dBm)	(W)			
5270 MHz	15.84	0.0384	24.00	0.2512	PASS
5310 MHz	10.50	0.0112	24.00	0.2512	PASS



### IEEE 802.11n (40 MHz)/ANT.2/5270 MHz/Maximum Peak Conducted Output Power

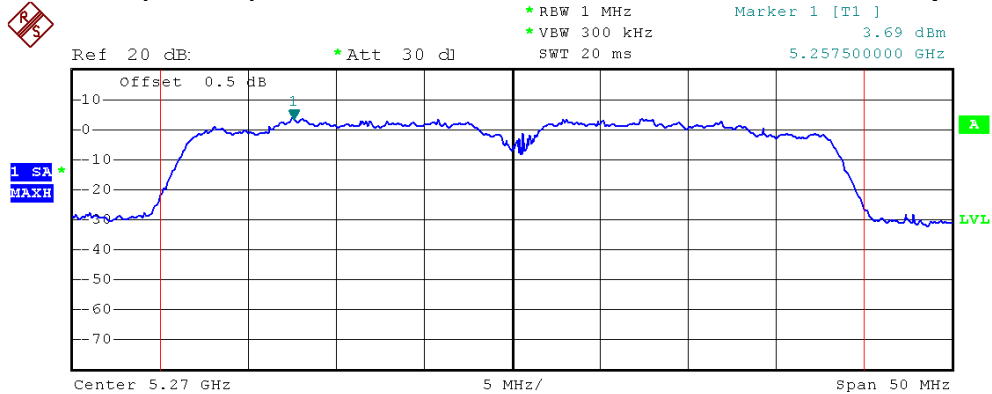

**Tx Channel**  
Bandwidth 40 MHz Power 15.84 dBm

### IEEE 802.11n (40 MHz)/ANT.2/5310 MHz/Maximum Peak Conducted Output Power

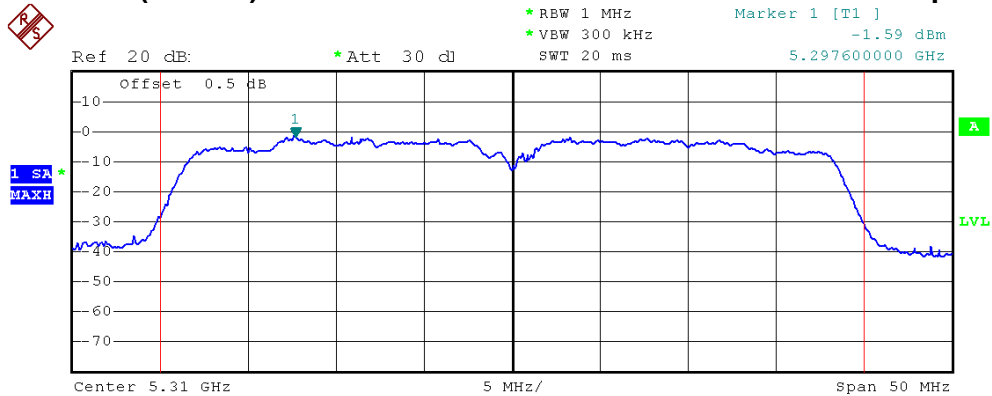

**Tx Channel**  
Bandwidth 40 MHz Power 10.50 dBm



E.U.T	MONDOCENTER	Model Name	INF-MCENTER
Temperature	26°C	Relative Humidity	46%
Test Voltage	AC 120V/60Hz		
Test Mode	IEEE 802.11n (40 MHz)/ANT.Total/5270 MHz, 5310 MHz		

Frequency	Peak Output Power		LIMIT (dBm)	LIMIT (W)	Result
	(dBm)	(W)			
5270 MHz	18.57	0.0719	24.00	0.2512	PASS
5310 MHz	13.89	0.0245	24.00	0.2512	PASS

**NOTE:**

- The MIMO test requirement, RF conducted output power shall measure each transmitter chain by using channel power method.  
And after obtain each individual transmitter chain power, then sum the output power by using the following formula:  

$$((\text{dBm}/\text{Chain 1})/10^{\text{Log}}) + ((\text{dBm}/\text{Chain 2})/10^{\text{Log}}) + ((\text{dBm}/\text{Chain N})/10^{\text{Log}}) = \text{Combined peak output power in mW.}$$
- Antenna 1 Gain=2 dBi.  
Antenna 2 Gain=2 dBi.



**7.10 TEST RESULTS - 5470-5725 MHZ**

E.U.T	MONDOCENTER	Model Name	INF-MCENTER
Temperature	26°C	Relative Humidity	46%
Test Voltage	AC 120V/60Hz		
Test Mode	IEEE 802.11a/5500 MHz, 5580 MHz, 5700 MHz		

Frequency	Peak Output Power (dBm)	LIMIT (dBm)	Result
5500 MHz	17.48	24.00	PASS
5580 MHz	17.91	24.00	PASS
5700 MHz	16.93	24.00	PASS



### IEEE 802.11a/5500 MHz/Maximum Peak Conducted Output Power

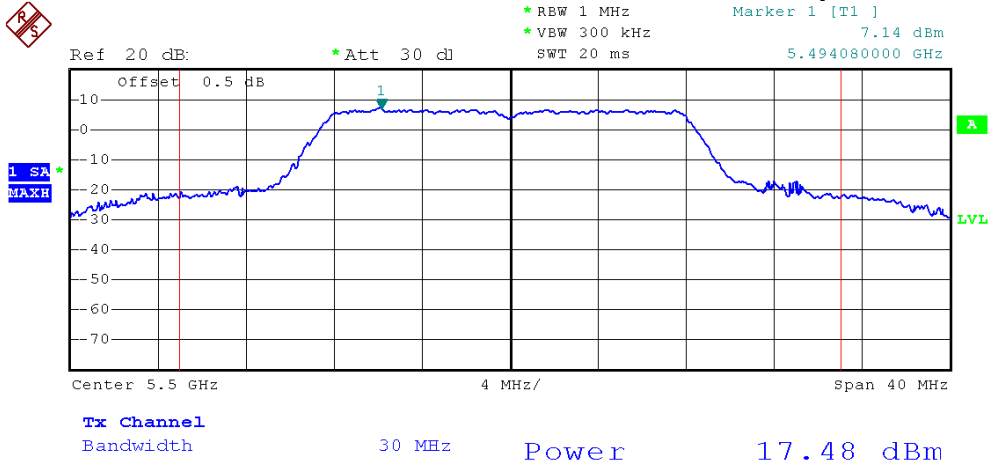

### IEEE 802.11a/5580 MHz/Maximum Peak Conducted Output Power

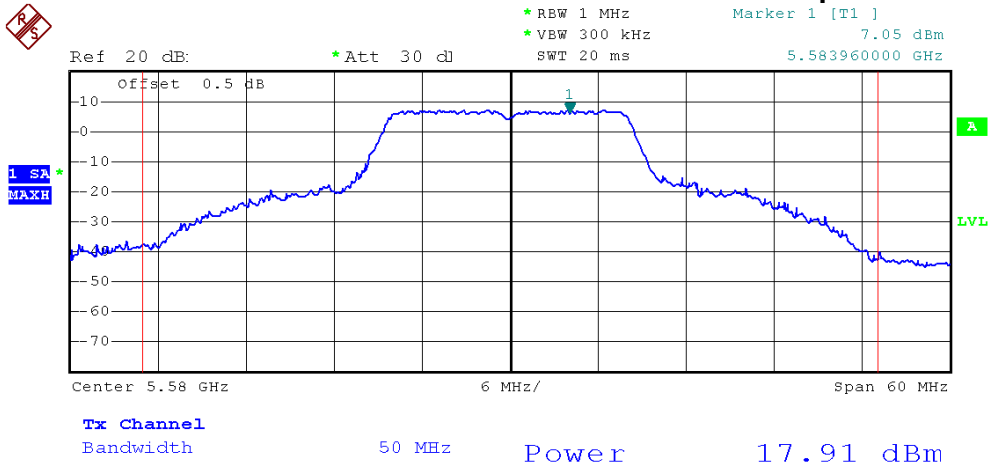

### IEEE 802.11a/5700 MHz/Maximum Peak Conducted Output Power

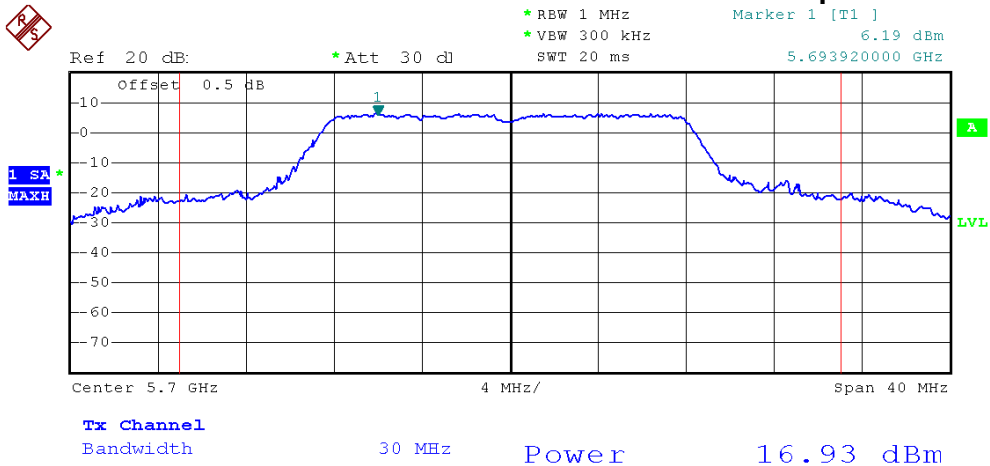



E.U.T	MONDOCENTER	Model Name	INF-MCENTER
Temperature	26°C	Relative Humidity	46%
Test Voltage	AC 120V/60Hz		
Test Mode	IEEE 802.11n (20 MHz)/ANT.1/5500 MHz, 5580 MHz, 5700 MHz		

Frequency	Peak Output Power		LIMIT (dBm)	LIMIT (W)	Result
	(dBm)	(W)			
5500 MHz	15.79	0.0379	30.00	1.0000	PASS
5580 MHz	15.31	0.0340	30.00	1.0000	PASS
5700 MHz	14.86	0.0306	30.00	1.0000	PASS



### IEEE 802.11n (20 MHz)/ANT.1/5500 MHz/Maximum Peak Conducted Output Power

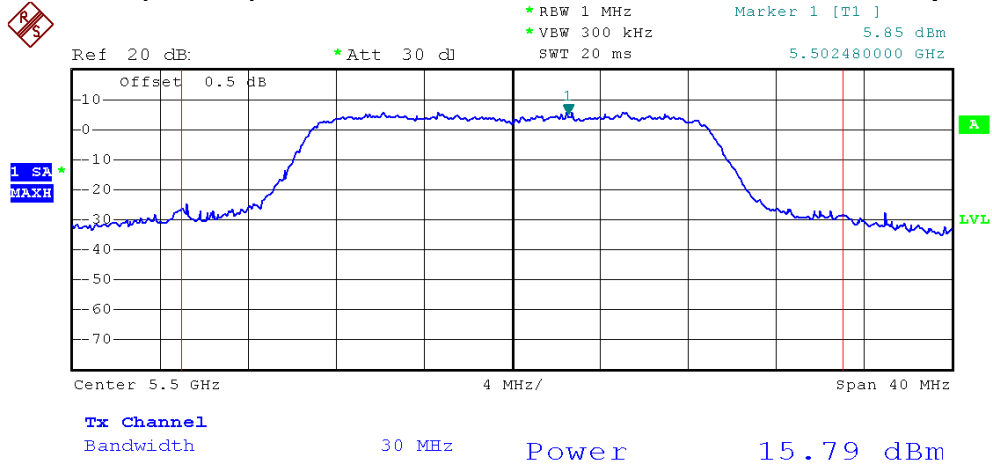

### IEEE 802.11n (20 MHz)/ANT.1/5580 MHz/Maximum Peak Conducted Output Power

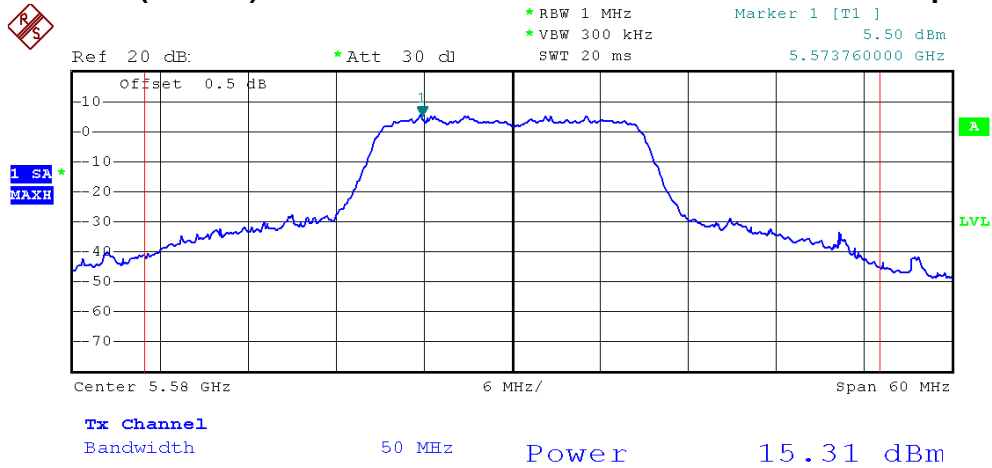

### IEEE 802.11n (20 MHz)/ANT.1/5700 MHz/Maximum Peak Conducted Output Power

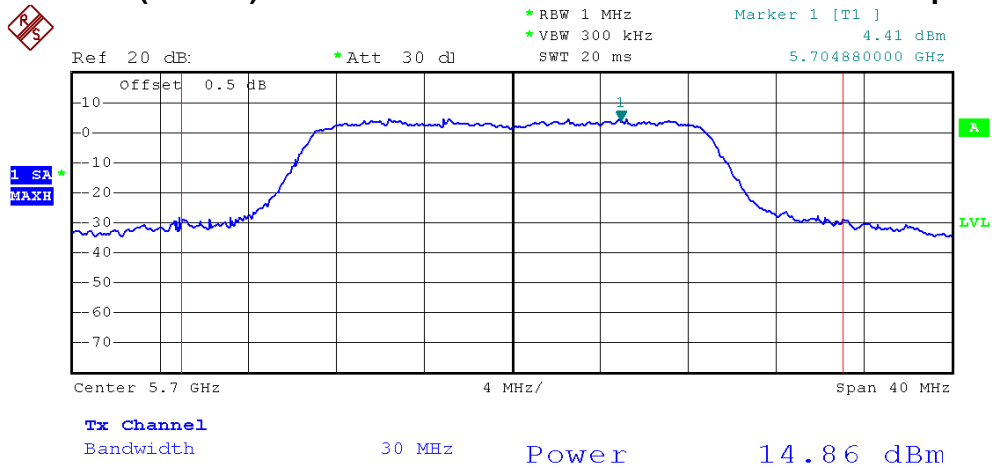



E.U.T	MONDOCENTER	Model Name	INF-MCENTER
Temperature	26°C	Relative Humidity	46%
Test Voltage	AC 120V/60Hz		
Test Mode	IEEE 802.11n (20 MHz)/ANT.2/5500 MHz, 5580 MHz, 5700 MHz		

Frequency	Peak Output Power		LIMIT (dBm)	LIMIT (W)	Result
	(dBm)	(W)			
5500 MHz	16.07	0.0405	30.00	1.0000	PASS
5580 MHz	15.28	0.0337	30.00	1.0000	PASS
5700 MHz	14.88	0.0308	30.00	1.0000	PASS





### IEEE 802.11n (20 MHz)/ANT.2/5500 MHz/Maximum Peak Conducted Output Power

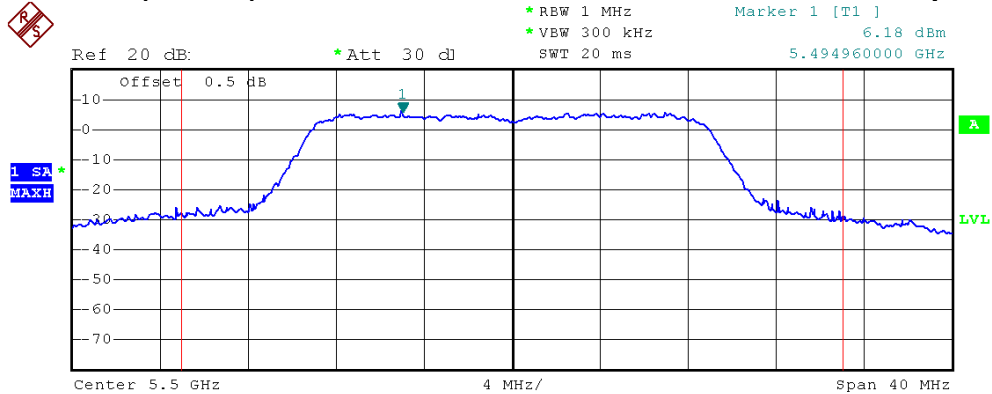

Tx Channel  
Bandwidth 30 MHz Power 16.07 dBm

### IEEE 802.11n (20 MHz)/ANT.2/5580 MHz/Maximum Peak Conducted Output Power

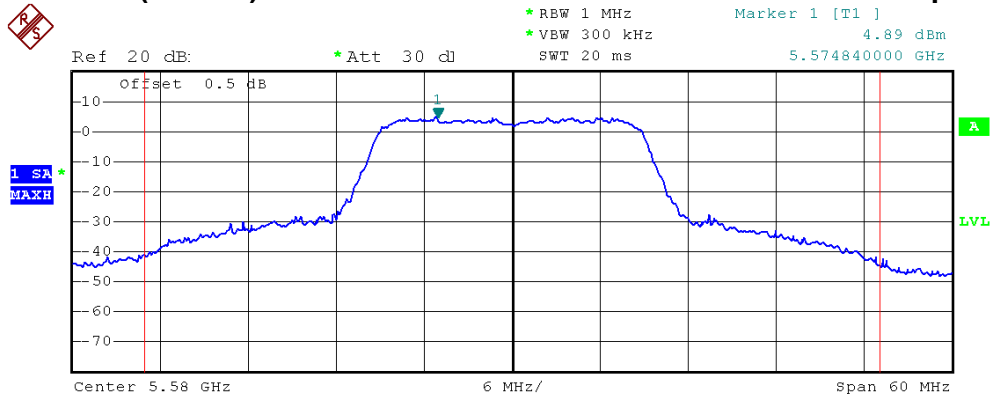

Tx Channel  
Bandwidth 50 MHz Power 15.28 dBm

### IEEE 802.11n (20 MHz)/ANT.2/5700 MHz/Maximum Peak Conducted Output Power

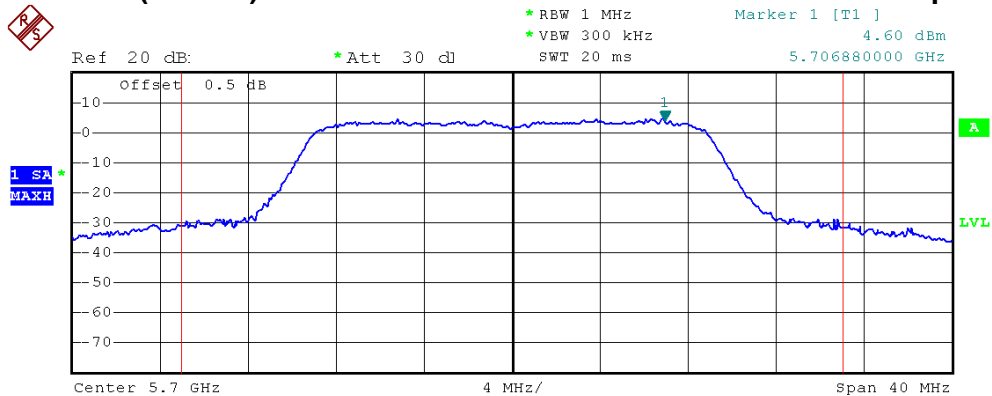

Tx Channel  
Bandwidth 30 MHz Power 14.88 dBm



E.U.T	MONDOCENTER	Model Name	INF-MCENTER
Temperature	26°C	Relative Humidity	46%
Test Voltage	AC 120V/60Hz		
Test Mode	IEEE 802.11n (20 MHz)/ANT.Total/5500 MHz, 5580 MHz, 5700 MHz		

Frequency	Peak Output Power		LIMIT (dBm)	LIMIT (W)	Result
	(dBm)	(W)			
5500 MHz	18.94	0.0784	30.00	1.0000	PASS
5580 MHz	18.31	0.0677	30.00	1.0000	PASS
5700 MHz	17.88	0.0614	30.00	1.0000	PASS

**NOTE:**

- The MIMO test requirement, RF conducted output power shall measure each transmitter chain by using channel power method.  
And after obtain each individual transmitter chain power, then sum the output power by using the following formula:  

$$((\text{dBm}/\text{Chain 1})/10^{\text{Log}}) + ((\text{dBm}/\text{Chain 2})/10^{\text{Log}}) + ((\text{dBm}/\text{ChainN})/10^{\text{Log}}) = \text{Combined peak output power in mW.}$$
- Antenna 1 Gain=2 dBi.  
Antenna 2 Gain=2 dBi.



E.U.T	MONDOCENTER	Model Name	INF-MCENTER
Temperature	26°C	Relative Humidity	46%
Test Voltage	AC 120V/60Hz		
Test Mode	IEEE 802.11n (40 MHz)/ANT.1/5510 MHz, 5550 MHz, 5670 MHz		

Frequency	Peak Output Power		LIMIT (dBm)	LIMIT (W)	Result
	(dBm)	(W)			
5510 MHz	15.78	0.0378	30.00	1.0000	PASS
5550 MHz	16.48	0.0445	30.00	1.0000	PASS
5670 MHz	15.58	0.0361	30.00	1.0000	PASS



### IEEE 802.11n (40 MHz)/ANT.1/5510 MHz/Maximum Peak Conducted Output Power

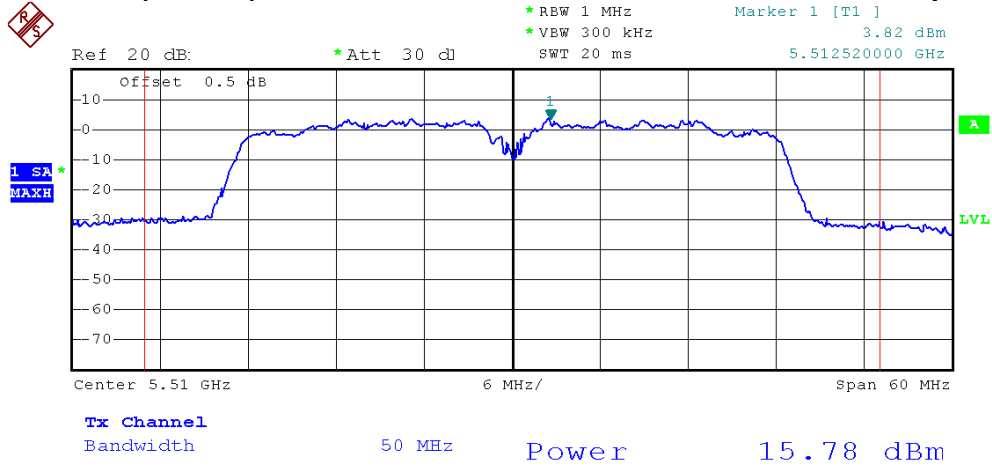

### IEEE 802.11n (40 MHz)/ANT.1/5550 MHz/Maximum Peak Conducted Output Power

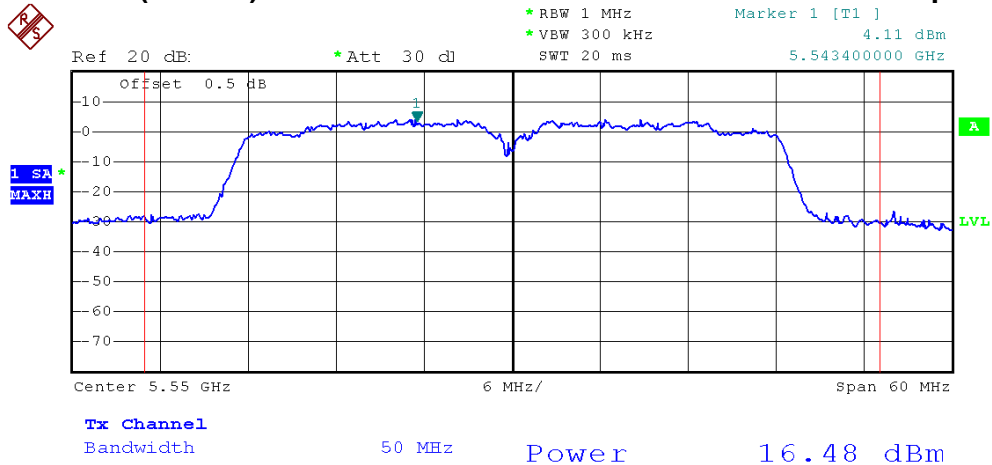

### IEEE 802.11n (40 MHz)/ANT.1/5670 MHz/Maximum Peak Conducted Output Power

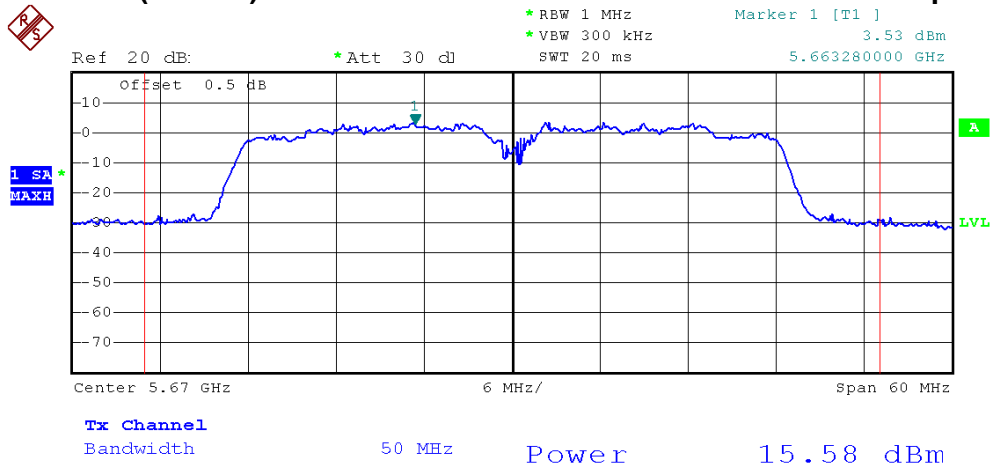



E.U.T	MONDOCENTER	Model Name	INF-MCENTER
Temperature	26°C	Relative Humidity	46%
Test Voltage	AC 120V/60Hz		
Test Mode	IEEE 802.11n (40 MHz)/ANT.2/5510 MHz, 5550 MHz, 5670 MHz		

Frequency	Peak Output Power		LIMIT (dBm)	LIMIT (W)	Result
	(dBm)	(W)			
5510 MHz	15.67	0.0369	30.00	1.0000	PASS
5550 MHz	16.64	0.0461	30.00	1.0000	PASS
5670 MHz	15.39	0.0346	30.00	1.0000	PASS



### IEEE 802.11n (40 MHz)/ANT.2/5510 MHz/Maximum Peak Conducted Output Power

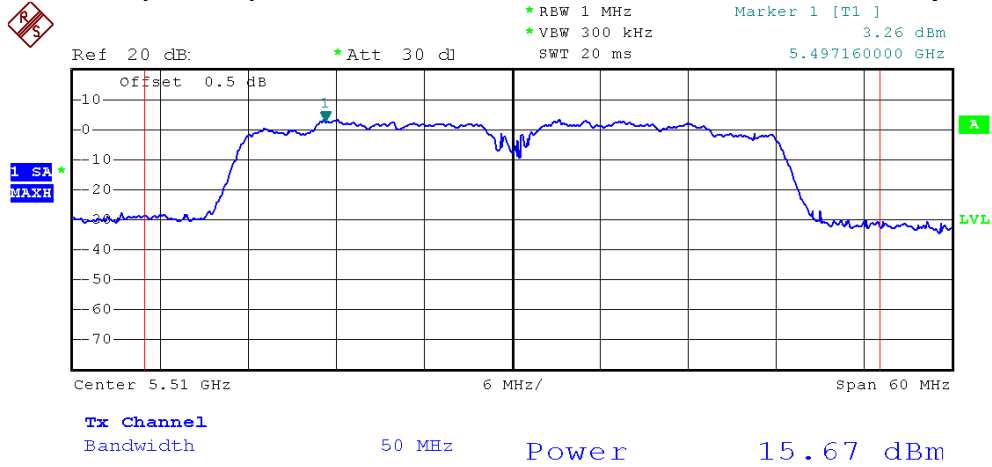

### IEEE 802.11n (40 MHz)/ANT.2/5550 MHz/Maximum Peak Conducted Output Power

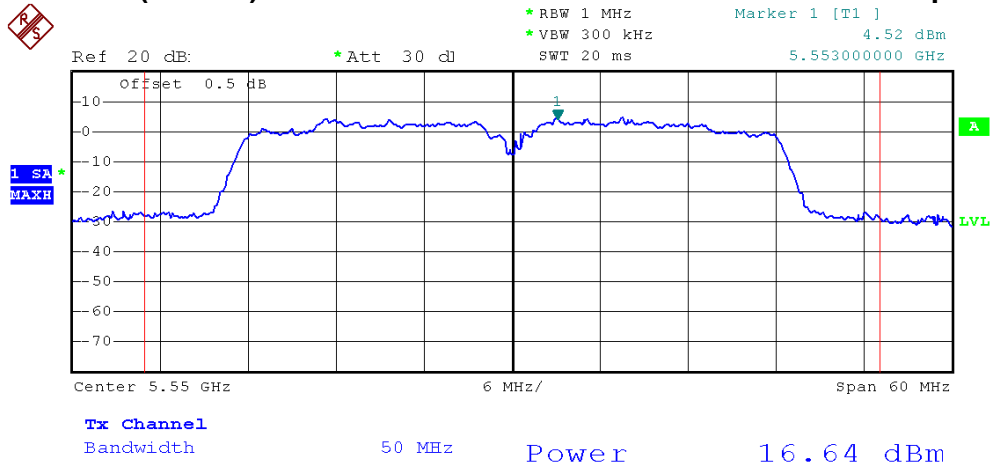

### IEEE 802.11n (40 MHz)/ANT.2/5670 MHz/Maximum Peak Conducted Output Power

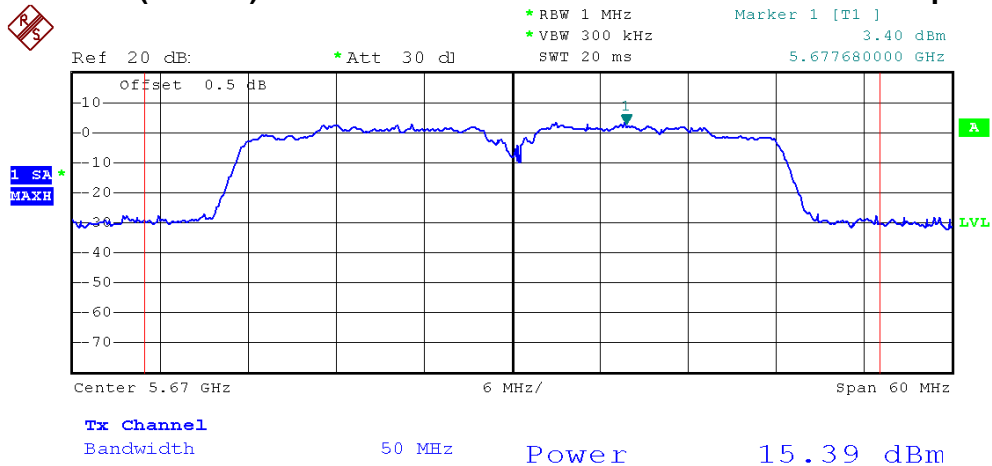



E.U.T	MONDOCENTER	Model Name	INF-MCENTER
Temperature	26°C	Relative Humidity	46%
Test Voltage	AC 120V/60Hz		
Test Mode	IEEE 802.11n (40 MHz)/ANT.Total/5510 MHz, 5550 MHz, 5670 MHz		

Frequency	Peak Output Power		LIMIT (dBm)	LIMIT (W)	Result
	(dBm)	(W)			
5510 MHz	18.74	0.0747	30.00	1.0000	PASS
5550 MHz	19.57	0.0906	30.00	1.0000	PASS
5670 MHz	18.50	0.0707	30.00	1.0000	PASS

**NOTE:**

- The MIMO test requirement, RF conducted output power shall measure each transmitter chain by using channel power method.  
And after obtain each individual transmitter chain power, then sum the output power by using the following formula:  

$$((\text{dBm}/\text{Chain 1})/10^{\text{Log}}) + ((\text{dBm}/\text{Chain 2})/10^{\text{Log}}) + ((\text{dBm}/\text{ChainN})/10^{\text{Log}}) = \text{Combined peak output power in mW.}$$
- Antenna 1 Gain=2 dBi.  
Antenna 2 Gain=2 dBi.



**8 RADIATED SPURIOUS EMISSION (9 KHZ TO 1 GHZ)**

**8.1 LIMIT**

20 dB in any 100 kHz bandwidth outside the operating frequency band. In case the emission fall within the restricted band specified on 15.205(a), then the 15.209(a) limit in the table below has to be followed.

Frequency Range: 9 kHz to 1 GHz		
FREQUENCY (MHz)	Field Strength (microvolts/meter)	Measurement Distance (meters)
0.009~0.490	2400/F(kHz)	300
0.490~1.705	24000/F(kHz)	30
1.705~30.0	30	30
30~88	100	3
88~216	150	3
216~960	200	3
Above 960	500	3

Frequency Range: above 1 GHz				
FREQUENCY (MHz)	Class A (dBuV/m) (at 3m)		Class B (dBuV/m) (at 3m)	
	PEAK	AVERAGE	PEAK	AVERAGE
above 1 GHz	80	60	74	54

**NOTE:**

- (1) The limit for radiated test was performed according to FCC PART 15B.
- (2) The tighter limit applies at the band edges.
- (3) Emission level (dBuV/m)=20log Emission level (uV/m).
- (4) The test result calculated as following:  
 Measurement Value = Reading Level + Correct Factor  
 Correct Factor = Antenna Factor + Cable Loss – Amplifier Gain(if use)  
 Margin Level = Measurement Value – Limit Value





**8.2 MEASUREMENT INSTRUMENTS LIST**

Item	Kind of Equipment	Manufacturer	Type No.	Serial No.	Calibrated until
1	Spectrum Analyzer	R&S	FSP-40	100129	Oct. 06, 2012
2	Horn Antenna	Schwarzbeck	BBHA 9120	D-325	Apr. 16, 2013
3	Microwave Pre_amplifier	Agilent	8449B	3008A01714	Apr. 17, 2013
4	Microflex Cable	N/A	N/A	1m	Apr. 14, 2013
5	Microflex Cable	AISI	S104-SMAP-1	10m	Apr. 14, 2013
6	Microflex Cable	N/A	N/A	3m	Apr. 14, 2013
7	Test Cable	N/A	LMR-400	966_12m	May. 15, 2013
8	Test Cable	N/A	LMR-400	966_3m	May. 15, 2013
9	Pre-Amplifier	EMC	EMC-330	980081	Jun. 07, 2013
10	Log-Bicon Antenna	Schwarzbeck	VULB9168-352	9168-352	Jun. 12, 2013
11	Horn Antenna	Schwarzbeck	BBHA 9170	187	Dec. 18, 2012
12	Preamplifier With Adaptor	EMC	EMC2654045	980030	Feb. 19, 2013

Remark: "N/A" denotes No Model Name, No Serial No. or No Calibration specified.

**8.3 MEASURING INSTRUMENTS SETTING**

EMI Test Receiver	Parameter Setting
Attenuation	Auto
Start ~ Stop Frequency	9kHz~150kHz / RB 200Hz for QP
Start ~ Stop Frequency	150kHz~30MHz / RB 9kHz for QP
Start ~ Stop Frequency	30MHz~1000MHz / RB 120kHz for QP

## 8.4 TEST PROCEDURES

- The measuring distance of at 3 m shall be used for measurements at frequency up to 1 GHz. For frequencies above 1 GHz, any suitable measuring distance may be used.
- The EUT was placed on the top of a rotating table 0.8 meters above the ground at a 3m Semi-anechoic chamber. The table was rotated 360 degrees to determine the position of the highest radiation.
- The height of the equipment or of the substitution antenna shall be 0.8 m; the height of the test antenna shall vary between 1 m to 4 m. Both horizontal and vertical polarizations of the antenna are set to make the measurement.
- The initial step in collecting conducted emission data is a spectrum analyzer peak detector mode pre-scanning the measurement frequency range. Significant peaks are then marked and then Quasi Peak detector mode re-measured.
- If the Peak Mode measured value compliance with and lower than Quasi Peak Mode Limit, the EUT shall be deemed to meet QP Limits and then no additional QP Mode measurement performed.
- For the actual test configuration, please refer to the related Item –EUT Test Photos.
- The testing follows the guidelines in ANSI C63.4 and FCC Public Notice DA 00-705 Measurement Guidelines. In case the emission is fail due to the used RBW/VBW is too wide, marker-delta method of FCC Public Notice DA 00-705 will be followed.

### NOTE:

- Reading in which marked as QP or Peak means measurements by using are Quasi-Peak Mode with Detector BW=120 kHz; SPA setting in RBW=100 kHz, VBW =100 kHz, Swp. Time = 0.3 sec./ MHz.
- All readings are Peak unless otherwise stated QP in column of Note. Peak denotes that the Peak reading compliance with the QP Limits and then QP Mode measurement didn't perform.

## 8.5 DEVIATION FROM TEST STANDARD

No deviation

## 8.6 TEST SETUP LAYOUT

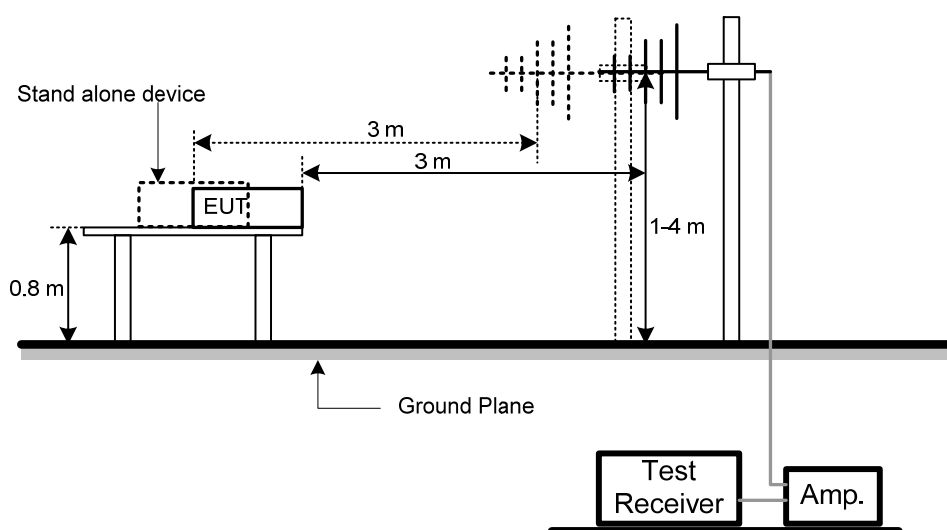



## **8.7 EUT OPERATING CONDITIONS**

The EUT tested system was configured as the statements of 5.6 Unless otherwise a special operating condition is specified in the follows during the testing.



**8.8 TEST RESULTS - 5150-5250 MHZ**

E.U.T	MONDOCENTER	Model Name	INF-MCENTER
Temperature	26°C	Relative Humidity	60%
Test Voltage	AC 120V/60Hz		
Test Mode	IEEE 802.11a/5200 MHz		

**Polarization: Vertical**

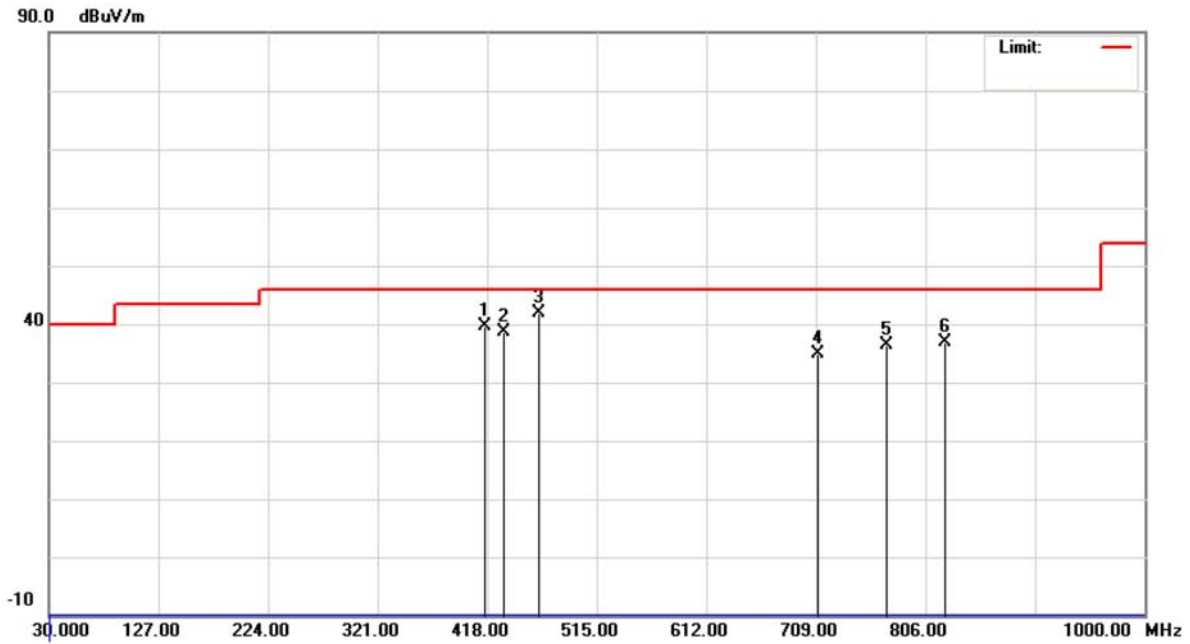

No.	Mk.	Freq. MHz	Reading Level dBuV	Correct Factor dB	Measure- ment dBuV/m	Limit dBuV/m	Over dB	Detector	Comment
1		415.5750	54.71	-15.11	39.60	46.00	-6.40	peak	
2		432.5499	53.42	-14.69	38.73	46.00	-7.27	peak	
3	*	464.0750	55.95	-13.97	41.98	46.00	-4.02	peak	
4		711.4249	44.32	-9.40	34.92	46.00	-11.08	peak	
5		772.0499	44.71	-8.37	36.34	46.00	-9.66	peak	
6		822.9749	44.53	-7.67	36.86	46.00	-9.14	peak	



E.U.T	MONDOCENTER	Model Name	INF-MCENTER
Temperature	26°C	Relative Humidity	60%
Test Voltage	AC 120V/60Hz		
Test Mode	IEEE 802.11a/5200 MHz		

**Polarization: Horizontal**

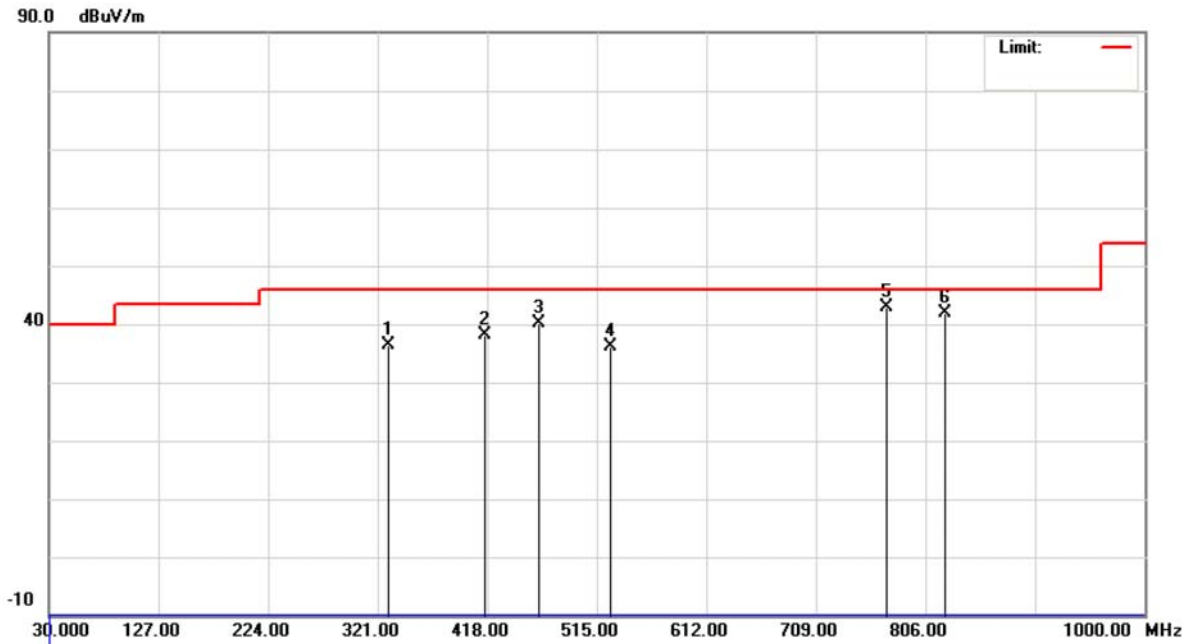

No.	Mk.	Freq. MHz	Reading Level dBuV	Correct Factor dB	Measure- ment dBuV/m	Limit dBuV/m	Over dB	Detector	Comment
1		330.7000	53.89	-17.39	36.50	46.00	-9.50	peak	
2		415.5750	53.31	-15.11	38.20	46.00	-7.80	peak	
3		464.0750	54.03	-13.97	40.06	46.00	-5.94	peak	
4		527.1250	49.04	-13.00	36.04	46.00	-9.96	peak	
5	*	772.0500	51.34	-8.37	42.97	46.00	-3.03	peak	
6		822.9750	49.62	-7.67	41.95	46.00	-4.05	peak	



**8.9 TEST RESULTS - 5250-5350 MHZ**

E.U.T	MONDOCENTER	Model Name	INF-MCENTER
Temperature	26°C	Relative Humidity	60%
Test Voltage	AC 120V/60Hz		
Test Mode	IEEE 802.11n (20 MHz)/5300 MHz		

**Polarization: Vertical**

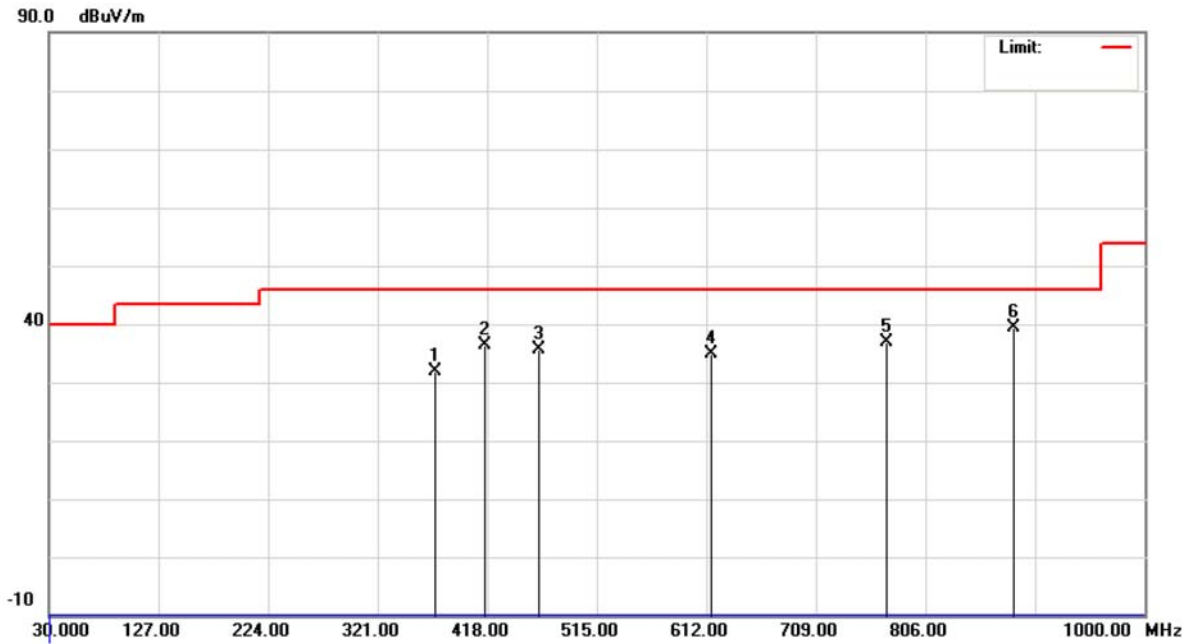

No.	Mk.	Freq. MHz	Reading Level dBuV	Correct Factor dB	Measure- ment dBuV/m	Limit dBuV/m	Over dB	Detector	Comment
1		371.9249	48.34	-16.36	31.98	46.00	-14.02	peak	
2		415.5750	51.60	-15.11	36.49	46.00	-9.51	peak	
3		464.0750	49.48	-13.97	35.51	46.00	-10.49	peak	
4		616.8499	45.51	-10.66	34.85	46.00	-11.15	peak	
5		772.0499	45.36	-8.37	36.99	46.00	-9.01	peak	
6	*	883.5999	46.16	-6.78	39.38	46.00	-6.62	peak	



E.U.T	MONDOCENTER	Model Name	INF-MCENTER
Temperature	26°C	Relative Humidity	60%
Test Voltage	AC 120V/60Hz		
Test Mode	IEEE 802.11n (20 MHz)/5300 MHz		

**Polarization: Horizontal**

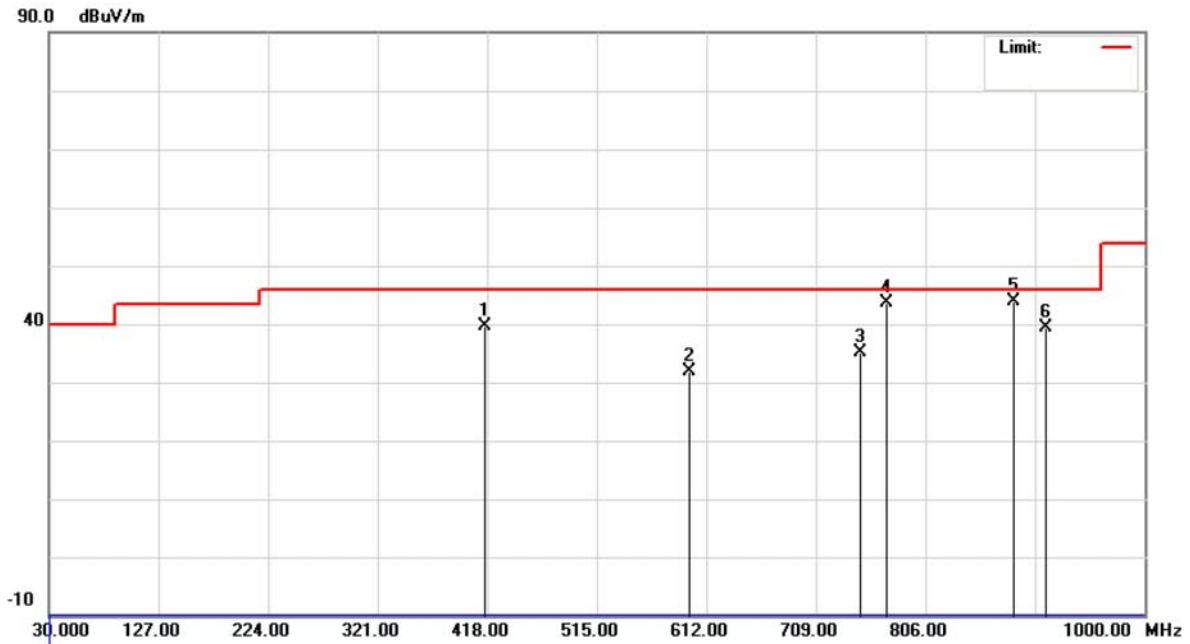

No.	Mk.	Freq. MHz	Reading Level dBuV	Correct Factor dB	Measure- ment dBuV/m	Limit dBuV/m	Over dB	Detector	Comment
1		415.5750	54.63	-15.11	39.52	46.00	-6.48	peak	
2		597.4500	42.93	-10.97	31.96	46.00	-14.04	peak	
3		747.8000	43.80	-8.67	35.13	46.00	-10.87	peak	
4		772.0500	52.11	-8.37	43.74	46.00	-2.26	peak	
5	*	883.6000	50.54	-6.78	43.76	46.00	-2.24	peak	
6		912.7000	45.72	-6.29	39.43	46.00	-6.57	peak	



**8.10 TEST RESULTS - 5470-5725 MHZ**

E.U.T	MONDOCENTER	Model Name	INF-MCENTER
Temperature	26°C	Relative Humidity	60%
Test Voltage	AC 120V/60Hz		
Test Mode	IEEE 802.11n (20 MHz)/5580 MHz		

**Polarization: Vertical**

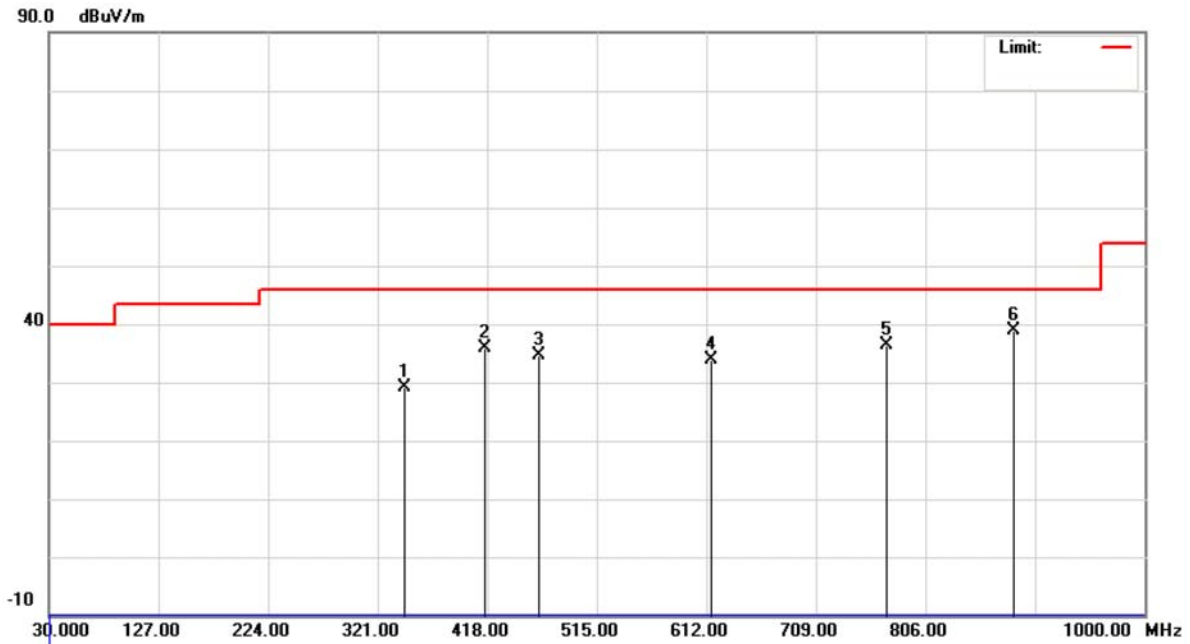

No.	Mk.	Freq. MHz	Reading Level dBuV	Correct Factor dB	Measure- ment dBuV/m	Limit dBuV/m	Over dB	Detector	Comment
1		345.2500	46.29	-17.11	29.18	46.00	-16.82	peak	
2		415.5750	51.10	-15.11	35.99	46.00	-10.01	peak	
3		464.0750	48.48	-13.97	34.51	46.00	-11.49	peak	
4		616.8499	44.51	-10.66	33.85	46.00	-12.15	peak	
5		772.0499	44.86	-8.37	36.49	46.00	-9.51	peak	
6	*	883.5999	45.66	-6.78	38.88	46.00	-7.12	peak	





E.U.T	MONDOCENTER	Model Name	INF-MCENTER
Temperature	26°C	Relative Humidity	60%
Test Voltage	AC 120V/60Hz		
Test Mode	IEEE 802.11n (20 MHz)/5580 MHz		

**Polarization: Horizontal**

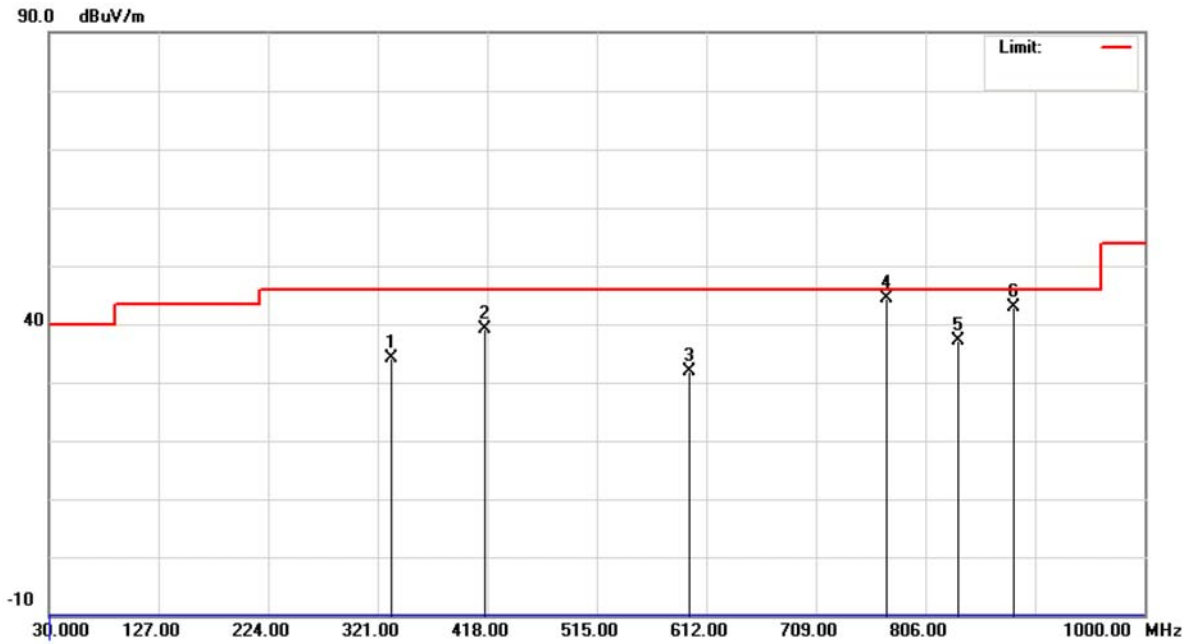

No.	Mk.	Freq. MHz	Reading Level dBuV	Correct Factor dB	Measure- ment dBuV/m	Limit dBuV/m	Over dB	Detector	Comment
1		333.1250	51.58	-17.34	34.24	46.00	-11.76	peak	
2		415.5750	54.13	-15.11	39.02	46.00	-6.98	peak	
3		597.4500	42.93	-10.97	31.96	46.00	-14.04	peak	
4	*	772.0499	52.72	-8.37	44.35	46.00	-1.65	peak	
5		835.0999	44.53	-7.47	37.06	46.00	-8.94	peak	
6		883.5999	49.54	-6.78	42.76	46.00	-3.24	peak	



**9 RADIATED SPURIOUS EMISSION (ABOVE 1 GHZ)**

**9.1 LIMIT**

20dBc in any 100 kHz bandwidth outside the operating frequency band. In case the emission fall within the restricted band specified on 15.205(a), then the 15.209(a) limit in the table below has to be followed.

Frequency Range: 9 kHz to 1 GHz		
FREQUENCY (MHz)	Field Strength (micровolts/meter)	Measurement Distance (meters)
0.009~0.490	2400/F(kHz)	300
0.490~1.705	24000/F(kHz)	30
1.705~30.0	30	30
30~88	100	3
88~216	150	3
216~960	200	3
Above 960	500	3

Frequency Range: above 1 GHz				
FREQUENCY (MHz)	Class A (dBuV/m) (at 3m)		Class B (dBuV/m) (at 3m)	
	PEAK	AVERAGE	PEAK	AVERAGE
above 1 GHz	80	60	74	54

**NOTE:**

- (1) The limit for radiated test was performed according to FCC PART 15B.
- (2) The tighter limit applies at the band edges.
- (3) Emission level (dBuV/m)=20log Emission level (uV/m).
- (4) The test result calculated as following:  
 Measurement Value = Reading Level + Correct Factor  
 Correct Factor = Antenna Factor + Cable Loss – Amplifier Gain(if use)  
 Margin Level = Measurement Value – Limit Value



**9.2 MEASUREMENT INSTRUMENTS LIST**

Item	Kind of Equipment	Manufacturer	Type No.	Serial No.	Calibrated until
1	Spectrum Analyzer	R&S	FSP-40	100129	Oct. 06, 2012
2	Horn Antenna	Schwarzbeck	BBHA 9120	D-325	Apr. 16, 2013
3	Microwave Pre_amplifier	Agilent	8449B	3008A01714	Apr. 17, 2013
4	Microflex Cable	N/A	N/A	1m	Apr. 14, 2013
5	Microflex Cable	AISI	S104-SMAP-1	10m	Apr. 14, 2013
6	Microflex Cable	N/A	N/A	3m	Apr. 14, 2013
7	Test Cable	N/A	LMR-400	966_12m	May. 15, 2013
8	Test Cable	N/A	LMR-400	966_3m	May. 15, 2013
9	Pre-Amplifier	EMC	EMC-330	980081	Jun. 07, 2013
10	Log-Bicon Antenna	Schwarzbeck	VULB9168-352	9168-352	Jun. 12, 2013
11	Horn Antenna	Schwarzbeck	BBHA 9170	187	Dec. 18, 2012
12	Preamplifier With Adaptor	EMC	EMC2654045	980030	Feb. 19, 2013

Remark: "N/A" denotes No Model Name, No Serial No. or No Calibration specified.

**9.3 MEASURING INSTRUMENTS SETTING**

Spectrum Analyzer	Parameter Setting
Attenuation	Auto
Start Frequency	1000 MHz
Stop Frequency	10th carrier harmonic
RB / VB (emission in restricted band)	1MHz / 1MHz for Peak, 1 MHz / 10Hz for Average
RB / VB (other emission)	1MHz / 1MHz for Peak, 1 MHz / 10Hz for Average



### 9.4 TEST PROCEDURES

- a. The measuring distance of at 1 m shall be used for measurements at frequency up to 1 GHz. For frequencies above 1 GHz, any suitable measuring distance may be used.
- b. The EUT was placed on the top of a rotating table 0.8 meters above the ground at a 3m Semi-anechoic chamber. The table was rotated 360 degrees to determine the position of the highest radiation.
- c. The height of the equipment or of the substitution antenna shall be 0.8 m; the height of the test antenna shall vary between 1 m to 4 m. Both horizontal and vertical polarizations of the antenna are set to make the measurement.
- d. The initial step in collecting conducted emission data is a spectrum analyzer peak detector mode pre-scanning the measurement frequency range. Significant peaks are then marked and then Quasi Peak detector mode re-measured.
- e. If the Peak Mode measured value compliance with and lower than Quasi Peak Mode Limit, the EUT shall be deemed to meet QP Limits and then no additional QP Mode measurement performed.
- f. For the actual test configuration, please refer to the related Item –EUT Test Photos.
- g. The testing follows the guidelines in ANSI C63.4 and FCC Public Notice DA 00-705 Measurement Guidelines. In case the emission is fail due to the used RBW/VBW is too wide, marker-delta method of FCC Public Notice DA 00-705 will be followed.

**NOTE:**

- a. Reading in which marked as Peak means measurements by using are Peak Mode with instrument setting in RBW= 1 MHz, VBW= 1 MHz, Swp. Time = Auto.  
Reading in which marked as AV means measurements by using are Average Mode with instrument setting in RBW= 1 MHz, VBW= 10 Hz, Swp. Time = Auto.
- b. All readings are Peak Mode value unless otherwise stated AVG in column of Note. If the Peak Mode Measured value compliance with the Peak Limits and lower than AVG Limits, the EUT shall be deemed to meet both Peak & AVG Limits and then only Peak Mode was measured, but AVG Mode didn't perform.

### 9.5 DEVIATION FROM TEST STANDARD

No deviation

### 9.6 TEST SETUP LAYOUT

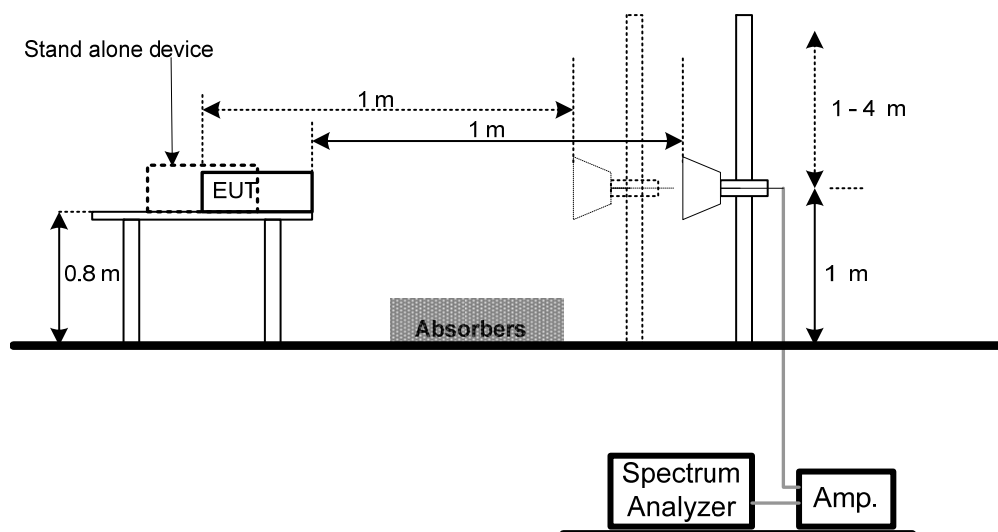



## **9.7 EUT OPERATING CONDITIONS**

The EUT tested system was configured as the statements of 5.6 Unless otherwise a special operating condition is specified in the follows during the testing.



**9.8 TEST RESULTS - 5150-5250 MHZ**

E.U.T	MONDOCENTER	Model Name	INF-MCENTER
Temperature	26°C	Relative Humidity	60%
Test Voltage	AC 120V/60Hz		
Test Mode	IEEE 802.11a/5180 MHz		

**Polarization: Vertical**

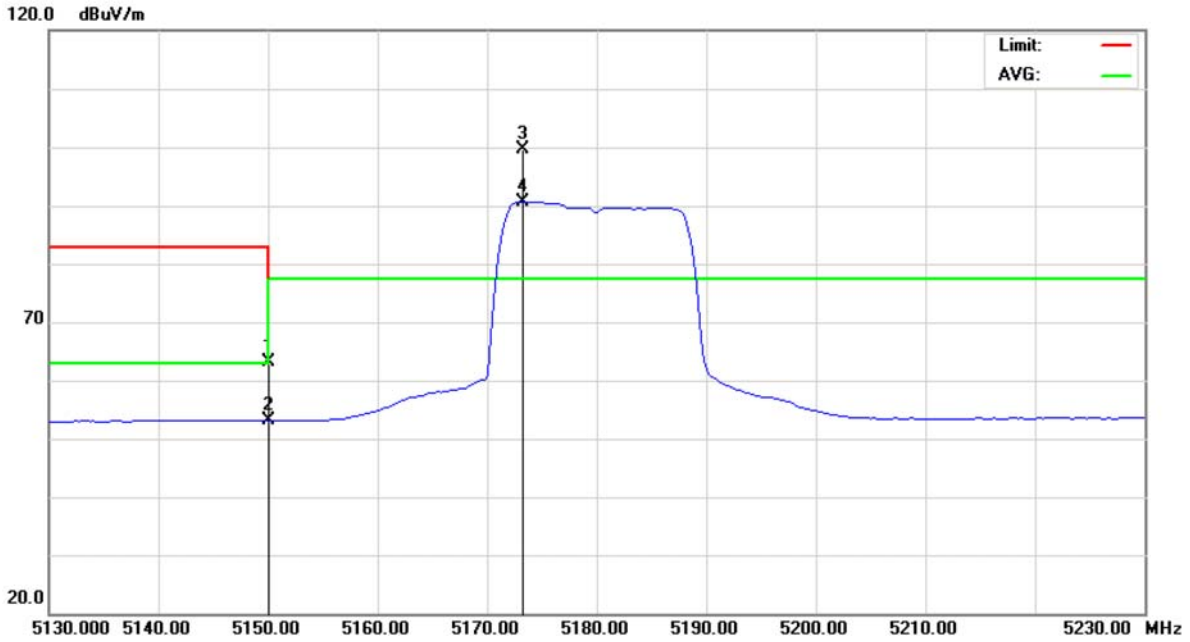

No.	Mk.	Freq. MHz	Reading Level dBuV	Correct Factor dB	Measure- ment dBuV/m	Limit dBuV/m	Over dB	Detector	Comment
1		5150.000	22.25	40.92	63.17	77.30	-14.13	peak	
2		5150.000	12.19	40.92	53.11	63.00	-9.89	AVG	
3	*	5173.250	58.61	40.96	99.57	77.30	22.27	peak	
4	X	5173.250	49.69	40.96	90.65	77.30	13.35	AVG	



E.U.T	MONDOCENTER	Model Name	INF-MCENTER
Temperature	26°C	Relative Humidity	60%
Test Voltage	AC 120V/60Hz		
Test Mode	IEEE 802.11a/5180 MHz		

**Polarization: Vertical**

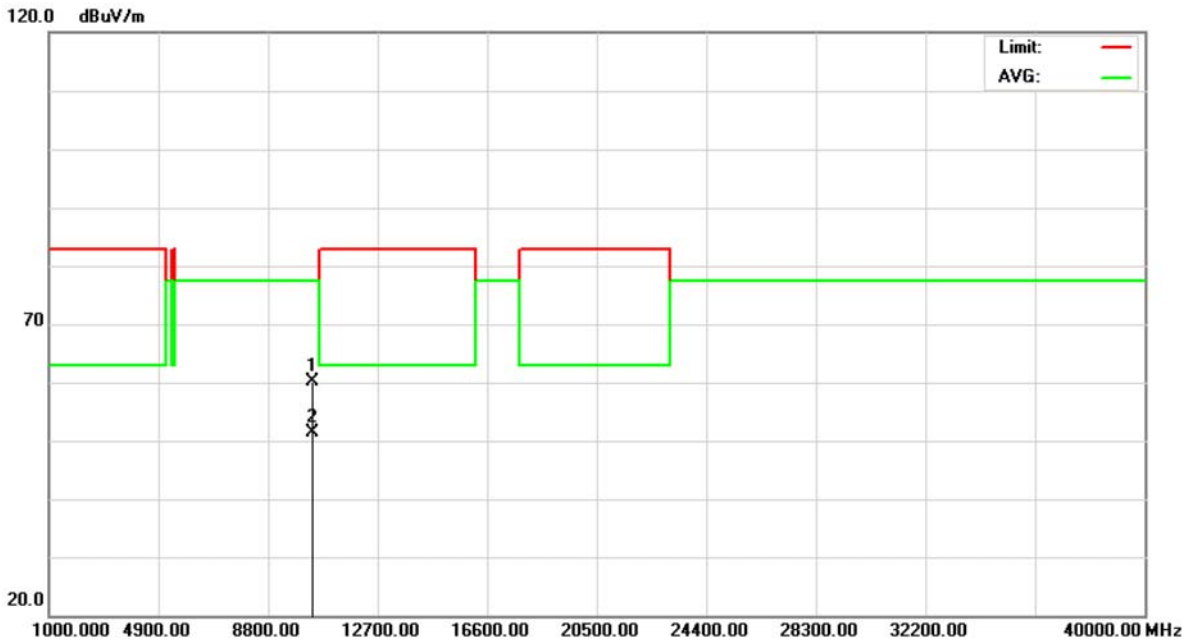

No.	Mk.	Freq. MHz	Reading Level dBuV	Correct Factor dB	Measure- ment dBuV/m	Limit dBuV/m	Over dB	Detector	Comment
1	*	10360.00	40.21	19.90	60.11	77.30	-17.19	peak	
2		10360.00	31.55	19.90	51.45	77.30	-25.85	AVG	



E.U.T	MONDOCENTER	Model Name	INF-MCENTER
Temperature	26°C	Relative Humidity	60%
Test Voltage	AC 120V/60Hz		
Test Mode	IEEE 802.11a/5180 MHz		

**Polarization: Horizontal**

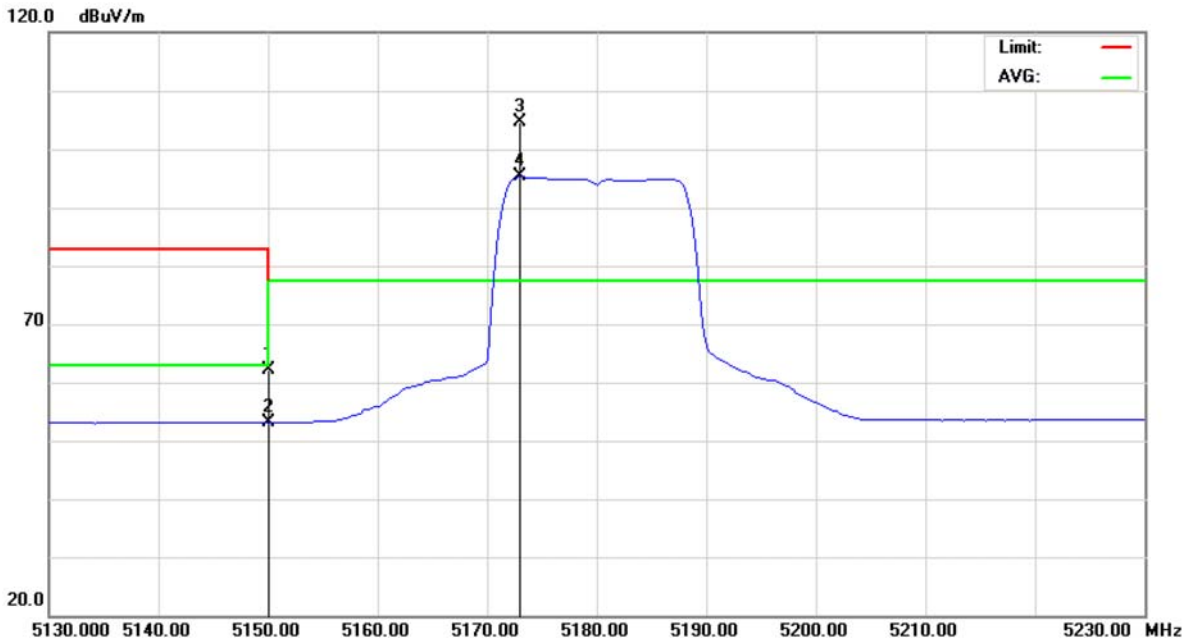

No.	Mk.	Freq. MHz	Reading Level dBuV	Correct Factor dB	Measure- ment dBuV/m	Limit dBuV/m	Over dB	Detector	Comment
1		5150.000	21.14	40.92	62.06	77.30	-15.24	peak	
2		5150.000	12.27	40.92	53.19	63.00	-9.81	AVG	
3	*	5173.000	63.70	40.96	104.66	77.30	27.36	peak	
4	X	5173.000	54.32	40.96	95.28	77.30	17.98	AVG	





E.U.T	MONDOCENTER	Model Name	INF-MCENTER
Temperature	26°C	Relative Humidity	60%
Test Voltage	AC 120V/60Hz		
Test Mode	IEEE 802.11a/5180 MHz		

**Polarization: Horizontal**

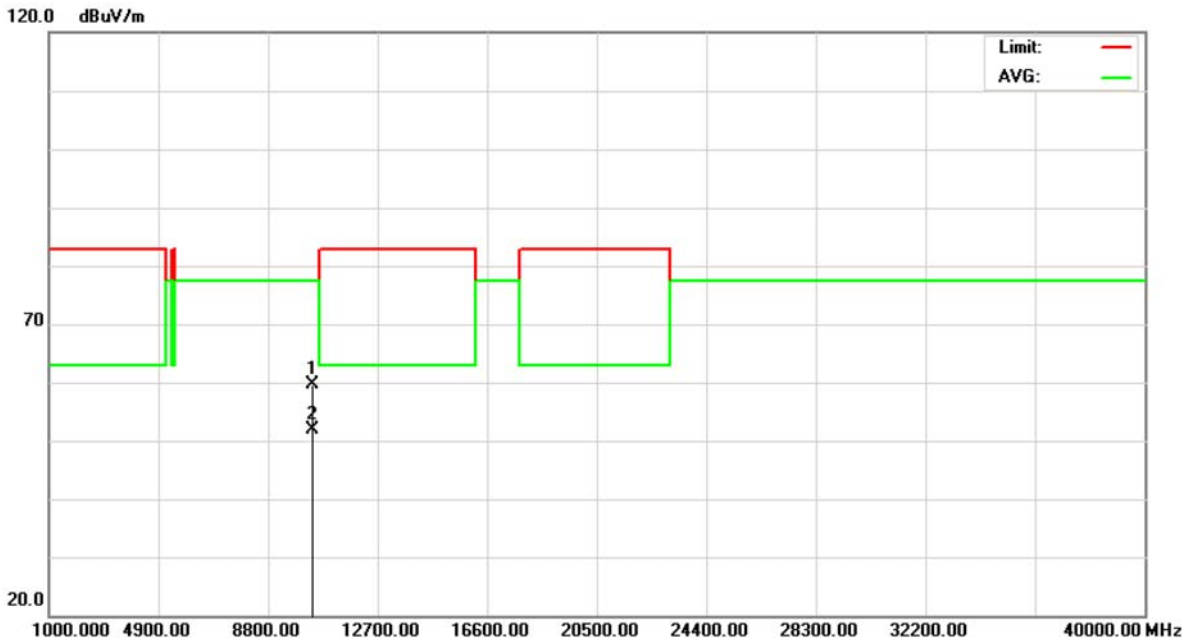

No.	Mk.	Freq. MHz	Reading Level dBuV	Correct Factor dB	Measure- ment dBuV/m	Limit dBuV/m	Over dB	Detector	Comment
1	*	10357.72	39.76	19.89	59.65	77.30	-17.65	peak	
2		10357.72	31.98	19.89	51.87	77.30	-25.43	AVG	



E.U.T	MONDOCENTER	Model Name	INF-MCENTER
Temperature	26°C	Relative Humidity	60%
Test Voltage	AC 120V/60Hz		
Test Mode	IEEE 802.11a/5200 MHz		

**Polarization: Vertical**

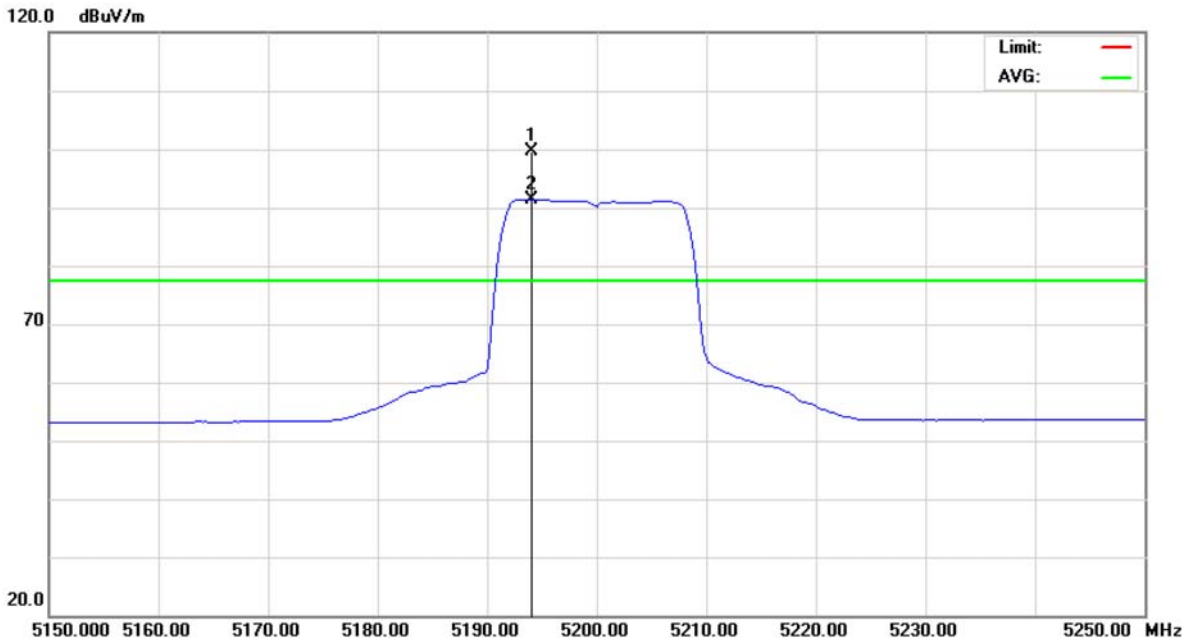

No.	Mk.	Freq. MHz	Reading Level dBuV	Correct Factor dB	Measure- ment dBuV/m	Limit dBuV/m	Over dB	Detector	Comment
1	*	5194.000	58.74	40.99	99.73	77.30	22.43	peak	
2	X	5194.000	50.41	40.99	91.40	77.30	14.10	AVG	



E.U.T	MONDOCENTER	Model Name	INF-MCENTER
Temperature	26°C	Relative Humidity	60%
Test Voltage	AC 120V/60Hz		
Test Mode	IEEE 802.11a/5200 MHz		

**Polarization: Vertical**

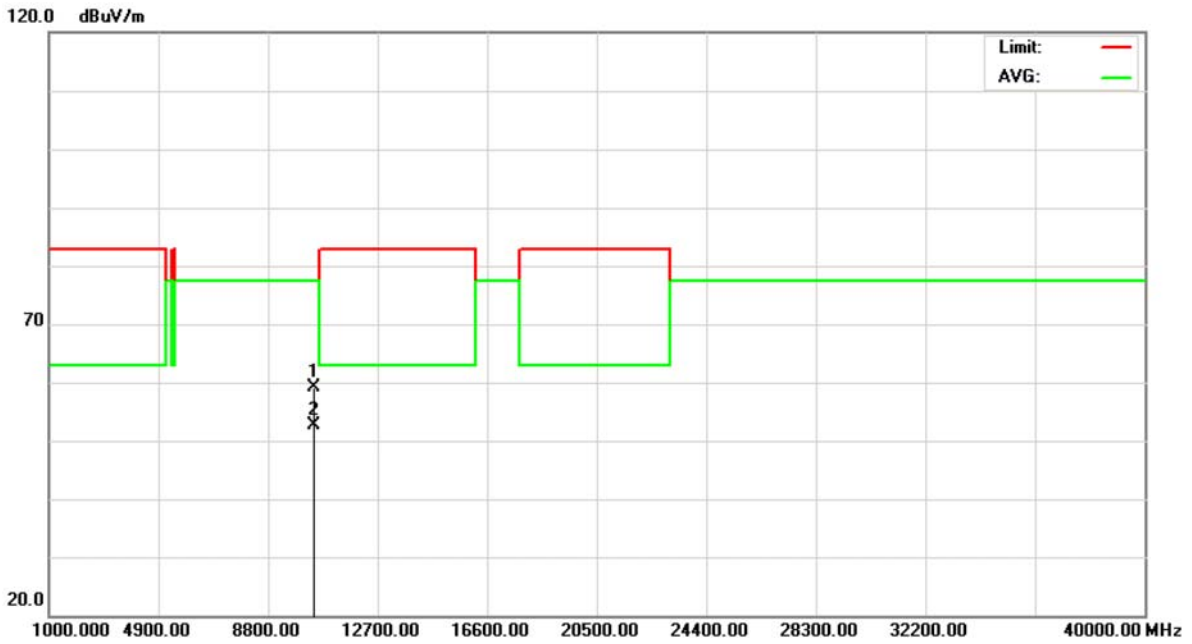

No.	Mk.	Freq. MHz	Reading Level dBuV	Correct Factor dB	Measure- ment dBuV/m	Limit dBuV/m	Over dB	Detector	Comment
1	*	10397.50	39.10	20.00	59.10	77.30	-18.20	peak	
2		10397.50	32.69	20.00	52.69	77.30	-24.61	AVG	



E.U.T	MONDOCENTER	Model Name	INF-MCENTER
Temperature	26°C	Relative Humidity	60%
Test Voltage	AC 120V/60Hz		
Test Mode	IEEE 802.11a/5200 MHz		

**Polarization: Horizontal**

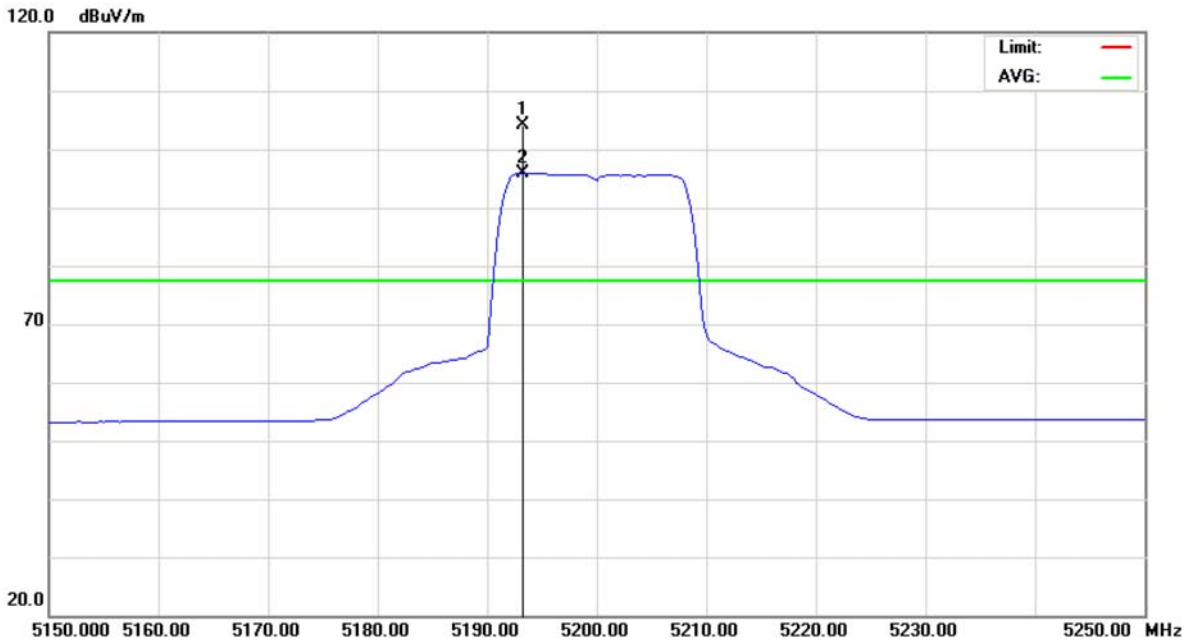

No.	Mk.	Freq. MHz	Reading Level dBuV	Correct Factor dB	Measure- ment dBuV/m	Limit dBuV/m	Over dB	Detector	Comment
1	*	5193.250	63.04	40.99	104.03	77.30	26.73	peak	
2	X	5193.250	55.01	40.99	96.00	77.30	18.70	AVG	



E.U.T	MONDOCENTER	Model Name	INF-MCENTER
Temperature	26°C	Relative Humidity	60%
Test Voltage	AC 120V/60Hz		
Test Mode	IEEE 802.11a/5200 MHz		

**Polarization: Horizontal**

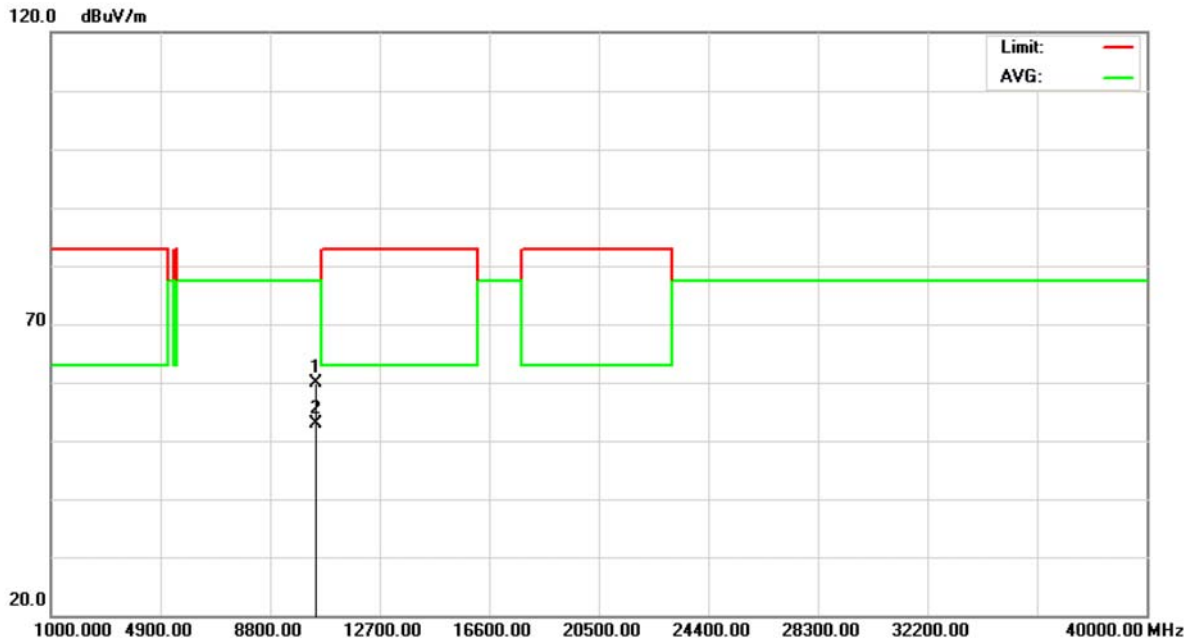

No.	Mk.	Freq. MHz	Reading Level dBuV	Correct Factor dB	Measure- ment dBuV/m	Limit dBuV/m	Over dB	Detector	Comment
1	*	10389.25	39.83	19.98	59.81	77.30	-17.49	peak	
2		10389.25	32.88	19.98	52.86	77.30	-24.44	AVG	



E.U.T	MONDOCENTER	Model Name	INF-MCENTER
Temperature	26°C	Relative Humidity	60%
Test Voltage	AC 120V/60Hz		
Test Mode	IEEE 802.11a/5240 MHz		

**Polarization: Vertical**

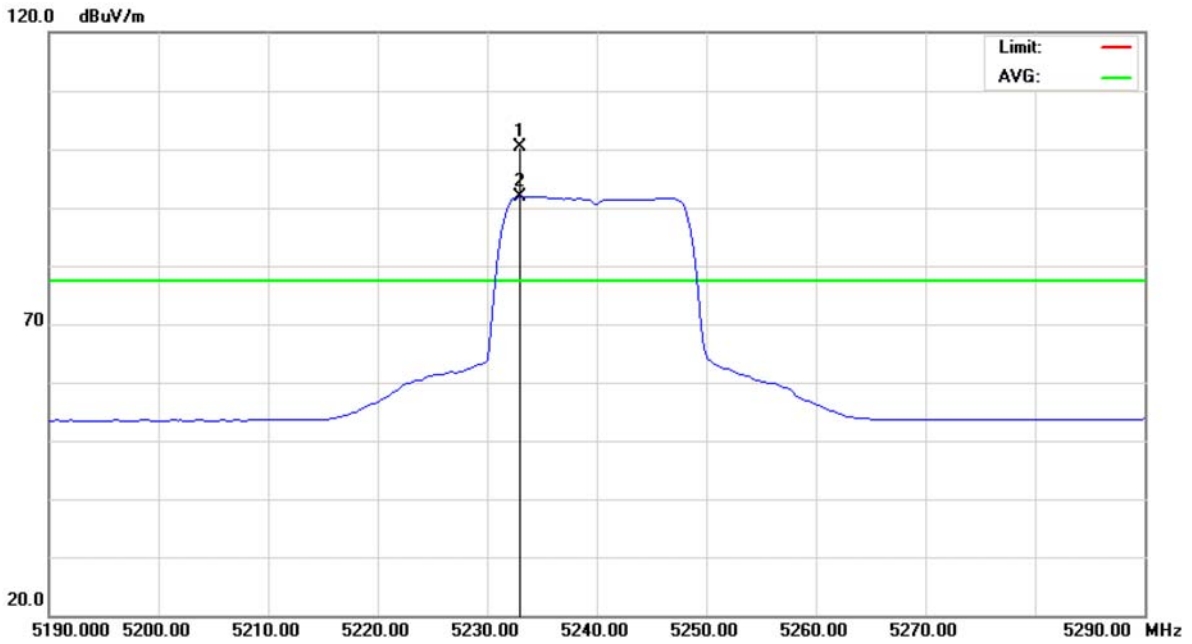

No.	Mk.	Freq. MHz	Reading Level dBuV	Correct Factor dB	Measure- ment dBuV/m	Limit dBuV/m	Over dB	Detector	Comment
1	*	5233.000	59.41	41.05	100.46	77.30	23.16	peak	
2	X	5233.000	50.84	41.05	91.89	77.30	14.59	AVG	



E.U.T	MONDOCENTER	Model Name	INF-MCENTER
Temperature	26°C	Relative Humidity	60%
Test Voltage	AC 120V/60Hz		
Test Mode	IEEE 802.11a/5240 MHz		

**Polarization: Vertical**

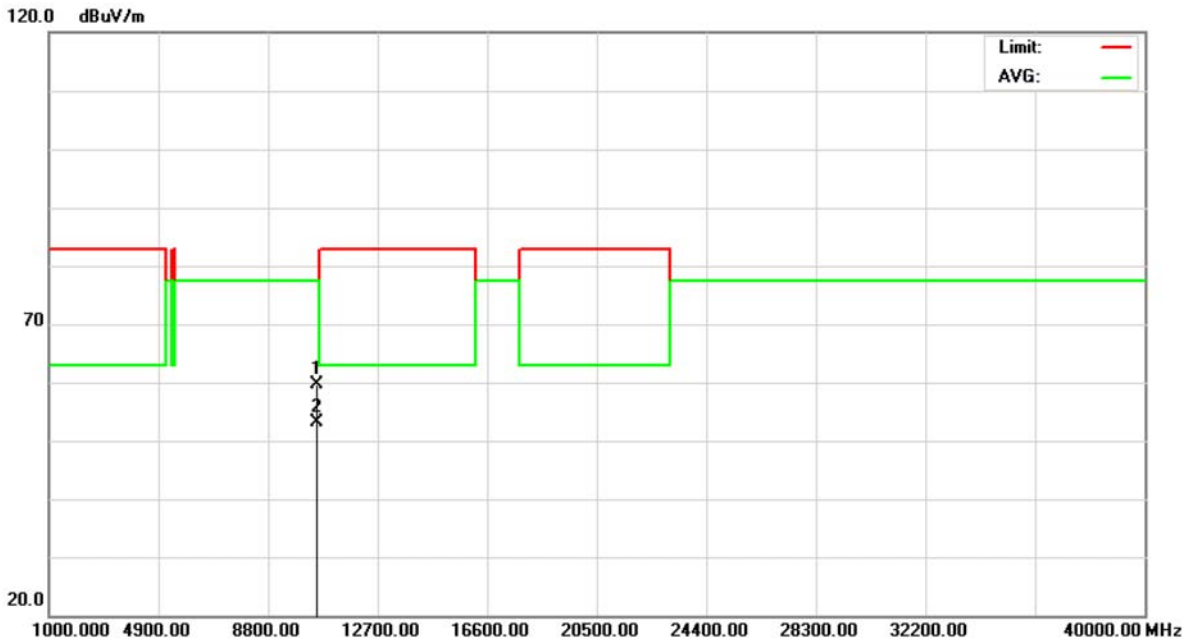

No.	Mk.	Freq. MHz	Reading Level dBuV	Correct Factor dB	Measure- ment dBuV/m	Limit dBuV/m	Over dB	Detector	Comment
1	*	10480.50	39.48	20.23	59.71	77.30	-17.59	peak	
2		10480.50	32.88	20.23	53.11	77.30	-24.19	AVG	



E.U.T	MONDOCENTER	Model Name	INF-MCENTER
Temperature	26°C	Relative Humidity	60%
Test Voltage	AC 120V/60Hz		
Test Mode	IEEE 802.11a/5240 MHz		

**Polarization: Horizontal**

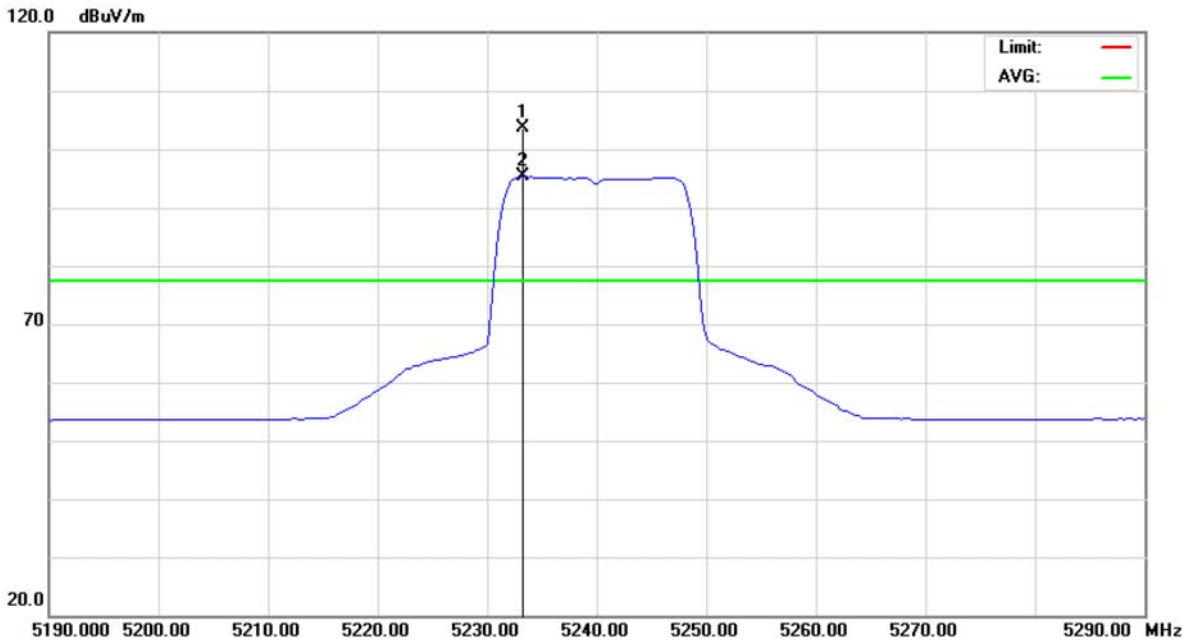

No.	Mk.	Freq. MHz	Reading Level dBuV	Correct Factor dB	Measure- ment dBuV/m	Limit dBuV/m	Over dB	Detector	Comment
1	*	5233.250	62.57	41.05	103.62	77.30	26.32	peak	
2	X	5233.250	54.26	41.05	95.31	77.30	18.01	AVG	





E.U.T	MONDOCENTER	Model Name	INF-MCENTER
Temperature	26°C	Relative Humidity	60%
Test Voltage	AC 120V/60Hz		
Test Mode	IEEE 802.11a/5240 MHz		

**Polarization: Horizontal**

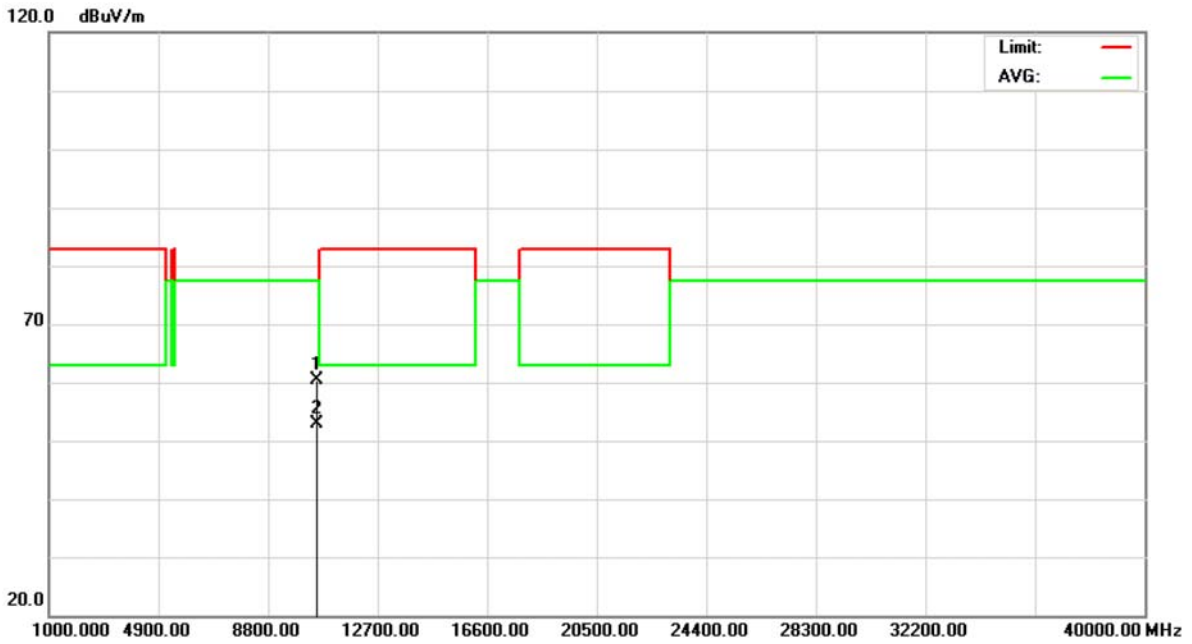

No.	Mk.	Freq. MHz	Reading Level dBuV	Correct Factor dB	Measure- ment dBuV/m	Limit dBuV/m	Over dB	Detector	Comment
1	*	10480.50	40.20	20.23	60.43	77.30	-16.87	peak	
2		10480.50	32.56	20.23	52.79	77.30	-24.51	AVG	



E.U.T	MONDOCENTER	Model Name	INF-MCENTER
Temperature	26°C	Relative Humidity	60%
Test Voltage	AC 120V/60Hz		
Test Mode	IEEE 802.11n (20 MHz)/5180 MHz		

**Polarization: Vertical**

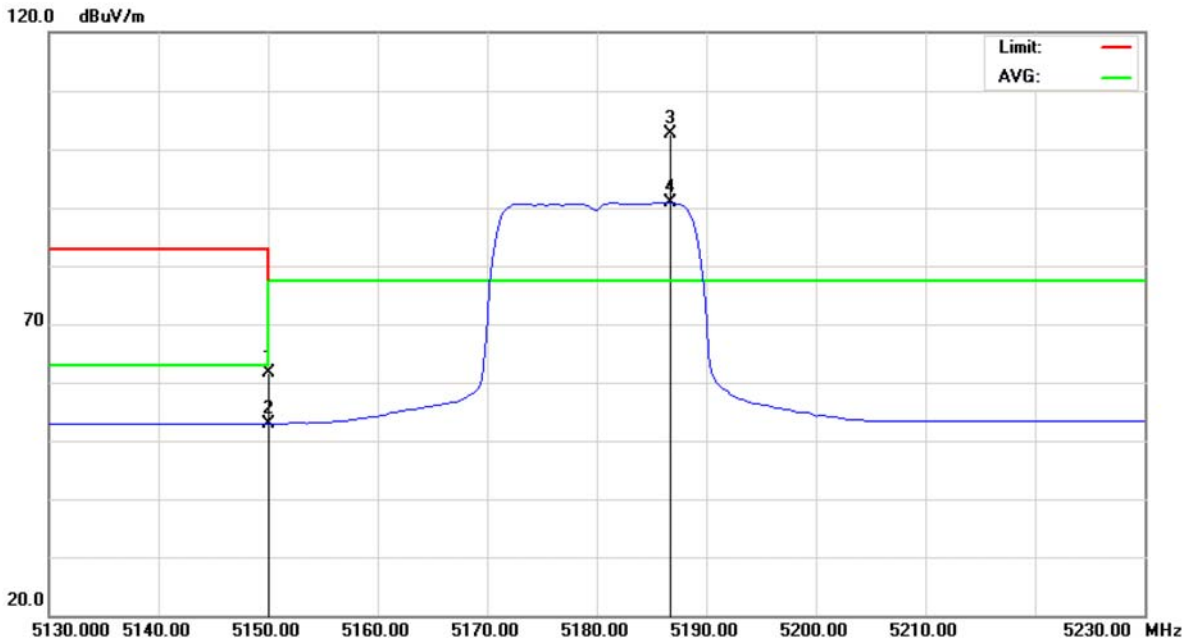

No.	Mk.	Freq. MHz	Reading Level dBuV	Correct Factor dB	Measure- ment dBuV/m	Limit dBuV/m	Over dB	Detector	Comment
1		5150.000	20.68	40.92	61.60	77.30	-15.70	peak	
2		5150.000	12.04	40.92	52.96	63.00	-10.04	AVG	
3	*	5186.750	61.56	40.98	102.54	77.30	25.24	peak	
4	X	5186.750	49.90	40.98	90.88	77.30	13.58	AVG	



E.U.T	MONDOCENTER	Model Name	INF-MCENTER
Temperature	26°C	Relative Humidity	60%
Test Voltage	AC 120V/60Hz		
Test Mode	IEEE 802.11n (20 MHz)/5180 MHz		

**Polarization: Vertical**

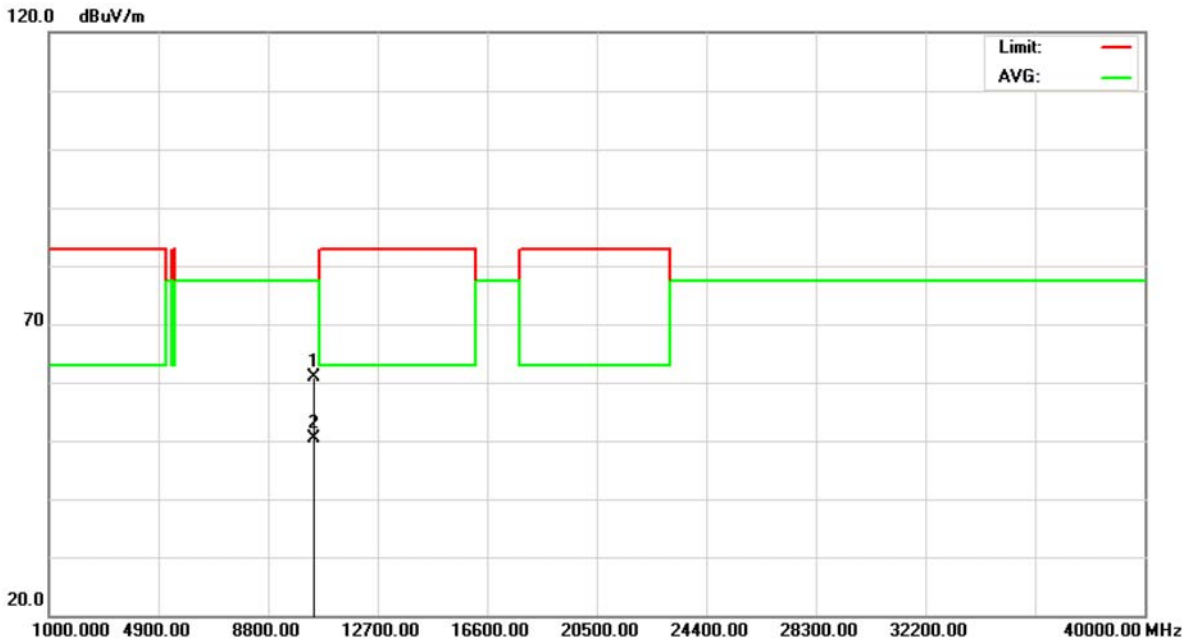

No.	Mk.	Freq. MHz	Reading Level dBuV	Correct Factor dB	Measure- ment dBuV/m	Limit dBuV/m	Over dB	Detector	Comment
1	*	10360.38	41.03	19.90	60.93	77.30	-16.37	peak	
2		10360.38	30.50	19.90	50.40	77.30	-26.90	AVG	



E.U.T	MONDOCENTER	Model Name	INF-MCENTER
Temperature	26°C	Relative Humidity	60%
Test Voltage	AC 120V/60Hz		
Test Mode	IEEE 802.11n (20 MHz)/5180 MHz		

**Polarization: Horizontal**

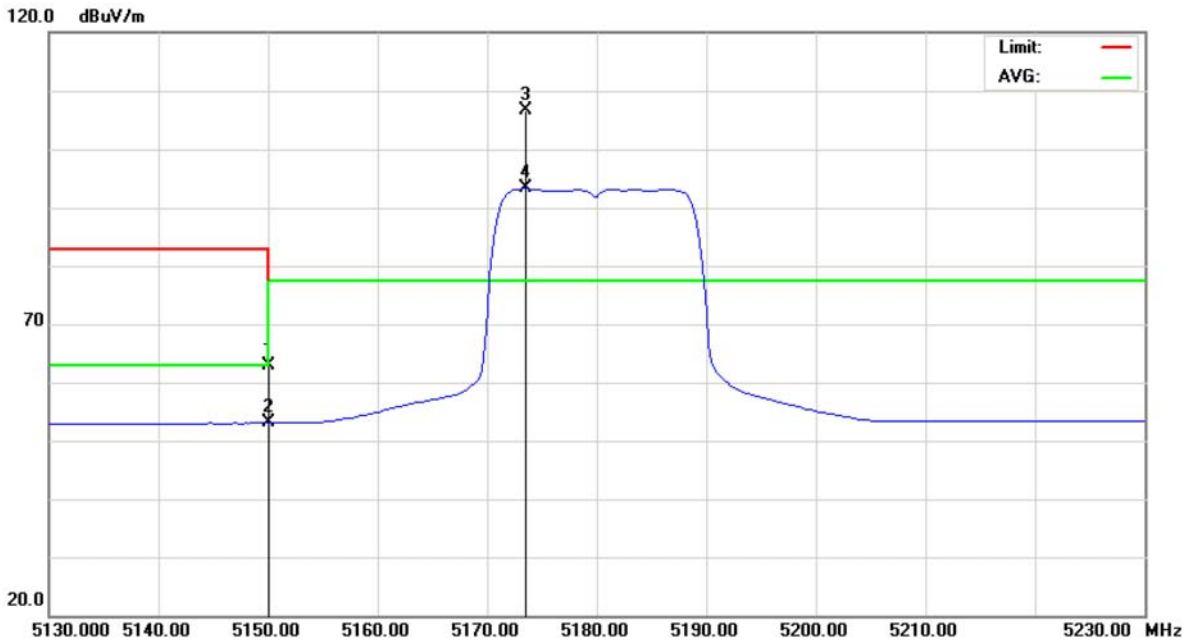

No.	Mk.	Freq. MHz	Reading Level dBuV	Correct Factor dB	Measure- ment dBuV/m	Limit dBuV/m	Over dB	Detector	Comment
1		5150.000	21.85	40.92	62.77	77.30	-14.53	peak	
2		5150.000	12.13	40.92	53.05	63.00	-9.95	AVG	
3	*	5173.500	65.56	40.96	106.52	77.30	29.22	peak	
4	X	5173.500	52.31	40.96	93.27	77.30	15.97	AVG	



E.U.T	MONDOCENTER	Model Name	INF-MCENTER
Temperature	26°C	Relative Humidity	60%
Test Voltage	AC 120V/60Hz		
Test Mode	IEEE 802.11n (20 MHz)/5180 MHz		

**Polarization: Horizontal**

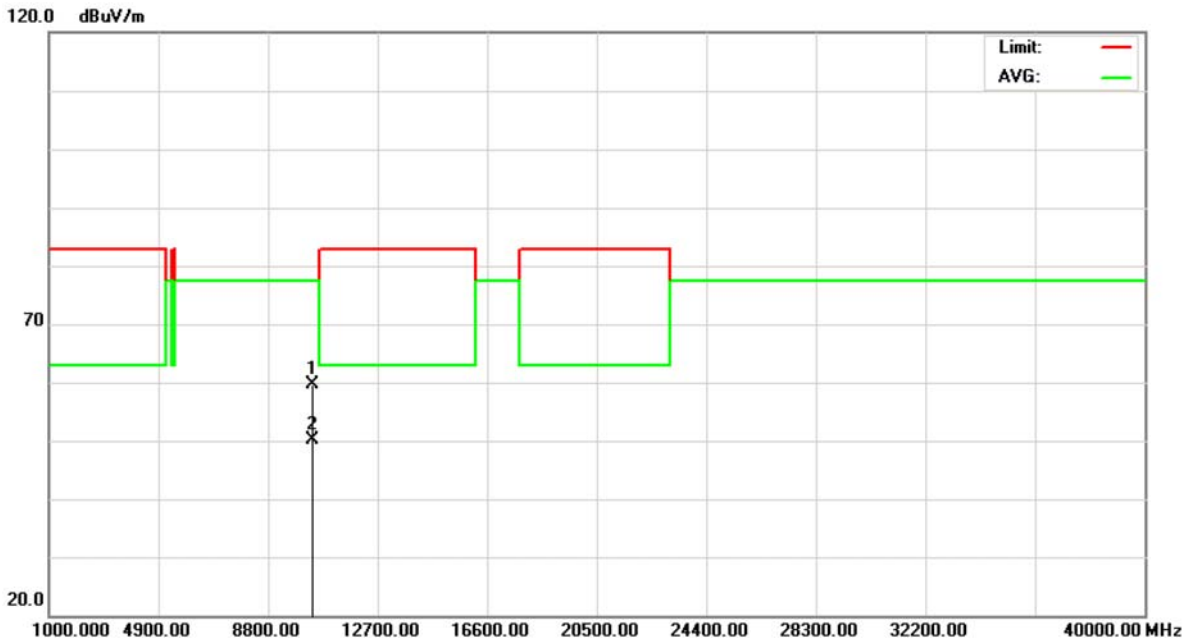

No.	Mk.	Freq. MHz	Reading Level dBuV	Correct Factor dB	Measure- ment dBuV/m	Limit dBuV/m	Over dB	Detector	Comment
1	*	10359.75	39.81	19.89	59.70	77.30	-17.60	peak	
2		10359.75	30.34	19.89	50.23	77.30	-27.07	AVG	



E.U.T	MONDOCENTER	Model Name	INF-MCENTER
Temperature	26°C	Relative Humidity	60%
Test Voltage	AC 120V/60Hz		
Test Mode	IEEE 802.11n (20 MHz)/5200 MHz		

**Polarization: Vertical**

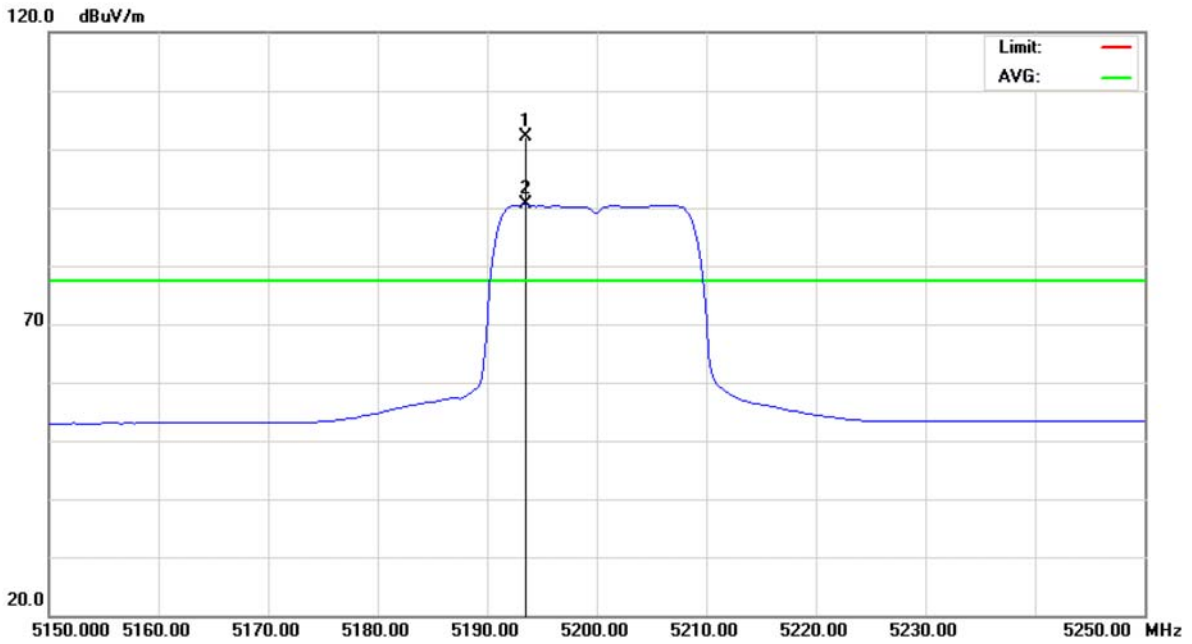

No.	Mk.	Freq. MHz	Reading Level dBuV	Correct Factor dB	Measure- ment dBuV/m	Limit dBuV/m	Over dB	Detector	Comment
1	*	5193.500	61.26	40.99	102.25	77.30	24.95	peak	
2	X	5193.500	49.53	40.99	90.52	77.30	13.22	AVG	



E.U.T	MONDOCENTER	Model Name	INF-MCENTER
Temperature	26°C	Relative Humidity	60%
Test Voltage	AC 120V/60Hz		
Test Mode	IEEE 802.11n (20 MHz)/5200 MHz		

**Polarization: Vertical**

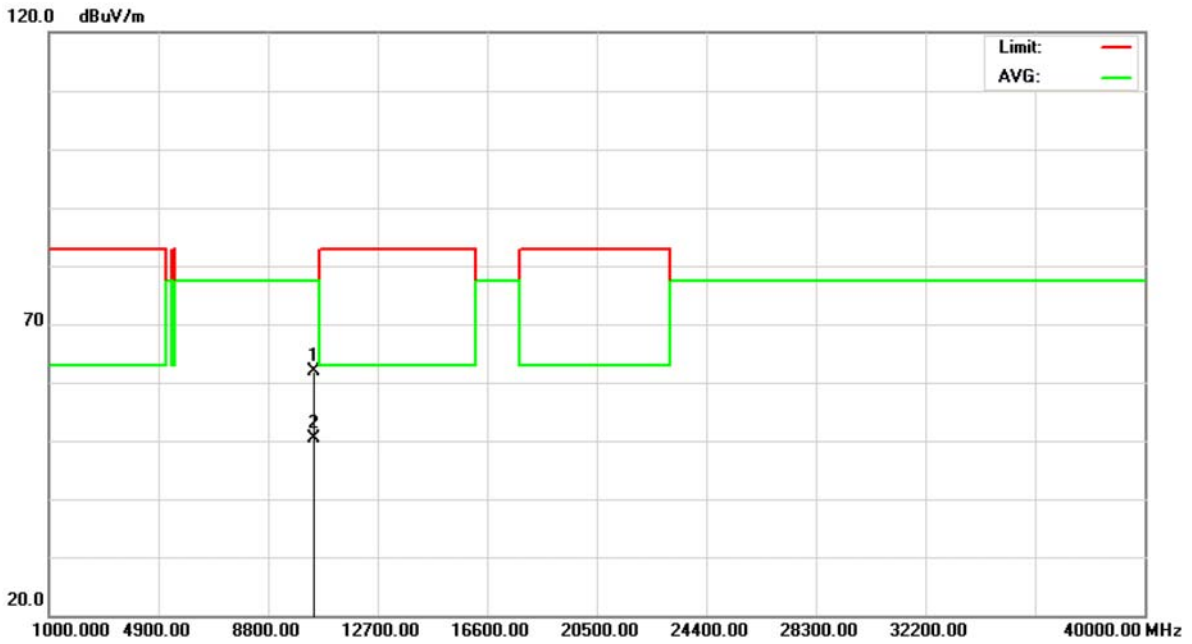

No.	Mk.	Freq. MHz	Reading Level dBuV	Correct Factor dB	Measure- ment dBuV/m	Limit dBuV/m	Over dB	Detector	Comment
1	*	10408.25	41.97	20.03	62.00	77.30	-15.30	peak	
2		10408.25	30.38	20.03	50.41	77.30	-26.89	AVG	



E.U.T	MONDOCENTER	Model Name	INF-MCENTER
Temperature	26°C	Relative Humidity	60%
Test Voltage	AC 120V/60Hz		
Test Mode	IEEE 802.11n (20 MHz)/5200 MHz		

**Polarization: Horizontal**

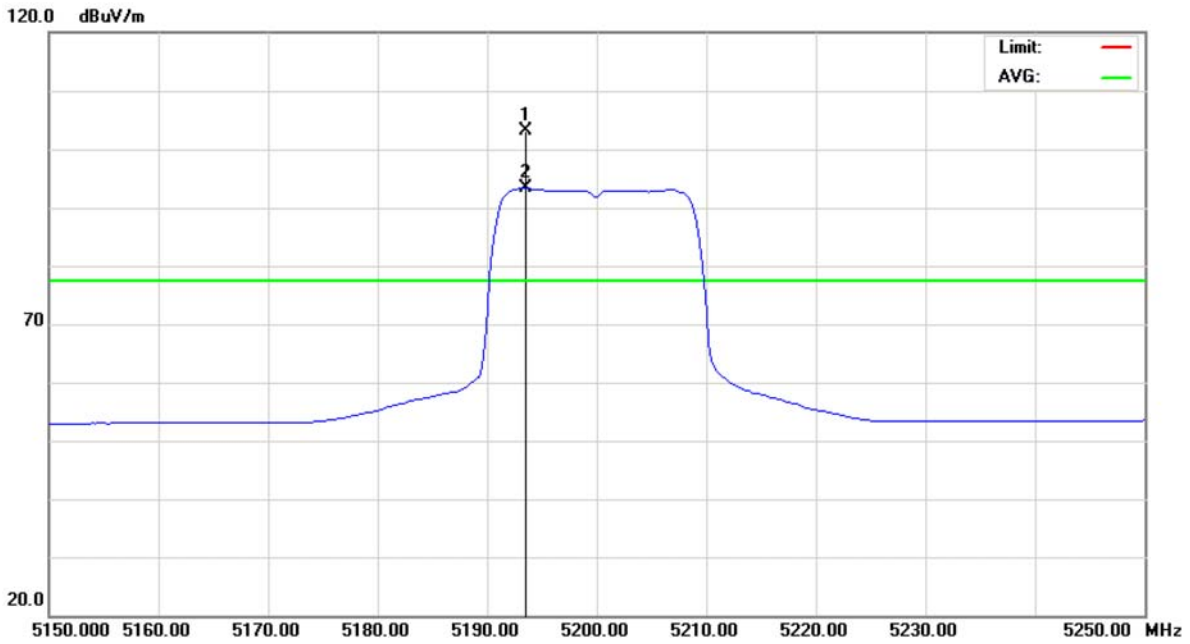

No.	Mk.	Freq. MHz	Reading Level dBuV	Correct Factor dB	Measure- ment dBuV/m	Limit dBuV/m	Over dB	Detector	Comment
1	*	5193.500	62.02	40.99	103.01	77.30	25.71	peak	
2	X	5193.500	52.35	40.99	93.34	77.30	16.04	AVG	





E.U.T	MONDOCENTER	Model Name	INF-MCENTER
Temperature	26°C	Relative Humidity	60%
Test Voltage	AC 120V/60Hz		
Test Mode	IEEE 802.11n (20 MHz)/5200 MHz		

**Polarization: Horizontal**

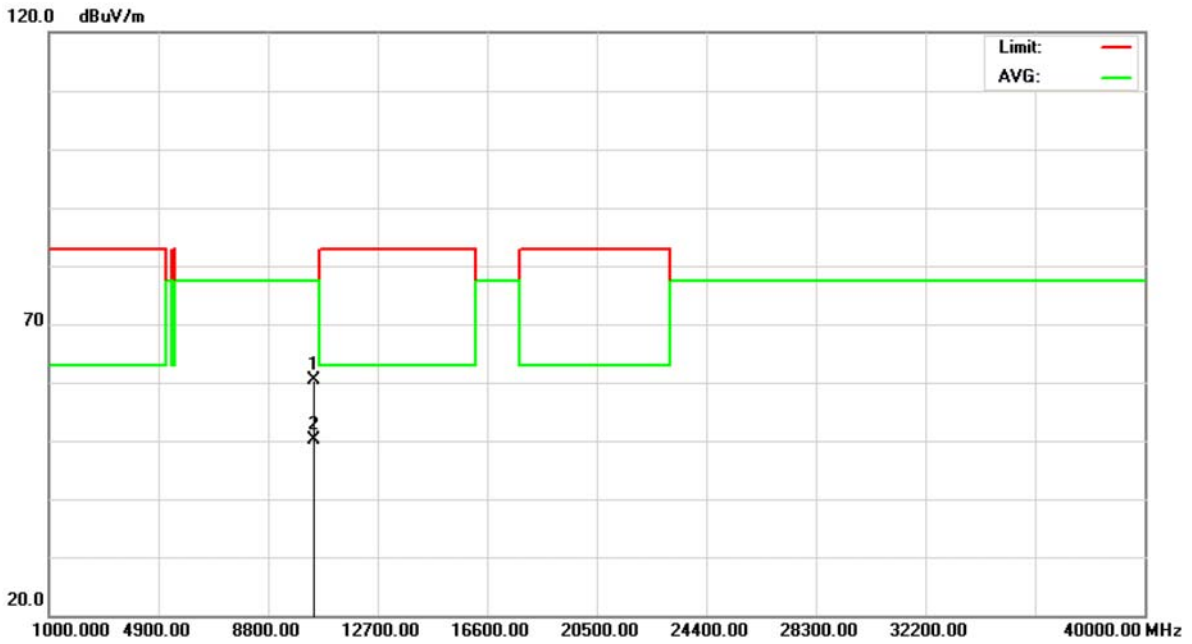

No.	Mk.	Freq. MHz	Reading Level dBuV	Correct Factor dB	Measure- ment dBuV/m	Limit dBuV/m	Over dB	Detector	Comment
1	*	10399.50	40.34	20.01	60.35	77.30	-16.95	peak	
2		10399.50	30.23	20.01	50.24	77.30	-27.06	AVG	



E.U.T	MONDOCENTER	Model Name	INF-MCENTER
Temperature	26°C	Relative Humidity	60%
Test Voltage	AC 120V/60Hz		
Test Mode	IEEE 802.11n (20 MHz)/5240 MHz		

**Polarization: Vertical**

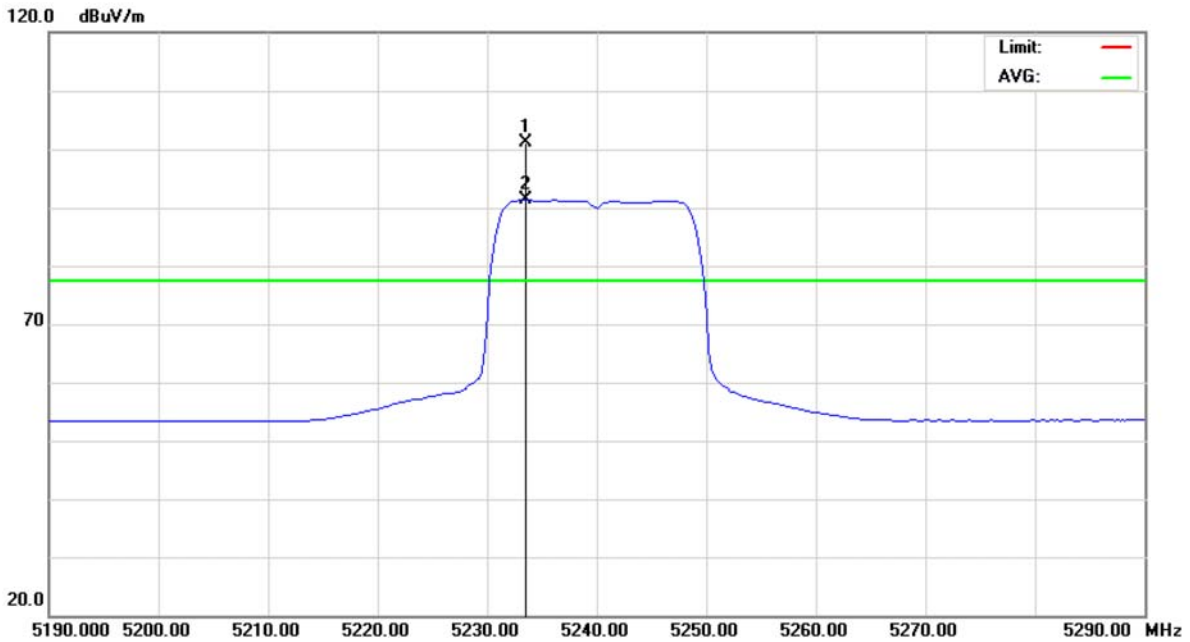

No.	Mk.	Freq. MHz	Reading Level dBuV	Correct Factor dB	Measure- ment dBuV/m	Limit dBuV/m	Over dB	Detector	Comment
1	*	5233.500	60.03	41.05	101.08	77.30	23.78	peak	
2	X	5233.500	50.33	41.05	91.38	77.30	14.08	AVG	



E.U.T	MONDOCENTER	Model Name	INF-MCENTER
Temperature	26°C	Relative Humidity	60%
Test Voltage	AC 120V/60Hz		
Test Mode	IEEE 802.11n (20 MHz)/5240 MHz		

**Polarization: Vertical**

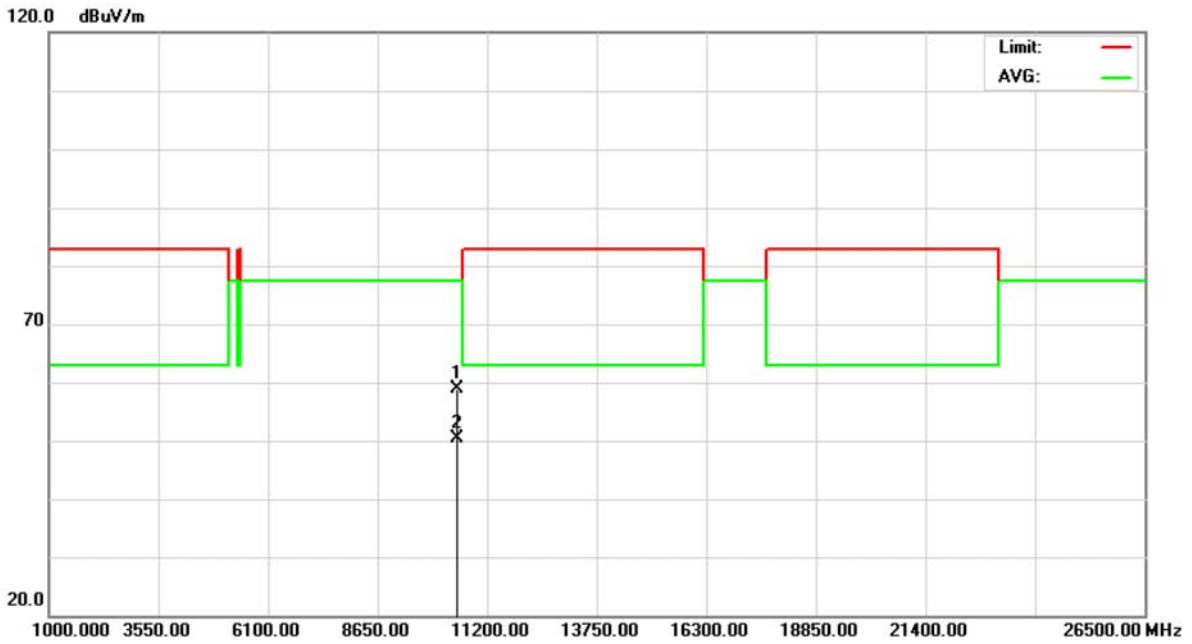

No.	Mk.	Freq. MHz	Reading Level dBuV	Correct Factor dB	Measure- ment dBuV/m	Limit dBuV/m	Over dB	Detector	Comment
1	*	10479.25	38.56	20.23	58.79	77.30	-18.51	peak	
2		10479.25	30.17	20.23	50.40	77.30	-26.90	AVG	



E.U.T	MONDOCENTER	Model Name	INF-MCENTER
Temperature	26°C	Relative Humidity	60%
Test Voltage	AC 120V/60Hz		
Test Mode	IEEE 802.11n (20 MHz)/5240 MHz		

**Polarization: Horizontal**

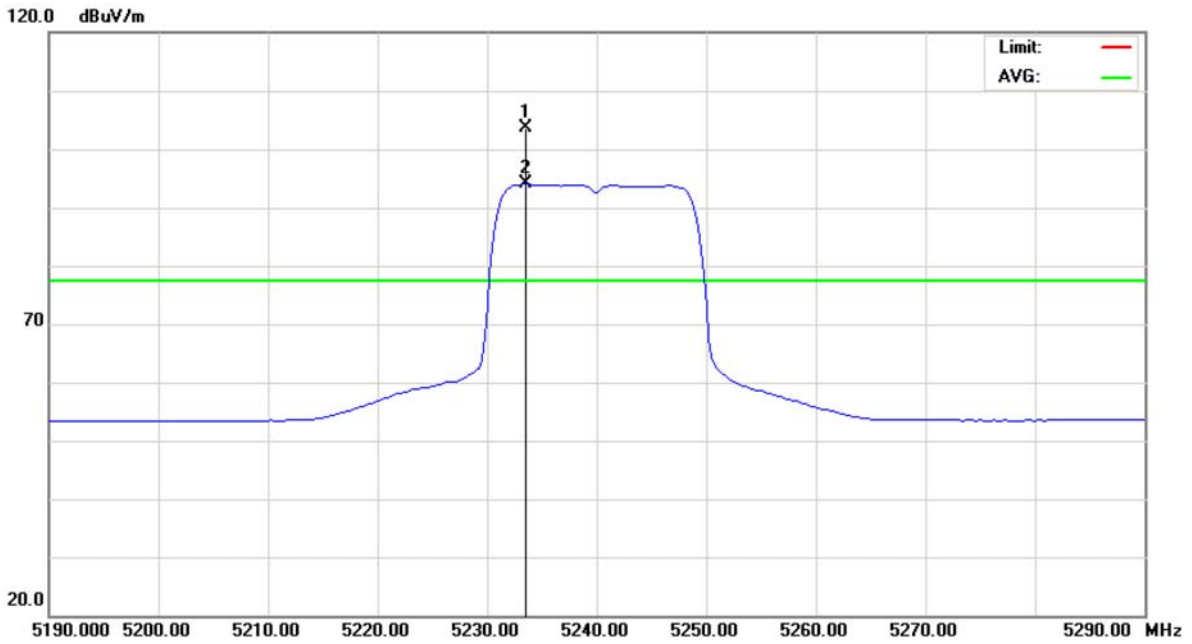

No.	Mk.	Freq. MHz	Reading Level dBuV	Correct Factor dB	Measure- ment dBuV/m	Limit dBuV/m	Over dB	Detector	Comment
1	*	5233.500	62.60	41.05	103.65	77.30	26.35	peak	
2	X	5233.500	52.98	41.05	94.03	77.30	16.73	AVG	



E.U.T	MONDOCENTER	Model Name	INF-MCENTER
Temperature	26°C	Relative Humidity	60%
Test Voltage	AC 120V/60Hz		
Test Mode	IEEE 802.11n (20 MHz)/5240 MHz		

**Polarization: Horizontal**

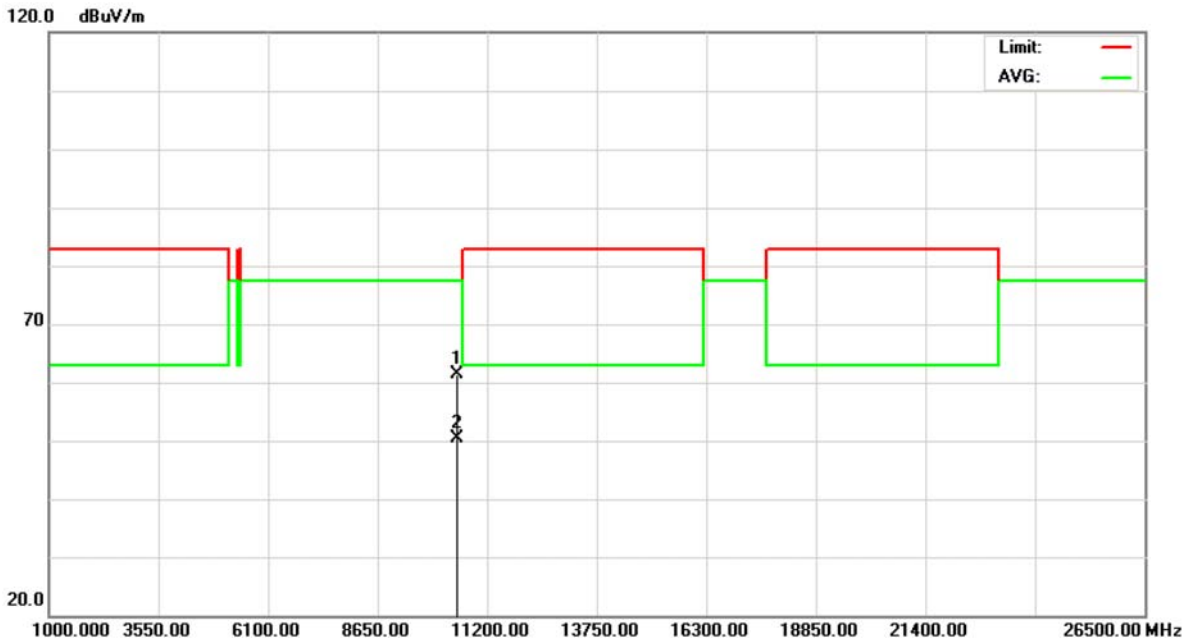

No.	Mk.	Freq. MHz	Reading Level dBuV	Correct Factor dB	Measure- ment dBuV/m	Limit dBuV/m	Over dB	Detector	Comment
1	*	10478.75	41.21	20.23	61.44	77.30	-15.86	peak	
2		10478.75	30.16	20.23	50.39	77.30	-26.91	AVG	



E.U.T	MONDOCENTER	Model Name	INF-MCENTER
Temperature	26°C	Relative Humidity	60%
Test Voltage	AC 120V/60Hz		
Test Mode	IEEE 802.11n (40 MHz)/5190 MHz		

**Polarization: Vertical**

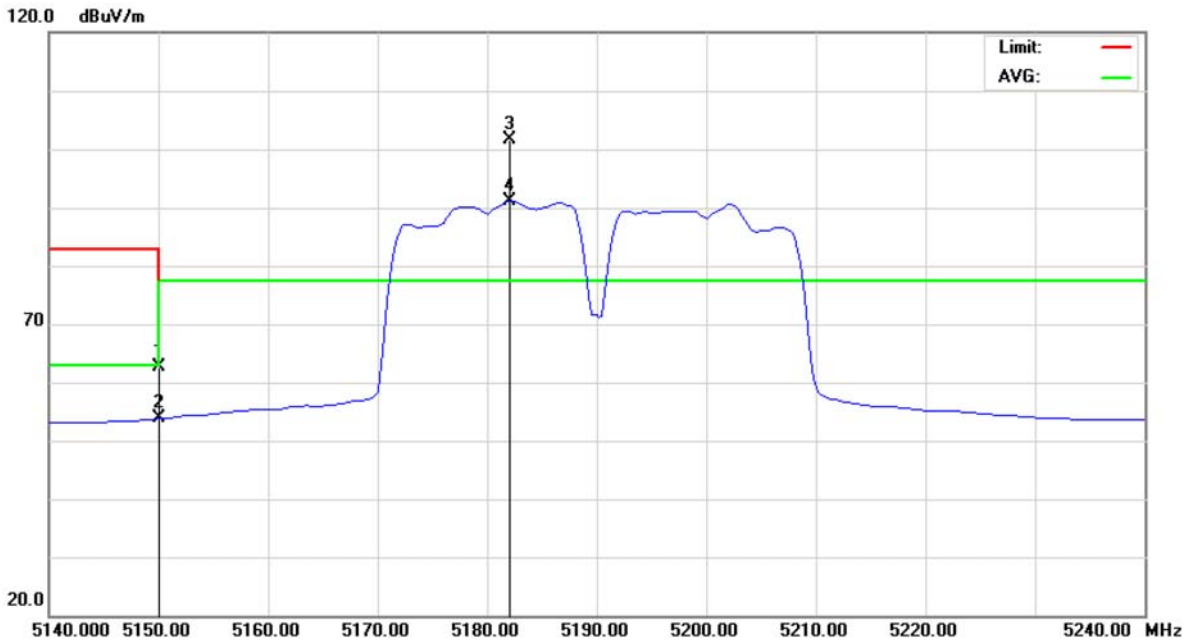

No.	Mk.	Freq. MHz	Reading Level dBuV	Correct Factor dB	Measure- ment dBuV/m	Limit dBuV/m	Over dB	Detector	Comment
1		5150.000	21.83	40.92	62.75	77.30	-14.55	peak	
2		5150.000	12.87	40.92	53.79	63.00	-9.21	AVG	
3	*	5182.000	60.59	40.97	101.56	77.30	24.26	peak	
4	X	5182.000	50.24	40.97	91.21	77.30	13.91	AVG	



E.U.T	MONDOCENTER	Model Name	INF-MCENTER
Temperature	26°C	Relative Humidity	60%
Test Voltage	AC 120V/60Hz		
Test Mode	IEEE 802.11n (40 MHz)/5190 MHz		

**Polarization: Vertical**

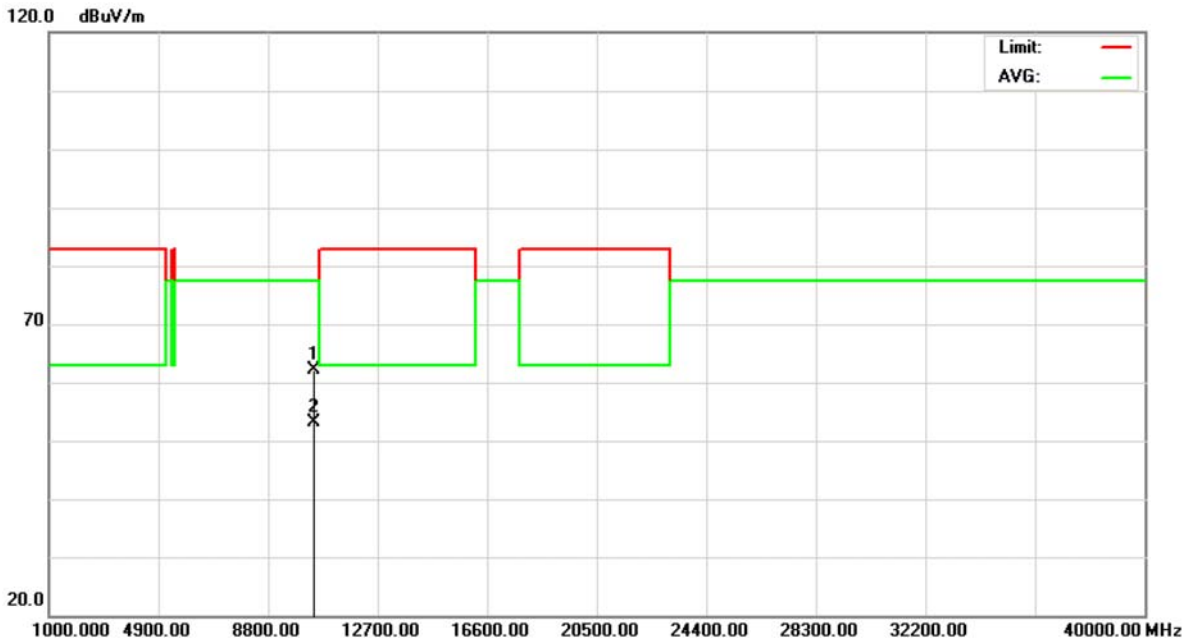

No.	Mk.	Freq. MHz	Reading Level dBuV	Correct Factor dB	Measure- ment dBuV/m	Limit dBuV/m	Over dB	Detector	Comment
1	*	10388.75	42.11	19.98	62.09	77.30	-15.21	peak	
2		10388.75	33.10	19.98	53.08	77.30	-24.22	AVG	



E.U.T	MONDOCENTER	Model Name	INF-MCENTER
Temperature	26°C	Relative Humidity	60%
Test Voltage	AC 120V/60Hz		
Test Mode	IEEE 802.11n (40 MHz)/5190 MHz		

**Polarization: Horizontal**

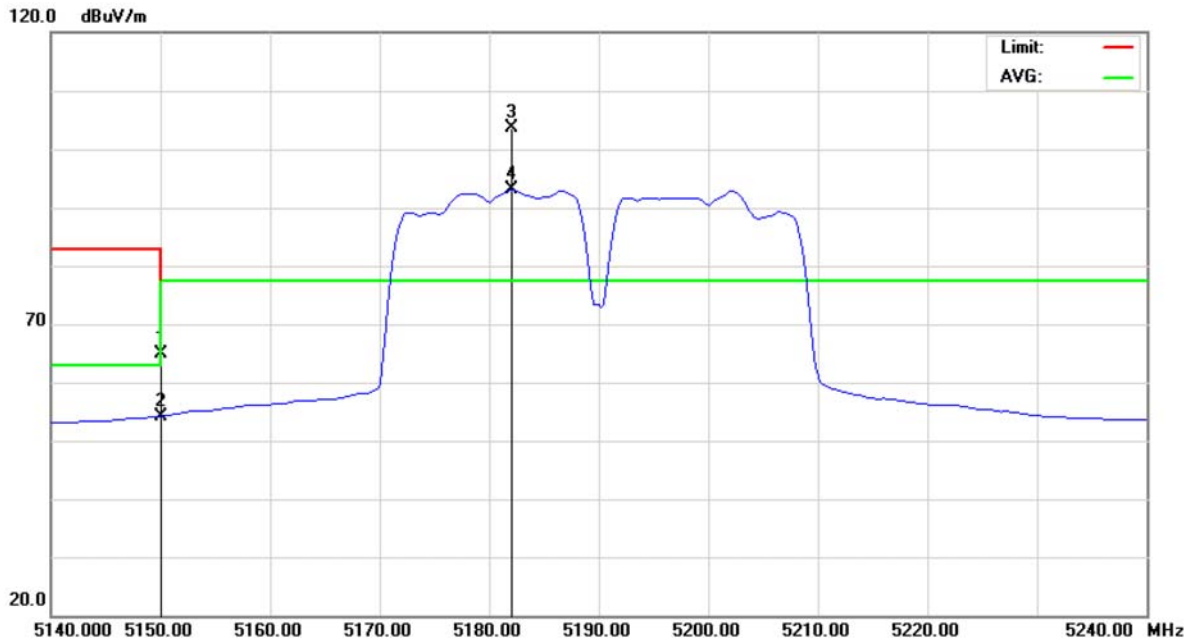

No.	Mk.	Freq. MHz	Reading Level dBuV	Correct Factor dB	Measure- ment dBuV/m	Limit dBuV/m	Over dB	Detector	Comment
1		5150.000	24.03	40.92	64.95	77.30	-12.35	peak	
2		5150.000	13.31	40.92	54.23	63.00	-8.77	AVG	
3	*	5182.000	62.55	40.97	103.52	77.30	26.22	peak	
4	X	5182.000	52.10	40.97	93.07	77.30	15.77	AVG	





E.U.T	MONDOCENTER	Model Name	INF-MCENTER
Temperature	26°C	Relative Humidity	60%
Test Voltage	AC 120V/60Hz		
Test Mode	IEEE 802.11n (40 MHz)/5190 MHz		

**Polarization: Horizontal**

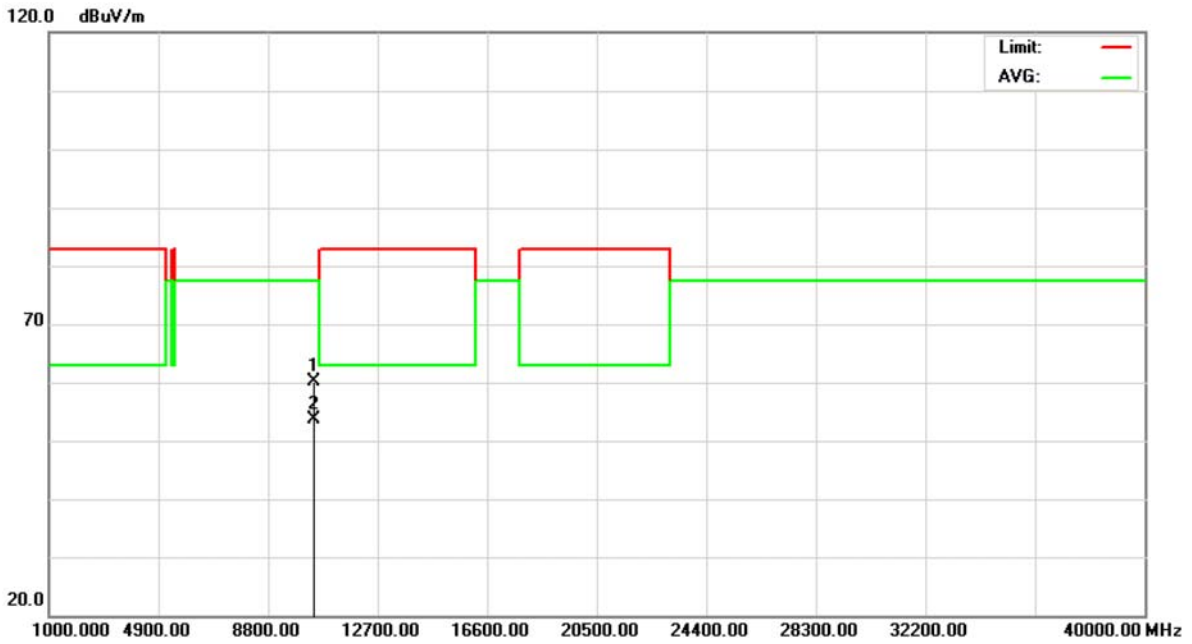

No.	Mk.	Freq. MHz	Reading Level dBuV	Correct Factor dB	Measure- ment dBuV/m	Limit dBuV/m	Over dB	Detector	Comment
1	*	10377.50	40.24	19.94	60.18	77.30	-17.12	peak	
2		10377.50	33.73	19.94	53.67	77.30	-23.63	AVG	



E.U.T	MONDOCENTER	Model Name	INF-MCENTER
Temperature	26°C	Relative Humidity	60%
Test Voltage	AC 120V/60Hz		
Test Mode	IEEE 802.11n (40 MHz)/5230 MHz		

**Polarization: Vertical**

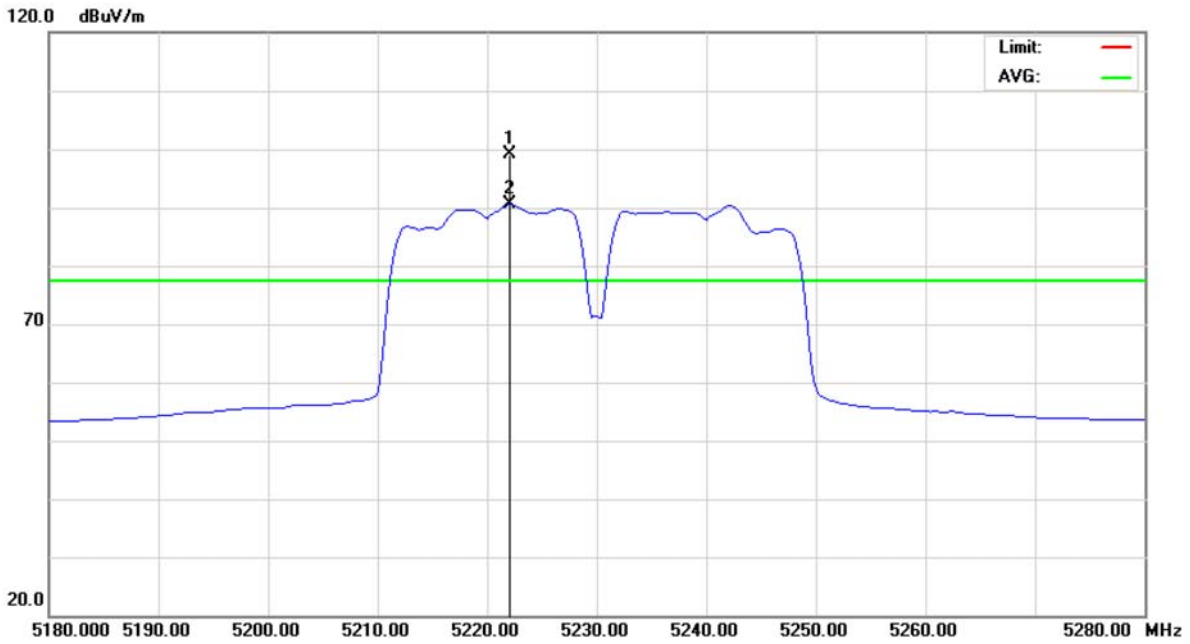

No.	Mk.	Freq. MHz	Reading Level dBuV	Correct Factor dB	Measure- ment dBuV/m	Limit dBuV/m	Over dB	Detector	Comment
1	*	5222.000	58.00	41.04	99.04	77.30	21.74	peak	
2	X	5222.000	49.52	41.04	90.56	77.30	13.26	AVG	



E.U.T	MONDOCENTER	Model Name	INF-MCENTER
Temperature	26°C	Relative Humidity	60%
Test Voltage	AC 120V/60Hz		
Test Mode	IEEE 802.11n (40 MHz)/5230 MHz		

**Polarization: Vertical**

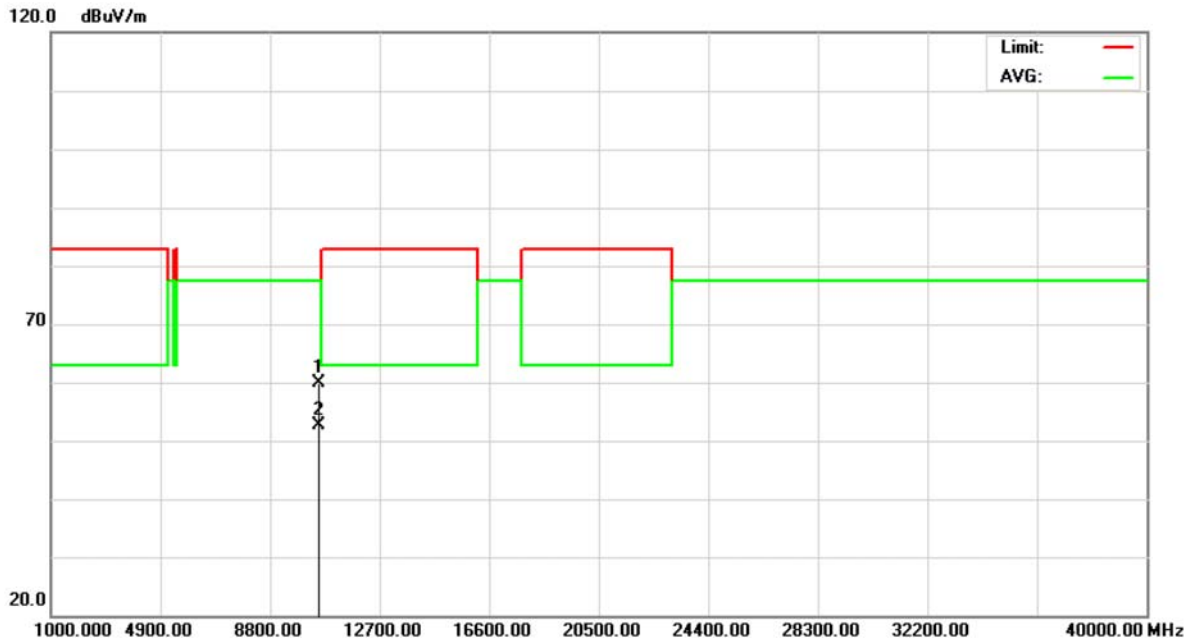

No.	Mk.	Freq. MHz	Reading Level dBuV	Correct Factor dB	Measure- ment dBuV/m	Limit dBuV/m	Over dB	Detector	Comment
1	*	10458.25	39.67	20.17	59.84	77.30	-17.46	peak	
2		10458.25	32.34	20.17	52.51	77.30	-24.79	AVG	



E.U.T	MONDOCENTER	Model Name	INF-MCENTER
Temperature	26°C	Relative Humidity	60%
Test Voltage	AC 120V/60Hz		
Test Mode	IEEE 802.11n (40 MHz)/5230 MHz		

**Polarization: Horizontal**

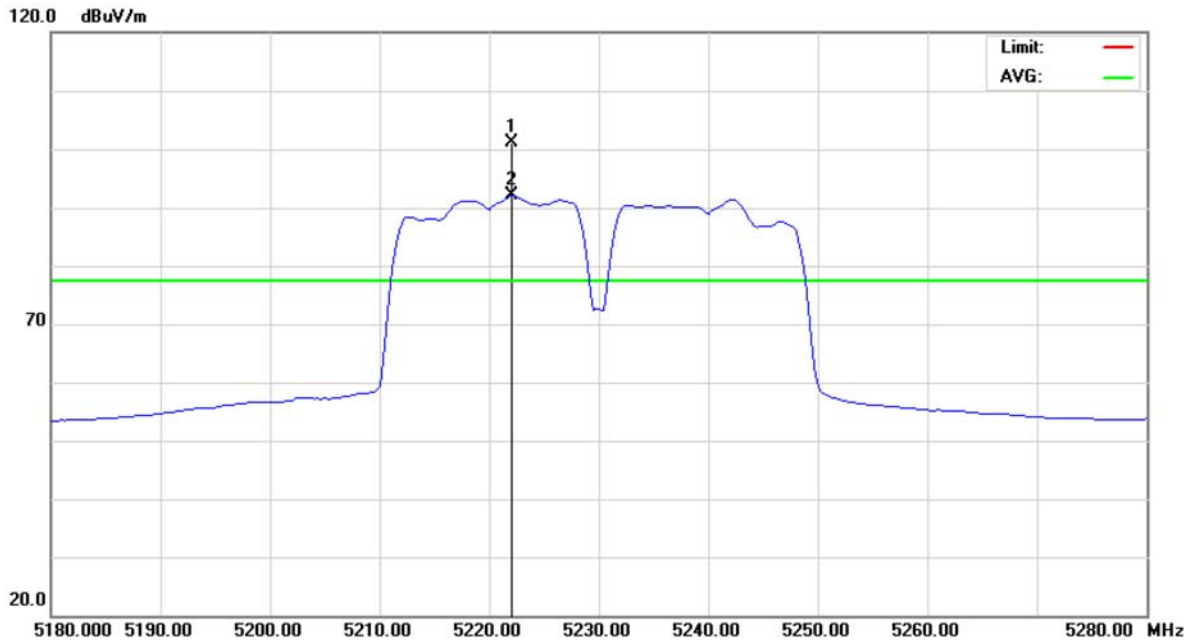

No.	Mk.	Freq. MHz	Reading Level dBuV	Correct Factor dB	Measure- ment dBuV/m	Limit dBuV/m	Over dB	Detector	Comment
1	*	5222.000	60.21	41.04	101.25	77.30	23.95	peak	
2	X	5222.000	50.98	41.04	92.02	77.30	14.72	AVG	



E.U.T	MONDOCENTER	Model Name	INF-MCENTER
Temperature	26°C	Relative Humidity	60%
Test Voltage	AC 120V/60Hz		
Test Mode	IEEE 802.11n (40 MHz)/5230 MHz		

**Polarization: Horizontal**

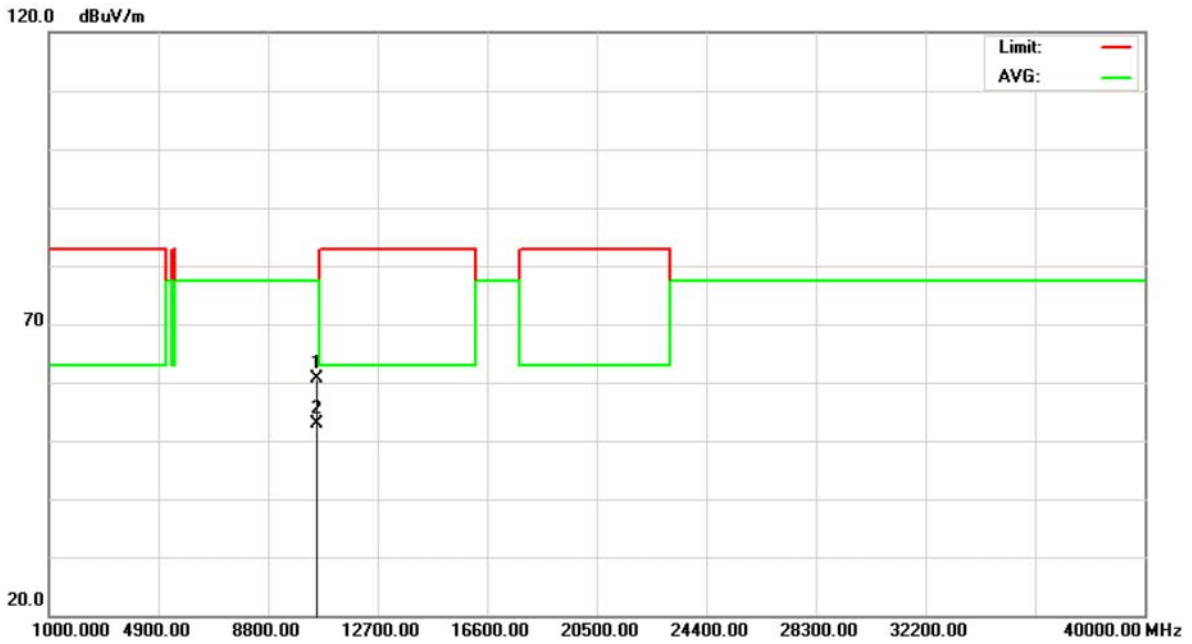

No.	Mk.	Freq. MHz	Reading Level dBuV	Correct Factor dB	Measure- ment dBuV/m	Limit dBuV/m	Over dB	Detector	Comment
1	*	10458.25	40.55	20.17	60.72	77.30	-16.58	peak	
2		10458.25	32.82	20.17	52.99	77.30	-24.31	AVG	