



# FCC RF Test Report

**APPLICANT** : Huawei Technologies Co., Ltd.  
**EQUIPMENT** : Smart Phone  
**BRAND NAME** : Honor  
**MODEL NAME** : YAL-L41  
**FCC ID** : QISYAL-L41  
**STANDARD** : 47 CFR Part 2, 22(H), 24(E), 27(L)  
**CLASSIFICATION** : PCS Licensed Transmitter Held to Ear (PCE)

The product was received on May 10, 2019 and completely tested on May 22, 2019. We, Sporton International (ShenZhen) Inc., would like to declare that the tested sample has been evaluated in accordance with the procedures given in ANSI C63.26-2015 and shown compliance with the applicable technical standards.

The test results in this report apply exclusively to the tested model / sample. Without written approval of Sporton International (ShenZhen) Inc., the test report shall not be reproduced except in full.

*Derreck Chen*

Reviewed by: Derreck Chen / Supervisor

*Eric Shih*

Approved by: Eric Shih / Manager



**Sporton International (ShenZhen) Inc.**

**1/F, 2/F, Bldg 5, Shiling Industrial Zone, Xinwei Village, Xili, Nanshan, Shenzhen, 518055**

**People's Republic of China**



# TABLE OF CONTENTS

**REVISION HISTORY..... 3**

**SUMMARY OF TEST RESULT ..... 4**

**1 GENERAL DESCRIPTION ..... 5**

    1.1 Applicant..... 5

    1.2 Product Feature of Equipment Under Test ..... 5

    1.3 Product Specification of Equipment Under Test ..... 6

    1.4 Modification of EUT ..... 7

    1.5 Maximum ERP/EIRP Power, Frequency Tolerance, and Emission Designator ..... 7

    1.6 Testing Location ..... 8

    1.7 Applicable Standards ..... 8

**2 TEST CONFIGURATION OF EQUIPMENT UNDER TEST ..... 9**

    2.1 Test Mode..... 9

    2.2 Connection Diagram of Test System ..... 10

    2.3 Support Unit used in test configuration ..... 10

    2.4 Measurement Results Explanation Example ..... 10

    2.5 Frequency List of Low/Middle/High Channels ..... 11

**3 CONDUCTED TEST RESULT ..... 12**

    3.1 Measuring Instruments..... 12

    3.2 Test Setup ..... 12

    3.3 Test Result of Conducted Test..... 12

    3.4 Conducted Output Power and ERP/EIRP ..... 13

    3.5 Peak-to-Average Ratio ..... 14

    3.6 99% Occupied Bandwidth and 26dB Bandwidth Measurement..... 15

    3.7 Conducted Band Edge ..... 16

    3.8 Conducted Spurious Emission ..... 17

    3.9 Frequency Stability..... 18

**4 RADIATED TEST ITEMS ..... 19**

    4.1 Measuring Instruments..... 19

    4.2 Test Setup ..... 19

    4.3 Test Result of Radiated Test..... 19

    4.4 Field Strength of Spurious Radiation Measurement ..... 20

**5 LIST OF MEASURING EQUIPMENT ..... 21**

**6 UNCERTAINTY OF EVALUATION ..... 22**

**APPENDIX A. TEST RESULTS OF CONDUCTED TEST**

**APPENDIX B. TEST RESULTS OF RADIATED TEST**

**APPENDIX C. TEST SETUP PHOTOGRAPHS**





### SUMMARY OF TEST RESULT

Report Section	FCC Rule	Description	Limit	Result	Remark
3.4	§2.1046	Conducted Output Power	Reporting Only	PASS	-
	§22.913(a)(5)	Effective Radiated Power	< 7 Watts	PASS	-
	§24.232(c)	Equivalent Isotropic Radiated Power	< 2 Watts	PASS	-
	§27.50(d)(4)	Equivalent Isotropic Radiated Power	< 1 Watts	PASS	-
3.5	§24.232(d)	Peak-to-Average Ratio	< 13 dB	PASS	-
3.6	§2.1049	Occupied Bandwidth	Reporting Only	PASS	-
3.7	§2.1051 §22.917(a) §24.238(a) §27.53(h)	Band Edge Measurement	< 43+10log10(P[Watts])	PASS	-
3.8	§2.1051 §22.917(a) §24.238(a) §27.53(h)	Conducted Emission	< 43+10log10(P[Watts])	PASS	-
3.9	§2.1055 §22.355	Frequency Stability for Temperature & Voltage	< 2.5 ppm for Part 22	PASS	-
	§2.1055 §24.235 §27.54		Within Authorized Band		
4.4	§2.1053 §22.917(a) §24.238(a) §27.53(h)	Field Strength of Spurious Radiation	< 43+10log10(P[Watts])	PASS	Under limit 42.30 dB at 6930.400 MHz



# 1 General Description

## 1.1 Applicant

Huawei Technologies Co., Ltd.

Administration Building, Headquarters of Huawei Technologies Co., Ltd., Bantian, Longgang District, Shenzhen, 518129, P.R.C

## 1.2 Product Feature of Equipment Under Test

Product Feature	
Equipment	Smart Phone
Brand Name	Honor
Model Name	YAL-L41
FCC ID	QISYAL-L41
EUT supports Radios application	GSM/GPRS/EGPRS/WCDMA/HSPA/DC-HSDPA/HSPA+(16 QAM Uplink is not supported)/LTE/NFC WLAN 2.4GHz 802.11b/g/n HT20/HT40 WLAN 5GHz 802.11a/n HT20/HT40 WLAN 5GHz 802.11ac VHT20/VHT40/VHT80/VHT160 Bluetooth BR/EDR/LE GNSS
IMEI Code	Conducted: 869436040038685/869436040043180 Radiation: 869436040037885/869436040042380
HW Version	HL2YALEM04
SW Version	9.1.0.119(C900E119R1P2)
EUT Stage	Identical Prototype

**Remark:** The above EUT's information was declared by manufacturer. Please refer to the specifications or user's manual for more detailed description.



### 1.3 Product Specification of Equipment Under Test

Standards-related Product Specification	
<b>Tx Frequency</b>	<b>GSM/GPRS/EDGE:</b> 850: 824.2 MHz ~ 848.8 MHz 1900: 1850.2 MHz ~ 1909.8MHz <b>WCDMA:</b> Band V: 826.4 MHz ~ 846.6 MHz Band II: 1852.4 MHz ~ 1907.6 MHz Band IV: 1712.4 MHz ~ 1752.6 MHz
<b>Rx Frequency</b>	<b>GSM/GPRS/EDGE:</b> 850: 869.2 MHz ~ 893.8 MHz 1900: 1930.2 MHz ~ 1989.8 MHz <b>WCDMA:</b> Band V: 871.4 MHz ~ 891.6 MHz Band II: 1932.4 MHz ~ 1987.6 MHz Band IV: 2112.4 MHz ~ 2152.6 MHz
<b>Maximum Output Power to Antenna</b>	<b>Top Antenna</b> <b>GSM/GPRS/EDGE:</b> 850: 33.26 dBm 1900: 29.36 dBm <b>WCDMA:</b> Band V: 23.82 dBm Band II: 23.31 dBm Band IV: 22.74 dBm <b>Bottom Antenna</b> <b>GSM/GPRS/EDGE:</b> 850: 32.12 dBm 1900: 30.25 dBm <b>WCDMA:</b> Band V: 24.08 dBm Band II: 23.54 dBm Band IV: 23.08 dBm
<b>Antenna Type</b>	Internal Antenna
<b>Antenna Gain</b>	<b>Top Antenna</b> Cellular Band: -4.00 dBi PCS Band: -3.40 dBi AWS Band: -1.70 dBi <b>Bottom Antenna</b> Cellular Band: -3.60 dBi PCS Band: 0.00 dBi AWS Band: 0.00 dBi
<b>Type of Modulation</b>	GSM: GMSK GPRS: GMSK EDGE: GMSK / 8PSK WCDMA : BPSK (Uplink) HSDPA/DC-HSDPA : QPSK (Uplink)



	HSUPA : QPSK (Uplink) HSPA+ : 16QAM (16QAM uplink is not supported) DC-HSDPA : 64QAM
--	--

Note: The Maximum ERP/EIRP is calculated from Max Output power and Max antenna gain.

### 1.4 Modification of EUT

No modifications are made to the EUT during all test items.

### 1.5 Maximum ERP/EIRP Power, Frequency Tolerance, and Emission Designator

FCC Rule	System	Type of Modulation	Maximum ERP/EIRP (W)	Frequency Tolerance (ppm)	Emission Designator
Part 22	GSM850 GSM	GMSK	0.5140	0.0143 ppm	243KGXW
Part 22	GSM850 EDGE class 8	8PSK	0.0869	0.0287 ppm	239KG7W
Part 22	WCDMA Band V RMC 12.2Kbps	BPSK	0.0681	0.0239 ppm	4M16F9W
Part 24	GSM1900 GSM	GMSK	1.0593	0.0069 ppm	246KGXW
Part 24	GSM1900 EDGE class 8	8PSK	0.3715	0.0096 ppm	245KG7W
Part 24	WCDMA Band II RMC 12.2Kbps	BPSK	0.2259	0.0122 ppm	4M16F9W
Part 27	WCDMA Band IV RMC 12.2Kbps	BPSK	0.2032	0.0046 ppm	4M17F9W



### 1.6 Testing Location

<FCC>

Sporton International (Shenzhen) Inc. is accredited to ISO/IEC 17025:2017 by American Association for Laboratory Accreditation with Certificate Number 5145.01.

<b>Test Firm</b>	Sporton International (Shenzhen) Inc.		
<b>Test Site Location</b>	1/F, 2/F, Bldg 5, Shiling Industrial Zone, Xinwei Village, Xili, Nanshan, Shenzhen, 518055 People's Republic of China TEL: +86-755-86379589 FAX: +86-755-86379595		
<b>Test Site No.</b>	<b>Sporton Site No.</b>	<b>FCC Designation No.</b>	<b>FCC Test Firm Registration No.</b>
	TH01-SZ	CN1256	421272

<b>Test Firm</b>	Sporton International (Shenzhen) Inc.		
<b>Test Site Location</b>	No. 3 Bldg the third floor of south, Shahe River west, Fengzeyuan Warehouse, Nanshan Shenzhen, 518055 People's Republic of China TEL: +86-755-33202398		
<b>Test Site No.</b>	<b>Sporton Site No.</b>	<b>FCC Designation No.</b>	<b>FCC Test Firm Registration No.</b>
	03CH01-SZ	CN1256	421272

### 1.7 Applicable Standards

According to the specifications of the manufacturer, the EUT must comply with the requirements of the following standards:

- ♦ 47 CFR Part 2, 22(H), 24(E), 27(L)
- ♦ ANSI C63.26-2015
- ♦ FCC KDB 971168 D01 Power Meas. License Digital Systems v03r01
- ♦ FCC KDB 412172 D01 Determining ERP and EIRP v01r01

**Remark:**

1. All test items were verified and recorded according to the standards and without any deviation during the test.
2. This EUT has also been tested and complied with the requirements of FCC Part 15, Subpart B, recorded in a separate test report.





## 2 Test Configuration of Equipment Under Test

### 2.1 Test Mode

Antenna port conducted and radiated test items were performed according to KDB 971168 D01 Power Meas. License Digital Systems v03r01 with maximum output power.

Radiated measurements were performed with rotating EUT in different three orthogonal test planes to find the maximum emission.

Radiated emissions were investigated as following frequency range:

30 MHz to 10th harmonic for GSM / WCDMA.

All modes and data rates and positions were investigated.

Test modes are chosen to be reported as the worst case configuration below:

Test Modes		
Band	Radiated TCs	Conducted TCs
GSM 850	<ul style="list-style-type: none"> <li>■ GSM Link</li> <li>■ EDGE class 8 Link</li> </ul>	<ul style="list-style-type: none"> <li>■ GSM Link</li> <li>■ EDGE class 8 Link</li> </ul>
GSM 1900	<ul style="list-style-type: none"> <li>■ GSM Link</li> <li>■ EDGE class 8 Link</li> </ul>	<ul style="list-style-type: none"> <li>■ GSM Link</li> <li>■ EDGE class 8 Link</li> </ul>
WCDMA Band V	<ul style="list-style-type: none"> <li>■ RMC 12.2Kbps Link</li> </ul>	<ul style="list-style-type: none"> <li>■ RMC 12.2Kbps Link</li> </ul>
WCDMA Band II	<ul style="list-style-type: none"> <li>■ RMC 12.2Kbps Link</li> </ul>	<ul style="list-style-type: none"> <li>■ RMC 12.2Kbps Link</li> </ul>
WCDMA Band IV	<ul style="list-style-type: none"> <li>■ RMC 12.2Kbps Link</li> </ul>	<ul style="list-style-type: none"> <li>■ RMC 12.2Kbps Link</li> </ul>

## 2.2 Connection Diagram of Test System

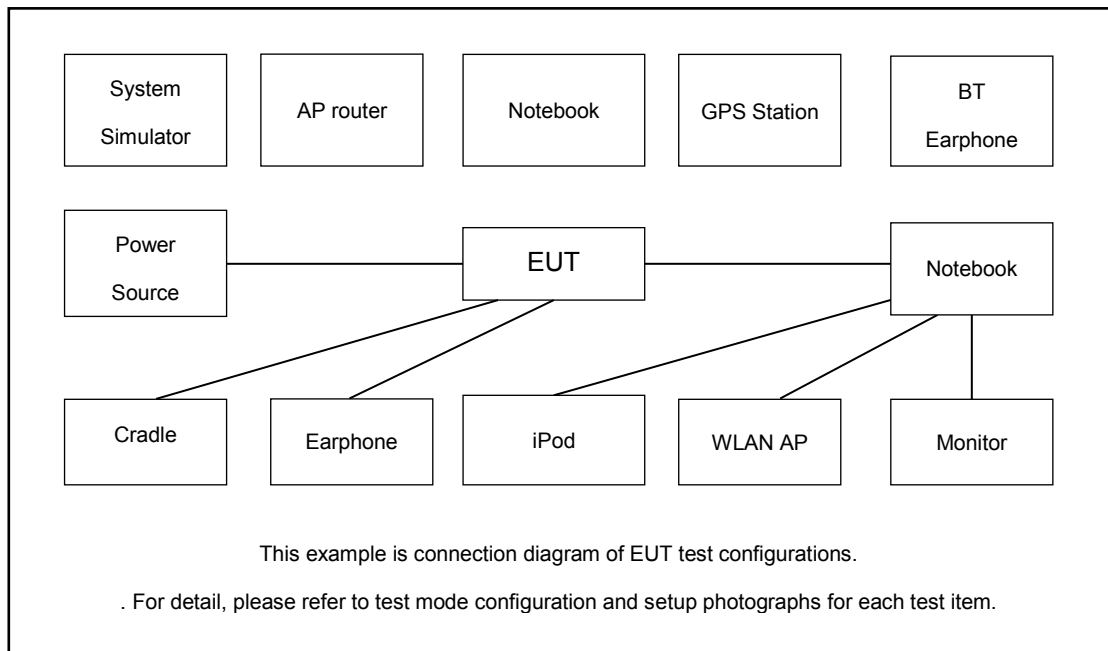

## 2.3 Support Unit used in test configuration

Item	Equipment	Trade Name	Model No.	FCC ID	Data Cable	Power Cord
1.	System Simulator	Anritsu	MT8820C	N/A	N/A	Unshielded, 1.8 m
2.	DC Power Supply	GW INSTEK	GPS-3030D	N/A	N/A	Unshielded, 1.8 m

## 2.4 Measurement Results Explanation Example

### For all conducted test items:

The offset level is set in the spectrum analyzer to compensate the RF cable loss and attenuator factor between RF conducted output port and spectrum analyzer. With the offset compensation, the spectrum analyzer reading level will be exactly the RF output level.

The spectrum analyzer offset is derived from RF cable loss and attenuator factor.

$$\text{Offset} = \text{RF cable loss} + \text{attenuator factor}.$$

The following shows an offset computation example with RF cable loss 4.5 dB and a 10dB attenuator.

Example :

$$\begin{aligned} \text{Offset(dB)} &= \text{RF cable loss(dB)} + \text{attenuator factor(dB)}. \\ &= 4.5 + 10 = 14.5 \text{ (dB)} \end{aligned}$$



## 2.5 Frequency List of Low/Middle/High Channels

Frequency List				
Band	Channel/Frequency(MHz)	Lowest	Middle	Highest
GSM850	Channel	128	189	251
	Frequency	824.2	836.4	848.8
WCDMA Band V	Channel	4132	4182	4233
	Frequency	826.4	836.4	846.6
GSM1900	Channel	512	661	810
	Frequency	1850.2	1880.0	1909.8
WCDMA Band II	Channel	9262	9400	9538
	Frequency	1852.4	1880.0	1907.6
WCDMA Band IV	Channel	1312	1413	1513
	Frequency	1712.4	1732.6	1752.6

### 3 Conducted Test Result

#### 3.1 Measuring Instruments

See list of measuring instruments of this test report.

#### 3.2 Test Setup

##### 3.2.1 Conducted Output Power

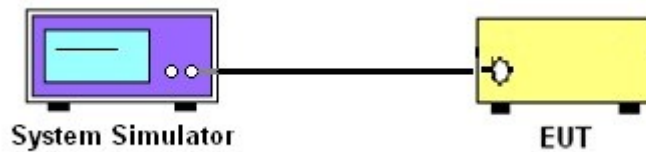

##### 3.2.2 Peak-to-Average Ratio, Occupied Bandwidth, Conducted Band-Edge and Conducted Spurious Emission

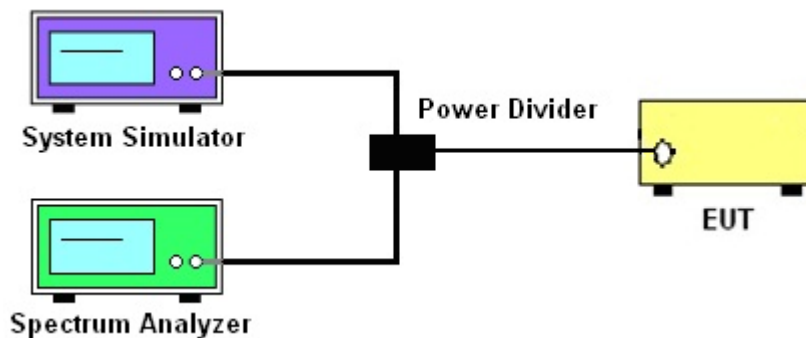

##### 3.2.3 Frequency Stability

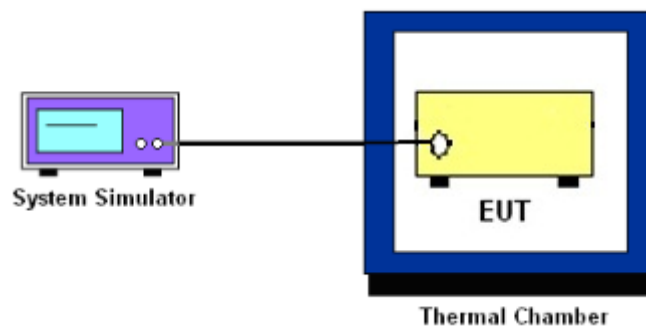

### 3.3 Test Result of Conducted Test

Please refer to Appendix A.



### 3.4 Conducted Output Power and ERP/EIRP

#### 3.4.1 Description of the Conducted Output Power and ERP/EIRP

A system simulator was used to establish communication with the EUT. Its parameters were set to enforce EUT transmitting at the maximum power. The measured power in the radio frequency on the transmitter output terminals shall be reported.

The ERP of mobile transmitters must not exceed 7 Watts for GSM850 and WCDMA Band V.

The EIRP of mobile transmitters must not exceed 2 Watts for GSM1900 and WCDMA Band II.

The EIRP of mobile transmitters must not exceed 1 Watts for WCDMA Band IV.

According to KDB 412172 D01 Power Approach,

$EIRP = P_T + G_T - L_C$ ,  $ERP = EIRP - 2.15$ , where

$P_T$  = transmitter output power in dBm

$G_T$  = gain of the transmitting antenna in dBi

$L_C$  = signal attenuation in the connecting cable between the transmitter and antenna in dB

#### 3.4.2 Test Procedures

1. The testing follows ANSI C63.26 Section 5.2
2. The transmitter output port was connected to the system simulator.
3. Set EUT at maximum power through the system simulator.
4. Select lowest, middle, and highest channels for each band and different modulation.
5. Measure and record the power level from the system simulator.



## **3.5 Peak-to-Average Ratio**

### **3.5.1 Description of the PAR Measurement**

The peak-to-average ratio (PAR) of the transmission may not exceed 13 dB.

### **3.5.2 Test Procedures**

1. The testing follows ANSI C63.26 Section 5.2.3.4 (CCDF).
2. The EUT was connected to spectrum and system simulator via a power divider.
3. Set the CCDF (Complementary Cumulative Distribution Function) option in spectrum analyzer.
4. The highest RF powers were measured and recorded the maximum PAPR level associated with a probability of 0.1 %.
5. Record the deviation as Peak to Average Ratio.



### 3.6 99% Occupied Bandwidth and 26dB Bandwidth Measurement

#### 3.6.1 Description of 99% Occupied Bandwidth and 26dB Bandwidth Measurement

The occupied bandwidth is the width of a frequency band such that, below the lower and above the upper frequency limits, the mean powers emitted are each equal to a specified percentage 0.5% of the total mean transmitted power.

The 26 dB emission bandwidth is defined as the frequency range between two points, one above and one below the carrier frequency, at which the spectral density of the emission is attenuated 26 dB below the maximum in-band spectral density of the modulated signal. Spectral density (power per unit bandwidth) is to be measured with a detector of resolution bandwidth equal to approximately 1.0% of the emission bandwidth.

#### 3.6.2 Test Procedures

1. The testing follows ANSI C63.26 Section 5.4
2. The EUT was connected to spectrum analyzer and system simulator via a power divider.
3. The spectrum analyzer center frequency is set to the nominal EUT channel center frequency. The span range for the spectrum analyzer shall be between two and five times the anticipated OBW.
4. The nominal resolution bandwidth (RBW) shall be in the range of 1 to 5 % of the anticipated OBW, and the VBW shall be at least 3 times the RBW.
5. Set the detection mode to peak, and the trace mode to max hold.
6. Determine the reference value: Set the EUT to transmit a modulated signal. Allow the trace to stabilize. Set the spectrum analyzer marker to the highest level of the displayed trace.  
(this is the reference value)
7. Determine the “-26 dB down amplitude” as equal to (Reference Value – X).
8. Place two markers, one at the lowest and the other at the highest frequency of the envelope of the spectral display such that each marker is at or slightly below the “-X dB down amplitude” determined in step 6. If a marker is below this “-X dB down amplitude” value it shall be placed as close as possible to this value. The OBW is the positive frequency difference between the two markers.
9. Use the 99 % power bandwidth function of the spectrum analyzer and report the measured bandwidth.



## 3.7 Conducted Band Edge

### 3.7.1 Description of Conducted Band Edge Measurement

The power of any emission outside of the authorized operating frequency ranges must be lower than the transmitter power (P) by a factor of at least  $43 + 10 \log (P)$  dB.

### 3.7.2 Test Procedures

1. The testing follows ANSI C63.26 section 5.7
2. The EUT was connected to the spectrum analyzer and system simulator via a power divider.
3. The RF output of EUT was connected to the spectrum analyzer by an RF cable and attenuator. The path loss was compensated to the results for each measurement.
4. The band edges of low and high channels for the highest RF powers were measured.
5. The RF fundamental frequency should be excluded against the limit line in the operating frequency band.
6. The limit line is derived from  $43 + 10\log(P)$  dB below the transmitter power P(Watts)





## 3.8 Conducted Spurious Emission

### 3.8.1 Description of Conducted Spurious Emission Measurement

The power of any emission outside of the authorized operating frequency ranges must be lower than the transmitter power (P) by a factor of at least  $43 + 10 \log (P)$  dB.

It is measured by means of a calibrated spectrum analyzer and scanned from 30 MHz up to a frequency including its 10<sup>th</sup> harmonic.

### 3.8.2 Test Procedures

1. The testing follows ANSI C63.26 section 5.7
2. The EUT was connected to the spectrum analyzer and system simulator via a power divider.
3. The RF output of EUT was connected to the spectrum analyzer by an RF cable and attenuator. The path loss was compensated to the results for each measurement.
4. The middle channel for the highest RF power within the transmitting frequency was measured.
5. The conducted spurious emission for the whole frequency range was taken.
6. The RF fundamental frequency should be excluded against the limit line in the operating frequency band.
7. The limit line is derived from  $43 + 10\log(P)$  dB below the transmitter power P(Watts)



## 3.9 Frequency Stability

### 3.9.1 Description of Frequency Stability Measurement

The frequency stability shall be measured by variation of ambient temperature and variation of primary supply voltage to ensure that the fundamental emission stays within the authorized frequency block. The frequency stability of the transmitter shall be maintained within  $\pm 0.00025\%$  ( $\pm 2.5\text{ppm}$ ) of the center frequency.

### 3.9.2 Test Procedures for Temperature Variation

1. The testing follows ANSI C63.26 section 5.6.4
2. The EUT was set up in the thermal chamber and connected with the system simulator.
3. With power OFF, the temperature was decreased to  $-30^{\circ}\text{C}$  and the EUT was stabilized before testing. Power was applied and the maximum change in frequency was recorded within one minute.
4. With power OFF, the temperature was raised in  $10^{\circ}\text{C}$  step up to  $50^{\circ}\text{C}$ . The EUT was stabilized at each step for at least half an hour. Power was applied and the maximum frequency change was recorded within one minute.

### 3.9.3 Test Procedures for Voltage Variation

1. The testing follows ANSI C63.26 section 5.6.5
2. The EUT was placed in a temperature chamber at  $20\pm 5^{\circ}\text{C}$  and connected with the system simulator.
3. The power supply voltage to the EUT was varied from 85% to 115% of the nominal value for other than hand carried battery equipment.
4. For hand carried, battery powered equipment, reduce the primary ac or dc supply voltage to the battery operating end point, which shall be specified by the manufacturer.
5. The variation in frequency was measured for the worst case.

## 4 Radiated Test Items

### 4.1 Measuring Instruments

See list of measuring instruments of this test report.

### 4.2 Test Setup

#### 4.2.1 For radiated test from 30MHz to 1GHz

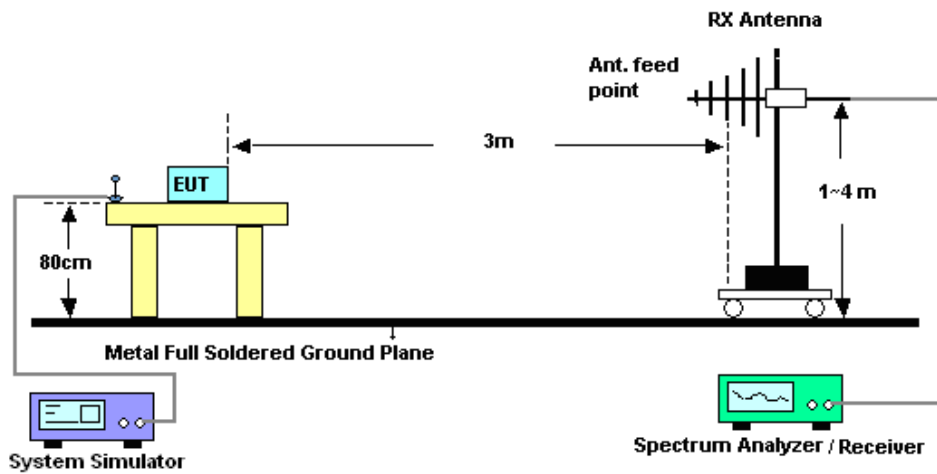

#### 4.2.2 For radiated test above 1GHz

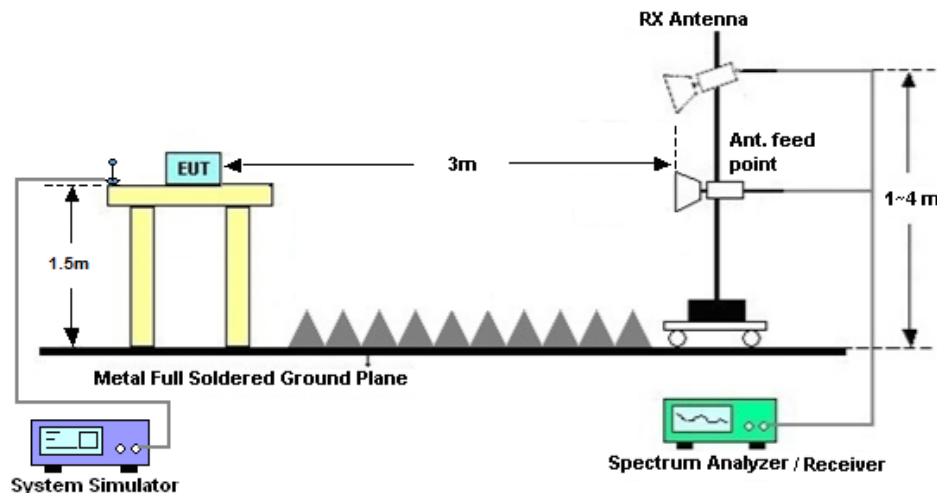

### 4.3 Test Result of Radiated Test

Please refer to Appendix B.



## 4.4 Field Strength of Spurious Radiation Measurement

### 4.4.1 Description of Field Strength of Spurious Radiated Measurement

The power of any emission outside of the authorized operating frequency ranges must be attenuated below the transmitter power (P) by a factor of at least  $43 + 10 \log (P)$  dB. The spectrum is scanned from 30 MHz up to a frequency including its 10th harmonic.

### 4.4.2 Test Procedures

1. The testing follows ANSI C63.26 Section 5.5
2. The EUT was placed on a rotatable wooden table 0.8 meters for frequency below 1GHz and 1.5 meter for frequency above 1GHz above the ground.
3. The EUT was set 3 meters from the receiving antenna, which was mounted on the antenna tower.
4. The table was rotated 360 degrees to determine the position of the highest spurious emission.
5. The height of the receiving antenna is varied between one meter and four meters to search for the maximum spurious emission for both horizontal and vertical polarizations.
6. Make the measurement with the spectrum analyzer's RBW = 1MHz, VBW = 3MHz, taking record of maximum spurious emission.
7. A horn antenna was substituted in place of the EUT and was driven by a signal generator.
8. Tune the output power of signal generator to the same emission level with EUT maximum spurious emission.
9. Taking the record of output power at antenna port.
10. Repeat step 7 to step 8 for another polarization.
11.  $EIRP (dBm) = S.G. Power - Tx Cable Loss + Tx Antenna Gain$
12.  $ERP (dBm) = EIRP - 2.15$
13. The RF fundamental frequency should be excluded against the limit line in the operating frequency band.
14. The limit line is derived from  $43 + 10\log(P)$  dB below the transmitter power P(Watts)



## 5 List of Measuring Equipment

Instrument	Manufacturer	Model No.	Serial No.	Characteristics	Calibration Date	Test Date	Due Date	Remark
Spectrum Analyzer	R&S	FSV40	101078	10Hz~40GHz	Apr. 18, 2019	May 21,2019~ May 22, 2019	Apr. 17, 2020	Conducted (TH01-SZ)
DC Power Supply	GWINSTEK	AnritsuGPS- 3030D	EM882636	Max 30V	Apr. 18, 2019	May 21,2019~ May 22, 2019	Apr. 17, 2020	Conducted (TH01-SZ)
Thermal Chamber	Ten Billion	LP-150U	H2014081803	-40~+150°C	Dec. 22, 2018	May 21,2019~ May 22, 2019	Dec. 21, 2019	Conducted (TH01-SZ)
EMI Test Receiver&SA	Agilent	N9038A	MY52260185	20Hz~26.5GHz	Aug. 30, 2018	May 16, 2019	Aug. 29, 2019	Radiation (03CH01-SZ)
HF Amplifier	KEYSIGHT	83017A	MY53270104	0.5GHz~26.5Ghz	Dec. 22, 2018	May 16, 2019	Dec. 21, 2019	Radiation (03CH01-SZ)
Bilog Antenna	TeseQ	CBL6112D	35407	30MHz-2GHz	Jun. 05, 2018	May 16, 2019	Jun. 04, 2019	Radiation (03CH01-SZ)
Double Ridge Horn Antenna	ETS Lindgren	3117	119436	1GHz~18GHz	Jun. 28, 2018	May 16, 2019	Jun. 27, 2019	Radiation (03CH01-SZ)
SHF-EHF Horn	com-power	AH-840	101071	18Ghz-40GHz	Mar. 30, 2019	May 16, 2019	Mar. 29, 2020	Radiation (03CH01-SZ)
LF Amplifier	Burgeon	BPA-530	102209	0.01~3000Mhz	Apr. 19, 2019	May 16, 2019	Apr. 18, 2020	Radiation (03CH01-SZ)
HF Amplifier	MITEQ	AMF-7D-001 01800-30-10	1707137	1GHz~18GHz	Oct. 19, 2018	May 16, 2019	Oct. 18, 2019	Radiation (03CH01-SZ)
HF Amplifier	MITEQ	TTA1840-35- HG	1871923	18GHz~40GHz	Jul. 17.2018	May 16, 2019	Jul. 16.2019	Radiation (03CH01-SZ)
AC Power Source	Chroma	61601	616010001985	N/A	NCR	May 16, 2019	NCR	Radiation (03CH01-SZ)
Turn Table	EM	EM1000	N/A	0~360 degree	NCR	May 16, 2019	NCR	Radiation (03CH01-SZ)
Antenna Mast	EM	EM1000	N/A	1 m~4 m	NCR	May 16, 2019	NCR	Radiation (03CH01-SZ)

NCR: No Calibration Required



## 6 Uncertainty of Evaluation

The measurement uncertainties shown below were calculated in accordance with the requirements of ANSI 63.26-2015. All the measurement uncertainty value were shown with a coverage K=2 to indicate 95% level of confidence. The measurement data show herein meets or exceeds the CISPR measurement uncertainty values specified in CISPR 16-4-2 and can be compared directly to specified limit to determine compliance.

### Uncertainty of Radiated Emission Measurement (30 MHz ~ 1000 MHz)

Measuring Uncertainty for a Level of Confidence of 95% (U = 2Uc(y))	2.5dB
---	-------

### Uncertainty of Radiated Emission Measurement (1 GHz ~ 18 GHz)

Measuring Uncertainty for a Level of Confidence of 95% (U = 2Uc(y))	3.5dB
---	-------

### Uncertainty of Radiated Emission Measurement (18 GHz ~ 40 GHz)

Measuring Uncertainty for a Level of Confidence of 95% (U = 2Uc(y))	4.0dB
---	-------



## Appendix A. Test Results of Conducted Test

### Conducted Output Power (Average power)

#### Top Antenna

Conducted Power (*Unit: dBm)						
Band	GSM850			GSM1900		
Channel	128	189	251	512	661	810
Frequency	824.2	836.4	848.8	1850.2	1880.0	1909.8
GSM	32.85	33.26	33.06	29.35	29.36	29.34
GPRS class 8	32.83	33.24	33.03	29.33	29.34	29.33
GPRS class 10	29.34	29.40	29.40	26.07	26.08	26.04
GPRS class 11	27.40	27.45	27.41	24.24	24.30	24.25
GPRS class 12	25.90	26.00	25.97	22.71	22.74	22.69
EGPRS class 8(GMSK)	32.78	33.02	33.01	29.31	29.27	29.20
EGPRS class 10(GMSK)	29.29	29.36	29.35	26.03	26.05	26.00
EGPRS class 11(GMSK)	27.39	27.46	27.41	24.20	24.25	24.17
EGPRS class 12(GMSK)	25.70	25.83	25.76	22.92	22.97	22.90
EGPRS class 8(8PSK)	25.28	25.45	25.30	24.56	24.64	24.38
EGPRS class 10(8PSK)	22.66	22.80	22.70	21.80	21.49	21.40
EGPRS class 11(8PSK)	20.91	21.10	21.06	19.87	19.51	19.58
EGPRS class 12(8PSK)	19.92	20.03	19.96	18.29	18.30	18.13



Conducted Power (*Unit: dBm)									
Band	WCDMA Band V			WCDMA Band II			WCDMA Band IV		
Channel	4132	4182	4233	9262	9400	9538	1312	1413	1513
Frequency	826.4	836.4	846.6	1852.4	1880	1907.6	1712.4	1732.6	1752.6
AMR 12.2K	23.74	23.81	23.70	23.30	23.27	23.29	22.67	22.72	22.52
RMC 12.2K	23.75	23.82	23.72	23.31	23.29	23.30	22.68	22.74	22.53
HSDPA Subtest-1	23.34	23.41	23.28	22.89	22.87	22.88	22.30	22.43	22.37
HSDPA Subtest-2	22.84	22.85	22.82	22.08	22.03	22.08	21.59	21.64	21.59
HSDPA Subtest-3	22.43	22.47	22.39	21.59	21.54	21.60	21.10	21.13	20.98
HSDPA Subtest-4	22.41	22.50	22.39	21.59	21.58	21.61	21.12	21.14	21.05
DC-HSDPA Subtest-1	23.30	23.38	23.27	22.85	22.84	22.82	22.24	22.40	22.32
DC-HSDPA Subtest-2	22.81	22.82	22.80	22.02	22.00	22.03	21.52	21.58	21.55
DC-HSDPA Subtest-3	22.42	22.45	22.37	21.56	21.50	21.63	21.01	21.10	20.97
DC-HSDPA Subtest-4	22.40	22.51	22.36	21.55	21.51	21.58	21.10	21.04	21.01
HSUPA Subtest-1	22.19	22.27	22.32	21.57	21.60	21.48	21.37	21.43	21.33
HSUPA Subtest-2	20.34	20.07	20.12	19.39	19.33	19.33	18.86	18.90	18.84
HSUPA Subtest-3	21.12	21.43	21.25	20.15	20.17	20.25	20.09	20.15	20.06
HSUPA Subtest-4	20.41	20.63	20.29	19.26	19.44	19.27	18.97	18.97	18.90
HSUPA Subtest-5	22.97	23.06	22.90	22.40	22.40	22.40	21.90	22.00	21.80





Bottom Antenna

Conducted Power (*Unit: dBm)						
Band	GSM850			GSM1900		
Channel	128	189	251	512	661	810
Frequency	824.2	836.4	848.8	1850.2	1880.0	1909.8
GSM	32.02	32.10	32.12	30.09	30.12	30.25
GPRS class 8	32.00	32.08	32.11	30.08	30.10	30.24
GPRS class 10	28.59	28.72	28.79	27.10	27.01	26.88
GPRS class 11	26.70	26.78	26.86	25.20	25.05	24.99
GPRS class 12	25.37	25.46	25.66	23.49	23.78	23.79
EGPRS class 8(GMSK)	31.99	32.01	32.09	30.05	29.95	30.22
EGPRS class 10(GMSK)	28.54	28.68	28.68	27.02	26.95	26.77
EGPRS class 11(GMSK)	26.66	26.65	26.85	25.04	24.99	24.89
EGPRS class 12(GMSK)	25.33	25.31	25.44	23.46	23.69	23.75
EGPRS class 8(8PSK)	25.05	25.14	25.12	25.70	25.62	25.51
EGPRS class 10(8PSK)	22.30	22.40	22.28	22.76	22.70	22.61
EGPRS class 11(8PSK)	20.54	20.57	20.58	20.90	20.85	20.78
EGPRS class 12(8PSK)	19.30	19.34	19.34	19.51	19.60	19.50

Conducted Power (*Unit: dBm)									
Band	WCDMA Band V			WCDMA Band II			WCDMA Band IV		
Channel	4132	4182	4233	9262	9400	9538	1312	1413	1513
Frequency	826.4	836.4	846.6	1852.4	1880	1907.6	1712.4	1732.6	1752.6
AMR 12.2K	24.01	24.07	23.93	23.53	23.52	23.50	23.03	23.07	22.87
RMC 12.2K	24.03	24.08	23.95	23.54	23.53	23.52	23.05	23.08	22.88
HSDPA Subtest-1	23.65	23.81	23.85	22.93	22.78	22.76	22.47	22.53	22.40
HSDPA Subtest-2	23.20	23.33	23.36	22.12	22.08	22.04	21.56	21.66	21.61
HSDPA Subtest-3	22.75	22.92	22.92	21.62	21.50	21.45	21.20	21.23	21.18
HSDPA Subtest-4	22.77	22.95	22.94	21.61	21.51	21.47	21.13	21.17	21.12
DC-HSDPA Subtest-1	23.63	23.78	23.81	22.91	22.74	22.70	22.46	22.51	22.37
DC-HSDPA Subtest-2	23.17	23.30	23.31	22.10	22.07	22.00	21.51	21.60	21.58
DC-HSDPA Subtest-3	22.74	22.90	22.91	21.58	21.45	21.41	21.18	21.20	21.14
DC-HSDPA Subtest-4	22.75	22.93	22.91	21.55	21.47	21.44	21.10	21.12	21.09
HSUPA Subtest-1	22.60	22.65	22.80	21.71	21.62	21.50	21.38	21.13	21.28
HSUPA Subtest-2	19.70	20.57	19.94	19.44	19.52	19.44	18.73	18.81	18.78
HSUPA Subtest-3	21.48	21.37	20.63	20.25	20.39	20.26	19.99	19.94	19.87
HSUPA Subtest-4	20.54	20.40	19.66	19.21	19.41	19.29	19.14	18.79	18.64
HSUPA Subtest-5	22.70	22.70	22.60	22.40	22.30	22.40	21.90	21.90	21.80



**ERP/EIRP**

For Top Antenna

GSM850 ( $G_T - L_C = -4.00$ dB)			
Channel	128	189	251
	(Low)	(Mid)	(High)
Frequency	824.2	836.4	848.8
(MHz)			
Conducted Power (dBm)	32.85	33.26	33.06
Conducted Power (Watts)	1.9275	2.1184	2.0230
ERP(dBm)	26.70	27.11	26.91
ERP(Watts)	0.4677	0.5140	0.4909



For Bottom Antenna

EDGE850(8PSK) ( $G_T - L_C = -3.60$ dB)			
Channel	128	189	251
	(Low)	(Mid)	(High)
Frequency	824.2	836.4	848.8
(MHz)			
Conducted Power (dBm)	25.05	25.14	25.12
Conducted Power (Watts)	0.3199	0.3266	0.3251
ERP(dBm)	19.30	19.39	19.37
ERP(Watts)	0.0851	0.0869	0.0865

GSM1900 ( $G_T - L_C = 0.00$ dB)			
Channel	512	661	810
	(Low)	(Mid)	(High)
Frequency	1850.2	1880	1909.8
(MHz)			
Conducted Power (dBm)	30.09	30.12	30.25
Conducted Power (Watts)	1.0209	1.0280	1.0593
EIRP(dBm)	30.09	30.12	30.25
EIRP(Watts)	1.0209	1.0280	1.0593

EDGE1900(8PSK) ( $G_T - L_C = 0.00$ dB)			
Channel	512	661	810
	(Low)	(Mid)	(High)
Frequency	1850.2	1880	1909.8
(MHz)			
Conducted Power (dBm)	25.70	25.62	25.51
Conducted Power (Watts)	0.3715	0.3648	0.3556
EIRP(dBm)	25.70	25.62	25.51
EIRP(Watts)	0.3715	0.3648	0.3556



WCDMA Band V ( $G_T - L_C = -3.60$ dB)			
Channel	4132	4182	4233
	(Low)	(Mid)	(High)
Frequency	826.4	836.4	846.6
(MHz)			
Conducted Power (dBm)	24.03	24.08	23.95
Conducted Power (Watts)	0.2529	0.2559	0.2483
ERP(dBm)	18.28	18.33	18.20
ERP(Watts)	0.0673	0.0681	0.0661

WCDMA Band II ( $G_T - L_C = 0.00$ dB)			
Channel	9262	9400	9538
	(Low)	(Mid)	(High)
Frequency	1852.4	1880	1907.6
(MHz)			
Conducted Power (dBm)	23.54	23.53	23.52
Conducted Power (Watts)	0.2259	0.2254	0.2249
EIRP(dBm)	23.54	23.53	23.52
EIRP(Watts)	0.2259	0.2254	0.2249

WCDMA Band IV ( $G_T - L_C = 0.00$ dB)			
Channel	1312	1413	1513
	(Low)	(Mid)	(High)
Frequency	1712.4	1732.6	1752.6
(MHz)			
Conducted Power (dBm)	23.05	23.08	22.88
Conducted Power (Watts)	0.2018	0.2032	0.1941
EIRP(dBm)	23.05	23.08	22.88
EIRP(Watts)	0.2018	0.2032	0.1941



**Peak-to-Average Ratio**

Mode	GSM850(dB)		Limit: 13dB
Mod.	GSM	EDGE class 8	Result
Lowest CH	0.29	3.07	PASS
Middle CH	0.26	3.04	
Highest CH	0.29	2.72	

Mode	GSM1900(dB)		Limit: 13dB
Mod.	GSM	EDGE class 8	Result
Lowest CH	0.23	3.19	PASS
Middle CH	0.23	3.28	
Highest CH	0.29	3.33	

Mode	WCDMA Band V(dB)	WCDMA Band II(dB)	WCDMA Band IV(dB)	Limit: 13dB
Mod.	RMC 12.2Kbps	RMC 12.2Kbps	RMC 12.2Kbps	Result
Lowest CH	2.81	2.78	3.16	PASS
Middle CH	3.07	3.04	3.01	
Highest CH	2.99	2.43	3.28	



GSM850 (GSM)

Lowest Channel

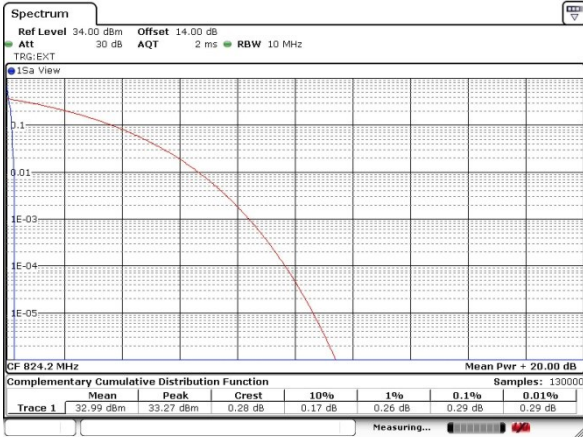

Date: 22.MAY.2019 09:33:28

GSM850 (EDGE class 8)

Lowest Channel

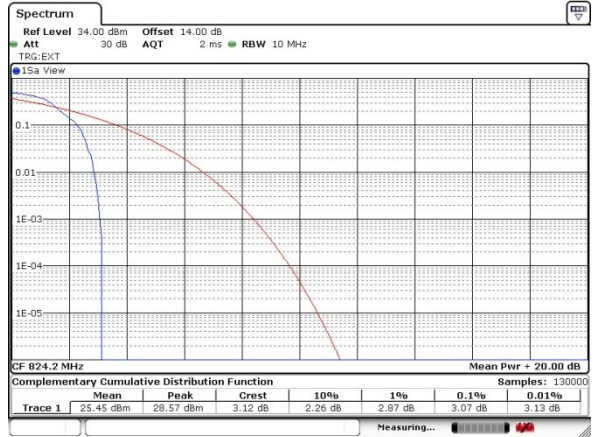

Date: 22.MAY.2019 09:59:33

Middle Channel

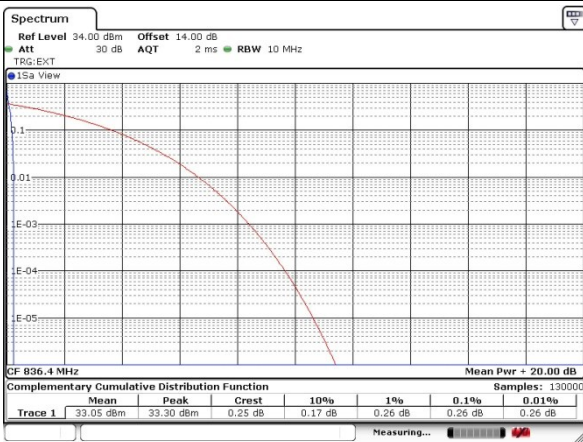

Date: 22.MAY.2019 09:33:45

Middle Channel

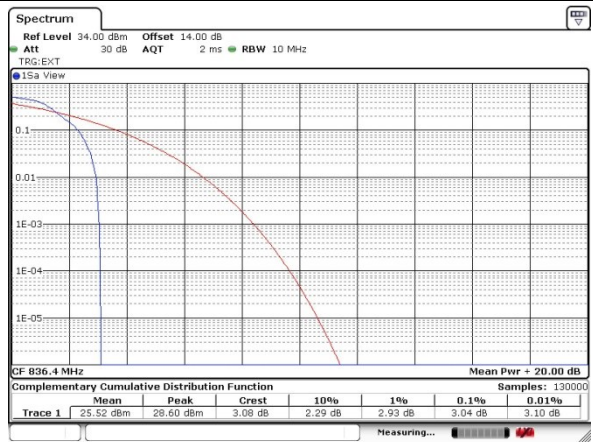

Date: 22.MAY.2019 09:59:55

Highest Channel

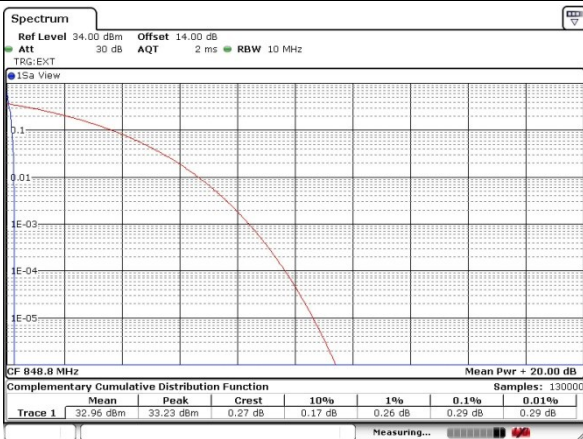

Date: 22.MAY.2019 09:34:05

Highest Channel

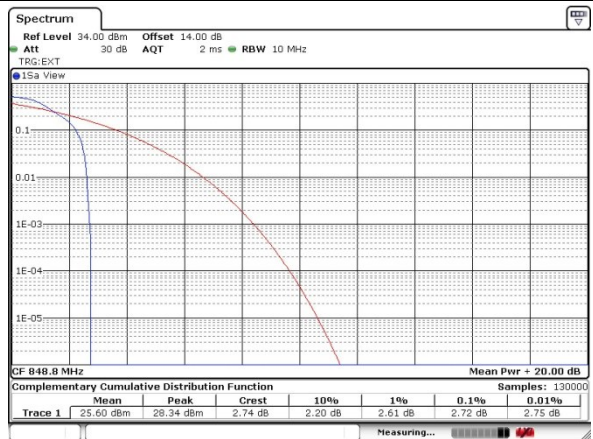

Date: 22.MAY.2019 10:00:15



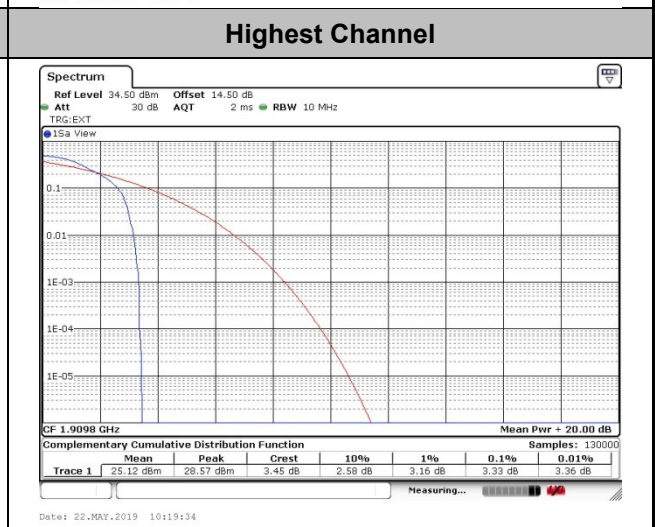
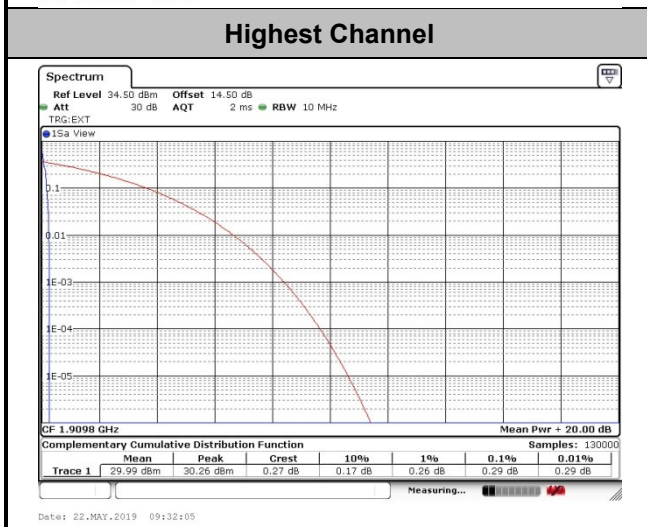
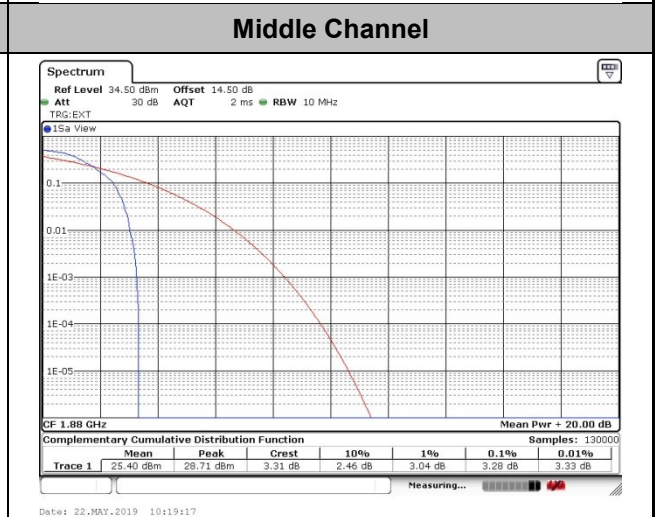
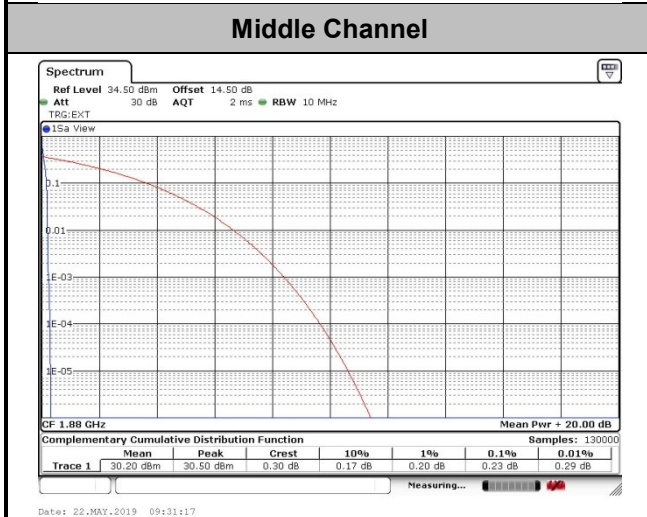
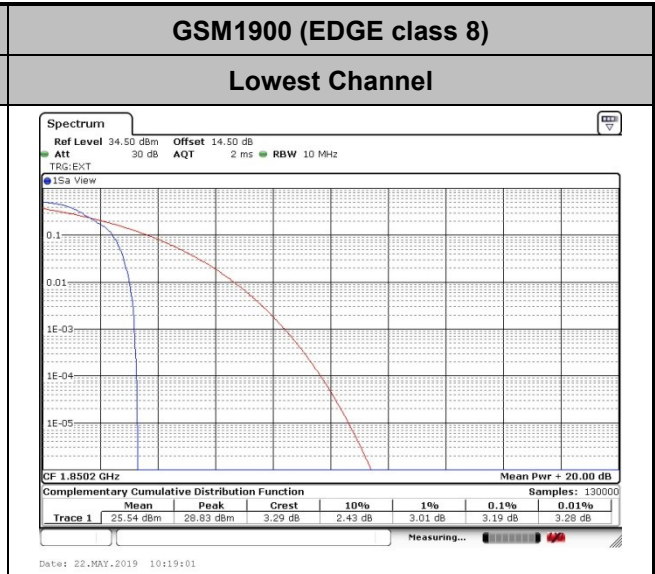
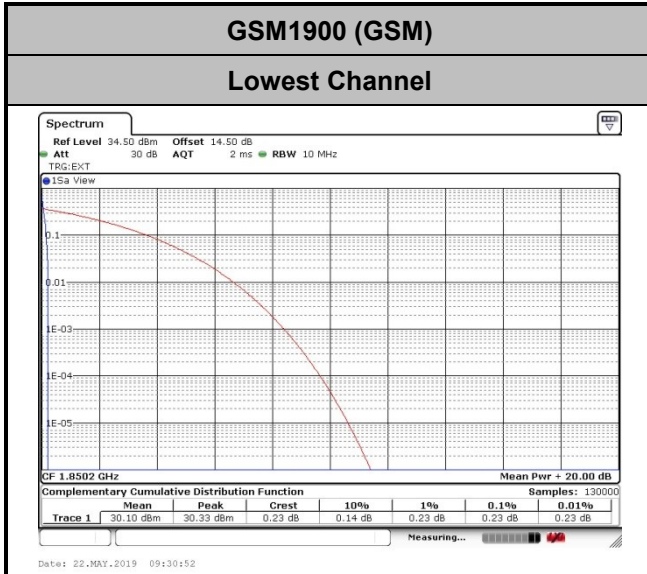

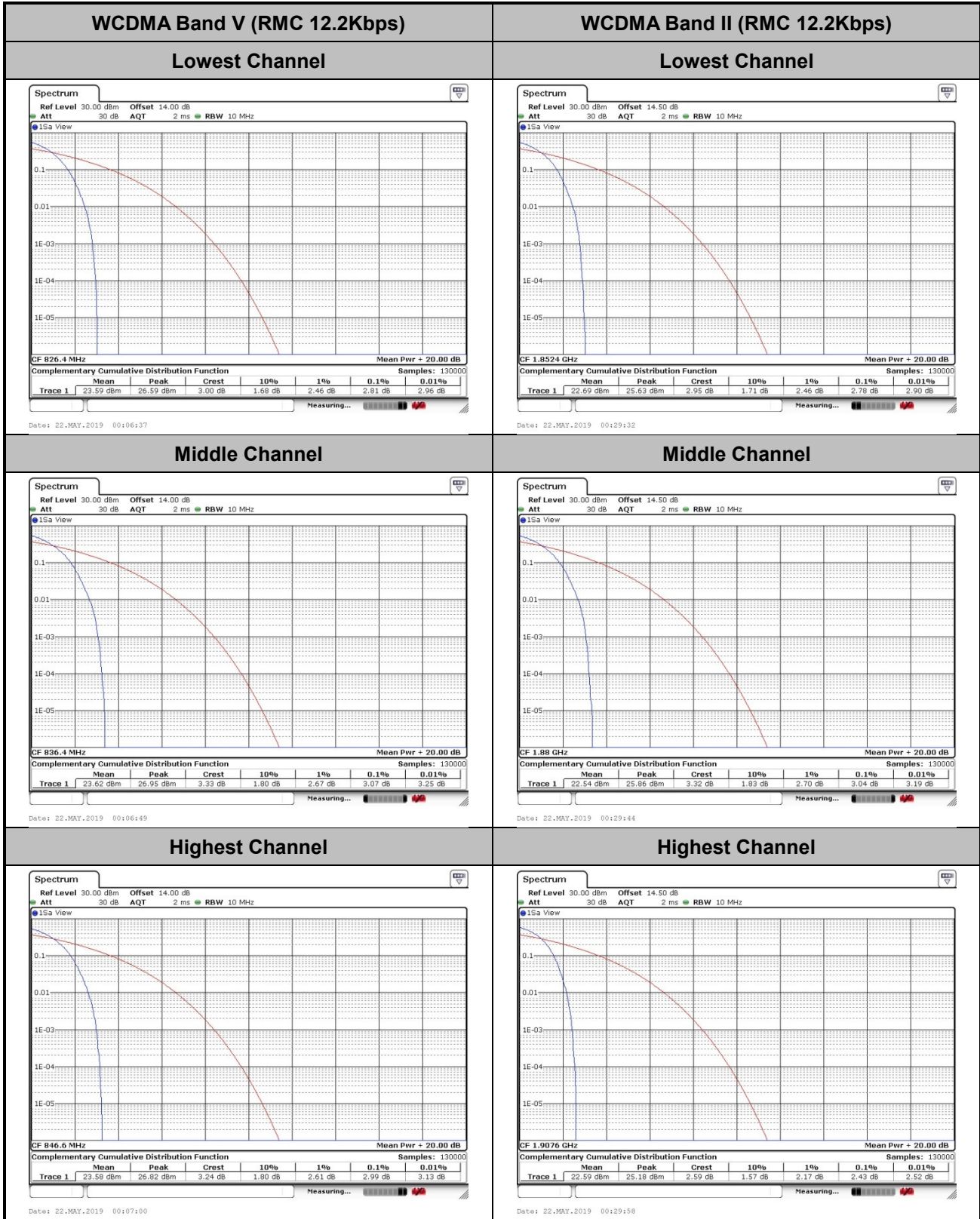



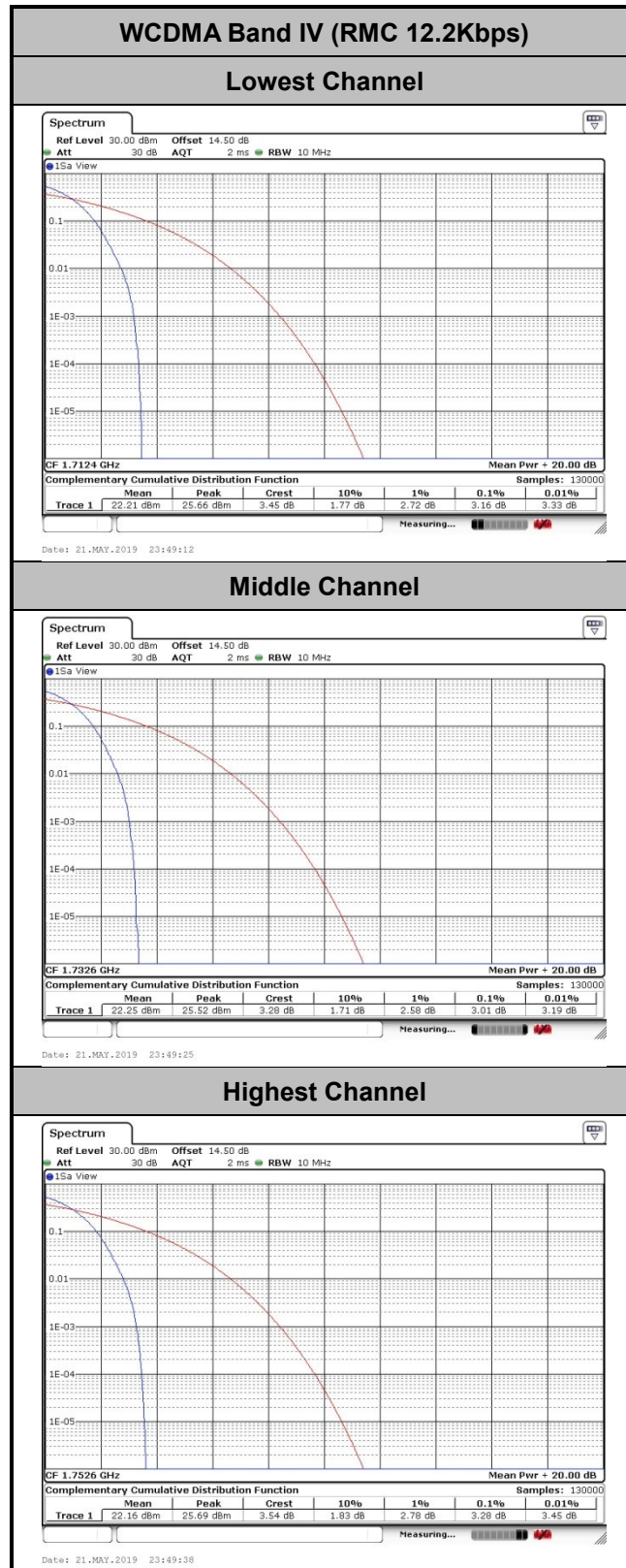



**26dB Bandwidth**

Mode	GSM850(KHz)	
Mod.	GSM	EDGE class 8
Lowest CH	314.7	314.7
Middle CH	312.7	305.7
Highest CH	313.7	306.7

Mode	GSM1900(KHz)	
Mod.	GSM	EDGE class 8
Lowest CH	318.7	305.7
Middle CH	314.7	293.7
Highest CH	314.7	306.7

Mode	WCDMA Band V(MHz)	WCDMA Band II(MHz)	WCDMA Band IV(MHz)
Mod.	RMC 12.2Kbps	RMC 12.2Kbps	RMC 12.2Kbps
Lowest CH	4.715	4.715	4.705
Middle CH	4.705	4.695	4.705
Highest CH	4.705	4.745	4.695



GSM850 (GSM)

Lowest Channel

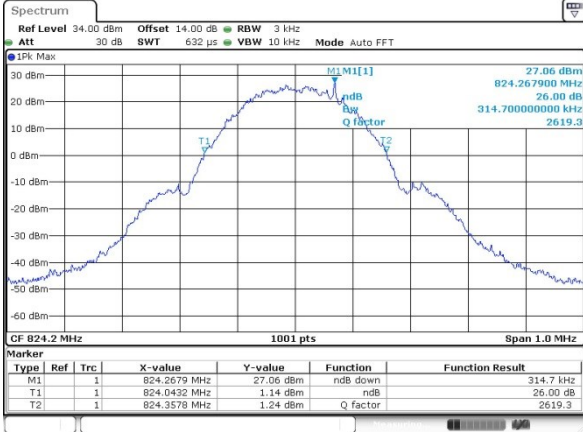

Date: 22\_MAY\_2019 09:01:07

GSM850 (EDGE class 8)

Lowest Channel

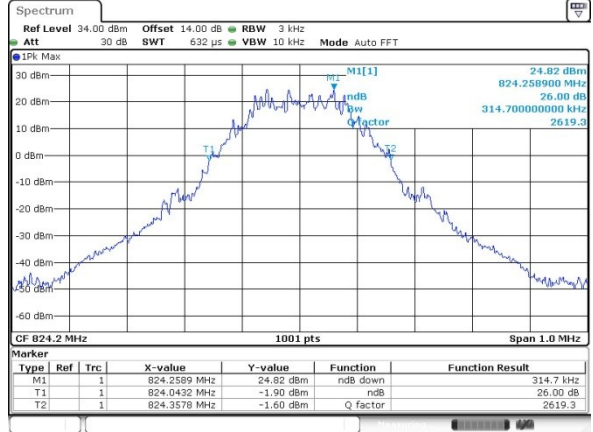

Date: 22\_MAY\_2019 09:50:26

Middle Channel

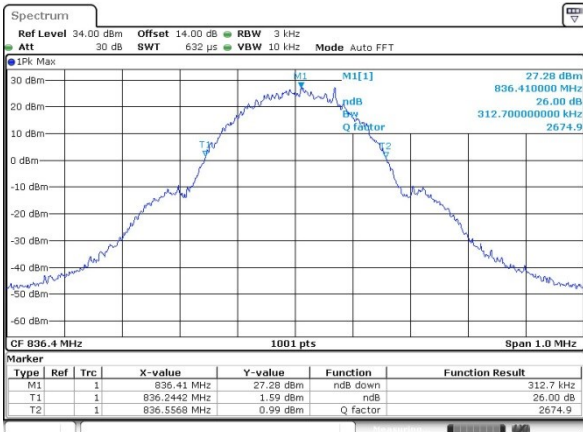

Date: 22\_MAY\_2019 09:01:45

Middle Channel



Date: 22\_MAY\_2019 09:51:04

Highest Channel

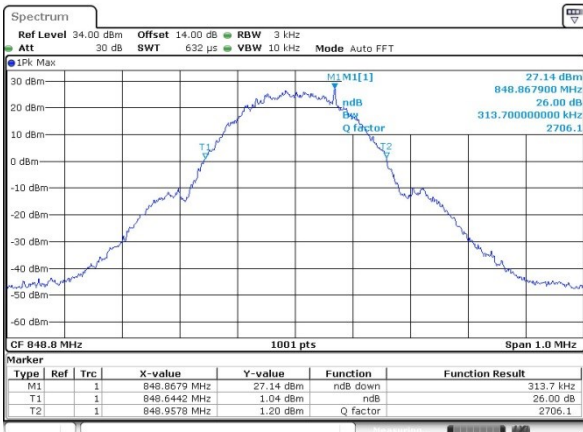

Date: 22\_MAY\_2019 09:02:21

Highest Channel



Date: 22\_MAY\_2019 09:51:42



GSM1900 (GSM)

Lowest Channel

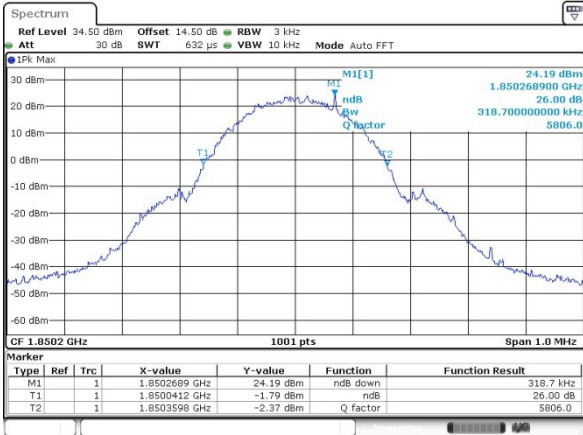

Date: 22\_MAY\_2019 09:20:47

GSM1900 (EDGE class 8)

Lowest Channel

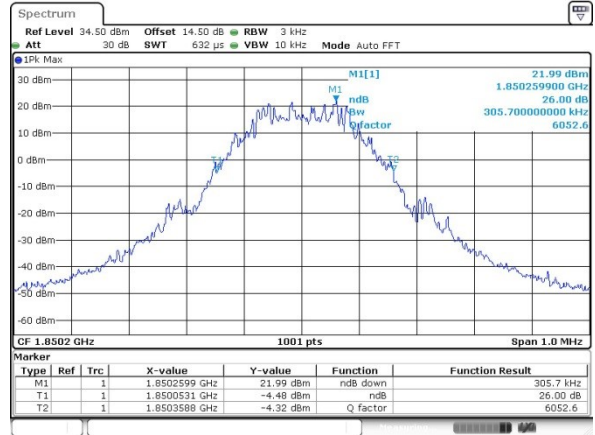

Date: 22\_MAY\_2019 10:09:00

Middle Channel

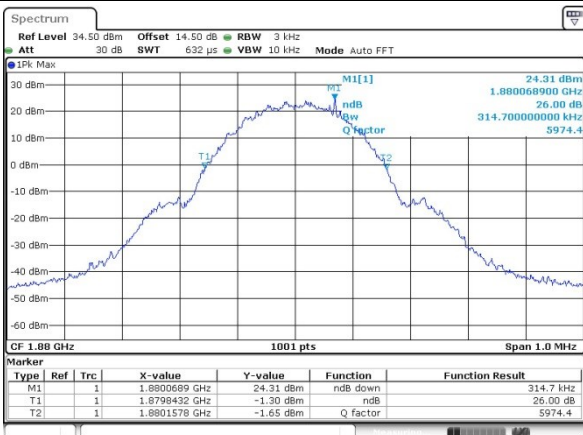

Date: 22\_MAY\_2019 09:21:28

Middle Channel

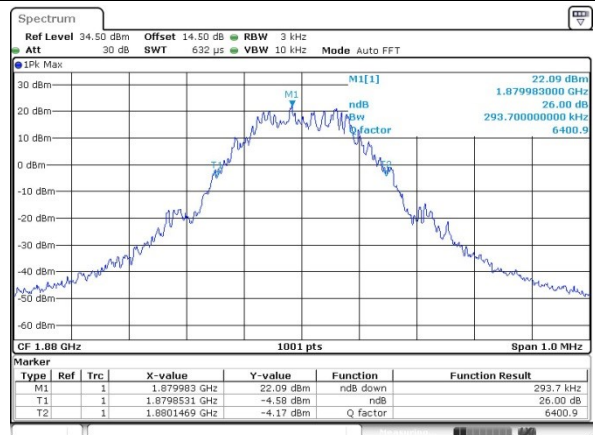

Date: 22\_MAY\_2019 10:09:35

Highest Channel

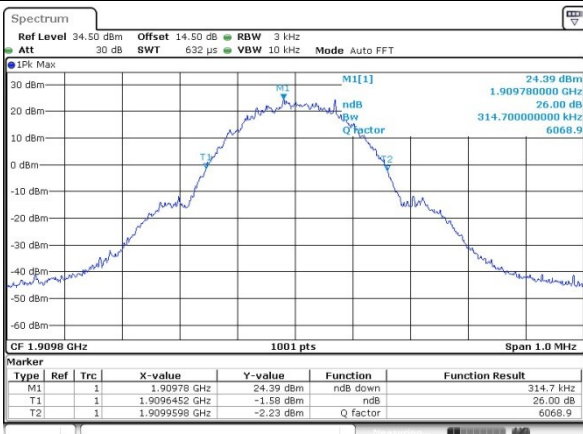

Date: 22\_MAY\_2019 09:22:04

Highest Channel



Date: 22\_MAY\_2019 10:10:30