



EMC Test Report

Product Name: 300Mbps WiFi Extender

Product Model: WE3200

Report Number: SYBH(Z-EMC)20180622017001-2

FCC ID: QISWE3200

Reliability Laboratory of Huawei Technologies Co., Ltd.

(Global Compliance and Testing Center of Huawei Technologies Co., Ltd)

Administration Building, Headquarters of Huawei Technologies Co., Ltd., Bantian, Longgang District,
Shenzhen, 518129, P.R.C

Tel: +86 755 28780808 Fax: +86 755 89652518

Notice

1. The laboratory has passed the accreditation by China National Accreditation Service for Conformity Assessment (CNAS). The accreditation number is L0310.
2. The laboratory has passed the accreditation by The American Association for Laboratory Accreditation (A2LA). The accreditation number is 2174.01
3. The laboratory has been listed by Industry Canada to perform electromagnetic emission measurements. The recognition numbers of test site are 6369A-1.
4. The laboratory (Reliability Lab of Huawei Technologies Co., Ltd) is also named “Global Compliance and Testing Center of Huawei Technologies Co., Ltd” , the both names have coexisted since 2009.
5. The laboratory has been recognized by the US Federal Communications Commission (FCC) to perform compliance testing subject to the Commission's Certification rules. The Designation Number is CN1173, and the Test Firm Registration Number is 294140.
6. The test report is invalid if not marked with the signatures of the persons responsible for preparing and approving the test report.
7. The test report is invalid if there is any evidence of erasure and/or falsification.
8. If there is any dissidence for the test report, please file objection to the test centre within 15 days from the date of receiving the test report.
9. Normally, the test report is only responsible for the samples that have undergone the test.
10. Content of the test report, in part or in full, cannot be used for publicity and/or promotional purposes without prior written approval from the laboratory.



Applicant: Huawei Technologies Co., Ltd.
Address: Administration Building, Headquarters of Huawei Technologies Co., Ltd., Bantian, Longgang District, Shenzhen, 518129, P.R.C

Date of Receipt Test Item: 2018-07-15
Start Date of Test: 2018-07-15
End Date of Test: 2018-07-25

Test Result: Pass

Approved By (Lab Manager)	2018-07-27	He Hao	<i>He Hao</i>
	Date	Name	Signature

Operator (Test Engineer)	2018-07-25	FengJinhua	<i>Feng Jinhua</i>
	Date	Name	Signature



Modification Record

No.	Last Report No.	Modification Description
1	NA	First report

TABLE OF CONTENT

1	General Information.....	6
1.1	EUT Description	6
1.2	Test Site Information.....	7
1.3	Applied Standards.....	7
2	Summary of Results.....	8
3	System Configuration during EMC Test.....	9
3.1	Test Mode	9
3.2	Test System Configuration	10
3.3	Cables Used during Test.....	11
3.4	Associated Equipment Used during Test	11
4	Electromagnetic Interference (EMI)	12
4.1	Radiated Disturbance 30MHz to 18GHz.....	12
4.2	Conducted Disturbance 0.15 MHz to 30MHz.....	14
5	Main Test Instruments.....	15
6	System Measurement Uncertainty	15
7	Test Data and Graph.....	16
7.1	Radiated Disturbance.....	16
7.2	Conducted Disturbance.....	18

1 General Information

1.1 EUT Description

EUT Description	
Product Name	300Mbps WiFi Extender
Model Number	WE3200
Input voltage	AC:100~240 V 0.5A
TX Frequency	WIFI 2.4G 2400MHz to 2483.5MHz
RX Frequency	WIFI 2.4G 2400MHz to 2483.5MHz
S/N	J4N8W18528000113
HW Version	AM1WE3200M
SW Version	8.0.1.5

Remark: The above EUT's information is declared by manufacturer. Please refer to the specifications or user's manual for more detailed information.



1.2 Test Site Information

Test Site 1:	RELIABILITY LABORATORY OF HUAWEI TECHNOLOGIES CO., LTD.
Test Site Location:	Administration Building, Headquarters of Huawei Technologies Co., Ltd., Bantian, Longgang District, Shenzhen, 518129, P.R.C

1.3 Applied Standards

APPLIED STANDARD

47 CFR FCC Part 15 2017, Subpart B

2 Summary of Results

Summary of Results				
Test Items	Test Mode	Performance Class & Required Performance Criteria	Result	Site
<u>Radiated Emissions</u> Enclosure Port	Mode1 Mode2	CLASS B	Pass	Site1
<u>Conducted Emissions</u> <input type="checkbox"/> DC Power Port <input checked="" type="checkbox"/> AC Power Port <input type="checkbox"/> Telecommunication Ports	Mode1 Mode2	CLASS B	Pass	Site1
Note: 1, Measurement taken is within the uncertainty of test system. 2, <input checked="" type="checkbox"/> The item has been tested; <input type="checkbox"/> The item has not been tested.				

During the measurement, the environmental conditions complied with the range listed as below.

Item	Required
Ambient temperature	15°C ~ 35°C
Relative humidity	25% ~ 75%
Atmospheric pressure	86kPa ~ 106kPa

3 System Configuration during EMC Test

3.1 Test Mode

The EUT was configured, installed, arranged and operated in a manner consistent with typical application. The following mode(s) were applied during the compliance test.

Test Mode	
Mode 1:	EUT+LAN+Wireless Service Idle Mode
Mode 2:	EUT+LAN+Wireless Service Traffic Mode

Remark:

- 1) If there is one kind of accessories with different models, each one should be applied throughout the compliance test respectively, however, only the worst case will be recorded in this report.
- 2) If EUT has more than one typical operation, only the worst test mode will be recorded in this report.

Worst Case:

- 1) Radiated Emission

Mode 1: EUT (SN: J4N8W18528000113) + LAN + Wireless Service idle .This result is the worst case.

- 2) Conducted Emission

Mode 2: EUT (SN: J4N8W18528000113)) + LAN + Wireless Service Traffic. This result is the worst case.

3.2 Test System Configuration

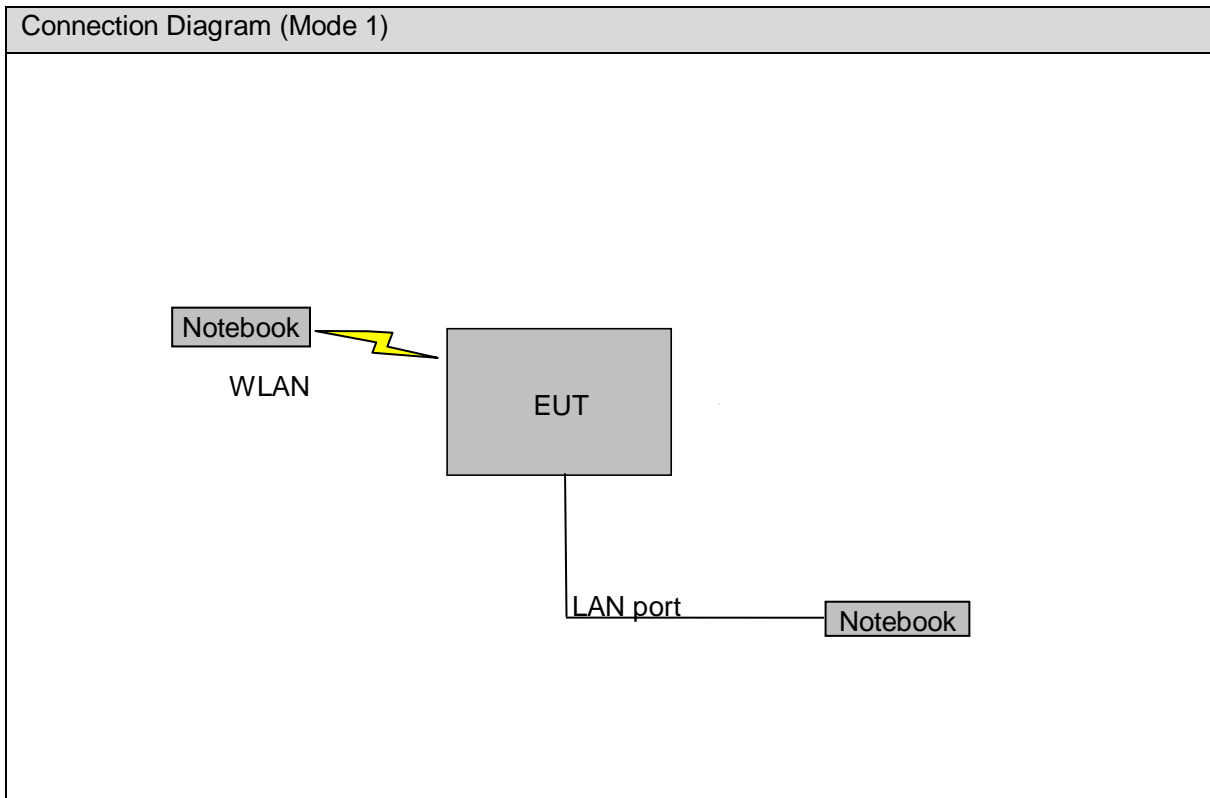

3.3 Cables Used during Test

Cable	Quantity	Length	Type of Cable
Lan Cable	1	<3m	unshielded

3.4 Associated Equipment Used during Test

Name	Model	Manufacturer	S/N	Calibrated Deadline	Cal interval
Notebook	X230	Lenovo	A130911985	N/A	Notebook
Notebook	X230	Lenovo	A131113804	N/A	Notebook

4 Electromagnetic Interference (EMI)

4.1 Radiated Disturbance 30MHz to 18GHz

4.1.1 Test Procedure

The test site semi-anechoic chamber has met the requirement of NSA tolerance 4dB according to the standards: ANSI C63.4-2014. The test distance was 3m. The set-up and test methods were according to ANSI C63.4-2014.

A preliminary scan and a final scan of the emissions were made from 30 MHz to 40 GHz by using test script of software; The emissions were measured using Quasi-Peak Detector (30MHz~1GHz) and AV/PK detector (above 1GHz). The maximal emission value was acquired by adjusting the antenna height, polarisation and turntable azimuth in accordance with the software setup. Normally, the height range of antenna was 1m to 4m. The azimuth range of turntable was 0° to 360°. The receiving antenna has two polarizations V and H.

Measurement bandwidth (RBW) for 30MHz to 1000 MHz: 120 kHz;

Measurement bandwidth (RBW) for 1000MHz to 18000 MHz: 1MHz;

EUT was configured in idle mode and the test performed at worst emission state.

4.1.2 Test setup

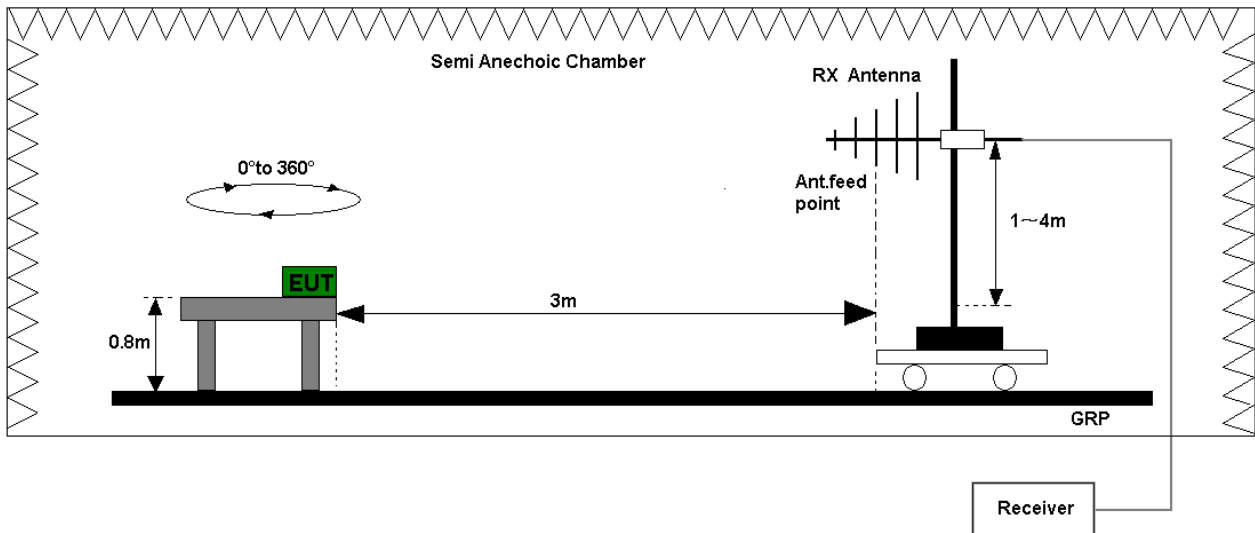

Figure 1. Test set-up of radiated disturbance(30MHz-1GHz)

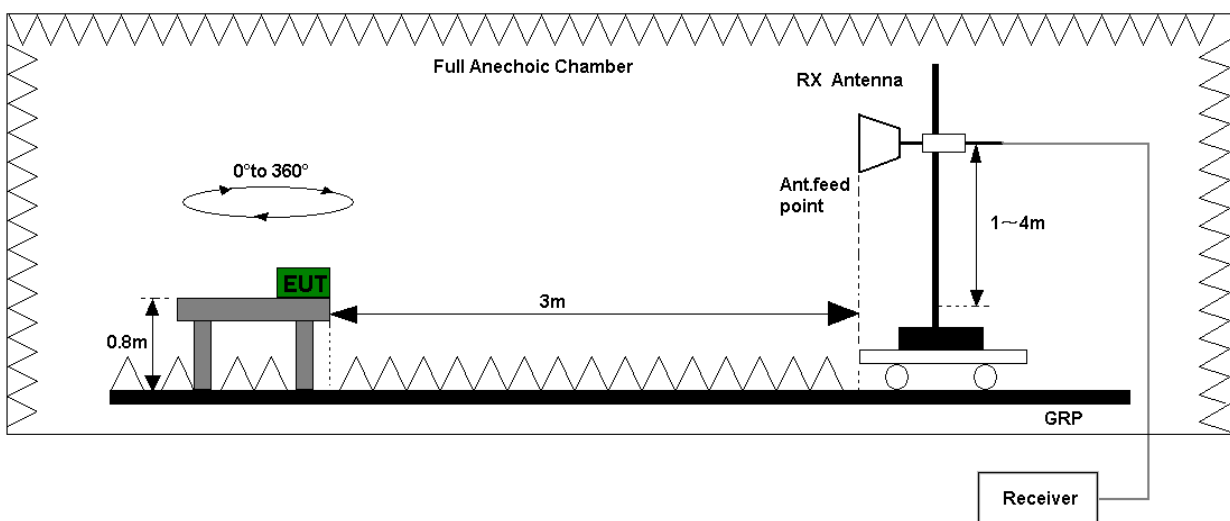

Figure 2. Test set-up of radiated disturbance(above 1GHz)

4.1.3 Test Results

The EUT has met the requirements for Radiated Emission of enclosure port.
Refer to the section 7.1 of this report for test data.

Test Limits (Class B)				
Frequency of Emission (MHz)	Radiated Limit			
	Unit(μ V/m)		Unit(dB μ V/m)	
30-88	100		40	
88-216	150		43.5	
216-960	200		46	
Above 960	500		54	
Above 1000	AV	PK	AV	PK
	500	5000	54	74

4.2 Conducted Disturbance 0.15 MHz to 30MHz

4.2.1 Test Procedure

The Table-top EUT was placed upon a non-metallic table 0.8 m above the horizontal metal reference ground plane. EUT was connected to LISN and LISN was connected to reference Ground Plane. EUT was 80cm away from LISN. The set-up and test methods were according to ANSI C63.4-2014. Conducted Disturbance at AC Port measurements were undertaken on the L and N Lines. The emissions were measured using a Quasi-Peak Detector and Average Detector.

EUT was communicated with the simulator through Air interface, the simulator controls the EUT to transmitter the maximum power which defined in specification of product. The EUT operated on the typical channel.

Measurement bandwidth (RBW) for 150 kHz to 30 MHz: 9 kHz;

The EUT was set in the shielded chamber and operated under nominal conditions.

4.2.2 Test Setup

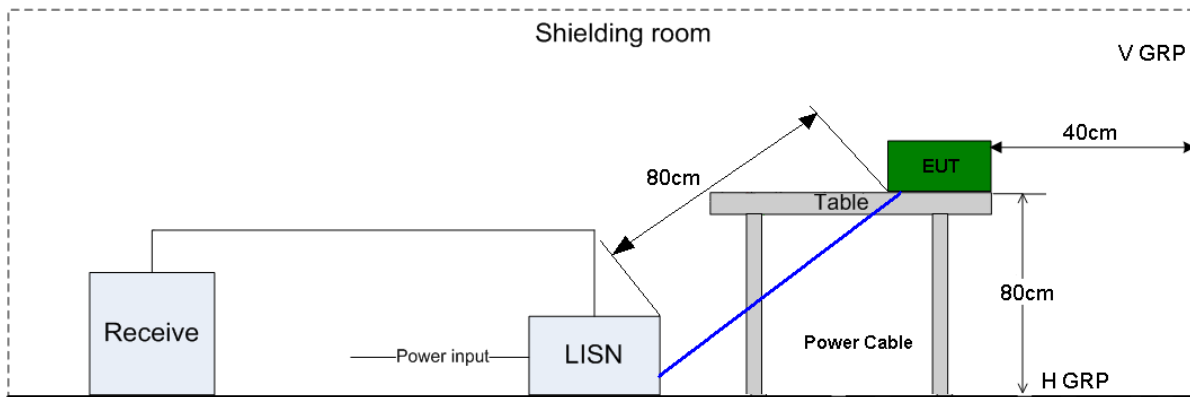

Figure 3. Test Set-up of conducted disturbance

4.2.3 Test Results

The EUT has met requirements for Conducted disturbance of power lines.

Refer to the section 7.2 of this report for test data.

Test Limit of AC Power Port(CLASS B)		
Frequency range	150kHz ~ 30MHz	
Frequency	Voltage limits	
	QP (dB μ V)	AV (dB μ V)
0.15MHz~0.5MHz	66-56	56-46
0.5MHz-5MHz	56	46
5MHz~30MHz	60	50

5 Main Test Instruments

Main Test Equipments						
Test item	Test Instrument	Model	S/N	Manufacturer	Calibrated Deadline	Cal interval
RE	EMI Test receiver	ESU26	100150	R&S	Jan. 19, 2019	12
	Broadband Antenna	VULB 9163	9163-491	SCHWARZBECK	Mar. 28, 2019	24
	Horn Antenna	HF906	100683	R&S	May. 07, 2019	24
CE	EMI Test receiver	ESCI	101163	R&S	May. 07, 2019	12
	Artificial Mains Network	ENV4200	100134	R&S	May. 07, 2019	12
	Artificial Mains Network	ENV216	100382	R&S	May. 07, 2019	12
Software Information						
Test Item	Software Name	Manufacturer		Version		
RE	EMC32	R&S		V9.25.0		
CE	EMC32	R&S		V9.25.0		

6 System Measurement Uncertainty

For a 95% confidence level, the measurement expanded uncertainties for defined systems, in accordance with the recommendations of ISO 17025 were:

System Measurement Uncertainty		
Items	Extended Uncertainty	
RE(30MHz-1GHz)	Field strength (dB μ V/m)	U=5.24dB; k=2
RE(1GHz-18GHz)	Field strength (dB μ V/m)	U=4.94dB; k=2
CE	Disturbance Voltage (dB μ V)	U=2.3dB; k=2

7 Test Data and Graph

Only the worst test results were shown

7.1 Radiated Disturbance

7.1.1 30MHz~1GHz

Test Mode: EUT+LAN+Wireless Service Idle Mode

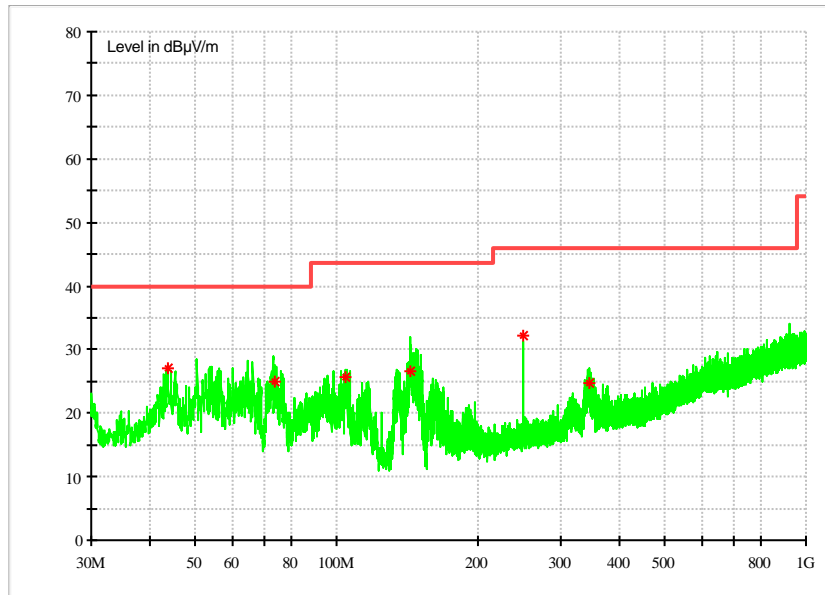

MEASUREMENT RESULT: QP Detector

Frequency MHz	Level dBµV/m	Transd dB	Limit dBµV/m	Margin dB	Height cm	Azimuth deg	Polarisation
43.777600	27.01	14.5	40.00	12.99	101.0	109.0	V
73.901880	24.91	9.2	40.00	15.09	151.0	311.0	V
104.173640	25.69	14.2	43.50	17.81	100.0	158.0	V
143.301640	26.52	9.9	43.50	16.98	101.0	195.0	V
249.997800	32.30	14.3	46.00	13.70	101.0	100.0	H
346.412560	24.61	16.8	46.00	21.39	200.0	126.0	V

Note:

Level = Reading level by receiver + Transd (Antenna factor + cable loss – preamplifier gain)
The reading level is calculated by software which is not shown in the sheet.

7.1.2 1GHz~18GHz

Test Mode: EUT+LAN+Wireless Service Idle Mode

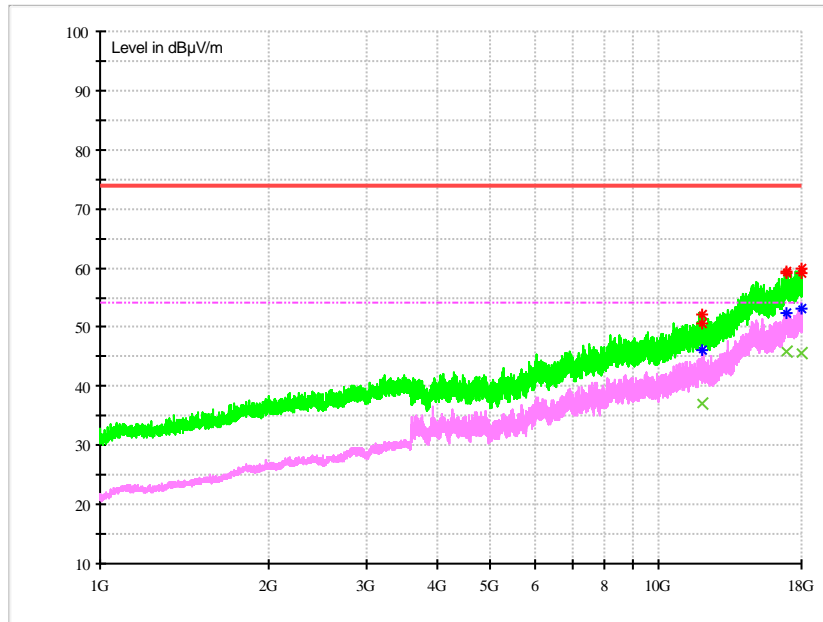

MEASUREMENT RESULT: PK Detector

Frequency MHz	Level dBµV/m	Transd dB	Limit dBµV/m	Margin dB	Height cm	Azimuth deg	Polarisation
11956.731	50.72	11	74	23.28	153	264	H
16892.961	59.39	21	74	14.61	187	161	H
17996.895	59.08	21.1	74	14.92	156	319	H

MEASUREMENT RESULT: AV Detector

Frequency MHz	Level dBµV/m	Transd dB	Limit dBµV/m	Margin dB	Height cm	Azimuth deg	Polarisation
11949.655	37.17	11	54	16.83	100	183	H
16895.117	45.78	20.9	54	8.22	100	134	V
17993.374	45.56	21.1	54	8.44	109	317	V

Note:

Level = Reading level by receiver + Transd (Antenna factor + cable loss – preamplifier gain)

The reading level is calculated by software which is not shown in the sheet.

7.2 Conducted Disturbance

7.2.1 AC Port Test Data

Test Mode: EUT+LAN+Wireless Service Traffic Mode

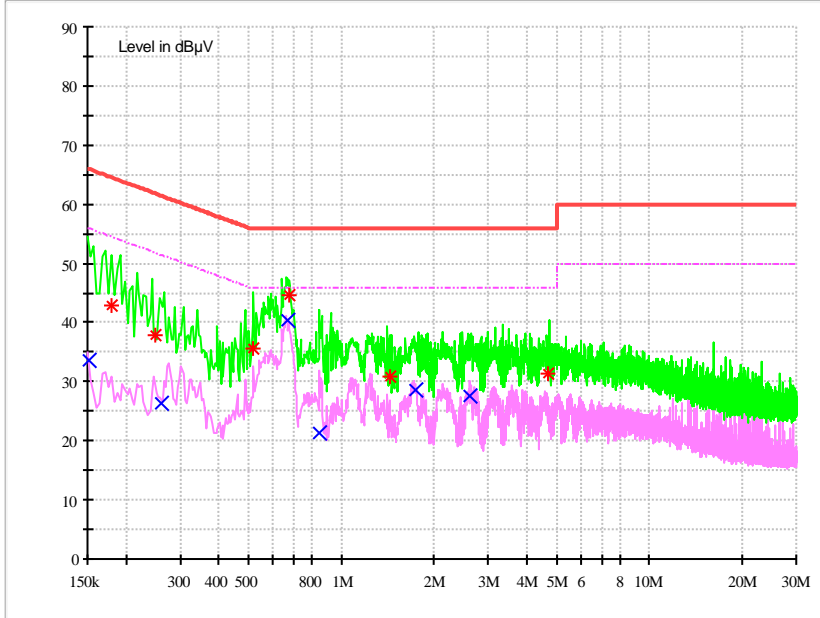

MEASUREMENT RESULT: QP Detector

Frequency MHz	Level dBµV	Line	Transd dB	Margin dB	Limit dBµV	PE
0.179758	42.89	N	9.7	21.61	64.5	FLO
0.248085	37.87	N	9.7	23.95	61.82	FLO
0.515486	35.68	N	9.7	20.32	56	FLO
0.675948	44.74	N	9.7	11.26	56	FLO
1.433625	30.91	N	9.7	25.09	56	FLO
4.707652	31.32	N	9.8	24.68	56	FLO

MEASUREMENT RESULT: AV Detector

Frequency MHz	Level dBµV	Line	Transd dB	Margin dB	Limit dBµV	PE
0.151802	33.47	N	9.7	22.43	55.9	FLO
0.261641	26.24	N	9.7	25.14	51.38	FLO
0.667378	40.3	N	9.7	5.7	46	FLO
0.849060	21.31	L1	9.7	24.69	46	FLO
1.743023	28.53	N	9.7	17.47	46	FLO
2.600918	27.49	N	9.7	18.51	46	FLO

-----**END**-----