



FCC RF Test Report

Product Name: Smart Phone

Model Number: VOG-L29/VOG-L09

Report No.: SYBH(Z-RF)20181224014002-2003

FCC ID : QISVOG-LX9

Authorized	APPROVED (Lab Manager)	PREPARED (Test Engineer)
BY	He Hao	Zhang shuangxia
DATE	2019-01-28	2019-01-28

Reliability Laboratory of Huawei Technologies Co., Ltd.

(Global Compliance and Testing Center of Huawei Technologies Co., Ltd)

No.2, New City Avenue, Songshan Lake Sci. & Tech. Industry Park, Dongguan, 523808, P.R.C
Telephone: +86 769 23830808 Fax: +86 769 23837628

※ ※ **Notice** ※ ※

1. The laboratory has passed the accreditation by The American Association for Laboratory Accreditation (A2LA). The accreditation number is 2174.01.
2. The laboratory has been recognized by the US Federal Communications Commission (FCC) to perform compliance testing subject to the Commission's Certification rules. The Designation Number is CN1173, and the Test Firm Registration Number is 294140.
3. The laboratory has been recognized by the Innovation, Science and Economic Development Canada (ISED) to test to Canadian radio equipment requirements. The CAB identifier is CN0003, and the ISED# is 21741.
4. The laboratory (Reliability Lab of Huawei Technologies Co., Ltd) is also named “Global Compliance and Testing Center of Huawei Technologies Co., Ltd”, the both names have coexisted since 2009.
5. The test report is invalid if not marked with the signatures of the persons responsible for preparing and approving the test report.
6. The test report is invalid if there is any evidence of erasure and/or falsification.
7. The test report is only valid for the test samples.
8. Content of the test report, in part or in full, cannot be used for publicity and/or promotional purposes without prior written approval from the laboratory.
9. If any question about this report, please contact the laboratory (PublicGCTC@huawei.com).

MODIFICATION RECORD

No.	Report No	Modification Description
1	SYBH(Z-RF)2018122 4014002-2003	First release.

DECLARATION

Type	Description
Multiple Models Applications	<p><input type="checkbox"/> The present report applies to single model.</p> <p><input checked="" type="checkbox"/> The present report applies to several models. The practical measurements are performed with the model <u>VOG-L29</u>.</p> <p>These models utilize the similar radio design, shielding, interface, physical layout and so on. The differences and modifications between these models are declared by the applicant and showed in General Description</p> <p>All others between these models are identical.</p> <p>The present report only presents the worst test case of all modes, see relevant test results for detailed.</p>

1 Table of contents

1	Table of contents	4
2	General Information	5
2.1	Test standard/s	5
2.2	Test Environment	5
2.3	Test Laboratories	6
2.4	Applicant and Manufacturer	6
2.5	Application details	6
3	Test Summary	7
4	Description of the Equipment under Test (EUT)	8
4.1	General Description	8
4.2	EUT Identity	11
4.3	Technical Description	12
5	General Test Conditions / Configurations	13
5.1	EUT Configurations	13
5.2	Antenna requirements	14
5.3	Description of tests	15
5.4	Test Setups	18
5.5	Test Conditions	21
6	Main Test Instruments	23
7	Measurement Uncertainty	25

2 General Information

2.1 Test standard/s

Applied Rules :	47 CFR FCC Part 2, Subpart J 47 CFR FCC Part 15, Subpart C
Test Method :	FCC PUBLIC NOTICE DA 00-705 Filing and Measurement Guidelines for Frequency Hopping Spread Spectrum Systems (Released March 30, 2000) ANSI C63.4-2014, American National Standard for Methods of Measurement of Radio-Noise Emissions from Low-Voltage Electrical and Electronic Equipment in the Range of 9 kHz to 40 GHz. ANSI C63.10-2013, American National Standard for Testing Unlicensed Wireless Devices.

2.2 Test Environment

Temperature :	TN	15 to 30	°C during room temperature tests
Ambient Relative Humidity:	20 to 85 %		
Atmospheric Pressure:	Not applicable		
Power supply :	VL	3.6	V
	VN	3.82	V DC by Battery
	VH	4.35	V

NOTE 1: 1) VN= nominal voltage, VL= low extreme test voltage, VH= High extreme test voltage;

TN= normal temperature, TL= low extreme test temperature, TH= High extreme test temperature.

NOTE 2: The values used in the test report may be stringent than the declared.

2.3 Test Laboratories

Test Location 1 :	RELIABILITY LABORATORY OF HUAWEI TECHNOLOGIES CO., LTD.
Address of Test Location 1 :	No.2, New City Avenue, Songshan Lake Sci. & Tech. Industry Park, Dongguan, 523808, P.R.C

2.4 Applicant and Manufacturer

Company Name :	HUAWEI TECHNOLOGIES CO., LTD
Address :	Administration Building, Headquarters of Huawei Technologies Co., Ltd., Bantian, Longgang District, Shenzhen, 518129, P.R.C

2.5 Application details

Date of Receipt Sample:	2019-01-02
Start of test:	2019-01-03
End of test:	2019-01-28

3 Test Summary

Test Item	FCC Rule No.	Requirements	Test Result	Verdict
20dB Emission Bandwidth (EBW)	15.247(a)(1)	No limit.	Refer to No. SYBH(Z-RF)20181218028001-2003	PASS
Carrier Frequency Separation	15.247(a)(1)	$\geq \text{MAX} \{25\text{kHz}, \text{IFF}\{\text{output power} \leq 125\text{mW}, 2/3 * 20\text{dB EBW}, 20\text{dB EBW}\}\}$.	Refer to No. SYBH(Z-RF)20181218028001-2003	PASS
Number of Hopping Channel	15.247(a)(1)(iii)	≥ 15 channels.	Refer to No. SYBH(Z-RF)20181218028001-2003	PASS
Time of Occupancy (Dwell Time)	15.247(a)(1)(iii)	$< 0.4\text{s}$ within a period of $(0.4\text{s} * \text{hopping number})$.	Refer to No. SYBH(Z-RF)20181218028001-2003	PASS
Maximum Peak Output Power	15.247(b)(1)	FCC: Conducted $< 1\text{W}$ if using ≥ 75 non-overlapping channels.	Refer to No. SYBH(Z-RF)20181218028001-2003	PASS
Band edge spurious emission	15.247(d)	$< -20\text{ dBm}/100\text{ kHz}$ if total peak power \leq power limit.	Refer to No. SYBH(Z-RF)20181218028001-2003	PASS
Conducted RF Spurious Emission			Refer to No. SYBH(Z-RF)20181218028001-2003	PASS
Radiated Emissions in the Restricted Bands	15.247(d) 15.209	FCC Part 15.209 field strength limit;	Refer to No. SYBH(Z-RF)20181218028001-2003	PASS
AC Power Line Conducted Emissions	15.207	FCC Part 15.207 conducted limit;	Refer to No. SYBH(Z-RF)20181218028001-2003	PASS
<p>Note1: The transmitter has an integral PCB loop antenna that is enclosed within the housing of the EUT and meets the requirements of FCC 15.203</p> <p>Note2: We do not test Bluetooth of VOG-L29/VOG-L09, all test data can refer to No. SYBH(Z-RF)20181218028001-2003 of VOG-L04(FCC ID:QISVOG-L04).</p>				

4 Description of the Equipment under Test (EUT)

4.1 General Description

VOG-L29 is a subscriber equipment in the GSM/WCDMA/LTE system. The GSM frequency band includes GSM850 and GSM900 and DCS1800 and PCS1900. The UMTS frequency band is B1 and B2 and B4 and B5 and B6 and B8 and B19. The LTE frequency band is B1 and B2 and B3 and B4 and B5 and B6 and B7 and B8 and B9 and B12 and B17 and B18 and B19 and B20 and B26 and B28 and B32 and B34 and B38 and B39 and B40 and B41. The Mobile Phone implements such functions as RF signal receiving/transmitting, LTE/HSPA/UMTS and GSM/GPRS/EDGE protocol processing, voice, video MMS service, GPS, Bluetooth, NFC, Wi-Fi and Wirelessly Charging etc. VOG-L29 is a dual SIM smart phone, and one of the SIM card interfaces could be used as Nano memory card interface. Externally it provides type C USB charging port, and the port could be used as the earphone port or data-transfer port.

VOG-L09 is a subscriber equipment in the GSM/WCDMA/LTE system. The GSM frequency band includes GSM850 and GSM900 and DCS1800 and PCS1900. The UMTS frequency band is B1 and B2 and B4 and B5 and B6 and B8 and B19. The LTE frequency band is B1 and B2 and B3 and B4 and B5 and B6 and B7 and B8 and B9 and B12 and B17 and B18 and B19 and B20 and B26 and B28 and B32 and B34 and B38 and B39 and B40 and B41. The Mobile Phone implements such functions as RF signal receiving/transmitting, LTE/HSPA/UMTS and GSM/GPRS/EDGE protocol processing, voice, video MMS service, GPS, Bluetooth, NFC, Wi-Fi and Wirelessly Charging etc. VOG-L09 provides one SIM card interface and one Nano memory card interface. Externally it provides type C USB charging port, and the port could be used as the earphone port or data-transfer port.

The difference between VOG-L29 and VOG-L09

The only difference between VOG-L29 and VOG-L09 is that VOG-L09 deletes into single SIM card by software. Other parts of the two models are the same.

The difference between VOG-L29 and VOG-L04 is show in the below table.

Model	VOG-L29	VOG-L04
PCB	The same	The same
Frequency-G SM	The same	The same
Frequency-W CDMA	The same	The same

Frequency-LTE	The same Support B32 Unsupport B66	Different Support B66 Unsupport B32
4*4 MIMO	The same Support B1、B3、B7	Different Support B2、B4、B7、B66
SIM Card	Dual	Single
Hardware	B32 RF circuit Support B32 Location ID: SAW filter:Z3401,Z4104, B32 Diplexer:Z3402,Z5403 RF low noise amplifier:U3405,U4103 Capacitor:C3422,C3423,C3425,C3442,C2912,C3411,L3533,L4416,C3418,C4102 Inductor:L3412,L3422,L3413,L3408,L4124,L4137,L4139,L4140 Function Description:B32 main RF circuit and diversity RF circuit	Unsupport B32 Delete components related to the B32 RF circuit.
	4*4 MIMO(the 3rd & 4th antenna) Support B1/3/7 4*4MIMO and delete/replace components related circuit; Location ID: B1/3/7 SAW filter of the 4th antenna :Z4403 (Vendor:KYOCERA type:SF18-1842M8SUA3) SAW filter of the 3rd antenna :Z4301 (Vendor:KYOCERA type:SF18-1842M8SUA3) Capacitor:L5507,C5401,C5402,C5517,C3411,L3533,L4416 Inductor:L5510,L4330,L5415,L3408,L4419 Function Description: B1/3/7 4*4MIMO RF circuit	Support B2/7/66(4) 4*4MIMO and delete/replace components related circuit; Location ID: B2/7/66(4) SAW filter: SAW filter of the 4th antenna :Z4403 (Vendor:MURATA type:SATEY1G96AU3F0AR00) SAW filter of the 3rd antenna :Z4301 (Vendor:MURATA type:SATEY1G96AU3F0AR00) Inductor:L4419,L4412,L4416,C5444,C5407,L5510 Function Description:B2/7/66(4) 4*4MIMO RF circuit

	B1/B3/ B32 & B2/B66 RF &CA circuit	<p>Unsupport B66 and delete/replace components related circuit;</p> <p>Support CA_1-3-32 Location ID: B1/B3 Quadruplexer:Z3502(Vendor:QORVO, type:QM25002TR13-5KHW) Capacitor:C3533 B2 SAW filter: Z4101(Vendor:MURATA ect. type:SAFFB1G96AB0F0AR1X ect.) L4123,L4122,L3523,L3532,C3520,L3512,L4419 Function Description:B2 RX and CA_1-3-32 diplexer RF circuit</p>	<p>Unsupport CA_1-3-32 and delete/replace components related circuit;</p> <p>Support B66 &Support CA_2-66 Location ID: B2/B7/B66(4) diversity TRI SAW filter:Z4105 (Vendor:MURATA type:SATEY1G96AU3F0AR00) B2/B66(B4) Quadruplexer:Z3502(Vendor:KYOCERA type:SQ25-1745K6SUA4) Capacitor:C3401,C3402,C3504,L4110 Inductor:L3532,L4111,L4112,L4107,L4109,L4114,L4108,L4118,C3520,L3533,L3512 Function Description:B2/B66 Single-band and CA main and diversity RF circuits</p>
	B7 RX circuit	<p>B7 receive matching circuit include: Inductor:L4127,L4126</p>	<p>B7 receiving matching circuit is adjusted to include: Inductor:C4101 B7 diversity TRI SAW filter:Z4105(Vendor:MURATA type:SATEY1G96AU3F0AR00)</p>
Software	Different	Different	
Dimensions	The same	The same	
Appearance	The same	The same	
main antenna	The same	The same	
DIV antenna	The same	The same	
BT/Wi-Fi antenna	The same	The same	
MIMO antenna	The same	The same	
NFC	The same	The same	
WPC	The same	The same	
Supported CA configurations for DL CA	Different	Different	
Supported CA configurations for UL CA	The same	The same	
Others	NA	NA	

Note1: Only Bluetooth test data included in this report.

Note2: We do not test Bluetooth of VOG-L29/VOG-L09, all test data can refer to No.

SYBH(Z-RF)20181218028001-2003 of VOG-L04(FCC ID:QISVOG-L04).















4.2 EUT Identity

NOTE: Unless otherwise noted in the report, the functional boards installed in the units shall be selected from the below list, but not means all the functional boards listed below shall be installed in one unit.

4.2.1 Board

Board		
Description	Software Version	Hardware Version
Main Board	9.1.0.84(C432E84R1P1)	HL2VOGUEM

4.2.2 Sub- Assembly

Sub-Assembly			
Sub-Assembly Name	Model	Manufacturer	Description
Adapter	HW-100400A00	Huawei Technologies Co., Ltd.	Input voltage: 100-240V ~50/60Hz 1.2A Output voltage: 5V  2A OR 9V  2A OR 10V  4A
Adapter	HW-100400U00	Huawei Technologies Co., Ltd.	Input voltage: 100-240V ~50/60Hz 1.2A Output voltage: 5V  2A OR 9V  2A OR 10V  4A
Adapter	HW-100400E00	Huawei Technologies Co., Ltd.	Input voltage: 100-240V ~50/60Hz 1.2A Output voltage: 5V  2A OR 9V  2A OR 10V  4A
Adapter	HW-100400B00	Huawei Technologies Co., Ltd.	Input voltage: 100-240V ~50/60Hz 1.2A Output voltage: 5V  2A OR 9V  2A OR 10V  4A
Battery	HB486486ECW	Huawei Technologies Co., Ltd.	Rated capacity: 4100mAh Nominal Voltage:  +3.82V Charging Voltage:  +4.4V

4.3 Technical Description

Characteristics	Description	
TX/RX Operating Range	2400-2483.5 MHz band	$f_c = 2402 \text{ MHz} + N * 1 \text{ MHz}$, where: - f_c = "Operating Frequency" in MHz, - N = "Channel Number" with the range from 0 to 78.
Modulation Type	Carrier	Frequency Hopping Spread Spectrum (FHSS)
	Digital	GFSK, $\pi/4$ -DQPSK, 8DPSK
Emission Designator for BT Normal power	GFSK: 950KFXD $\pi/4$ -DQPSK: 1M32GXD 8DPSK: 1M32GXD	
Emission Designator for BT High power	GFSK: 950KFXD $\pi/4$ -DQPSK: 1M31GXD 8DPSK: 1M31GXD	
Bluetooth Power Class	Class 1	
Antenna	Description	Isotropic Antenna
	Type	<input checked="" type="checkbox"/> Integral <input type="checkbox"/> External <input type="checkbox"/> Dedicated
	Ports	<input checked="" type="checkbox"/> Ant 1, <input type="checkbox"/> Ant 2, <input type="checkbox"/> Ant 3
	Gain	-1.4 dBi (per antenna port, max.)
	Remark	When the EUT is put into service, the practical maximum antenna gain should NOT exceed the value as described above.
Power Supply	Type	<input type="checkbox"/> External DC mains, <input checked="" type="checkbox"/> Battery, <input type="checkbox"/> AC/DC Adapter, <input type="checkbox"/> Powered over Ethernet (PoE). <input type="checkbox"/> Other

5 General Test Conditions / Configurations

5.1 EUT Configurations

5.1.1 General Configurations

Configuration	Description
Test Antenna Ports	Until otherwise specified, <ul style="list-style-type: none"> - All TX tests are performed at all TX antenna ports of the EUT, and - All RX tests are performed at all RX antenna ports of the EUT.
Multiple RF Sources	Other than the tested RF source of the EUT, other RF source(s) are disabled or shutdown during measurements.

5.1.2 Customized Configurations

# EUT Conf.	Signal Description	Operating Frequency
TM1_DH5_Hop	GFSK modulation, package type DH5, hopping on.	---
TM1_DH5_Ch0	GFSK modulation, package type DH5, hopping off.	Ch No. 0 / 2402 MHz
TM1_DH5_Ch39	GFSK modulation, package type DH5, hopping off.	Ch No. 39 / 2441 MHz
TM1_DH5_Ch78	GFSK modulation, package type DH5, hopping off.	Ch No. 78 / 2480 MHz
TM2_2DH5_Hop	$\pi/4$ -DQPSK modulation, package type 2DH5, hopping on.	---
TM2_2DH5_Ch0	$\pi/4$ -DQPSK modulation, package type 2DH5, hopping off.	Ch No. 0 / 2402 MHz
TM2_2DH5_Ch39	$\pi/4$ -DQPSK modulation, package type 2DH5, hopping off.	Ch No. 39 / 2441 MHz
TM2_2DH5_Ch78	$\pi/4$ -DQPSK modulation, package type 2DH5, hopping off.	Ch No. 78 / 2480 MHz
TM3_3DH5_Hop	8DPSK modulation, package type 3DH5, hopping on.	---
TM3_3DH5_Ch0	8DPSK modulation, package type 3DH5, hopping off.	Ch No. 0 / 2402 MHz
TM3_3DH5_Ch39	8DPSK modulation, package type 3DH5, hopping off.	Ch No. 39 / 2441 MHz
TM3_3DH5_Ch78	8DPSK modulation, package type 3DH5, hopping off.	Ch No. 78 / 2480 MHz

5.2 Antenna requirements

Excerpt from §15.203 of the FCC Rules/Regulations:

“An intentional radiator antenna shall be designed to ensure that no antenna other than that furnished by the responsible party can be used with the device. The use of a permanently attached antenna or of an antenna that uses a unique coupling to the intentional radiator shall be considered sufficient to comply with the provisions of this section.”

The antennas of the **VOG-L29/VOG-L09** are **permanently attached**.

There are no provisions for connection to an external antenna.

Conclusion:

The **Smart Phone FCC ID: QISVOG-LX9** unit complies with the requirement of §15.203.

Ch. Frequency (MHz)

Ch.	Frequency (MHz)
00	2402
.	.
.	.
39	2441
.	.
.	.
78	2480

Frequency/ Channel Operations

5.3 Description of tests

5.3.1 Bandwidth measurement

- (a) Connect EUT test port to universal communication tester.
- (b) Set the EUT to transmit maximum output power at 2.4GHz and switch off frequency hopping function, then set the measuring frequency number, finally test the bandwidth with universal communication tester.

5.3.2 Carrier frequency separation measurement

- (a) Connect EUT test port to spectrum analyzer and universal communication tester.
- (b) Set the EUT to transmit maximum output power at 2.4GHz and switch off frequency hopping function, then set the measured frequency number to two adjacent channels separately and test the carrier frequency separation with spectrum analyzer.

5.3.3 Number of hopping channel

- (a) Connect EUT test port to spectrum analyzer and universal communication tester.
- (b) Set the EUT to transmit maximum output power at 2.4GHz and switch on frequency hopping function, then set enough count time (larger than 5000 times) to get all the hopping frequency channel displayed on the screen of spectrum analyzer.
- (c) Count the quantity of peaks to get the number of hopping channels.

5.3.4 Time of occupancy

- (a) Connect test port of EUT to spectrum analyzer and universal communication tester.
- (b) Set the EUT to transmit maximum output power at 2.4GHz and switch on frequency hopping function.
- (c) Set the span of spectrum analyzer to 0 Hz, and set the resolution bandwidth to 1 MHz and the video bandwidth to 1 MHz, then get the time domain measured diagram. and set sweep time to 2 times of one burst occupancy time, and measure the time of occupancy of one burst.
- (d) Set the resolution bandwidth to 1 MHz and the video bandwidth to 3 MHz, and set the sweep time to a period (0.4 seconds multiplied by the number of hopping channels employed), and count the number of the bursts.
- (e) Calculate the time of occupancy in a period with time occupancy of a burst and quantity of bursts

5.3.5 Peak output power

- (a) Connect EUT test port to spectrum analyzer and universal communication tester.
- (b) Set the EUT to transmit maximum output power at 2.4GHz and switch off frequency hopping function.
- (c) Then set the EUT to transmit at high, middle and low frequency and measure the conducted output power separately.

5.3.6 Band edge spurious emission

- (a) Connect EUT test port to spectrum analyzer and universal communication tester
- (b) Set the EUT to transmit maximum output power at 2.4GHz and switch off frequency hopping function.
- (c) Then set the EUT to transmit at high, low frequency and measure the conducted band edge spurious separately.
- (d) Switch on the frequency hopping function, and repeat above measurement.

5.3.7 Conducted RF Spurious

- (a) Connect EUT test port to spectrum analyzer and universal communication tester
- (b) Set the EUT to transmit maximum output power at 2.4GHz and switch off frequency hopping function.
- (c) Then set the EUT to transmit at high, middle and low frequency and measure the conducted spurious separately.
- (d) Switch on the frequency hopping function, and repeat the above measurement.

5.3.8 Radiated spurious emission & spurious in restricted band

For frequency below 1GHz, the test site semi-anechoic chamber has met the requirement of NSA tolerance 4dB according to the standards: ANSI C63.10 (2013). The EUT was set-up on insulator 80cm above the Ground Plane. For frequency above 1GHz, the test site full-anechoic chamber has met the requirement of ANSI C63.10 (2013). The EUT was set-up on insulator 150cm above the Ground Plane.

The set-up and test methods were according to ANSI C63.10:2013. The Radiated Disturbance measurements were made using a Rohde and Schwarz Test Receiver and control software.

A preliminary scan and a final scan of the emissions were made by using test script of software; the emissions were measured using a Quasi-Peak Detector below 1GHz, Peak Detector and AV detector above 1GHz. The maximal emission value was acquired by adjusting the antenna height, polarisation and turntable azimuth in accordance with the software setup. Normally, the height range of antenna was 1m to 4m, and the azimuth range of turntable was 0° to 360°. The receive antenna has two polarizations V and H.

A portable or small unlicensed wireless device shall be placed on a non-metallic test fixture or other nonmetallic support during testing. The supporting fixture shall permit orientation of the EUT in each of three orthogonal (x, y, z) axis positions such that emissions from the EUT are maximized.

The EUT communicates with the BTS simulator through Air interface. The EUT transmits maximum output power at 2.4GHz and switch off frequency hopping function.

Measurement bandwidth: 30 MHz - 1000 MHz: 120 kHz

Measurement bandwidth: 1000 MHz - 10th Carrier Frequency: 1 MHz

5.3.9 Conducted Emission at Power Port

The Table-top EUT was placed upon a non-metallic table 0.8 m above the horizontal metal reference ground plane. EUT was connected to LISN and LISN was connected to reference Ground Plane. EUT was 80cm from LISN. The set-up and test methods were according to ANSI C63.10: 2013.

Conducted Disturbance at AC Port measurements were undertaken on the L and N Lines. The emissions were measured using a Quasi-Peak Detector and Average Detector.

The EUT communicates with the BTS simulator through Air interface, the BTS simulator controls the EUT to transmitter the maximum power which defined in specification of product. The EUT operated on the typical channel.

Measurement bandwidth (RBW) for 150kHz to 30 MHz: 9 kHz;

5.4 Test Setups

5.4.1 Test Setup 1

The Bluetooth component's antenna ports(s) of the EUT are connected to the measurement instrument per an appropriate attenuator. The EUT is controlled by Bluetooth System Simulator and/or PC/software to emit the specified signals for the purpose of measurements.

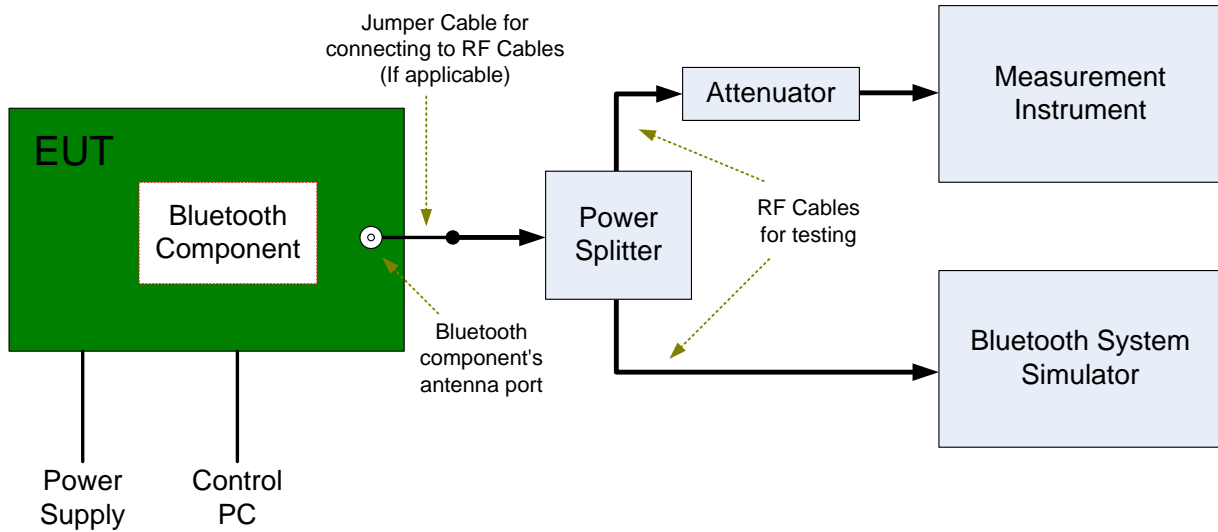

5.4.2 Test Setup 2

The semi-anechoic chamber and full-anechoic chamber has met the requirement of ANSI C63.4. The test distance is 3m. The setup is according to ANSI C63.4 and CAN/CSA-CEI/IEC CISPR 22.

The maximal emission value is acquired by adjusting the antenna height, polarisation and turntable azimuth. Normally, the height range of antenna is 1 m to 4 m, the azimuth range of turntable is 0° to 360°, and the receive antenna has two polarizations Vertical (V) and Horizontal (H).

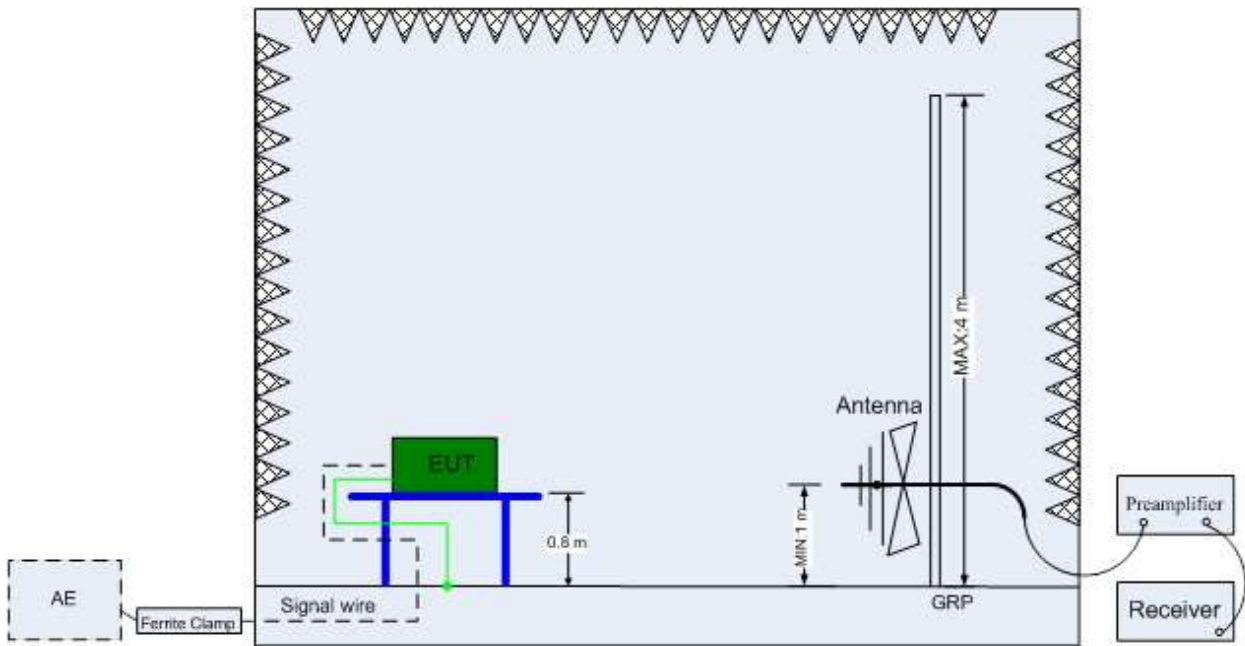

(Below 1 GHz)

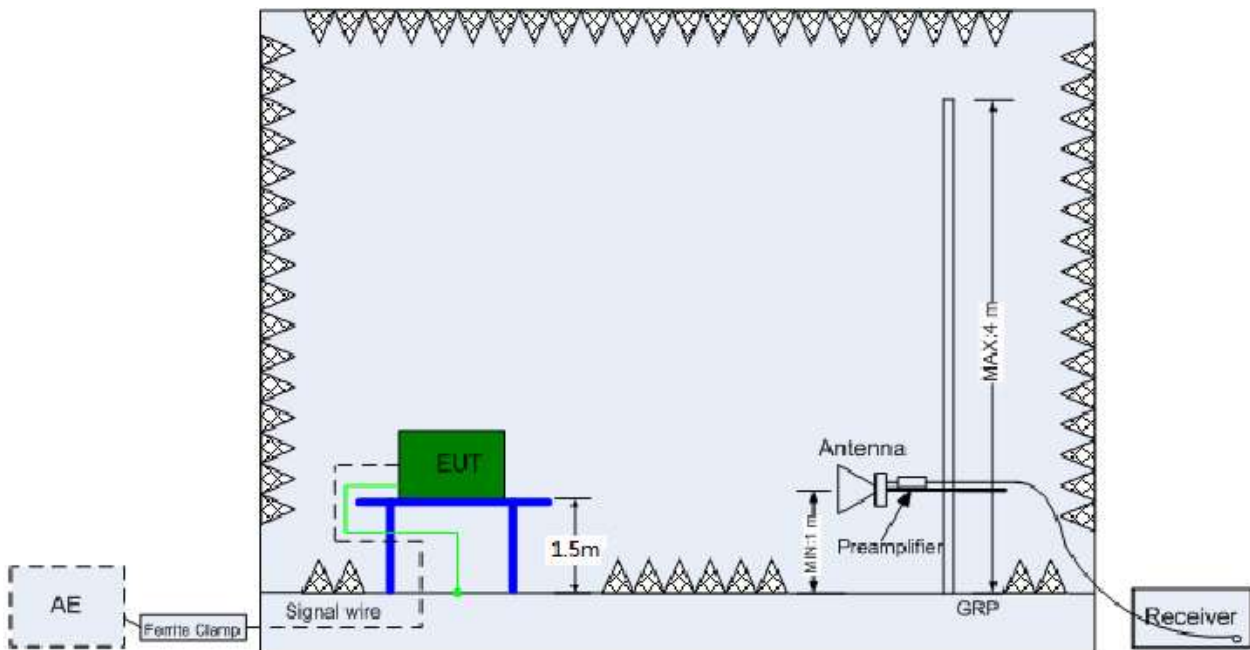

(Above 1 GHz)

5.4.3 Test Setup 3

The mains cable of the EUT (maybe per AC/DC Adapter) must be connected to LISN. The LISN shall be placed 0.8 m from the boundary of EUT and bonded to a ground reference plane for LISN mounted on top of the ground reference plane. This distance is between the closest points of the LISN and the EUT. All other units of the EUT and associated equipment shall be at least 0.8m from the LISN.

Ground connections, where required for safety purposes, shall be connected to the reference ground point of the LISN and, where not otherwise provided or specified by the manufacturer, shall be of same length as the mains cable and run parallel to the mains connection at a separation distance of not more than 0.1 m.

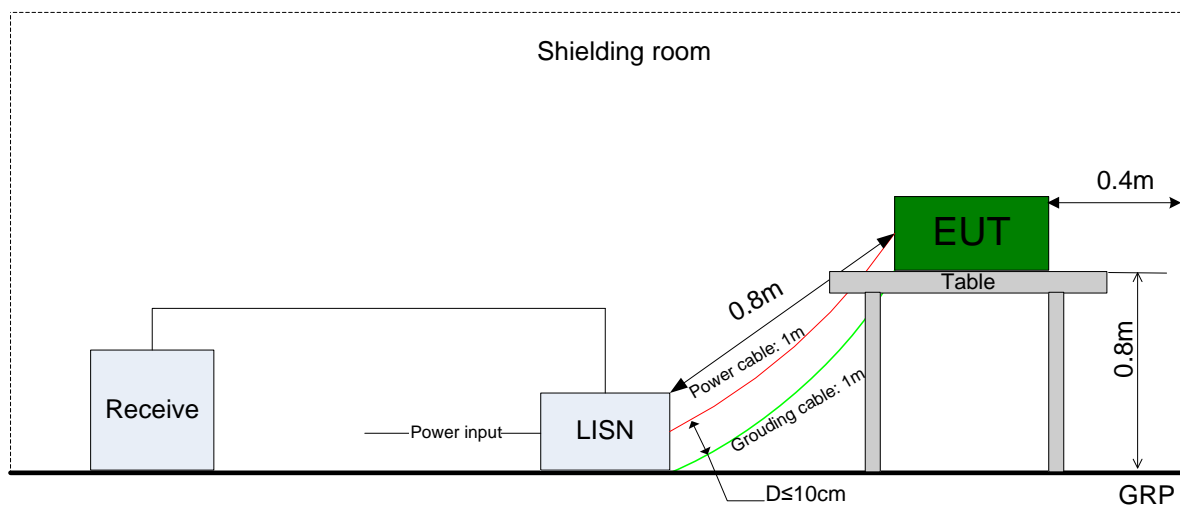

5.5 Test Conditions

Test Case	Test Conditions	
	Configuration	Description
20dB Emission Bandwidth (EBW)	Meas. Method	DA 00-705
	Test Env.	TN/VN
	Test Setup	Test Setup 1
	EUT Conf.	TM1_DH5_Ch0, TM1_DH5_Ch39, TM1_DH5_Ch78, TM2_2DH5_Ch0, TM2_2DH5_Ch39, TM2_2DH5_Ch78, TM3_3DH5_Ch0, TM3_3DH5_Ch39, TM3_3DH5_Ch78.
Carrier Frequency Separation	Meas. Method	DA 00-705
	Test Env.	TN/VN
	Test Setup	Test Setup 1
	EUT Conf.	TM1_DH5_Hop, TM2_2DH5_Hop, TM3_3DH5_Hop.
Number of Hopping Channel	Meas. Method	DA 00-705
	Test Env.	TN/VN
	Test Setup	Test Setup 1
	EUT Conf.	TM1_DH5_Hop, TM2_2DH5_Hop, TM3_3DH5_Hop.
Time of Occupancy (Dwell Time)	Meas. Method	DA 00-705
	Test Env.	TN/VN
	Test Setup	Test Setup 1
	EUT Conf.	TM1_DH5_Ch39, TM2_2DH5_Ch39, TM3_3DH5_Ch39.
Maximum Peak Conducted Output Power	Meas. Method	DA 00-705
	Test Env.	TN/VN
	Test Setup	Test Setup 1
	EUT Conf.	TM1_DH5_Ch0, TM1_DH5_Ch39, TM1_DH5_Ch78, TM2_2DH5_Ch0, TM2_2DH5_Ch39, TM2_2DH5_Ch78, TM3_3DH5_Ch0, TM3_3DH5_Ch39, TM3_3DH5_Ch78.
Band edge spurious emission	Meas. Method	DA 00-705
	Test Env.	TN/VN
	Test Setup	Test Setup 1
	EUT Conf.	TM1_DH5_Ch0, TM1_DH5_Ch78, TM2_2DH5_Ch0, TM2_2DH5_Ch78, TM3_3DH5_Ch0, TM3_3DH5_Ch78.
Conducted RF Spurious Emission	Meas. Method	DA 00-705
	Test Env.	TN/VN

Test Case	Test Conditions		
	Configuration	Description	
	Test Setup	Test Setup 1	
	EUT Conf.	TM1_DH5_Ch0, TM1_DH5_Ch39, TM1_DH5_Ch78, TM2_2DH5_Ch0, TM2_2DH5_Ch39, TM2_2DH5_Ch78, TM3_3DH5_Ch0, TM3_3DH5_Ch39, TM3_3DH5_Ch78.	
	Meas. Method	DA 00-705, C63.4, C63.10. (1) 30 MHz to 1 GHz: Pre: RBW = 100 kHz; VBW = 300 kHz; Det. = Peak. Final: RBW = 120 kHz; Det. = CISPR Quasi-Peak. (2) 1 GHz to 26.5 GHz: Average: RBW = 1 MHz; VBW = 10 Hz; Det. = Peak; Sweep-time = Auto; Trace = Single. Peak: RBW = 1 MHz; VBW = 3 MHz; Det. = Peak; Sweep-time = Auto; Trace ≥ Max Hold * 100.	
	Test Env.	TN/VN	
Radiated Emissions in the Restricted Bands	Test Setup	Test Setup 2	
	EUT Conf.	30 MHz -1 GHz	TM1_DH5_Ch0 (Worst Conf.).
		1-3 GHz	TM1_DH5_Ch0, TM1_DH5_Ch39, TM1_DH5_Ch78, TM2_2DH5_Ch0, TM2_2DH5_Ch39, TM2_2DH5_Ch78, TM3_3DH5_Ch0, TM3_3DH5_Ch39, TM3_3DH5_Ch78.
		3-18 GHz	TM1_DH5_Ch0 (Worse Conf.), TM1_DH5_Ch39 (Worse Conf.), TM1_DH5_Ch78 (Worse Conf.).
		18-26.5 GHz	TM1_DH5_Ch0 (Worst Conf.).
AC Power Line Conducted Emissions	Meas. Method	AC mains conducted. Pre: RBW = 10 kHz; Det. = Peak. Final: RBW = 9 kHz; Det. = CISPR Quasi-Peak & Average.	
	Test Env.	TN/VN	
	Test Setup	Test Setup 3	
	EUT Conf.	TM1_DH5_Ch78.	

6 Main Test Instruments

This table gives a complete overview of the RF measurement equipment.

Devices used during the test described are marked

<input checked="" type="checkbox"/> Main Test Equipment (BT/WIFI test system)						
Marked	Equipment Name	Manufacturer	Model	Serial Number	Cal Date	Cal-Due
<input type="checkbox"/>	JS1120-3 BT/WIFI test system	JS Tonscend	JS0806-2	/	2018/05/30	2019/05/30
<input type="checkbox"/>	Power Detecting & Samplig Unit	R&S	OSP-B157	101429	2018/07/23	2019/07/23
<input type="checkbox"/>	Power Sensor	R&S	NRP2	103085/106211	2018/05/17	2018/05/17
<input checked="" type="checkbox"/>	DC Power Supply	KEITHLEY	2303	1342889	2018/10/24	2019/10/24
<input type="checkbox"/>	DC Power Supply	KEITHLEY	2303	000500E	2018/05/21	2019/05/21
<input type="checkbox"/>	DC Power Supply	KEITHLEY	2303	1288003	2018/12/21	2019/12/21
<input type="checkbox"/>	DC Power Supply	KEITHLEY	2303	000381E	2018/05/21	2019/05/21
<input type="checkbox"/>	DC Power Supply	KEITHLEY	2303	000510E	2018/05/21	2019/05/21
<input type="checkbox"/>	DC Power Supply	KEITHLEY	2303	1342896	2018/10/24	2019/10/24
<input type="checkbox"/>	Temperature Chamber	WEISS	WKL64	56246002940010	2018/12/13	2019/12/13
<input checked="" type="checkbox"/>	Spectrum Analyzer	Agilent	N9030A	MY51380032	2018/07/23	2019/07/23
<input type="checkbox"/>	Spectrum Analyzer	Agilent	N9030A	MY49431698	2018/07/23	2019/07/23
<input type="checkbox"/>	Spectrum Analyzer	Keysight	N9040B	MY57212529	2018/06/28	2019/06/28
<input type="checkbox"/>	Signal Analyzer	R&S	FSQ31	200021	2018/07/23	2019/07/23
<input type="checkbox"/>	Signal Analyzer	R&S	FSU26	201069	2018/11/2	2019/11/2
<input checked="" type="checkbox"/>	Universal Radio Communication Tester	R&S	CMW500	164699	2018/03/15	2019/03/15
<input type="checkbox"/>	Universal Radio Communication Tester	R&S	CMW500	159302	2018/07/23	2019/07/23
<input checked="" type="checkbox"/>	Wireless Communication Test set	Agilent	N4010A	MY49081592	2018/07/23	2019/07/23
<input checked="" type="checkbox"/>	Signal generator	Agilent	E8257D	MY51500314	2018/04/27	2019/04/27
<input type="checkbox"/>	Signal generator	Agilent	E8257D	MY49281095	2018/07/23	2019/07/23
<input checked="" type="checkbox"/>	Vector Signal Generator	R&S	SMW200A	103447	2018/05/31	2019/05/31
<input type="checkbox"/>	Vector Signal Generator	R&S	SMU200A	104162	2018/07/23	2019/07/23

<input checked="" type="checkbox"/> Main Test Equipment(RE test system)						
Marked	Equipment Name	Manufacturer	Model	Serial Number	Cal Date	Cal-Due
<input checked="" type="checkbox"/>	Test receiver	R&S	ESU26	100387	2019/01/15	2020/01/14
<input checked="" type="checkbox"/>	LOOP Antennas(9kHz-30M Hz)	R&S	HFH2-Z2	100262	2017/04/25	2019/04/25

<input type="checkbox"/>	LOOP Antennas(9kHz-30MHz)	R&S	HFH2-Z2	100263	2017/04/25	2019/04/25
<input checked="" type="checkbox"/>	Trilog Broadband Antenna (30M~3GHz)	SCHWARZECK	VULB 9163	9163-357	2017/04/21	2019/04/20
<input type="checkbox"/>	Trilog Broadband Antenna (30M~3GHz)	SCHWARZECK	VULB 9163	9163-520	2017/3/29	2019/3/28
<input type="checkbox"/>	Trilog Broadband Antenna (30M~3GHz)	SCHWARZECK	VULB 9163	9163-491	2017/3/29	2019/3/28
<input type="checkbox"/>	Trilog Broadband Antenna (30M~3GHz)	SCHWARZECK	VULB 9163	9163-356	2018/4/9	2020/4/8
<input checked="" type="checkbox"/>	Double-Ridged Waveguide Horn Antenna (1G~18GHz)	R&S	HF907	100305	2017/4/21	2019/4/20
<input type="checkbox"/>	Double-Ridged Waveguide Horn Antenna (1G~18GHz)	R&S	HF906	100684	2017/5/27	2019/5/26
<input type="checkbox"/>	Double-Ridged Waveguide Horn Antenna (1G~18GHz)	R&S	HF906	100683	2017/3/29	2019/3/28
<input checked="" type="checkbox"/>	Pyramidal Horn Antenna(18GHz-26.5GHz)	ETS-Lindgren	3160-09	5140299	2017/07/20	2019/07/19
<input type="checkbox"/>	Pyramidal Horn Antenna(18GHz-26.5GHz)	ETS-Lindgren	3160-09	00206665	2018/4/21	2020/4/20
<input checked="" type="checkbox"/>	Pyramidal Horn Antenna(26.5GHz-40GHz)	ETS-Lindgren	3160-10	00205695	2018/04/20	2020/04/19
<input type="checkbox"/>	Pyramidal Horn Antenna(26.5GHz-40GHz)	ETS-Lindgren	3160-10	LM5947	2017/07/20	2019/07/19
<input checked="" type="checkbox"/>	Measurement Software	R&S	EMC32 V9.25.0	/	/	/

<input checked="" type="checkbox"/> Main Test Equipment (CE test system)						
Marked	Equipment Name	Manufacturer	Model	Serial Number	Cal Date	Cal-Due
<input type="checkbox"/>	Test receiver	R&S	ESU26	100387	2019/01/15	2020/01/14
<input checked="" type="checkbox"/>	Test receiver	R&S	ESCI	101163	2019/01/15	2020/01/14

<input type="checkbox"/>	Artificial Main Network	R&S	ENV4200	100134	2018/05/08	2019/05/07
<input checked="" type="checkbox"/>	Line Impedance Stabilization Network	R&S	ENV216	100382	2018/05/08	2019/05/07
<input checked="" type="checkbox"/>	Measurement Software	R&S	EMC32 V9.25.0	/	/	/

7 Measurement Uncertainty

For a 95% confidence level (k = 2), the measurement expanded uncertainties for defined systems, in accordance with the recommendations of ISO 17025 as following:

Test Item		Extended Uncertainty
Transmit Output Power Data	Power [dBm]	U = 0.39 dB
Bandwidth	Magnitude [%]	U=7%
Band Edge Compliance	Disturbance Power [dBm]	U = 0.9 dB
Spurious Emissions, Conducted	Disturbance Power [dBm]	20MHz~3.6GHz: U=0.88dB 3.6GHz~8.4GHz: U=1.08dB 8.4GHz~13.6GHz: U=1.24dB 13.6GHz~22GHz: U=1.34dB 22GHz~26.5GHz: U=1.36dB
Field Strength of Spurious Radiation	ERP/EIRP [dBm]	For 3 m Chamber: U = 5.90 dB (30 MHz-1 GHz) U = 4.94 dB (1 GHz-18 GHz) U = 4.24 dB (18 GHz-26.5 GHz)
Frequency Stability	Frequency Accuracy [Hz]	U=41.58Hz
AC Power Line Conducted Emissions	Disturbance Voltage[dBμV]	U=2.3 dB
Duty Cycle	Duty Cycle [%]	U=±2.06 %

END