



# FCC&ISED RF Test Report

**Product Name: Smart Phone**

**Model Number: VOG-L04**

**Report No.: SYBH(Z-RF)20181218028001-2002**

**FCC ID: QISVOG-L04**

**IC: 6369A-VOGL04**

Authorized	APPROVED (Lab Manager)	PREPARED (Test Engineer)
BY	He Hao	Zhang Shuangxia
DATE	2019-01-28	2019-01-28

**Reliability Laboratory of Huawei Technologies Co., Ltd.**

**(Global Compliance and Testing Center of Huawei Technologies Co., Ltd)**

No.2, New City Avenue, Songshan Lake Sci. & Tech. Industry Park, Dongguan, 523808, P.R.C

Telephone: +86 769 23830808

Fax: +86 769 23837628

※ ※ **Notice** ※ ※

1. The laboratory has passed the accreditation by The American Association for Laboratory Accreditation (A2LA). The accreditation number is 2174.01.
2. The laboratory has been recognized by the US Federal Communications Commission (FCC) to perform compliance testing subject to the Commission's Certification rules. The Designation Number is CN1173, and the Test Firm Registration Number is 294140.
3. The laboratory has been recognized by the Innovation, Science and Economic Development Canada (ISED) to test to Canadian radio equipment requirements. The CAB identifier is CN0003, and the ISED# is 21741.
4. The laboratory (Reliability Lab of Huawei Technologies Co., Ltd) is also named “Global Compliance and Testing Center of Huawei Technologies Co., Ltd”, the both names have coexisted since 2009.
5. The test report is invalid if not marked with the signatures of the persons responsible for preparing and approving the test report.
6. The test report is invalid if there is any evidence of erasure and/or falsification.
7. The test report is only valid for the test samples.
8. Content of the test report, in part or in full, cannot be used for publicity and/or promotional purposes without prior written approval from the laboratory.
9. If any question about this report, please contact the laboratory ([PublicGCTC@huawei.com](mailto:PublicGCTC@huawei.com)).

**MODIFICATION RECORD**

No.	Report No	Modification Description
1	SYBH(Z-RF)2018121 8028001-2002	First release.

**DECLARATION**

Type	Description
Multiple Models Applications	<input checked="" type="checkbox"/> The present report applies to single model.
	<input type="checkbox"/> The present report applies to several models. The practical measurements are performed with the model.
	The present report only presents the worst test case of all modes, see relevant test results for detailed.

## 1 Table of contents

1	Table of contents .....	4
2	General Information .....	5
2.1	Test standard/s .....	5
2.2	Test Environment .....	5
2.3	Test Laboratories .....	5
2.4	Applicant and Manufacturer .....	6
2.5	Application details .....	6
3	Test Summary .....	6
4	Description of the Equipment under Test (EUT) .....	8
4.1	General Description .....	8
4.2	EUT Identity .....	8
4.3	Technical Description .....	10
5	General Test Conditions / Configurations .....	12
5.1	Test Modes .....	12
5.2	EUT Configurations .....	12
5.3	Antenna requirements .....	14
5.4	Description of tests .....	15
5.5	Test Setups .....	17
5.6	Test Conditions .....	20
5.7	Main Instruments .....	24
6	Measurement Uncertainty .....	26
7	Appendixes .....	27

## 2 General Information

### 2.1 Test standard/s

Applied Rules :	47 CFR FCC Part 2, Subpart J 47 CFR FCC Part 15, Subpart C ISED RSS-Gen Issue 5 ISED RSS-247 Issue2
Test Method :	FCC KDB 558074 D01 DTS Meas Guidance v05 FCC KDB 662911 D01 Multiple Transmitter Output v02r01 ANSI C63.10-2013, American National Standard for Testing Unlicensed Wireless Devices.

### 2.2 Test Environment

Temperature :	TN	15 to 30	°C during room temperature tests
Ambient Relative Humidity:	20 to 85 %		
Atmospheric Pressure:	Not applicable		
Power supply :	VL	3.6	V
	VN	3.82	V DC by Battery
	VH	4.35	V

NOTE 1: 1) VN= nominal voltage, VL= low extreme test voltage, VH= High extreme test voltage;

TN= normal temperature, TL= low extreme test temperature, TH= High extreme test temperature.

NOTE 2: The values used in the test report may be stringent than the declared.

### 2.3 Test Laboratories

Test Location 1 :	RELIABILITY LABORATORY OF HUAWEI TECHNOLOGIES CO., LTD.
Address of Test Location 1 :	No.2, New City Avenue, Songshan Lake Sci. & Tech. Industry Park, Dongguan, 523808, P.R.C

## 2.4 Applicant and Manufacturer

Company Name :	HUAWEI TECHNOLOGIES CO., LTD
Address :	Administration Building, Headquarters of Huawei Technologies Co., Ltd., Bantian, Longgang District, Shenzhen, 518129, P.R.C

## 2.5 Application details

Date of Receipt Sample:	2019-01-02
Start of test:	2019-01-03
End of test:	2019-01-28

## 3 Test Summary

Test Item	FCC Rule No.	ISED Rule No.	Requirements	Test Result	Verdict
DTS (6 dB) Bandwidth	15.247(a)(2)	RSS-247, 5.2	≥ 500 kHz.	Appendix A	Pass
Occupied Bandwidth	---	RSS-247, 5.2 RSS-Gen, 6.7	No limit	Appendix B	Pass
Duty Cycle	KDB 558074 D01 (6.0)	--	No limit	Appendix C	Pass
Maximum Average Output Power	15.247(b)(3)	RSS-247, 5.4	FCC: For directional gain: Conducted < 30 dBm – (G[dBi] – 6 [dB]); Otherwise: Conducted < 30 dBm, ISED: Conducted < 30 dBm. EIRP < 36 dBm,	Appendix D	Pass
Maximum Power Spectral Density Level	15.247(e)	RSS-247, 5.2	Conducted < 8 dBm/3 kHz.	Appendix E	Pass
Band Edges Compliance	15.247(d)	RSS-247, 5.5	< -30 dB/100 kHz if total average power ≤ power limit.	Appendix F	Pass
Unwanted Emissions into Non-Restricted				Appendix G	Pass

Test Item	FCC Rule No.	ISED Rule No.	Requirements	Test Result	Verdict
Frequency Bands					
Unwanted Emissions into Restricted Frequency Bands (Radiated)	15.247(d) 15.209 (NOTE 1)	RSS-247, 5.5 RSS-Gen, §6.13 RSS-Gen, 8.10	FCC Part 15.209 field strength limit; RSS-Gen 8.10 field strength limit.	Appendix H	Pass
AC Power Line Conducted Emissions	15.207	RSS-Gen, 8.8	FCC Part 15.207 conducted limit; RSS-Gen, 8.8 conducted limit.	Appendix I	Pass
<p>Note1: According to KDB 558074 D01, antenna-port conducted measurements are acceptable as an alternative to radiated measurements for demonstrating compliance to the limits in the restricted frequency bands. If conducted measurements are performed, then proper impedance matching must be ensured and an additional radiated test for cabinet/case emissions will also be required.</p> <p>Note2: The transmitter has an integral PCB loop antenna that is enclosed within the housing of the EUT and meets the requirements of FCC 15.203</p>					

## 4 Description of the Equipment under Test (EUT)

### 4.1 General Description

VOG-L04 is a subscriber equipment in the GSM/WCDMA/LTE system. The GSM frequency band includes GSM850 and GSM900 and DCS1800 and PCS1900. The UMTS frequency band is B1 and B2 and B4 and B5 and B6 and B8 and B19. The LTE frequency band is B1 and B2 and B3 and B4 and B5 and B6 and B7 and B8 and B9 and B12 and B17 and B18 and B19 and B20 and B26 and B28 and B34 and B38 and B39 and B40 and B41 and B66. The Mobile Phone implements such functions as RF signal receiving/transmitting, LTE/HSPA/UMTS and GSM/GPRS/EDGE protocol processing, voice, video MMS service, GPS, Bluetooth, NFC, Wi-Fi and Wirelessly Charging etc. VOG-L04 provides one USIM card interface and one HUAWEI Nano memory card interface. Externally it provides type C USB charging port, and the port could be used as the earphone port or data-transfer port.

Note: Only 2.4G WIFI test data included in this report.







### 4.2 EUT Identity

NOTE: Unless otherwise noted in the report, the functional boards installed in the units shall be selected from the below list, but not means all the functional boards listed below shall be installed in one unit.









#### 4.2.1 Board

Board		
Description	Software Version	Hardware Version
Main Board	9.1.0.42(C792E10R1P4)	HL2VOGUEM

#### 4.2.2 Sub- Assembly

Sub-Assembly			
Sub-Assembly Name	Model	Manufacturer	Description
Adapter	HW-100400A00	Huawei Technologies Co., Ltd.	Input voltage: 100-240V ~50/60Hz 1.2A Output voltage: 5V  2A OR 9V  2A OR 10V  4A
Adapter	HW-100400U00	Huawei Technologies Co., Ltd.	Input voltage: 100-240V ~50/60Hz 1.2A Output voltage: 5V  2A OR 9V  2A OR 10V  4A



Sub-Assembly			
Sub-Assembly Name	Model	Manufacturer	Description
Adapter	HW-100400E00	Huawei Technologies Co., Ltd.	Input voltage: 100-240V ~50/60Hz 1.2A Output voltage: 5V  2A OR 9V  2A OR 10V  4A
Adapter	HW-100400B00	Huawei Technologies Co., Ltd.	Input voltage: 100-240V ~50/60Hz 1.2A Output voltage: 5V  2A OR 9V  2A OR 10V  4A
Battery	HB486486ECW	Huawei Technologies Co., Ltd.	Rated capacity: 4100mAh Nominal Voltage:  +3.82V Charging Voltage:  +4.4V

### 4.3 Technical Description

NOTE: For the detailed technical descriptions, see the applicant/manufacturer's specifications or user manual.

Characteristics	Description	
IEEE 802.11 WLAN Mode Supported	<input checked="" type="checkbox"/> 802.11b (20 MHz channel bandwidth), <input checked="" type="checkbox"/> 802.11g (20 MHz channel bandwidth) <input checked="" type="checkbox"/> 802.11n (20 MHz channel bandwidth), <input checked="" type="checkbox"/> 802.11n (40 MHz channel bandwidth)	
TX/RX Operating Range	2412-2462 MHz band	$fc = 2407 \text{ MHz} + N * 5 \text{ MHz}$ , where: - $fc$ = "Operating Frequency" in MHz, - $N$ = "Channel Number" with the range from 1 to 11 for the 20 MHz channel bandwidth, or 3 to 9 for the 40 MHz channel bandwidth.
Data Rate	802.11b	1 Mbps, 2 Mbps, 5.5 Mbps, 11 Mbps
	802.11g	6 Mbps, 9 Mbps, 12 Mbps, 18 Mbps, 24 Mbps, 36 Mbps, 48 Mbps, 54 Mbps
	802.11g CDD	6 Mbps, 9 Mbps, 12 Mbps, 18 Mbps, 24 Mbps, 36 Mbps, 48 Mbps, 54 Mbps
	802.11n (SISO)	MCS 0 to MCS 7
	802.11n (MIMO)	MCS 8 to MCS 15
Modulation Type	DBPSK/DQPSK/CCK (DSSS), BPSK/QPSK/16QAM/64QAM (OFDM).	
Emission Designator	11M8G7D (for 802.11b mode), 16M8G7D (for 802.11g mod), 17M6G7D (for 802.11n20 mode), 37M0G7D (for 802.11n40 mode)	
TX Power Control	<input type="checkbox"/> Supported, <input checked="" type="checkbox"/> Not Supported	
Standby Mode	<input type="checkbox"/> Supported, <input checked="" type="checkbox"/> Not Supported	
Equipment Type	<input checked="" type="checkbox"/> Stand-alone equipment, <input type="checkbox"/> Plug-in radio device, <input type="checkbox"/> Combined equipment	
Antenna	Description	Isotropic Antenna
	Type	<input checked="" type="checkbox"/> Integral <input type="checkbox"/> External <input type="checkbox"/> Dedicated
	Ports	<input checked="" type="checkbox"/> Ant 1, <input checked="" type="checkbox"/> Ant 2, <input type="checkbox"/> Ant 3
	Smart System	<input checked="" type="checkbox"/> SISO (for 802.11b/g/n), <input checked="" type="checkbox"/> CDD (for 802.11g), 2 Tx & 2 Rx, <input checked="" type="checkbox"/> MIMO (for 802.11n), 2 Tx & 2 Rx, <input type="checkbox"/> Diversity (for 802.11b/g) :      Tx      Rx
	Gain	Ant 1: -1.4 dBi (per antenna port, max.) Ant 2: -5.2 dBi (per antenna port, max.)
	Remark	When the EUT is put into service, the practical maximum antenna gain should NOT exceed the value as described above.

Characteristics	Description	
Power Supply	Type	<input type="checkbox"/> External DC mains, <input checked="" type="checkbox"/> Battery, <input type="checkbox"/> AC/DC Adapter, <input type="checkbox"/> Powered over Ethernet (PoE). <input type="checkbox"/> Other

## 5 General Test Conditions / Configurations

### 5.1 Test Modes

NOTE: Worst cases for each IEEE 802.11 mode are selected to perform tests.

Test Mode	Test Modes Description
11B	IEEE 802.11b with data rate of 1 Mbps using SISO mode.
11G	IEEE 802.11g with data rate of 6 Mbps using SISO mode.
11G CDD	IEEE 802.11g with data rate of 6 Mbps using CDD mode.
11N20	IEEE 802.11n with data rate of MCS0 and bandwidth of 20 MHz using SISO mode.
11N20m	IEEE 802.11n with data rate of MCS8 and bandwidth of 20 MHz using MIMO mode.
11N40	IEEE 802.11n with data rate of MCS0 and bandwidth of 40 MHz using SISO mode.
11N40m	IEEE 802.11n with data rate of MCS8 and bandwidth of 40 MHz using MIMO mode.

### 5.2 EUT Configurations

#### 5.2.1 General Configurations

Configuration	Description
Test Antenna Ports	Until otherwise specified, - All TX tests are performed at all TX antenna ports of the EUT, and - All RX tests are performed at all RX antenna ports of the EUT.
Multiple RF Sources	Other than the tested RF source of the EUT, other RF source(s) are disabled or shutdown during measurements.

#### 5.2.2 Customized Configurations

Test Mode	Antenna Port	Power Conf.,	Duty cycle [%]
11B	Ant 1	16.5	99.92
	Ant 2	15.5	99.94
11G	Ant 1	CH1/2: 10 CH10: 8.5 CH11: 7 Others:16.5	99.19
	Ant 2	CH1/2: 10 CH10: 8.5 CH11: 7 Others:15.5	99.38
11G_CDD	Ant 1	ANT1+ANT2 Total CH1/2: 13	99.15

	Ant 2	CH10: 11.5 CH11: 10 Others:19	99.34
11N20	Ant 1	CH1/2: 10 CH10: 8.5 CH11: 7 Others:15.5	99.12
	Ant 2	CH1/2: 10 CH10: 8.5 CH11: 7 Others:14.5	99.33
11N20M	Ant 1	ANT1+ANT2 Total CH1/2: 13 CH10: 11.5	99.19
	Ant 2	CH11: 10 Others:18	98.62
11N40	Ant 1	CH3/8: 5.5 CH4: 7 CH5/6:14.0 CH7: 6.5 CH9: 5.0	98.23
	Ant 2	CH3/8: 5.5 CH4: 7 CH5/6:13.0 CH7: 6.5 CH9: 5.0	98.73
11N40M	Ant 1	ANT1+ANT2 Total CH3/8: 8.5 CH4: 10	96.80
	Ant 2	CH5/6:16.5 CH7: 9.5 CH9: 8.0	97.42

### 5.3 Antenna requirements

**Excerpt from §15.203 of the FCC Rules/Regulations:**

“An intentional radiator antenna shall be designed to ensure that no antenna other than that furnished by the responsible party can be used with the device. The use of a permanently attached antenna or of an antenna that uses a unique coupling to the intentional radiator shall be considered sufficient to comply with the provisions of this section.”

The antennas of the **VOG-L04** are **permanently attached**.

There are no provisions for connection to an external antenna.

**Conclusion:**

The **EUT FCC ID: QISVOG-L04 unit** complies with the requirement of §15.203.

**Ch. Frequency (MHz)**

Ch.	Frequency (MHz)
01	2412
.	.
.	.
06	2437
.	.
.	.
11	2462

Frequency/ Channel Operations

## 5.4 Description of tests

### 5.4.1 Bandwidth measurement

- (a) Connect EUT test port to spectrum analyzer.
- (b) Set the EUT to transmit maximum output power at 2.4GHz, then set the measured frequency number and test the bandwidth with spectrum analyzer.

### 5.4.2 Average output power

- (a) Connect EUT test port to spectrum analyzer.
- (b) Set the EUT to transmit maximum output power at 2.4GHz.
- (c) Then set the EUT to transmit at high, middle and low frequency and measure the conducted output power separately.

### 5.4.3 Band edge spurious emission

- (a) Connect EUT test port to spectrum analyzer
- (b) Set the EUT to transmit maximum output power at 2.4GHz.
- (c) Then set the EUT to transmit at high, low frequency and measure the conducted band edge spurious separately.

### 5.4.4 Conducted RF spurious

- (a) Connect EUT test port to spectrum analyzer
- (b) Set the EUT to transmit maximum output power at 2.4GHz.
- (c) Then set the EUT to transmit at high, middle and low frequency and measure the conducted spurious separately.

### 5.4.5 Power spectral density

- (a) Connect EUT test port to spectrum analyzer
- (b) Set the EUT to transmit maximum output power at 2.4GHz.
- (c) Then set the EUT to transmit at high, middle and low frequency and measure the conducted power spectral density.

### 5.4.6 Radiated spurious emission & spurious in restricted band

For frequency below 1GHz, the test site semi-anechoic chamber has met the requirement of NSA tolerance 4dB according to the standards: ANSI C63.10 (2013). The EUT was set-up on insulator 80cm above the Ground Plane. For frequency above 1GHz, the test site full-anechoic chamber has met the requirement of ANSI C63.10 (2013). The EUT was set-up on insulator 150cm above the Ground Plane.

The set-up and test methods were according to ANSI C63.10:2013. The Radiated Disturbance measurements were made using a Rohde and Schwarz Test Receiver and control software.

A preliminary scan and a final scan of the emissions were made by using test script of software; the emissions were measured using a Quasi-Peak Detector below 1GHz, Peak Detector and AV Detector above 1GHz. The maximal emission value was acquired by adjusting the antenna height, polarisation and turntable azimuth in accordance with the software setup. Normally, the height range of antenna

was 1m to 4m, and the azimuth range of turntable was 0° to 360°. The receive antenna has two polarizations V and H.

A portable or small unlicensed wireless device shall be placed on a non-metallic test fixture or other nonmetallic support during testing. The supporting fixture shall permit orientation of the EUT in each of three orthogonal (x, y, z) axis positions such that emissions from the EUT are maximized.

The EUT communicates with the BTS simulator through Air interface. The EUT operated on the typical channel.

Measurement bandwidth: 30 MHz – 1000 MHz: 120 kHz

Measurement bandwidth: 1000 MHz – 10<sup>th</sup> Carrier Frequency: 1 MHz

#### **5.4.7 Conducted Emission at Power Port**

The Table-top EUT was placed upon a non-metallic table 0.8 m above the horizontal metal reference ground plane. EUT was connected to LISN and LISN was connected to reference Ground Plane. EUT was 80cm from LISN. The set-up and test methods were according to ANSI C63.10: 2013.

Conducted Disturbance at AC Port measurements were undertaken on the L and N Lines. The emissions were measured using a Quasi-Peak Detector and Average Detector.

The EUT communicates with the BTS simulator through Air interface, the BTS simulator controls the Wireless Modem to transmit the maximum power which defined in specification of product. The Wireless Modem operated on the typical channel.

Measurement bandwidth (RBW) for 150kHz to 30 MHz: 9 kHz;



## 5.5 Test Setups

### 5.5.1 Test Setup 1

The WLAN component's antenna port(s) of the EUT are connected to the measurement instrument per an appropriate attenuator. The EUT is controlled by PC/software to emit the specified signals for the purpose of measurements.

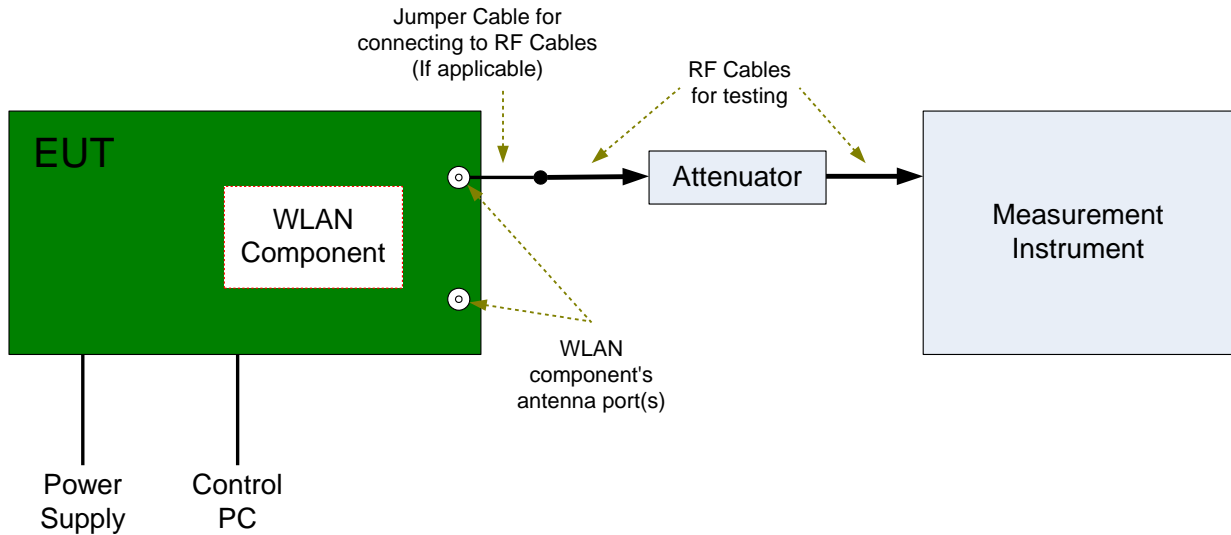

### 5.5.2 Test Setup 2

The semi-anechoic chamber and full-anechoic chamber has met the requirement of ANSI C63.4. The test distance is 3m. The setup is according to ANSI C63.4 and CAN/CSA-CEI/IEC CISPR 22.

The maximal emission value is acquired by adjusting the antenna height, polarisation and turntable azimuth. Normally, the height range of antenna is 1 m to 4 m, the azimuth range of turntable is 0° to 360°, and the receive antenna has two polarizations Vertical (V) and Horizontal (H).

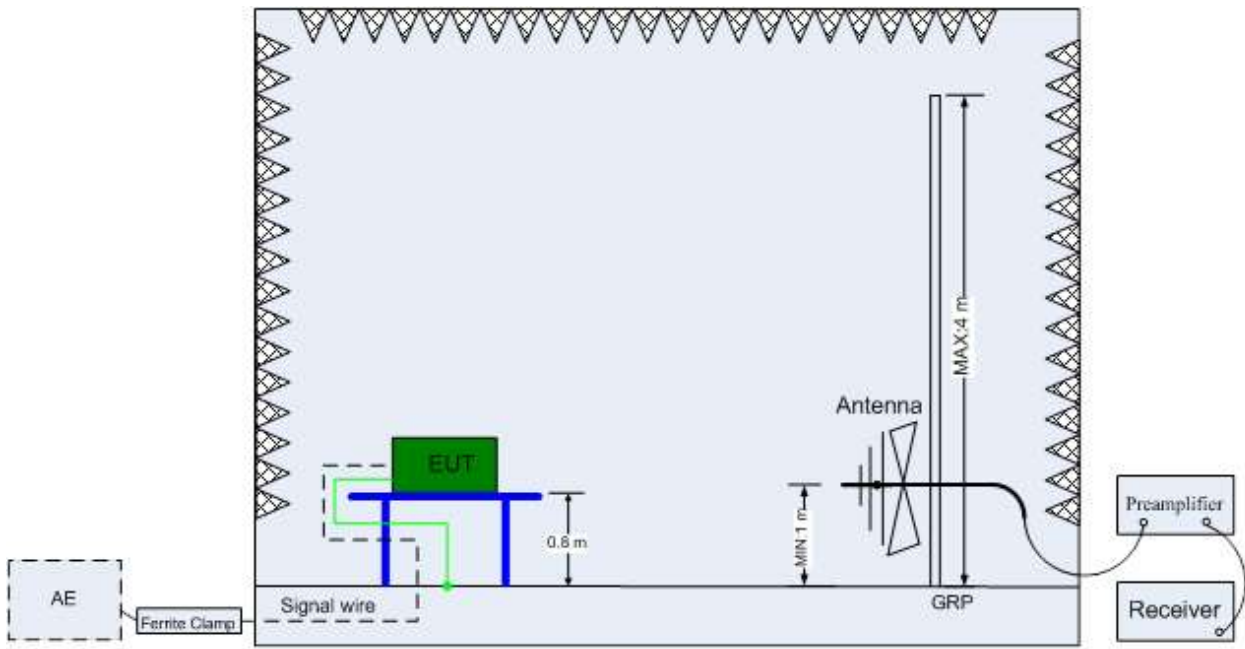

(Below 1 GHz)

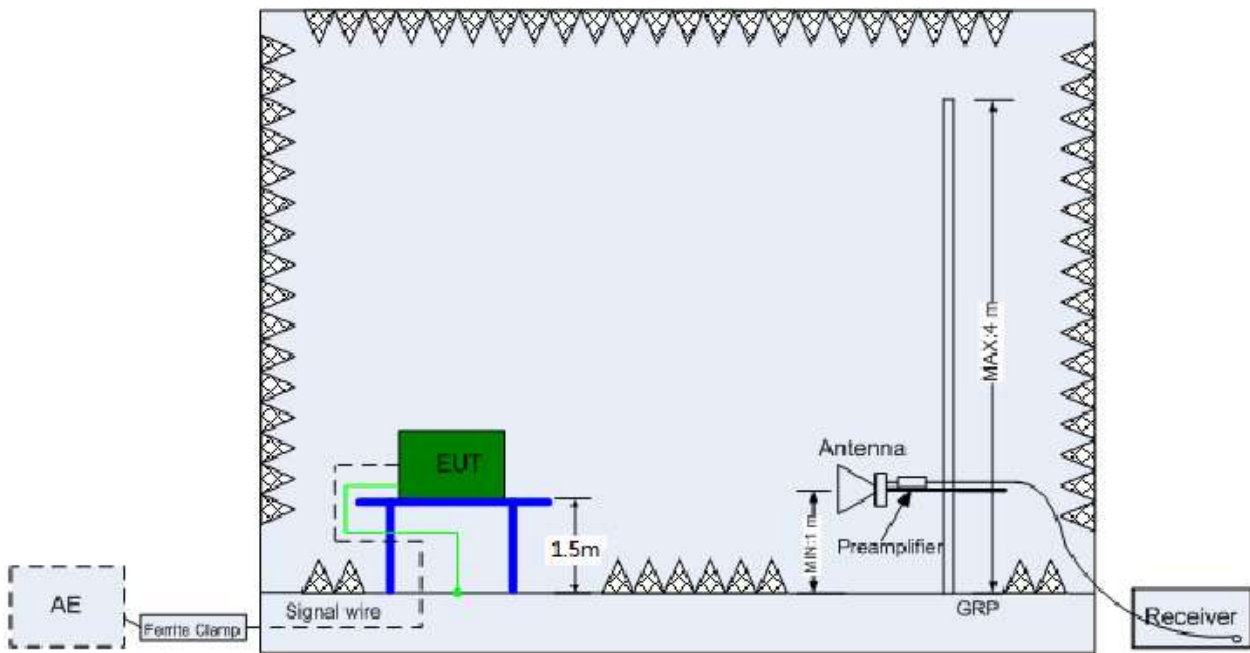

(Above 1 GHz)

### 5.5.3 Test Setup 3

The mains cable of the EUT (maybe per AC/DC Adapter) must be connected to LISN. The LISN shall be placed 0.8 m from the boundary of EUT and bonded to a ground reference plane for LISN mounted on top of the ground reference plane. This distance is between the closest points of the LISN and the EUT. All other units of the EUT and associated equipment shall be at least 0.8m from the LISN.

Ground connections, where required for safety purposes, shall be connected to the reference ground point of the LISN and, where not otherwise provided or specified by the manufacturer, shall be of same length as the mains cable and run parallel to the mains connection at a separation distance of not more than 0.1 m.

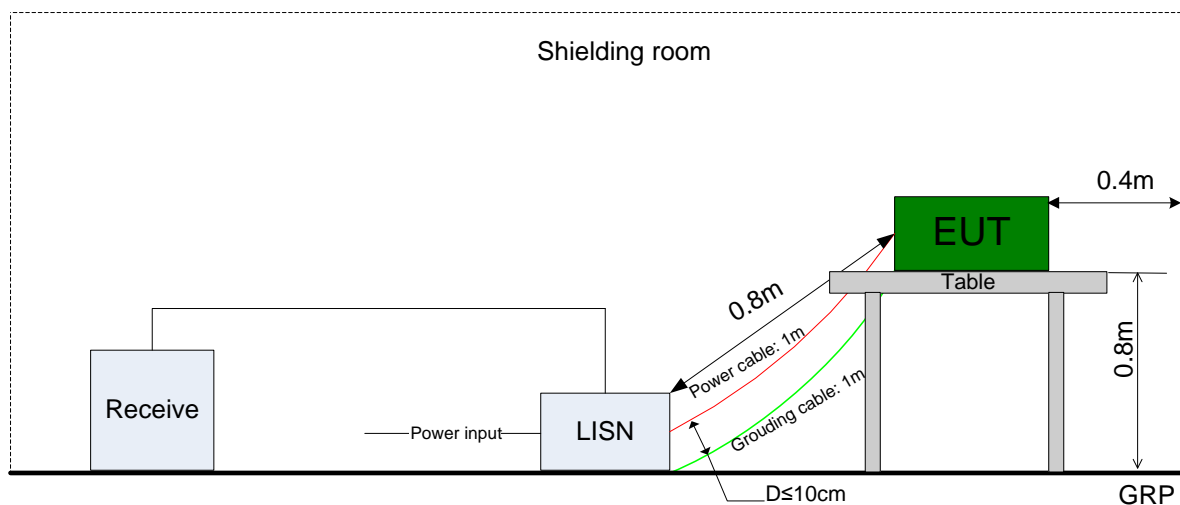

### 5.6 Test Conditions

Test Case	Test Conditions	
	Configuration	Description
DTS (6 dB) Bandwidth	Measurement Method	FCC KDB 558074 D01 §8.2 Option 2.
	Test Environment	TN/VN
	Test Setup	Test Setup 1
	EUT Configuration	11B_L@Ant1, 11B_L@Ant2, 11B_M@Ant1, 11B_M@Ant2, 11B_H@Ant1, 11B_H@Ant2, 11G_L@Ant1, 11G_L@Ant2, 11G_M@Ant1, 11G_M@Ant2, 11G_H@Ant1, 11G_H@Ant2, 11G_CDD_L@Ant1, 11G_CDD_L@Ant2, 11G_CDD_M@Ant1, 11G_CDD_M@Ant2, 11G_CDD_H@Ant1, 11G_CDD_H@Ant2, 11N20_L@Ant1, 11N20_L@Ant2, 11N20_M@Ant1, 11N20_M@Ant2, 11N20_H@Ant1, 11N20_H@Ant2, 11N20m_L@Ant1, 11N20m_L@Ant2, 11N20m_M@Ant1, 11N20m_M@Ant2, 11N20m_H@Ant1, 11N20m_H@Ant2, 11N40_L@Ant1, 11N40_L@Ant2, 11N40_M@Ant1, 11N40_M@Ant2, 11N40_H@Ant1, 11N40_H@Ant2, 11N40m_L@Ant1, 11N40m_L@Ant2, 11N40m_M@Ant1, 11N40m_M@Ant2, 11N40m_H@Ant1, 11N40m_H@Ant2,
Occupied Bandwidth	Measurement Method	FCC KDB 558074 D01 §8.2 Option 2.
	Test Environment	TN/VN
	Test Setup	Test Setup 1
	EUT Configuration	11B_L@Ant1, 11B_L@Ant2, 11B_M@Ant1, 11B_M@Ant2, 11B_H@Ant1, 11B_H@Ant2, 11G_L@Ant1, 11G_L@Ant2, 11G_M@Ant1, 11G_M@Ant2, 11G_H@Ant1, 11G_H@Ant2, 11G_CDD_L@Ant1, 11G_CDD_L@Ant2, 11G_CDD_M@Ant1, 11G_CDD_M@Ant2, 11G_CDD_H@Ant1, 11G_CDD_H@Ant2, 11N20_L@Ant1, 11N20_L@Ant2, 11N20_M@Ant1, 11N20_M@Ant2, 11N20_H@Ant1, 11N20_H@Ant2, 11N20m_L@Ant1, 11N20m_L@Ant2, 11N20m_M@Ant1, 11N20m_M@Ant2, 11N20m_H@Ant1, 11N20m_H@Ant2, 11N40_L@Ant1, 11N40_L@Ant2, 11N40_M@Ant1, 11N40_M@Ant2, 11N40_H@Ant1, 11N40_H@Ant2, 11N40m_L@Ant1, 11N40m_L@Ant2, 11N40m_M@Ant1, 11N40m_M@Ant2, 11N40m_H@Ant1, 11N40m_H@Ant2,
Maximum Conducted Average Output Power	Measurement Method	FCC KDB 558074 D01 §8.3.2.2
	Test Environment	TN/VN
	Test Setup	Test Setup 1
	EUT Configuration	11B_L@Ant1, 11B_L@Ant2, 11B_M@Ant1, 11B_M@Ant2,

Test Case	Test Conditions	
	Configuration	Description
		11B_H@Ant1, 11B_H@Ant2, 11G_L@Ant1, 11G_L@Ant2, 11G_M@Ant1, 11G_M@Ant2, 11G_H@Ant1, 11G_H@Ant2, 11G_CDD_L@Ant1, 11G_CDD_L@Ant2, 11G_CDD_M@Ant1, 11G_CDD_M@Ant2, 11G_CDD_H@Ant1, 11G_CDD_H@Ant2, 11N20_L@Ant1, 11N20_L@Ant2, 11N20_M@Ant1, 11N20_M@Ant2, 11N20_H@Ant1, 11N20_H@Ant2, 11N20m_L@Ant1, 11N20m_L@Ant2, 11N20m_M@Ant1, 11N20m_M@Ant2, 11N20m_H@Ant1, 11N20m_H@Ant2, 11N40_L@Ant1, 11N40_L@Ant2, 11N40_M@Ant1, 11N40_M@Ant2, 11N40_H@Ant1, 11N40_H@Ant2, 11N40m_L@Ant1, 11N40m_L@Ant2, 11N40m_M@Ant1, 11N40m_M@Ant2, 11N40m_H@Ant1, 11N40m_H@Ant2,
Maximum Power Spectral Density Level	Measurement Method	FCC KDB 558074 D01 §8.4
	Test Environment	TN/VN
	Test Setup	Test Setup 1
	EUT Configuration	11B_L@Ant1, 11B_L@Ant2, 11B_M@Ant1, 11B_M@Ant2, 11B_H@Ant1, 11B_H@Ant2, 11G_L@Ant1, 11G_L@Ant2, 11G_M@Ant1, 11G_M@Ant2, 11G_H@Ant1, 11G_H@Ant2, 11G_CDD_L@Ant1, 11G_CDD_L@Ant2, 11G_CDD_M@Ant1, 11G_CDD_M@Ant2, 11G_CDD_H@Ant1, 11G_CDD_H@Ant2, 11N20_L@Ant1, 11N20_L@Ant2, 11N20_M@Ant1, 11N20_M@Ant2, 11N20_H@Ant1, 11N20_H@Ant2, 11N20m_L@Ant1, 11N20m_L@Ant2, 11N20m_M@Ant1, 11N20m_M@Ant2, 11N20m_H@Ant1, 11N20m_H@Ant2, 11N40_L@Ant1, 11N40_L@Ant2, 11N40_M@Ant1, 11N40_M@Ant2, 11N40_H@Ant1, 11N40_H@Ant2, 11N40m_L@Ant1, 11N40m_L@Ant2, 11N40m_M@Ant1, 11N40m_M@Ant2, 11N40m_H@Ant1, 11N40m_H@Ant2,
Band Edges Compliance	Measurement Method	FCC KDB 558074 D01 §8.7
	Test Environment	TN/VN
	Test Setup	Test Setup 1
	EUT Configuration	11B_L@Ant1, 11B_L@Ant2, 11B_H@Ant1, 11B_H@Ant2, 11G_L@Ant1, 11G_L@Ant2, 11G_H@Ant1, 11G_H@Ant2, 11G_CDD_L@Ant1, 11G_CDD_L@Ant2, 11G_CDD_H@Ant1, 11G_CDD_H@Ant2, 11N20_L@Ant1, 11N20_L@Ant2, 11N20_H@Ant1, 11N20_H@Ant2, 11N20m_L@Ant1, 11N20m_L@Ant2, 11N20m_H@Ant1, 11N20m_H@Ant2, 11N40_L@Ant1, 11N40_L@Ant2, 11N40_H@Ant1, 11N40_H@Ant2,

Test Case	Test Conditions	
	Configuration	Description
		11N40m_L@Ant1,11N40m_L@Ant2,11N40m_H@Ant1,11N40m_H@Ant2,
Unwanted Emissions into Non-Restricted Frequency Bands	Measurement Method	FCC KDB 558074 D01 §8.5
	Test Environment	TN/VN
	Test Setup	Test Setup 1
	EUT Configuration	11B_L@Ant1, 11B_L@Ant2, 11B_M@Ant1, 11B_M@Ant2, 11B_H@Ant1, 11B_H@Ant2, 11G_L@Ant1, 11G_L@Ant2, 11G_M@Ant1, 11G_M@Ant2, 11G_H@Ant1, 11G_H@Ant2, 11G_CDD_L@Ant1, 11G_CDD_L@Ant2, 11G_CDD_M@Ant1, 11G_CDD_M@Ant2, 11G_CDD_H@Ant1, 11G_CDD_H@Ant2, 11N20_L@Ant1, 11N20_L@Ant2, 11N20_M@Ant1, 11N20_M@Ant2, 11N20_H@Ant1, 11N20_H@Ant2, 11N20m_L@Ant1, 11N20m_L@Ant2, 11N20m_M@Ant1, 11N20m_M@Ant2, 11N20m_H@Ant1, 11N20m_H@Ant2, 11N40_L@Ant1, 11N40_L@Ant2, 11N40_M@Ant1, 11N40_M@Ant2, 11N40_H@Ant1, 11N40_H@Ant2, 11N40m_L@Ant1, 11N40m_L@Ant2, 11N40m_M@Ant1, 11N40m_M@Ant2, 11N40m_H@Ant1, 11N40m_H@Ant2,
Unwanted Emissions into Restricted Frequency Bands (Radiated)	Measurement Method	ANSI C63.10; FCC KDB 558074 D01 §8.6, Radiated
	Test Environment	TN/VN
	Test Setup	Test Setup 2
	EUT Placement	<input checked="" type="checkbox"/> Flatwise, <input checked="" type="checkbox"/> Upright, <input checked="" type="checkbox"/> Hung
	EUT Configuration	(1) 30 MHz to 1 GHz: 11B_L@Ant1 (Worst Conf.). (2) 1 GHz to 3 GHz: 11B_L@Ant1, 11B_L@Ant2, 11B_H@Ant1, 11B_H@Ant2, 11G_L@Ant1, 11G_L@Ant2, 11G_H@Ant1, 11G_H@Ant2, 11G_CDD_L@Ant1, 11G_CDD_L@Ant2, 11G_CDD_H@Ant1, 11G_CDD_H@Ant2, 11N20_L@Ant1, 11N20_L@Ant2, 11N20_H@Ant1, 11N20_H@Ant2, 11N20m_L@Ant1,11N20m_L@Ant2,11N20m_H@Ant1,11N20m_H@Ant2 11N40_L@Ant1, 11N40_L@Ant2, 11N40_H@Ant1, 11N40_H@Ant2, 11N40m_L@Ant1,11N40m_L@Ant2,11N40m_H@Ant1,11N40m_H@Ant2, (3) 3 GHz to 18 GHz: 11B_L@Ant1 (Worse Conf.), 11B_H@Ant1 (Worse Conf.). (4) 18 GHz to 26.5 GHz: 11B_L@Ant1 (Worse Conf.), 11B_H@Ant1 (Worse Conf.).
AC Power Line	Measurement Method	AC mains conducted.

Test Case	Test Conditions	
	Configuration	Description
Conducted Emissions	Test Environment	TN/VN
	Test Setup	Test Setup 3
	EUT Configuration	11B_L@Ant1 (Worst Conf.).

## 5.7 Main Instruments

This table gives a complete overview of the RF measurement equipment.

Devices used during the test described are marked

<input checked="" type="checkbox"/> Main Test Equipment(BT/WIFI test system)						
Marked	Equipment Name	Manufacturer	Model	Serial Number	Cal Date	Cal-Due
<input type="checkbox"/>	JS1120-3 BT/WIFI test system	JS Tonscend	JS0806-2	188060102	2018/05/30	2019/05/30
<input type="checkbox"/>	Power Detecting & Samplig Unit	R&S	OSP-B157	101429	2018/07/23	2019/07/23
<input type="checkbox"/>	Power Sensor	R&S	NRP2	103085/106211	2018/05/17	2019/05/17
<input type="checkbox"/>	DC Power Supply	KEITHLEY	2303	1342889	2018/10/24	2019/10/24
<input type="checkbox"/>	DC Power Supply	KEITHLEY	2303	000500E	2018/05/21	2019/05/21
<input type="checkbox"/>	DC Power Supply	KEITHLEY	2303	1288003	2017/12/21	2018/12/21
<input type="checkbox"/>	DC Power Supply	KEITHLEY	2303	000381E	2018/05/21	2019/05/21
<input checked="" type="checkbox"/>	DC Power Supply	KEITHLEY	2303	000510E	2018/05/21	2019/05/21
<input type="checkbox"/>	DC Power Supply	KEITHLEY	2303	1342896	2018/10/24	2019/10/24
<input type="checkbox"/>	Temperature Chamber	WEISS	WKL64	56246002940010	2018/10/24	2019/10/24
<input type="checkbox"/>	Spectrum Analyzer	Agilent	N9030A	MY51380032	2018/07/23	2019/07/23
<input type="checkbox"/>	Spectrum Analyzer	Agilent	N9030A	MY49431698	2018/07/23	2019/07/23
<input checked="" type="checkbox"/>	Spectrum Analyzer	Keysight	N9040B	MY57212529	2018/06/28	2019/06/28
<input type="checkbox"/>	Signal Analyzer	R&S	FSQ31	200021	2018/07/23	2019/07/23
<input type="checkbox"/>	Signal Analyzer	R&S	FSU26	201069	2018/11/2	2019/11/2
<input type="checkbox"/>	Universal Radio Communication Tester	R&S	CMW500	164699	2018/03/15	2019/03/15
<input type="checkbox"/>	Universal Radio Communication Tester	R&S	CMW500	159302	2018/07/23	2019/07/23
<input type="checkbox"/>	Wireless Communication Test set	Agilent	N4010A	MY49081592	2018/07/23	2019/07/23
<input checked="" type="checkbox"/>	Signal generator	Agilent	E8257D	MY51500314	2018/04/27	2019/04/27
<input type="checkbox"/>	Signal generator	Agilent	E8257D	MY49281095	2018/07/23	2019/07/23
<input type="checkbox"/>	Vector Signal Generator	R&S	SMW200A	103447	2018/05/31	2019/05/31
<input type="checkbox"/>	Vector Signal Generator	R&S	SMU200A	104162	2018/07/23	2019/07/23

<input checked="" type="checkbox"/> Main Test Equipment( RE test system)						
Marked	Equipment Name	Manufacturer	Model	Serial Number	Cal Date	Cal-Due
<input checked="" type="checkbox"/>	Test receiver	R&S	ESU26	100387	2019/01/15	2020/01/14
<input checked="" type="checkbox"/>	LOOP Antennas(9kHz-30MHz)	R&S	HFH2-Z2	100262	2017/04/25	2019/04/25
<input type="checkbox"/>	LOOP	R&S	HFH2-Z2	100263	2017/04/25	2019/04/25



	Antennas(9kHz-30MHz)					
<input checked="" type="checkbox"/>	Trilog Broadband Antenna (30M~3GHz)	SCHWARZBECK	VULB 9163	9163-357	2017/04/21	2019/04/20
<input type="checkbox"/>	Trilog Broadband Antenna (30M~3GHz)	SCHWARZBECK	VULB 9163	9163-520	2017/3/29	2019/3/28
<input type="checkbox"/>	Trilog Broadband Antenna (30M~3GHz)	SCHWARZBECK	VULB 9163	9163-491	2017/3/29	2019/3/28
<input type="checkbox"/>	Trilog Broadband Antenna (30M~3GHz)	SCHWARZBECK	VULB 9163	9163-356	2018/4/9	2020/4/8
<input checked="" type="checkbox"/>	Double-Ridged Waveguide Horn Antenna (1G~18GHz)	R&S	HF907	100305	2017/4/21	2019/4/20
<input type="checkbox"/>	Double-Ridged Waveguide Horn Antenna (1G~18GHz)	R&S	HF906	100684	2017/5/27	2019/5/26
<input type="checkbox"/>	Double-Ridged Waveguide Horn Antenna (1G~18GHz)	R&S	HF906	100683	2017/3/29	2019/3/28
<input checked="" type="checkbox"/>	Pyramidal Horn Antenna(18GHz-26.5G Hz)	ETS-Lindgren	3160-09	5140299	2017/07/20	2019/07/19
<input type="checkbox"/>	Pyramidal Horn Antenna(18GHz-26.5G Hz)	ETS-Lindgren	3160-09	00206665	2018/4/21	2020/4/20
<input checked="" type="checkbox"/>	Pyramidal Horn Antenna(26.5GHz-40G Hz)	ETS-Lindgren	3160-10	00205695	2018/04/20	2020/04/19
<input type="checkbox"/>	Pyramidal Horn Antenna(26.5GHz-40G Hz)	ETS-Lindgren	3160-10	LM5947	2017/07/20	2019/07/19
<input checked="" type="checkbox"/>	Measurement Software	R&S	EMC32 V9.25.0	/	/	/

<input checked="" type="checkbox"/> Main Test Equipment( CE test system)						
Marked	Equipment Name	Manufacturer	Model	Serial Number	Cal Date	Cal-Due
<input type="checkbox"/>	Test receiver	R&S	ESU26	100387	2019/01/15	2020/01/14
<input checked="" type="checkbox"/>	Test receiver	R&S	ESCI	101163	2019/01/15	2020/01/14
<input type="checkbox"/>	Artificial Main Network	R&S	ENV4200	100134	2018/05/08	2019/05/07
<input checked="" type="checkbox"/>	Line Impedance Stabilization Network	R&S	ENV216	100382	2018/05/08	2019/05/07
<input checked="" type="checkbox"/>	Measurement Software	R&S	EMC32 V9.25.0	/	/	/

## 6 Measurement Uncertainty

For a 95% confidence level ( $k = 2$ ), the measurement expanded uncertainties for defined systems, in accordance with the recommendations of ISO 17025 as following:

Test Item		Extended Uncertainty
Transmit Output Power Data	Power [dBm]	U = 0.39 dB
RF Power Density, Conducted	Power [dBm]	U = 0.64 dB
Bandwidth	Magnitude [kHz]	20MHz: U=41.78kHz 40MHz: U=82.12kHz
Band Edge Compliance	Disturbance Power [dBm]	U = 0.9 dB
Spurious Emissions, Conducted	Disturbance Power [dBm]	20MHz~3.6GHz: U=0.88dB 3.6GHz~8.4GHz: U=1.08dB 8.4GHz~13.6GHz: U=1.24dB 13.6GHz~22GHz: U=1.34dB 22GHz~26.5GHz: U=1.36dB
Field Strength of Spurious Radiation	ERP/EIRP [dBm]	For 3 m Chamber: U = 5.90 dB (30 MHz-1 GHz) U = 4.94 dB (1 GHz-18 GHz) U = 4.24 dB (18 GHz-26.5 GHz)
Frequency Stability	Frequency Accuracy [Hz]	U=41.58Hz
AC Power Line Conducted Emissions	Disturbance Voltage[dBμV]	U=2.3 dB
Duty Cycle	Duty Cycle [%]	U=±2.06 %

## 7 Appendixes

Appendix No.	Description
SYBH(Z-RF)20181218028001-2002-A	Appendix for_2.4G_WLAN

---

END