



FCC&ISED RF Test Report

Product Name: Smart Phone

Model Number: VOG-L04

Report No.: SYBH(Z-RF)20181218028001-2001

FCC ID : QISVOG-L04

IC: 6369A-VOGL04

Authorized	APPROVED (Lab Manager)	PREPARED (Test Engineer)
BY	He Hao	Zhang Shuangxia
DATE	2019-01-28	2019-01-28

Reliability Laboratory of Huawei Technologies Co., Ltd.

(Global Compliance and Testing Center of Huawei Technologies Co., Ltd)

No.2, New City Avenue, Songshan Lake Sci. & Tech. Industry Park, Dongguan, 523808, P.R.C

Telephone: +86 769 23830808

Fax: +86 769 23837628

※ ※ Notice ※ ※

1. The laboratory has passed the accreditation by The American Association for Laboratory Accreditation (A2LA). The accreditation number is 2174.01
2. The laboratory has been recognized by the US Federal Communications Commission (FCC) to perform compliance testing subject to the Commission's Certification rules. The Designation Number is CN1173, and the Test Firm Registration Number is 294140.
3. The laboratory has been recognized by the Innovation, Science and Economic Development Canada (ISED) to test to Canadian radio equipment requirements. The CAB identifier is CN0003, and the ISED# is 21741.
4. The laboratory (Reliability Lab of Huawei Technologies Co., Ltd) is also named "Global Compliance and Testing Center of Huawei Technologies Co., Ltd", the both names have coexisted since 2009.
5. The test report is invalid if not marked with the signatures of the persons responsible for preparing and approving the test report.
6. The test report is invalid if there is any evidence of erasure and/or falsification.
7. The test report is only valid for the test samples.
8. Content of the test report, in part or in full, cannot be used for publicity and/or promotional purposes without prior written approval from the laboratory.
9. If any question about this report, please contact the laboratory (PublicGCTC@huawei.com).

MODIFICATION RECORD

No.	Report No	Modification Description
1	SYBH(Z-RF)2018121 8028001-2001	First release.

DECLARATION

Type	Description
Multiple Models Applications	<input checked="" type="checkbox"/> The present report applies to single model.
	<input type="checkbox"/> The present report applies to several models. The practical measurements are performed with the model.
	The present report only presents the worst test case of all modes, see relevant test results for detailed.

1 Table of contents

1	Table of contents.....	4
2	General Information.....	5
2.1	Test standard/s.....	5
2.2	Test Environment.....	5
2.3	Test Laboratories.....	6
2.4	Applicant and Manufacturer.....	6
2.5	Application details.....	6
3	Test Summary.....	7
3.1	Cellular Band (824-849 MHz paired with 869-894 MHz).....	7
3.2	PCS Band (1850-1910 MHz paired with 1930-1990 MHz).....	9
3.3	AWS Band (1710-1755 MHz paired with 2110-2155 MHz).....	11
3.4	BRS&EBS Band 7&CA_7C (2500-2570 MHz paired with 2620-2690 MHz).....	13
3.5	Band12 (699-716MHz paired with 729-746 MHz).....	16
3.6	Band17 (704-716MHz paired with 734-746 MHz).....	17
3.7	Band26 (814-824 MHz paired with 859-869MHz).....	18
3.8	BRS&EBS Band38&CA_38C (2570-2620 MHz paired with 2570-2620 MHz).....	19
3.9	WCS Band40 (2305-2315 MHz and 2350-2360 MHz).....	22
3.10	Band41&CA_41C (2545-2655 MHz paired with 2545-2655 MHz).....	23
3.11	Band 66 (1710-1780 MHz paired with 2110-2175 MHz).....	26
4	Description of the Equipment under Test (EUT).....	28
4.1	General Description.....	28
4.2	EUT Identity.....	28
4.3	Technical Specification.....	30
5	General Test Conditions / Configurations.....	36
5.1	Test Modes.....	36
5.2	Test Frequency.....	37
5.3	DESCRIPTION OF TESTS.....	51
5.4	Test Setups.....	55
5.5	Test Conditions.....	58
6	Main Test Instruments.....	60
6.1	Current Test Project/Report.....	60
7	Measurement Uncertainty.....	63
8	Appendixes.....	64

2 General Information

2.1 Test standard/s

Applied Rules :	47 CFR FCC Part 02 47 CFR FCC Part 22 47 CFR FCC Part 24 47 CFR FCC Part 27 47 CFR FCC Part 90 ISED RSS-Gen Issue 5 ISED RSS-130 Issue 1 ISED RSS-132 Issue 3 ISED RSS-133 Issue 6 ISED RSS-139 Issue 3 ISED RSS-195 Issue 2 ISED RSS-199 Issue 3
Test Method :	FCC KDB 971168 D01 Power Meas License Digital Systems v03r01 ANSI C63.26

2.2 Test Environment

Temperature :	TN	15 to 30	°C during room temperature tests	
Ambient Relative Humidity:	40 to 55 %			
Atmospheric Pressure:	Not applicable			
Power supply :	VL	3.6	V	
	VN	3.82	V DC by Battery	
	VH	4.35	V	

NOTE: 1) VN= nominal voltage, VL= low extreme test voltage, VH= High extreme test voltage;

TN= normal temperature, TL= low extreme test temperature, TH= High extreme test temperature.

NOTE 2: The values used in the test report may be stringent than the declared.

2.3 Test Laboratories

Test Location 1 :	RELIABILITY LABORATORY OF HUAWEI TECHNOLOGIES CO., LTD.
Address of Test Location 1 :	No.2 New City Avenue Songshan Lake Sci. &Tech. Industry Park, Dongguan, Guangdong, P.R.C

2.4 Applicant and Manufacturer

Company Name :	HUAWEI TECHNOLOGIES CO., LTD
Address :	Administration Building, Headquarters of Huawei Technologies Co., Ltd., Bantian, Longgang District, Shenzhen, 518129, P.R.C

2.5 Application details

Date of Receipt Sample:	2019-01-02
Start of test:	2019-01-03
End of test:	2019-01-28

3 Test Summary

3.1 Cellular Band (824-849 MHz paired with 869-894 MHz)

Test Item	FCC Rule No.	ISED Rule No.	Requirements	Test Result	Verdict (Note1)
Effective (Isotropic) Radiated Power Output Data	§2.1046, §22.913	RSS-Gen, §6.12; RSS-132, §5.4	FCC: ERP ≤ 7 W. ISED: EIRP ≤ 11.5 W.	Appendix A	Pass
Peak-Average Ratio	---	RSS-132, §5.4	Limit ≤ 13 dB	Appendix B	Pass
Modulation Characteristics	§2.1047	RSS-132, §5.2	Digital modulation	Appendix C	Pass
Bandwidth	§2.1049	RSS-Gen, §6.7	OBW: No limit. EBW: No limit.	Appendix D	Pass
Band Edges Compliance	§2.1051, §22.917	RSS-Gen, §6.13; RSS-132, §5.5	FCC: ≤ -13 dBm/1%*EBW, in 1 MHz bands immediately outside and adjacent to the frequency block. Note 1): EBW is -26 dBc EBW. ISED: ≤ -13 dBm/1%*OBW, in 1 MHz bands immediately outside and adjacent to the sub-bands.	Appendix E	Pass
Spurious Emission at Antenna Terminals	§2.1051, §22.917	RSS-Gen, §6.13; RSS-132, §5.5	FCC: ≤ -13 dBm/RefBW, from max(lowest internal frequency, 9 kHz) to min(10 * highest fundamental frequency, 40 GHz), after 1 MHz bands immediately outside and adjacent to the frequency block. (RefBW: ≥100 kHz for frequency below 1 GHz, and =1 MHz above 1 GHz) ISED: ≤ -13 dBm/100 kHz, from max(min(lowest internal frequency, 30 MHz), 9 kHz) to min(10 * highest fundamental frequency, 40 GHz), after first 1.0 MHz immediately outside and adjacent to each of the sub-bands.	Appendix F	Pass
Field Strength of	§2.1053,	RSS-Gen,	FCC: ≤ -13 dBm/RefBW, from	Appendix G	Pass

Test Item	FCC Rule No.	ISED Rule No.	Requirements	Test Result	Verdict (Note1)
Spurious Radiation	§22.917	§6.13; RSS-132, §5.5	<p>max(lowest internal frequency, 9 kHz) to min(10 * highest fundamental frequency, 40 GHz), after 1 MHz bands immediately outside and adjacent to the frequency block.</p> <p>(RefBW: ≥100 kHz for frequency below 1 GHz, and =1 MHz above 1 GHz)</p> <p>ISED: ≤ -13 dBm/100 kHz, from max(min(lowest internal frequency, 30 MHz), 9 kHz) to min(10 * highest fundamental frequency, 40 GHz), after first 1.0 MHz immediately outside and adjacent to each of the sub-bands.</p>		
Frequency Stability	§2.1055, §22.355	RSS-Gen, §6.11 RSS-132, §5.3	≤ ±2.5ppm	Appendix H	Pass
NOTE: For the verdict, the "N/A" denotes "not applicable", the "N/T" denotes "not tested".					

3.2 PCS Band (1850-1910 MHz paired with 1930-1990 MHz)

Test Item	FCC Rule No.	ISED Rule No.	Requirements	Test Result	Verdict (Note1)
Effective (Isotropic) Radiated Power Output Data	§2.1046, §24.232	RSS-Gen, §6.12; RSS-133, §6.4	EIRP ≤ 2 W	Appendix A	Pass
Peak-Average Ratio	§2.1046, §24.232	RSS-133, §6.4	Limit ≤ 13 dB	Appendix B	Pass
Modulation Characteristics	§2.1047	RSS-133, §6.2	Digital modulation	Appendix C	Pass
Bandwidth	§2.1049	RSS-Gen, §6.7	OBW: No limit. EBW: No limit.	Appendix D	Pass
Band Edges Compliance	§2.1051, §24.238	RSS-Gen, §6.13; RSS-133, §6.5	FCC: ≤ -13 dBm/1%*EBW, in 1 MHz bands immediately outside and adjacent to the frequency block. Note 1): EBW is -26 dBc EBW. ISED: ≤ -13 dBm/1%*EBW, in 1 MHz bands immediately outside and adjacent to the frequency block. Note 1): EBW is -20 dBc EBW, or OBW.	Appendix E	Pass
Spurious Emission at Antenna Terminals	§2.1051, §24.238	RSS-Gen, §6.13; RSS-133, §6.5	FCC: ≤ -13 dBm/1 MHz, from max(lowest internal frequency, 9 kHz) to min(10 * highest fundamental frequency, 40 GHz) but outside authorized operating frequency blocks. ISED: ≤ -13 dBm/1 MHz, from max(min(lowest internal frequency, 30 MHz), 9 kHz) to min(10 * highest fundamental frequency, 40 GHz) but outside authorized operating frequency blocks.	Appendix F	Pass
Field Strength of Spurious	§2.1053, §24.238	RSS-Gen, §6.13;	FCC: ≤ -13 dBm/1 MHz, from max(lowest internal frequency, 9	Appendix G	Pass

Test Item	FCC Rule No.	ISED Rule No.	Requirements	Test Result	Verdict (Note1)
Radiation		RSS-133, §6.5	kHz) to min(10 * highest fundamental frequency, 40 GHz) but outside authorized operating frequency blocks. ISED: ≤ -13 dBm/1 MHz, from max(min(lowest internal frequency, 30 MHz), 9 kHz) to min(10 * highest fundamental frequency, 40 GHz) but outside authorized operating frequency blocks.		
Frequency Stability	§2.1055, §24.235	RSS-Gen, §6.11 RSS-133, §6.3	FCC: Within authorized bands of operation/frequency block. ISED $\leq \pm 2.5$ ppm	Appendix H	Pass
NOTE: For the verdict, the "N/A" denotes "not applicable", the "N/T" denotes "not tested".					

3.3 AWS Band (1710-1755 MHz paired with 2110-2155 MHz)

Test Item	FCC Rule No.	ISED Rule No.	Requirements	Test Result	Verdict (Note1)
Effective (Isotropic) Radiated Power Output Data	§2.1046, §27.50(d)	RSS-Gen, §6.12; RSS-139, §6.4	EIRP ≤ 1 W	Appendix A	Pass
Peak-Average Ratio	§2.1046, §27.50(d)	RSS-139, §6.4	Limit ≤ 13 dB	Appendix B	Pass
Modulation Characteristics	§2.1047	RSS-139, §6.2	Digital modulation	Appendix C	Pass
Bandwidth	§2.1049	RSS-Gen, §6.7	OBW: No limit. EBW: No limit.	Appendix D	Pass
Band Edges Compliance	§2.1051, §27.53(h)	RSS-Gen, §6.13; RSS-139, §6.5	FCC: ≤ -13 dBm/1%*EBW, in 1 MHz bands immediately outside and adjacent to the frequency block. Note 1): EBW is -26 dBc EBW. ISED: ≤ -13 dBm/1%*EBW, in 1 MHz bands immediately outside and adjacent to the frequency block. Note 1): EBW is not defined.	Appendix E	Pass
Spurious Emission at Antenna Terminals	§2.1051, §27.53(h)	RSS-Gen, §6.13; RSS-139, §6.5	FCC: ≤ -13 dBm/1 MHz, from max(lowest internal frequency, 9 kHz) to min(10 * highest fundamental frequency, 40 GHz) but outside authorized operating frequency ranges. ISED: ≤ -13 dBm/1 MHz, from max(min(lowest internal frequency, 30 MHz), 9 kHz) to min(10 * highest fundamental frequency, 40 GHz) but outside authorized operating frequency ranges.	Appendix F	Pass
Field Strength of Spurious	§2.1053, §27.53(h)	RSS-Gen, §6.13;	FCC: ≤ -13 dBm/1 MHz, from max(lowest internal frequency,	Appendix G	Pass

Test Item	FCC Rule No.	ISED Rule No.	Requirements	Test Result	Verdict (Note1)
Radiation		RSS-139, §6.5	<p>9 kHz) to min(10 * highest fundamental frequency, 40 GHz) but outside authorized operating frequency ranges.</p> <p>ISED: ≤ -13 dBm/1 MHz, from max(min(lowest internal frequency, 30 MHz), 9 kHz) to min(10 * highest fundamental frequency, 40 GHz) but outside authorized operating frequency ranges.</p>		
Frequency Stability	§2.1055, §27.54	RSS-Gen, §6.11; RSS-139, §6.3	Within authorized bands of operation/frequency block.	Appendix H	Pass
<p>NOTE: For the verdict, the "N/A" denotes "not applicable", the "N/T" denotes "not tested".</p>					

3.4 BRS&EBS Band 7&CA_7C (2500-2570 MHz paired with 2620-2690 MHz)

Test Item	FCC Rule No.	ISED Rule No.	Requirements	Test Result	Verdict (Note1)
Effective (Isotropic) Radiated Power Output Data	§2.1046, §27.50(h)	RSS-Gen, §6.12; RSS-199, §4.4	EIRP ≤ 2W	Appendix A	Pass
Peak-Average Ratio	§27.50(a)	RSS-199, §4.4	Limits ≤ 13 dB	Appendix B	Pass
Modulation Characteristics	§2.1047	RSS-199, §4.1	Digital modulation	Appendix C	Pass
Bandwidth	§2.1049	RSS-Gen, §6.7	OBW: No limit. EBW: No limit.	Appendix D	Pass
Band Edges Compliance	§2.1051, §27.53(m4)	RSS-Gen, §6.13; RSS-199, §4.5; RSS-199, §4.2	<p>FCC:</p> <p>AND</p> <p>AND, if 2495-2496MHz is immediately outside and adjacent to the frequency block</p> <p>Note 1): EBW is -26 dBc EBW.</p> <p>ISED:</p> <p>AND</p>	Appendix E	Pass

Test Item	FCC Rule No.	ISED Rule No.	Requirements	Test Result	Verdict (Note1)
<p>Spurious Emission at Antenna Terminals</p>	<p>§2.1051, §27.53(m)</p>	<p>RSS-Gen, §6.13; RSS-199, §4.5; RSS-199, §4.2</p>	<p>FCC:</p> <p>AND</p> <p>Fa = max(lowest internal frequency, 9 kHz) Fb = min(10 * highest fundamental frequency, 40 GHz)</p> <p>Note 1): EBW is -26 dBc EBW. Note 2): MeasFrom: max(lowest internal frequency, 9 kHz). Note 3): MeasTo: min(10 * highest fundamental frequency, 40 GHz).</p> <p>ISED:</p> <p>AND</p> <p>Fa = max(min(lowest internal frequency, 30 MHz), 9 kHz). Fb = min(10 * highest fundamental frequency, 40 GHz).</p> <p>Note 1): MeasFrom: max(min(lowest internal frequency, 30 MHz), 9 kHz). Note 2): MeasTo: min(10 * highest fundamental frequency, 40 GHz).</p>	<p>Appendix F</p>	<p>Pass</p>
<p>Field Strength of Spurious Radiation</p>	<p>§2.1053, §27.53(m)</p>	<p>RSS-Gen, §6.13; RSS-199, §4.5</p>	<p>FCC:</p> <p>AND</p> <p>Fa = max(lowest internal frequency, 9 kHz) Fb = min(10 * highest fundamental frequency, 40 GHz)</p>	<p>Appendix G</p>	<p>Pass</p>

Test Item	FCC Rule No.	ISED Rule No.	Requirements	Test Result	Verdict (Note1)
			<p>Note 1): EBW is -26 dBc EBW.</p> <p>Note 2): MeasFrom: max(lowest internal frequency, 9 kHz).</p> <p>Note 3): MeasTo: min(10 * highest fundamental frequency, 40 GHz).</p> <p>ISED:</p> <p>AND</p> <p>Fa = max(min(lowest internal frequency, 30 MHz), 9 kHz). Fb = min(10 * highest fundamental frequency, 40 GHz).</p> <p>Note 1): MeasFrom: max(min(lowest internal frequency, 30 MHz), 9 kHz).</p> <p>Note 2): MeasTo: min(10 * highest fundamental frequency, 40 GHz).</p>		
Frequency Stability	§2.1055, §27.54	RSS-Gen, §6.11; RSS-199, §4.3	Within authorized bands of operation/frequency block.	Appendix H	Pass
NOTE: For the verdict, the "N/A" denotes "not applicable", the "N/T" denotes "not tested".					

3.5 Band12 (699-716MHz paired with 729-746 MHz)

Test Item	FCC Rule No	ISED Rule No.	Requirements	Test Result	Verdict (Note1)
Effective (Isotropic) Radiated Power Output Data	§27.50(c)	RSS-Gen, §6.12; RSS-130,§4.4	FCC: ERP ≤ 3 W. ISED: EIRP ≤ 50 W.	Appendix A	Pass
Peak-Average Ratio	§2.1046, §27.50(c)	RSS-130,§4.4	ISED: Limits≤13 dB	Appendix B	Pass
Modulation Characteristics	§2.1047	---	Digital modulation	Appendix C	Pass
Bandwidth	§2.1049	RSS-Gen, §6.7	OBW: No limit. EBW: No limit.	Appendix D	Pass
Band Edges Compliance	§2.1051, §27.53(g)	RSS-Gen, §6.13 RSS-130,§4.6	≤ -13 dBm/30 kHz, in 100 kHz bands immediately outside and adjacent to the frequency blocks.	Appendix	Pass
Spurious Emission at Antenna Terminals	§2.1051, §27.53(g)	RSS-Gen, §6.13 RSS-130,§4.6	≤ -13 dBm/100 kHz, from 9 kHz to 10 th harmonics but outside authorized operating frequency ranges.	Appendix F	Pass
Field Strength of Spurious Radiation	§2.1051, §27.53(g)	RSS-Gen, §6.13 RSS-130,§4.6	≤ -13 dBm/100 kHz.	Appendix G	Pass
Frequency Stability	§2.1055, §27.54	RSS-Gen, §6.11; RSS-130,§4.3	Within authorized bands of operation/frequency block.	Appendix H	Pass
NOTE: For the verdict, the "N/A" denotes "not applicable", the "N/T" denotes "not tested".					

3.6 Band17 (704-716MHz paired with 734-746 MHz)

Test Item	FCC Rule No.	ISED Rule No.	Requirements	Test Result	Verdict (Note1)
Effective (Isotropic) Radiated Power Output Data	§27.50(c).	RSS-Gen, §6.12; RSS-130,§4.4	FCC: ERP ≤ 3 W. ISED: EIRP ≤ 50 W.	Appendix A	Pass
Peak-Average Ratio	§2.1046, §27.50(c)	RSS-130,§4.4	ISED: Limits≤13 dB	Appendix B	Pass
Modulation Characteristics	§2.1047	---	Digital modulation	Appendix C	Pass
Bandwidth	§2.1049	RSS-Gen, §6.7	OBW: No limit. EBW: No limit.	Appendix D	Pass
Band Edges Compliance	§2.1051, §27.53(g)	RSS-Gen, §6.13 RSS-130,§4.6	≤ -13 dBm/30 kHz, in 100 kHz bands immediately outside and adjacent to the frequency blocks.	Appendix E	Pass
Spurious Emission at Antenna Terminals	§2.1051, §27.53(g)	RSS-Gen, §6.13 RSS-130,§4.6	≤ -13 dBm/100 kHz, from 9 kHz to 10 th harmonics but outside authorized operating frequency ranges.	Appendix F	Pass
Field Strength of Spurious Radiation	§2.1051, §27.53(g)	RSS-Gen, §6.13 RSS-130,§4.6	≤ -13 dBm/100 kHz.	Appendix G	Pass
Frequency Stability	§2.1055, §27.54	RSS-Gen, §6.11; RSS-130,§4.3	Within authorized bands of operation/frequency block.	Appendix H	Pass
NOTE: For the verdict, the "N/A" denotes "not applicable", the "N/T" denotes "not tested".					

3.7 Band26 (814-824 MHz paired with 859-869MHz)

Test Item	FCC Rule No.	Requirements	Test Result	Verdict
Transmitter Conducted Power Output	§2.1046, §90.635	< 100 W.	Appendix A	PASS
Peak-Average Ratio	---	---	Appendix B	N/T
Modulation Characteristics	§2.1047	Digital modulation	Appendix C	PASS
Bandwidth	§2.1049	OBW: No limit. EBW: No limit.	Appendix D	PASS
Band Edges Compliance	§2.1051, §90.691	< 50 + 10Log10(P[Watts]) at Band Edge and for all out-of-band emissions within 37.5kHz of Block Edge	Appendix E	PASS
Spurious Emission at Antenna Terminals	§2.1051, §90.691	< 43 + 10Log10(P[Watts]) for all out-of-band emissions	Appendix F	PASS
Field Strength of Spurious Radiation	§2.1053, §90.691	< 43 + 10Log10(P[Watts]) for all out-of-band emissions	Appendix G	PASS
Frequency Stability	§2.1055, §90.213	< ±2.5ppm.	Appendix H	PASS
NOTE: For the verdict, the "N/A" denotes "not applicable", the "N/T" denotes "not tested".				

3.8 BRS&EBS Band38&CA_38C (2570-2620 MHz paired with 2570-2620 MHz)

Test Item	FCC Rule No.	ISED Rule No.	Requirements	Test Result	Verdict (Note1)
Effective (Isotropic) Radiated Power Output Data	§2.1046, §27.50(h)	RSS-Gen, §6.12; RSS-199, §4.4	EIRP ≤ 2W	Appendix A	Pass
Peak-Average Ratio	§27.50(a)	RSS-199, §4.4	Limit ≤ 13 dB	Appendix B	Pass
Modulation Characteristics	§2.1047	RSS-199, §4.1	Digital modulation	Appendix C	Pass
Bandwidth	§2.1049	RSS-Gen, §6.7	OBW: No limit. EBW: No limit.	Appendix D	Pass
Band Edges Compliance	§2.1051, §27.53(m4)	RSS-Gen, §6.13; RSS-199, §4.5; RSS-199, §4.2	<p>FCC:</p> <p>AND</p> <p>AND, if 2495-2496MHz is immediately outside and adjacent to the frequency block</p> <p>Note 1): EBW is -26 dBc EBW.</p> <p>ISED:</p>	Appendix E	Pass

Test Item	FCC Rule No.	ISED Rule No.	Requirements	Test Result	Verdict (Note1)
<p>Spurious Emission at Antenna Terminals</p>	<p>§2.1051, §27.53(m)</p>	<p>RSS-Gen, §6.13; RSS-199, §4.5; RSS-199, §4.2</p>	<p>FCC:</p> <p>AND</p> <p>Fa = max(lowest internal frequency, 9 kHz) Fb = min(10 * highest fundamental frequency, 40 GHz)</p> <p>Note 1): EBW is -26 dBc EBW. Note 2): MeasFrom: max(lowest internal frequency, 9 kHz). Note 3): MeasTo: min(10 * highest fundamental frequency, 40 GHz).</p> <p>ISED:</p> <p>AND</p> <p>Fa = max(min(lowest internal frequency, 30 MHz), 9 kHz). Fb = min(10 * highest fundamental frequency, 40 GHz).</p> <p>Note 1): MeasFrom: max(min(lowest internal frequency, 30 MHz), 9 kHz). Note 2): MeasTo: min(10 * highest fundamental frequency, 40 GHz).</p>	<p>Appendix F</p>	<p>Pass</p>
<p>Field Strength of Spurious Radiation</p>	<p>§2.1053, §27.53(m)</p>	<p>RSS-Gen, §6.13; RSS-199, §4.5</p>	<p>FCC:</p>	<p>Appendix G</p>	<p>Pass</p>

Test Item	FCC Rule No.	ISED Rule No.	Requirements	Test Result	Verdict (Note1)
			<div style="text-align: center;"> <p>Channel Edge</p> <p>-25 dBm/1 MHz -25 dBm/1 MHz</p> <p>Fa -X 0 0 X Fb</p> <p>X = max (6 MHz, EBW)</p> <p>AND</p> <p>Fa 2490.5 2500 2690 / MHz</p> <p>Eg = max(lowest internal frequency, 9 kHz) Fb = min(10 * highest fundamental frequency, 40 GHz)</p> </div> <p>Note 1): EBW is -26 dBc EBW.</p> <p>Note 2): MeasFrom: max(lowest internal frequency, 9 kHz).</p> <p>Note 3): MeasTo: min(10 * highest fundamental frequency, 40 GHz).</p> <p>ISED:</p> <div style="text-align: center;"> <p>Channel Edge</p> <p>-25 dBm/1 MHz -25 dBm/1 MHz</p> <p>Fa -X 0 0 X Fb</p> <p>X = max (6 MHz, OBW)</p> <p>AND</p> <p>Fa 2490.5 2500 2690 / MHz</p> <p>Fa = max(min(lowest internal frequency, 30 MHz), 9 kHz). Fb = min(10 * highest fundamental frequency, 40 GHz).</p> </div> <p>Note 1): MeasFrom: max(min(lowest internal frequency, 30 MHz), 9 kHz).</p> <p>Note 2): MeasTo: min(10 * highest fundamental frequency, 40 GHz).</p>		
Frequency Stability	§2.1055, §27.54	RSS-Gen, §6.11; RSS-199, §4.3	Within authorized bands of operation/frequency block.	Appendix H	Pass
NOTE: For the verdict, the "N/A" denotes "not applicable", the "N/T" denotes "not tested".					

3.9 WCS Band40 (2305-2315 MHz and 2350-2360 MHz)

Test Item	ISED Rule No.	Requirements	Test Result	Verdict (Note1)
Effective (Isotropic) Radiated Power Output Data	RSS-Gen, §6.12; RSS-195, §5.5	ISED: RMS EIRP PD: ≤ 250 mW/5 MHz (for LTE; and for 2305-2315MHz, 2350-2360MHz).	Appendix A	Pass
Peak-Average Ratio	RSS-195, §5.5.1	Limits ≤ 13 dB	Appendix B	Pass
Modulation Characteristics	RSS-195, §5.3	Digital modulation	Appendix C	Pass
Bandwidth	RSS-Gen, §6.7 RSS-195, §5.6	OBW: No limit. EBW: No limit.	Appendix D	Pass
Band Edges Compliance	RSS-Gen, §6.13; RSS-195, §5.6	ISED: ≤ -13 dBm, in 1 MHz range (integrated with RBW $\geq 1\% \cdot$ OBW) outside operating frequency ranges.	Appendix E	Pass
Spurious Emission at Antenna Terminals	RSS-Gen, §6.13 RSS-195, §5.6	<p> $-13\text{dBm}/1\text{M}$ $-25\text{dBm}/1\text{M}$ $-31\text{dBm}/1\text{M}$ $-37\text{dBm}/1\text{M}$ $-40\text{dBm}/1\text{M}$ </p> <p> $F_a = \max(\text{lowest internal frequency, } 9 \text{ kHz})$ $F_b = \min(10 \cdot \text{highest fundamental frequency, } 40 \text{ GHz})$ </p>	Appendix F	Pass
Field Strength of Spurious Radiation	RSS-Gen, §6.13 RSS-195, §5.6	≤ -13 dBm/1 MHz.	Appendix G	Pass
Frequency Stability	RSS-Gen, §6.11 RSS-195, §5.4	within the range of the operating frequency blocks	Appendix H	Pass
NOTE: For the verdict, the "N/A" denotes "not applicable", the "N/T" denotes "not tested".				

3.10 Band41&CA_41C (2545-2655 MHz paired with 2545-2655 MHz)

Test Item	FCC Rule No.	ISED Rule No.	Requirements	Test Result	Verdict (Note1)
Effective (Isotropic) Radiated Power Output Data	§2.1046, §27.50(h)	RSS-Gen, §6.12; RSS-199, §4.4	EIRP ≤ 2W	Appendix A	Pass
Peak-Average Ratio	§27.50(a)	RSS-199, §4.4	Limit ≤ 13 dB	Appendix B	Pass
Modulation Characteristics	§2.1047	RSS-199, §4.1	Digital modulation	Appendix C	Pass
Bandwidth	§2.1049	RSS-Gen, §6.7	OBW: No limit. EBW: No limit.	Appendix D	Pass
Band Edges Compliance	§2.1051, §27.53(m4)	RSS-Gen, §6.13; RSS-199, §4.5; RSS-199, §4.2	<p>FCC:</p> <p>AND</p> <p>AND, if 2495-2496MHz is immediately outside and adjacent to the frequency block</p> <p>Note 1): EBW is -26 dBc EBW.</p> <p>ISED:</p> <p>AND</p>	Appendix E	Pass

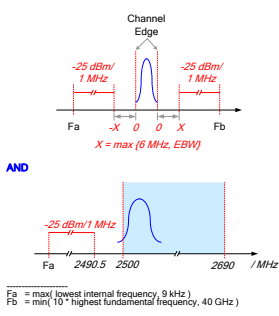
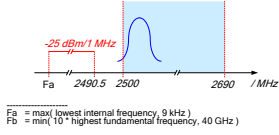
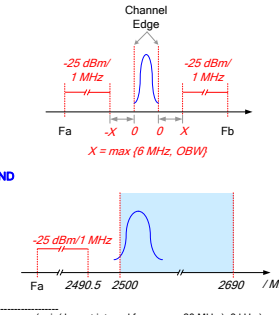
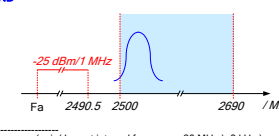
Test Item	FCC Rule No.	ISED Rule No.	Requirements	Test Result	Verdict (Note1)
<p>Spurious Emission at Antenna Terminals</p>	<p>§2.1051, §27.53(m)</p>	<p>RSS-Gen, §6.13; RSS-199, §4.5; RSS-199, §4.2</p>	<p>FCC:</p>  <p>AND</p>  <p>Fa = max(lowest internal frequency, 9 kHz) Fb = min(10 * highest fundamental frequency, 40 GHz)</p> <p>Note 1): EBW is -26 dBc EBW. Note 2): MeasFrom: max(lowest internal frequency, 9 kHz). Note 3): MeasTo: min(10 * highest fundamental frequency, 40 GHz).</p> <p>ISED:</p>  <p>AND</p>  <p>Fa = max(min(lowest internal frequency, 30 MHz), 9 kHz). Fb = min(10 * highest fundamental frequency, 40 GHz).</p> <p>Note 1): MeasFrom: max(min(lowest internal frequency, 30 MHz), 9 kHz). Note 2): MeasTo: min(10 * highest fundamental frequency, 40 GHz).</p>	<p>Appendix F</p>	<p>Pass</p>
<p>Field Strength of Spurious Radiation</p>	<p>§2.1053, §27.53(m)</p>	<p>RSS-Gen, §6.13; RSS-199, §4.5</p>	<p>FCC:</p>	<p>Appendix G</p>	<p>Pass</p>

Test Item	FCC Rule No.	ISED Rule No.	Requirements	Test Result	Verdict (Note1)
			<div style="text-align: center;"> <p>Channel Edge</p> <p>-25 dBm/1 MHz</p> <p>-25 dBm/1 MHz</p> <p>Fa -X 0 X Fb</p> <p>X = max(6 MHz, EBW)</p> <p>AND</p> <p>-25 dBm/1 MHz</p> <p>Fa 2490.5 2500 2690 / MHz</p> <p>Fa = max(lowest internal frequency, 9 kHz) Fb = min(10 * highest fundamental frequency, 40 GHz)</p> </div> <p>Note 1): EBW is -26 dBc EBW.</p> <p>Note 2): MeasFrom: max(lowest internal frequency, 9 kHz).</p> <p>Note 3): MeasTo: min(10 * highest fundamental frequency, 40 GHz).</p> <p>ISED:</p> <div style="text-align: center;"> <p>Channel Edge</p> <p>-25 dBm/1 MHz</p> <p>-25 dBm/1 MHz</p> <p>Fa -X 0 X Fb</p> <p>X = max(6 MHz, OBW)</p> <p>AND</p> <p>-25 dBm/1 MHz</p> <p>Fa 2490.5 2500 2690 / MHz</p> <p>Fa = max(min(lowest internal frequency, 30 MHz), 9 kHz). Fb = min(10 * highest fundamental frequency, 40 GHz).</p> </div> <p>Note 1): MeasFrom: max(min(lowest internal frequency, 30 MHz), 9 kHz).</p> <p>Note 2): MeasTo: min(10 * highest fundamental frequency, 40 GHz).</p>		
Frequency Stability	§2.1055, §27.54	RSS-Gen, §6.11; RSS-199, §4.3	Within authorized bands of operation/frequency block.	Appendix H	Pass
NOTE: For the verdict, the "N/A" denotes "not applicable", the "N/T" denotes "not tested".					

3.11 Band 66 (1710-1780 MHz paired with 2110-2175 MHz)

Test Item	FCC Rule No.	ISED Rule No.	Requirements	Test Result	Verdict (Note1)
Effective (Isotropic) Radiated Power Output Data	§2.1046, §27.50(d)	RSS-Gen, §6.12; RSS-139, §6.4	EIRP ≤ 1 W	Appendix A	Pass
Peak-Average Ratio	§2.1046, §27.50(d)	RSS-139, §6.4	Limit≤13 dB	Appendix B	Pass
Modulation Characteristics	§2.1047	RSS-139, §6.2	Digital modulation	Appendix C	Pass
Bandwidth	§2.1049	RSS-Gen, §6.7	OBW: No limit. EBW: No limit.	Appendix D	Pass
Band Edges Compliance	§2.1051, §27.53(h)	RSS-Gen, §6.13; RSS-139, §6.5	FCC: ≤ -13 dBm/1%*EBW, in 1 MHz bands immediately outside and adjacent to the frequency block. Note 1): EBW is -26 dBc EBW. ISED: ≤ -13 dBm/1%*EBW, in 1 MHz bands immediately outside and adjacent to the frequency block. Note 1): EBW is not defined.	Appendix E	Pass
Spurious Emission at Antenna Terminals	§2.1051, §27.53(h)	RSS-Gen, §6.13; RSS-139, §6.5	FCC: ≤ -13 dBm/1 MHz, from max(lowest internal frequency, 9 kHz) to min(10 * highest fundamental frequency, 40 GHz) but outside authorized operating frequency ranges. ISED: ≤ -13 dBm/1 MHz, from max(min(lowest internal frequency, 30 MHz), 9 kHz) to min(10 * highest fundamental frequency, 40 GHz) but outside authorized operating frequency ranges.	Appendix F	Pass
Field Strength of Spurious Radiation	§2.1053, §27.53(h)	RSS-Gen, §6.13; RSS-139,	FCC: ≤ -13 dBm/1 MHz, from max(lowest internal frequency, 9 kHz) to min(10 * highest	Appendix G	Pass

Test Item	FCC Rule No.	ISED Rule No.	Requirements	Test Result	Verdict (Note1)
		§6.5	<p>fundamental frequency, 40 GHz) but outside authorized operating frequency ranges.</p> <p>ISED: ≤ -13 dBm/1 MHz, from max(min(lowest internal frequency, 30 MHz), 9 kHz) to min(10 * highest fundamental frequency, 40 GHz) but outside authorized operating frequency ranges.</p>		
Frequency Stability	§2.1055, §27.54	RSS-Gen, §6.11; RSS-139, §6.3	Within authorized bands of operation/frequency block.	Appendix H	Pass
NOTE: For the verdict, the "N/A" denotes "not applicable", the "N/T" denotes "not tested".					

4 Description of the Equipment under Test (EUT)

4.1 General Description

VOG-L04 is a subscriber equipment in the GSM/WCDMA/LTE system. The GSM frequency band includes GSM850 and GSM900 and DCS1800 and PCS1900. The UMTS frequency band is B1 and B2 and B4 and B5 and B6 and B8 and B19. The LTE frequency band is B1 and B2 and B3 and B4 and B5 and B6 and B7 and B8 and B9 and B12 and B17 and B18 and B19 and B20 and B26 and B28 and B34 and B38 and B39 and B40 and B41 and B66. The Mobile Phone implements such functions as RF signal receiving/transmitting, LTE/HSPA/UMTS and GSM/GPRS/EDGE protocol processing, voice, video MMS service, GPS, Bluetooth, NFC, Wi-Fi and Wirelessly Charging etc. VOG-L04 provides one USIM card interface and one HUAWEI Nano memory card interface. Externally it provides type C USB charging port, and the port could be used as the earphone port or data-transfer port.

Note1: Only GSM850/1900, UMTS Band II/IV/V, LTE Band 2/4/5/7/12/17/26/38/40/41/66 & intra-band CA_7C/38C/41C test data included in this report.

Note2: LTE Band 40 only apply for ISED and LTE Band 26 only apply for FCC.















4.2 EUT Identity

NOTE: Unless otherwise noted in the report, the functional boards installed in the units shall be selected from the below list, but not means all the functional boards listed below shall be installed in one unit.

4.2.1 Board

Board		
Description	Software Version	Hardware Version
Main Board	9.1.0.42(C792E10R1P4)	HL2VOGUEM

4.2.2 Sub-Assembly

Sub-Assembly			
Sub-Assembly Name	Model	Manufacturer	Description
Adapter	HW-100400A00	Huawei Technologies Co., Ltd.	Input voltage: 100-240V ~50/60Hz 1.2A Output voltage: 5V  2A OR 9V  2A OR 10V  4A
Adapter	HW-100400U00	Huawei Technologies Co., Ltd.	Input voltage: 100-240V ~50/60Hz 1.2A Output voltage: 5V  2A OR 9V  2A OR 10V  4A
Adapter	HW-100400E00	Huawei Technologies Co., Ltd.	Input voltage: 100-240V ~50/60Hz 1.2A Output voltage: 5V  2A OR 9V  2A OR 10V  4A
Adapter	HW-100400B00	Huawei Technologies Co., Ltd.	Input voltage: 100-240V ~50/60Hz 1.2A Output voltage: 5V  2A OR 9V  2A OR 10V  4A
Battery	HB486486ECW	Huawei Technologies Co., Ltd.	Rated capacity: 4100mAh Nominal Voltage:  +3.82V Charging Voltage:  +4.4V

4.3 Technical Specification

NOTE: For the detailed technical descriptions, see the applicant/manufacturer's specifications or user manual.

4.3.1 General

Characteristics	Description	
Radio System Type	<input checked="" type="checkbox"/> GSM <input checked="" type="checkbox"/> UMTS <input checked="" type="checkbox"/> LTE	
Supported Frequency Range	GSM850/ WCDMA850	Transmission (TX): 824 to 849 MHz
		Receiving (RX): 869 to 894 MHz
	PCS1900/ WCDMA1900	Transmission (TX): 1850 to 1910 MHz
		Receiving (RX): 1930 to 1990 MHz
	WCDMA1700	Transmission (TX): 1710 to 1755 MHz
		Receiving (RX): 2110 to 2155 MHz
	LTE BAND2	Transmission (TX): 1850 to 1910 MHz
		Receiving (RX): 1930 to 1990 MHz
	LTE BAND4	Transmission (TX): 1710 to 1755 MHz
		Receiving (RX): 2110 to 2155 MHz
	LTE BAND5	Transmission (TX): 824 to 849 MHz
		Receiving (RX): 869 to 894 MHz
	LTE BAND7	Transmission (TX): 2500 to 2570 MHz
		Receiving (RX): 2620 to 2690 MHz
	LTE BAND12	Transmission (TX): 699 to 716 MHz
		Receiving (RX): 729 to 746 MHz
	LTE BAND17	Transmission (TX): 704 to 716 MHz
		Receiving (RX): 734 to 746 MHz
LTE band 26(814 to 824MHz) only apply for FCC.	Transmission (TX): 814 to 824MHz	
	Receiving (RX): 859 to 869 MHz	
LTE band 26 (824 to 849 MHz) only apply for FCC	Transmission (TX): 824 to 849 MHz	
	Receiving (RX): 869 to 894 MHz	
LTE BAND38	Transmission (TX): 2570 to 2620 MHz	
	Receiving (RX): 2570 to 2620 MHz	
LTE Band 40(2305 to 2315 MHz) only apply for ISED	Transmission (TX): 2305 to 2315 MHz	
	Receiving (RX): 2305 to 2315 MHz	
LTE Band 40(2350 to 2360 MHz) only apply for ISED	Transmission (TX): 2350 to 2360 MHz	
	Receiving (RX): 2350 to 2360 MHz	

Characteristics	Description	
	LTE Band 41(2535 to 2655 MHz)	Transmission (TX): 2535 to 2655 MHz
		Receiving (RX): 2535 to 2655 MHz
	LTE Band 66	Transmission (TX): 1710 to 1780 MHz
		Receiving (RX): 2110 to 2175 MHz
	CA_Band_CA_7C	Transmission (TX): 2500 to 2570 MHz
		Receiving (RX): 2620 to 2690 MHz
	CA_Band_CA_38C	Transmission (TX): 2750 to 2620 MHz
		Receiving (RX): 2570 to 2620 MHz
	CA_Band_CA_41C	Transmission (TX): 2535 to 2655 MHz
		Receiving (RX): 2535 to 2655 MHz
Antenna	Description	Isotropic Antenna
	Type	<input checked="" type="checkbox"/> Integral <input type="checkbox"/> External <input type="checkbox"/> Dedicated
	TX and RX Antenna Ports(one band)	TX & RX port: 1 TX-only port: 0 RX-only port: band2/4/7/66 3; Others : 1
	Smart Antenna(for uplink)	<input type="checkbox"/> MIMO <input checked="" type="checkbox"/> Non MIMO
	Gain	GSM850: -4.99 dBi (per antenna port, max) PCS1900: -2.47 dBi (per antenna port, max) WCDMA 850: -5.13 dBi (per antenna port, max) WCDMA 1700: -1 dBi (per antenna port, max) WCDMA 1900: -2.34 dBi (per antenna port, max) LTE Band 2: -1.66 dBi (per antenna port, max) LTE Band 4: -0.68 dBi (per antenna port, max) LTE Band 5: -4.73 dBi (per antenna port, max) LTE Band 7: 0.73 dBi (per antenna port, max) LTE Band 12: -4.99 dBi (per antenna port, max) LTE Band 17:-5.18 dBi (per antenna port, max) LTE Band 26 : -4.76 dBi (per antenna port, max) TE Band 38: 0.03 dBi (per antenna port, max) LTE Band 40: 0.51 dBi (per antenna port, max) LTE Band 41: 0.11 dBi (per antenna port, max) LTE Band 66: -0.68 dBi (per antenna port, max) CA_Band_CA_7C :0.73 dBi (per antenna port, max) CA_Band_CA_38C: 0.03 dBi (per antenna port, max) CA_Band_CA_41C: 0.11 dBi (per antenna port, max)
	Remark	When the EUT is put into service, the practical maximum antenna gain should NOT exceed the

Characteristics	Description	
		value as described above.
Target TX Output Power	GSM850: 33dBm GSM1900 30 dBm UMTS850 24dBm UMTS1900: 24dBm UMTS1700 24dBm LTE BAND2: 23.5dBm LTE BAND4: 24 dBm LTE BAND5: 24dBm LTE BAND7: 23.5dBm LTE BAND12: 24dBm LTE BAND17: 24dBm LTE BAND26: 24dBm LTE BAND38: 24dBm LTE BAND40: 22.5dBm LTE BAND41: 24dBm LTE BAND66: 23dBm CA_Band_CA_7C 23.5dBm CA_Band_CA_38C 24dBm CA_Band_CA_41C 24dBm	
Supported Channel Bandwidth	GSM system:	<input checked="" type="checkbox"/> 200 kHz
	UMTS system:	<input checked="" type="checkbox"/> 5 MHz
	LTE band 2	<input checked="" type="checkbox"/> 1.4MHz, <input checked="" type="checkbox"/> 3MHz, <input checked="" type="checkbox"/> 5MHz, <input checked="" type="checkbox"/> 10MHz , <input checked="" type="checkbox"/> 15MHz , <input checked="" type="checkbox"/> 20MHz
	LTE band 4	<input checked="" type="checkbox"/> 1.4MHz, <input checked="" type="checkbox"/> 3MHz, <input checked="" type="checkbox"/> 5MHz, <input checked="" type="checkbox"/> 10MHz , <input checked="" type="checkbox"/> 15MHz , <input checked="" type="checkbox"/> 20MHz
	LTE band 5	<input checked="" type="checkbox"/> 1.4MHz, <input checked="" type="checkbox"/> 3MHz, <input checked="" type="checkbox"/> 5MHz, <input checked="" type="checkbox"/> 10MHz
	LTE band 7	<input checked="" type="checkbox"/> 5MHz, <input checked="" type="checkbox"/> 10MHz , <input checked="" type="checkbox"/> 15MHz , <input checked="" type="checkbox"/> 20MHz
	LTE band 12	<input checked="" type="checkbox"/> 1.4MHz, <input checked="" type="checkbox"/> 3MHz, <input checked="" type="checkbox"/> 5MHz, <input checked="" type="checkbox"/> 10MHz
	LTE band 17	<input checked="" type="checkbox"/> 5MHz, <input checked="" type="checkbox"/> 10MHz
	LTE BAND26(814 to 824 MHz) only apply for FCC	<input checked="" type="checkbox"/> 1.4MHz, <input checked="" type="checkbox"/> 3MHz, <input checked="" type="checkbox"/> 5MHz, <input checked="" type="checkbox"/> 10MHz
	LTE band26(824 to 849 MHz) only apply for FCC	<input checked="" type="checkbox"/> 1.4MHz, <input checked="" type="checkbox"/> 3MHz, <input checked="" type="checkbox"/> 5MHz, <input checked="" type="checkbox"/> 10MHz , <input checked="" type="checkbox"/> 15MHz
	LTE band 38	<input checked="" type="checkbox"/> 5MHz, <input checked="" type="checkbox"/> 10MHz , <input checked="" type="checkbox"/> 15MHz , <input checked="" type="checkbox"/> 20MHz
	LTE band 40	<input checked="" type="checkbox"/> 5MHz, <input checked="" type="checkbox"/> 10MHz
	LTE band 41	<input checked="" type="checkbox"/> 5MHz, <input checked="" type="checkbox"/> 10MHz , <input checked="" type="checkbox"/> 15MHz , <input checked="" type="checkbox"/> 20MHz
	LTE band 66	<input checked="" type="checkbox"/> 1.4MHz, <input checked="" type="checkbox"/> 3MHz, <input checked="" type="checkbox"/> 5MHz, <input checked="" type="checkbox"/> 10MHz , <input checked="" type="checkbox"/> 15MHz , <input checked="" type="checkbox"/> 20MHz
	CA_Band_CA_7C	<input checked="" type="checkbox"/> 10MHz+20MHz, <input checked="" type="checkbox"/> 15MHz+15MHz, <input checked="" type="checkbox"/> 15MHz+20MHz, <input checked="" type="checkbox"/> 20MHz+20MHz

Characteristics	Description	
	CA_Band_CA_38C	<input checked="" type="checkbox"/> 15MHz+15MHz, 20MHz+20MHz,
	CA_Band_CA_41C	<input checked="" type="checkbox"/> 5MHz+20MHz, <input checked="" type="checkbox"/> 10MHz+20MHz, <input checked="" type="checkbox"/> 15MHz+15MHz, <input checked="" type="checkbox"/> 20MHz+20MHz
Type of Modulation for uplink	GSM	<input checked="" type="checkbox"/> GMSK <input checked="" type="checkbox"/> 8PSK
	WCDMA	<input checked="" type="checkbox"/> QPSK <input checked="" type="checkbox"/> 16QAM(only for HSPA+) <input type="checkbox"/> 64QAM
	LTE	<input checked="" type="checkbox"/> QPSK <input checked="" type="checkbox"/> 16QAM <input checked="" type="checkbox"/> 64QAM
Designation of Emissions (Note: the necessary bandwidth of which is the worst value from the measured occupied bandwidths for each type of channel bandwidth configuration.)	GSM850:	248KGXW, 249KG7W
	GSM1900:	246KGXW, 253KG7W
	UMTS850:	4M16F9W
	UMTS1900:	4M17F9W
	UMTS1700:	4M17F9W
	LTE BAND2:	1M10G7D (1.4 MHz QPSK modulation), 1M10W7D (1.4 MHz 16QAM modulation) 2M72G7D (3 MHz QPSK modulation), 2M72W7D (3 MHz 16QAM modulation) 4M52G7D (5 MHz QPSK modulation), 4M52W7D (5 MHz 16QAM modulation) 9M02G7D (10 MHz QPSK modulation), 9M02W7D (10 MHz 16QAM modulation) 13M5G7D (15 MHz QPSK modulation), 13M5W7D (15 MHz 16QAM modulation) 18M0G7D (20 MHz QPSK modulation), 18M1W7D (20 MHz 16QAM modulation)
	LTE BAND4:	1M10G7D (1.4 MHz QPSK modulation), 1M10W7D (1.4 MHz 16QAM modulation) 2M71G7D (3 MHz QPSK modulation), 2M72W7D (3 MHz 16QAM modulation) 4M52G7D (5 MHz QPSK modulation), 4M51W7D (5 MHz 16QAM modulation) 9M02G7D (10 MHz QPSK modulation), 9M01W7D (10 MHz 16QAM modulation) 13M5G7D (15 MHz QPSK modulation), 13M5W7D (15 MHz 16QAM modulation) 18M0G7D (20 MHz QPSK modulation), 18M0W7D (20 MHz 16QAM modulation)
LTE BAND5:	1M10G7D (1.4 MHz QPSK modulation), 1M10W7D (1.4 MHz 16QAM modulation)	

Characteristics	Description	
		2M71G7D (3 MHz QPSK modulation), 2M71W7D (3 MHz 16QAM modulation) 4M51G7D (5 MHz QPSK modulation), 4M52W7D (5 MHz 16QAM modulation) 9M02G7D (10 MHz QPSK modulation), 9M00W7D (10 MHz 16QAM modulation)
	LTE BAND7:	4M52G7D (5 MHz QPSK modulation), 4M52W7D (5 MHz 16QAM modulation) 9M02G7D (10 MHz QPSK modulation), 9M00W7D (10 MHz 16QAM modulation) 13M5G7D (15 MHz QPSK modulation), 13M5W7D (15 MHz 16QAM modulation) 18M0G7D (20 MHz QPSK modulation), 18M0W7D (20 MHz 16QAM modulation)
	LTE BAND12:	1M09G7D (1.4 MHz QPSK modulation), 1M09W7D (1.4 MHz 16QAM modulation) 2M71G7D (3 MHz QPSK modulation), 2M72W7D (3 MHz 16QAM modulation) 4M52G7D (5 MHz QPSK modulation), 4M52W7D (5 MHz 16QAM modulation) 9M01G7D (10 MHz QPSK modulation), 9M00W7D (10 MHz 16QAM modulation)
	LTE BAND17:	4M51G7D (5 MHz QPSK modulation), 4M52W7D (5 MHz 16QAM modulation) 9M03G7D (10 MHz QPSK modulation), 9M03W7D (10 MHz 16QAM modulation)
	LTE BAND26: 814-824	1M10G7D (1.4 MHz QPSK modulation), 1M10W7D (1.4 MHz 16QAM modulation) 2M71G7D (3 MHz QPSK modulation), 2M71W7D (3 MHz 16QAM modulation) 4M52G7D (5 MHz QPSK modulation), 4M51W7D (5 MHz 16QAM modulation) 9M00G7D (10 MHz QPSK modulation), 9M02W7D (10 MHz 16QAM modulation)
	LTE BAND26: 824-849	1M10G7D (1.4 MHz QPSK modulation), 1M10W7D (1.4 MHz 16QAM modulation) 2M71G7D (3 MHz QPSK modulation), 2M72W7D (3 MHz 16QAM modulation) 4M51G7D (5 MHz QPSK modulation), 4M52W7D (5 MHz 16QAM modulation) 8M99G7D (10 MHz QPSK modulation), 9M00W7D (10 MHz 16QAM modulation) 13M5G7D (15 MHz QPSK modulation),

Characteristics	Description	
		13M5W7D (15 MHz 16QAM modulation)
	LTE BAND38:	4M51G7D (5 MHz QPSK modulation), 4M51W7D (5 MHz 16QAM modulation) 9M01G7D (10 MHz QPSK modulation), 9M01W7D (10 MHz 16QAM modulation) 13M5G7D (15 MHz QPSK modulation), 13M5W7D (15 MHz 16QAM modulation) 18M1G7D (20 MHz QPSK modulation), 18M0W7D (20 MHz 16QAM modulation)
	LTE BAND40: (2305-2315MHz)	4M51G7D (5 MHz QPSK modulation), 4M50W7D (5 MHz 16QAM modulation) 8M99G7D (10 MHz QPSK modulation), 8M99W7D (10 MHz 16QAM modulation)
	LTE BAND40: (2350-2360MHz)	4M51G7D (5 MHz QPSK modulation), 4M52W7D (5 MHz 16QAM modulation) 9M03G7D (10 MHz QPSK modulation), 9M00W7D (10 MHz 16QAM modulation)
	LTE BAND41:	4M50G7D (5 MHz QPSK modulation), 4M51W7D (5 MHz 16QAM modulation) 9M00G7D (10 MHz QPSK modulation), 9M02W7D (10 MHz 16QAM modulation) 13M5G7D (15 MHz QPSK modulation), 13M5W7D (15 MHz 16QAM modulation) 18M0G7D (20 MHz QPSK modulation), 18M0W7D (20 MHz 16QAM modulation)
	LTE BAND66	1M10G7D (1.4 MHz QPSK modulation), 1M10W7D (1.4 MHz 16QAM modulation) 2M71G7D (3 MHz QPSK modulation), 2M72W7D (3 MHz 16QAM modulation) 4M52G7D (5 MHz QPSK modulation), 4M52W7D (5 MHz 16QAM modulation) 9M00G7D (10 MHz QPSK modulation), 9M03W7D (10 MHz 16QAM modulation) 13M5G7D (15 MHz QPSK modulation), 13M6W7D (15 MHz 16QAM modulation) 18M0G7D (20 MHz QPSK modulation), 18M0W7D (20 MHz 16QAM modulation)
	CA_Band_CA_7C	29M0G7D (15 MHz+15 MHz QPSK modulation), 29M0W7D (15 MHz+15 MHz 16QAM modulation) 38M5G7D (20 MHz+20 MHz QPSK modulation), 38M5W7D (20 MHz+20 MHz 16QAM modulation)
	CA_Band_CA_38C	29M1G7D (15 MHz+15 MHz QPSK modulation),

Characteristics	Description	
		29M1W7D (15 MHz+15 MHz 16QAM modulation) 38M5G7D (20 MHz+20 MHz QPSK modulation), 38M6W7D (20 MHz+20 MHz 16QAM modulation)
	CA_Band_CA_41C	29M1G7D (15 MHz+15 MHz QPSK modulation), 29M0W7D (15 MHz+15 MHz 16QAM modulation) 38M6G7D (20 MHz+20 MHz QPSK modulation), 38M7W7D (20 MHz+20 MHz 16QAM modulation)

5 General Test Conditions / Configurations

5.1 Test Modes

NOTE1: The test mode(s) are selected according to relevant radio technology specifications.

NOTE2: The modulation for WCDMA, HSUPA, HSDPA, DC-HSDPA is the same, which is QPSK, and the WCDMA is the worst, so we test the WCDMA only.

NOTE3: The power of HSPA+ system with 16QAM modulation is lower than that of QPSK, so we did not test 16QAM modulation.

NOTE4: The power of LTE system 64QAM modulation is lower than that of 16QAM, so we did not test 64QAM modulation.

Test Mode	Test Modes Description
GSM/TM1	GSM system, GSM/GPRS, GMSK modulation
GSM/TM2	GSM system, EDGE, 8PSK modulation
UMTS/TM1	WCDMA system, QPSK modulation
LTE/TM1	LTE system, QPSK modulation
LTE/TM2	LTE system, 16QAM modulation

5.2 Test Frequency

Test Mode	TX / RX	RF Channel		
		Low (L)	Middle (M)	High (H)
GSM850	TX	Channel 128	Channel 190	Channel 251
		824.2MHz	836.6MHz	848.8MHz
	RX	Channel 128	Channel 190	Channel 251
		869.2MHz	881.6MHz	893.8MHz
WCDMA850	TX	Channel 4132	Channel 4182	Channel 4233
		826.4MHz	836.4MHz	846.6MHz
	RX	Channel 4357	Channel 4407	Channel 4458
		871.4MHz	881.4MHz	891.6MHz
Test Mode	TX / RX	RF Channel		
		Low (L)	Middle (M)	High (H)
GSM1900	TX	Channel 512	Channel 661	Channel 810
		1850.2MHz	1880.0MHz	1909.8MHz
	RX	Channel 512	Channel 661	Channel 810
		1930.2 MHz	1960.0 MHz	1989.8 MHz
WCDMA1900	TX	Channel 9262	Channel9400	Channel9538
		1852.4MHz	1880.0MHz	1907.6MHz
	RX	Channel 9662	Channel 9800	Channel 9938
		1932.4 MHz	1960.0 MHz	1987.6 MHz
Test Mode	TX / RX	RF Channel		
		Low (L)	Middle (M)	High (H)
WCDMA1700	TX	Channel1312	Channel1413	Channel1513
		1712.4MHz	1732.6MHz	1752.6MHz

Test Mode	TX / RX	RF Channel		
		Low (L)	Middle (M)	High (H)
	RX	Channel 1537	Channel 1638	Channel 1738
		2112.4 MHz	2132.6 MHz	2152.6 MHz

Test Mode	TX / RX	RF Channel		
		Low (B)	Middle (M)	High (T)
LTE Band 2	TX(1.4M)	Channel 18607	Channel 18900	Channel 19193
		1850.7 MHz	1880 MHz	1909.3 MHz
	TX(3M)	Channel 18615	Channel 18900	Channel 19185
		1851.5 MHz	1880 MHz	1908.5 MHz
	TX(5M)	Channel 18625	Channel 18900	Channel 19175
		1852.5 MHz	1880 MHz	1907.5 MHz
	TX(10M)	Channel 18650	Channel 18900	Channel 19150
		1855 MHz	1880 MHz	1905 MHz
	TX(15M)	Channel 18675	Channel 18900	Channel 19125
		1857.5 MHz	1880 MHz	1902.5 MHz
	TX(20M)	Channel 18700	Channel 18900	Channel 19100
		1860 MHz	1880 MHz	1900 MHz
	RX(1.4M)	Channel 607	Channel 900	Channel 1193
		1930.7 MHz	1960 MHz	1989.3 MHz
	RX(3M)	Channel 615	Channel 900	Channel 1185
		1931.5 MHz	1960 MHz	1988.5 MHz
	RX(5M)	Channel 625	Channel 900	Channel 1175
		1932.5 MHz	1960 MHz	1987.5 MHz
RX(10M)	Channel 650	Channel 900	Channel 1150	

Test Mode	TX / RX	RF Channel		
		Low (B)	Middle (M)	High (T)
		1935 MHz	1960 MHz	1985 MHz
		Channel 675	Channel 900	Channel 1125
	RX(15M)	1937.5 MHz	1960 MHz	1982.5 MHz
		Channel 700	Channel 900	Channel 1100
	RX(20M)	1940 MHz	1960 MHz	1980 MHz

Test Mode	TX / RX	RF Channel		
		Low (B)	Middle (M)	High (T)
LTE Band 4	TX(1.4M)	Channel 19957	Channel 20175	Channel 20393
		1710.7 MHz	1732.5 MHz	1754.3 MHz
	TX(3M)	Channel 19965	Channel 20175	Channel 20385
		1711.5 MHz	1732.5 MHz	1753.5 MHz
	TX(5M)	Channel 19975	Channel 20175	Channel 20375
		1712.5 MHz	1732.5 MHz	1752.5 MHz
	TX(10M)	Channel 20000	Channel 20175	Channel 20350
		1715 MHz	1732.5 MHz	1750 MHz
	TX(15M)	Channel 20025	Channel 20175	Channel 20325
		1717.5 MHz	1732.5 MHz	1747.5 MHz
	TX(20M)	Channel 20050	Channel 20175	Channel 20300
		1720 MHz	1732.5 MHz	1745 MHz
	RX(1.4M)	Channel 1975	Channel 2175	Channel 2375
		2112.5 MHz	2132.5MHz	2152.5 MHz
	RX(3M)	Channel 2000	Channel 2175	Channel 2350
		2115 MHz	2132.5MHz	2150 MHz

Test Mode	TX / RX	RF Channel		
		Low (B)	Middle (M)	High (T)
	RX(5M)	Channel 1975	Channel 2175	Channel 2375
		2112.5 MHz	2132.5MHz	2152.5 MHz
	RX(10M)	Channel 2000	Channel 2175	Channel 2350
		2115 MHz	2132.5MHz	2150 MHz
	RX(15M)	Channel 2025	Channel 2175	Channel 2325
		2117.5 MHz	2132.5MHz	2147.5 MHz
	RX(20M)	Channel 2050	Channel 2175	Channel 2300
		2120 MHz	2132.5MHz	2145 MHz

Test Mode	TX / RX	RF Channel		
		Low (B)	Middle (M)	High (T)
LTE Band 5	TX(1.4M)	Channel 20407	Channel 20525	Channel 20643
		824.7 MHz	836.5 MHz	848.3 MHz
	TX(3M)	Channel 20415	Channel 20525	Channel 20635
		825.5 MHz	836.5 MHz	847.5 MHz
	TX(5M)	Channel 20425	Channel 20525	Channel 20625
		826.5 MHz	836.5 MHz	846.5 MHz
	TX(10M)	Channel 20450	Channel 20525	Channel 20600
		829 MHz	836.5 MHz	844 MHz
	RX(1.4M)	Channel 2407	Channel 2525	Channel 2643
		869.7 MHz	881.5 MHz	893.3 MHz
	RX (3M)	Channel 2415	Channel 2525	Channel 2635
		870.5 MHz	881.5 MHz	892.5 MHz
	RX(5M)	Channel 2425	Channel 2525	Channel 2625

Test Mode	TX / RX	RF Channel		
		Low (B)	Middle (M)	High (T)
		871.5 MHz	881.5 MHz	891.5 MHz
		Channel 2450	Channel 2525	Channel 2600
	RX (10M)	874 MHz	881.5 MHz	889 MHz

Test Mode	TX / RX	RF Channel		
		Low (B)	Middle (M)	High (T)
LTE Band 7	TX (5M)	Channel 20775	Channel 21100	Channel 21425
		2502.5 MHz	2535 MHz	2567.5 MHz
	TX (10M)	Channel 20800	Channel 21100	Channel 21400
		2505 MHz	2535 MHz	2565 MHz
	TX (15M)	Channel 20825	Channel 21100	Channel 21375
		2507.5 MHz	2535 MHz	2562.5 MHz
	TX (20M)	Channel 20850	Channel 21100	Channel 21350
		2510 MHz	2535 MHz	2560 MHz
	RX (5M)	Channel 2775	Channel 3100	Channel 3425
		2622.5 MHz	2655 MHz	2687.5 MHz
	RX (10M)	Channel 2800	Channel 3100	Channel 3400
		2625 MHz	2655 MHz	2685 MHz
	RX (15M)	Channel 2825	Channel 3100	Channel 3375
		2627.5 MHz	2655 MHz	2682.5 MHz
	RX (20M)	Channel 2850	Channel 3100	Channel 3350
		2630 MHz	2655 MHz	2680 MHz

Test frequencies for CA_7C

Range	CC-Combo / N _{RB_agg} [RB]	CC1 Note1					CC2 Note1				
		BW [RB]	NUL	fUL [MHz]	N _{DL}	fDL [MHz]	BW [RB]	NUL	fUL [MHz]	N _{DL}	fDL [MHz]
Low	50+100	50	20805	2505.5	2805	2625.5	100	20949	2519.9	2949	2639.9
		100	20850	2510	2850	2630	50	20994	2524.4	2994	2644.4
	75+75	75	20825	2507.5	2825	2627.5	75	20975	2522.5	2975	2642.5
	75+100	75	20828	2507.8	2828	2627.8	100	20999	2524.9	2999	2644.9
		100	20850	2510	2850	2630	75	21021	2527.1	3021	2647.1
100+100	100	20850	2510	2850	2630	100	21048	2529.8	3048	2649.8	
Mid	50+100	50	21006	2525.6	3006	2645.6	100	21150	2540	3150	2660
		100	21051	2530.1	3051	2650.1	50	21195	2544.5	3195	2664.5
	75+75	75	21025	2527.5	3025	2647.5	75	21175	2542.5	3175	2662.5
	75+100	75	21003	2525.3	3003	2645.3	100	21174	2542.4	3174	2662.4
		100	21026	2527.6	3026	2647.6	75	21197	2544.7	3197	2664.7
100+100	100	21001	2525.1	3001	2645.1	100	21199	2544.9	3199	2664.9	
High	50+100	50	21206	2545.6	3206	2665.6	100	21350	2560	3350	2680
		100	21251	2550.1	3251	2670.1	50	21395	2564.5	3395	2684.5
	75+75	75	21225	2547.5	3225	2667.5	75	21375	2562.5	3375	2682.5
	75+100	75	21179	2542.9	3179	2662.9	100	21350	2560	3350	2680
		100	21201	2545.1	3201	2665.1	75	21372	2562.2	3372	2682.2
100+100	100	21152	2540.2	3152	2660.2	100	21350	2560	3350	2680	

Note 1: Carriers in increasing frequency order.

Test Mode	TX / RX	RF Channel		
		Low (B)	Middle (M)	High (T)
LTE Band 12	TX(1.4M)	Channel 23017	Channel 23095	Channel 23173
		699.7 MHz	707.5 MHz	715.3 MHz
	TX(3M)	Channel 23025	Channel 23095	Channel 23165
		700.5 MHz	707.5 MHz	714.5 MHz
	TX(5M)	Channel 23035	Channel 23095	Channel 23155
		701.5 MHz	707.5 MHz	713.5 MHz
	TX(10M)	Channel 23060	Channel 23095	Channel 23130
		704 MHz	707.5 MHz	711 MHz
	RX(1.4M)	Channel 5017	Channel 5095	Channel 5173

Test Mode	TX / RX	RF Channel			
		Low (B)	Middle (M)	High (T)	
		729.7 MHz	737.5 MHz	745.3 MHz	
		Channel 5025	Channel 5095	Channel 5165	
	RX (3M)	730.5 MHz	737.5 MHz	744.5 MHz	
		Channel 5035	Channel 5095	Channel 5155	
	RX(5M)	731.5 MHz	737.5 MHz	743.5 MHz	
		Channel 5060	Channel 5095	Channel 5130	
		RX (10M)	734 MHz	737.5 MHz	741 MHz

Test Mode	TX / RX	RF Channel		
		Low (B)	Middle (M)	High (T)
LTE Band 17	TX (5M)	Channel 23755	Channel 23790	Channel 23825
		706.5 MHz	710 MHz	713.5 MHz
	TX (10M)	Channel 23780	Channel 23790	Channel 23800
		709 MHz	710 MHz	711 MHz
	RX (5M)	Channel 5755	Channel 5790	Channel 5825
		736.5 MHz	740 MHz	743.5 MHz
	RX (10M)	Channel 5780	Channel 5790	Channel 5800

Test Mode	TX / RX	RF Channel		
		Low (L)	Middle (M)	High (H)
LTE Band 26 (814 to 824 MHz)	TX (1.4M)	Channel 26697	Channel 26740	Channel 26783
		814.7 MHz	819 MHz	823.3 MHz
	TX (3M)	Channel 26705	Channel 26740	Channel 26775
		815.5 MHz	819 MHz	822.5 MHz
	TX (5M)	Channel 26715	Channel 26740	Channel 26765
		816.5 MHz	819 MHz	821.5 MHz
	TX (10M)	Channel 26740	Channel 26740	Channel 26740
		819 MHz	819 MHz	819 MHz
	RX (1.4M)	Channel 8697	Channel 8740	Channel 8783
		859.7 MHz	864 MHz	868.3 MHz
	RX (3M)	Channel 8705	Channel 8740	Channel 8765
		860.5 MHz	864 MHz	867.5 MHz
	RX (5M)	Channel 8715	Channel 8740	Channel 8765
		861.5 MHz	864 MHz	866.5 MHz
	RX (10M)	Channel 8740	Channel 8740	Channel 8740
		864 MHz	864 MHz	864 MHz

Test Mode	TX / RX	RF Channel		
		Low (L)	Middle (M)	High (H)
LTE Band 26 (824 to 849 MHz)	TX (1.4M)	Channel 26797	Channel 26915	Channel 27033
		824.7 MHz	836.5 MHz	848.3 MHz
	TX (3M)	Channel 26805	Channel 26915	Channel 27025
		825.5 MHz	836.5 MHz	847.5 MHz

Test Mode	TX / RX	RF Channel		
		Low (L)	Middle (M)	High (H)
	TX (5M)	Channel 26815	Channel 26915	Channel 27015
		826.5 MHz	836.5 MHz	846.5 MHz
	TX (10M)	Channel 26840	Channel 26915	Channel 26990
		829 MHz	836.5 MHz	844 MHz
	TX (15M)	Channel 26865	Channel 26915	Channel 26965
		831.5 MHz	836.5 MHz	841.5 MHz
	RX (1.4M)	Channel 8697	Channel 8915	Channel 9033
		859.7 MHz	881.5 MHz	893.3 MHz
	RX (3M)	Channel 8805	Channel 8915	Channel 9025
		860.5 MHz	881.5 MHz	892.5 MHz
	RX (5M)	Channel 8815	Channel 8915	Channel 9015
		871.5 MHz	881.5 MHz	891.5 MHz
	RX (10M)	Channel 8840	Channel 8915	Channel 8990
		874 MHz	881.5 MHz	889 MHz
	RX (15M)	Channel 8865	Channel 8915	Channel 8965
		876.5 MHz	881.5 MHz	886.5 MHz

Test Mode	TX / RX	RF Channel		
		Low (B)	Middle (M)	High (T)
LTE Band 38	TX(5M)	Channel 37775	Channel 38000	Channel 38225
		2572.5 MHz	2595 MHz	2617.5 MHz
	TX(10M)	Channel 37800	Channel 38000	Channel 38200
		2575 MHz	2595 MHz	2615 MHz
	TX(15M)	Channel 37825	Channel 38000	Channel 38175

Test Mode	TX / RX	RF Channel		
		Low (B)	Middle (M)	High (T)
	TX(20M)	2577.5 MHz	2595 MHz	2612.5 MHz
		Channel 37850	Channel 38000	Channel 38150
	RX(5M)	2580 MHz	2595 MHz	2610 MHz
		Channel 37775	Channel 38000	Channel 38225
	RX(10M)	2572.5 MHz	2595 MHz	2617.5 MHz
		Channel 37800	Channel 38000	Channel 38200
	RX(15M)	2575 MHz	2595 MHz	2615 MHz
		Channel 37825	Channel 38000	Channel 38175
	RX(20M)	2577.5 MHz	2595 MHz	2612.5 MHz
		Channel 37850	Channel 38000	Channel 38150
		2580 MHz	2595 MHz	2610 MHz

Test frequencies for CA_38C							
Range	CC-Combo / N _{RB_agg} [RB]	CC1 Note1			CC2 Note1		
		BW [RB]	N _{UL/DL}	f _{UL/DL} [MHz]	BW [RB]	N _{UL/DL}	f _{UL/DL} [MHz]
Low	75+75	75	37825	2577.5	75	37975	2592.5
	100+100	100	37850	2580	100	38048	2599.8
Mid	75+75	75	37925	2587.5	75	38075	2602.5
	100+100	100	37901	2585.1	100	38099	2604.9
High	75+75	75	38025	2597.5	75	38175	2612.5
	100+100	100	37952	2590.2	100	38150	2610

Note 1: Carriers in increasing frequency order.

Test Mode	TX / RX	RF Channel		
		Low (B)	Middle (M)	High (T)
LTE Band 40(2305-2315MHz)	TX (5M)	Channel 38725	Channel 38750	Channel 38775
		2307.5 MHz	2310 MHz	2312.5 MHz

Test Mode	TX / RX	RF Channel		
		Low (B)	Middle (M)	High (T)
	TX (10M)	Channel 38750	Channel 3.49	Channel 38750
		2310 MHz	2310 MHz	2310MHz
	RX (5M)	Channel 38725	Channel 38750	Channel 38775
		2307.5 MHz	2310 MHz	2312.5 MHz
	RX (10M)	Channel 38750	Channel 38750	Channel 38750
		2310 MHz	2310 MHz	2310MHz

Test Mode	TX / RX	RF Channel		
		Low (B)	Middle (M)	High (T)
LTE Band 40(2350-2360MHz)	TX (5M)	Channel 39175	Channel 39200	Channel 39225
		2352.5 MHz	2355 MHz	2357.5 MHz
	TX (10M)	Channel 39200	Channel 39200	Channel 39200
		2355 MHz	2355 MHz	2355 MHz
	RX (5M)	Channel 39175	Channel 39200	Channel 39225
		2352.5 MHz	2355 MHz	2357.5 MHz
	RX (10M)	Channel 39200	Channel 39200	Channel 39200
		2355 MHz	2355 MHz	2355 MHz

Test Mode	TX / RX	RF Channel		
		Low (B)	Middle (M)	High (T)
LTE Band 41(2535-2655)	TX(5M)	Channel 40065	Channel 40640	Channel 41215
		2537.5 MHz	2595 MHz	2652.5 MHz
	TX(10M)	Channel 40090	Channel 40640	Channel 41190
		2540 MHz	2595 MHz	2650 MHz

Test Mode	TX / RX	RF Channel		
		Low (B)	Middle (M)	High (T)
	TX(15M)	Channel 40115	Channel 40640	Channel 41165
		2542.5 MHz	2595 MHz	2647.5 MHz
	TX(20M)	Channel 40140	Channel 40640	Channel 41140
		2545 MHz	2595 MHz	2645 MHz
	RX(5M)	Channel 40165	Channel 40640	Channel 41215
		2547.5 MHz	2595 MHz	2652.5 MHz
	RX(10M)	Channel 40190	Channel 40640	Channel 41190
		2550 MHz	2595 MHz	2650 MHz
	RX(15M)	Channel 40215	Channel 40640	Channel 41165
		2552.5 MHz	2595 MHz	2647.5 MHz
	RX(20M)	Channel 40240	Channel 40640	Channel 41140
		2555 MHz	2595 MHz	2645 MHz

Test frequencies for CA_41C(2535-2655)							
Range	CC-Combo / NRB_agg [RB]	CC1 Note1			CC2 Note1		
		BW [RB]	NUL/DL	fUL/DL [MHz]	BW [RB]	NUL/DL	fUL/DL [MHz]
Low	25+100	25	40073	2538.3	100	40190	2550.0
		100	40140	2545	25	40257	2556.7
	50+100	50	40095	2540.5	100	40239	2554.9
		100	40140	2545	50	40284	2559.4
	75+75	75	40115	2542.5	75	40265	2557.5
	75+100	75	40118	2542.8	100	40289	2559.9
		100	40140	2545	75	40311	2562.1
100+100	100	40140	2545	100	40338	2564.8	
Mid	25+100	25	40548	2585.8	100	40665	2597.5
		100	40615	2592.5	25	40732	2604.2
	50+100	50	40546	2585.6	100	40690	2600.0
		100	40591	2590.1	50	40735	2604.5
	75+75	75	40565	2587.5	75	40715	2602.5
	75+100	75	40543	2585.3	100	40714	2602.4

Test frequencies for CA_41C(2535-2655)							
Range	CC-Combo /	CC1 Note1			CC2 Note1		
				100	40566	2587.6	75
	100+100	100	40911	2622.1	100	40739	2604.9
High	25+100	25	41023	2633.3	100	41140	2645.0
		100	41090	2640	25	41207	2651.7
	50+100	50	40996	2630.6	100	41140	2545.0
		100	41041	2635.1	50	41185	2649.5
	75+75	75	41015	2632.5	75	41165	2647.5
	75+100	75	40969	2627.9	100	41140	2545.0
		100	40991	2630.1	75	41162	2647.2
	100+100	100	40942	2625.2	100	41140	2645.0

Note 1: Carriers in increasing frequency order.

Test Mode	TX / RX	RF Channel		
		Low (B)	Middle (M)	High (T)
LTE Band 66	TX(1.4M)	Channel 131979	Channel 132322	Channel 132665
		1710.7 MHz	1745 MHz	1779.3 MHz
	TX(3M)	Channel 131987	Channel 132322	Channel 132657
		1711.5 MHz	1745 MHz	1778.5 MHz
	TX(5M)	Channel 131997	Channel 132322	Channel 132647
		1712.5 MHz	1745 MHz	1777.5 MHz
	TX(10M)	Channel 132022	Channel 132322	Channel 132622
		1715 MHz	1745 MHz	1775MHz
	TX(15M)	Channel 132047	Channel 132322	Channel 132597
		1717.5 MHz	1745 MHz	1772.5 MHz
	TX(20M)	Channel 132072	Channel 132322	Channel 132572
		1720 MHz	1745 MHz	1770 MHz
	RX(1.4M)	Channel 1975	Channel 2175	Channel 2375
		2112.5 MHz	2132.5MHz	2152.5 MHz
	RX(3M)	Channel 2000	Channel 2175	Channel 2350

Test Mode	TX / RX	RF Channel		
		Low (B)	Middle (M)	High (T)
		2115 MHz	2132.5MHz	2150 MHz
	RX(5M)	Channel 1975	Channel 2175	Channel 2375
		2112.5 MHz	2132.5MHz	2152.5 MHz
	RX(10M)	Channel 2000	Channel 2175	Channel 2350
		2115 MHz	2132.5MHz	2150 MHz
	RX(15M)	Channel 2025	Channel 2175	Channel 2325
		2117.5 MHz	2132.5MHz	2147.5 MHz
	RX(20M)	Channel 2050	Channel 2175	Channel 2300
		2120 MHz	2132.5MHz	2145 MHz

5.3 DESCRIPTION OF TESTS

5.3.1 Radiated Power and Radiated Spurious Emissions

Radiated spurious emissions are investigated indoors in a full-anechoic chamber to determine the frequencies producing the worst case emissions. Final measurements for radiated power and radiated spurious emissions are performed on the 3 meter OATS per the guidelines of ANSI/TIA-603-E-2016. The equipment under test was transmitting while connected to its integral antenna and is placed on a wooden turntable 150cm above the ground plane and 3 meters from the receive antenna. The spectrum is scanned from the lowest frequency generated in the equipment up to a frequency including its 10th harmonic. The receive antenna height is adjusted between 1 and 4 meter height, the turntable is rotated through 360 degrees, and the EUT is manipulated through all orthogonal planes representative of its typical use to achieve the highest reading on the receive spectrum analyzer. Emissions are also investigated with the receive antenna horizontally and vertically polarized.

A portable or small unlicensed wireless device shall be placed on a non-metallic test fixture or other non-metallic support during testing. The supporting fixture shall permit orientation of the EUT in each of three orthogonal (x, y, z) axis positions such that emissions from the EUT are maximized. Measure the EUT maximum RF power and record the result.

A half-wave dipole is then substituted in place of the EUT. For emissions above 3GHz, a horn antenna is substituted in place of the EUT. The substitute antenna is driven by a signal generator with the level of the signal generator being adjusted to obtain the same receive spectrum analyzer level previously recorded from the spurious emission from the EUT.

The power of the emission is calculated using the following formula:

$$P_d \text{ [dBm]} = P_g \text{ [dBm]} - \text{cable loss [dB]} + \text{antenna gain [dBd/dBi]}$$

Where, P_d is the dipole equivalent power, P_g is the generator output into the substitution antenna, and the antenna gain is the gain of the substitute antenna used relative to either a half-wave dipole (dBd) or an isotropic source (dBi). The substitute level is equal to $P_g \text{ [dBm]} - \text{cable loss [dB]}$.

The calculated P_d levels are then compared to the absolute spurious emission limit of -13dBm which is equivalent to the required minimum attenuation of $43 + 10\log_{10}(\text{Power [Watts]})$.

Test Procedures Used

KDB 971168 D01 v03-Section 5

ANSI/TIA-603-E-2016-Section 2.2.17 / ANSI/TIA-603-E-2016-Section 2.2.12

Note: Reference test setup 3

5.3.2 Peak-Average Ratio

A peak to average ratio measurement is performed at the conducted port of the EUT. The spectrum analyzers Complementary Cumulative Distribution Function (CCDF) measurement profile is used to determine the largest deviation between the average and the peak power of the EUT in a given bandwidth.

Test Procedures Used

KDB 971168 D01 v03-Section 5.7.2

Test Settings

- 1、 The signal analyzer's CCDF measurement profile enabled
- 2、 Frequency= carrier center frequency
- 3、 Measurement BW > EBW of signal
- 4、 for continuous transmissions, set to 1ms
- 5、 Record the maximum PAPR level associated with a probability of 0.1%.

Note: Reference test setup 1

5.3.3 Occupied Bandwidth

The occupied bandwidth, that is the frequency bandwidth such that, below its lower and above its upper frequency limits, the mean powers radiated are each equal to 0.5 percent of the total mean power radiated by a given emission shall be measured. The span of the analyzer shall be set to capture all products of the modulation process, including the emission skirts. The resolution bandwidth shall be set to as close to 1 percent of the selected span as is possible without being below 1 percent. The video bandwidth shall be set to 3 times the resolution bandwidth. Video averaging is not permitted. Where practical, a sampling detector shall be used since a peak or, peak hold, may produce a wider bandwidth than actual. The trace data points are recovered and are directly summed in linear terms. The recovered amplitude data points, beginning at the lowest frequency, are placed in a running sum until 0.5 percent of the total is reached and that frequency recorded. The process is repeated for the highest frequency data points. This frequency is recorded. The span between the two recorded frequencies is the occupied bandwidth.

Test Procedures Used

KDB 971168 D01 v03-Section 4.3

Test Settings

- 1、 SET RBW=1-5% of OBW
- 2、 SET VBW \geq 3*RBW
- 3、 Detector: Peak
- 4、 Trace mode= max hold.
- 5、 Sweep= auto couple
- 6、 Steps 1-5 were repeated after it is stable

Note: Reference test setup 1.

5.3.4 Band Edge Compliance

The test complies with the requirements in clause 2 of the present report according to test procedures in KDB 971168 D01 v03-Section 6 with corresponding test settings.

Note: Reference test setup 1.

5.3.5 Spurious and Harmonic Emissions at Antenna Terminal

The test complies with the requirements in clause 2 of the present report according to test procedures in KDB 971168 D01 v03-Section 6 with corresponding test settings.

Note: Reference test setup 1.

5.3.6 Frequency Stability / Temperature Variation

Frequency stability testing is performed in accordance with the guidelines of ANSI/TIA-603-E-2016. The frequency stability of the transmitter is measured by:

- a.) **Temperature:** The temperature is varied from -30°C to +50°C in 10°C increments using an environmental chamber.
- b.) **Primary Supply Voltage:** The primary supply voltage is varied from 85% to 115% of the nominal value for non-hand-carried battery and AC powered equipment. For hand-carried, battery-powered equipment, primary supply voltage is reduced to the battery operating end point which shall be specified by the manufacturer.

Specification – The frequency stability shall be sufficient to ensure that the fundamental emission stays within the authorized frequency block. The frequency stability of the transmitter shall be maintained within $\pm 0.00025\%$ (± 2.5 ppm) of the center frequency.

Time Period and Procedure:

1. The carrier frequency of the transmitter is measured at room temperature (20°C to provide a reference).
2. The equipment is turned on in a “standby” condition for fifteen minutes before applying power to the transmitter. Measurement of the carrier frequency of the transmitter is made within one minute after applying power to the transmitter.
3. Frequency measurements are made at 10°C intervals ranging from -30°C to +50°C. A period of at least one half-hour is provided to allow stabilization of the equipment at each temperature level.

Test Procedures Used

ANSI/TIA-603-E-2016

Note: Reference test setup 2.

5.4 Test Setups

5.4.1 Test Setup 1

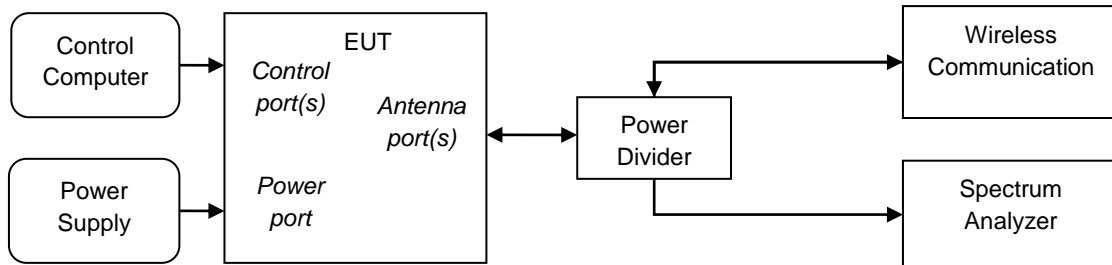

5.4.2 Test Setup 2

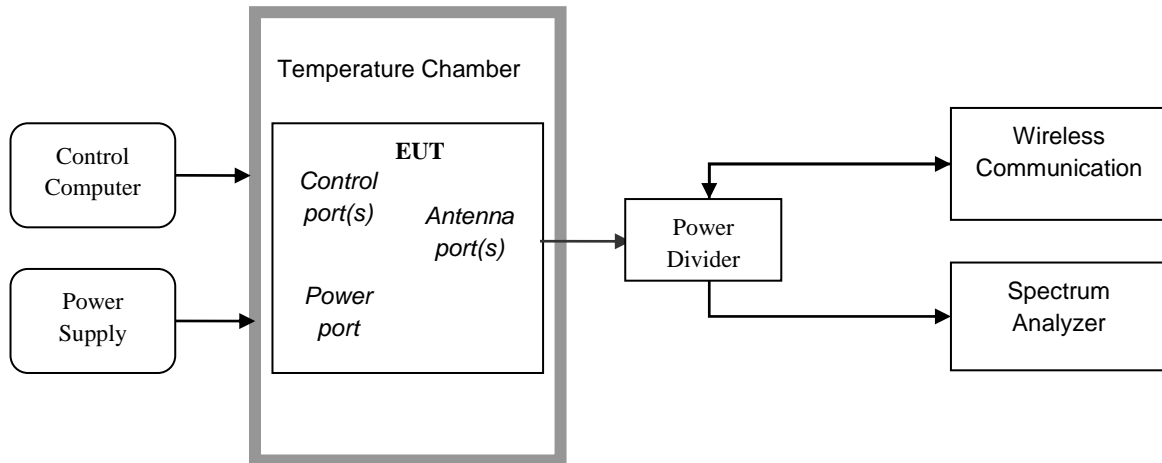

5.4.3 Test Setup 3

NOTE: Effective radiated power (ERP) and Equivalent Isotropic Radiated Power(EIRP) refers to the radiation power output of the EUT, assuming all emissions are radiated from half-wave dipole antennas.

5.4.3.1 Step 1: Pre-test

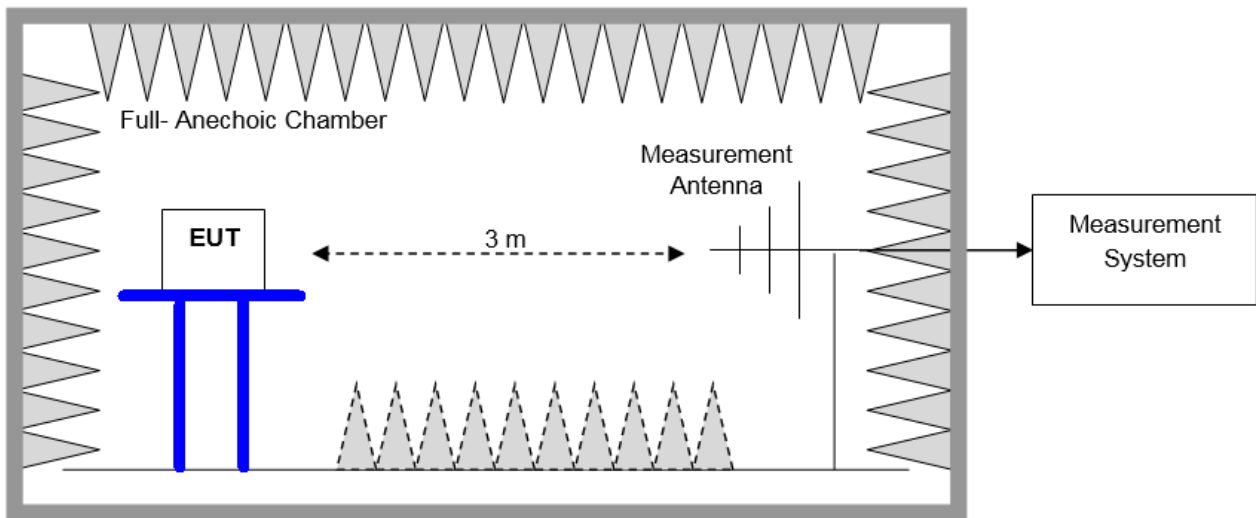

5.4.3.2 Step 2: Substitution method to verify the maximum ERP/EIRP

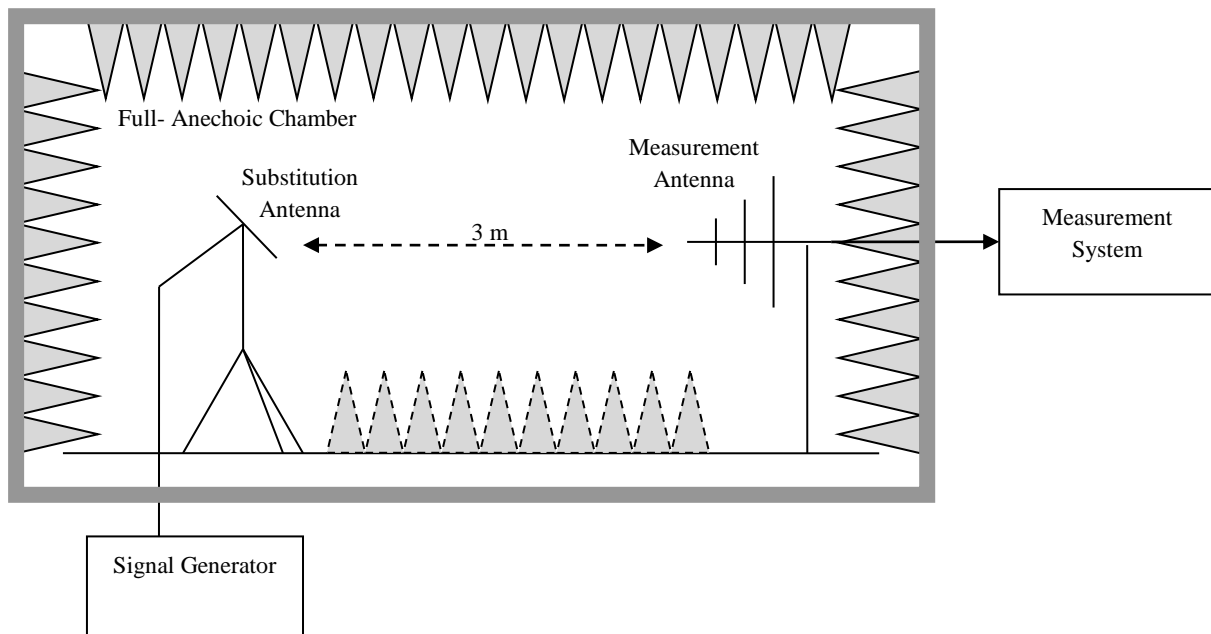

5.5 Test Conditions

Test Case		Test Conditions	
Transmit Output Power Data	Average Power, Total	Test Env.	Ambient Climate & Rated Voltage
		Test Setup	Test Setup 1
		RF Channels (TX)	L, M, H (L= low channel, M= middle channel, H= high channel)
		Test Mode	GSM/TM1,GSM/TM2,UMTS/TM1,LTE/TM1,LTE/TM2
	Average Power, Spectral Density (if required)	Test Env.	Ambient Climate & Rated Voltage
		Test Setup	Test Setup 1
		RF Channels (TX)	L, M, H (L= low channel, M= middle channel, H= high channel)
		Test Mode	GSM/TM1,GSM/TM2,UMTS/TM1,LTE/TM1,LTE/TM2
Peak-to-Average Ratio (if required)		Test Env.	Ambient Climate & Rated Voltage
		Test Setup	Test Setup 1
		RF Channels (TX)	L, M, H (L= low channel, M= middle channel, H= high channel)
		Test Mode	GSM/TM1,GSM/TM2,UMTS/TM1,LTE/TM1,LTE/TM2
Modulation Characteristics		Test Env.	Ambient Climate & Rated Voltage
		Test Setup	Test Setup 1
		RF Channels (TX)	M (L= low channel, M= middle channel, H= high channel)
		Test Mode	GSM/TM1,GSM/TM2,UMTS/TM1,LTE/TM1,LTE/TM2
Bandwidth	Occupied Bandwidth	Test Env.	Ambient Climate & Rated Voltage
		Test Setup	Test Setup 1
		RF Channels (TX)	L, M, H (L= low channel, M= middle channel, H= high channel)
		Test Mode	GSM/TM1,GSM/TM2,UMTS/TM1,LTE/TM1,LTE/TM2
	Emission Bandwidth (if required)	Test Env.	Ambient Climate & Rated Voltage
		Test Setup	Test Setup 1
		RF Channels (TX)	L, M, H (L= low channel, M= middle channel, H= high channel)
		Test Mode	GSM/TM1,GSM/TM2,UMTS/TM1,LTE/TM1,LTE/TM2
Band Edges Compliance		Test Env.	Ambient Climate & Rated Voltage
		Test Setup	Test Setup 1
		RF Channels (TX)	L, H (L= low channel, M= middle channel, H= high channel)
		Test Mode	GSM/TM1,GSM/TM2,UMTS/TM1,LTE/TM1,LTE/TM2
Spurious Emission at Antenna Terminals		Test Env.	Ambient Climate & Rated Voltage
		Test Setup	Test Setup 1
		RF Channels (TX)	L, M, H (L= low channel, M= middle channel, H= high channel)

Test Case	Test Conditions	
	Test Mode	GSM/TM1,GSM/TM2,UMTS/TM1,LTE/TM1,LTE/TM2
Field Strength of Spurious Radiation	Test Env.	Ambient Climate & Rated Voltage
	Test Setup	Test Setup 3
	Test Mode	GSM/TM1,GSM/TM2,UMTS/TM1,LTE/TM1,LTE/TM2 NOTE: If applicable, the EUT conf. that has maximum power density (based on the equivalent power level) is selected.
	RF Channels (TX)	L, M, H (L= low channel, M= middle channel, H= high channel)
Frequency Stability	Test Env.	(1) -30 °C to +50 °C with step 10 °C at Rated Voltage; (2) VL, VN and VH of Rated Voltage at Ambient Climate.
	Test Setup	Test Setup 2
	RF Channels (TX)	L, M, H (L= low channel, M= middle channel, H= high channel)
	Test Mode	GSM/TM1,GSM/TM2,UMTS/TM1,LTE/TM1,LTE/TM2

6 Main Test Instruments

This table gives a complete overview of the RF measurement equipment.

Devices used during the test described are marked

6.1 Current Test Project/Report

<input checked="" type="checkbox"/> Main Test Equipment(GSM/WCDMA/LTE test system)						
Marked	Equipment Name	Manufacturer	Model	Serial Number	Cal Date	Cal-Due
<input type="checkbox"/>	DC Power Supply	KEITHLEY	2303	1342889	2018/10/24	2019/10/24
<input type="checkbox"/>	DC Power Supply	KEITHLEY	2303	000500E	2018/05/21	2019/05/21
<input type="checkbox"/>	DC Power Supply	KEITHLEY	2303	1288003	2018/12/20	2019/12/20
<input checked="" type="checkbox"/>	DC Power Supply	KEITHLEY	2303	000381E	2018/05/21	2019/05/21
<input type="checkbox"/>	DC Power Supply	KEITHLEY	2303	000510E	2018/05/21	2019/05/21
<input checked="" type="checkbox"/>	Temperature Chamber	WEISS	WKL64	56246002940010	2018/10/24	2019/10/24
<input type="checkbox"/>	Universal Radio Communication Tester	R&S	CMW500	159302	2018/07/23	2019/07/23
<input checked="" type="checkbox"/>	Universal Radio Communication Tester	R&S	CMW500	126854	2018/07/23	2019/07/23
<input type="checkbox"/>	Universal Radio Communication Tester	R&S	CMW500	164698	2018/06/17	2019/06/17
<input checked="" type="checkbox"/>	Universal Radio Communication Tester	R&S	CMU200	110932	2018/4/27	2019/4/27
<input type="checkbox"/>	Universal Radio Communication Tester	R&S	CMU200	123299	2018/12/18	2019/12/18
<input type="checkbox"/>	Universal Radio Communication Tester	R&S	CMU200	117341	2018/12/18	2019/12/18
<input type="checkbox"/>	Signal Analyzer	R&S	FSQ31	200021	2018/7/23	2019/7/23
<input type="checkbox"/>	Signal Analyzer	R&S	FSU26	201069	2018/11/02	2019/11/02
<input type="checkbox"/>	Spectrum Analyzer	Agilent	N9030A	MY51380032	2018/07/23	2019/07/23
<input checked="" type="checkbox"/>	Spectrum Analyzer	Agilent	N9030A	MY49431698	2018/07/23	2019/07/23
<input type="checkbox"/>	Spectrum Analyzer	Keysight	N9040B	MY57212529	2018/06/28	2019/06/28
<input type="checkbox"/>	Signal generator	Agilent	E8257D	MY51500314	2018/04/27	2019/04/27
<input checked="" type="checkbox"/>	Signal generator	Agilent	E8257D	MY49281095	2018/07/23	2019/07/23
<input checked="" type="checkbox"/>	Vector Signal Generator	R&S	SMU200A	104162	2018/07/23	2019/07/23
<input type="checkbox"/>	Vector Signal Generator	R&S	SMW200A	103447	2018/05/31	2019/05/31

<input checked="" type="checkbox"/> Main Test Equipment(RE test system)						
Marked	Equipment Name	Manufacturer	Model	Serial Number	Cal Date	Cal-Due
<input checked="" type="checkbox"/>	Test receiver	R&S	ESU26	100387	2019/01/15	2020/01/14
<input checked="" type="checkbox"/>	LOOP	R&S	HFH2-Z2	100262	2017/04/25	2019/04/25

	Antennas(9kHz-30MHz)					
<input type="checkbox"/>	LOOP Antennas(9kHz-30MHz)	R&S	HFH2-Z2	100263	2017/04/25	2019/04/25
<input checked="" type="checkbox"/>	Trilog Broadband Antenna (30M~3GHz)	SCHWARZBE CK	VULB 9163	9163-357	2017/04/21	2019/04/20
<input type="checkbox"/>	Trilog Broadband Antenna (30M~3GHz)	SCHWARZBE CK	VULB 9163	9163-520	2017/3/29	2019/3/28
<input type="checkbox"/>	Trilog Broadband Antenna (30M~3GHz)	SCHWARZBE CK	VULB 9163	9163-491	2017/3/29	2019/3/28
<input type="checkbox"/>	Trilog Broadband Antenna (30M~3GHz)	SCHWARZBE CK	VULB 9163	9163-356	2018/4/9	2020/4/8
<input checked="" type="checkbox"/>	Double-Ridged Waveguide Horn Antenna (1G~18GHz)	R&S	HF907	100305	2017/4/21	2019/4/20
<input type="checkbox"/>	Double-Ridged Waveguide Horn Antenna (1G~18GHz)	R&S	HF906	100684	2017/5/27	2019/5/26
<input type="checkbox"/>	Double-Ridged Waveguide Horn Antenna (1G~18GHz)	R&S	HF906	100683	2017/3/29	2019/3/28
<input checked="" type="checkbox"/>	Pyramidal Horn Antenna(18GHz-26.5G Hz)	ETS-Lindgren	3160-09	5140299	2017/07/20	2019/07/19
<input type="checkbox"/>	Pyramidal Horn Antenna(18GHz-26.5G Hz)	ETS-Lindgren	3160-09	00206665	2018/4/21	2020/4/20
<input checked="" type="checkbox"/>	Pyramidal Horn Antenna(26.5GHz-40G Hz)	ETS-Lindgren	3160-10	00205695	2018/04/20	2020/04/19
<input type="checkbox"/>	Pyramidal Horn Antenna(26.5GHz-40G Hz)	ETS-Lindgren	3160-10	LM5947	2017/07/20	2019/07/19
<input checked="" type="checkbox"/>	Measurement Software	R&S	EMC32 V9.25.0	/	/	/

<input checked="" type="checkbox"/> Main Test Equipment (RSE test system)						
Marked	Equipment Name	Manufacturer	Model	Serial Number	Cal Date	Cal-Due
<input checked="" type="checkbox"/>	Universal Radio Communication Tester	R&S	CMU200	117385	2018/05/08	2019/05/07
<input checked="" type="checkbox"/>	Universal Radio Communication Tester	R&S	MT8821C	6261760791	2018/04/02	2019/04/01
<input checked="" type="checkbox"/>	Spectrum analyzer	R&S	FSU3	200474	2019/01/15	2020/01/14
<input checked="" type="checkbox"/>	Spectrum analyzer	R&S	FSU43	100144	2019/01/15	2020/01/14

<input type="checkbox"/>	Trilog Broadband Antenna (30M~3GHz)	SCHWARZBECK	VULB 9163	9163-490	2017/03/29	2019/03/28
<input checked="" type="checkbox"/>	Trilog Broadband Antenna (30M~3GHz)	SCHWARZBECK	VULB 9163	9163-521	2018/04/09	2020/04/08
<input checked="" type="checkbox"/>	Double-Ridged Waveguide Horn Antenna (1G~18GHz)	R&S	HF907	100304	2017/05/27	2019/05/26
<input checked="" type="checkbox"/>	double ridged horn antenna (0.8G-18GHz)	R&S	HF907	100391	2017/7/20	2019/7/19
<input checked="" type="checkbox"/>	Pyramidal Horn Antenna(18GHz-26.5GHz)	ETS-Lindgren	3160-09	5140299	2017/07/20	2019/07/19
<input type="checkbox"/>	Pyramidal Horn Antenna(18GHz-26.5GHz)	ETS-Lindgren	3160-09	00206665	2018/4/21	2020/4/20
<input type="checkbox"/>	Pyramidal Horn Antenna(26.5GHz-40GHz)	ETS-Lindgren	3160-10	00205695	2018/04/20	2020/04/19
<input checked="" type="checkbox"/>	Pyramidal Horn Antenna(26.5GHz-40GHz)	ETS-Lindgren	3160-10	LM5947	2017/07/20	2019/07/19
<input checked="" type="checkbox"/>	Measurement Software	R&S	EMC32 V8.40.0	/	/	/

7 Measurement Uncertainty

For a 95% confidence level ($k = 2$), the measurement expanded uncertainties for defined systems, in accordance with the recommendations of ISO 17025 as following:

Test Item		Extended Uncertainty
Transmit Output Power Conducted	Power [dBm]	U = 0.64 dB
RF Power Density, Conducted	Power [dBm]	U = 0.64 dB
Bandwidth	Magnitude [kHz]	200kHz: U=9.06kHz 1.4MHz: U=9.48kHz 3MHz: U= 10.86kHz 5MHz: U=13.84kHz 10MHz: U=22.32kHz 15MHz: U=31.9kHz 20MHz: U=41.78kHz
Band Edge Compliance	Disturbance Power [dBm]	U = 0.9 dB
Spurious Emissions, Conducted	Disturbance Power [dBm]	20MHz~3.6GHz: U=0.88dB 3.6GHz~8.4GHz: U=1.08dB 8.4GHz~13.6GHz: U=1.24dB 13.6GHz~22GHz: U=1.34dB 22GHz~26.5GHz: U=1.36dB
Field Strength of Spurious Radiation	ERP/EIRP [dBm]	For 3 m Chamber: U = 5.94 dB (30 MHz to 3GHz) U = 5.54 dB (3GHz to 18GHz) U = 4.94 dB (18GHz to 26.5GHz)
Frequency Stability	Frequency Accuracy [Hz]	800MHz: U=24.08Hz 900MHz: U=24.54Hz 1900MHz: U=34.7Hz 2100MHz: U=36.96Hz 2300MHz: U=39.24Hz 2500MHz: U=41.58Hz 2600MHz: U=42.74Hz

8 Appendixes

Appendix No.	Description
SYBH(Z-RF)20181218028001-2001-A	Appendix_for_GSM
SYBH(Z-RF)20181218028001-2001-B	Appendix_for_WCDMA
SYBH(Z-RF)20181218028001-2001-C	Appendix_for_LTE Band2
SYBH(Z-RF)20181218028001-2001-D	Appendix_for_LTE Band4
SYBH(Z-RF)20181218028001-2001-E	Appendix_for_LTE Band5
SYBH(Z-RF)20181218028001-2001-F	Appendix_for_LTE Band7
SYBH(Z-RF)20181218028001-2001-G	Appendix_for_LTE Band12
SYBH(Z-RF)20181218028001-2001-H	Appendix_for_LTE Band17
SYBH(Z-RF)20181218028001-2001-I	Appendix_for_LTE_Band_26(814-824)
SYBH(Z-RF)20181218028001-2001-J	Appendix_for_LTE_Band_26(824-849)
SYBH(Z-RF)20181218028001-2001-K	Appendix_for_LTE Band38
SYBH(Z-RF)20181218028001-2001-L	Appendix_for_LTE_Band_40(2305-2315)
SYBH(Z-RF)20181218028001-2001-M	Appendix_for_LTE_Band_40(2350-2360)
SYBH(Z-RF)20181218028001-2001-N	Appendix_for_LTE_Band_41(2535-2655)
SYBH(Z-RF)20181218028001-2001-O	Appendix_for_LTE_Band_66
SYBH(Z-RF)20181218028001-2001-P	Appendix_for_CA_Band_CA_7C
SYBH(Z-RF)20181218028001-2001-Q	Appendix_for_CA_Band_CA_38C
SYBH(Z-RF)20181218028001-2001-R	Appendix_for_CA_Band_CA_41C(2535-2655)

Appendix	Description
Appendix A	Effective (Isotropic) Radiated Power Output Data
Appendix B	Peak-Average Ratio
Appendix C	Modulation Characteristics
Appendix D	Bandwidth
Appendix E	Band Edges Compliance
Appendix F	Spurious Emission at Antenna Terminals
Appendix G	Field Strength of Spurious Radiation
Appendix H	Frequency Stability

Note: For the RSE data we tested ant1&ant2, the data presented is all the antenna mode; the other items we tested all antenna modes, but the data presented is the worst antenna mode.

END