



FCC SAR Compliance Test Report

Product Name: Smart Phone

Model: VOG-L04

Report No.: SYBH(Z-SAR)20200307017001-2

FCC ID: QISVOG-L04

	APPROVED (Lab Manager)	PREPARED (Test Engineer)
BY	<i>Wei Huaobin</i>	<i>Sun Shaobin</i>
DATE	2020-04-13	2020-04-13

Reliability Laboratory of Huawei Technologies Co., Ltd.

(Global Compliance and Testing Center of Huawei Technologies Co., Ltd)

No.2, New City Avenue, Songshan Lake Sci. & Tech. Industry Park,
Dongguan, Guangdong, 523808, P.R.C
Tel: +86 769 23830808 Fax: +86 769 23837628

※ ※ **Notice** ※ ※

1. The laboratory has passed the accreditation by China National Accreditation Service for Conformity Assessment (CNAS). The accreditation number is L0310.
2. The laboratory has passed the accreditation by The American Association for Laboratory Accreditation (A2LA). The accreditation number is 2174.01 & 2174.02 & 2174.03
3. The laboratory (Reliability Lab of Huawei Technologies Co., Ltd) is also named “Global Compliance and Testing Center of Huawei Technologies Co., Ltd”, the both names have coexisted since 2009.
4. The test report is invalid if not marked with the signatures of the persons responsible for preparing and approving the test report.
5. The test report is invalid if there is any evidence of erasure and/or falsification.
6. The test report is only valid for the test samples.
7. Content of the test report, in part or in full, cannot be used for publicity and/or promotional purposes without prior written approval from the laboratory.
8. If any question about this report, please contact the laboratory (PublicGCTC@huawei.com).

Table of Contents

1	General Information.....	7
1.1	Statement of Compliance	7
1.2	RF exposure limits	8
1.3	EUT Description.....	9
1.3.1	General Description	12
1.4	Test specification(s).....	13
1.5	Testing laboratory	13
1.6	Applicant and Manufacturer.....	13
1.7	Application details	13
1.8	Ambient Condition.....	13
2	SAR Measurement System	14
2.1	SAR Measurement Set-up.....	14
2.2	Test environment	15
2.3	Data Acquisition Electronics description.....	15
2.4	Probe description	16
2.5	Phantom description	17
2.6	Device holder description	18
2.7	Test Equipment List	19
3	SAR Measurement Procedure	21
3.1	Scanning procedure.....	21
3.2	Spatial Peak SAR Evaluation	22
3.3	Data Storage and Evaluation.....	23
4	System Verification Procedure	25
4.1	Tissue Verification.....	25
4.2	System Check.....	29
4.3	System check Procedure	30
5	SAR measurement variability and uncertainty	31
5.1	SAR measurement variability	31
5.2	SAR measurement uncertainty.....	31
6	SAR Test Configuration.....	32
6.1	Test Positions Configuration.....	32
6.1.1	General considerations	32
6.1.2	Head Exposure Condition	32
6.1.3	Body-worn Exposure Condition	34
6.1.4	Hotspot Exposure Condition	34
6.1.5	Product Specific 10-g SAR Exposure Condition.....	34
6.2	3G SAR Test Reduction Procedure	35
6.3	GSM Test Configuration	35
6.4	UMTS Test Configuration	36
6.5	LTE Test Configuration	41
6.6	WiFi Test Configuration	45
6.6.1	Initial Test Position Procedure	45
6.6.2	Initial Test Configuration Procedure	45
6.6.3	Sub Test Configuration Procedure	45
6.6.4	WiFi 2.4G SAR Test Procedures	46
6.6.5	U-NII-1 and U-NII-2A Bands	47
6.6.6	U-NII-2C and U-NII-3 Bands.....	47
6.6.7	OFDM Transmission Mode SAR Test Channel Selection Requirements	48
6.6.8	MIMO SAR Considerations.....	48
6.7	LTE CA and downlink 4 x 4 MIMO specification.....	49
6.7.1	LTE CA combinations specification	49
6.7.2	Test procedure for downlink CA	58
6.7.3	Test procedure for Intra-band uplink CA.....	59
6.7.4	LTE Downlink 4 x 4 MIMO specification and Test procedure	60
6.8	Dynamic antenna switching specification	63
6.9	Power Reduction Specification	64
6.9.1	Power reduction triggered by specific use conditions (2G&3G&4G Second Antenna)	65
6.9.2	Power Reduction Specification of WiFi Antenna	66
6.9.3	Power reduction Specification of 2G&3G&4G Main antenna	69

6.9.4	Proximity sensor Power Reduction Test configuration and validation	70
6.10	BT Test Configuration	84
7	SAR Measurement Results	85
7.1	Conducted power measurements	85
7.1.1	Conducted power measurements of GSM850(Second antenna)	86
7.1.2	Conducted power measurements of GSM850(Main antenna)	87
7.1.3	Conducted power measurements of GSM1900(Second antenna)	88
7.1.4	Conducted power measurements of GSM1900(Main antenna)	90
7.1.5	Conducted power measurements of UMTS Band II(Second antenna)	91
7.1.6	Conducted power measurements of UMTS Band II(Main antenna)	93
7.1.7	Conducted power measurements of UMTS Band IV(Second antenna)	95
7.1.8	Conducted power measurements of UMTS Band IV(Main antenna)	97
7.1.9	Conducted power measurements of UMTS Band V(Second antenna)	100
7.1.10	Conducted power measurements of UMTS Band V(Main antenna)	101
7.1.11	Conducted power measurements of LTE Band 2(Second antenna)	102
7.1.12	Conducted power measurements of LTE Band 2(Main antenna)	114
7.1.13	Conducted power measurements of LTE Band 4(Second antenna)	126
7.1.14	Conducted power measurements of LTE Band 4(Main antenna)	138
7.1.15	Conducted power measurements of LTE Band 5(Second antenna)	156
7.1.16	Conducted power measurements of LTE Band 5(Main antenna)	160
7.1.17	Conducted power measurements of LTE Band 7(Second antenna)	162
7.1.18	Conducted power measurements of LTE Band 7(Main antenna)	170
7.1.19	Conducted power measurements of LTE Band 12(Second antenna)	182
7.1.20	Conducted power measurements of LTE Band 12(Main antenna)	186
7.1.21	Conducted power measurements of LTE Band 17(Second antenna)	188
7.1.22	Conducted power measurements of LTE Band 17(Main antenna)	190
7.1.23	Conducted power measurements of LTE Band 26(Second antenna)	191
7.1.24	Conducted power measurements of LTE Band 26(Main antenna)	197
7.1.25	Conducted power measurements of LTE Band 38(Second antenna)	200
7.1.26	Conducted power measurements of LTE Band 38(Main antenna)	208
7.1.27	Conducted power measurements of LTE Band 41(Second antenna)	218
7.1.28	Conducted power measurements of LTE Band 41(Main antenna)	226
7.1.29	Conducted power measurements of LTE Band 66(Second antenna)	232
7.1.30	Conducted power measurements of LTE Band 66(Main antenna)	244
7.1.31	Conducted power measurements of Downlink LTE CA	262
7.1.32	Conducted power measurements of LTE Downlink 4x4 MIMO	275
7.1.33	Conducted Power measurements of Uplink LTE CA	288
7.1.34	Conducted power measurements of WiFi 2.4G	291
7.1.35	Conducted power measurements of WiFi 5G	296
7.1.36	Conducted power measurements of BT	319
7.2	SAR measurement Results	323
7.2.1	SAR measurement Results of GSM850	325
7.2.2	SAR measurement Results of GSM1900	327
7.2.3	SAR measurement Results of UMTS Band II	330
7.2.4	SAR measurement Results of UMTS Band IV	333
7.2.5	SAR measurement Results of UMTS Band V	336
7.2.6	SAR measurement Results of LTE Band 2	338
7.2.7	SAR measurement Results of LTE Band 4	342
7.2.8	SAR measurement Results of LTE Band 5	347
7.2.9	SAR measurement Results of LTE Band 7	350
7.2.10	SAR measurement Results of LTE Band 12	355
7.2.11	SAR measurement Results of LTE Band 26	358
7.2.12	SAR measurement Results of LTE Band 38	361
7.2.13	SAR measurement Results of LTE Band 41	366
7.2.14	SAR measurement Results of LTE Band 66	371
7.2.15	SAR measurement Results of WiFi 2.4G	376
7.2.16	SAR measurement Results of WiFi 5G	382
7.2.17	SAR measurement Results of BT	391
7.3	Multiple Transmitter Evaluation	393
7.3.1	Simultaneous Transmission Possibilities	394
7.3.2	SAR Summation Scenario	398
7.3.3	Simultaneous Transmission Conclusion	405
	Appendix A. System Check Plots	406



Appendix B. SAR Measurement Plots.....	406
Appendix C. Calibration Certificate	406
Appendix D. Photo documentation.....	406
Appendix E. Antenna Location	406



※ ※ **Modified History** ※ ※

REV.	DESCRIPTION	ISSUED DATE	REMARK
Rev.1.0	Initial Test Report Release	2020-04-13	Sun Shaobin

1 General Information

1.1 Statement of Compliance

The maximum results of Specific Absorption Rate (SAR) found during testing are below Table 1.

Band	Max Reported SAR(W/kg)			
	Head	Body Worn	Hotspot	Product Specific 10-g SAR (0mm)**
GSM850	0.46	0.33	0.80	/
GSM1900	0.56	0.17	0.57	/
UMTS Band II	0.54	0.50	0.68	2.72
UMTS Band IV	0.59	0.60	0.71	2.34
UMTS Band V	0.42	0.38	0.72	/
LTE Band 2	0.58	0.45	0.60	/
LTE Band 4	0.45	0.64	0.74	2.51
LTE Band 5	0.39	0.40	0.72	/
LTE Band 7	0.40	0.57	0.58	1.65
LTE Band 12	0.46	0.29	0.40	/
LTE Band 17	/	/	/	/
LTE Band 26	0.48	0.36	0.73	/
LTE Band 38	0.50	0.35	0.74	1.77
LTE Band 41	0.59	0.37	0.88	2.96
LTE Band 66	0.57	0.44	0.78	2.48
WiFi 2.4G	0.79	0.12	0.37	1.28
WiFi 5G	0.50	0.06	0.23	1.74
BT	0.23	0.06	0.19	/

The highest reported SAR for Head, Body Worn, Hotspot, Simultaneous transmission and Product Specific 10-g SAR exposure conditions are 0.79W/kg, 0.64W/kg, 0.88W/kg, 1.34W/kg and 2.96W/kg respectively per KDB690783 D01.

Table 1: Summary of test result

Note:

- 1)* For body worn operation, this device has been tested and met FCC RF exposure guidelines when used with any accessory that contains no metal and that positions the handset a minimum of 15mm from the body. Use of other accessories may not ensure compliance with FCC RF exposure guidelines.
- 2)** For Product Specific 10-g SAR operation, this device has been tested and meets the 10-g SAR limits of 4.0 W/kg for general population/ uncontrolled exposure according to ANSI C95.1:1992/IEEE C95.1:1991.
- 3) *** According to TCB workshop October,2014 RF Exposure Procedures Update(Overlapping LTE Bands): SAR for LTE Band 17 (Frequency range:704-716 MHz) is covered by LTE Band 12 (Frequency range:699-716 MHz) due to similar frequency range,same maximum tune up limit and same channel bandwidth.

The device is in compliance with Specific Absorption Rate (SAR) for general population/uncontrolled exposure limits according to the FCC rule §2.1093, the ANSI C95.1:1992/IEEE C95.1:1991, the NCRP Report Number 86 for uncontrolled environment, and had been tested in accordance with the measurement methods and procedures specified in IEEE Std 1528-2013.

1.2 RF exposure limits

Human Exposure	Uncontrolled Environment General Population	Controlled Environment Occupational
Spatial Peak SAR* (Brain/Body/Arms/Legs)	1.60 W/kg	8.00 W/kg
Spatial Average SAR** (Whole Body)	0.08 W/kg	0.40 W/kg
Spatial Peak SAR*** (Hands/Feet/Ankle/Wrist)	4.00 W/kg	20.00 W/kg

Table 2: RF exposure limits

The limit applied in this test report is shown in **bold** letters

Notes:

- * The Spatial Peak value of the SAR averaged over any 1 gram of tissue (defined as a tissue volume in the shape of a cube) and over the appropriate averaging time.
- ** The Spatial Average value of the SAR averaged over the whole body.
- *** The Spatial Peak value of the SAR averaged over any 10 grams of tissue (defined as a tissue volume in the shape of a cube) and over the appropriate averaging time.

Uncontrolled Environments are defined as locations where there is the exposure of individuals who have no knowledge or control of their exposure.

Controlled Environments are defined as locations where there is exposure that may be incurred by persons who are aware of the potential for exposure, (i.e. as a result of employment or occupation

1.3 EUT Description

Device Information:			
Product Name:	Smart Phone		
Model:	VOG-L04		
FCC ID :	QISVOG-L04		
SN:	1#: 45C0118C13000093 2#: 45C0118C13000068 3#: 45C0118C13000136 4#: 45C0118C13000131 5#: 45C0118C13000141 6#: 45C0118C13000130 7#: 45C0118C13000067 8#: 45C0118C13000142 9#: 45C0118C13000505		
Device Type :	Portable device		
Device Phase:	Identical Prototype		
Exposure Category:	Uncontrolled environment / general population		
Hardware Version :	HL2VOGUEM		
Software Version :	10.1.0.223(C792E11R1P3log)		
Antenna Type :	Internal antenna		
Other Accessories	Headset, Nonmetallic Protected Cover		
Device Operating Configurations:			
Supporting Mode(s)	GSM850/1900, UMTS Band II/IV/V, LTE Band 2/4/5/7/12/17/26/38/41/66, WiFi 2.4G/5G, BT, NFC		
Test Modulation	GSM(GMSK/8PSK),UMTS(QPSK), LTE(QPSK/16QAM/64QAM), WiFi(DSSS/OFDM),BT(GFSK)		
Device Class	B		
Operating Frequency Range(s)	Band	Tx (MHz)	Rx (MHz)
	GSM850	824-849	869 - 894
	GSM1900	1850-1910	1930-1990
	UMTS Band II	1850-1910	1930-1990
	UMTS Band IV	1710-1755	2110-2115
	UMTS Band V	824-849	869 - 894
	LTE Band 2	1850-1910	1930-1990
	LTE Band 4	1710-1755	2110-2155
	LTE Band 5	824-849	869-894
	LTE Band 7	2500-2570	2620 -2690
	LTE Band 12	699-716	729-746
	LTE Band 17	704-716	734-746
	LTE Band 26	814-849	859-894
	LTE Band 38		2570-2620
	LTE Band 41		2535-2655
	LTE Band 66	1710-1780	2110-2200
	BT		2400-2483.5
	WiFi 2.4G		2400-2472
	WiFi 5G		5150-5350
			5470-5725
		5725-5850	
NFC		13.56	
GPRS Multislot Class(12)	Max Number of Timeslots in Uplink:	4	

	Max Number of Timeslots in Downlink:	4
	Max Total Timeslot:	5
EGPRS Multislot Class(12)	Max Number of Timeslots in Uplink:	4
	Max Number of Timeslots in Downlink:	4
	Max Total Timeslot:	5
HSDPA UE Category	14	
HSUPA UE Category	6	
DC-HSDPA UE Category	24	
Power Class:	4, tested with power level 5(GSM850)	
	1, tested with power level 0(GSM1900)	
	3, tested with power control "all 1"(UMTS Band II)	
	3, tested with power control "all 1"(UMTS Band IV)	
	3, tested with power control "all 1"(UMTS Band V)	
	3, tested with power control all Max.(LTE Band 2)	
	3, tested with power control all Max.(LTE Band 4)	
	3, tested with power control all Max.(LTE Band 5)	
	3, tested with power control all Max.(LTE Band 7)	
	3, tested with power control all Max.(LTE Band 12)	
	3, tested with power control all Max.(LTE Band 17)	
	3, tested with power control all Max.(LTE Band 26)	
	3, tested with power control all Max.(LTE Band 38)	
	3, tested with power control all Max.(LTE Band 41)	
3, tested with power control all Max.(LTE Band 66)		
Test Channels (low-mid-high):	128-190-251(GSM850)	
	512-661-810(GSM1900)	
	9262-9400-9538(UMTS Band II)	
	1312-1413-1513(UMTS Band IV)	
	4132-4182-4233(UMTS Band V)	
	18607-18900-19193(LTE Band 2 BW=1.4MHz)	
	18615-18900-19185(LTE Band 2 BW=3MHz)	
	18625-18900-19175(LTE Band 2 BW=5MHz)	
	18650-18900-19150(LTE Band 2 BW=10MHz)	
	18675-18900-19125(LTE Band 2 BW=15MHz)	
	18700-18900-19100(LTE Band 2 BW=20MHz)	
	19957-20175-20393(LTE Band 4 BW=1.4MHz)	
	19965-20175-20385(LTE Band 4 BW=3MHz)	
	19975-20175-20375(LTE Band 4 BW=5MHz)	
	20000-20175-20350(LTE Band 4 BW=10MHz)	
	20025-20175-20325(LTE Band 4 BW=15MHz)	
	20050-20175-20300(LTE Band 4 BW=20MHz)	
	20407-20525-20643(LTE Band 5 BW=1.4MHz)	
	20415-20525-20635(LTE Band 5 BW=3MHz)	
	20425-20525-20625(LTE Band 5 BW=5MHz)	
	20450-20525-20600(LTE Band 5 BW=10MHz)	
	20775-21100-21425(LTE Band 7 BW=5MHz)	
	20800-21100-21400(LTE Band 7 BW=10MHz)	
	20825-21100-21375(LTE Band 7 BW=15MHz)	
	20850-21100-21350(LTE Band 7 BW=20MHz)	
	23017-23095-23173(LTE Band 12 BW=1.4MHz)	
	23025-23095-23165(LTE Band 12 BW=3MHz)	
23035-23095-23155(LTE Band 12 BW=5MHz)		
23060-23095-23130(LTE Band 12 BW=10MHz)		
23755-23790-23825(LTE Band 17 BW=5MHz)		
23780-23790-23800(LTE Band 17 BW=10MHz)		

26697-26865-27033(LTE Band 26 BW=1.4MHz)
26705-26865-27025(LTE Band 26 BW=3MHz)
26715-26865-27015(LTE Band 26 BW=5MHz)
26740-26865-26990(LTE Band 26 BW=10MHz)
26765-26865-26965(LTE Band 26 BW=15MHz)
37775-38000-38225(LTE Band 38 BW=5MHz)
37800-38000-38200(LTE Band 38 BW=10MHz)
37825-38000-38175(LTE Band 38 BW=15MHz)
37850-38000-38150(LTE Band 38 BW=20MHz)
40065-40448-40832-41215(LTE Band 41 BW=5MHz)
40090-40457-40823-41190(LTE Band 41 BW=10MHz)
40115-40465-40815-41165(LTE Band 41 BW=15MHz)
40140-40473-40807-41140(LTE Band 41 BW=20MHz)
131979-132322-132665(LTE Band 66 BW=1.4MHz)
131987-132322-132657(LTE Band 66 BW=3MHz)
131997-132322-132647(LTE Band 66 BW=5MHz)
132022-132322-132622(LTE Band 66 BW=10MHz)
132047-132322-132597(LTE Band 66 BW=15MHz)
132072-132322-132572(LTE Band 66 BW=20MHz)
802.11b/g/n 20M:1-2-3-6-9-10-11 (WiFi 2.4G)
802.11n 40M:3-4-5-6-7-8-9 (WiFi 2.4G)
802.11a/n/ac 20M: 36-40-44-48-52-56-60-64-100-104-108-112-116-120-124-128-132-136-140-149-153-157-161-165 (WiFi 5G)
802.11 n/ac 40M: 38-46-54-62-102-110-118-126-134-151-159 (WiFi 5G)
802.11ac 80M: 42-58-106-122-155 (WiFi 5G)
802.11ac 160M: 50-114 (WiFi 5G)
BT : 0-2-5-6-10-11-13-18-26-27-31-32-35-39-41-65-66-68-69-72-73-78

Table 3: Device information and operating configuration

Note:

- 1)*For WiFi 5G,the device does not support channel 144(20M), channel 142(40M) and channel 138(80M).
- 2)*For WiFi 5G,U-NII-2A and U-NII-2C band does not support hotspot function.

1.3.1 General Description

VOG-L04 is a subscriber equipment in the GSM/WCDMA/LTE system. The Mobile Phone implements such functions as RF signal receiving/transmitting, LTE/HSPA/UMTS and GSM/GPRS/EDGE protocol processing, voice, video MMS service, GPS, Bluetooth, NFC, Wi-Fi and Wirelessly Charging etc. VOG-L04 provides one USIM card interface and one HUAWEI Nano memory card interface. Externally it provides type C USB charging port, and the port could be used as the earphone port or data-transfer port.

Battery information:

Name	Manufacturer/trademark	Description
Li-ion Polymer Battery	Huawei Technologies Co., Ltd. (Manufacturer: SCUD)	Battery Model: HB486486ECW Rated capacity: 4100mAh Nominal Voltage: $\text{---} +3.82\text{V}$ Charging Voltage: $\text{---} +4.4\text{V}$
	Huawei Technologies Co., Ltd. (Manufacturer: Desay)	

Difference Description

The BT change VOG-L04 new and VOG-L04 old is as below:

Item	VOG-L04 old	VOG-L04 new
BT Function	Not support BT UHD function	Support BT UHD function by upgrade software, BT UHD has 5 kinds mode, which are BLE UHD 1M GFSK, BLE UHD 2M GFSK, BLE UHD 2M $\pi/4$ -DQPSK, BLE UHD 4M $\pi/4$ -DQPSK, BLE UHD 2M 8DQPSK

According to the difference description above:

- 1) The test plan for VOG-L04 new is as below:
 - a) Additional conducted power tests are performed for BT UHD. SAR for BT UHD is not required because the maximum power of BT UHD is not higher than BT-DH5.
 - b) For other frequency bands, VOG-L04 new share the same test data with VOG-L04 old(report no.: SYBH(Z-SAR)20181218028001-2)

1.4 Test specification(s)

ANSI C95.1:1992/ IEEE C95.1:1991	Safety Levels with Respect to Human Exposure to Radio Frequency Electromagnetic Fields, 3 kHz – 300 GHz.
IEEE Std 1528-2013	Recommended Practice for Determining the Peak Spatial-Average Specific Absorption Rate (SAR) in the Human Head from Wireless Communications Devices: Measurement Techniques
KDB 941225 D01	3G SAR Procedures v03r01
KDB 941225 D05	SAR for LTE Devices v02r05
KDB 941225 D05A	LTE Rel.10 KDB Inquiry Sheet v01r02
KDB 941225 D06	Hotspot SAR v02r01
KDB 447498 D01	General RF Exposure Guidance v06
KDB 648474 D04	Handsets SAR v01r03
KDB 248227 D01	SAR Guidance for IEEE 802.11 Wi-Fi SAR v02r02
KDB 865664 D01	SAR measurement 100 MHz to 6 GHz v01r04
KDB 865664 D02	RF Exposure Reporting v01r02
KDB 690783 D01	SAR Listings on Grants v01r03
KDB 616217 D04	SAR for laptop and tablets v01r02

1.5 Testing laboratory

Test Site	Reliability Laboratory of Huawei Technologies Co., Ltd.
Test Location	NO.2 New City Avenue Songshan Lake Sci. & Tech. Industry Park, Dongguan, Guangdong, P.R.C
Telephone	+86 755 28780808
Fax	+86 769 23837628
State of accreditation	The Test laboratory (area of testing) is accredited according to ISO/IEC 17025. CNAS Registration number: L0310 A2LA TESTING CERT # 2174.01 & 2174.02 & 2174.03

1.6 Applicant and Manufacturer

Company Name	HUAWEI TECHNOLOGIES CO., LTD
Address	Administration Building, Headquarters of Huawei Technologies Co., Ltd., Bantian, Longgang District, Shenzhen, 518129, P.R.C

1.7 Application details

Start Date of test	2019-01-02	2020-04-08
End Date of test	2019-01-12	2020-04-08

1.8 Ambient Condition

Ambient temperature	18°C – 25°C
Relative Humidity	30% – 70%

2 SAR Measurement System

2.1 SAR Measurement Set-up

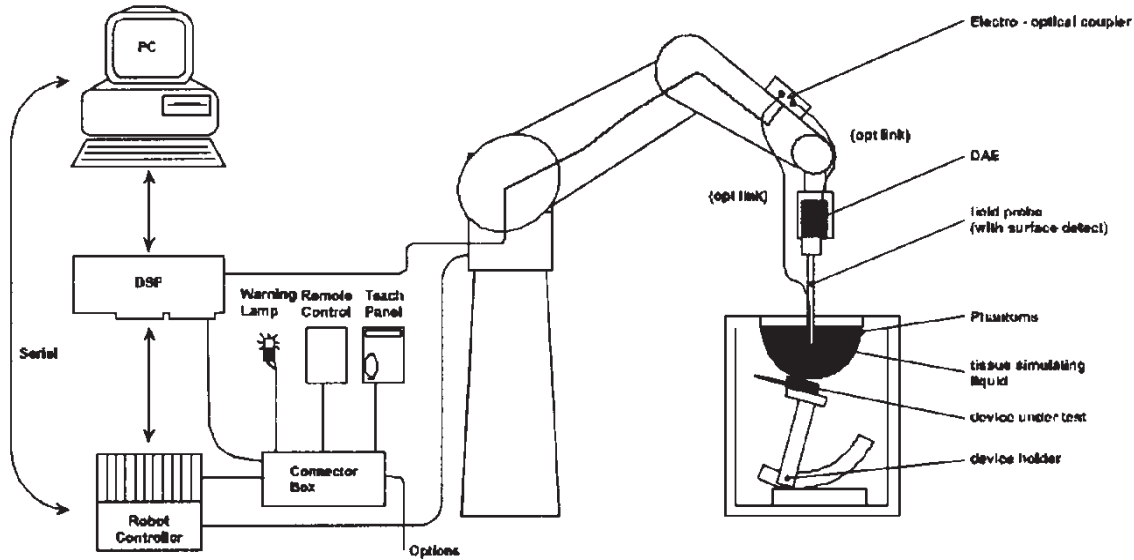

The DAS system for performing compliance tests consists of the following items:

- A standard high precision 6-axis robot (Stäubli RX family) with controller and software. An arm extension for accommodating the data acquisition electronics (DAE).
- A dosimetric probe, i.e. an isotropic E-field probe optimized and calibrated for usage in tissue simulating liquid. The probe is equipped with an optical surface detector system.
- A data acquisition electronic (DAE) which performs the signal amplification, signal multiplexing, AD-conversion, offset measurements, mechanical surface detection, collision detection, etc. The unit is battery powered with standard or rechargeable batteries. The signal is optically transmitted to the EOC.
- A unit to operate the optical surface detector which is connected to the EOC.
- The Electro-Optical Coupler (EOC) performs the conversion from the optical into a digital electric signal of the DAE. The EOC is connected to the DAS measurement server.
- The DAS measurement server, which performs all real-time data evaluation for field measurements and surface detection, controls robot movements and handles safety operation. A computer operating Windows 7.
- DAS software and SEMCAD data evaluation software.
- Remote control with teach panel and additional circuitry for robot safety such as warning lamps, etc.
- The generic twin phantom enabling the testing of left-hand and right-hand usage.
- The device holder for handheld mobile phones.
- Tissue simulating liquid mixed according to the given recipes.
- System check dipoles allowing to validate the proper functioning of the system.

2.2 Test environment

The DASY measurement system is placed at the head end of a room with dimensions: 5 x 2.5 x 3 m³, the SAM phantom is placed in a distance of 75 cm from the side walls and 1.1m from the rear wall. Above the test system a 1.5 x 1.5 m² array of pyramid absorbers is installed to reduce reflections from the ceiling.

Picture 1 of the photo documentation shows a complete view of the test environment.

The system allows the measurement of SAR values larger than 0.005 mW/g.

2.3 Data Acquisition Electronics description

The data acquisition electronics (DAE) consist of a highly sensitive electrometer-grade preamplifier with auto-zeroing, a channel and gain-switching multiplexer, a fast 16 bit AD-converted and a command decoder with a control logic unit. Transmission to the measurement server is accomplished through an optical downlink for data and status information, as well as an optical uplink for commands and the clock.

The mechanical probe mounting device includes two different sensor systems for frontal and sideways Probe contacts. They are used for mechanical surface detection and probe collision detection.

DAE

Input Impedance	200MOhm	
The Inputs	symmetrical and floating	
Common mode rejection	above 80 dB	

2.4 Probe description

These probes are specially designed and calibrated for use in liquids with high permittivities. They should not be used in air, since the spherical isotropy in air is poor (± 2 dB). The dosimetric probes have special calibrations in various liquids at different frequencies.

Isotropic E-Field Probe ES3DV3 for Dosimetric Measurements

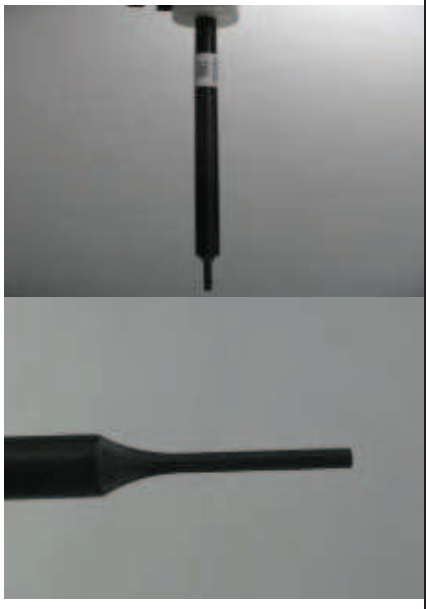
Construction	Symmetrical design with triangular core Interleaved sensors Built-in shielding against static charges PEEK enclosure material (resistant to organic solvents, e.g., DGBE)	
Calibration	ISO/IEC 17025 calibration service available.	
Frequency	10 MHz to 4 GHz; Linearity: ± 0.2 dB (30 MHz to 4 GHz)	
Directivity	± 0.2 dB in HSL (rotation around probe axis) ± 0.3 dB in tissue material (rotation normal to probe axis)	
Dynamic range	5 μ W/g to > 100 mW/g; Linearity: ± 0.2 dB	
Dimensions	Overall length: 337 mm (Tip: 20 mm) Tip diameter: 3.9 mm (Body: 12 mm) Distance from probe tip to dipole centers: 2.0 mm	
Application	General dosimetry up to 4 GHz Dosimetry in strong gradient fields Compliance tests of mobile phones	

Isotropic E-Field Probe EX3DV4 for Dosimetric Measurements

Construction	Symmetrical design with triangular core Built-in shielding against static charges PEEK enclosure material (resistant to organic solvents, e.g., DGBE)	
Calibration	ISO/IEC 17025 calibration service available.	
Frequency	10 MHz to >6 GHz; Linearity: ± 0.2 dB (30 MHz to 6 GHz)	
Directivity	± 0.3 dB in HSL (rotation around probe axis) ± 0.5 dB in tissue material (rotation normal to probe axis)	
Dynamic range	10 μ W/g to > 100 mW/g; Linearity: ± 0.2 dB (noise: typically < 1 μ W/g)	
Dimensions	Overall length: 337 mm (Tip: 20 mm) Tip diameter: 2.5 mm (Body: 12 mm) Typical distance from probe tip to dipole centers: 1mm	
Application	High precision dosimetric measurements in any exposure scenario (e.g., very strong gradient fields). Only probe which enables compliance testing for frequencies up to 6 GHz with precision of better 30%	

2.5 Phantom description

SAM Twin Phantom

Shell Thickness	2mm±0.2mm;The ear region:6.0±0.2mm	
Filling Volume	Approximately 25 liters	
Dimensions	Length:1000mm; Width:500mm; Height: adjustable feet	
Measurement Areas	Left hand Right hand Flat phantom	

The bottom plate contains three pairs of bolts for locking the device holder. The device holder positions are adjusted to the standard measurement positions in the three sections.

A white cover is provided to cover the phantom during off-periods to prevent water evaporation and changes in the liquid parameters. Free space scans of devices on top of this phantom cover are possible. Three reference marks are provided on the phantom counter. These reference marks are used to teach the absolute phantom position relative to the robot.

The following figure shows the definition of reference point:

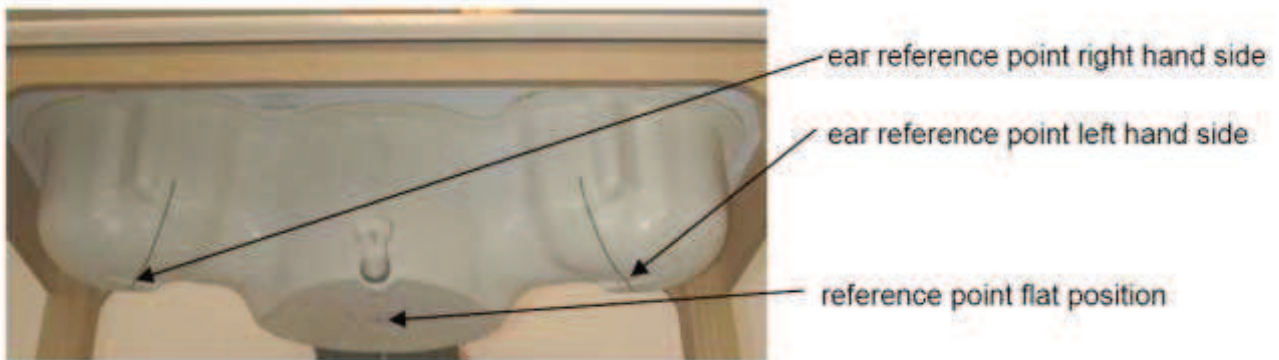

ELI4 Phantom

Shell Thickness	2mm±0.2mm	
Filling Volume	Approximately 30 liters	
Dimensions	Major axis:600mm; Minor axis:400mm;	
Measurement Areas	Flat phantom	

The ELI4 phantom is intended for compliance testing of handheld and body-mounted wireless devices in the frequency range of 30MHz to 6GHz. ELI4 is fully compatible with the latest draft of the standard IEC 62209-2 and all known tissue simulating liquids.

The phantom shell material is resistant to all ingredients used in the tissue-equivalent liquid recipes. The shell of the phantom including ear spacers is constructed from low permittivity and low loss material, with a relative permittivity $2 \leq \epsilon_r \leq 5$ at ≤ 3 GHz, $3 \leq \epsilon_r \leq 4$ at > 3 GHz and a loss tangent ≤ 0.05 .

Modular Triple Flat Phantom

Shell Thickness (bottom plate)	2mm±0.2mm	
Filling Volume (Module)	approx. 8.1 liters (filling height: 155 mm)	
Dimensions	Length: 292 mm Width: 178 mm Height: 178 mm Useable area: 280 × 175 mm	
Measurement Areas	Flat phantom	
<p>The Modular Flat Phantom consists of three identical modules that can be installed and removed separately without emptying the liquid. It is used for compliance testing of small wireless devices in body-worn configurations according to IEC 62209-2, etc.</p>		

2.6 Device holder description

The DASY device holder has two scales for device rotation (with respect to the body axis) and the device inclination (with respect to the line between the ear openings). The plane between the ear openings and the mouth tip has a rotation angle of 65°. The bottom plate contains three pair of bolts for locking the device holder. The device holder positions are adjusted to the standard measurement positions in the three sections. This device holder is used for standard mobile phones or PDA's only. If necessary an additional support of polystyrene material is used.



The DASY device holder is constructed of low-loss POM material having the following dielectric parameters: relative permittivity $\epsilon = 3$ and loss tangent $\sigma = 0.02$. The amount of dielectric material has been reduced in the closest vicinity of the device, since measurements have suggested that the influence of the clamp on the test results could thus be lowered.

The device holder permits the device to be positioned with a tolerance of $\pm 1^\circ$ in the tilt angle.

Larger DUT's (e.g. notebooks) cannot be tested using this device holder. Instead a support of bigger polystyrene cubes and thin polystyrene plates is used to position the DUT in all relevant positions to find and measure spots with maximum SAR values.

Therefore those devices are normally only tested at the flat part of the SAM.

2.7 Test Equipment List

This table gives a complete overview of the SAR measurement equipment.

Devices used during the test described are marked

<input checked="" type="checkbox"/>	Manufacturer	Device	Type	Serial number	Date of last calibration	Valid period
<input checked="" type="checkbox"/>	SPEAG	Dosimetric E-Field Probe	EX3DV4	3744	2018-07-25	One year
<input checked="" type="checkbox"/>	SPEAG	Dosimetric E-Field Probe	EX3DV4	3743	2018-11-19	One year
<input checked="" type="checkbox"/>	SPEAG	Dosimetric E-Field Probe	ES3DV3	3168	2018-09-27	One year
<input checked="" type="checkbox"/>	SPEAG	Dosimetric E-Field Probe	EX3DV4	7505	2018-06-12	One year
<input checked="" type="checkbox"/>	SPEAG	Dosimetric E-Field Probe	EX3DV4	7381	2018-09-28	One year
<input checked="" type="checkbox"/>	SPEAG	Dosimetric E-Field Probe	EX3DV4	3736	2018-04-27	One year
<input checked="" type="checkbox"/>	SPEAG	Dosimetric E-Field Probe	EX3DV4	7489	2018-01-09	One year
<input checked="" type="checkbox"/>	SPEAG	750 MHz Dipole	D750V3	1044	2018-09-18	Three years
<input checked="" type="checkbox"/>	SPEAG	835 MHz Dipole	D835V2	4d059	2016-04-20	Three years
<input checked="" type="checkbox"/>	SPEAG	1750 MHz Dipole	D1750V2	1123	2017-07-27	Three years
<input checked="" type="checkbox"/>	SPEAG	1900 MHz Dipole	D1900V2	5d091	2018-09-19	Three years
<input checked="" type="checkbox"/>	SPEAG	1900 MHz Dipole	D1900V2	5d143	2017-09-20	Three years
<input checked="" type="checkbox"/>	SPEAG	2450 MHz Dipole	D2450V2	860	2018-11-17	Three years
<input checked="" type="checkbox"/>	SPEAG	2600 MHz Dipole	D2600V2	1021	2018-07-26	Three years
<input checked="" type="checkbox"/>	SPEAG	2600 MHz Dipole	D2600V2	1032	2018-09-17	Three years
<input checked="" type="checkbox"/>	SPEAG	5GHz Dipole	D5GHzV2	1155	2018-06-08	Three years
<input checked="" type="checkbox"/>	SPEAG	5GHz Dipole	D5GHzV2	1278	2018-04-30	Three years
<input checked="" type="checkbox"/>	SPEAG	Data acquisition electronics	DAE4	852	2018-04-23	One year
<input checked="" type="checkbox"/>	SPEAG	Data acquisition electronics	DAE4	1235	2018-11-14	One year
<input checked="" type="checkbox"/>	SPEAG	Data acquisition electronics	DAE4	1492	2018-11-14	One year
<input checked="" type="checkbox"/>	SPEAG	Data acquisition electronics	DAE4	1554	2018-06-05	One year
<input checked="" type="checkbox"/>	SPEAG	Data acquisition electronics	DAE4	1236	2018-07-18	One year
<input checked="" type="checkbox"/>	SPEAG	Data acquisition electronics	DAE4	851	2018-07-18	One year
<input checked="" type="checkbox"/>	SPEAG	Software	DASY52	N/A	NCR	NCR
<input checked="" type="checkbox"/>	SPEAG	Twin Phantom	SAM2	1474	NCR	NCR
<input checked="" type="checkbox"/>	SPEAG	Twin Phantom	SAM3	1597	NCR	NCR
<input checked="" type="checkbox"/>	SPEAG	Twin Phantom	SAM4	1620	NCR	NCR
<input checked="" type="checkbox"/>	SPEAG	Twin Phantom	SAM5	1892	NCR	NCR
<input checked="" type="checkbox"/>	SPEAG	Twin Phantom	SAM7	1594	NCR	NCR
<input checked="" type="checkbox"/>	SPEAG	Twin Phantom	SAM8	1940	NCR	NCR
<input checked="" type="checkbox"/>	SPEAG	Twin Phantom	SAM9	1958	NCR	NCR
<input checked="" type="checkbox"/>	SPEAG	Triple Flat Phantom	Triple Flat Phantom 5.1C	1176/2	NCR	NCR
<input checked="" type="checkbox"/>	R & S	Universal Radio Communication Tester	CMW 500	158850	2018-05-08	One year
<input checked="" type="checkbox"/>	R & S	Universal Radio Communication Tester	CMW 500	165424	2018-07-07	One year
<input checked="" type="checkbox"/>	Anritsu	Signal Analyzer	MS2690A	6261767335	2018-03-15	One year
<input checked="" type="checkbox"/>	Anritsu	Radio Communication Analyzer	MT8821C	6201735100	2018-03-15	One year
<input checked="" type="checkbox"/>	Anritsu	Radio Communication Analyzer	MT8821C	6201830585	2018-05-30	One year
<input checked="" type="checkbox"/>	Agilent	Network Analyzer	E5071C	MY46107368	2018-10-15	One year
<input checked="" type="checkbox"/>	Agilent	Dielectric Probe Kit	85070E	2484	NCR	NCR
<input checked="" type="checkbox"/>	Agilent	Signal Generator	N5181A	MY50145341	2018-12-18	One year
<input checked="" type="checkbox"/>	MINI-	Amplifier	ZHL-42W	QA1402001	NCR	NCR

	CIRCUITS					
<input checked="" type="checkbox"/>	MINI-CIRCUITS	Amplifier	ZVE-8G+	188163	NCR	NCR
<input checked="" type="checkbox"/>	SHX	Dual Directional Coupler	DDTO-4-20	17121801	2018-12-13	One year
<input checked="" type="checkbox"/>	Agilent	Dual Directional Coupler	772D	MY52180173	2018-12-13	One year
<input checked="" type="checkbox"/>	AR	Directional Coupler	DC7144M1	311190	2018-05-29	One year
<input checked="" type="checkbox"/>	Agilent	Power Meter	E4417A	MY54100027	2018-03-24	One year
<input checked="" type="checkbox"/>	Keysight	Power Meter Sensor	E9321A	MY57150002	2018-03-15	One year
<input checked="" type="checkbox"/>	R & S	Power Meter	NRP	100740	2018-07-17	One year
<input checked="" type="checkbox"/>	R & S	Power Meter Sensor	NRP-Z11	106288	2018-07-17	One year

Table 4: List of Test Equipment(Test date: 2019-01-02~2019-01-12)

	Manufacturer	Device	Type	Serial number	Date of last calibration	Valid period
<input checked="" type="checkbox"/>	R & S	Power Meter	NRP	100740	2019-07-04	One year
<input checked="" type="checkbox"/>	R & S	Power Meter Sensor	NRP-Z11	106288	2019-07-04	One year

Table 5: List of Test Equipment(Test date: 2020-04-08)

Note:

- 1) Per KDB865664 D01 requirements for dipole calibration, the test laboratory has adopted three-year extended calibration interval. Each measured dipole is expected to evaluate with the following criteria at least on annual interval in Appendix C.
 - a) There is no physical damage on the dipole;
 - b) System check with specific dipole is within 10% of calibrated value;
 - c) The most recent return-loss result, measured at least annually, deviates by no more than 20% from the previous measurement.
 - d) The most recent measurement of the real or imaginary parts of the impedance, measured at least annually is within 5Ω from the previous measurement.
- 2) Network analyzer probe calibration against air, distilled water and a shorting block performed before measuring liquid parameters.
- 3) *All the equipment are within the valid period when the tests are performed.

3 SAR Measurement Procedure

3.1 Scanning procedure

The DASY installation includes predefined files with recommended procedures for measurements and system check. They are read-only document files and destined as fully defined but unmeasured masks. All test positions (head or body-worn) are tested with the same configuration of test steps differing only in the grid definition for the different test positions.

- The “reference” and “drift” measurements are located at the beginning and end of the batch process. They measure the field drift at one single point in the liquid over the complete procedure. The indicated drift is mainly the variation of the DUT’s output power and should vary max. +/- 5 %.
- For power drift measurement, DASY software supports that the reference position can be either the selected section’s grid reference point or a user point. If the E-field of power reference measurement in the default grid reference point is very small, the test lab may set the reference position to the user point near the hotspot location to avoid large measurement uncertainty.
- The “surface check” measurement tests the optical surface detection system of the DASY system by repeatedly detecting the surface with the optical and mechanical surface detector and comparing the results. The output gives the detecting heights of both systems, the difference between the two systems and the standard deviation of the detection repeatability. Air bubbles or refraction in the liquid due to separation of the sugar-water mixture gives poor repeatability (above $\pm 0.1\text{mm}$). To prevent wrong results tests are only executed when the liquid is free of air bubbles. The difference between the optical surface detection and the actual surface depends on the probe and is specified with each probe. (It does not depend on the surface reflectivity or the probe angle to the surface within $\pm 30^\circ$.)
- The “area scan” measures the SAR above the DUT or verification dipole on a parallel plane to the surface. It is used to locate the approximate location of the peak SAR with 2D spline interpolation. The robot performs a stepped movement along one grid axis while the local electrical field strength is measured by the probe. The probe is touching the surface of the SAM during acquisition of measurement values. The standard scan uses large grid spacing for faster measurement. Standard grid spacing for head measurements is 15 mm in x- and y- dimension ($\leq 2\text{GHz}$), 12 mm in x- and y- dimension (2-4 GHz) and 10mm in x- and y- dimension (4-6GHz). If a finer resolution is needed, the grid spacing can be reduced. Grid spacing and orientation have no influence on the SAR result. For special applications where the standard scan method does not find the peak SAR within the grid, e.g. mobile phones with flip cover, the grid can be adapted in orientation. Results of this coarse scan are shown in Appendix B.
- A “zoom scan” measures the field in a volume around the 2D peak SAR value acquired in the previous “coarse” scan. This is a fine grid with maximum scan spatial resolution: $\Delta x_{\text{zoom}}, \Delta y_{\text{zoom}} \leq 2\text{GHz} - \leq 8\text{mm}$, 2-4GHz - $\leq 5\text{ mm}$ and 4-6 GHz- $\leq 4\text{mm}$; $\Delta z_{\text{zoom}} \leq 3\text{GHz} - \leq 5\text{ mm}$, 3-4 GHz- $\leq 4\text{mm}$ and 4-6GHz- $\leq 2\text{mm}$ where the robot additionally moves the probe along the z-axis away from the bottom of the Phantom. DASY is also able to perform repeated zoom scans if more than 1 peak is found during area scan. In this document, the evaluated peak 1g and 10g averaged SAR values are shown in the 2D-graphics in Appendix B. Test results relevant for the specified standard (see chapter 1.4.) are shown in table form in chapter 7.2.
- A Z-axis scan measures the total SAR value at the x-and y-position of the maximum SAR value found during the cube scan. The probe is moved away in z-direction from the bottom of the SAM phantom in 2 mm steps. This measurement shows the continuity of the liquid and can - depending in the field strength – also show the liquid depth. A z-axis scan of the measurement with maximum SAR value is shown in Appendix B.

The following table summarizes the area scan and zoom scan resolutions per FCC KDB865664 D01:

Frequency	Maximum Area Scan resolution ($\Delta x_{area}, \Delta y_{area}$)	Maximum Zoom Scan spatial resolution ($\Delta x_{zoom}, \Delta y_{zoom}$)	Maximum Zoom Scan spatial resolution			Minimum zoom scan volume (x,y,z)
			Uniform Grid	Graded Grad		
			$\Delta z_{zoom}(n)$	$\Delta z_{zoom}(1)^*$	$\Delta z_{zoom}(n>1)^*$	
≤2GHz	≤15mm	≤8mm	≤5mm	≤4mm	$\leq 1.5 * \Delta z_{zoom}(n-1)$	≥30mm
2-3GHz	≤12mm	≤5mm	≤5mm	≤4mm	$\leq 1.5 * \Delta z_{zoom}(n-1)$	≥30mm
3-4GHz	≤12mm	≤5mm	≤4mm	≤3mm	$\leq 1.5 * \Delta z_{zoom}(n-1)$	≥28mm
4-5GHz	≤10mm	≤4mm	≤3mm	≤2.5mm	$\leq 1.5 * \Delta z_{zoom}(n-1)$	≥25mm
5-6GHz	≤10mm	≤4mm	≤2mm	≤2mm	$\leq 1.5 * \Delta z_{zoom}(n-1)$	≥22mm

3.2 Spatial Peak SAR Evaluation

The spatial peak SAR - value for 1 and 10 g is evaluated after the Cube measurements have been done. The basis of the evaluation are the SAR values measured at the points of the fine cube grid consisting of 5 x 5 x 7 points (with 8mm horizontal resolution) or 7 x 7 x 7 points (with 5mm horizontal resolution) or 8 x 8 x 7 points (with 4mm horizontal resolution). The algorithm that finds the maximal averaged volume is separated into three different stages.

- The data between the dipole center of the probe and the surface of the phantom are extrapolated. This data cannot be measured since the center of the dipole is 2.7 mm away from the tip of the probe and the distance between the surface and the lowest measuring point is about 1 mm (see probe calibration sheet). The extrapolated data from a cube measurement can be visualized by selecting 'Graph Evaluated'.
- The maximum interpolated value is searched with a straight-forward algorithm. Around this maximum the SAR - values averaged over the spatial volumes (1g or 10 g) are computed using the 3d-spline interpolation algorithm. If the volume cannot be evaluated (i.e., if a part of the grid was cut off by the boundary of the measurement area) the evaluation will be started on the corners of the bottom plane of the cube.
- All neighboring volumes are evaluated until no neighboring volume with a higher average value is found.

Extrapolation

The extrapolation is based on a least square algorithm [W. Gander, Computermathematik, p.168-180]. Through the points in the first 3 cm along the z-axis, polynomials of order four are calculated. These polynomials are then used to evaluate the points between the surface and the probe tip. The points, calculated from the surface, have a distance of 1 mm from each other.

Interpolation

The interpolation of the points is done with a 3d-Spline. The 3d-Spline is composed of three one-dimensional splines with the "Not a knot"-condition [W. Gander, Computermathematik, p.141-150] (x, y and z -direction) [Numerical Recipes in C, Second Edition, p.123ff].

Volume Averaging

At First the size of the cube is calculated. Then the volume is integrated with the trapezoidal algorithm. 8000 points (20x20x20) are interpolated to calculate the average.

Advanced Extrapolation

DASY uses the advanced extrapolation option which is able to compensate boundary effects on E-field probes.

3.3 Data Storage and Evaluation

Data Storage

The DASY software stores the acquired data from the data acquisition electronics as raw data (in microvolt readings from the probe sensors), together with all necessary software parameters for the data evaluation (probe calibration data, liquid parameters and device frequency and modulation data) in measurement files with the extension "DAE". The software evaluates the desired unit and format for output each time the data is visualized or exported. This allows verification of the complete software setup even after the measurement and allows correction of incorrect parameter settings. For example, if a measurement has been performed with a wrong crest factor parameter in the device setup, the parameter can be corrected afterwards and the data can be re-evaluated.

The measured data can be visualized or exported in different units or formats, depending on the selected probe type ([V/m], [A/m], [°C], [mW/g], [mW/cm²], [dBrel], etc.). Some of these units are not available in certain situations or show meaningless results, e.g., a SAR output in a lossless media will always be zero. Raw data can also be exported to perform the evaluation with other software packages.

Data Evaluation by SEMCAD

The SEMCAD software automatically executes the following procedures to calculate the field units from the microvolt readings at the probe connector. The parameters used in the evaluation are stored in the configuration modules of the software:

Probe parameters:	- Sensitivity	Norm _i , a _{i0} , a _{i1} , a _{i2}
	- Conversion factor	ConvF _i
	- Diode compression point	Dcpi
Device parameters:	- Frequency	f
	- Crest factor	cf
Media parameters:	- Conductivity	σ
	- Density	ρ

These parameters must be set correctly in the software. They can be found in the component documents or they can be imported into the software from the configuration files issued for the DASY components. In the direct measuring mode of the multimeter option, the parameters of the actual system setup are used. In the scan visualization and export modes, the parameters stored in the corresponding document files are used.

The first step of the evaluation is a linearization of the filtered input signal to account for the compression characteristics of the detector diode. The compensation depends on the input signal, the diode type and the DC-transmission factor from the diode to the evaluation electronics.

If the exciting field is pulsed, the crest factor of the signal must be known to correctly compensate for peak power. The formula for each channel can be given as:

$$V_i = U_i + U_i^2 \cdot cf/dcp_i$$

with	V _i	= compensated signal of channel i	(i = x, y, z)
	U _i	= input signal of channel i	(i = x, y, z)
	cf	= crest factor of exciting field (DASY parameter)	
	dcp _i	= diode compression point	(DASY parameter)

From the compensated input signals the primary field data for each channel can be

evaluated:

$$E_i = (V_i / Norm_i \cdot ConvF)^{1/2}$$

$$H_i = (V_i)^{1/2} \cdot (a_{i0} + a_{i1}f + a_{i2}f^2)/f$$

with V_i = compensated signal of channel i (i = x, y, z)
 $Norm_i$ = sensor sensitivity of channel i (i = x, y, z)
[mV/ (V/m)²] for E-field Probes
ConvF = sensitivity enhancement in solution
 a_{ij} = sensor sensitivity factors for H-field probes
f = carrier frequency [GHz]
 E_i = electric field strength of channel i in V/m
 H_i = magnetic field strength of channel i in A/m

The RSS value of the field components gives the total field strength (Hermitian magnitude):

$$E_{tot} = (E_x^2 + E_y^2 + E_z^2)^{1/2}$$

The primary field data are used to calculate the derived field units.

$$SAR = (E_{tot}^2 \cdot \sigma) / (\rho \cdot 1000)$$

with SAR = local specific absorption rate in mW/g
 E_{tot} = total field strength in V/m
 σ = conductivity in [mho/m] or [Siemens/m]
 ρ = equivalent tissue density in g/cm³

Note that the density is normally set to 1 (or 1.06), to account for actual brain density rather than the density of the simulation liquid. The power flow density is calculated assuming the excitation field to be a free space field.

$$P_{pwe} = E_{tot}^2 / 3770 \quad \text{or} \quad P_{pwe} = H_{tot}^2 \cdot 37.7$$

with P_{pwe} = equivalent power density of a plane wave in mW/cm²
 E_{tot} = total electric field strength in V/m
 H_{tot} = total magnetic field strength in A/m

4 System Verification Procedure

4.1 Tissue Verification

The simulating liquids should be checked at the beginning of a series of SAR measurements to determine if the dielectric parameters are within the tolerances of the specified target values. The measured conductivity and relative permittivity should be within $\pm 5\%$ of the target values.

The following materials are used for producing the tissue-equivalent materials.

Ingredients (% of weight)	Head Tissue					
Frequency Band (MHz)	750	835	1750	1900	2450	2600
Water	39.2	41.45	52.64	55.242	62.7	55.242
Salt (NaCl)	2.7	1.45	0.36	0.306	0.5	0.306
Sugar	57.0	56.0	0.0	0.0	0.0	0.0
HEC	0.0	1.0	0.0	0.0	0.0	0.0
Bactericide	0.0	0.1	0.0	0.0	0.0	0.0
Triton X-100	0.0	0.0	0.0	0.0	0.0	0.0
DGBE	0.0	0.0	47.0	44.542	36.8	44.452
Ingredients (% of weight)	Body Tissue					
Frequency Band (MHz)	750	835	1750	1900	2450	2600
Water	50.3	52.4	69.91	69.91	73.2	64.493
Salt (NaCl)	1.60	1.40	0.13	0.13	0.04	0.024
Sugar	47.0	45.0	0.0	0.0	0.0	0.0
HEC	0.0	1.0	0.0	0.0	0.0	0.0
Bactericide	0.0	0.1	0.0	0.0	0.0	0.0
Triton X-100	0.0	0.0	0.0	0.0	0.0	0.0
DGBE	0.0	0.0	29.96	29.96	26.7	32.252

Table 6: Tissue Dielectric Properties

Salt: 99+% Pure Sodium Chloride; Sugar: 98+% Pure Sucrose; Water: De-ionized, 16M Ω + resistivity
 HEC: Hydroxyethyl Cellulose; DGBE: 99+% Di(ethylene glycol) butyl ether, [2-(2-butoxyethoxy)ethanol]
 Triton X-100(ultra pure): Polyethylene glycol mono [4-(1,1,3,3-tetramethylbutyl)phenyl]ether

Simulating Head Liquid (HBBL600-6000MHz), Manufactured by SPEAG:

Ingredients	(% by weight)
Water	50-65%
Esters, Emulsifiers, Inhibitors	10-30%
Sodium salt	8-25%

Simulating Body Liquid (MBBL600-6000MHz), Manufactured by SPEAG:

Ingredients	(% by weight)
Water	60-80%
Esters, Emulsifiers, Inhibitors	20-40%
Sodium salt	0-1.5%

Tissue Type	Target Frequency	Target Tissue		Measured Tissue		Deviation (Within +/-5%)		Liquid Temp.	Test Date
		Permit-tivity	Conduc-tivity [S/m]	Permit-tivity	Conduc-tivity [S/m]	$\Delta\epsilon_r$	$\Delta\sigma$		
750MHz Head	705	42.2	0.89	40.92	0.909	-2.98%	2.10%	22.0°C	2019-01-06
	710	42.1	0.89	40.90	0.910	-2.96%	2.22%		
	750	41.9	0.89	40.76	0.922	-2.82%	3.22%		
835MHz Head	825	41.6	0.90	42.31	0.932	1.82%	3.65%	21.0°C	2019-01-04
	835	41.5	0.90	42.28	0.936	1.88%	3.96%		
	850	41.5	0.92	42.25	0.941	1.81%	2.70%		
1750MHz Head	1710	40.1	1.35	38.83	1.346	-3.27%	-0.14%	21.5°C	2019-01-03
	1730	40.1	1.36	38.82	1.358	-3.22%	-0.11%		
	1750	40.1	1.37	38.79	1.370	-3.22%	-0.08%		
	1800	40.0	1.40	38.68	1.401	-3.30%	0.07%		
1900MHz Head	1850	40.0	1.40	39.29	1.433	-1.78%	2.36%	21.5°C	2019-01-02
	1880	40.0	1.40	39.27	1.447	-1.82%	3.36%		
	1900	40.0	1.40	39.21	1.458	-1.98%	4.14%		
	1910	40.0	1.40	39.19	1.465	-2.03%	4.64%		
1900MHz Head	1850	40.0	1.40	40.23	1.426	0.57%	1.86%	21.5°C	2019-01-04
	1880	40.0	1.40	40.13	1.441	0.33%	2.93%		
	1900	40.0	1.40	40.16	1.454	0.40%	3.86%		
	1910	40.0	1.40	40.18	1.459	0.45%	4.21%		
2450MHz Head	2410	39.3	1.76	38.06	1.769	-3.08%	0.26%	21.0°C	2019-01-06
	2435	39.2	1.79	38.02	1.786	-3.08%	-0.04%		
	2450	39.2	1.80	37.98	1.802	-3.11%	0.11%		
	2460	39.2	1.81	37.97	1.802	-3.11%	-0.49%		
2600MHz Head	2510	39.1	1.86	39.69	1.884	1.46%	1.29%	21.5°C	2019-01-04
	2535	39.1	1.89	39.64	1.903	1.38%	0.69%		
	2560	39.1	1.92	39.60	1.923	1.28%	0.16%		
	2600	39.0	1.96	39.54	1.952	1.38%	-0.41%		
	2610	39.0	1.97	39.52	1.960	1.39%	-0.51%		
	2645	38.9	2.01	39.45	1.990	1.34%	-1.00%		
5GHz Head	5250	35.9	4.71	34.92	4.570	-2.81%	-2.90%	22.5°C	2019-01-07
	5600	35.5	5.07	34.16	5.000	-3.85%	-1.28%		
	5750	35.4	5.22	33.90	5.119	-4.12%	-1.91%		
5GHz Head	5250	35.9	4.71	35.50	4.532	-1.19%	-3.70%	21.0°C	2019-01-08
	5600	35.5	5.07	34.89	4.909	-1.80%	-3.08%		
	5750	35.4	5.22	34.64	5.071	-2.03%	-2.83%		
750MHz Body	705	55.7	0.96	53.98	0.924	-3.10%	-3.74%	20.7°C	2019-01-03
	710	55.7	0.96	53.98	0.926	-3.07%	-3.61%		
	750	55.5	0.96	53.91	0.941	-2.92%	-2.35%		
750MHz Body	705	55.7	0.96	54.83	0.933	-1.57%	-2.77%	21.5°C	2019-01-09
	710	55.7	0.96	54.81	0.935	-1.57%	-2.60%		
	750	55.5	0.96	54.71	0.950	-1.48%	-1.39%		

835MHz Body	825	55.2	0.97	53.89	1.011	-2.44%	4.31%	21.0°C	2019-01-03
	835	55.2	0.97	53.87	1.014	-2.41%	4.54%		
	850	55.2	0.99	53.81	1.020	-2.44%	3.19%		
835MHz Body	825	55.2	0.97	53.24	0.999	-3.62%	3.06%	21.5°C	2019-01-06
	835	55.2	0.97	53.21	1.003	-3.61%	3.40%		
	850	55.2	0.99	53.15	1.009	-3.63%	2.08%		
1750MHz Body	1710	53.5	1.46	53.24	1.456	-0.55%	-0.49%	21.5°C	2019-01-04
	1730	53.5	1.48	53.23	1.475	-0.48%	-0.05%		
	1750	53.4	1.49	53.20	1.492	-0.43%	0.24%		
	1800	53.3	1.52	53.08	1.522	-0.41%	0.13%		
1750MHz Body	1710	53.5	1.46	52.23	1.463	-2.44%	-0.01%	21.5°C	2019-01-07
	1730	53.5	1.48	52.22	1.473	-2.36%	-0.19%		
	1750	53.4	1.49	52.22	1.482	-2.27%	-0.43%		
	1800	53.3	1.52	52.27	1.515	-1.93%	-0.33%		
1900MHz Body	1850	53.3	1.52	50.79	1.455	-4.71%	-4.28%	20.7°C	2019-01-03
	1880	53.3	1.52	50.74	1.475	-4.80%	-2.96%		
	1900	53.3	1.52	50.74	1.483	-4.80%	-2.43%		
	1910	53.3	1.52	50.74	1.488	-4.80%	-2.11%		
1900MHz Body	1850	53.3	1.52	53.04	1.468	-0.49%	-3.42%	20.7°C	2019-01-06
	1880	53.3	1.52	52.98	1.497	-0.60%	-1.51%		
	1900	53.3	1.52	52.93	1.514	-0.69%	-0.39%		
	1910	53.3	1.52	52.90	1.522	-0.75%	0.13%		
2450MHz Body	2410	52.8	1.91	53.87	1.995	2.12%	4.35%	21.0°C	2019-01-07
	2435	52.7	1.94	53.81	2.021	2.07%	4.41%		
	2450	52.7	1.95	53.77	2.035	2.03%	4.36%		
	2460	52.7	1.96	53.75	2.046	2.02%	4.17%		
2600MHz Body	2510	52.6	2.03	51.71	2.101	-1.73%	3.50%	20.7°C	2019-01-02
	2535	52.6	2.07	51.61	2.117	-1.86%	2.27%		
	2560	52.6	2.09	51.55	2.147	-1.94%	2.73%		
	2585	52.5	2.13	51.56	2.173	-1.85%	2.02%		
	2600	52.5	2.16	51.51	2.182	-1.89%	1.02%		
	2615	52.4	2.19	51.44	2.191	-1.87%	0.05%		
	2645	52.3	2.24	51.41	2.228	-1.63%	-0.54%		
2600MHz Body	2510	52.6	2.03	50.04	2.045	-4.90%	0.74%	22.0°C	2019-01-06
	2535	52.6	2.07	50.01	2.066	-4.91%	-0.19%		
	2560	52.6	2.09	49.96	2.089	-4.96%	-0.05%		
	2585	52.5	2.13	49.93	2.114	-4.95%	-0.75%		
	2600	52.5	2.16	49.91	2.127	-4.93%	-1.53%		
	2615	52.4	2.19	49.89	2.138	-4.83%	-2.37%		
	2645	52.3	2.24	49.82	2.169	-4.67%	-3.17%		
2600MHz Body	2510	52.6	2.03	50.91	2.123	-3.25%	4.58%	21.8°C	2019-01-09
	2535	52.6	2.07	50.88	2.147	-3.25%	3.72%		
	2560	52.6	2.09	50.82	2.169	-3.33%	3.78%		
	2585	52.5	2.13	50.74	2.197	-3.41%	3.15%		
	2600	52.5	2.16	50.72	2.211	-3.39%	2.36%		
	2615	52.4	2.19	50.71	2.223	-3.26%	1.51%		
	2645	52.3	2.24	50.63	2.250	-3.12%	0.45%		

2600MHz Body	2510	52.6	2.03	51.73	2.091	-1.69%	3.00%	21.5°C	2019-01-09
	2535	52.6	2.07	51.68	2.118	-1.73%	2.32%		
	2560	52.6	2.09	51.62	2.142	-1.81%	2.49%		
	2585	52.5	2.13	51.57	2.166	-1.83%	1.69%		
	2600	52.5	2.16	51.54	2.179	-1.83%	0.88%		
	2615	52.4	2.19	51.51	2.193	-1.74%	0.14%		
	2645	52.3	2.24	51.44	2.222	-1.57%	-0.80%		
5GHz Body	5250	48.9	5.36	47.71	5.335	-2.53%	-0.42%	22.5°C	2019-01-10
	5600	48.5	5.77	47.04	5.825	-2.95%	1.02%		
	5750	48.3	5.94	46.76	6.043	-3.12%	1.71%		
5GHz Body	5250	48.9	5.36	46.98	5.120	-4.02%	-4.44%	21.7°C	2019-01-10
	5600	48.5	5.77	46.40	5.589	-4.27%	-3.08%		
	5750	48.3	5.94	46.15	5.801	-4.39%	-2.37%		
5GHz Body	5250	48.9	5.36	47.09	5.288	-3.79%	-1.30%	21.5°C	2019-01-11
	5600	48.5	5.77	46.45	5.746	-4.17%	-0.35%		
	5750	48.3	5.94	46.17	5.948	-4.35%	0.11%		

Table 7: Measured Tissue Parameter

Note: 1) The dielectric parameters of the tissue-equivalent liquid should be measured under similar ambient conditions and within 2 °C of the conditions expected during the SAR evaluation to satisfy protocol requirements.

2) KDB865664 was ensured to be applied for probe calibration frequencies greater than or equal to 50MHz of the EUT frequencies.

3) The above measured tissue parameters were used in the DASY software to perform interpolation via the DASY software to determine actual dielectric parameters at the test frequencies. The SAR test plots may slightly differ from the table above since the DASY rounds to three significant digits.

4.2 System Check

The system check is performed for verifying the accuracy of the complete measurement system and performance of the software. The system check is performed with tissue equivalent material according to IEEE 1528 (described above). The following table shows system check results for all frequency bands and tissue liquids used during the tests (Graphic Plot(s) see Appendix A).

Dipole Information	System Check	Target SAR (Normalized to 1W)		Measured SAR (Normalized to 1W)		Deviation (Within +/-10%)		Test Date
		1-g (mW/g)	10-g (mW/g)	1-g (mW/g)	10-g (mW/g)	Δ1-g	Δ10-g	
1044	750MHz Head	8.24	5.34	7.68	5.00	-6.80%	-6.37%	2019-01-06
4d059	835MHz Head	9.30	6.05	9.92	6.44	6.67%	6.45%	2019-01-04
1123	1750MHz Head	36.60	19.40	33.64	17.72	-8.09%	-8.66%	2019-01-03
5d091	1900MHz Head	40.40	21.30	37.52	19.56	-7.13%	-8.17%	2019-01-02
5d091	1900MHz Head	40.40	21.30	38.12	19.84	-5.64%	-6.85%	2019-01-04
860	2450MHz Head	53.10	24.70	50.00	23.32	-5.84%	-5.59%	2019-01-06
1032	2600MHz Head	56.40	25.20	55.60	25.36	-1.42%	0.63%	2019-01-04
1155	5250MHz Head	81.40	23.50	79.20	22.80	-2.70%	-2.98%	2019-01-07
1155	5250MHz Head	81.40	23.50	75.30	21.60	-7.49%	-8.09%	2019-01-08
1155	5600MHz Head	85.20	24.30	83.80	23.90	-1.64%	-1.65%	2019-01-07
1155	5600MHz Head	85.20	24.30	84.30	23.90	-1.06%	-1.65%	2019-01-08
1155	5750MHz Head	78.40	22.30	75.90	22.00	-3.19%	-1.35%	2019-01-07
1155	5750MHz Head	78.40	22.30	73.30	20.90	-6.51%	-6.28%	2019-01-08
1044	750MHz Body	8.54	5.61	8.44	5.68	-1.17%	1.25%	2019-01-03
1044	750MHz Body	8.54	5.61	8.48	5.68	-0.70%	1.25%	2019-01-09
4d059	835MHz Body	9.41	6.20	9.76	6.40	3.72%	3.23%	2019-01-03
4d059	835MHz Body	9.41	6.20	9.72	6.32	3.29%	1.94%	2019-01-06
1123	1750MHz Body	36.40	19.40	34.24	18.64	-5.93%	-3.92%	2019-01-04
1123	1750MHz Body	36.40	19.40	34.64	18.92	-4.84%	-2.47%	2019-01-07
5d143	1900MHz Body	39.40	20.80	37.56	20.28	-4.67%	-2.50%	2019-01-03
5d143	1900MHz Body	39.40	20.80	38.72	20.96	-1.73%	0.77%	2019-01-06
860	2450MHz Body	51.60	24.20	50.00	22.76	-3.10%	-5.95%	2019-01-07
1032	2600MHz Body	55.10	24.50	55.20	25.00	0.18%	2.04%	2019-01-02
1032	2600MHz Body	55.10	24.50	50.00	22.72	-9.26%	-7.27%	2019-01-06
1021	2600MHz Body	55.70	25.00	56.80	25.36	1.97%	1.44%	2019-01-09
1032	2600MHz Body	55.10	24.50	56.80	25.60	3.09%	4.49%	2019-01-09
1155	5250MHz Body	74.70	20.90	72.50	21.30	-2.95%	1.91%	2019-01-10
1155	5250MHz Body	74.70	20.90	72.80	21.50	-2.54%	2.87%	2019-01-10
1278	5250MHz Body	76.60	21.40	79.30	22.20	3.52%	3.74%	2019-01-11
1155	5600MHz Body	79.60	22.10	73.30	21.40	-7.91%	-3.17%	2019-01-10
1155	5600MHz Body	79.60	22.10	77.40	23.40	-2.76%	5.88%	2019-01-10
1155	5750MHz Body	73.30	20.40	72.70	22.10	-0.82%	8.33%	2019-01-10
1155	5750MHz Body	73.30	20.40	70.90	20.40	-3.27%	0.00%	2019-01-11

Table 8: System Check Results

4.3 System check Procedure

The system check is performed by using a system check dipole which is positioned parallel to the planar part of the SAM phantom at the reference point. The distance of the dipole to the SAM phantom is determined by a plexiglass spacer. The dipole is connected to the signal source consisting of signal generator and amplifier via a directional coupler, N-connector cable and adaption to SAM. It is fed with a power of 250 mW (below 3GHz) or 100mW (3-6GHz). To adjust this power, a power meter is used. The power sensor is connected to the cable before the system check to measure the power at this point and do adjustments at the signal generator. At the outputs of the directional coupler both return loss as well as forward power are controlled during the system check to make sure that emitted power at the dipole is kept constant. This can also be checked by the power drift measurement after the test (result on plot). System check results have to be equal or near the values determined during dipole calibration (target SAR in table above) with the relevant liquids and test system.

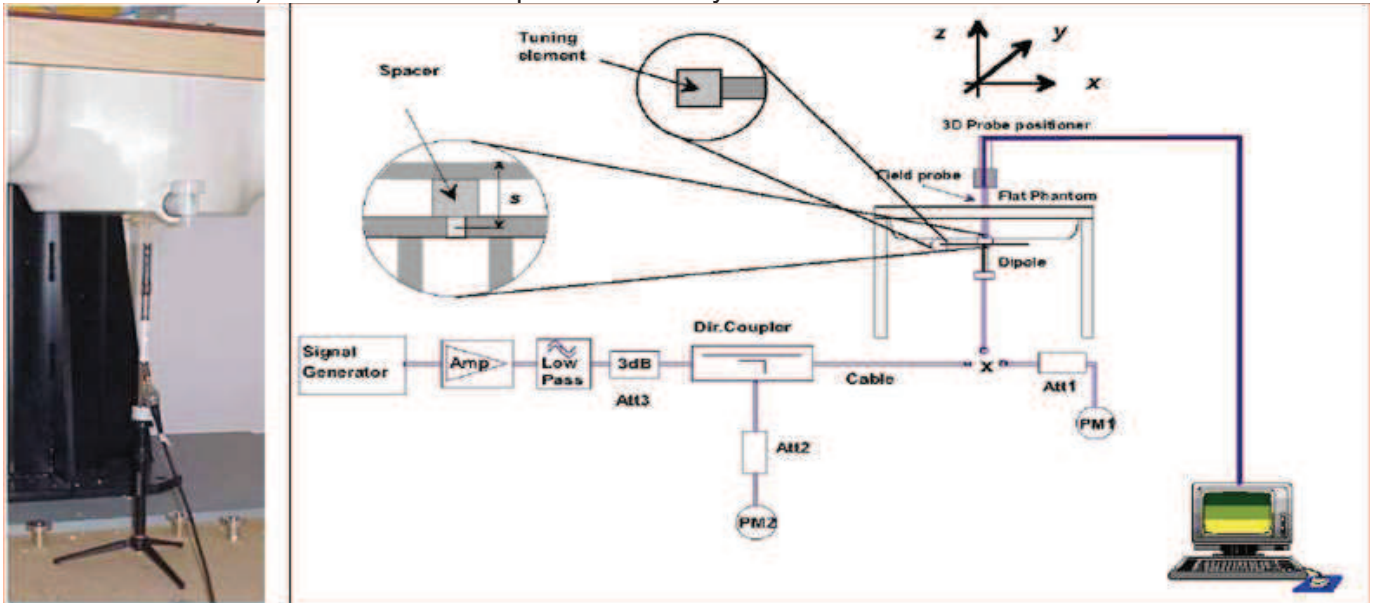

5 SAR measurement variability and uncertainty

5.1 SAR measurement variability

Per KDB865664 D01 SAR measurement 100 MHz to 6 GHz, SAR measurement variability must be assessed for each frequency band, which is determined by the SAR probe calibration point and tissue-equivalent medium used for the device measurements. The additional measurements are repeated after the completion of all measurements requiring the same head or body tissue-equivalent medium in a frequency band. The test device should be returned to ambient conditions (normal room temperature) with the battery fully charged before it is re-mounted on the device holder for the repeated measurement(s) to minimize any unexpected variations in the repeated results.

- 1) Repeated measurement is not required when the original highest measured SAR is < 0.80 W/kg; steps 2) through 4) do not apply.
- 2) When the original highest measured SAR is ≥ 0.80 W/kg, repeat that measurement once.
- 3) Perform a second repeated measurement only if the ratio of largest to smallest SAR for the original and first repeated measurements is > 1.20 or when the original or repeated measurement is ≥ 1.45 W/kg ($\sim 10\%$ from the 1-g SAR limit).
- 4) Perform a third repeated measurement only if the original, first or second repeated measurement is ≥ 1.5 W/kg and the ratio of largest to smallest SAR for the original, first and second repeated measurements is > 1.20 .

The same procedures should be adapted for measurements according to extremity and occupational exposure limits by applying a factor of 2.5 for extremity exposure and a factor of 5 for occupational exposure to the corresponding SAR thresholds.

The detailed repeated measurement results are shown in Section 7.2.

5.2 SAR measurement uncertainty

Per KDB865664 D01 SAR Measurement 100 MHz to 6 GHz, when the highest measured 1-g SAR within a frequency band is < 1.5 W/kg, the extensive SAR measurement uncertainty analysis described in IEEE Std 1528-2013 is not required in SAR reports submitted for equipment approval. The equivalent ratio (1.5/1.6) is applied to extremity and occupational exposure conditions.

6 SAR Test Configuration

6.1 Test Positions Configuration

6.1.1 General considerations

Per IEEE 1528-2013, two imaginary lines on the handset were established: the vertical centerline and the horizontal line (See Figure 1).

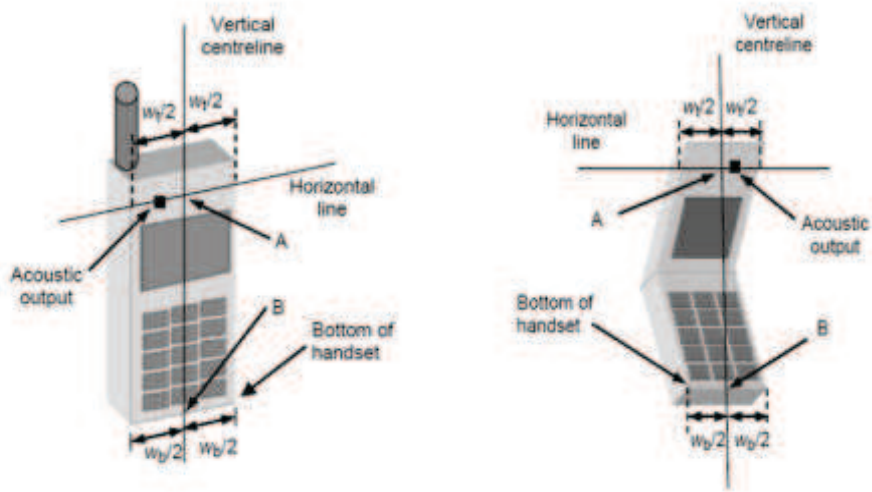

Figure 1 Hand Vertical Center & Horizontal Line Reference Points

6.1.2 Head Exposure Condition

Per IEEE 1528-2013, Head SAR measurements were made in the “cheek” position (See Figure 2) and the “tilt” position (See Figure 3). The device should be tested in both positions on left and right sides of the SAM phantom.

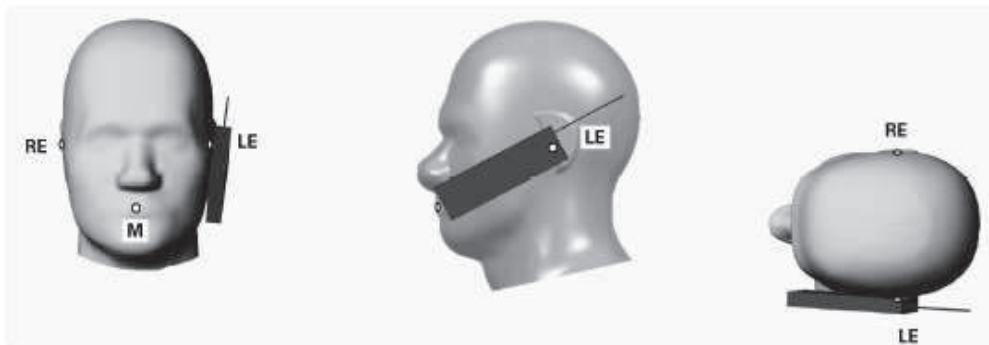

Figure 2 Front, Side and Top View of Cheek Position

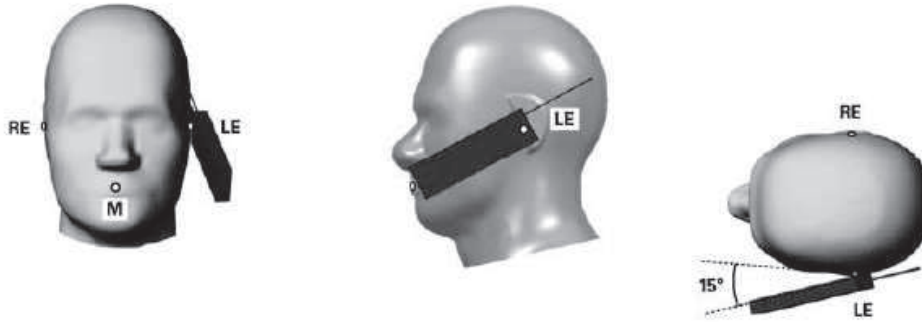

Figure 3 Front, Side and Top View of Tilt 15° Position

Note:

M Mouth reference point

LE Left ear reference point (ERP)

RE Right ear reference point(ERP)

For this device, the receiver is designed under the screen and invisible. In order to solve the head positioning issue and locate the receiver accurately during Head SAR test, the SAR test lab should follow the manufacturer specification and precisely identify the earpiece location and the best acoustic position on the handset. Then the Horizontal line and the Vertical center line should also be identified on the handset. The head SAR positioning procedure in section 6.4 of IEEE 1528-2013 is followed. (Refer to Appendix D Test photo and Appendix E The Position of Audio Receiver photo for details)

For Head SAR test, full SAR test is perform with the normal audio receiver position per IEEE 1528-2013 as above. Additional Head SAR spot check tests are also performed with the best acoustic position based on the Head SAR worst case of each Tx antenna to ensure SAR compliance.

6.1.3 Body-worn Exposure Condition

Body-worn operating configurations are tested with the holder attached to the device and positioned against a flat phantom with test separation distance of 15mm in a normal use configuration (See Figure 4). Per FCC KDB648474 D04, Body-worn accessory exposure is typically related to voice mode operations when handsets are carried in body-worn accessories. The body-worn accessory procedures in FCC KDB447498 should be used to test for body-worn accessory SAR compliance, without a headset connected to it. When the reported SAR for a body-worn accessory, measured without a headset connected to the handset, is $> 1.2 \text{ W/kg}$, the highest reported SAR configuration for that wireless mode and frequency band should be repeated for that body-worn accessory with a headset attached to the handset.

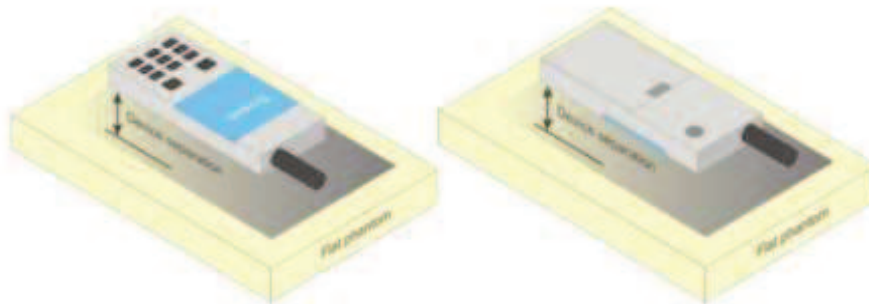

Figure 4 Test position for Body-Worn device

6.1.4 Hotspot Exposure Condition

Per FCC KDB941225 D06, the SAR test separation distance for hotspot mode is determined according to device form factor. When the overall length and width of a device is $> 9 \text{ cm} \times 5 \text{ cm}$, a test separation distance of 10 mm is required for hotspot mode SAR measurements. A test separation distance of 5 mm or less is required for smaller devices. Hotspot mode SAR is measured for all edges and surfaces of the device with a transmitting antenna located within 25 mm from that surface or edge; for the data modes, wireless technologies and frequency bands supporting hotspot mode. The SAR results are used to determine simultaneous transmission SAR test exclusion for hotspot mode; otherwise, simultaneous transmission SAR measurement is required.

6.1.5 Product Specific 10-g SAR Exposure Condition

Per FCC KDB648474 D04, for smart phones with a display diagonal dimension $> 15.0 \text{ cm}$ or an overall diagonal dimension $> 16.0 \text{ cm}$ that provide similar mobile web access and multimedia support found in mini-tablets or UMPC mini-tablets that support voice calls next to the ear, the device is marketed as “Phablet”.

The UMPC mini-tablet procedures must also be applied to test the SAR of all surfaces and edges with an antenna located at $\leq 25 \text{ mm}$ from that surface or edge, in direct contact with a flat phantom, for Product Specific 10-g SAR according to the body-equivalent tissue dielectric parameters in KDB 865664 to address interactive hand use exposure conditions. The UMPC mini-tablet 1-g SAR at 5 mm is not required. When hotspot mode applies, Product Specific 10-g SAR is required only for the surfaces

and edges with hotspot mode 1-g reported SAR > 1.2 W/kg; however, when power reduction applies to hotspot mode the measured SAR must be scaled to the maximum output power, including tolerance, allowed for phablet modes to compare with the 1.2 W/kg SAR test reduction threshold.

6.2 3G SAR Test Reduction Procedure

Per KDB941225 D01, in the following procedures, the mode tested for SAR is referred to as the primary mode. The equivalent modes considered for SAR test reduction are denoted as secondary modes. Both primary and secondary modes must be in the same frequency band. When the maximum output power and tune-up tolerance specified for production units in a secondary mode is $\leq \frac{1}{4}$ dB higher than the primary mode or when the highest *reported* SAR of the primary mode is scaled by the ratio of specified maximum output power and tune-up tolerance of secondary to primary mode and the adjusted SAR is ≤ 1.2 W/kg, SAR measurement is not required for the secondary mode. This is referred to as the 3G SAR test reduction procedure in the following SAR test guidance, where the primary mode is identified in the applicable wireless mode test procedures and the secondary mode is wireless mode being considered for SAR test reduction by that procedure. When the 3G SAR test reduction procedure is not satisfied, it is identified as “otherwise” in the applicable procedures; SAR measurement is required for the secondary mode.

6.3 GSM Test Configuration

SAR tests for GSM850 and GSM1900, a communication link is set up with a base station by air link. The power lever is set to “5” and “0” in SAR of GSM850 and GSM1900. The tests in the band of GSM850 and GSM1900 are performed in the mode of GPRS/EGPRS function. Since the GPRS class is 12 for this EUT, it has at most 4 timeslots in uplink and at most 4 timeslots in downlink, the maximum total timeslot is 5. The EGPRS class is 12 for this EUT, it has at most 4 timeslots in uplink, and at most 4 timeslots in downlink, the maximum total timeslot is 5.

When SAR tests for EGPRS mode is necessary, GMSK modulation should be used to minimize SAR measurement error due to higher peak-to-average power (PAR) ratios inherent in 8 PSK.

6.4 UMTS Test Configuration

1) Output Power Verification

Maximum output power is verified on the high, middle and low channels according to procedures described in section 5.2 of 3GPP TS 34.121, using the appropriate RMC or AMR with TPC (transmit power control) set to all “1’s” for WCDMA/HSDPA or by applying the required inner loop power control procedures to maintain maximum output power while HSUPA is active. Results for all applicable physical channel configurations (DPCCH, DPDCHn and spreading codes, HSDPA, HSPA) are required in the SAR report. All configurations that are not supported by the handset or cannot be measured due to technical or equipment limitations must be clearly identified.

2) WCDMA

a. Head SAR Measurements

SAR for next to the ear head exposure is measured using a 12.2 kbps RMC with TPC bits configured to all “1’s”. The 3G SAR test reduction procedure is applied to AMR configurations with 12.2 kbps RMC as the primary mode.

b. Body SAR Measurements

SAR for body-worn accessory configurations is measured using a 12.2 kbps RMC with TPC bits configured to all “1’s”. The 3G SAR test reduction procedure is applied to other spreading codes and multiple DPDCHn configurations supported by the handset with 12.2 kbps RMC as the primary mode

3) HSDPA

SAR for body exposure configurations is measured according to the “Body SAR Measurements” procedures of 3G device. When the maximum output power and tune-up tolerance specified for production units in a secondary mode is $\leq \frac{1}{4}$ dB higher than the primary mode or when the highest *reported* SAR of the primary mode is scaled by the ratio of specified maximum output power and tune-up tolerance of secondary to primary mode and the adjusted SAR is ≤ 1.2 W/kg, SAR measurement is not required for the secondary mode. This is referred to as the 3G SAR test reduction procedure in the following SAR test guidance, where the primary mode is identified in the applicable wireless mode test procedures and the secondary mode is wireless mode being considered for SAR test reduction by that procedure. When the 3G SAR test reduction procedure is not satisfied, it is identified as “otherwise” in the applicable procedures; SAR measurement is required for the secondary mode.

Per KDB941225 D01, the 3G SAR test reduction procedure is applied to HSDPA body configurations with 12.2 kbps RMC as the primary mode. Otherwise, SAR is measured for HSDPA using the HSDPA body SAR procedures for the highest reported SAR body exposure configuration in 12.2 kbps RMC.

HSDPA should be configured according to UE category of a test device. The number of HS-DSCH/HS-PDSCHs, HAPRQ processes, minimum inter-TTI interval, transport block sizes and RV coding sequence are defined by the H-set. To maintain a consistent test configuration and stable transmission condition, QPSK is used in the H-set for SAR testing. HS-DPCCH should be configured with a CQI feedback cycle of 4ms with a CQI repetition factor of 2 to maintain a constant rate of active CQI slots. The β_c and β_d gain factors for DPCCH and DPDCH were set according to the values in the below table, β_{hs} for HS-DPCCH is set automatically to the correct value when $\Delta ACK, \Delta NACK, \Delta CQI = 8$. The variation of the β_c / β_d ratio causes a power reduction at sub-tests 2 - 4.

Sub-test [Ⓢ]	β_c [Ⓢ]	β_d [Ⓢ]	β_d (SF) [Ⓢ]	β_c / β_d [Ⓢ]	β_{hs} (1) [Ⓢ]	CM(dB)(2) [Ⓢ]	MPR (dB) [Ⓢ]
1 [Ⓢ]	2/15 [Ⓢ]	15/15 [Ⓢ]	64 [Ⓢ]	2/15 [Ⓢ]	4/15 [Ⓢ]	0.0 [Ⓢ]	0 [Ⓢ]
2 [Ⓢ]	12/15(3) [Ⓢ]	15/15(3) [Ⓢ]	64 [Ⓢ]	12/15(3) [Ⓢ]	24/15 [Ⓢ]	1.0 [Ⓢ]	0 [Ⓢ]
3 [Ⓢ]	15/15 [Ⓢ]	8/15 [Ⓢ]	64 [Ⓢ]	15/8 [Ⓢ]	30/15 [Ⓢ]	1.5 [Ⓢ]	0.5 [Ⓢ]
4 [Ⓢ]	15/15 [Ⓢ]	4/15 [Ⓢ]	64 [Ⓢ]	15/4 [Ⓢ]	30/15 [Ⓢ]	1.5 [Ⓢ]	0.5 [Ⓢ]

Note 1: ΔACK , $\Delta NACK$ and $\Delta CQI = 8$ $A_{hs} = \beta_{hs} / \beta_c = 30/15$ $\beta_{hs} = 30/15 * \beta_c$ [Ⓢ]
Note 2: CM=1 for $\beta_c / \beta_d = 12/15$, $\beta_{hs} / \beta_c = 24/15$. For all other combinations of DPDCH, DPCCH and HS-DPCCH the MPR is based on the relative CM difference. This is applicable for only UEs that support HSDPA in release 6 and later releases.[Ⓢ]
Note 3: For subtest 2 the β_c / β_d ratio of 12/15 for the TFC during the measurement period (TF1, TF0) is achieved by setting the signalled gain factors for the reference TFC (TF1, TF1) to $\beta_c = 11/15$ and $\beta_d = 15/15$ [Ⓢ]

Table 9: Sub-tests for UMTS Release 5 HSDPA

The measurements were performed with a Fixed Reference Channel (FRC) and H-Set 1 QPSK.

Parameter	Value
Nominal average inf. bit rate	534 kbit/s
Inter-TTI Distance	3 TTI's
Number of HARQ Processes	2 Processes
Information Bit Payload	3202 Bits
MAC-d PDU size	336 Bits
Number Code Blocks	1 Block
Binary Channel Bits Per TTI	4800 Bits
Total Available SMLs in UE	19200 SMLs
Number of SMLs per HARQ Process	9600 SMLs
Coding Rate	0.67
Number of Physical Channel Codes	5

Table 10: settings of required H-Set 1 QPSK acc. to 3GPP 34.121

HS-DSCH Category	Maximum HS-DSCH Codes Received	Minimum Inter-TTI Interval	Maximum HS-DSCH Transport Block Bits/HS-DSCH TTI	Total Soft Channel Bits
1	5	3	7298	19200
2	5	3	7298	28800
3	5	2	7298	28800
4	5	2	7298	38400
5	5	1	7298	57600
6	5	1	7298	67200
7	10	1	14411	115200
8	10	1	14411	134400
9	15	1	25251	172800
10	15	1	27952	172800
11	5	2	3630	14400
12	5	1	3630	28800
13	15	1	34800	259200
14	15	1	42196	259200
15	15	1	23370	345600
16	15	1	27952	345600

Table 11: HSDPA UE category

4) HSUPA

SAR for body exposure configurations is measured according to the “Body SAR Measurements” procedures of 3G device. When the maximum output power and tune-up tolerance specified for production units in a secondary mode is $\leq \frac{1}{4}$ dB higher than the primary mode or when the highest reported SAR of the primary mode is scaled by the ratio of specified maximum output power and tune-up tolerance of secondary to primary mode and the adjusted SAR is ≤ 1.2 W/kg, SAR measurement is not required for the secondary mode.

Per KDB941225 D01, the 3G SAR test reduction procedure is applied to HSPA (HSUPA/HSDPA with RMC) body configurations with 12.2 kbps RMC as the primary mode. Otherwise, SAR is measured for HSPA using the HSPA body SAR procedures for the highest reported body exposure SAR configuration in 12.2 kbps RMC.

Due to inner loop power control requirements in HSDPA, a commercial communication test set should be used for the output power and SAR tests. The 12.2 kbps RMC, FRC H-set 1 and E-DCH configurations for HSDPA should be configured according to the values indicated below as well as other applicable procedures described in the ‘WCDMA Handset’ and ‘Release 5 HSDPA Data Device’ sections of 3G device.

Sub-test	β_c	β_d	β_d (SF)	β_c/β_d	$\beta_{hs}^{(1)}$	β_{ec}	β_{ed}	β_c (SF)	β_{ed} (code)	CM ⁽²⁾ (dB)	MP R (dB)	AG ⁽⁴⁾ Index	E-TFC I
1	11/15 ⁽³⁾	15/15 ⁽³⁾	64	11/15 ⁽³⁾	22/15	209/225	1039/225	4	1	1.0	0.0	20	75
2	6/15	15/15	64	6/15	12/15	12/15	94/75	4	1	3.0	2.0	12	67
3	15/15	9/15	64	15/9	30/15	30/15	$\beta_{ed1}:47/15$ $\beta_{ed2}:47/15$	4	2	2.0	1.0	15	92
4	2/15	15/15	64	2/15	4/15	2/15	56/75	4	1	3.0	2.0	17	71
5	15/15 ⁽⁴⁾	15/15 ⁽⁴⁾	64	15/15 ⁽⁴⁾	30/15	24/15	134/15	4	1	1.0	0.0	21	81

Note 1: $\Delta ACK, \Delta NACK$ and $\Delta CQI = 8$ $A_{hs} = \beta_{hs}/\beta_c = 30/15$ $\beta_{hs} = 30/15 * \beta_c$

Note 2: CM = 1 for $\beta_c/\beta_d = 12/15, \beta_{hs}/\beta_c = 24/15$. For all other combinations of DPDCH, DPCCH, HS-DPCCH, E-DPDCH and E-DPCCH the MPR is based on the relative CM difference

Note 3 : For subtest 1 the β_c/β_d ratio of 11/15 for the TFC during the measurement period (TF1, TF0) is achieved by setting the signalled gain factors for the reference TFC (TF1, TF1) to $\beta_c = 10/15$ and $\beta_d = 15/15$

Note 4 : For subtest 5 the β_c/β_d ratio of 15/15 for the TFC during the measurement period (TF1, TF0) is achieved by setting the signalled gain factors for the reference TFC (TF1, TF1) to $\beta_c = 14/15$ and $\beta_d = 15/15$

Note 5 : Testing UE using E-DPDCH Physical Layer category 1 Sub-test 3 is not required according to TS 25.306 Table 5.1g

Note 6: β_{ed} can not be set directly; it is set by Absolute Grant Value.

Table 12: Subtests for UMTS Release 6 HSUPA

UE E-DCH Category	Maximum E-DCH Codes Transmitted	Number of HARQ Processes	E-DCH TTI(ms)	Minimum Spreading Factor	Maximum E-DCH Transport Block Bits	Max Rate (Mbps)
1	1	4	10	4	7110	0.7296
2	2	8	2	4	2798	1.4592
	2	4	10	4	14484	
3	2	4	10	4	14484	1.4592
4	2	8	2	2	5772	2.9185
	2	4	10	2	20000	2.00
5	2	4	10	2	20000	2.00
6 (No DPDCH)	4	8	10	2SF2&2SF	11484	5.76
	4	4	2	4	20000	2.00
7 (No DPDCH)	4	8	2	2SF2&2SF	22996	?
	4	4	10	4	20000	?

NOTE: When 4 codes are transmitted in parallel, two codes shall be transmitted with SF2 and two with SF4. UE categories 1 to 6 support QPSK only. UE category 7 supports QPSK and 16QAM. (TS25.306-7.3.0).

Table 13: HSUPA UE category

5) DC-HSDPA

SAR is required for Rel. 8 DC-HSDPA when SAR is required for Rel. 5 HSDPA; otherwise, the 3G SAR test reduction procedure is applied to DC-HSDPA with 12.2 kbps RMC as the primary mode. Power is measured for DC-HSDPA according to the H-Set 12, FRC configuration in Table C.8.1.12 of 3GPP TS 34.121-1 to determine SAR test reduction. A primary and a Second serving HS-DSCH Cell are required to perform the power measurement and for the results to be acceptable.

The following tests were completed according to procedures in section 7.3.13 of 3GPP TS 34.108 v9.5.0. A summary of these settings are illustrated below:

Downlink Physical Channels are set as per 3GPP TS34.121-1 v9.0.0 E.5.0

Table E.5.0: Levels for HSDPA connection setup

Parameter During Connection setup	Unit	Value
P-CPICH_Ec/Ior	dB	-10
P-CCPCH and SCH_Ec/Ior	dB	-12
PICH_Ec/Ior	dB	-15
HS-PDSCH	dB	off
HS-SCCH_1	dB	off
DPCH_Ec/Ior	dB	-5
OCNS_Ec/Ior	dB	-3.1

Call is set up as per 3GPP TS34.108 v9.5.0 sub clause 7.3.13

The configurations of the fixed reference channels for HSDPA RF tests are described in 3GPP TS 34.121, annex C for FDD and 3GPP TS 34.122.

The measurements were performed with a Fixed Reference Channel (FRC) H-Set 12 with QPSK

Parameter	Value
Nominal average inf. bit rate	60 kbit/s
Inter-TTI Distance	1 TTI's
Number of HARQ Processes	6 Processes
Information Bit Payload	120 Bits
Number Code Blocks	1 Block
Binary Channel Bits Per TTI	960 Bits
Total Available SMLs in UE	19200 SMLs
Number of SMLs per HARQ Process	3200 SMLs
Coding Rate	0.15
Number of Physical Channel Codes	1

Table 14: settings of required H-Set 12 QPSK acc. to 3GPP 34.121

Note:

1. The RMC is intended to be used for DC-HSDPA mode and both cells shall transmit with identical parameters as listed in the table above.
2. Maximum number of transmission is limited to 1, i.e., retransmission is not allowed. The redundancy and constellation version 0 shall be used.

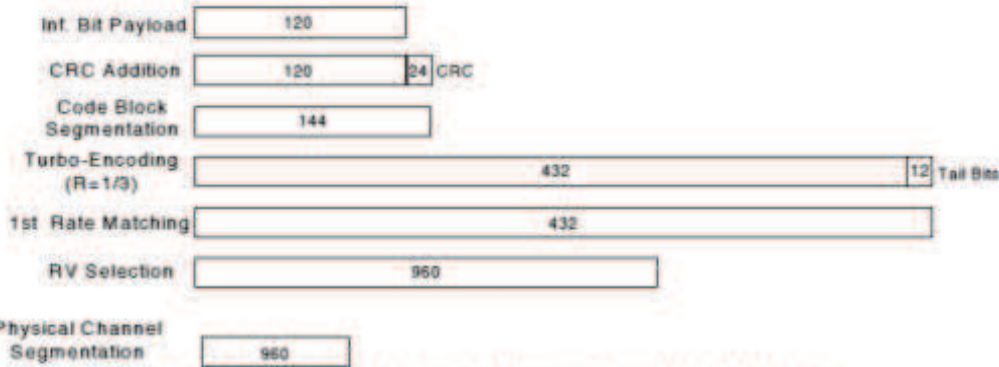

Figure C.8.19: Coding rate for Fixed reference Channel H-Set 12 (QPSK)

The following 4 Sub-tests for HSDPA were completed according to Release 5 procedures. A summary of subtest settings are illustrated below:

Sub-test ¹	β_{sp}	β_{sp}	β_{sf} (SF)	β_c/β_{sp}	β_{ms} (1)	CM(dB)(2)	MPR (dB)
1	2/15	15/15	64	2/15	4/15	0.0	0
2	12/15(3)	15/15(3)	64	12/15(3)	24/15	1.0	0
3	15/15	8/15	64	15/8	30/15	1.5	0.5
4	15/15	4/15	64	15/4	30/15	1.5	0.5

Note 1: Δ ACK, Δ NACK and Δ CQI=8. $A_{ms} = \beta_{ms}/\beta_c = 30/15$ $\beta_{ms} = 30/15 * \beta_c$
 Note 2: CM=1 for β_c/β_{sp} 12/15, $\beta_{ms}/\beta_c = 24/15$. For all other combinations of DPDCH, DPCCH and HS-DPCCH the MPR is based on the relative CM difference. This is applicable for only UEs that support HSDPA in release 6 and later releases.
 Note 3: For subtest 2 the β_c/β_{sp} ratio of 12/15 for the TFC during the measurement period (TF1, TF0) is achieved by setting the signalled gain factors for the reference TFC (TF1, TF1) to $\beta_c = 11/15$ and $\beta_{sp} = 15/15$

Up commands are set continuously to set the UE to Max power.

Note:

1. The Dual Carriers transmission only applies to HSDPA physical channels
2. The Dual Carriers belong to the same Node and are on adjacent carriers.
3. The Dual Carriers do not support MIMO to serve UEs configured for dual cell operation
4. The Dual Carriers operate in the same frequency band.
5. The device doesn't support the modulation of 16QAM in uplink but 64QAM in downlink for DC-HSDPA mode.
6. The device doesn't support carrier aggregation for it just can operate in Release 8.

6.5 LTE Test Configuration

SAR for LTE band exposure configurations is measured according to the procedures of KDB941225 D05 SAR for LTE Devices. The CMW500 Wideband Radio Communication Tester was used for LTE output power measurements and SAR testing. Closed loop power control was used so the UE transmits with maximum output power during SAR testing. SAR test were performed with the same number of RB and RB offsets transmitting on all TTI frames (Maximum TTI)

1) Spectrum Plots for RB configurations

A properly configured base station simulator was used for LTE output power measurements and SAR testing. Therefore, spectrum plots for RB configurations were not required to be included in this report.

2) MPR

When MPR is implemented permanently within the UE, regardless of network requirements, only those RB configurations allowed by 3GPP for the channel bandwidth and modulation combinations may be tested with MPR active. Configurations with RB allocations less than the RB thresholds required by 3GPP must be tested without MPR.

The allowed Maximum Power Reduction (MPR) for the maximum output power due to higher order modulation and transmit bandwidth configuration (resource blocks) is specified in 3GPP TS36.101.

Modulation	Channel bandwidth / Transmission bandwidth (N_{RB})						MPR (dB)
	1.4 MHz	3.0 MHz	5 MHz	10 MHz	15 MHz	20 MHz	
QPSK	> 5	> 4	> 8	> 12	> 16	> 18	≤ 1
16 QAM	≤ 5	≤ 4	≤ 8	≤ 12	≤ 16	≤ 18	≤ 1
16 QAM	> 5	> 4	> 8	> 12	> 16	> 18	≤ 2
64 QAM	≤ 5	≤ 4	≤ 8	≤ 12	≤ 16	≤ 18	≤ 2
64 QAM	> 5	> 4	> 8	> 12	> 16	> 18	≤ 3

3) A-MPR

A-MPR (Additional MPR) has been disabled for all SAR tests by using Network Signaling Value of "NS_01" on the base station simulator.

4) LTE procedures for SAR testing

A) Largest channel bandwidth standalone SAR test requirements

i) QPSK with 1 RB allocation

Start with the largest channel bandwidth and measure SAR for QPSK with 1 RB allocation, using the RB offset and required test channel combination with the highest maximum output power for RB offsets at the upper edge, middle and lower edge of each required test channel. When the reported SAR is ≤ 0.8 W/kg, testing of the remaining RB offset configurations and required test channels is not required for 1 RB allocation; otherwise, SAR is required for the remaining required test channels and only for the RB offset configuration with the highest output power for that channel. When the reported SAR of a required test channel is > 1.45 W/kg, SAR is required for all three RB offset configurations for that required test channel.

ii) QPSK with 50% RB allocation

The procedures required for 1 RB allocation in i) are applied to measure the SAR for QPSK with 50% RB allocation.

iii) QPSK with 100% RB allocation

For QPSK with 100% RB allocation, SAR is not required when the highest maximum output power for

100 % RB allocation is less than the highest maximum output power in 50% and 1 RB allocations and the highest reported SAR for 1 RB and 50% RB allocation in i) and ii) are ≤ 0.8 W/kg. Otherwise, SAR is measured for the highest output power channel and if the reported SAR is > 1.45 W/kg, the remaining required test channels must also be tested.

iv) Higher order modulations

For each modulation besides QPSK; e.g., 16-QAM, 64-QAM, apply the QPSK procedures in above sections to determine the QAM configurations that may need SAR measurement. For each configuration identified as required for testing, SAR is required only when the highest maximum output power for the configuration in the higher order modulation is $> \frac{1}{2}$ dB higher than the same configuration in QPSK or when the reported SAR for the QPSK configuration is > 1.45 W/kg.

B) Other channel bandwidth standalone SAR test requirements

For the other channel bandwidths used by the device in a frequency band, apply all the procedures required for the largest channel bandwidth in section A) to determine the channels and RB configurations that need SAR testing and only measure SAR when the highest maximum output power of a configuration requiring testing in the smaller channel bandwidth is $> \frac{1}{2}$ dB higher than the equivalent channel configurations in the largest channel bandwidth configuration or the reported SAR of a configuration for the largest channel bandwidth is > 1.45 W/kg.

5) TDD LTE test configuration

According to KDB941225 D05 SAR for LTE Devices, for Time-Division Duplex (TDD) systems, SAR must be tested using a fixed periodic duty factor according to the highest transmission duty factor implemented for the device and supported by the defined 3GPP LTE TDD configurations.

TDD LTE Band 41 supports 3GPP TS 36.211 section 4.2 for Type 2 Frame Structure and Table 4.2-2 for uplink-downlink configurations and Table 4.2-1 for Special subframe configurations.

Figure 4.2-1: Frame structure type 2

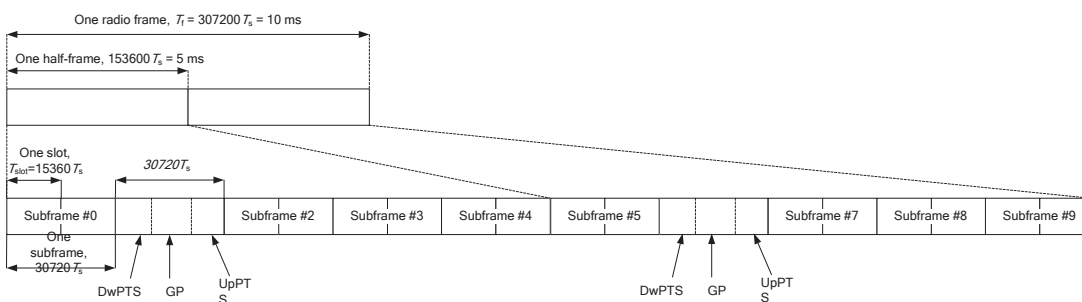

Table 4.2-1: Configuration of special subframe (lengths of DwPTS/GP/UpPTS)

Special subframe configuration	Normal cyclic prefix in downlink				Extended cyclic prefix in downlink			
	DwPTS		UpPTS		DwPTS		UpPTS	
		Normal cyclic prefix in uplink	Extended cyclic prefix in uplink		Normal cyclic prefix in uplink	Extended cyclic prefix in uplink		
0	$6592 \cdot T_s$	$2192 \cdot T_s$	$2560 \cdot T_s$	$7680 \cdot T_s$	$2192 \cdot T_s$	$2560 \cdot T_s$		
1	$19760 \cdot T_s$			$20480 \cdot T_s$				
2	$21952 \cdot T_s$			$23040 \cdot T_s$				
3	$24144 \cdot T_s$			$25600 \cdot T_s$				
4	$26336 \cdot T_s$			$7680 \cdot T_s$				
5	$6592 \cdot T_s$	$4384 \cdot T_s$	$5120 \cdot T_s$	$20480 \cdot T_s$	$4384 \cdot T_s$	$5120 \cdot T_s$		
6	$19760 \cdot T_s$			$23040 \cdot T_s$				
7	$21952 \cdot T_s$			$12800 \cdot T_s$				
8	$24144 \cdot T_s$			-				
9	$13168 \cdot T_s$			-				

Table 4.2-2: Uplink-downlink configurations

Uplink-downlink configuration	Downlink-to-Uplink Switch-point periodicity	Subframe number										
		0	1	2	3	4	5	6	7	8	9	
0	5 ms	D	S	U	U	U	D	S	U	U	U	
1	5 ms	D	S	U	U	D	D	S	U	U	D	
2	5 ms	D	S	U	D	D	D	S	U	D	D	
3	10 ms	D	S	U	U	U	D	D	D	D	D	
4	10 ms	D	S	U	U	D	D	D	D	D	D	
5	10 ms	D	S	U	D	D	D	D	D	D	D	
6	5 ms	D	S	U	U	U	D	S	U	U	D	

According to Figure 4.2-1, one radio frame is configured by 10 subframes, which consist of Uplink-subframe, Downlink-subframe and Special subframe. For TDD-LTE, the Duty Cycle should be calculated on Uplink-subframes and Special subframes, due to Special subframe containing both Uplink transmissions. So for one radio frame, Duty Cycle can be calculated with formula as below. The count of Uplink subframes are according to Table 4.2-2:

$$\text{Duty cycle} = (30720T_s \cdot \text{Ups} + \text{Uplink Component} \cdot \text{Specials}) / (307200T_s)$$

About the uplink component of Special subframes, we can figure out by Table 4.2-1:

$$\text{Uplink Component} = \text{UpPTS}$$

In conclusion, for the TDD LTE Band, Duty Cycle can be calculated with formula as below all these sets are ok when we test, or we can set as below.

$$\text{Duty cycle} = [(30720T_s \cdot \text{Ups}) + \text{UpPTS} \cdot \text{Specials}] / (307200T_s)$$

And we can get different Duty cycles under different configurations:

Uplink-Downlink configuration	Subframe number			Configuration of special subframe								
				Normal cyclice prefix in downlink				Extended cyclice prefix in downlink				
	D		S	U	Normal cyclice prefix in uplink		Extended cyclice prefix in uplink		Normal cyclice prefix in uplink		Extended cyclice prefix in uplink	
					configuration 0~4	configuration 5~9	configuration 0~4	configuration 5~9	configuration 0~3	configuration 4~7	configuration 0~3	configuration 4~7
0	2	2	6	61.43%	62.85%	61.67%	63.33%	61.43%	62.85%	61.67%	63.33%	
1	4	2	4	41.43%	42.85%	41.67%	43.33%	41.43%	42.85%	41.67%	43.33%	
2	6	2	2	21.43%	22.85%	21.67%	23.33%	21.43%	22.85%	21.67%	23.33%	
3	6	1	3	30.71%	31.43%	30.83%	31.67%	30.71%	31.43%	30.83%	31.67%	
4	7	1	2	20.71%	21.43%	20.83%	21.67%	20.71%	21.43%	20.83%	21.67%	
5	8	1	1	10.71%	11.43%	10.83%	11.67%	10.71%	11.43%	10.83%	11.67%	
6	3	2	5	51.43%	52.85%	51.67%	53.33%	51.43%	52.85%	51.67%	53.33%	



For TDD LTE, SAR should be tested with the highest transmission duty factor (63.33%) using Uplink-downlink configuration 0 and Special subframe configuration 7 for Frame structure type 2.

6.6 WiFi Test Configuration

For WiFi SAR testing, a communication link is set up with some command for WiFi mode test. During the test, at the each test frequency channel, the EUT is operated at the RF continuous emission mode. Per KDB248227 D01, a minimum transmission duty factor of 85% is required to avoid certain hardware and device implementation issues related to wide range SAR scaling. The reported SAR must be scaled to 100% transmission duty factor to determine compliance at the maximum tune-up tolerance limit.

6.6.1 Initial Test Position Procedure

For exposure condition with multiple test position, such as handsets operating next to the ear, devices with hotspot mode or UMPC mini-tablet, procedures for initial test position can be applied. Using the transmission mode determined by the DSSS procedure or initial test configuration, area scans are measured for all position in an exposure condition. The test position with the highest extrapolated (peak) SAR is used as the initial test position. When reported SAR for the initial test position is $\leq 0.4\text{W/kg}$, no additional testing for the remaining test position is required. Otherwise, SAR is evaluated at the subsequent highest peak SAR position until the reported SAR result is $\leq 0.8\text{W/kg}$ or all test position are measured. For all positions/configurations tested using the initial test position and subsequent test positions, when the *reported* SAR is $> 0.8\text{W/kg}$, SAR is measured for these test positions/configurations on the subsequent next highest measured output power channel(s) until the *reported* SAR is $\leq 1.2\text{W/kg}$ or all required channels are tested.

6.6.2 Initial Test Configuration Procedure

An initial test configuration is determined for OFDM transmission modes according to the channel bandwidth, modulation and data rate combination(s) with the highest maximum output power specified for production units in each standalone and aggregated frequency band. SAR is measured using the highest measured maximum output power channel. For configurations with the same specified or measured maximum output power, additional transmission mode and test channel selection procedures are required (see section 5.3.2 of KDB248227 D01). SAR test reduction of subsequent highest output test channels is based on the *reported* SAR of the initial test configuration.

For next to the ear, hotspot mode and UMC mini-tablet exposure configurations where multiple test positions are required, the initial test position procedure is applied to minimize the number of test positions required for SAR measurement using the initial test configuration transmission mode. For fixed exposure conditions that do not have multiple SAR test positions, SAR is measured in the transmission mode determined by the initial test configuration.

When the *reported* SAR of the initial test configuration is $> 0.8\text{W/kg}$, SAR measurement is required for the subsequent next highest measured output power channel(s) in the initial test configuration until the *reported* SAR is $\leq 1.2\text{W/kg}$ or all required channels are tested.

6.6.3 Sub Test Configuration Procedure

SAR measurement requirements for the remaining 802.11 transmission mode configurations that have not been tested in the initial test configuration are determined separately for each standalone and aggregated frequency band, in each exposure condition, according to the maximum output power specified for production units.

When the highest reported SAR for the initial test configuration, according to the initial test position or fixed exposure position requirements, is adjusted by the ratio of the subsequent test configuration to

initial test configuration specified maximum output power and the adjusted SAR is ≤ 1.2 W/kg, SAR is not required for that subsequent test configuration.

6.6.4 WiFi 2.4G SAR Test Procedures

Separate SAR procedures are applied to DSSS and OFDM configurations in the 2.4 GHz band to simplify DSSS test requirements. For 802.11b DSSS SAR measurements, DSSS SAR procedure applies to fixed exposure test position and initial test position procedure applies to multiple exposure test positions.

A) 802.11b DSSS SAR Test Requirements

SAR is measured for 2.4 GHz 802.11b DSSS using either a fixed test position or, when applicable, the initial test position procedure. SAR test reduction is determined according to the following:

1) When the *reported* SAR of the highest measured maximum output power channel (section 3.1 of of KDB248227 D01) for the exposure configuration is ≤ 0.8 W/kg, no further SAR testing is required for 802.11b DSSS in that exposure configuration.

2) When the *reported* SAR is > 0.8 W/kg, SAR is required for that exposure configuration using the next highest measured output power channel. When any *reported* SAR is > 1.2 W/kg, SAR is required for the third channel; i.e., all channels require testing.

B) 2.4GHz 802.11g/n OFDM SAR Test Exclusion Requirements

When SAR measurement is required for 2.4 GHz 802.11g/n OFDM configurations, the measurement and test reduction procedures for OFDM are applied (section 5.3 of of KDB248227 D01). SAR is not required for the following 2.4 GHz OFDM conditions.

1) When KDB Publication 447498 SAR test exclusion applies to the OFDM configuration.

2) When the highest *reported* SAR for DSSS is adjusted by the ratio of OFDM to DSSS specified maximum output power and the adjusted SAR is ≤ 1.2 W/kg.

C) SAR Test Requirements for OFDM configurations

When SAR measurement is required for 802.11 a/g/n/ac OFDM configurations, each standalone and frequency aggregated band is considered separately for SAR test reduction. When the same transmitter and antenna(s) are used for U-NII-1 and U-NII-2A bands, additional SAR test reduction applies. When band gap channels between U-NII-2C band and 5.8 GHz U-NII-3 or §15.247 band are supported, the highest maximum output power transmission mode configuration and maximum output power channel across the bands must be used to determine SAR test reduction, according to the initial test configuration and subsequent test configuration requirements. In applying the initial test configuration and subsequent test configuration procedures, the 802.11 transmission configuration with the highest specified maximum output power and the channel within a test configuration with the highest measured maximum output power should be clearly distinguished to apply the procedures.

6.6.5 U-NII-1 and U-NII-2A Bands

For devices that operate in only one of the U-NII-1 and U-NII-2A bands, the normally required SAR procedures for OFDM configurations are applied. For devices that operate in both U-NII bands using the same transmitter and antenna(s), SAR test reduction is determined according to the following:

- 1) When the same maximum output power is specified for both bands, begin SAR measurement in U-NII-2A band by applying the OFDM SAR requirements. If the highest *reported* SAR for a test configuration is ≤ 1.2 W/kg, SAR is not required for U-NII-1 band for that configuration (802.11 mode and exposure condition); otherwise, both bands are tested independently for SAR.
- 2) When different maximum output power is specified for the bands, begin SAR measurement in the band with higher specified maximum output power. The highest *reported* SAR for the tested configuration is adjusted by the ratio of lower to higher specified maximum output power for the two bands. When the adjusted SAR is ≤ 1.2 W/kg, SAR is not required for the band with lower maximum output power in that test configuration; otherwise, both bands are tested independently for SAR.
- 3) The two U-NII bands may be aggregated to support a 160 MHz channel on channel number 50. Without additional testing, the maximum output power for this is limited to the lower of the maximum output power certified for the two bands. When SAR measurement is required for at least one of the bands and the highest *reported* SAR adjusted by the ratio of specified maximum output power of aggregated to standalone band is > 1.2 W/kg, SAR is required for the 160 MHz channel. This procedure does not apply to an aggregated band with maximum output higher than the standalone band(s); the aggregated band must be tested independently for SAR. SAR is not required when the 160 MHz channel is operating at a reduced maximum power and also qualifies for SAR test exclusion.

6.6.6 U-NII-2C and U-NII-3 Bands

The frequency range covered by these bands is 380 MHz (5.47 – 5.85 GHz), which requires a minimum of at least two SAR probe calibration frequency points to support SAR measurements. when Terminal Doppler Weather Radar (TDWR) restriction applies, the channels at 5.60 – 5.65 GHz in U-NII-2C band must be disabled with acceptable mechanisms and documented in the equipment certification to avoid SAR requirements.¹⁰ TDWR restriction does not apply under the new rules; all channels that operate at 5.60 – 5.65 GHz must be included to apply the SAR test reduction and measurement procedures.

When the same transmitter and antenna(s) are used for U-NII-2C band and U-NII-3 band or 5.8 GHz band of §15.247, the bands may be aggregated to enable additional channels with 20, 40 or 80 MHz bandwidth to span across the band gap, as illustrated in Appendix B. The maximum output power for the additional band gap channels is limited to the lower of those certified for the bands. Unless band gap channels are permanently disabled, they must be considered for SAR testing. The frequency range covered by these bands is 380 MHz (5.47 – 5.85 GHz), which requires a minimum of at least two SAR probe calibration frequency points to support SAR measurements. To maintain SAR measurement accuracy and to facilitate test reduction, the channels in U-NII-2C band above 5.65 GHz may be grouped with the 5.8 GHz channels in U-NII-3 or §15.247 band to enable two SAR probe calibration frequency points to cover the bands, including the band gap channels.¹¹ When band gap channels are supported and the bands are not aggregated for SAR testing, band gap channels must be considered independently in each band according to the normally required OFDM SAR measurement and probe calibration frequency points requirements.

6.6.7 OFDM Transmission Mode SAR Test Channel Selection Requirements

For 2.4 GHz and 5 GHz bands, When the same maximum output power was specified for multiple OFDM transmission mode configurations in a frequency band or aggregated band, SAR is measured using the configuration with the largest channel bandwidth, lowest order modulation and lowest data rate. When the maximum output power of a channel is the same for equivalent OFDM configurations (for example 802.11a, 802.11n and 802.11ac, or 802.11g and 802.11n, with the same channel bandwidth, modulation, and data rate, etc), the lower order 802.11 mode (i.e., 802.11a is chosen over 802.11n then 802.11ac, or 802.11g is chosen over 802.11n) is used for SAR measurement. When the maximum output power are the same for multiple test channel, either according to the default or additional power measurement requirement, SAR is measured using the channel closest to the middle of the frequency band or aggregated band. When there are multiple channels with the same maximum output power, SAR is measured using the higher number channel.

6.6.8 MIMO SAR Considerations

Per KDB248227 D01, simultaneous transmission provisions in KDB Publication 447498 should be used to determine simultaneous transmission SAR test exclusion for WiFi MIMO. If the sum of 1-g SAR single transmission SAR measurement is $<1.6\text{W/kg}$, no additional SAR measurements for MIMO are required. Alternatively, SAR for MIMO can be measured with all antennas transmitting simultaneously at the specified maximum output power of MIMO operation.

6.7 LTE CA and downlink 4 x 4 MIMO specification

6.7.1 LTE CA combinations specification

The device supports downlink and uplink LTE Carrier Aggregation (CA) for Intra-band and inter-band.

a) The LTE release and version numbers of the 3GPP documents used to implement the specific device(s): Release 13, 3GPP TS 36.211 V13.3.0 (2016-09)

b) The associated 3GPP release and version numbers required for power measurements and RF test setup conditions:

Release 15, 3GPP TS 36.521-1 V15.3.1 (2018-09)

Release 15, 3GPP TS 36.101 V15.4.0 (2018-09)

1) The device supports Intra-band uplink LTE CA for CA_7C, CA_38C, CA_41C with two component carriers in the uplink.

2) The device supports Intra-band and inter-band downlink LTE CA (See the table below)

3) The device does not support full CA features on 3GPP Release 15 or higher. All other uplink communications are identical to the release 8 specifications. Other LTE Rel.10 or higher features are not supported, including Enhanced SC-FDMA, Uplink MIMO or other antenna diversity configurations, Wi-Fi offloading using LTE-U, LAA or LWA related protocols etc.

Intra-band contiguous CA operating bands

E-UTRA CA configuration / Bandwidth combination set							
E-UTRA CA configuration	Uplink CA configurations (NOTE 3)	Component carriers in order of increasing carrier frequency				Maximum aggregated bandwidth [MHz]	Bandwidth combination set
		Channel bandwidths for carrier [MHz]	Channel bandwidths for carrier [MHz]	Channel bandwidths for carrier [MHz]	Channel bandwidths for carrier [MHz]		
CA_2C	-	5	20			40	0
		10	15, 20				
		15	10, 15, 20				
		20	5, 10, 15, 20				
CA_5B	-	5, 10	10			20	0
		10	5				
CA_7C	CA_7C	15	15			40	0
		20	20				
		10	20			40	1
		15	15, 20				
		20	10, 15, 20			40	2
		15	10, 15				
CA_12B	-	5	5, 10			15	0
CA_38C	CA_38C	15	15			40	0
		20	20				
CA_41C	CA_41C	10	20			40	0
		15	15, 20				
		20	10, 15, 20			40	1
		5, 10	20				
		15	15, 20			40	2
		20	5, 10, 15, 20				
		10	15, 20			40	3
		15	10, 15, 20				
		20	10, 15, 20				
		10	20			40	0
20	20						
CA_41D	CA_41C	10	20	15		60	0
		10	15, 20	20			
		15	20	10, 15			
		15	10, 15, 20	20			
		20	15, 20	10			
		20	10, 15, 20	15, 20			
CA_66B	-	5	5, 10, 15			20	0
		10	5, 10				
		15	5				
CA_66C	-	5	20			40	0
		10	15, 20				
		15	10, 15, 20				
		20	5, 10, 15, 20				

CA_66D	-	5	20	20		60	0
		20	5	20			
		20	20	5			
		10	20	15			
		15	20	10			
		10, 15, 20	15, 20	20			
		15, 20	10	20			
		15	15, 20	15			
		20	15, 20	10, 15			
		20	10	15			

NOTE 1: The CA configuration refers to an operating band and a CA bandwidth class specified in Table (the indexing letter).
Absence of a CA bandwidth class for an operating band implies support of all classes.
NOTE 2: For the supported CC bandwidth combinations, the CC downlink and uplink bandwidths are equal.
NOTE 3: Uplink CA configurations are the configurations supported by the present release of specifications.

Intra-band non-contiguous CA operating bands (with two sub-blocks)

E-UTRACA configuration	Uplink CA configurations (NOTE 1)	E-UTRA CA configuration / Bandwidth combination set						
		Component carriers in order of increasing carrier frequency					Maximum aggregated bandwidth [MHz]	Bandwidth combination set
		Channel bandwidths for carrier [MHz]	Channel bandwidths for carrier [MHz]	Channel bandwidths for carrier [MHz]	Channel bandwidths for carrier [MHz]	Channel bandwidths for carrier [MHz]		
CA_2A-2A	-	5, 10, 15, 20	5, 10, 15, 20				40	0
CA_4A-4A	-	5, 10, 15, 20	5, 10, 15, 20				40	0
		5, 10	5, 10				20	1
CA_7A-7A	-	5	15				40	0
		10	10, 15					
		15	15, 20					
		20	20				40	1
		5, 10, 15, 20	5, 10, 15, 20				30	2
		10, 15, 20	10, 15, 20				40	3
CA_12A-12A	-	5	5				10	0
CA_66A-66A	-	5, 10, 15, 20	5, 10, 15, 20				40	0

Inter-band CA operating bands (two bands)

E-UTRA CA configuration / Bandwidth combination set										
E-UTRA CA Configuration	Uplink CA configurations (NOTE 4)	E-UTRA Bands	1.4 MHz	3 MHz	5 MHz	10 MHz	15 MHz	20 MHz	Maximum aggregated bandwidth [MHz]	Bandwidth combination set
CA_2A-4A	-	2	Yes	Yes	Yes	Yes	Yes	Yes	40	0
		4			Yes	Yes	Yes	Yes		
		2			Yes	Yes			20	1
		4			Yes	Yes				
		2			Yes	Yes	Yes	Yes	40	2
4			Yes	Yes	Yes	Yes				
CA_2A-4A-4A	-	2			Yes	Yes	Yes	Yes	60	0
		4	See CA_4A-4A Bandwidth Combination Set 0							
CA_2A-5A	-	2			Yes	Yes	Yes	Yes	30	0
		5			Yes	Yes				
		2			Yes	Yes			20	1
		5			Yes	Yes				
CA_2A-2A-5A	-	2	See CA_2A-2A Bandwidth Combination Set 0						50	0
		5			Yes	Yes				
CA_2A-7A	-	2			Yes	Yes	Yes	Yes	40	0
		7			Yes	Yes	Yes	Yes		
CA_2A-2A-7A	-	2	See CA_2A-2A Bandwidth Combination Set 0						60	0
		7			Yes	Yes	Yes	Yes		
CA_2A-7A-7A	-	2			Yes	Yes	Yes	Yes	60	0
		7	See the CA_7A-7A Bandwidth combination set 1							
CA_2A-7C	-	2			Yes	Yes	Yes	Yes	60	0
		7	See the CA_7C Bandwidth combination set 1							
CA_2A-12A	-	2			Yes	Yes	Yes	Yes	30	0
		12			Yes	Yes				
		2			Yes	Yes	Yes	Yes	30	1
		12	Yes	Yes	Yes					
		2			Yes	Yes			20	2
12			Yes	Yes						
CA_2A-2A-12A	-	2	See CA_2A-2A Bandwidth Combination Set 0						50	0
		12			Yes	Yes				
CA_2A-12A-12A	-	2			Yes	Yes	Yes	Yes	30	0
		12	See CA_12A-12A Bandwidth Combination Set 0							
CA_2A-12B	-	2			Yes	Yes	Yes	Yes	35	0
		12	See CA_12B Bandwidth Combination Set 0							
CA_2A-17A	-	2			Yes	Yes			20	0
		17			Yes	Yes				
CA_2A-66A	-	2	Yes	Yes	Yes	Yes	Yes	Yes	40	0
		66			Yes	Yes	Yes	Yes		
		2			Yes	Yes			20	1
		66			Yes	Yes				
		2			Yes	Yes	Yes	Yes	40	2
66			Yes	Yes	Yes	Yes				

CA_2A-66C	-	2			Yes	Yes	Yes	Yes	60	0	
		66	See CA_66C Bandwidth Combination Set 0								
CA_2A-2A-66A	-	2	See CA_2A-2A Bandwidth Combination Set 0							60	0
		66			Yes	Yes	Yes	Yes			
CA_2A-66A-66A	-	2			Yes	Yes	Yes	Yes	60	0	
		66	See CA_66A-66A Bandwidth Combination Set 0								
CA_2A-2A-66C	-	2	See CA_2A-2A Bandwidth Combination Set 0							80	0
		66	See CA_66C Bandwidth combination set 0								
CA_4A-5A	-	4			Yes	Yes			20	0	
		5			Yes	Yes					
		4			Yes	Yes	Yes	Yes	30	1	
		5			Yes	Yes					
CA_4A-4A-5A	-	4	See CA_4A-4A Bandwidth Combination Set 0							50	0
		5			Yes	Yes					
CA_4A-7A	-	4			Yes	Yes			30	0	
		7			Yes	Yes	Yes	Yes			
		4			Yes	Yes	Yes	Yes	40	1	
		7			Yes	Yes	Yes	Yes			
CA_4A-4A-7A	-	4			Yes	Yes			40	0	
		4			Yes	Yes					
		7			Yes	Yes	Yes	Yes			
		4			Yes	Yes	Yes	Yes	60	1	
		4			Yes	Yes	Yes	Yes			
		7			Yes	Yes	Yes	Yes			
CA_4A-7C	-	4			Yes	Yes	Yes	Yes	60	0	
		7	See CA_7C Bandwidth Combination Set 1								
CA_4A-7A-7A	-	4			Yes	Yes	Yes	Yes	60	0	
		7	See the CA_7A-7A Bandwidth combination set 1								
CA_4A-12A	-	4	Yes	Yes	Yes	Yes			20	0	
		12			Yes	Yes					
		4	Yes	Yes	Yes	Yes	Yes	Yes	30	1	
		12			Yes	Yes					
		4			Yes	Yes	Yes	Yes	30	2	
		12		Yes	Yes	Yes					
		4			Yes	Yes			20	3	
		12			Yes	Yes					
		4			Yes	Yes	Yes	Yes	30	4	
		12			Yes	Yes					
4			Yes	Yes	Yes		20	5			
12			Yes								
CA_4A-4A-12A	-	4	See CA_4A-4A Bandwidth Combination Set 0							50	0
		12			Yes	Yes					
CA_4A-12A-12A	-	4	See CA_4A-4A Bandwidth Combination Set 0							50	0
		12			Yes	Yes					
CA_4A-12B	-	4			Yes	Yes	Yes	Yes	35	0	
		12	See CA_12B Bandwidth Combination Set 0								
CA_4A-17A	-	4			Yes	Yes			20	0	
		17			Yes	Yes					
CA_5A-7A	-	5	Yes	Yes	Yes	Yes			30	0	
		7				Yes	Yes	Yes			
		5			Yes	Yes			30	1	
		7			Yes	Yes	Yes	Yes			
CA_5A-7C	-	5			Yes	Yes			50	0	
		7	See CA_7C Bandwidth Combination Set 1								
CA_5A-7A-7A	-	5			Yes	Yes			50	0	

		7	See CA_7A-7A Bandwidth Combination Set 3							
CA_5A-66A	-	5			Yes	Yes			30	0
		66			Yes	Yes	Yes	Yes		
CA_5A-66C	-	5			Yes	Yes			50	0
		66	See CA_66C Bandwidth combination set 0							
CA_7A-12A	-	7			Yes	Yes	Yes	Yes	30	0
		12			Yes	Yes				
CA_7A-12B	-	7			Yes	Yes	Yes	Yes	35	0
		12	See CA_12B Bandwidth combination set 0							
CA_7A-66A	-	7			Yes	Yes	Yes	Yes	40	0
		66			Yes	Yes	Yes	Yes		
CA_7A-7A-66A-66A	-	7	See CA_7A-7A Bandwidth combination set 1						80	0
		66	See CA_66A-66A Bandwidth Combination Set 0							
CA_7C-66A	CA_7C	7	See CA_7C Bandwidth Combination Set 1						60	0
		66			Yes	Yes	Yes	Yes		
CA_7A-7A-66A	-	7	See CA_7A-7A Bandwidth combination set 1						60	0
		66			Yes	Yes	Yes	Yes		
CA_7A-66A-66A	-	7			Yes	Yes	Yes	Yes	60	0
		66	See CA_66A-66A Bandwidth Combination Set 0							
CA_7C-66A-66A	-	7	See CA_7C Bandwidth Combination Set 1						80	0
		66	See CA_66A-66A Bandwidth Combination Set 0							
CA_12A-66A	-	12			Yes	Yes			20	0
		66	Yes	Yes	Yes	Yes				
		12			Yes	Yes			30	1
		66	Yes	Yes	Yes	Yes	Yes	Yes		
		12		Yes	Yes	Yes			30	2
		66			Yes	Yes	Yes	Yes		
		12			Yes	Yes			20	3
		66			Yes	Yes				
		12			Yes	Yes			30	4
		66			Yes	Yes	Yes	Yes		
12			Yes				20	5		
66			Yes	Yes	Yes					
CA_12A-66A-66A	-	12			Yes	Yes			50	0
		66	See CA_66A-66A Bandwidth combination set 0							
CA_12B-66A	-	12	See CA_12B bandwidth combination set 0						35	0
		66			Yes	Yes	Yes	Yes		

Note:

- 1) For the inter-band CA combinations, Band12 and Band 17 can not be assigned PCC.
- 2) The channel spacing and aggregated channel bandwidth for CA are identical to the associated specification in Release 15,3GPP TS 36.521-1 V15.3.1 (2018-09) and Release 15,3GPP TS 36.101 V15.4.0 (2018-09)
- 3) The reference test frequencies for CA refers to 3GPP TS 36.508 V15.4.0 (2018-12)

Inter-band CA operating bands (three bands)

E-UTRA CA configuration / Bandwidth combination set										
E-UTRA CA Configuration	Uplink CA configurations (NOTE 5)	E-UTRA Bands	1.4 MHz	3 MHz	5 MHz	10 MHz	15 MHz	20 MHz	Maximum aggregated bandwidth [MHz]	Bandwidth combination set
CA_2A-4A-5A	-	2			Yes	Yes	Yes	Yes	50	0
		4			Yes	Yes	Yes	Yes		
		5			Yes	Yes				
CA_2A-4A-7A	-	2			Yes	Yes	Yes	Yes	60	0
		4			Yes	Yes	Yes	Yes		
		7			Yes	Yes	Yes	Yes		
CA_2A-4A-7A-7A	-	2			Yes	Yes	Yes	Yes	80	0
		4			Yes	Yes	Yes	Yes		
		7	See the CA_7A-7A Bandwidth combination set 1							
CA_2A-4A-7C	-	2			Yes	Yes	Yes	Yes	80	0
		4			Yes	Yes	Yes	Yes		
		7	See CA_7C Bandwidth Combination Set 1							
CA_2A-4A-12A	-	2			Yes	Yes	Yes	Yes	50	0
		4			Yes	Yes	Yes	Yes		
		12			Yes	Yes				
CA_2A-4A-12A-12A	-	2			Yes	Yes	Yes	Yes	50	0
		4			Yes	Yes	Yes	Yes		
		12	See CA_12A-12A Bandwidth Combination Set 0							
CA_2A-2A-5A-66A	-	2	See CA_2A-2A Bandwidth Combination Set 0						70	0
		5			Yes	Yes				
		66			Yes	Yes	Yes	Yes		
CA_2A-2A-5A-66C	-	2	See CA_2A-2A Bandwidth Combination Set 0						90	0
		5			Yes	Yes				
		66	See CA_66C Bandwidth combination set 0							
CA_2A-2A-7A-12A	-	2	See CA_2A-2A Bandwidth combination set 0						70	0
		7			Yes	Yes	Yes	Yes		
		12			Yes	Yes				
CA_2A-2A-7A-66A	-	2	See CA_2A-2A Bandwidth Combination Set 0						80	0
		7			Yes	Yes	Yes	Yes		
		66			Yes	Yes	Yes	Yes		
CA_2A-2A-12A-66A	-	2	See CA_2A-2A Bandwidth Combination Set 0						70	0
		12			Yes	Yes				
		66			Yes	Yes	Yes	Yes		
CA_2A-5A-66A	-	2			Yes	Yes	Yes	Yes	50	0
		5			Yes	Yes				
		66			Yes	Yes	Yes	Yes		
CA_2A-5A-66C	-	2			Yes	Yes	Yes	Yes	70	0
		5			Yes	Yes				
		66	See CA_66C Bandwidth combination set 0							
CA_2A-7A-12A	-	2			Yes	Yes	Yes	Yes	50	0
		7			Yes	Yes	Yes	Yes		
		12			Yes	Yes				

CA_2A-7A-12B	-	2			Yes	Yes	Yes	Yes	55	0
		7			Yes	Yes	Yes	Yes		
		12	See CA_12B Bandwidth combination set 0							
CA_2A-7A-66A	-	2			Yes	Yes	Yes	Yes	60	0
		7			Yes	Yes	Yes	Yes		
		66			Yes	Yes	Yes	Yes		
CA_2A-7A-7A-66A	-	2			Yes	Yes	Yes	Yes	80	0
		7	See CA_7A-7A Bandwidth combination set 1							
		66			Yes	Yes	Yes	Yes		
CA_2A-7A-66A-66A	-	2			Yes	Yes	Yes	Yes	80	0
		7			Yes	Yes	Yes	Yes		
		66	See CA_66A-66A Bandwidth combination set 0							
CA_2A-12A-66A	-	2			Yes	Yes	Yes	Yes	50	0
		12			Yes	Yes				
		66			Yes	Yes	Yes	Yes		
		2			Yes	Yes			40	1
		12			Yes	Yes				
		66			Yes	Yes	Yes	Yes		
CA_2A-12B-66A	-	2			Yes	Yes	Yes	Yes	55	0
		12	See CA_12B Bandwidth Combination Set 0							
		66			Yes	Yes	Yes	Yes		
CA_4A-7A-12A	-	4			Yes	Yes			40	0
		7			Yes	Yes	Yes	Yes		
		12			Yes	Yes				
		4			Yes	Yes	Yes	Yes	50	1
		7			Yes	Yes	Yes	Yes		
		12			Yes	Yes				
CA_7A-12A-66A	-	7			Yes	Yes	Yes	Yes	50	0
		12			Yes	Yes				
		66			Yes	Yes	Yes	Yes		
CA_7A-12B-66A	-	7			Yes	Yes	Yes	Yes	55	0
		12	See CA_12B Bandwidth combination set 0							
		66			Yes	Yes	Yes	Yes		

Note:

- 1) For the inter-band CA combinations, Band12 and Band 17 can not be assigned PCC.
- 2) The channel spacing and aggregated channel bandwidth for CA are identical to the associated specification in Release 15,3GPP TS 36.521-1 V15.3.1 (2018-09) and Release 15,3GPP TS 36.101 V15.4.0 (2018-09)
- 3) The reference test frequencies for CA refers to 3GPP TS 36.508 V15.4.0 (2018-12)

Inter-band CA operating bands (four bands)

E-UTRA CA configuration / Bandwidth combination set										
E-UTRA CA Configuration	Uplink CA configurations (NOTE 5)	E-UTRA Bands	1.4 MHz	3 MHz	5 MHz	10 MHz	15 MHz	20 MHz	Maximum aggregated bandwidth [MHz]	Bandwidth combination set
CA_2A-2A-7A-12A-66A	-	2	See CA_2A-2A Bandwidth Combination Set 0						90	0
		7			Yes	Yes	Yes	Yes		
		12			Yes	Yes				
		66			Yes	Yes	Yes	Yes		
CA_2A-4A-7A-12A	-	2			Yes	Yes	Yes	Yes	70	0
		4			Yes	Yes	Yes	Yes		
		7			Yes	Yes	Yes	Yes		
CA_2A-7A-12A-66A	-	2			Yes	Yes	Yes	Yes	70	0
		7			Yes	Yes	Yes	Yes		
		12			Yes	Yes				
CA_2A-7A-12B-66A	-	2			Yes	Yes	Yes	Yes	75	0
		7			Yes	Yes	Yes	Yes		
		12	See CA_12B Bandwidth combination set 0							
		66			Yes	Yes	Yes	Yes		

Note:

- 1) For the inter-band CA(four bands) combinations, Band12 cannot be assigned as PCC.

6.7.2 Test procedure for downlink CA

According to 201804 FCC RF Exposure TCB workshop slides, the guidance does not consider Intra-band DL CA and inter-band DL CA separately.

In applying the power measurement procedures of KDB 941225 D05A for DL CA SAR test exclusion, only the CA configuration with the largest aggregated DL CA bandwidth in each frequency band group need consideration (independently for contiguous and non-contiguous CA). When the same frequency band is used for both contiguous and non-contiguous CA, power may be measured using the configuration with the largest aggregated bandwidth “and” maximum output power among the contiguous and non-contiguous CA configurations, otherwise, these are considered separately. In applying the existing power measurement procedures of KDB 941225 D05A for DL CA SAR test exclusion, only the subset with the largest number of combinations of frequency bands and CCs in each row need consideration. the configurations that require power measurements are in the table as below:

Index	2CCs	Restriction	Covered by	Index	3CCs	Restriction	Covered by	Index	4CCs	Restriction	Covered by	Index	5CCs	Restriction	Covered by
2CCs#1	CA 2C		No	3CCs#1	CA 41D		No	4CCs#1	CA 2A-2A-66C		5CCs#1	5CCs#1	CA 2A-2A-5A-66C		No
2CCs#2	CA 5B		No	3CCs#2	CA 66D		No	4CCs#2	CA 7A-7A-66A-66A			5CCs#2	CA 2A-2A-7A-12A-66A		No
2CCs#3	CA 7C		3CCs#7	3CCs#3	CA 2A-4A-4A		No	4CCs#3	CA 7C-66A-66A			5CCs#3	CA 2A-7A-12B-66A		No
2CCs#4	CA 12B		3CCs#10	3CCs#4	CA 2A-2A-5A		4CCs#7	4CCs#4	CA 2A-4A-7A-7A						
2CCs#5	CA 38C		No	3CCs#5	CA 2A-2A-7A		4CCs#8	4CCs#5	CA 2A-4A-7C						
2CCs#6	CA 41C		No	3CCs#6	CA 2A-7A-7A		4CCs#4	4CCs#6	CA 2A-4A-12A-12A						
2CCs#7	CA 66B		No	3CCs#7	CA 2A-7C		4CCs#5	4CCs#7	CA 2A-2A-5A-66A						
2CCs#8	CA 66C		3CCs#11	3CCs#8	CA 2A-2A-12A		4CCs#8	4CCs#8	CA 2A-2A-7A-12A						5CCs#2
2CCs#9	CA 2A-2A		3CCs#4	3CCs#9	CA 2A-12A-12A		4CCs#6	4CCs#9	CA 2A-2A-7A-66A						5CCs#2
2CCs#10	CA 4A-4A		3CCs#3	3CCs#10	CA 2A-12B		4CCs#12	4CCs#10	CA 2A-2A-12A-66A						5CCs#2
2CCs#11	CA 7A-7A		3CCs#6	3CCs#11	CA 2A-66C		4CCs#1	4CCs#11	CA 2A-5A-66C						5CCs#1
2CCs#12	CA 12A-12A		3CCs#9	3CCs#12	CA 2A-2A-66A		4CCs#7	4CCs#12	CA 2A-7A-12B						5CCs#3
2CCs#13	CA 66A-66A		3CCs#13	3CCs#13	CA 2A-66A-66A		4CCs#14	4CCs#13	CA 2A-7A-66A						No
2CCs#14	CA 2A-4A		3CCs#3	3CCs#14	CA 4A-4A-5A		No	4CCs#14	CA 2A-7A-66A-66A						No
2CCs#15	CA 2A-5A		3CCs#4	3CCs#15	CA 4A-4A-7A		No	4CCs#15	CA 2A-12B-66A						5CCs#3
2CCs#16	CA 2A-7A		3CCs#5	3CCs#16	CA 4A-7C		4CCs#5	4CCs#16	CA 7A-12B-66A						5CCs#3
2CCs#17	CA 2A-12A		3CCs#8	3CCs#17	CA 4A-7A-7A		4CCs#4	4CCs#17	CA 2A-4A-7A-12A						No
2CCs#18	CA 2A-17A		No	3CCs#18	CA 4A-4A-12A		No	4CCs#18	CA 2A-7A-12A-66A						5CCs#2
2CCs#19	CA 2A-66A		3CCs#12	3CCs#19	CA 4A-12A-12A		4CCs#6								
2CCs#20	CA 4A-5A		3CCs#14	3CCs#20	CA 4A-12B		No								
2CCs#21	CA 4A-7A		3CCs#15	3CCs#21	CA 5A-7C		No								
2CCs#22	CA 4A-12A		3CCs#18	3CCs#22	CA 5A-7A-7A		No								
2CCs#23	CA 4A-17A		No	3CCs#23	CA 5A-66C		4CCs#11								
2CCs#24	CA 5A-7A		3CCs#22	3CCs#24	CA 7A-12B		4CCs#12								
2CCs#25	CA 5A-66A		3CCs#33	3CCs#25	CA 7C-66A		4CCs#3								
2CCs#26	CA 7A-12A		3CCs#34	3CCs#26	CA 7A-7A-66A		4CCs#2								
2CCs#27	CA 7A-66A		3CCs#26	3CCs#27	CA 7A-66A-66A		4CCs#2								
2CCs#28	CA 12A-66A		3CCs#28	3CCs#28	CA 12A-66A-66A		No								
				3CCs#29	CA 12B-66A		4CCs#15								
				3CCs#30	CA 2A-4A-5A		No								
				3CCs#31	CA 2A-4A-7A		4CCs#4								
				3CCs#32	CA 2A-4A-12A		4CCs#6								
				3CCs#33	CA 2A-5A-66A		4CCs#7								
				3CCs#34	CA 2A-7A-12A		4CCs#8								
				3CCs#35	CA 2A-7A-66A		4CCs#9								
				3CCs#36	CA 2A-12A-66A		4CCs#10								
				3CCs#37	CA 4A-7A-12A		4CCs#17								
				3CCs#38	CA 7A-12A-66A		4CCs#18								

Refer to section 7.1 of this report for detailed DL CA conducted power measurement results

6.7.3 Test procedure for Intra-band uplink CA

For Intra-band uplink LTE CA measurement (Uplink CA_7C, CA_38C, CA_41C), the following procedure according to 201711 FCC RF Exposure TCB workshop slides is applied:

- 1) Maximum output power is measured for each UL CA configuration for the required test channels described in KDB 941225 D05 (Rel. 8).
 - UL PCC configuration is determined by the required test channel.
 - SCC and subsequent CCs are added alternatively to either side of the PCC or within the transmission band for channels at the ends of a frequency band.
- 2) SAR for UL CA is required in each exposure condition and frequency band combination.
- 3) For this device , as the maximum output for Intra-band uplink LTE CA (Uplink CA_7C, CA_38C, CA_41C) is \leq standalone LTE mode (without CA).
 - PCC is configured according to the highest standalone SAR configuration tested.
 - SCC and subsequent CCs are configured according to procedures used for power measurement and parameters (BW, RB etc.) similar to that used for the PCC.
- 4) When the reported SAR for UL CA configuration, described above, is > 1.2 W/kg, UL CA SAR is also required for all required test channels(PCC based).
- 5) UL CA SAR is also required for standalone SAR configurations > 1.2 W/kg when they are scaled to the UL CA power level.

Refer to section 7.1 of this report for detailed UL CA conducted power measurement results.

6.7.4 LTE Downlink 4 x 4 MIMO specification and Test procedure

LTE B2/B4/B7/B66 of this device support downlink 4*4 MIMO band, the information are tabulated below:

Single Band support DL 4*4MIMO	4*4MIMO Band
LTE Band 2	B2
LTE Band 4	B4
LTE Band 7	B7
LTE Band 66	B66
Intra-band contiguous CA With DL 4*4MIMO	4*4MIMO Band
CA_2C	B2
CA_7C	B7
CA_66B	B66
CA_66C	B66
CA_66D	B66
Inter-band CA (two bands) With DL 4*4MIMO	4*4MIMO Band
CA_2A-4A	B2,B4
CA_2A-5A	B2
CA_2A-7A	B2,B7
CA_2A-2A-7A	B7
CA_2A-7C	B2,B7
CA_2A-7A-7A	B2
CA_2A-12A	B2
CA_2A-12B	B2
CA_2A-12A-12A	B2
CA_2A-17A	B2
CA_2A-66A	B2,B66
CA_2A-2A-66A	B66
CA_2A-66C	B2,B66
CA_2A-2A-66C	B66
CA_4A-5A	B4
CA_4A-7A	B4,B7
CA_4A-4A-7A	B7
CA_4A-7C	B4,B7
CA_4A-12A	B4
CA_4A-12B	B4
CA_4A-12A-12A	B4
CA_4A-17A	B4
CA_5A-7A	B7
CA_5A-7C	B7
CA_5A-66A	B66
CA_5A-66C	B66
CA_7A-12A	B7
CA_7A-12B	B7
CA_7A-66A	B7,B66
CA_7C-66A	B7,B66
CA_7A-66A-66A	B7
CA_7C-66A-66A	B7

CA_12A-66A	B66
CA_12B-66A	B66
Inter-band CA (Three bands) With DL 4*4MIMO	4*4MIMO Band
CA_2A-4A-5A	B2,B4
CA_2A-4A-7A	B2,B4,B7
CA_2A-4A-7C	B2,B4
CA_2A-4A-7A-7A	B2
CA_2A-4A-12A	B2,B4
CA_2A-4A-12A-12A	B2,B4
CA_2A-5A-66A	B2,B66
CA_2A-2A-5A-66A	B66
CA_2A-5A-66C	B2,B66
CA_2A-2A-5A-66C	B66
CA_2A-7A-12A	B2,B7
CA_2A-2A-7A-12A	B7
CA_2A-7A-12B	B2,B7
CA_2A-7A-66A	B2,B7,B66
CA_2A-2A-7A-66A	B7,B66
CA_2A-7A-7A-66A	B2
CA_2A-7A-66A-66A	B7
CA_2A-12A-66A	B2,B66
CA_2A-2A-12A-66A	B66
CA_2A-12B-66A	B2,B66
CA_4A-7A-12A	B4,B7
CA_7A-12A-66A	B7,B66
CA_7A-12B-66A	B7,B66
Inter-band CA (Four bands) With DL 4*4MIMO	4*4MIMO Band
CA_2A-4A-7A-12A	B2,B4
CA_2A-7A-12A-66A	B2,B7
CA_2A-2A-7A-12A-66A	B7
CA_2A-7A-12B-66A	B2,B7

According to 201705 FCC RF Exposure TCB workshop slides, SAR test exclusion for LTE DL 4x4 MIMO should be determined by UL power measurements with and without DL MIMO using the highest UL output power configuration without DL MIMO to confirm that UL output with DL MIMO is < ¼ dB higher. For DL MIMO with carrier aggregation, the same SAR test exclusion procedure should be considered.

For LTE DL 4x4 MIMO with carrier aggregation, the same SAR test exclusion procedure should be considered: In applying the existing power measurement procedures of KDB 941225 D05A for DL CA SAR test exclusion, only the subset with the largest number of combinations of frequency bands and CCs in each row need consideration. the configurations that require power measurements are in the table as below:

Index	2CCs	Restriction	Covered by	Index	3CCs	Restriction	Covered by	Index	4CCs	Restriction	Covered by	Index	5CCs	Restriction	Covered by
2CCs #1	CA_2C		Nb	3CCs #1	CA_66D		Nb	4CCs #1	CA_2A-2A-66C		5CCs #1	5CCs #1	CA_2A-2A-5A-66C		Nb
2CCs #2	CA_7C		3CCs #3	3CCs #2	CA_2A-2A-7A		4CCs #8	4CCs #2	CA_7C-66A-66A		5CCs #2	5CCs #2	CA_2A-2A-7A-12A-66A		Nb
2CCs #3	CA_66B		Nb	3CCs #3	CA_2A-7C		4CCs #3	4CCs #3	CA_2A-4A-7C		5CCs #3	5CCs #3	CA_2A-7A-12B-66A		Nb
2CCs #4	CA_66C		3CCs #8	3CCs #4	CA_2A-7A-7A		4CCs #4	4CCs #4	CA_2A-4A-7A-7A						
2CCs #5	CA_2A-4A		3CCs #19	3CCs #5	CA_2A-12B		4CCs #5	4CCs #5	CA_2A-4A-12A-12A						
2CCs #6	CA_2A-5A		3CCs #19	3CCs #6	CA_2A-12A-12A		4CCs #5	4CCs #6	CA_2A-2A-5A-66A						
2CCs #7	CA_2A-7A		3CCs #2	3CCs #7	CA_2A-2A-66A		4CCs #6	4CCs #7	CA_2A-5A-66C		5CCs #1				
2CCs #8	CA_2A-12A		3CCs #6	3CCs #8	CA_2A-66C		4CCs #1	4CCs #8	CA_2A-2A-7A-12A		5CCs #2				
2CCs #9	CA_2A-17A		Nb	3CCs #9	CA_4A-4A-7A		Nb	4CCs #9	CA_2A-7A-12B		5CCs #3				
2CCs #10	CA_2A-66A		3CCs #7	3CCs #10	CA_4A-7C		4CCs #3	4CCs #10	CA_2A-2A-7A-66A		5CCs #2				
2CCs #11	CA_4A-5A		3CCs #19	3CCs #11	CA_4A-12B		Nb	4CCs #11	CA_2A-7A-7A-66A						
2CCs #12	CA_4A-7A		3CCs #9	3CCs #12	CA_4A-12A-12A		4CCs #5	4CCs #12	CA_2A-7A-66A-66A						
2CCs #13	CA_4A-12A		3CCs #12	3CCs #13	CA_5A-7C		Nb	4CCs #13	CA_2A-2A-12A-66A		5CCs #2				
2CCs #14	CA_4A-17A		Nb	3CCs #14	CA_5A-66C		4CCs #7	4CCs #14	CA_2A-12B-66A		5CCs #3				
2CCs #15	CA_5A-7A		Nb	3CCs #15	CA_7A-12B		4CCs #9	4CCs #15	CA_7A-12B-66A		5CCs #3				
2CCs #16	CA_5A-66A		3CCs #22	3CCs #16	CA_7C-66A		4CCs #2	4CCs #16	CA_2A-4A-7A-12A						
2CCs #17	CA_7A-12A		3CCs #23	3CCs #17	CA_7A-66A-66A		4CCs #12	4CCs #17	CA_2A-7A-12A-66A		5CCs #2				
2CCs #18	CA_7A-66A		3CCs #17	3CCs #18	CA_12B-66A		4CCs #18								
2CCs #19	CA_12A-66A		3CCs #25	3CCs #19	CA_2A-4A-5A		Nb								
				3CCs #20	CA_2A-4A-7A		4CCs #4								
				3CCs #21	CA_2A-4A-12A		4CCs #5								
				3CCs #22	CA_2A-5A-66A		4CCs #6								
				3CCs #23	CA_2A-7A-12A		4CCs #8								
				3CCs #24	CA_2A-7A-66A		4CCs #10								
				3CCs #25	CA_2A-12A-66A		4CCs #13								
				3CCs #26	CA_4A-7A-12A		4CCs #16								
				3CCs #27	CA_7A-12A-66A		4CCs #17								

Refer to section 7.1 of this report for detailed DL 4*4 MIMO conducted power measurement results.

Power test equipment: The Anritsu Radio Communication Analyzer MT8821C were used for LTE Downlink 4x4MIMO.

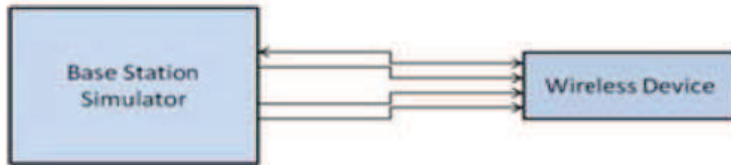

Figure: Power Measurement setup for single carrier with 4x4 DL MIMO.

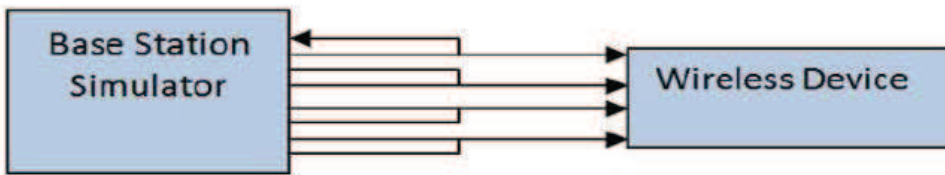

Figure: Power Measurement setup for Carrier Aggregation Scenarios with 2 Component Carriers with 4x4 DL MIMO.

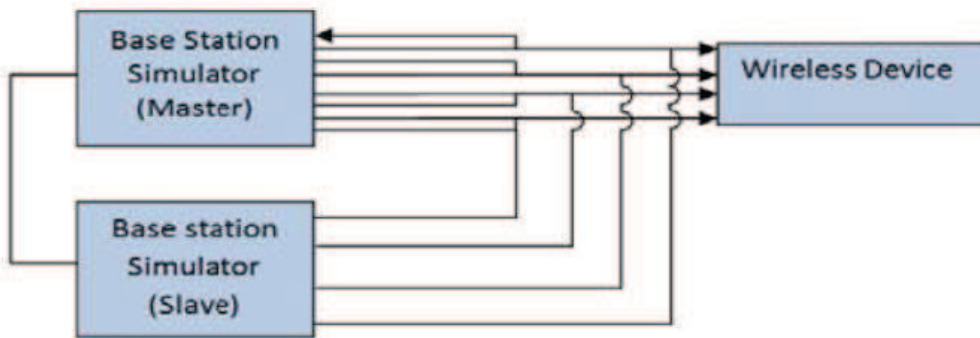

Figure: Power Measurement setup for Carrier Aggregation Scenarios with 3 Component Carriers with 4x4 DL MIMO.

6.8 Dynamic antenna switching specification

The device supports dynamic Tx antenna switching function for 2G/3G/4G bands. It can transmit from either Main Antenna or Second Antenna, but they can not transmit simultaneously (Refer to the Antenna location picture in the appendix for details).

SAR test procedure for dynamic antenna switching is as below:

During the SAR test, the Main Antenna and Second Antenna are set to the MAX transmit power level respectively and test the SAR respectively in all applicable RF exposure conditions. Some commands or test scripts are supplied to fix the operation state so that only one TX antenna is chosen and tested at a time. All independent antennas are completely covered by the appropriate SAR measurements. We can ensure that all independent antennas and modem are completely covered by the appropriate SAR measurements and all simultaneous transmission possibilities are fully considered.

6.9 Power Reduction Specification

This device uses the following power reduction features to reduce the transmit power and ensure SAR compliance. These power reduction features are implemented using a single fixed level of reduction through static table look-up for some wireless operating modes or frequency bands and triggered by a single event or operation. The published RF exposure KDB procedures are applicable to the specific implementation and applied for testing. So PAG is not required for these features.

- 1) A fixed level power reduction is applied for some frequency bands when hotspot mode becomes active. When the hotspot is disabled, the power value will be recovered.
- 2) A fixed level power reduction is applied for some frequency bands when 2G/3G/4G and WIFI transmit simultaneously.
- 3) This device uses the receiver to indicate whether the user is making a voice call in head scenario or not. The selection between head and body power levels is based on the receiver detection mechanism. A fixed level power reduction is applied for some frequency bands when the audio receiver is on.
- 4) This device uses the mobile country code (MCC) detection mechanism to indicate whether the users in CE countries, FCC countries or CN(China) in WiFi bands. The selection between different power levels is based on the country code detection mechanism. It can determine the countries where users are and set the relevant power level for WiFi antennas accordingly.

Antenna	MCC OF CE COUNTRY (CE standard)	MCC OF FCC COUNTRY (FCC standard)	MCC OF CN (CN standard)
WiFi 2.4G Core0 (Ant 3)	Power Level A3	Power Level B3	Power Level C3
WiFi 2.4G Core1 (Ant 4)	Power Level A4	Power Level B4	Power Level C4
WiFi 5G Core0 (Ant 3)	Power Level A5	Power Level B5	Power Level C5
WiFi 5G Core1(Ant 4)	Power Level A6	Power Level B6	Power Level C6

- 5) This device uses a proximity sensor to reduce the maximum output power of 2G/3G/4G main transmitting antenna in selected wireless modes and operating configurations to ensure SAR compliance. The procedures in KDB 616217 are applied to determine proximity sensor triggering distances, and sensor coverage for normal and tilt positions.

6.9.1 Power reduction triggered by specific use conditions (2G&3G&4G Second Antenna)

The following tables summarize the key power reduction information of 2G/3G/4G second antenna triggered by specific use conditions. The detailed full power and reduced conducted power measurement results are provided in Section 7 of this report:

Band	Second Antenna Power Reduction Level Amount (dB)			
	Second Antenna only		Second Antenna+WiFi Antenna simultaneous transmission	
	Receiver off	Receiver on	Receiver off	Receiver on
	Full Power	Reduced Power Level D1	Reduced Power Level D2	Reduced Power Level D3
GSM850	0	5	0	5
GSM1900	0	2	1	3
UMTS Band II	0	5	3	8
UMTS Band IV	0	5.5	3	8.5
UMTS Band V	0	6	0	6
LTE Band 2	0	5	3	8
LTE Band 4	0	6.5	3	9.5
LTE Band 5	0	6	0	6
LTE Band 7	0	5	2	7
LTE Band 12	0	4.5	0	4.5
LTE Band 17	0	4.5	0	4.5
LTE Band 26	0	5.5	0	5.5
LTE Band 38	0	4.5	1	5.5
LTE Band 41	0	5	2	7
LTE Band 66	0	5	3	8

Note: For Head SAR test of 2G/3G/4G Second Antenna, standalone Head SAR should be evaluated with audio receiver on. The audio receiver only works in voice mode when the user is making a call in head scenario, lacking of the third-party VoIP server and the unstandardized VOIP operating characteristic, therefore, a test script tool is used to trigger the receiver on during the test. The test script is only used to trigger audio receiver on and simulate voice and VOIP usage scene. It can be ensured that the unmodified settings in production units, including maximum output power, amplifier gain and other RF performance or tuning parameters, are used for SAR measurement.

6.9.2 Power Reduction Specification of WiFi Antenna

The following tables summarize the key WiFi power reduction information and WiFi conducted power validation results of MCC detection mechanism with signaling mode:

Config.			Tune-up				WiFi conducted power validation results(dBm)			
Band	Antenna	Mode	MCC of FCC countries		MCC of CE countries		MCC of FCC countries		MCC of CE countries	
			Receiver on	Receiver off	Receiver on	Receiver off	Receiver on	Receiver off	Receiver on	Receiver off
WiFi 2.4G	Core0 (Ant3)	802.11b	14.50	18.00	17.00	18.00	13.02	16.82	15.45	16.74
		802.11g	14.50	18.00	17.00	18.00	13.66	16.45	15.80	16.27
		802.11n (20M)	14.50	17.00	17.00	17.00	13.46	15.45	15.42	15.25
		802.11n (40M)	14.50	15.50	15.50	15.50	13.87	14.65	13.66	14.46
	Core1 (Ant4)	802.11b	14.50	17.00	17.00	17.00	11.77	15.27	15.34	15.14
		802.11g	14.50	17.00	17.00	17.00	12.92	15.23	15.74	15.05
		802.11n (20M)	14.50	16.00	16.00	16.00	12.91	15.22	14.68	15.14
		802.11n (40M)	14.50	14.50	14.50	14.50	12.65	13.22	12.67	13.07
	CDD/MIMO	802.11g	17.51	20.54	20.01	20.54	16.06	19.14	18.75	18.71
		802.11n (20M)	17.51	19.54	19.54	19.54	16.05	18.50	18.10	18.21
802.11n (40M)		17.51	18.04	18.04	18.04	16.16	17.15	16.19	16.83	
U-NII-1	Core0 (Ant3)	802.11a	11.00	16.00	14.50	16.00	10.12	14.77	13.24	14.69
		802.11n (20M)	11.00	16.00	14.50	16.00	10.34	15.63	12.73	15.51
		802.11n (40M)	11.00	15.50	14.50	15.50	10.61	15.23	11.30	12.33
		802.11ac (20M)	11.00	16.00	14.50	16.00	10.68	15.40	12.76	15.22
		802.11ac (40M)	11.00	15.50	14.50	15.50	10.56	15.31	12.88	13.58
		802.11ac (80M)	6.50	6.50	6.50	6.50	5.80	5.64	3.66	5.56
	Core1 (Ant4)	802.11a	11.00	15.50	14.50	15.50	10.31	14.86	12.86	14.78
		802.11n (20M)	11.00	15.50	14.50	15.50	10.35	15.19	12.36	15.07
		802.11n (40M)	11.00	15.00	14.50	15.00	10.64	14.74	13.09	13.49
		802.11ac (20M)	11.00	15.50	14.50	15.50	10.23	14.58	12.49	14.40
		802.11ac (40M)	11.00	15.00	14.50	15.00	10.37	14.82	12.26	12.75
		802.11ac (80M)	6.50	6.50	6.50	6.50	5.90	5.33	4.88	5.15
	CDD/MIMO	802.11a	14.01	18.77	17.51	18.77	13.31	17.91	16.06	17.75
		802.11n (20M)	14.01	18.77	17.51	18.77	13.44	18.51	15.56	18.31
		802.11n (40M)	14.01	18.27	17.51	18.27	13.77	18.13	15.30	15.96
		802.11ac (20M)	14.01	18.77	17.51	18.77	13.45	18.00	15.64	17.84

		802.11ac (40M)	14.01	18.27	17.51	18.27	13.41	18.02	13.41	18.02
		802.11ac (80M)	9.51	9.51	9.51	9.51	8.84	8.48	7.32	8.37
U-NII-1 & U-NII-2A	Core0 (Ant3)	802.11ac (160M)	6.50	6.50	6.50	6.50	6.00	6.12	3.55	5.92
	Core1 (Ant4)	802.11ac (160M)	6.50	6.50	6.50	6.50	5.86	6.12	3.86	5.94
	MIMO	802.11ac (160M)	9.51	9.51	9.50	9.50	8.69	8.88	6.72	8.94
U-NII-2A	Core0 (Ant3)	802.11a	11.00	16.00	14.50	16.00	10.25	14.95	13.65	14.66
		802.11n (20M)	11.00	16.00	14.50	16.00	10.46	15.48	12.92	15.28
		802.11n (40M)	11.00	15.50	14.50	15.50	10.55	15.05	11.40	12.26
		802.11ac (20M)	11.00	16.00	14.50	16.00	10.32	14.82	12.56	14.57
		802.11ac (40M)	11.00	15.50	14.50	15.50	10.82	15.31	12.78	13.52
		802.11ac (80M)	6.50	6.50	6.50	6.50	5.88	5.71	3.67	5.53
	Core1 (Ant4)	802.11a	11.00	15.50	14.50	15.50	10.30	14.66	13.68	14.54
		802.11n (20M)	11.00	15.50	14.50	15.50	10.30	15.03	13.16	14.83
		802.11n (40M)	11.00	15.00	14.50	15.00	10.63	14.73	13.24	13.67
		802.11ac (20M)	11.00	15.50	14.50	15.50	10.18	14.54	12.04	14.29
		802.11ac (40M)	11.00	15.00	14.50	15.00	10.70	14.75	12.03	12.47
		802.11ac (80M)	6.50	6.50	6.50	6.50	5.83	5.58	3.86	5.39
	CDD/MIMO	802.11a	14.01	18.77	17.51	18.77	13.13	17.80	16.68	17.61
		802.11n (20M)	14.01	18.77	17.51	18.77	13.23	18.25	16.05	18.07
		802.11n (40M)	14.01	18.27	17.51	18.27	13.39	17.69	15.43	16.03
		802.11ac (20M)	14.01	18.77	17.51	18.77	13.35	17.43	15.32	17.44
		802.11ac (40M)	14.01	18.27	17.51	18.27	13.72	18.19	13.72	18.19
		802.11ac (80M)	9.51	9.51	9.51	9.51	8.75	8.54	6.78	8.47
U-NII-2C	Core0 (Ant3)	802.11a	11.00	16.00	14.50	16.00	10.25	14.90	13.28	14.72
		802.11n (20M)	11.00	16.00	14.50	16.00	10.48	15.48	12.88	15.23
		802.11n (40M)	11.00	15.50	14.50	15.50	10.66	14.95	11.58	12.63
		802.11ac (20M)	11.00	16.00	14.50	16.00	10.43	14.93	12.88	14.82
		802.11ac (40M)	11.00	15.50	14.50	15.50	10.34	15.09	12.86	13.58
		802.11ac (80M)	6.50	6.50	6.50	6.50	5.74	5.55	4.32	5.30
	Core1 (Ant4)	802.11ac (160M)	6.50	6.50	6.50	6.50	5.98	6.08	4.23	6.00
		802.11a	11.00	15.50	14.50	15.50	10.23	14.78	12.72	14.60
		802.11n (20M)	11.00	15.50	14.50	15.50	10.44	15.28	11.60	15.03
		802.11n (40M)	11.00	15.00	14.50	15.00	10.56	14.66	13.03	13.47
		802.11ac (20M)	11.00	15.50	14.50	15.50	10.28	14.63	12.41	14.52
		802.11ac	11.00	15.00	14.50	15.00	10.25	14.70	12.30	12.66

		(40M)								
		802.11ac (80M)	6.50	6.50	6.50	6.50	5.76	5.45	4.38	5.37
		802.11ac (160M)	6.50	6.50	6.50	6.50	6.13	6.21	4.58	6.06
	CDD/MIMO	802.11a	14.01	18.77	17.51	18.77	13.06	17.66	16.02	17.67
		802.11n (20M)	14.01	18.77	17.51	18.77	13.28	18.20	15.30	18.14
		802.11n (40M)	14.01	18.27	17.51	18.27	13.57	17.77	15.38	16.08
		802.11ac (20M)	14.01	18.77	17.51	18.77	13.23	17.66	15.66	17.68
802.11ac (40M)		14.01	18.27	17.51	18.27	13.40	18.01	13.40	18.01	
802.11ac (80M)		9.51	9.51	9.51	9.51	8.54	8.22	7.36	8.35	
U-NII-3	Core0 (Ant3)	802.11a	11.00	16.00	11.50	11.50	10.78	14.89	10.30	10.36
		802.11n (20M)	11.00	16.00	11.50	11.50	10.95	15.83	10.60	10.48
		802.11n (40M)	11.00	15.50	11.50	11.50	10.44	14.97	8.51	8.41
		802.11ac (20M)	11.00	16.00	11.50	11.50	10.85	15.30	10.50	10.38
		802.11ac (40M)	11.00	15.50	11.50	11.50	10.71	15.39	10.51	10.60
		802.11ac (80M)	11.00	11.50	11.50	11.50	10.56	10.54	10.82	10.45
	Core1 (Ant4)	802.11a	11.00	15.50	11.50	11.50	10.35	14.89	10.36	10.43
		802.11n (20M)	11.00	15.50	11.50	11.50	10.18	15.19	10.20	10.20
		802.11n (40M)	11.00	15.00	11.50	11.50	10.53	14.70	10.07	10.06
		802.11ac (20M)	11.00	15.50	11.50	11.50	10.08	14.55	10.80	11.10
		802.11ac (40M)	11.00	15.00	11.50	11.50	10.52	14.88	8.17	8.00
		802.11ac (80M)	11.00	11.50	11.50	11.50	10.67	10.66	10.71	10.44
	CDD/MIMO	802.11a	14.01	18.77	14.51	14.51	13.46	17.77	13.34	13.41
		802.11n (20M)	14.01	18.77	14.51	14.51	13.47	18.51	13.41	13.35
		802.11n (40M)	14.01	18.27	14.51	14.51	13.42	17.76	12.37	12.32
		802.11ac (20M)	14.01	18.77	14.51	14.51	13.48	17.79	13.66	13.77
		802.11ac (40M)	14.01	18.27	14.51	18.27	13.41	18.18	13.63	18.18
		802.11ac (80M)	14.01	14.51	14.51	14.51	13.47	13.46	13.78	13.46

Note:

- 1) For FCC SAR test, WiFi SAR test should be evaluated at the power level of FCC mobile country code for each exposure conditions of WiFi .
- 2) The detailed full power and reduced conducted power measurement results are provided in section 7 of this report

6.9.3 Power reduction Specification of 2G&3G&4G Main antenna

The following tables summarize the key power reduction information of 2G/3G/4G main antenna. The detailed full power and reduced conducted power measurement results are provided in section 7 of this report:

Band	Main antenna only				Simultaneous Transmission with WiFi							
	Receiver on	Receiver off			Receiver on		Receiver off					
	/	/	/		WiFi Station /P2P	Hotspot	WiFi Station/P2P			Hotspot		
	/	sensor off	sensor on*		/	/	sensor off	sensor on**		sensor off	sensor on**	
	Full power	/	Reduced Power Level D4	Reduced Power Level D5	Reduced Power Level D9	Reduced Power Level D10	Reduced Power Level D1	Reduced Power Level D2	Reduced Power Level D3	Reduced Power Level D6	Reduced Power Level D7	Reduced Power Level D8
GSM1900	0	0	0	0	0	/	0	0	0	0.5	0.5	0.5
UMTS Band II	0	0	1.5	0	0	3	0	1.5	0	3	4.5	3
UMTS Band IV	0	0	1.5	0	0.4	3	0.4	1.9	0.4	3	4.5	3
LTE Band 2	0	0	1	0	0	3	0	1	0	3	4	3
LTE Band 4	0	0	2	0	0.5	3.5	0.5	2.5	0.5	3.5	5.5	3.5
LTE Band 7	0	0	3.5	2.5	0	3	0	3.5	2.5	3	6.5	5.5
UL CA 7C	0	0	3.5	2.5	0	3	0	3.5	2.5	3	6.5	5.5
LTE Band 38	0	0	2	1	0	2	0	2	1	2	4	3
UL CA 38C	0	0	2	1	0	2	0	2	1	2	4	3
LTE Band 41	0	0	0	0	0.5	2	0.5	0.5	0.5	2	2	2
LTE Band 66	0	0	1	0	0.5	2.5	0.5	1.5	1.5	2.5	3.5	2.5

Note:

- 1) * Reduced Power Level D4 or Reduced Power Level D5 is determined by different sensor Trigger Distance ranges when hotspot is off(Main antenna only);
- 2) ** Reduced Power Level D7 or Reduced Power Level D8 is determined by different sensor Trigger Distance range when hotspot is on;
- 3) *** Reduced Power Level D2 or Reduced Power Level D3 is determined by different sensor Trigger Distance range when Main antenna transmits simultaneously with WiFi Station/P2P
- 4) For some frequency bands, the power reduction level amount value 0 means there is no power reduction in this frequency band and exposure conditions. The power level is the same as full power.
- 5) Please refer to section 6.9.4 for detailed Proximity sensor power reduction test configuration and validation results per KDB616217.

6.9.4 Proximity sensor Power Reduction Test configuration and validation

Due to the operating configurations and exposure conditions required by the device, the proximity sensor is used to indicate when the device is held close to a user's body/hotspot exposure condition. It utilizes the proximity sensor to reduce the output power in specific wireless and operating modes of main antenna to ensure SAR compliance. It is also set an output power leveled to the lowest one to make sure that in any case of SAR sensor hardware failure, the SAR requirements can still be satisfied.

The following tables summarize the key power reduction information for proximity sensor. The test procedures in KDB 616217 should be applied to determine proximity sensor triggering distances, and sensor coverage for normal and tilt positions. To ensure all production units are compliant, it is generally necessary to reduce the triggering distance determined from the triggering tests by 1 mm, or more if it is necessary, and use the smallest distance for movements to and from the phantom, minus 1 mm, as the sensor triggering distance for determining the SAR measurement distance.

Main antenna					
Band	Test position	Sensor Trigger Distance range (DUT to Phantom)	Power reduction amount(dB)	Max Power level(dBm)	Power level
UMTS Band II	Bottom side	0mm ≤ distance ≤ 8mm	1.5	23.5	Reduced Power Level D4
		8mm < distance	0	25	Full Power
	Back side	0mm ≤ distance ≤ 6mm	1.5	23.5	Reduced Power Level D4
		6mm < distance	0	25	Full Power
	Front side	0mm ≤ distance ≤ 6mm	1.5	23.5	Reduced Power Level D4
		6mm < distance	0	25	Full Power
	Left side	ALL	0	25	Full Power
	Right side	ALL	0	25	Full Power
Top side	ALL	0	25	Full Power	
UMTS Band IV	Bottom side	0mm ≤ distance ≤ 8mm	1.5	23.5	Reduced Power Level D4
		8mm < distance	0	25	Full Power
	Back side	0mm ≤ distance ≤ 6mm	1.5	23.5	Reduced Power Level D4
		6mm < distance	0	25	Full Power
	Front side	0mm ≤ distance ≤ 6mm	1.5	23.5	Reduced Power Level D4
		6mm < distance	0	25	Full Power
	Left side	ALL	0	25	Full Power
	Right side	ALL	0	25	Full Power
Top side	ALL	0	25	Full Power	
LTE B2	Bottom side	0mm ≤ distance ≤ 8mm	1	23.5	Reduced Power Level D4
		8mm < distance	0	24.5	Full Power
	Back side	0mm ≤ distance ≤ 6mm	1	23.5	Reduced Power Level D4
		6mm < distance	0	24.5	Full Power

	Front side	$0\text{mm} \leq \text{distance} \leq 6\text{mm}$	1	23.5	Reduced Power Level D4
		$6\text{mm} < \text{distance}$	0	24.5	Full Power
	Left side	ALL	0	24.5	Full Power
	Right side	ALL	0	24.5	Full Power
	Top side	ALL	0	24.5	Full Power
LTE B4	Bottom side	$0\text{mm} \leq \text{distance} \leq 8\text{mm}$	2	23	Reduced Power Level D4
		$8\text{mm} < \text{distance}$	0	25	Full Power
	Back side	$0\text{mm} \leq \text{distance} \leq 6\text{mm}$	2	23	Reduced Power Level D4
		$6\text{mm} < \text{distance}$	0	25	Full Power
	Front side	$0\text{mm} \leq \text{distance} \leq 6\text{mm}$	2	23	Reduced Power Level D4
		$6\text{mm} < \text{distance}$	0	25	Full Power
	Left side	ALL	0	25	Full Power
	Right side	ALL	0	25	Full Power
Top side	ALL	0	25	Full Power	
LTE B7	Bottom side	$0\text{mm} \leq \text{distance} \leq 8\text{mm}$	3.5	21	Reduced Power Level D4
		$8\text{mm} < \text{distance} \leq 13\text{mm}$	2.5	22	Reduced Power Level D5
		$\text{distance} > 13\text{mm}$	0	24.5	Full Power
	Back side	$0\text{mm} \leq \text{distance} \leq 6\text{mm}$	3.5	21	Reduced Power Level D4
		$6\text{mm} < \text{distance} \leq 9\text{mm}$	2.5	22	Reduced Power Level D5
		$\text{distance} > 9\text{mm}$	0	24.5	Full Power
	Front side	$0\text{mm} \leq \text{distance} \leq 6\text{mm}$	3.5	21	Reduced Power Level D4
		$6\text{mm} < \text{distance} \leq 9\text{mm}$	2.5	22	Reduced Power Level D5
		$\text{distance} > 9\text{mm}$	0	24.5	Full Power
	Left side	ALL	0	24.5	Full Power
	Right side	ALL	0	24.5	Full Power
	Top side	ALL	0	24.5	Full Power
LTE B38	Bottom side	$0\text{mm} \leq \text{distance} \leq 8\text{mm}$	2	23	Reduced Power Level D4
		$8\text{mm} < \text{distance} \leq 13\text{mm}$	1	24	Reduced Power Level D5
		$\text{distance} > 13\text{mm}$	0	25	Full Power
	Back side	$0\text{mm} \leq \text{distance} \leq 6\text{mm}$	2	23	Reduced Power Level D4
		$6\text{mm} < \text{distance} \leq 9\text{mm}$	1	24	Reduced Power Level D5
		$\text{distance} > 9\text{mm}$	0	25	Full Power
	Front side	$0\text{mm} \leq \text{distance} \leq 6\text{mm}$	2	23	Reduced Power Level D4
		$6\text{mm} < \text{distance} \leq 9\text{mm}$	1	24	Reduced Power Level D5
		$\text{distance} > 9\text{mm}$	0	25	Full Power

	Left side	ALL	0	25	Full Power
	Right side	ALL	0	25	Full Power
	Top side	ALL	0	25	Full Power
LTE B66	Bottom side	$0\text{mm} \leq \text{distance} \leq 8\text{mm}$	1	23	Reduced Power Level D4
		$8\text{mm} < \text{distance}$	0	24	Full Power
	Back side	$0\text{mm} \leq \text{distance} \leq 6\text{mm}$	1	23	Reduced Power Level D4
		$6\text{mm} < \text{distance}$	0	24	Full Power
	Front side	$0\text{mm} \leq \text{distance} \leq 6\text{mm}$	1	23	Reduced Power Level D4
		$6\text{mm} < \text{distance}$	0	24	Full Power
	Left side	ALL	0	24	Full Power
	Right side	ALL	0	24	Full Power
	Top side	ALL	0	24	Full Power

Note:

To ensure all production units are compliant, the smallest separation distance determined by the sensor triggering and sensor coverage for normal and tilt positions for all usage conditions and applicable sides, minus 1 mm, must be used as the test separation distance for additional SAR testing of each higher power stage.

For the other sides or other frequency bands of the device, SAR is still tested at the maximum full power level with sensor off.

1) Procedures for determining proximity sensor triggering distances

The device was tested by the test lab to determine the proximity sensor triggering distances for the front side, back side and bottom side of the device. To ensure all production units are compliant, the smallest separation distance determined by the sensor triggering minus 1 mm, must be used as the test separation distance for SAR testing.

the proximity sensor triggering distance measurement method are as below:



Picture: Proximity sensor triggering distances assessment Bottom Side



Picture: Proximity sensor triggering distances assessment Front Side and Back side

Table: Summary of Trigger Distances

Band	Reduced Power Level	Trigger distance-Front Side		Trigger distance-Back Side		Trigger distance-Bottom Side	
		Moving toward phantom	Moving away from phantom	Moving toward phantom	Moving away from phantom	Moving toward phantom	Moving away from phantom
UMTS Band II	Reduced Power Level D4	6mm	6mm	6mm	6mm	8mm	8mm
UMTS Band IV	Reduced Power Level D4	6mm	6mm	6mm	6mm	8mm	8mm
LTE Band 2	Reduced Power Level D4	6mm	6mm	6mm	6mm	8mm	8mm
LTE Band 4	Reduced Power Level D4	6mm	6mm	6mm	6mm	8mm	8mm
LTE Band 7	Reduced Power Level D4	6mm	6mm	6mm	6mm	8mm	8mm
	Reduced Power Level D5	9mm	9mm	9mm	9mm	13mm	13mm
UL CA_7C	Reduced Power Level D4	6mm	6mm	6mm	6mm	8mm	8mm
	Reduced Power Level D5	9mm	9mm	9mm	9mm	13mm	13mm
LTE Band 38	Reduced Power Level D4	6mm	6mm	6mm	6mm	8mm	8mm
	Reduced Power Level D5	9mm	9mm	9mm	9mm	13mm	13mm
UL CA_38C	Reduced Power Level D4	6mm	6mm	6mm	6mm	8mm	8mm
	Reduced Power Level D5	9mm	9mm	9mm	9mm	13mm	13mm
LTE Band 66	Reduced Power Level D4	6mm	6mm	6mm	6mm	8mm	8mm

Note:

- 1) * The sensor Trigger Distance of Reduced Power Level D7 (WIFI hotspot on) , Level D2 (WiFi station on) and Level D4 (WIFI hotspot off / WIFI station off, main antenna only) are the same.
- 2) * The sensor Trigger Distance of Reduced Power Level D8 (WIFI hotspot on) , Level D3 (WiFi station on) and Level D5(WIFI hotspot off / WIFI station off, main antenna only) are the same.

The detailed conducted power measurement data to determine the triggering distances is as below:

The DUT(Front side) is moved towards the flat phantom with/without protective cover(WIFI hotspot off / WIFI station off):

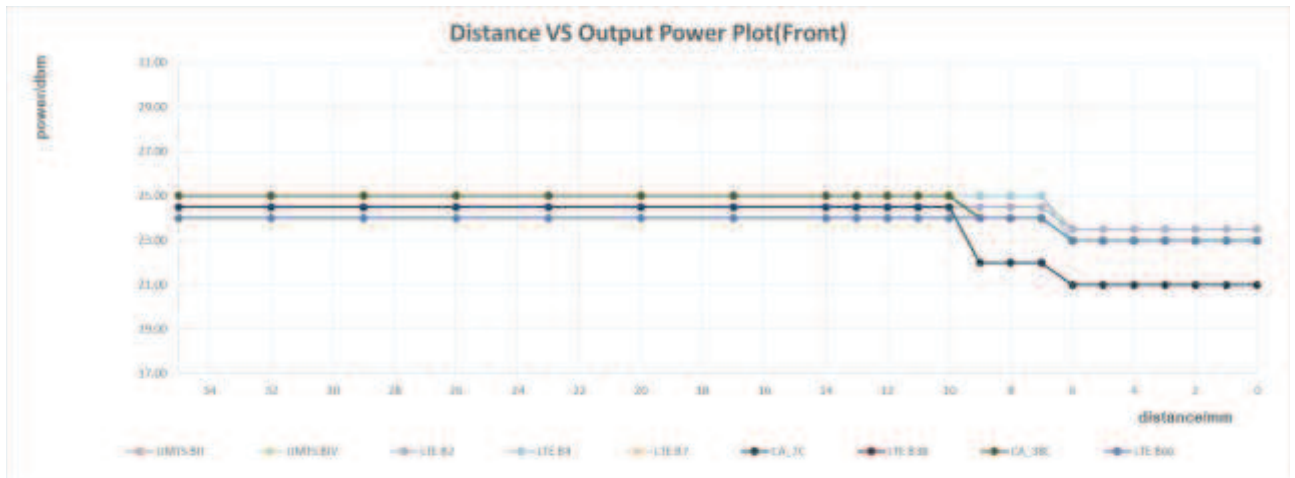

The DUT(Back side) is moved towards the flat phantom with/without protective cover (WIFI hotspot / station off):

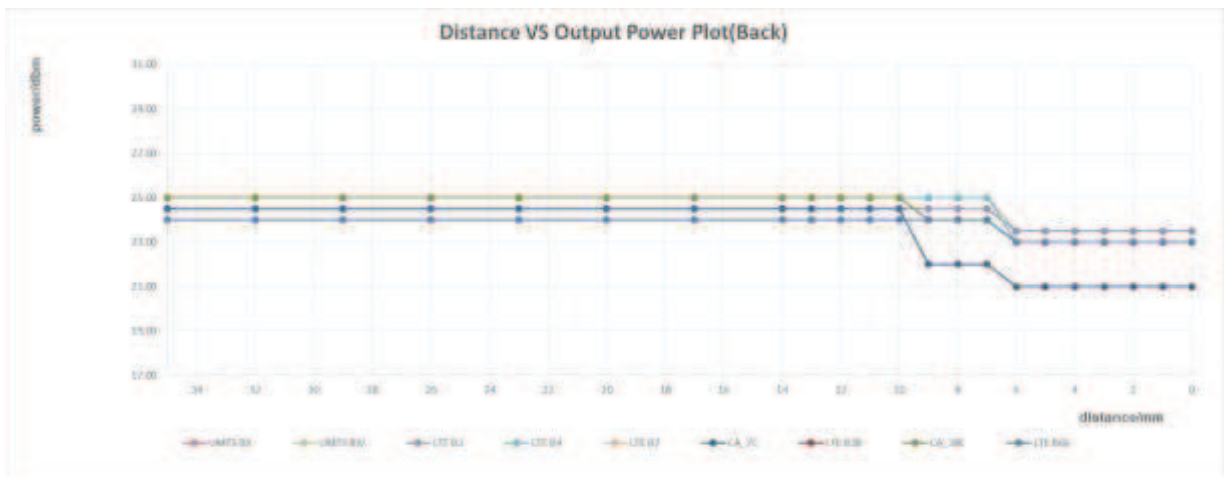

The DUT(Bottom side) is moved towards the flat phantom with/without protective cover(WIFI hotspot / station off):

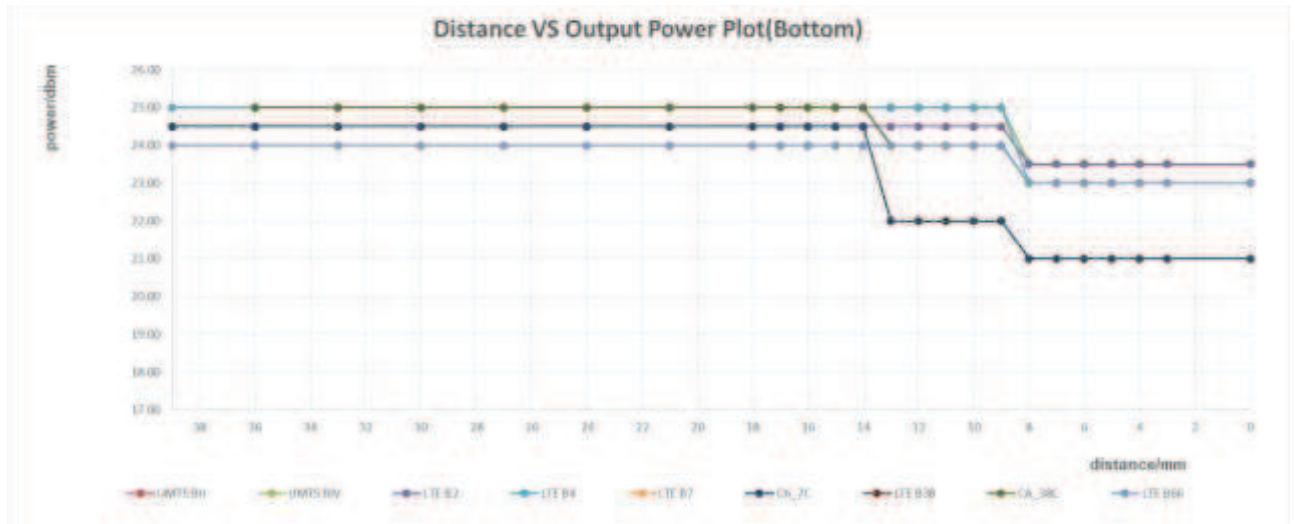

The DUT(Front side) is moved towards the flat phantom with/without protective cover(hotspot on):

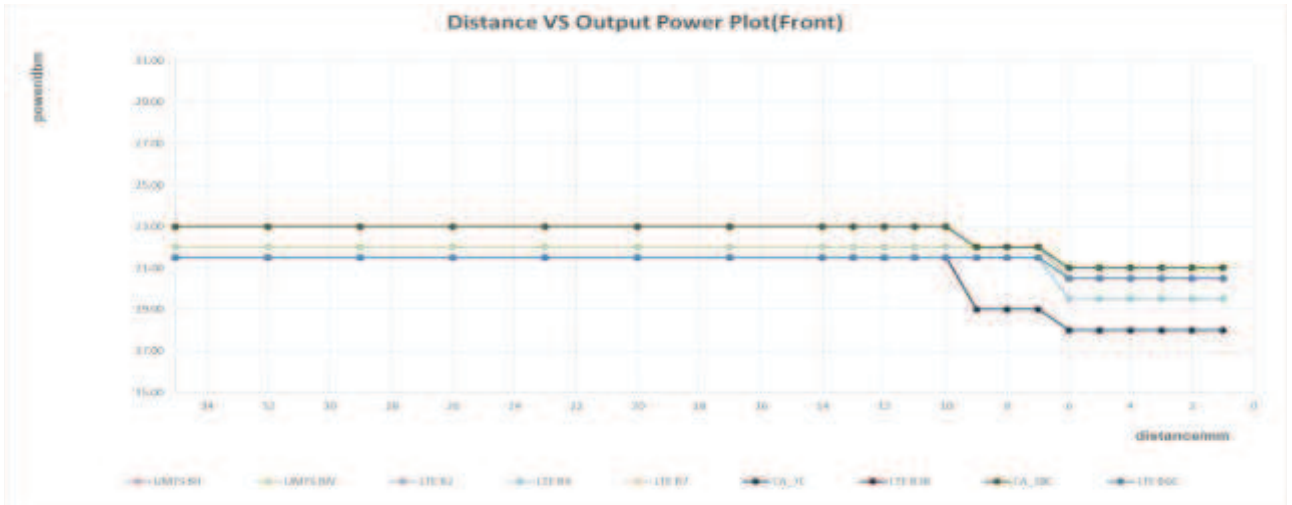

The DUT(Back side) is moved towards the flat phantom with/without protective cover(hotspot on):

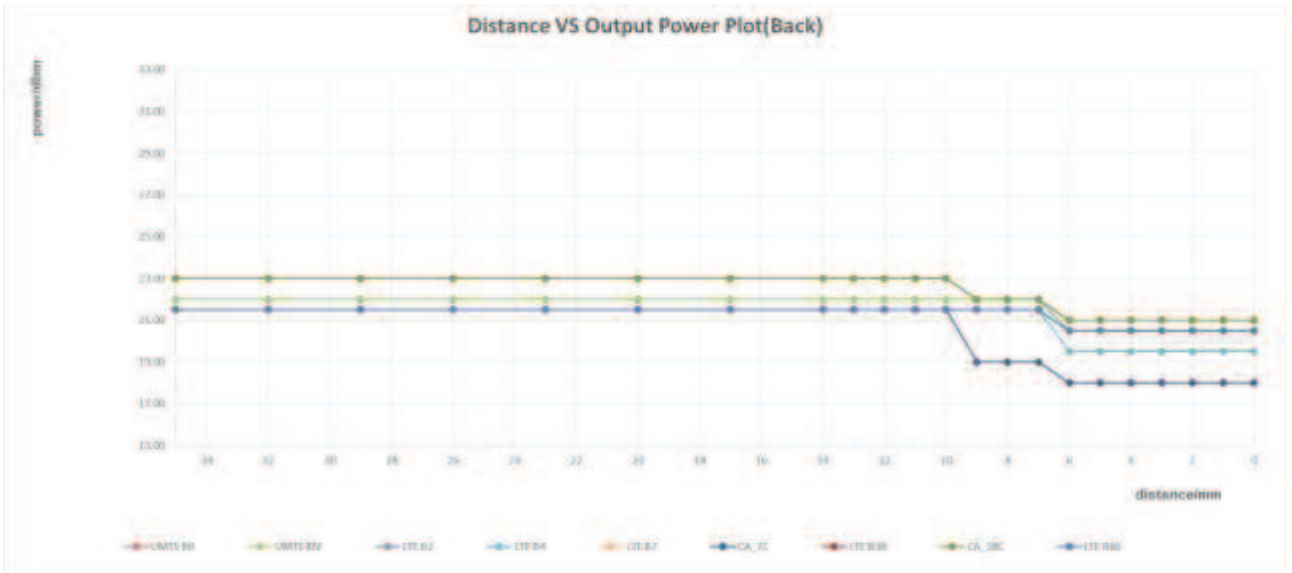

The DUT(Bottom side) is moved towards the flat phantom with/without protective cover(hotspot on):

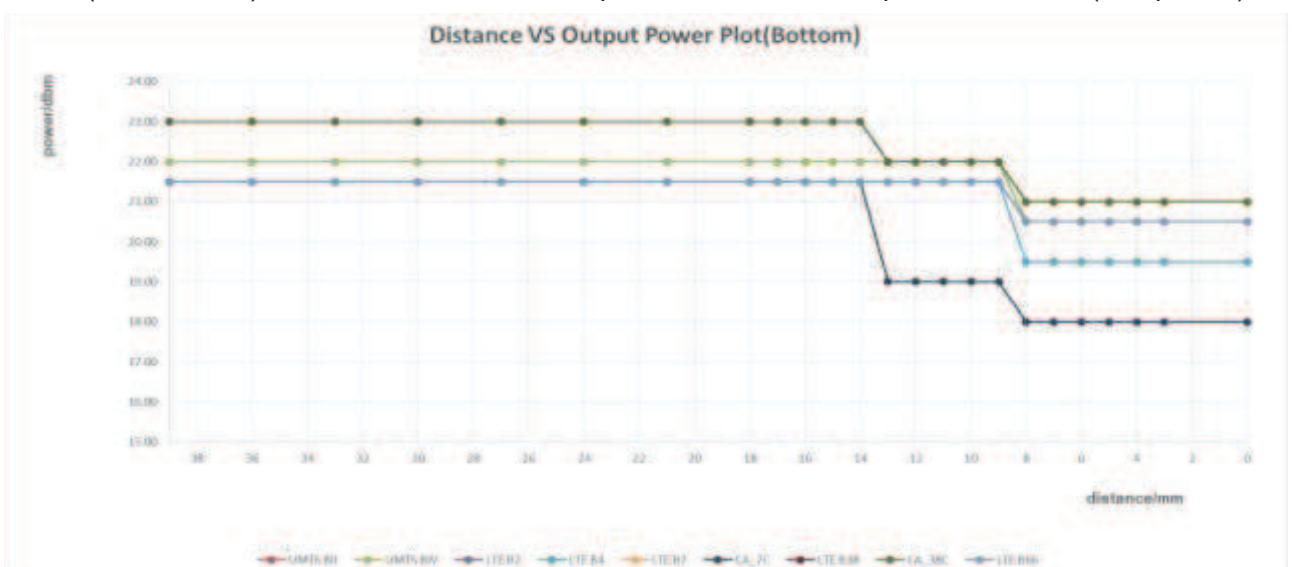

The DUT(Front side) is moved away from the flat phantom with/without protective cover(hotspot on):

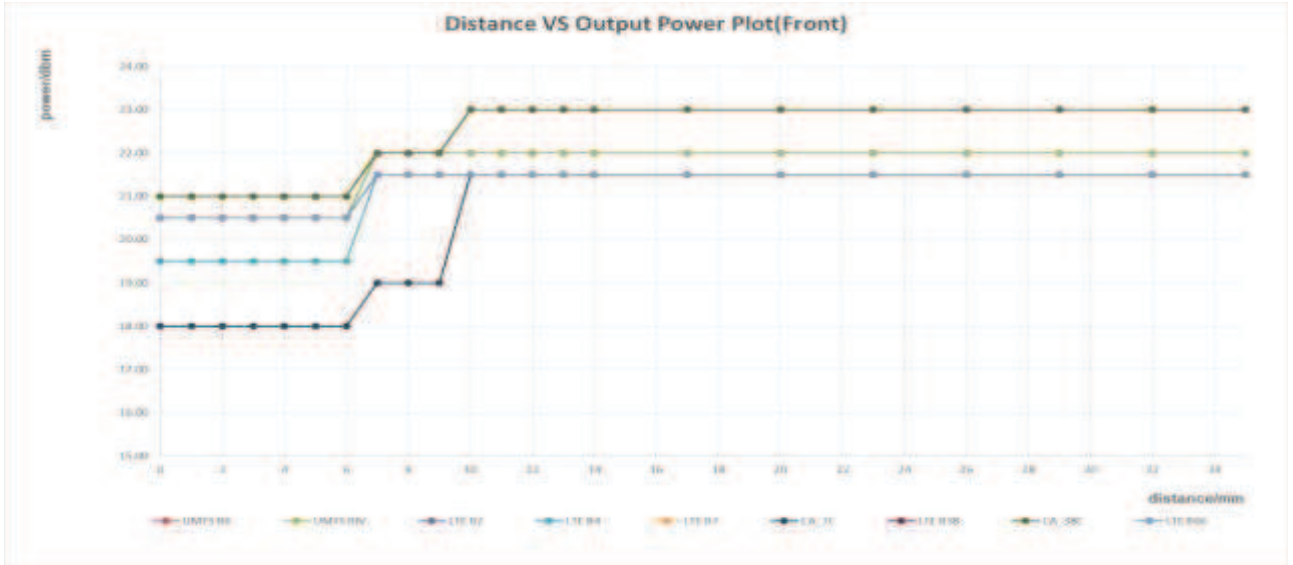

The DUT(Back side) is moved away from the flat phantom with/without protective cover(hotspot on):

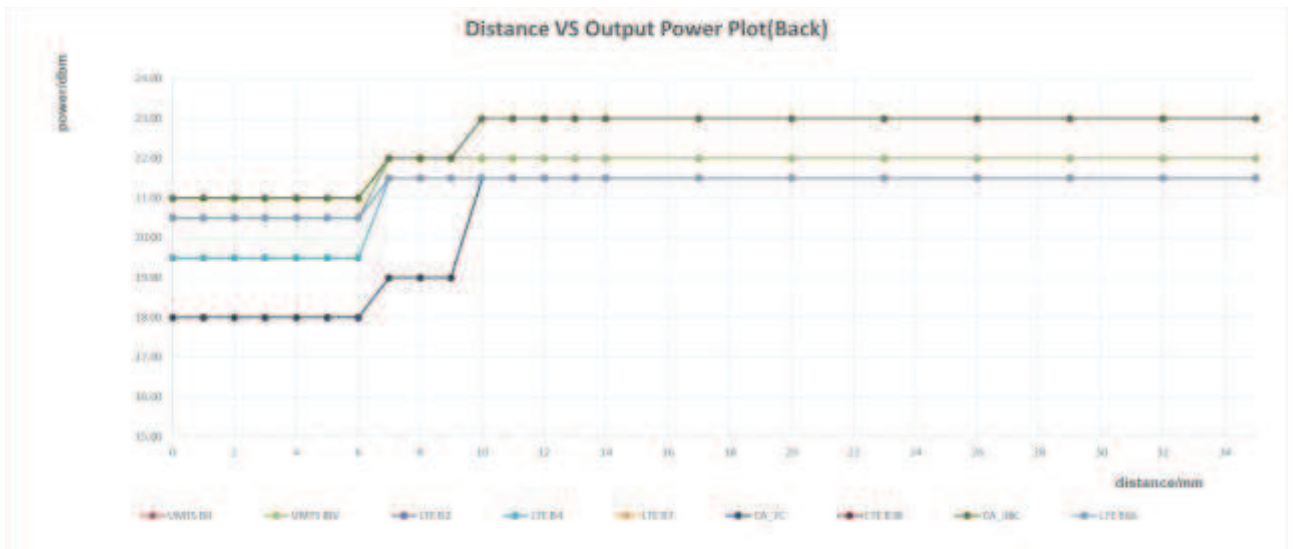

The DUT(Bottom side) is moved away from the flat phantom with/without protective cover(hotspot on):

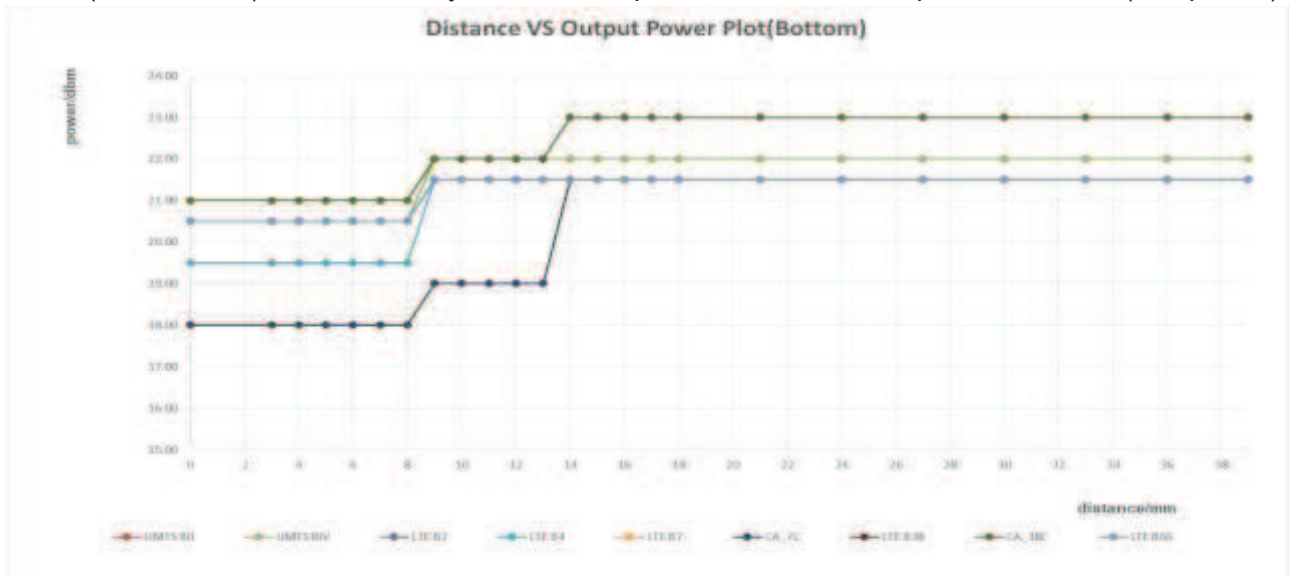

The DUT(Front side) is moved towards the flat phantom with/without protective cover(WiFi Station on):

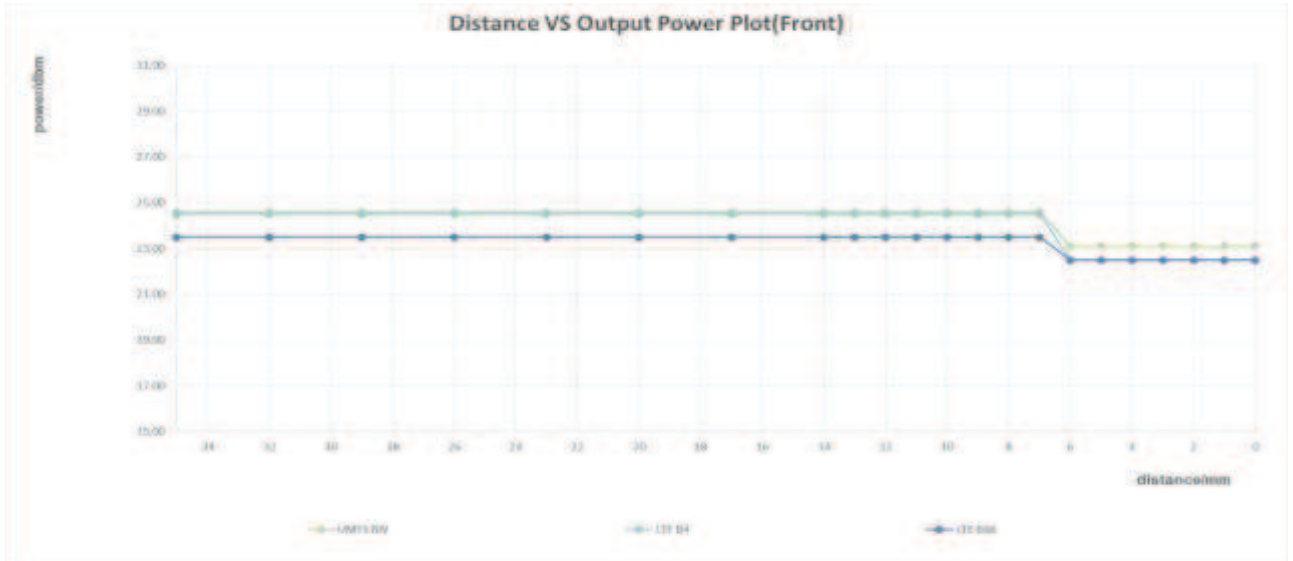

The DUT(Back side) is moved towards the flat phantom with/without protective cover(WiFi Station on):

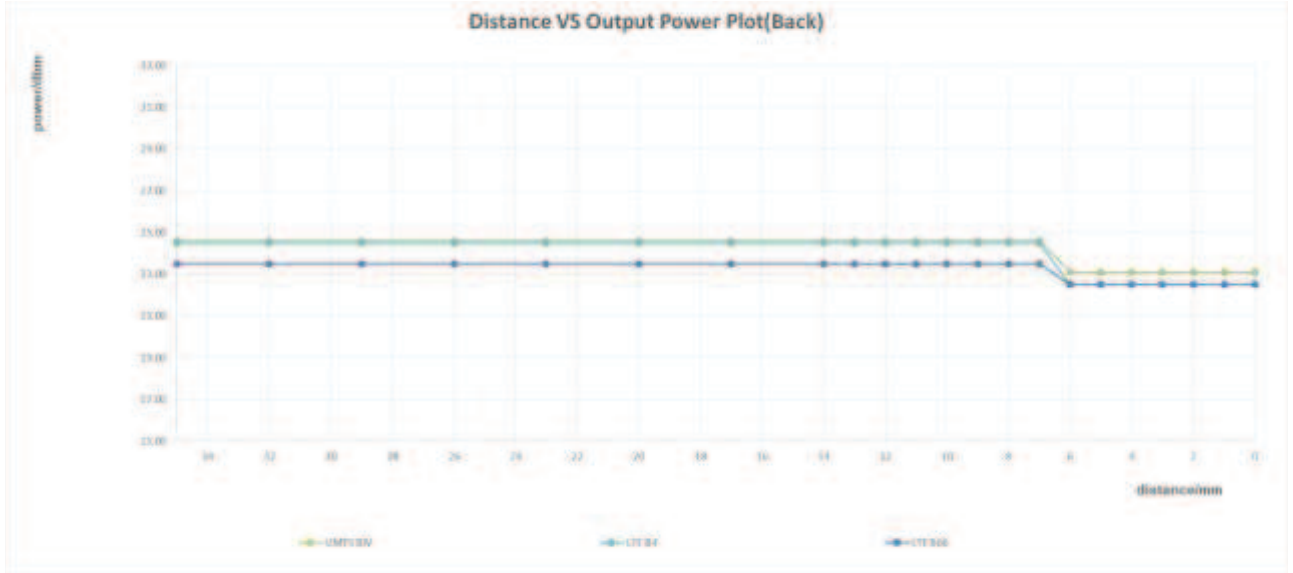

The DUT(Bottom side) is moved towards the flat phantom with/without protective cover(WiFi Station on):

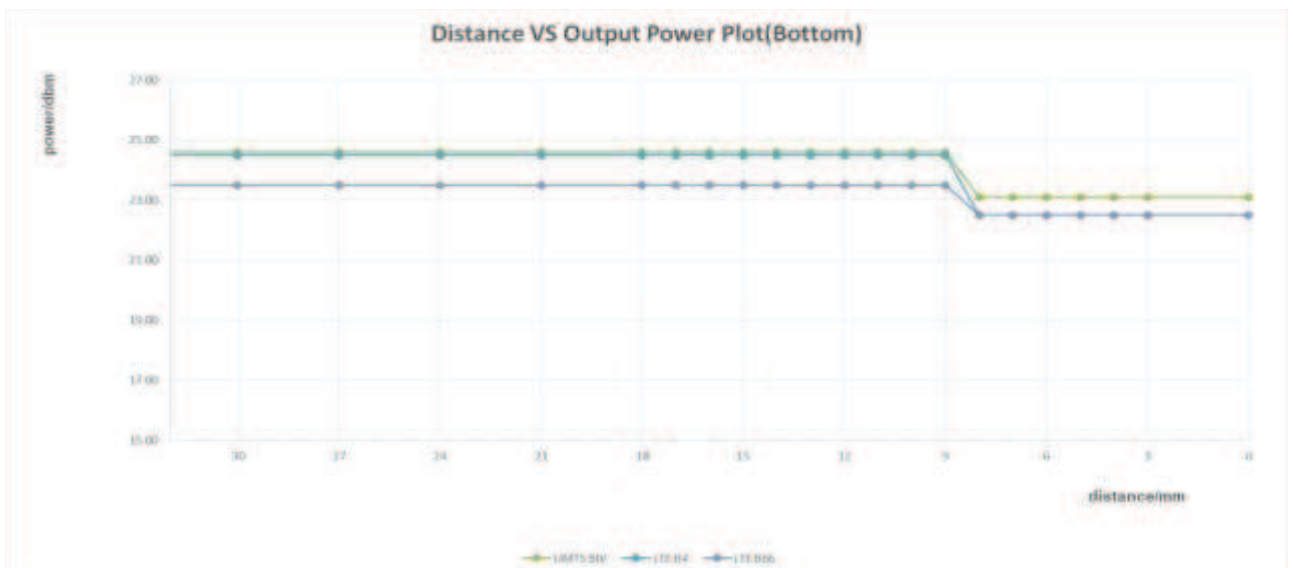

The DUT(Front side) is moved away from the flat phantom with/without protective cover(WiFi Station on):

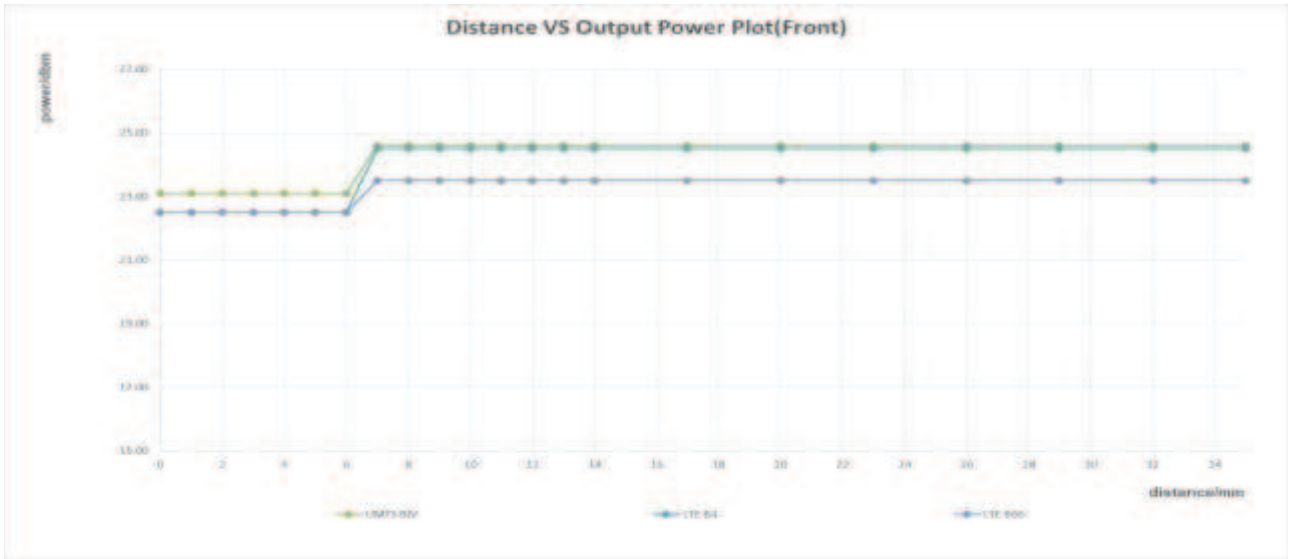

The DUT(Back side) is moved away from the flat phantom with/without protective cover(WiFi Station on):

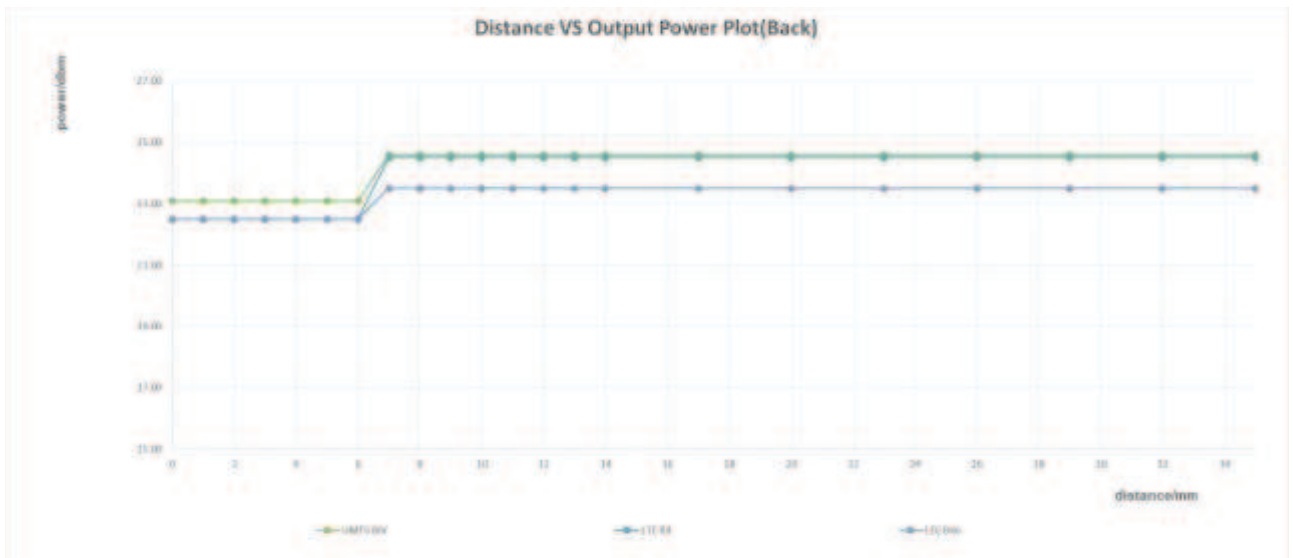

The DUT(Bottom side) is moved away from the flat phantom with/without protective cover(WiFi Station on):

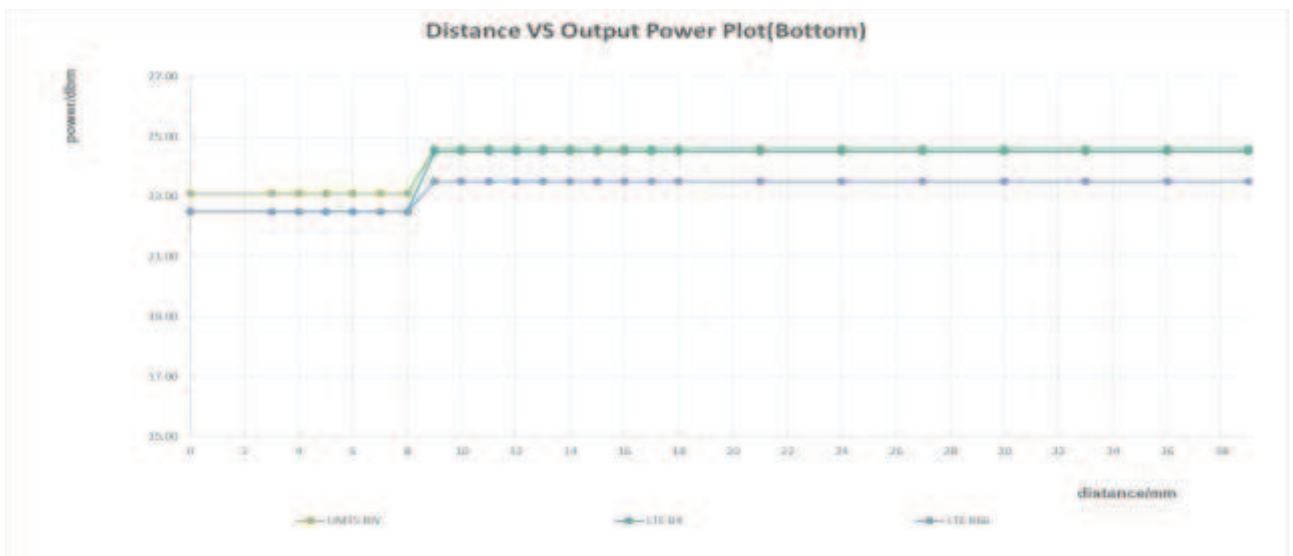

Conclusion: It can be ensured that the proximity sensor can be valid triggered for the body exposure condition in all required frequency bands (UMTS Band II/IV, LTE Band 2/4/7/38/66, UL CA_7C, UL CA_38C with Main Antenna).

2) Procedures for determining antenna and proximity sensor coverage

According to the antenna and sensors location figure: Proximity sensor pad does not fully cover the 2G/3G/4G main antenna. So the proximity sensor coverage need to be assessed for the frequency bands and test positions supporting proximity sensor power reduction per KDB 616217:

- a) All the sides/edges (bottom side, front side and back side of the device) is positioned at a test separation distance less than or equal to the distance required for sensor triggering, with both the antenna and sensor pad located at least 20 mm laterally outside the edge (boundary) of the phantom, along the direction of maximum antenna and sensor offset. Each applicable edge should be positioned perpendicularly to the phantom to determine sensor coverage. For antennas and/or sensors located near the corner of a tablet, both adjacent edges must be considered.
- b) The similar sequence of steps applied to determine sensor triggering distance are used to verify the sensor coverage by moving the DUT(sensor and antenna) horizontally toward the phantom while maintaining the same vertical separation between the side or edge and the phantom.
- c) After the exact location where triggering of power reduction is determined, with respect to the sensor and antenna, the DUT movement should be continued, in 3 mm increments, until both the sensor and antenna(s) are fully under the phantom and at least 20 mm inside the phantom edge.
- d) The process is then repeated from the opposite direction, starting at the other end of the maximum antenna and sensor offset, by rotating the DUT 180° along the vertical axis.
- e) The triggering points should be documented graphically, with the antenna and sensor clearly identified, along with all relevant dimensions.
- f) If the subsequently measured peak SAR location for the antenna is not between the triggering points, established by the sensor coverage tests from opposite ends of the antenna and sensor, additional SAR tests may be required for conditions where only part of the surface or edge of the DUT corresponding to the antenna is in proximity to the user and the sensor may not be triggering as desired. The proximity sensor coverage measurement method are as below:

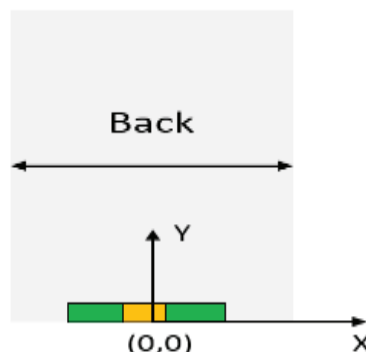

Figure: Plane coordinate system definition on the DUT

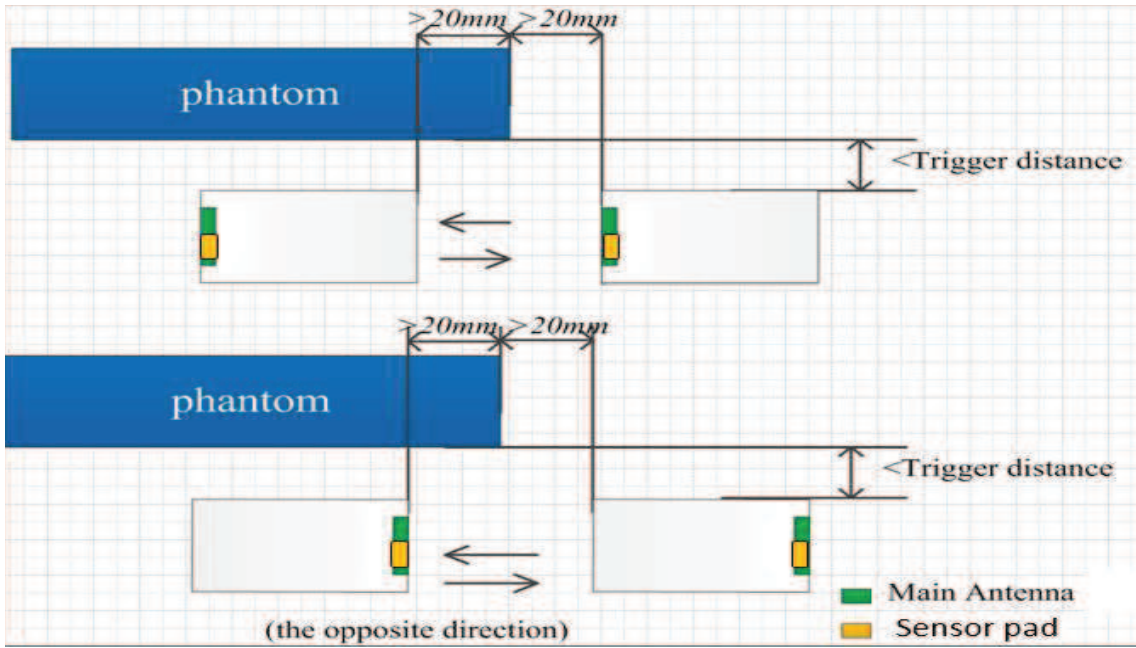

Figure: proximity sensor coverage assesment (Y coordinate direction)

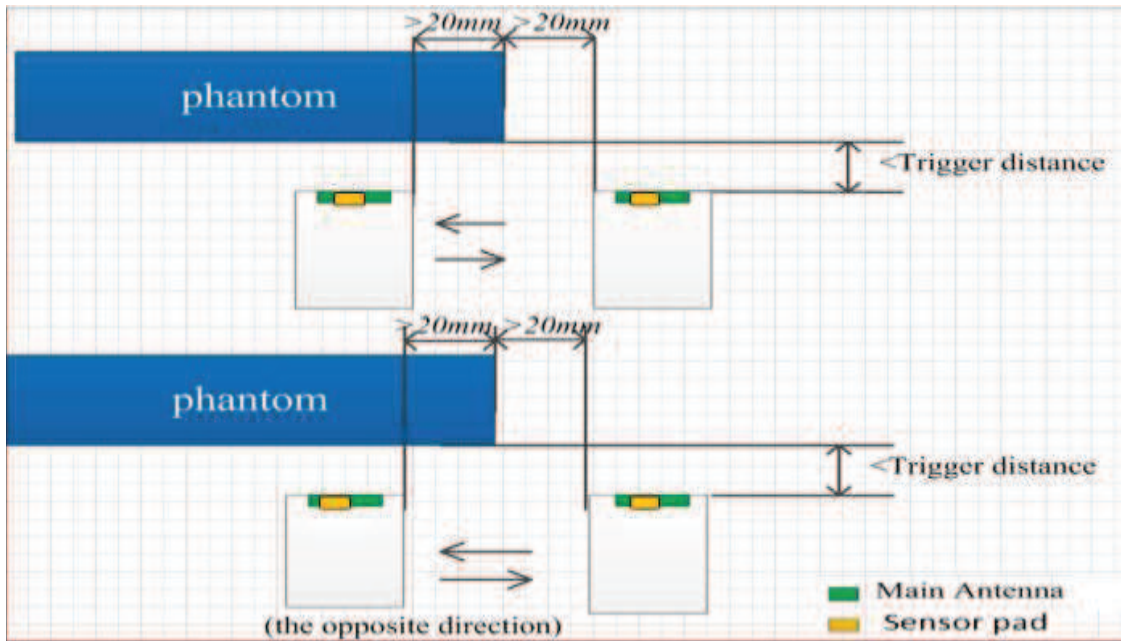
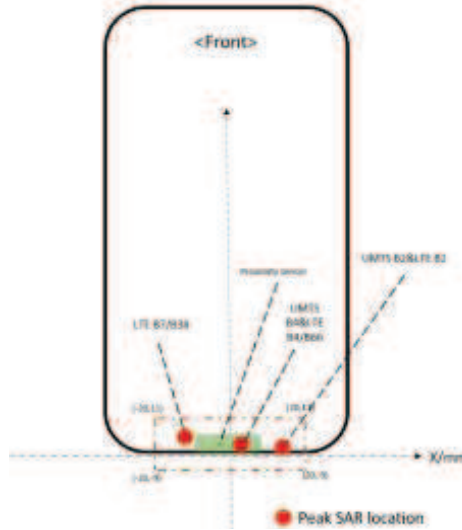
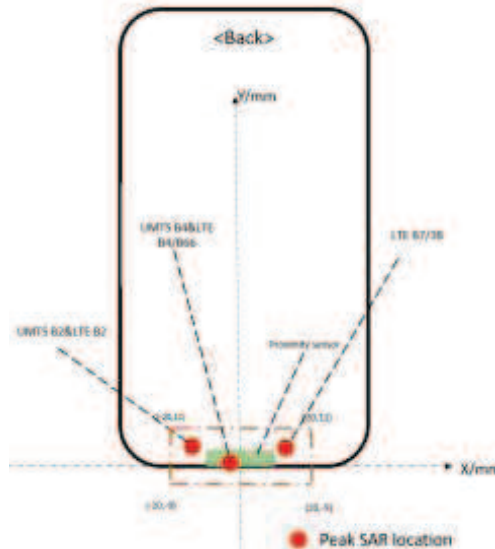

Figure: proximity sensor coverage assesment (X coordinate direction)

sensor coverage assesment results(Front side):



sensor coverage assesment results(Back side):



sensor coverage assesment results(Bottom side):

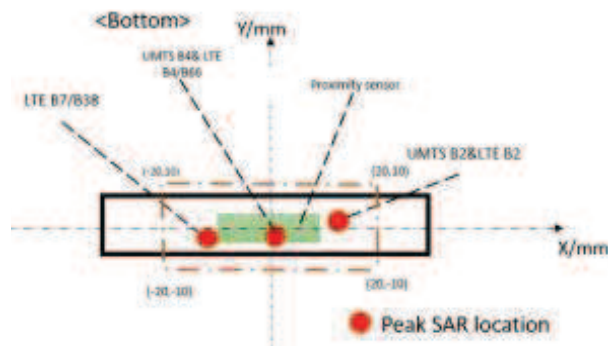

Conclusion: As the subsequently measured peak SAR location for the antenna is between the triggering points, additional SAR tests are not required for proximity sensor coverage per KDB 616217.

3) Procedures for determining device tilt angle influences to proximity sensor triggering

The DUT was positioned directly below the flat phantom with/without protective cover at the minimum measured trigger distance with Bottom side parallel to the base of the flat phantom with/without protective cover for each band.

The DUT was rotated about Bottom side for angles up to +/- 45°. If the output power increased during the rotation the DUT was moved 1mm toward the phantom and the rotation repeated. This procedure was repeated until the power remained reduced for all angles up to +/- 45°.

The proximity sensor triggering tilt angle measurement method are as below:

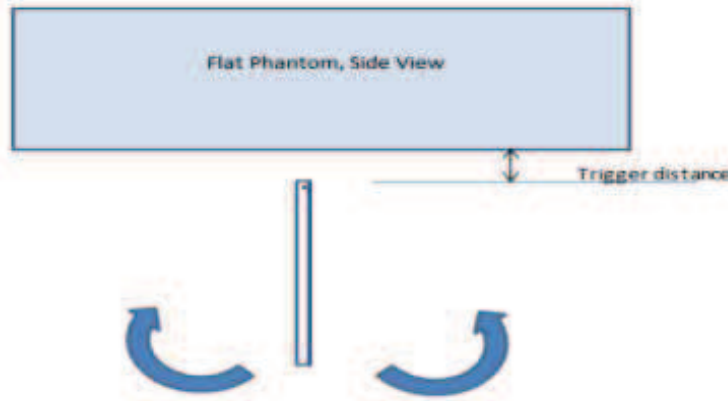

Table: Summary of Device Tilt Angle Influence to Proximity Sensor Triggering(Bottom side)

Band(MHz)	Minimum trigger distance at which power reduction was maintained over $\pm 45^\circ$	Power Reduction Status										
		-45°	-35°	-25°	-15°	-5°	0°	5°	15°	25°	35°	45°
UMTS Band II	8mm	on	on	on	on	on	on	on	on	on	on	on
UMTS Band IV	8mm	on	on	on	on	on	on	on	on	on	on	on
LTE Band 2	8mm	on	on	on	on	on	on	on	on	on	on	on
LTE Band 4	8mm	on	on	on	on	on	on	on	on	on	on	on
LTE Band 7	8mm/13mm	on	on	on	on	on	on	on	on	on	on	on
UL CA_7C	8mm/13mm	on	on	on	on	on	on	on	on	on	on	on
LTE Band 38	8mm/13mm	on	on	on	on	on	on	on	on	on	on	on
UL CA_38C	8mm/13mm	on	on	on	on	on	on	on	on	on	on	on
LTE Band 66	8mm	on	on	on	on	on	on	on	on	on	on	on

Conclusion: It can be ensured that the proximity sensor can be valid triggered for the DUT tilt coverage exposure condition.

6.10 BT Test Configuration

BT specific wireless modes and SAR test:

The device is a mobile phone. It supports a BT high power feature in specific wireless modes and operating configurations. The maximum power of BT is different on different scenarios.

The BT of this device has two different operating modes:

- 1) Low power level mode (power level B, maximum duty cycle 100%) as default mode;
- 2) High power level mode (power level A, maximum duty cycle 100%) in specific wireless modes and operating configurations when the mobile phone is connected to an external audio device;

Note: For this device, power level B is \leq power level A.

Based on the BT high power mode detection technique description above, the different exposure conditions related to BT high power mode(Power level A) are listed as below table:

Operating modes	Max power level	Maximum duty cycle	Exposure condition Required for SAR testing	
			Head (Audio Receiver on)	Body-worn/Hotspot/Product Specific 10-g
Low power level mode	power level B	100%	Yes (See Below Note 1)	Yes (See Below Note 1)
High power level mode	power level A	100%	N/A (See Below Note 2)	Yes

Note 1: The BT SAR results at low power level B is still required because the simultaneous transmission possibilities for BT at lower power level B and high power level A are different. The BT SAR results at low power level B should be used to evaluation the simultaneous transmission SAR conditions not supported by BT higher power level A(Refer to Section 7 for details).

Note 2: High power level mode (power level A, maximum duty cycle 100%) is not applicable for Head exposure condition(Audio Receiver on) by design.

Note 3: Both the power level A and B results will be tested and provided in the SAR report to validate the power reduction function works.

During the BT test, a test software tool (an APK) installed on the DUT is required to configure the DUT to transmit continuously at the maximum power level A using the highest transmission duty factor(100%). The APK function is only used to trigger mobile phone always transmitting power. It can be ensured that the unmodified settings in production units, including maximum output power, amplifier gain and other RF performance or tuning parameters, are used for SAR measurement.

7 SAR Measurement Results

7.1 Conducted power measurements

For the measurements a Rohde & Schwarz Radio Communication Tester was used.

SAR drift measured at the same position in liquid before and after each SAR test as below 7.2 chapter.

Note: The Radio Communication Tester measures GSM peak and average output power for active timeslots. For SAR the timebased average power is relevant. The difference in between depends on the duty cycle of the TDMA signal:

No. of timeslots	1	2	3	4
Duty Cycle	1:8.3	1:4.1	1:2.77	1:2.08
timebased avg. power compared to slotted avg. power	-9.19dB	-6.13dB	-4.42dB	-3.18dB

The signalling modes differ as follows:

mode	coding scheme	modulation
GPRS	CS1 to CS4	GMSK
EDGE	MCS1 to MCS4	GMSK
EDGE	MCS5 to MCS9	8PSK

Apart from modulation change (GMSK/8PSK) coding schemes differ in code rate without influence on the RF signal. Therefore, one coding scheme per mode was selected for conducted power measurements.

The Radio Communication Tester was used for LTE output power measurements and SAR testing. Closed loop power control was used so the UE transmits with maximum output power during SAR testing.

The Radio Communication Tester measures LTE TDD peak and average output power for active timeslots. LTE TDD peak and average output power for active timeslots. For SAR the time-based average power is relevant. The difference in between depends on the duty cycle of the TDMA signal:

For Time-Division Duplex (TDD) systems, SAR must be tested using a fixed periodic duty factor according to the highest transmission duty factor implemented for the device and supported by the defined 3GPP LTE TDD configurations.

No. of Configuration	0	1	2	3	4	5	6
Duty Cycle	0.6333	0.4333	0.2333	0.3167	0.2167	0.1167	0.5333
Time-based avg. power compared to slotted avg. power	-1.98dB	-3.63dB	-6.32dB	-4.99dB	-6.64dB	-9.33 dB	-2.73dB

Note: According to duty cycle of configuration 0 to 6, Max output power should be Configuration 0, so we just tested the conduction power and SAR of configuration 0.

7.1.1 Conducted power measurements of GSM850(Second antenna)

GSM850		Burst-Averaged output Power (dBm)				Division Factors	Frame-Averaged output Power (dBm)			
		Tune-up Max.	128CH	190CH	251CH		Tune-up Max.	128CH	190CH	251CH
GSM (CS)		29.00	27.88	28.07	28.10	-9.19	19.81	18.69	18.88	18.91
GPRS (GMSK)	1 Tx Slot	29.00	27.84	28.13	28.16	-9.19	19.81	18.65	18.94	18.97
	2 Tx Slots	27.00	25.96	26.04	26.18	-6.13	20.87	19.83	19.91	20.05
	3 Tx Slots	25.00	24.10	24.24	24.38	-4.42	20.58	19.68	19.82	19.96
	4 Tx Slots	23.00	22.04	22.18	22.33	-3.18	19.82	18.86	19.00	19.15
EDGE (GMSK)	1 Tx Slot	29.00	28.12	28.22	28.35	-9.19	19.81	18.93	19.03	19.16
	2 Tx Slots	27.00	26.12	26.20	26.34	-6.13	20.87	19.99	20.07	20.21
	3 Tx Slots	25.00	24.10	24.24	24.38	-4.42	20.58	19.68	19.82	19.96
	4 Tx Slots	23.00	22.03	22.17	22.33	-3.18	19.82	18.85	18.99	19.15
EDGE (8PSK)	1 Tx Slot	23.00	21.36	21.66	21.71	-9.19	13.81	12.17	12.47	12.52
	2 Tx Slots	20.50	19.18	19.58	19.63	-6.13	14.37	13.05	13.45	13.50
	3 Tx Slots	18.50	17.07	17.45	17.49	-4.42	14.08	12.65	13.03	13.07
	4 Tx Slots	16.50	14.96	15.07	15.13	-3.18	13.32	11.78	11.89	11.95

Table 15: Conducted power measurement results of GSM850 (Reduced Power Level D1/D3)

GSM850		Burst-Averaged output Power (dBm)				Division Factors	Frame-Averaged output Power (dBm)			
		Tune-up Max.	128CH	190CH	251CH		Tune-up Max.	128CH	190CH	251CH
GSM (CS)		34.00	33.37	33.40	33.45	-9.19	24.81	24.18	24.21	24.26
GPRS (GMSK)	1 Tx Slot	34.00	33.38	33.40	33.47	-9.19	24.81	24.19	24.21	24.28
	2 Tx Slots	32.00	30.82	31.10	30.99	-6.13	25.87	24.69	24.97	24.86
	3 Tx Slots	30.00	28.89	28.95	29.07	-4.42	25.58	24.47	24.53	24.65
	4 Tx Slots	28.00	26.85	26.94	27.07	-3.18	24.82	23.67	23.76	23.89
EDGE (GMSK)	1 Tx Slot	34.00	33.36	33.38	33.47	-9.19	24.81	24.17	24.19	24.28
	2 Tx Slots	32.00	31.02	31.05	31.16	-6.13	25.87	24.89	24.92	25.03
	3 Tx Slots	30.00	28.89	28.95	29.06	-4.42	25.58	24.47	24.53	24.64
	4 Tx Slots	28.00	26.85	26.94	27.07	-3.18	24.82	23.67	23.76	23.89
EDGE (8PSK)	1 Tx Slot	28.00	26.38	26.48	26.56	-9.19	18.81	17.19	17.29	17.37
	2 Tx Slots	25.50	23.68	24.00	24.05	-6.13	19.37	17.55	17.87	17.92
	3 Tx Slots	23.50	21.74	21.51	21.60	-4.42	19.08	17.32	17.09	17.18
	4 Tx Slots	21.50	21.18	20.03	21.23	-3.18	18.32	18.00	16.85	18.05

Table 16: Conducted power measurement results of GSM850 (Full Power)

Note:

- 1) Frame-averaged output power was calculated from the measured burst-averaged output power by converting the slot powers into linear units and calculating the energy over 8 timeslots.
- 2) Per KDB941225 D01, SAR test reduction for GPRS and EDGE modes is determined by the source-based time-averaged output power specified for production units, including tune-up tolerance. The data mode with highest specified time-averaged output power should be tested for SAR compliance in the applicable exposure conditions. For modes with the same specified maximum output power and tolerance, the higher number time-slot configuration should be tested.

7.1.2 Conducted power measurements of GSM850(Main antenna)

GSM850		Burst-Averaged output Power (dBm)				Division Factors	Frame-Averaged output Power (dBm)			
		Tune-up Max.	128CH	190CH	251CH		Tune-up Max.	128CH	190CH	251CH
GSM (CS)		34.00	33.48	33.43	33.41	-9.19	24.81	24.29	24.24	24.22
GPRS (GMSK)	1 Tx Slot	34.00	33.46	33.46	33.54	-9.19	24.81	24.27	24.27	24.35
	2 Tx Slots	32.00	31.16	31.17	31.28	-6.13	25.87	25.03	25.04	25.15
	3 Tx Slots	30.00	28.97	28.98	29.09	-4.42	25.58	24.55	24.56	24.67
	4 Tx Slots	28.00	26.94	26.97	27.09	-3.18	24.82	23.76	23.79	23.91
EDGE (GMSK)	1 Tx Slot	34.00	33.45	33.44	33.53	-9.19	24.81	24.26	24.25	24.34
	2 Tx Slots	32.00	31.09	31.08	31.19	-6.13	25.87	24.96	24.95	25.06
	3 Tx Slots	30.00	28.97	28.97	29.08	-4.42	25.58	24.55	24.55	24.66
	4 Tx Slots	28.00	26.93	26.96	27.08	-3.18	24.82	23.75	23.78	23.90
EDGE (8PSK)	1 Tx Slot	28.00	26.47	26.57	26.65	-9.19	18.81	17.28	17.38	17.46
	2 Tx Slots	25.50	23.72	24.11	24.20	-6.13	19.37	17.59	17.98	18.07
	3 Tx Slots	23.50	21.79	22.11	22.18	-4.42	19.08	17.37	17.69	17.76
	4 Tx Slots	21.50	19.68	19.99	20.07	-3.18	18.32	16.50	16.81	16.89

Table 17: Conducted power measurement results of GSM850

Note:

- 1) Frame-averaged output power was calculated from the measured burst-averaged output power by converting the slot powers into linear units and calculating the energy over 8 timeslots.
- 2) Per KDB941225 D01, SAR test reduction for GPRS and EDGE modes is determined by the source-based time-averaged output power specified for production units, including tune-up tolerance. The data mode with highest specified time-averaged output power should be tested for SAR compliance in the applicable exposure conditions. For modes with the same specified maximum output power and tolerance, the higher number time-slot configuration should be tested.

7.1.3 Conducted power measurements of GSM1900(Second antenna)

GSM1900		Burst-Averaged output Power (dBm)				Division Factors	Frame-Averaged output Power (dBm)			
		Tune-up Max.	512CH	661CH	810CH		Tune-up Max.	512CH	661CH	810CH
GSM (CS)		28.00	26.77	27.10	27.32	-9.19	18.81	17.58	17.91	18.13
GPRS (GMSK)	1 Tx Slot	28.00	26.93	27.26	27.51	-9.19	18.81	17.74	18.07	18.32
	2 Tx Slots	26.00	24.75	25.09	25.39	-6.13	19.87	18.62	18.96	19.26
	3 Tx Slots	24.00	22.75	23.11	23.40	-4.42	19.58	18.33	18.69	18.98
	4 Tx Slots	22.00	20.78	21.16	21.41	-3.18	18.82	17.60	17.98	18.23
EDGE (GMSK)	1 Tx Slot	28.00	27.02	27.25	27.50	-9.19	18.81	17.83	18.06	18.31
	2 Tx Slots	26.00	24.70	25.18	25.36	-6.13	19.87	18.57	19.05	19.23
	3 Tx Slots	24.00	22.73	23.10	23.40	-4.42	19.58	18.31	18.68	18.98
	4 Tx Slots	22.00	20.78	21.16	21.41	-3.18	18.82	17.60	17.98	18.23
EDGE (8PSK)	1 Tx Slot	24.00	23.65	23.92	22.71	-9.19	14.81	14.46	14.73	13.52
	2 Tx Slots	21.50	20.18	20.56	20.49	-6.13	15.37	14.05	14.43	14.36
	3 Tx Slots	19.50	19.36	19.16	18.42	-4.42	15.08	14.94	14.74	14.00
	4 Tx Slots	17.50	16.85	16.25	16.95	-3.18	14.32	13.67	13.07	13.77

Table 18: Conducted power measurement results of GSM1900 (Reduced Power Level D1)

GSM1900		Burst-Averaged output Power (dBm)				Division Factors	Frame-Averaged output Power (dBm)			
		Tune-up Max.	512CH	661CH	810CH		Tune-up Max.	512CH	661CH	810CH
GSM (CS)		30.00	29.14	29.48	29.57	-9.19	20.81	19.95	20.29	20.38
GPRS (GMSK)	1 Tx Slot	30.00	29.17	29.72	29.83	-9.19	20.81	19.98	20.53	20.64
	2 Tx Slots	28.00	26.95	27.17	27.51	-6.13	21.87	20.82	21.04	21.38
	3 Tx Slots	26.00	24.81	25.17	25.43	-4.42	21.58	20.39	20.75	21.01
	4 Tx Slots	24.00	22.82	23.19	23.48	-3.18	20.82	19.64	20.01	20.30
EDGE (GMSK)	1 Tx Slot	30.00	29.32	29.71	29.82	-9.19	20.81	20.13	20.52	20.63
	2 Tx Slots	28.00	27.01	27.34	27.58	-6.13	21.87	20.88	21.21	21.45
	3 Tx Slots	26.00	24.88	25.24	25.43	-4.42	21.58	20.46	20.82	21.01
	4 Tx Slots	24.00	22.82	23.19	23.48	-3.18	20.82	19.64	20.01	20.30
EDGE (8PSK)	1 Tx Slot	26.00	24.47	24.83	24.99	-9.19	16.81	15.28	15.64	15.80
	2 Tx Slots	23.50	21.99	22.25	22.50	-6.13	17.37	15.86	16.12	16.37
	3 Tx Slots	21.50	20.03	20.24	20.31	-4.42	17.08	15.61	15.82	15.89
	4 Tx Slots	19.50	17.98	18.15	18.18	-3.18	16.32	14.80	14.97	15.00

Table 19: Conducted power measurement results of GSM1900 (Full Power)

GSM1900		Burst-Averaged output Power (dBm)				Division Factors	Frame-Averaged output Power (dBm)			
		Tune-up Max.	512CH	661CH	810CH		Tune-up Max.	512CH	661CH	810CH
GSM (CS)		27.00	25.79	26.13	26.41	-9.19	17.81	16.60	16.94	17.22
GPRS (GMSK)	1 Tx Slot	27.00	25.83	26.18	26.35	-9.19	17.81	16.64	16.99	17.16
	2 Tx Slots	25.00	23.63	23.99	24.32	-6.13	18.87	17.50	17.86	18.19
	3 Tx Slots	23.00	21.67	22.04	22.35	-4.42	18.58	17.25	17.62	17.93
	4 Tx Slots	21.00	19.55	20.06	20.27	-3.18	17.82	16.37	16.88	17.09
EDGE (GMSK)	1 Tx Slot	27.00	25.82	26.17	26.45	-9.19	17.81	16.63	16.98	17.26
	2 Tx Slots	25.00	23.52	23.98	24.25	-6.13	18.87	17.39	17.85	18.12
	3 Tx Slots	23.00	21.66	22.03	22.34	-4.42	18.58	17.24	17.61	17.92
	4 Tx Slots	21.00	19.55	20.05	20.38	-3.18	17.82	16.37	16.87	17.20
EDGE (8PSK)	1 Tx Slot	23.00	21.23	21.50	21.55	-9.19	13.81	12.04	12.31	12.36
	2 Tx Slots	20.50	19.20	19.49	19.56	-6.13	14.37	13.07	13.36	13.43
	3 Tx Slots	18.50	17.23	17.37	17.42	-4.42	14.08	12.81	12.95	13.00
	4 Tx Slots	16.50	15.08	15.17	15.28	-3.18	13.32	11.90	11.99	12.10

Table 20: Conducted power measurement results of GSM1900 (Reduced Power Level D3)

GSM1900		Burst-Averaged output Power (dBm)				Division Factors	Frame-Averaged output Power (dBm)			
		Tune-up Max.	512CH	661CH	810CH		Tune-up Max.	512CH	661CH	810CH
GSM (CS)		29.00	27.83	28.35	28.50	-9.19	19.81	18.64	19.16	19.31
GPRS (GMSK)	1 Tx Slot	29.00	27.88	28.43	28.63	-9.19	19.81	18.69	19.24	19.44
	2 Tx Slots	27.00	25.88	26.21	26.45	-6.13	20.87	19.75	20.08	20.32
	3 Tx Slots	25.00	23.70	24.06	24.34	-4.42	20.58	19.28	19.64	19.92
	4 Tx Slots	23.00	21.75	22.13	22.54	-3.18	19.82	18.57	18.95	19.36
EDGE (GMSK)	1 Tx Slot	29.00	28.00	28.42	28.61	-9.19	19.81	18.81	19.23	19.42
	2 Tx Slots	27.00	25.92	26.27	26.55	-6.13	20.87	19.79	20.14	20.42
	3 Tx Slots	25.00	23.69	24.05	24.34	-4.42	20.58	19.27	19.63	19.92
	4 Tx Slots	23.00	21.75	22.13	22.43	-3.18	19.82	18.57	18.95	19.25
EDGE (8PSK)	1 Tx Slot	25.00	23.03	23.47	23.64	-9.19	15.81	13.84	14.28	14.45
	2 Tx Slots	22.50	21.09	21.31	21.42	-6.13	16.37	14.96	15.18	15.29
	3 Tx Slots	20.50	19.14	19.31	19.36	-4.42	16.08	14.72	14.89	14.94
	4 Tx Slots	18.50	17.09	17.20	17.24	-3.18	15.32	13.91	14.02	14.06

Table 21: Conducted power measurement results of GSM1900 (Reduced Power Level D2)

Note:

- 1) Frame-averaged output power was calculated from the measured burst-averaged output power by converting the slot powers into linear units and calculating the energy over 8 timeslots.
- 2) Per KDB941225 D01, SAR test reduction for GPRS and EDGE modes is determined by the source-based time-averaged output power specified for production units, including tune-up tolerance. The data mode with highest specified time-averaged output power should be tested for SAR compliance in the applicable exposure conditions. For modes with the same specified maximum output power and tolerance, the higher number time-slot configuration should be tested.

7.1.4 Conducted power measurements of GSM1900(Main antenna)

GSM1900		Burst-Averaged output Power (dBm)				Division Factors	Frame-Averaged output Power (dBm)			
		Tune-up Max.	512CH	661CH	810CH		Tune-up Max.	512CH	661CH	810CH
GSM (CS)		31.00	29.95	30.20	30.22	-9.19	21.81	20.76	21.01	21.03
GPRS (GMSK)	1 Tx Slot	31.00	30.03	30.23	30.32	-9.19	21.81	20.84	21.04	21.13
	2 Tx Slots	29.00	28.18	28.22	28.23	-6.13	22.87	22.05	22.09	22.10
	3 Tx Slots	27.00	26.01	26.10	26.12	-4.42	22.58	21.59	21.68	21.70
	4 Tx Slots	25.00	23.99	24.08	24.06	-3.18	21.82	20.81	20.90	20.88
EDGE (GMSK)	1 Tx Slot	31.00	30.15	30.30	30.36	-9.19	21.81	20.96	21.11	21.17
	2 Tx Slots	29.00	28.06	28.13	28.23	-6.13	22.87	21.93	22.00	22.10
	3 Tx Slots	27.00	26.01	26.10	26.11	-4.42	22.58	21.59	21.68	21.69
	4 Tx Slots	25.00	23.98	24.07	24.05	-3.18	21.82	20.80	20.89	20.87
EDGE (8PSK)	1 Tx Slot	27.00	25.69	25.55	25.51	-9.19	17.81	16.50	16.36	16.32
	2 Tx Slots	24.50	23.10	22.96	23.05	-6.13	18.37	16.97	16.83	16.92
	3 Tx Slots	22.50	20.98	20.93	20.88	-4.42	18.08	16.56	16.51	16.46
	4 Tx Slots	20.50	18.93	18.73	18.68	-3.18	17.32	15.75	15.55	15.50

Table 22: Conducted power measurement results of GSM1900 (Full Power)

GSM1900		Burst-Averaged output Power (dBm)				Division Factors	Frame-Averaged output Power (dBm)			
		Tune-up Max.	512CH	661CH	810CH		Tune-up Max.	512CH	661CH	810CH
GSM (CS)		30.50	29.48	29.65	29.68	-9.19	21.31	20.29	20.46	20.49
GPRS (GMSK)	1 Tx Slot	30.50	29.59	29.83	29.84	-9.19	21.31	20.40	20.64	20.65
	2 Tx Slots	28.50	27.59	27.64	27.63	-6.13	22.37	21.46	21.51	21.50
	3 Tx Slots	26.50	25.57	25.66	25.68	-4.42	22.08	21.15	21.24	21.26
	4 Tx Slots	24.50	23.58	23.67	23.66	-3.18	21.32	20.40	20.49	20.48
EDGE (GMSK)	1 Tx Slot	30.50	29.59	29.82	29.82	-9.19	21.31	20.40	20.63	20.63
	2 Tx Slots	28.50	27.63	27.71	27.70	-6.13	22.37	21.50	21.58	21.57
	3 Tx Slots	26.50	25.48	25.57	25.68	-4.42	22.08	21.06	21.15	21.26
	4 Tx Slots	24.50	23.57	23.66	23.65	-3.18	21.32	20.39	20.48	20.47
EDGE (8PSK)	1 Tx Slot	26.50	25.23	25.16	25.26	-9.19	17.31	16.04	15.97	16.07
	2 Tx Slots	24.00	22.66	22.51	22.54	-6.13	17.87	16.53	16.38	16.41
	3 Tx Slots	22.00	21.39	20.36	20.30	-4.42	17.58	16.97	15.94	15.88
	4 Tx Slots	20.00	18.43	18.45	18.41	-3.18	16.82	15.25	15.27	15.23

Table 23: Conducted power measurement results of GSM1900 (Reduced Power Level D6/D7/D8/D10)

Note:

- 1) Frame-averaged output power was calculated from the measured burst-averaged output power by converting the slot powers into linear units and calculating the energy over 8 timeslots.
- 2) Per KDB941225 D01, SAR test reduction for GPRS and EDGE modes is determined by the source-based time-averaged output power specified for production units, including tune-up tolerance. The data mode with highest specified time-averaged output power should be tested for SAR compliance in the applicable exposure conditions. For modes with the same specified maximum output power and tolerance, the higher number time-slot configuration should be tested.

7.1.5 Conducted power measurements of UMTS Band II(Second antenna)

UMTS Band II		Tune-up	Average Power (dBm)		
		Max.	9262CH	9400CH	9538CH
WCDMA	12.2kbps RMC	18.50	17.65	17.54	17.62
	12.2kbps AMR	18.50	17.64	17.56	17.66
HSDPA	Subtest 1	18.00	17.18	17.04	17.13
	Subtest 2	17.00	16.34	16.30	16.37
	Subtest 3	16.50	15.85	15.77	15.89
	Subtest 4	16.50	15.85	15.79	15.88
HSUPA	Subtest 1	18.50	16.80	17.06	17.16
	Subtest 2	18.50	16.31	15.28	15.42
	Subtest 3	18.50	15.13	15.07	15.02
	Subtest 4	18.50	14.30	14.51	14.66
	Subtest 5	18.50	17.67	17.56	17.66
DC-HSDPA	Subtest 1	18.00	17.16	17.06	17.14
	Subtest 2	17.00	16.38	16.30	16.39
	Subtest 3	16.50	15.83	15.80	15.86
	Subtest 4	16.50	15.85	15.76	15.87

Table 24: Conducted power measurement results of UMTS Band II (Reduced Power Level D1)

UMTS Band II		Tune-up	Average Power (dBm)		
		Max.	9262CH	9400CH	9538CH
WCDMA	12.2kbps RMC	23.50	22.61	22.54	22.63
	12.2kbps AMR	23.50	22.65	22.56	22.65
HSDPA	Subtest 1	23.00	22.13	22.02	22.12
	Subtest 2	22.00	21.37	21.26	21.35
	Subtest 3	21.50	20.85	20.72	20.83
	Subtest 4	21.50	20.86	20.71	20.84
HSUPA	Subtest 1	23.50	19.18	19.28	19.34
	Subtest 2	23.50	18.39	17.91	18.01
	Subtest 3	23.50	17.58	18.03	17.80
	Subtest 4	23.50	17.38	17.09	17.15
	Subtest 5	23.50	20.14	20.04	20.13
DC-HSDPA	Subtest 1	23.00	22.14	22.02	22.12
	Subtest 2	22.00	21.37	21.25	21.33
	Subtest 3	21.50	20.85	20.74	20.84
	Subtest 4	21.50	20.84	20.74	20.84

Table 25: Conducted power measurement results of UMTS Band II (Full Power)

UMTS Band II		Tune-up	Average Power (dBm)		
		Max.	9262CH	9400CH	9538CH
WCDMA	12.2kbps RMC	15.50	14.58	14.21	14.42
	12.2kbps AMR	15.50	14.66	14.57	14.69
HSDPA	Subtest 1	15.00	14.15	14.07	14.14
	Subtest 2	14.00	13.36	13.28	13.37
	Subtest 3	13.50	12.85	12.78	12.88
	Subtest 4	13.50	12.84	12.75	12.87
HSUPA	Subtest 1	15.50	14.91	13.93	13.92
	Subtest 2	15.50	14.45	13.36	13.45
	Subtest 3	15.50	15.12	13.25	13.08
	Subtest 4	15.50	13.34	11.63	11.66
	Subtest 5	15.50	14.62	14.20	14.38
DC-HSDPA	Subtest 1	15.00	14.14	14.05	14.14
	Subtest 2	14.00	13.35	13.30	13.37
	Subtest 3	13.50	12.83	12.78	12.86
	Subtest 4	13.50	12.84	12.76	12.88

Table 26: Conducted power measurement results of UMTS Band II (Reduced Power Level D3)

UMTS Band II		Tune-up	Average Power (dBm)		
		Max.	9262CH	9400CH	9538CH
WCDMA	12.2kbps RMC	20.50	19.58	19.52	19.49
	12.2kbps AMR	20.50	19.67	19.55	19.66
HSDPA	Subtest 1	20.00	19.13	19.03	19.12
	Subtest 2	19.00	18.36	18.24	18.32
	Subtest 3	18.50	17.86	17.76	17.82
	Subtest 4	18.50	17.87	17.77	17.83
HSUPA	Subtest 1	20.50	18.88	18.56	18.70
	Subtest 2	20.50	18.39	17.92	18.02
	Subtest 3	20.50	16.97	16.89	17.79
	Subtest 4	20.50	16.16	16.08	17.16
	Subtest 5	20.50	19.66	19.55	19.64
DC-HSDPA	Subtest 1	20.00	19.12	19.02	19.13
	Subtest 2	19.00	18.35	18.26	18.33
	Subtest 3	18.50	17.86	17.76	17.83
	Subtest 4	18.50	17.86	17.76	17.83

Table 27: Conducted power measurement results of UMTS Band II (Reduced Power Level D2)

Note:

- 1) The bolded 12.2kbps RMC mode was selected for SAR testing (the primary mode).
- 2) Per KDB941225 D01, When the maximum output power and tune-up tolerance specified for production units in a Second mode is $\leq \frac{1}{4}$ dB higher than the primary mode or when the highest reported SAR of the primary mode is scaled by the ratio of specified maximum output power and tune-up tolerance of Second to primary mode and the adjusted SAR is ≤ 1.2 W/kg, SAR measurement is not required for the Second mode.

7.1.6 Conducted power measurements of UMTS Band II(Main antenna)

UMTS Band II		Tune-up	Average Power (dBm)		
		Max.	9262CH	9400CH	9538CH
WCDMA	12.2kbps RMC	25.00	23.80	23.77	23.94
	12.2kbps AMR	25.00	23.74	23.74	23.89
HSDPA	Subtest 1	24.50	23.24	23.23	23.38
	Subtest 2	23.50	22.48	22.46	22.61
	Subtest 3	23.00	21.97	21.95	22.11
	Subtest 4	23.00	21.96	21.96	22.10
HSUPA	Subtest 1	25.00	20.01	19.66	19.71
	Subtest 2	25.00	18.78	19.41	19.55
	Subtest 3	25.00	18.00	17.70	17.78
	Subtest 4	25.00	17.88	16.94	17.54
	Subtest 5	25.00	20.76	20.71	20.90
DC-HSDPA	Subtest 1	24.50	23.24	23.24	23.40
	Subtest 2	23.50	22.48	22.47	22.60
	Subtest 3	23.00	21.96	21.94	22.12
	Subtest 4	23.00	21.97	21.96	22.11

Table 28: Conducted power measurement results of UMTS Band II (Full Power)

UMTS Band II		Tune-up	Average Power (dBm)		
		Max.	9262CH	9400CH	9538CH
WCDMA	12.2kbps RMC	23.50	22.26	22.27	22.42
	12.2kbps AMR	23.50	22.25	22.24	22.40
HSDPA	Subtest 1	23.00	21.73	21.72	21.90
	Subtest 2	22.00	20.96	20.95	21.10
	Subtest 3	21.50	20.45	20.44	20.58
	Subtest 4	21.50	20.46	20.44	20.60
HSUPA	Subtest 1	23.50	20.01	19.65	19.75
	Subtest 2	23.50	18.91	19.40	19.54
	Subtest 3	23.50	18.00	17.69	17.77
	Subtest 4	23.50	17.88	16.95	17.54
	Subtest 5	23.50	20.75	20.73	20.90
DC-HSDPA	Subtest 1	23.00	21.74	21.72	21.91
	Subtest 2	22.00	20.98	20.94	21.10
	Subtest 3	21.50	20.45	20.43	20.58
	Subtest 4	21.50	20.45	20.44	20.60

Table 29: Conducted power measurement results of UMTS Band II (Reduced Power Level D2/D4)

UMTS Band II		Tune-up	Average Power (dBm)		
		Max.	9262CH	9400CH	9538CH
WCDMA	12.2kbps RMC	22.00	20.77	20.72	20.89
	12.2kbps AMR	22.00	20.75	20.72	20.88
HSDPA	Subtest 1	21.50	20.24	20.23	20.40
	Subtest 2	20.50	19.47	19.44	19.59
	Subtest 3	20.00	18.96	18.92	19.07
	Subtest 4	20.00	18.95	18.93	19.10
HSUPA	Subtest 1	22.00	20.00	19.67	19.74
	Subtest 2	22.00	18.89	19.38	19.54
	Subtest 3	22.00	18.00	17.69	17.79
	Subtest 4	22.00	17.87	16.96	17.53
	Subtest 5	22.00	20.75	20.71	20.91
DC-HSDPA	Subtest 1	21.50	20.23	20.23	20.40
	Subtest 2	20.50	19.47	19.45	19.59
	Subtest 3	20.00	18.94	18.92	19.08
	Subtest 4	20.00	18.95	18.93	19.08

Table 30: Conducted power measurement results of UMTS Band II (Reduced Power Level D6/D8/D10)

UMTS Band II		Tune-up	Average Power (dBm)		
		Max.	9262CH	9400CH	9538CH
WCDMA	12.2kbps RMC	20.50	19.32	19.25	19.42
	12.2kbps AMR	20.50	19.23	19.24	19.38
HSDPA	Subtest 1	20.00	18.76	18.72	18.89
	Subtest 2	19.00	17.97	17.94	18.11
	Subtest 3	18.50	17.46	17.43	17.59
	Subtest 4	18.50	17.46	17.44	17.61
HSUPA	Subtest 1	20.50	18.13	18.44	18.51
	Subtest 2	20.50	17.37	16.95	17.07
	Subtest 3	20.50	17.12	16.66	16.76
	Subtest 4	20.50	16.47	15.91	16.13
	Subtest 5	20.50	19.24	19.24	19.38
DC-HSDPA	Subtest 1	20.00	18.77	18.73	18.89
	Subtest 2	19.00	17.98	17.96	18.09
	Subtest 3	18.50	17.45	17.42	17.61
	Subtest 4	18.50	17.46	17.43	17.60

Table 31: Conducted power measurement results of UMTS Band II (Reduced Power Level D7)

Note:

- 1) The bolded 12.2kbps RMC mode was selected for SAR testing (the primary mode).
- 2) Per KDB941225 D01, When the maximum output power and tune-up tolerance specified for production units in a Second mode is $\leq \frac{1}{4}$ dB higher than the primary mode or when the highest reported SAR of the primary mode is scaled by the ratio of specified maximum output power and tune-up tolerance of Second to primary mode and the adjusted SAR is ≤ 1.2 W/kg, SAR measurement is not required for the Second mode.

7.1.7 Conducted power measurements of UMTS Band IV(Second antenna)

UMTS Band IV		Tune-up	Average Power (dBm)		
		Max.	1312CH	1413CH	1513CH
WCDMA	12.2kbps RMC	18.50	17.38	17.38	17.32
	12.2kbps AMR	18.50	17.52	17.58	17.45
HSDPA	Subtest 1	18.00	17.03	16.99	16.95
	Subtest 2	17.00	16.24	16.24	16.13
	Subtest 3	16.50	15.71	15.69	15.63
	Subtest 4	16.50	15.70	15.71	15.63
HSUPA	Subtest 1	18.50	16.57	16.46	16.13
	Subtest 2	18.50	16.77	16.79	15.64
	Subtest 3	18.50	16.85	16.43	16.26
	Subtest 4	18.50	15.12	15.14	14.87
	Subtest 5	18.50	17.52	17.51	17.42
DC-HSDPA	Subtest 1	18.00	17.00	16.99	16.94
	Subtest 2	17.00	16.23	16.23	16.16
	Subtest 3	16.50	15.70	15.70	15.60
	Subtest 4	16.50	15.72	15.72	15.66

Table 32: Conducted power measurement results of UMTS Band IV (Reduced Power Level D1)

UMTS Band IV		Tune-up	Average Power (dBm)		
		Max.	1312CH	1413CH	1513CH
WCDMA	12.2kbps RMC	24.00	23.02	23.01	22.90
	12.2kbps AMR	24.00	23.03	23.00	22.90
HSDPA	Subtest 1	23.50	22.52	22.51	22.44
	Subtest 2	22.50	21.75	21.70	21.60
	Subtest 3	22.00	21.25	21.18	21.10
	Subtest 4	22.00	21.26	21.19	21.10
HSUPA	Subtest 1	24.00	19.46	19.21	19.23
	Subtest 2	24.00	19.09	18.62	18.50
	Subtest 3	24.00	18.80	19.46	19.33
	Subtest 4	24.00	17.12	17.80	17.94
	Subtest 5	24.00	20.04	19.98	19.91
DC-HSDPA	Subtest 1	23.50	22.52	22.52	22.41
	Subtest 2	22.50	21.74	21.70	21.58
	Subtest 3	22.00	21.24	21.18	21.09
	Subtest 4	22.00	21.25	21.19	21.10

Table 33: Conducted power measurement results of UMTS Band IV (Full Power)

UMTS Band IV		Tune-up	Average Power (dBm)		
		Max.	1312CH	1413CH	1513CH
WCDMA	12.2kbps RMC	15.50	14.52	14.53	14.46
	12.2kbps AMR	15.50	14.50	14.52	14.43
HSDPA	Subtest 1	15.00	14.00	14.00	13.99
	Subtest 2	14.00	13.20	13.18	13.13
	Subtest 3	13.50	12.63	12.68	12.65
	Subtest 4	13.50	12.69	12.69	12.65
HSUPA	Subtest 1	15.50	14.80	14.66	13.54
	Subtest 2	15.50	13.96	14.25	12.92
	Subtest 3	15.50	14.23	14.79	13.55
	Subtest 4	15.50	13.21	13.51	12.35
	Subtest 5	15.50	15.16	15.39	14.18
DC-HSDPA	Subtest 1	15.00	14.01	14.05	13.91
	Subtest 2	14.00	13.20	13.19	13.13
	Subtest 3	13.50	12.71	12.70	12.63
	Subtest 4	13.50	12.67	12.70	12.64

Table 34: Conducted power measurement results of UMTS Band IV (Reduced Power Level D3)

UMTS Band IV		Tune-up	Average Power (dBm)		
		Max.	1312CH	1413CH	1513CH
WCDMA	12.2kbps RMC	21.00	20.02	20.00	19.90
	12.2kbps AMR	21.00	20.01	20.02	19.89
HSDPA	Subtest 1	20.50	19.52	19.49	19.40
	Subtest 2	19.50	18.74	18.69	18.59
	Subtest 3	19.00	18.23	18.16	18.08
	Subtest 4	19.00	18.24	18.18	18.10
HSUPA	Subtest 1	21.00	19.46	19.21	19.24
	Subtest 2	21.00	19.10	18.63	18.50
	Subtest 3	21.00	18.82	19.47	19.33
	Subtest 4	21.00	17.14	17.79	17.95
	Subtest 5	21.00	20.04	19.98	19.91
DC-HSDPA	Subtest 1	20.50	19.51	19.49	19.40
	Subtest 2	19.50	18.74	18.70	18.61
	Subtest 3	19.00	18.23	18.17	18.08
	Subtest 4	19.00	18.24	18.20	18.10

Table 35: Conducted power measurement results of UMTS Band IV (Reduced Power Level D2)

Note:

- 1) The bolded 12.2kbps RMC mode was selected for SAR testing (the primary mode).
- 2) Per KDB941225 D01, When the maximum output power and tune-up tolerance specified for production units in a Second mode is $\leq \frac{1}{4}$ dB higher than the primary mode or when the highest reported SAR of the primary mode is scaled by the ratio of specified maximum output power and tune-up tolerance of Second to primary mode and the adjusted SAR is ≤ 1.2 W/kg, SAR measurement is not required for the Second mode.

7.1.8 Conducted power measurements of UMTS Band IV(Main antenna)

UMTS Band IV		Tune-up	Average Power (dBm)		
		Max.	1312CH	1413CH	1513CH
WCDMA	12.2kbps RMC	25.00	24.01	23.98	23.87
	12.2kbps AMR	25.00	24.01	23.99	23.85
HSDPA	Subtest 1	24.50	23.51	23.47	23.37
	Subtest 2	23.50	22.73	22.67	22.53
	Subtest 3	23.00	22.23	22.20	22.02
	Subtest 4	23.00	22.24	22.19	22.03
HSUPA	Subtest 1	25.00	20.03	20.20	19.98
	Subtest 2	25.00	20.29	20.53	19.49
	Subtest 3	25.00	20.40	20.51	19.84
	Subtest 4	25.00	18.51	18.72	18.73
	Subtest 5	25.00	20.97	20.97	20.85
DC-HSDPA	Subtest 1	24.50	23.49	23.47	23.36
	Subtest 2	23.50	22.70	22.68	22.54
	Subtest 3	23.00	22.22	22.18	22.03
	Subtest 4	23.00	22.22	22.18	22.06

Table 36: Conducted power measurement results of UMTS Band IV (Full Power)

UMTS Band IV		Tune-up	Average Power (dBm)		
		Max.	1312CH	1413CH	1513CH
WCDMA	12.2kbps RMC	23.50	22.50	22.48	22.35
	12.2kbps AMR	23.50	22.51	22.49	22.37
HSDPA	Subtest 1	23.00	21.99	21.99	21.84
	Subtest 2	22.00	21.19	21.16	21.02
	Subtest 3	21.50	20.72	20.66	20.50
	Subtest 4	21.50	20.71	20.66	20.52
HSUPA	Subtest 1	23.50	20.05	20.20	20.00
	Subtest 2	23.50	20.29	20.51	19.48
	Subtest 3	23.50	20.42	20.45	19.85
	Subtest 4	23.50	18.54	18.71	18.74
	Subtest 5	23.50	20.98	20.96	20.84
DC-HSDPA	Subtest 1	23.00	21.98	21.97	21.85
	Subtest 2	22.00	21.18	21.18	21.03
	Subtest 3	21.50	20.71	20.62	20.52
	Subtest 4	21.50	20.68	20.67	20.52

Table 37: Conducted power measurement results of UMTS Band IV (Reduced Power Level D4)

UMTS Band IV		Tune-up	Average Power (dBm)		
		Max.	1312CH	1413CH	1513CH
WCDMA	12.2kbps RMC	22.00	20.81	20.88	20.79
	12.2kbps AMR	22.00	20.98	20.99	20.89
HSDPA	Subtest 1	21.50	20.51	20.48	20.35
	Subtest 2	20.50	19.70	19.68	19.54
	Subtest 3	20.00	19.22	19.19	19.01
	Subtest 4	20.00	19.21	19.19	19.04
HSUPA	Subtest 1	22.00	20.03	20.19	19.99
	Subtest 2	22.00	20.29	20.51	19.51
	Subtest 3	22.00	20.31	20.40	19.84
	Subtest 4	22.00	18.52	18.73	18.76
	Subtest 5	22.00	20.98	20.96	20.84

DC-HSDPA	Subtest 1	21.50	20.48	20.47	20.34
	Subtest 2	20.50	19.69	19.68	19.51
	Subtest 3	20.00	19.19	19.16	19.00
	Subtest 4	20.00	19.19	19.19	19.04

Table 38: Conducted power measurement results of UMTS Band IV (Reduced Power Level D6/D8/D10)

UMTS Band IV		Tune-up	Average Power (dBm)		
		Max.	1312CH	1413CH	1513CH
WCDMA	12.2kbps RMC	20.50	19.28	19.39	19.30
	12.2kbps AMR	20.50	19.29	19.48	19.34
HSDPA	Subtest 1	20.00	19.01	18.96	18.84
	Subtest 2	19.00	18.19	18.19	18.11
	Subtest 3	18.50	17.71	17.71	17.54
	Subtest 4	18.50	17.72	17.69	17.55
HSUPA	Subtest 1	20.50	18.99	18.67	18.63
	Subtest 2	20.50	18.45	18.49	18.39
	Subtest 3	20.50	18.49	18.72	18.70
	Subtest 4	20.50	17.59	17.22	17.65
	Subtest 5	20.50	19.48	19.44	19.34
DC-HSDPA	Subtest 1	20.00	18.97	19.00	18.85
	Subtest 2	19.00	18.20	18.19	18.10
	Subtest 3	18.50	17.72	17.68	17.52
	Subtest 4	18.50	17.70	17.69	17.55

Table 39: Conducted power measurement results of UMTS Band IV (Reduced Power Level D7)

UMTS Band IV		Tune-up	Average Power (dBm)		
		Max.	1312CH	1413CH	1513CH
WCDMA	12.2kbps RMC	24.60	23.60	23.60	23.46
	12.2kbps AMR	24.60	23.63	23.59	23.47
HSDPA	Subtest 1	24.10	23.11	23.07	22.94
	Subtest 2	23.10	22.34	22.27	22.13
	Subtest 3	22.60	21.84	21.81	21.62
	Subtest 4	22.60	21.84	21.80	21.63
HSUPA	Subtest 1	24.60	19.94	20.23	20.00
	Subtest 2	24.60	20.30	20.52	19.50
	Subtest 3	24.60	20.33	20.43	19.85
	Subtest 4	24.60	18.50	18.72	18.75
	Subtest 5	24.60	20.96	20.95	20.83
DC-HSDPA	Subtest 1	24.10	23.11	23.06	22.93
	Subtest 2	23.10	22.33	22.28	22.15
	Subtest 3	22.60	21.83	21.78	21.64
	Subtest 4	22.60	21.82	21.78	21.66

Table 40: Conducted power measurement results of UMTS Band IV (Reduced Power Level D1/D3/D9)

UMTS Band IV		Tune-up	Average Power (dBm)		
		Max.	1312CH	1413CH	1513CH
WCDMA	12.2kbps RMC	23.10	22.12	22.10	21.96
	12.2kbps AMR	23.10	22.10	22.09	22.05
HSDPA	Subtest 1	22.60	21.59	21.57	21.45
	Subtest 2	21.60	20.80	20.77	20.64
	Subtest 3	21.10	20.30	20.29	20.13
	Subtest 4	21.10	20.30	20.29	20.15

HSUPA	Subtest 1	23.10	20.02	20.20	19.98
	Subtest 2	23.10	20.31	20.53	19.51
	Subtest 3	23.10	20.42	20.47	19.83
	Subtest 4	23.10	18.50	18.72	18.74
	Subtest 5	23.10	20.96	20.96	20.84
DC-HSDPA	Subtest 1	22.60	21.59	21.58	21.46
	Subtest 2	21.60	20.79	20.77	20.63
	Subtest 3	21.10	20.30	20.29	20.10
	Subtest 4	21.10	20.28	20.27	20.15

Table 41: Conducted power measurement results of UMTS Band IV (Reduced Power Level D2)

Note:

- 1) The bolded 12.2kbps RMC mode was selected for SAR testing (the primary mode).
- 2) Per KDB941225 D01, When the maximum output power and tune-up tolerance specified for production units in a Second mode is $\leq \frac{1}{4}$ dB higher than the primary mode or when the highest reported SAR of the primary mode is scaled by the ratio of specified maximum output power and tune-up tolerance of Second to primary mode and the adjusted SAR is ≤ 1.2 W/kg, SAR measurement is not required for the Second mode.

7.1.9 Conducted power measurements of UMTS Band V(Second antenna)

UMTS Band V		Tune-up	Average Power (dBm)		
		Max.	4132CH	4182CH	4233CH
WCDMA	12.2kbps RMC	18.50	17.61	17.65	17.56
	12.2kbps AMR	18.50	17.68	17.65	17.57
HSDPA	Subtest 1	18.00	17.30	17.36	17.36
	Subtest 2	17.00	16.84	16.87	16.85
	Subtest 3	16.50	16.39	16.48	16.45
	Subtest 4	16.50	16.42	16.48	16.45
HSUPA	Subtest 1	18.50	17.99	17.57	17.56
	Subtest 2	18.50	17.99	17.98	18.03
	Subtest 3	18.50	17.32	17.80	17.43
	Subtest 4	18.50	15.79	15.53	16.09
	Subtest 5	18.50	17.85	17.88	17.87
DC-HSDPA	Subtest 1	18.00	17.30	17.35	17.38
	Subtest 2	17.00	16.80	16.87	16.85
	Subtest 3	16.50	16.39	16.47	16.46
	Subtest 4	16.50	16.40	16.47	16.48

Table 42: Conducted power measurement results of UMTS Band V (Reduced Power Level D1/D3)

UMTS Band V		Tune-up	Average Power (dBm)		
		Max.	4132CH	4182CH	4233CH
WCDMA	12.2kbps RMC	24.50	23.60	23.54	23.37
	12.2kbps AMR	24.50	23.50	23.55	23.57
HSDPA	Subtest 1	24.00	22.99	23.04	23.06
	Subtest 2	23.00	22.47	22.54	22.56
	Subtest 3	22.50	22.12	22.17	22.15
	Subtest 4	22.50	22.10	22.17	22.14
HSUPA	Subtest 1	24.50	20.47	20.26	20.62
	Subtest 2	24.50	19.85	20.59	20.85
	Subtest 3	24.50	20.22	20.43	20.77
	Subtest 4	24.50	19.09	18.84	19.00
	Subtest 5	24.50	20.54	20.57	20.57
DC-HSDPA	Subtest 1	24.00	22.99	23.05	23.05
	Subtest 2	23.00	22.47	22.54	22.59
	Subtest 3	22.50	22.11	22.18	22.14
	Subtest 4	22.50	22.10	22.17	22.15

Table 43: Conducted power measurement results of UMTS Band V (Full Power)

Note:

- 1) The bolded 12.2kbps RMC mode was selected for SAR testing (the primary mode).
- 2) Per KDB941225 D01, When the maximum output power and tune-up tolerance specified for production units in a Second mode is $\leq \frac{1}{4}$ dB higher than the primary mode or when the highest reported SAR of the primary mode is scaled by the ratio of specified maximum output power and tune-up tolerance of Second to primary mode and the adjusted SAR is ≤ 1.2 W/kg, SAR measurement is not required for the Second mode.

7.1.10 Conducted power measurements of UMTS Band V(Main antenna)

UMTS Band V		Tune-up	Average Power (dBm)		
		Max.	4132CH	4182CH	4233CH
WCDMA	12.2kbps RMC	25.00	23.70	23.52	23.40
	12.2kbps AMR	25.00	23.79	23.79	23.83
HSDPA	Subtest 1	24.50	23.27	23.33	23.32
	Subtest 2	23.50	22.76	22.80	22.79
	Subtest 3	23.00	22.40	22.44	22.42
	Subtest 4	23.00	22.38	22.44	22.40
HSUPA	Subtest 1	25.00	20.76	20.43	20.98
	Subtest 2	25.00	20.10	20.88	21.04
	Subtest 3	25.00	20.47	21.16	20.96
	Subtest 4	25.00	19.25	19.18	19.39
	Subtest 5	25.00	20.80	20.84	20.83
DC-HSDPA	Subtest 1	24.50	23.27	23.31	23.31
	Subtest 2	23.50	22.76	22.81	22.81
	Subtest 3	23.00	22.40	22.44	22.45
	Subtest 4	23.00	22.39	22.43	22.45

Table 44: Conducted power measurement results of UMTS Band V

Note:

- 1) The bolded 12.2kbps RMC mode was selected for SAR testing (the primary mode).
- 2) Per KDB941225 D01, When the maximum output power and tune-up tolerance specified for production units in a Second mode is $\leq \frac{1}{4}$ dB higher than the primary mode or when the highest reported SAR of the primary mode is scaled by the ratio of specified maximum output power and tune-up tolerance of Second to primary mode and the adjusted SAR is ≤ 1.2 W/kg, SAR measurement is not required for the Second mode.

7.1.11 Conducted power measurements of LTE Band 2(Second antenna)

Bandwidth	Modulation	RB size	RB offset	Tune-up	Channel	Channel	Channel	
				Max.	18607CH	18900CH	19193CH	
1.4MHz	QPSK	1	0	18.00	17.09	16.81	16.88	
		1	3	18.00	17.10	16.96	16.76	
		1	5	18.00	17.04	16.82	16.81	
		3	0	18.00	16.81	16.80	16.72	
		3	2	18.00	17.12	16.91	16.70	
		3	3	18.00	16.92	16.78	16.85	
		6	0	18.00	16.99	16.88	16.78	
	16QAM	1	0	18.00	16.92	17.01	16.76	
		1	3	18.00	16.94	17.05	16.97	
		1	5	18.00	16.86	16.96	16.81	
		3	0	18.00	16.91	16.75	16.56	
		3	2	18.00	16.90	16.83	16.69	
		3	3	18.00	16.96	16.79	16.69	
		6	0	18.00	16.72	16.78	16.83	
	64QAM	1	0	18.00	16.87	16.90	17.02	
		1	3	18.00	16.85	16.88	16.86	
		1	5	18.00	17.01	16.70	17.05	
		3	0	18.00	16.83	16.75	16.82	
		3	2	18.00	16.82	16.89	16.87	
		3	3	18.00	16.98	16.94	16.92	
		6	0	18.00	16.70	16.75	16.80	
	Bandwidth	Modulation	RB size	RB offset	Tune-up	Channel	Channel	Channel
	3MHz	QPSK	1	0	18.00	17.08	16.71	16.77
			1	7	18.00	17.09	16.81	16.69
1			14	18.00	17.07	16.70	16.72	
8			0	18.00	16.99	16.73	16.70	
8			4	18.00	16.89	16.76	16.73	
8			7	18.00	16.89	16.75	16.73	
15			0	18.00	17.08	16.87	16.89	
16QAM		1	0	18.00	16.96	16.90	17.00	
		1	7	18.00	17.06	17.01	17.07	
		1	14	18.00	16.84	16.93	16.74	
		8	0	18.00	16.99	16.72	16.64	
		8	4	18.00	17.05	16.92	16.73	
		8	7	18.00	16.84	16.83	16.75	
		15	0	18.00	16.93	16.81	16.62	
64QAM		1	0	18.00	16.83	16.73	16.83	
		1	7	18.00	16.83	16.96	16.79	
		1	14	18.00	16.86	16.85	16.70	
		8	0	18.00	16.79	16.70	16.68	
		8	4	18.00	16.84	16.63	16.69	
		8	7	18.00	16.83	16.75	16.66	
		15	0	18.00	16.96	16.88	16.82	
Bandwidth		Modulation	RB size	RB offset	Tune-up	Channel	Channel	Channel
					Max.	18615CH	18900CH	19185CH

Bandwidth	Modulation	RB size	RB offset	Tune-up	Channel	Channel	Channel
				Max.	18625CH	18900CH	19175CH
5MHz	QPSK	1	0	18.00	17.04	16.72	16.71
		1	13	18.00	16.97	16.91	16.72
		1	24	18.00	16.98	16.90	16.73
		12	0	18.00	17.06	16.79	16.77
		12	6	18.00	17.05	16.74	16.77
		12	13	18.00	17.05	16.75	16.77
		25	0	18.00	16.93	16.90	16.87
	16QAM	1	0	18.00	17.31	16.95	16.93
		1	13	18.00	16.99	16.97	16.90
		1	24	18.00	16.99	16.91	17.13
		12	0	18.00	17.06	16.90	16.68
		12	6	18.00	16.74	16.84	16.80
		12	13	18.00	17.03	16.70	16.77
		25	0	18.00	16.97	16.83	16.75
	64QAM	1	0	18.00	16.74	16.66	17.12
		1	13	18.00	16.76	16.80	16.96
		1	24	18.00	16.88	16.49	16.98
		12	0	18.00	16.83	16.91	16.78
		12	6	18.00	16.91	16.91	16.65
		12	13	18.00	16.90	16.87	16.67
		25	0	18.00	16.99	16.89	16.66
Bandwidth	Modulation	RB size	RB offset	Tune-up	Channel	Channel	Channel
10MHz	QPSK	1	0	18.00	17.02	16.77	16.88
		1	25	18.00	17.17	16.72	16.87
		1	49	18.00	17.17	16.72	16.92
		25	0	18.00	17.07	16.90	16.91
		25	13	18.00	17.07	16.76	16.86
		25	25	18.00	16.87	16.88	16.92
		50	0	18.00	16.90	16.69	16.88
	16QAM	1	0	18.00	16.84	16.89	16.85
		1	25	18.00	16.87	16.73	16.82
		1	49	18.00	16.89	16.80	16.91
		25	0	18.00	17.02	16.64	16.85
		25	13	18.00	17.01	16.57	16.85
		25	25	18.00	16.97	16.57	16.84
		50	0	18.00	16.81	16.62	16.83
	64QAM	1	0	18.00	16.90	16.91	17.03
		1	25	18.00	17.08	16.70	17.03
		1	49	18.00	17.12	16.83	16.76
		25	0	18.00	16.96	16.67	16.70
		25	13	18.00	16.99	16.66	16.77
		25	25	18.00	17.00	16.65	16.74
		50	0	18.00	16.86	16.68	16.69
Bandwidth	Modulation	RB size	RB offset	Tune-up	Channel	Channel	Channel
				Max.	18650CH	18900CH	19150CH

Bandwidth	Modulation	RB size	RB offset	Tune-up	Channel	Channel	Channel
				Max.	18675CH	18900CH	19125CH
15MHz	QPSK	1	0	18.00	17.11	16.73	16.81
		1	38	18.00	17.09	16.97	16.79
		1	74	18.00	17.09	16.98	16.73
		36	0	18.00	17.07	16.75	16.77
		36	18	18.00	16.85	16.82	16.75
		36	39	18.00	16.89	16.76	16.66
		75	0	18.00	16.83	16.79	16.77
	16QAM	1	0	18.00	16.91	17.03	16.93
		1	38	18.00	16.90	16.88	16.82
		1	74	18.00	16.97	16.88	16.92
		36	0	18.00	16.79	16.72	16.67
		36	18	18.00	16.84	16.78	16.69
		36	39	18.00	16.78	16.72	16.69
		75	0	18.00	17.01	16.73	16.71
	64QAM	1	0	18.00	16.82	16.73	16.86
		1	38	18.00	16.71	16.84	16.61
		1	74	18.00	16.81	17.01	16.98
		36	0	18.00	16.74	16.68	16.76
		36	18	18.00	16.82	16.69	16.78
		36	39	18.00	16.81	16.76	16.79
		75	0	18.00	16.78	16.76	16.73
Bandwidth	Modulation	RB size	RB offset	Tune-up	Channel	Channel	Channel
20MHz	QPSK	1	0	18.00	17.22	17.09	16.88
		1	50	18.00	17.20	17.08	16.95
		1	99	18.00	17.21	16.92	16.93
		50	0	18.00	16.85	16.72	16.80
		50	25	18.00	16.84	16.71	16.97
		50	50	18.00	16.82	16.77	16.97
		100	0	18.00	16.89	16.77	16.99
	16QAM	1	0	18.00	16.97	17.17	17.22
		1	50	18.00	17.15	17.17	17.30
		1	99	18.00	17.09	17.09	17.37
		50	0	18.00	17.05	16.68	16.75
		50	25	18.00	17.07	16.67	16.78
		50	50	18.00	16.85	16.75	16.80
		100	0	18.00	16.84	16.77	16.66
	64QAM	1	0	18.00	17.10	17.16	17.31
		1	50	18.00	17.28	17.08	17.16
		1	99	18.00	17.21	17.08	17.20
		50	0	18.00	16.93	16.73	16.78
		50	25	18.00	16.93	16.72	16.81
		50	50	18.00	16.92	16.73	16.80
		100	0	18.00	16.82	16.83	16.78

Table 45: Conducted power measurement results of LTE Band 2 (Reduced Power Level D1)

Bandwidth	Modulation	RB size	RB offset	Tune-up	Channel	Channel	Channel
				Max.	18607CH	18900CH	19193CH
1.4MHz	QPSK	1	0	23.00	21.89	21.93	21.72
		1	3	23.00	21.94	21.84	21.67
		1	5	23.00	21.89	21.88	21.58
		3	0	23.00	21.97	21.70	21.85
		3	2	23.00	21.94	21.74	21.81
		3	3	23.00	22.08	21.92	21.70
		6	0	22.00	21.39	21.33	21.21
	16QAM	1	0	22.00	21.36	21.34	21.15
		1	3	22.00	21.54	21.33	21.21
		1	5	22.00	21.44	21.34	21.24
		3	0	22.00	21.43	21.35	21.33
		3	2	22.00	21.58	21.37	21.33
		3	3	22.00	21.57	21.37	21.38
		6	0	21.50	20.37	20.33	20.22
	64QAM	1	0	21.50	20.40	20.55	20.20
		1	3	21.50	20.50	20.26	20.29
		1	5	21.50	20.57	20.33	20.10
		3	0	21.50	20.45	20.29	20.16
		3	2	21.50	20.49	20.36	20.08
		3	3	21.50	20.49	20.55	20.41
		6	0	20.50	19.31	19.43	19.16
Bandwidth	Modulation	RB size	RB offset	Tune-up	Channel	Channel	Channel
3MHz	QPSK	1	0	23.00	21.80	21.80	21.86
		1	7	23.00	21.93	21.71	21.87
		1	14	23.00	21.79	21.70	21.85
		8	0	22.50	21.34	21.29	21.39
		8	4	22.50	21.26	21.35	21.38
		8	7	22.50	21.24	21.35	21.39
		15	0	22.50	21.41	21.25	21.26
	16QAM	1	0	22.50	21.34	21.45	21.33
		1	7	22.50	21.35	21.30	21.37
		1	14	22.50	21.43	21.27	21.36
		8	0	21.50	20.31	20.30	20.34
		8	4	21.50	20.31	20.20	20.08
		8	7	21.50	20.23	20.16	20.13
		15	0	21.50	20.24	20.25	20.19
	64QAM	1	0	21.50	20.54	20.38	20.35
		1	7	21.50	20.63	20.52	20.16
		1	14	21.50	20.59	20.23	20.35
		8	0	20.50	19.24	19.30	19.14
		8	4	20.50	19.24	19.26	19.17
		8	7	20.50	19.26	19.31	19.20
		15	0	20.50	19.31	19.23	19.24

Bandwidth	Modulation	RB size	RB offset	Tune-up	Channel	Channel	Channel
				Max.	18625CH	18900CH	19175CH
5MHz	QPSK	1	0	23.00	21.77	21.68	21.68
		1	13	23.00	22.09	21.62	21.60
		1	24	23.00	22.11	21.61	21.67
		12	0	22.50	21.38	21.28	21.33
		12	6	22.50	21.37	21.30	21.32
		12	13	22.50	21.37	21.28	21.28
		25	0	22.50	21.26	21.22	21.21
	16QAM	1	0	22.50	21.36	21.31	21.33
		1	13	22.50	21.64	21.25	21.29
		1	24	22.50	21.44	21.38	21.34
		12	0	21.50	20.33	20.24	20.24
		12	6	21.50	20.31	20.18	20.20
		12	13	21.50	20.35	20.26	20.21
		25	0	21.50	20.32	20.16	20.36
	64QAM	1	0	21.50	20.58	20.36	20.38
		1	13	21.50	20.43	20.33	20.23
		1	24	21.50	20.61	20.33	20.44
		12	0	20.50	19.26	19.31	19.25
		12	6	20.50	19.27	19.28	19.30
		12	13	20.50	19.27	19.27	19.31
		25	0	20.50	19.33	19.26	19.38
Bandwidth	Modulation	RB size	RB offset	Tune-up	Channel	Channel	Channel
10MHz	QPSK	1	0	23.00	22.08	21.66	21.70
		1	25	23.00	21.95	21.64	21.65
		1	49	23.00	21.94	21.71	21.70
		25	0	22.50	21.39	21.18	21.15
		25	13	22.50	21.37	21.14	21.16
		25	25	22.50	21.61	21.18	21.13
		50	0	22.50	21.29	21.25	21.16
	16QAM	1	0	22.50	21.52	21.22	21.06
		1	25	22.50	21.50	21.38	21.18
		1	49	22.50	21.45	21.39	21.32
		25	0	21.50	20.32	20.22	20.20
		25	13	21.50	20.30	20.22	20.21
		25	25	21.50	20.27	20.23	20.15
		50	0	21.50	20.22	20.25	20.17
	64QAM	1	0	21.50	20.43	20.75	20.36
		1	25	21.50	20.48	20.50	20.29
		1	49	21.50	20.41	20.51	20.33
		25	0	20.50	19.29	19.25	19.20
		25	13	20.50	19.27	19.23	19.27
		25	25	20.50	19.29	19.27	19.21
		50	0	20.50	19.28	19.34	19.26
Bandwidth	Modulation	RB size	RB offset	Tune-up	Channel	Channel	Channel
				Max.	18650CH	18900CH	19150CH

Bandwidth	Modulation	RB size	RB offset	Tune-up	Channel	Channel	Channel
				Max.	18675CH	18900CH	19125CH
15MHz	QPSK	1	0	23.00	21.79	21.73	21.81
		1	38	23.00	21.77	21.69	21.70
		1	74	23.00	21.78	21.65	21.73
		36	0	22.50	21.37	21.37	21.25
		36	18	22.50	21.63	21.37	21.23
		36	39	22.50	21.59	21.36	21.30
		75	0	22.50	21.37	21.23	21.29
	16QAM	1	0	22.50	21.50	21.33	21.43
		1	38	22.50	21.53	21.33	21.51
		1	74	22.50	21.50	21.39	21.45
		36	0	21.50	20.54	20.26	20.35
		36	18	21.50	20.53	20.44	20.35
		36	39	21.50	20.53	20.43	20.35
		75	0	21.50	20.49	20.20	20.37
	64QAM	1	0	21.50	20.54	20.41	20.49
		1	38	21.50	20.61	20.57	20.33
		1	74	21.50	20.35	20.48	20.23
		36	0	20.50	19.34	19.28	19.20
		36	18	20.50	19.54	19.29	19.22
		36	39	20.50	19.60	19.27	19.25
		75	0	20.50	19.50	19.20	19.22
Bandwidth	Modulation	RB size	RB offset	Tune-up	Channel	Channel	Channel
20MHz	QPSK	1	0	23.00	22.33	21.85	22.12
		1	50	23.00	22.32	21.91	22.17
		1	99	23.00	22.27	21.96	22.13
		50	0	22.50	21.55	21.35	21.22
		50	25	22.50	21.56	21.33	21.32
		50	50	22.50	21.56	21.33	21.31
		100	0	22.50	21.33	21.34	21.34
	16QAM	1	0	22.50	21.73	21.75	21.55
		1	50	22.50	21.72	21.72	21.57
		1	99	22.50	21.69	21.63	21.86
		50	0	21.50	20.39	20.39	20.13
		50	25	21.50	20.34	20.37	20.19
		50	50	21.50	20.20	20.36	20.18
		100	0	21.50	20.34	20.23	20.32
	64QAM	1	0	21.50	20.77	20.87	20.53
		1	50	21.50	20.38	20.74	20.44
		1	99	21.50	20.46	20.78	20.44
		50	0	20.50	19.32	19.43	19.17
		50	25	20.50	19.33	19.41	19.30
		50	50	20.50	19.36	19.43	19.27
		100	0	20.50	19.32	19.24	19.24
Bandwidth	Modulation	RB size	RB offset	Tune-up	Channel	Channel	Channel
20MHz	QPSK	1	0	23.00	22.33	21.85	22.12
		1	50	23.00	22.32	21.91	22.17
		1	99	23.00	22.27	21.96	22.13
		50	0	22.50	21.55	21.35	21.22
		50	25	22.50	21.56	21.33	21.32
		50	50	22.50	21.56	21.33	21.31
		100	0	22.50	21.33	21.34	21.34
	16QAM	1	0	22.50	21.73	21.75	21.55
		1	50	22.50	21.72	21.72	21.57
		1	99	22.50	21.69	21.63	21.86
		50	0	21.50	20.39	20.39	20.13
		50	25	21.50	20.34	20.37	20.19
		50	50	21.50	20.20	20.36	20.18
		100	0	21.50	20.34	20.23	20.32
	64QAM	1	0	21.50	20.77	20.87	20.53
		1	50	21.50	20.38	20.74	20.44
		1	99	21.50	20.46	20.78	20.44
		50	0	20.50	19.32	19.43	19.17
		50	25	20.50	19.33	19.41	19.30
		50	50	20.50	19.36	19.43	19.27
		100	0	20.50	19.32	19.24	19.24

Table 46: Conducted power measurement results of LTE Band 2 (Full Power)

Bandwidth	Modulation	RB size	RB offset	Tune-up	Channel	Channel	Channel
				Max.	18607CH	18900CH	19193CH
1.4MHz	QPSK	1	0	15.00	14.12	13.82	13.78
		1	3	15.00	14.09	13.91	13.75
		1	5	15.00	14.12	13.83	13.73
		3	0	15.00	14.10	13.89	13.78
		3	2	15.00	13.84	13.78	13.80
		3	3	15.00	14.04	13.86	13.67
		6	0	15.00	13.91	13.85	13.76
	16QAM	1	0	15.00	14.08	13.83	13.81
		1	3	15.00	14.01	13.83	13.90
		1	5	15.00	13.98	13.80	13.80
		3	0	15.00	13.87	13.67	13.88
		3	2	15.00	13.85	13.68	13.82
		3	3	15.00	13.85	13.66	13.79
		6	0	15.00	13.75	13.80	13.83
	64QAM	1	0	15.00	13.77	13.75	13.74
		1	3	15.00	14.11	13.72	13.79
		1	5	15.00	14.09	13.86	13.82
		3	0	15.00	13.84	13.99	13.93
		3	2	15.00	13.75	13.85	13.72
		3	3	15.00	13.94	13.83	13.75
		6	0	15.00	13.75	13.83	13.57
Bandwidth	Modulation	RB size	RB offset	Tune-up	Channel	Channel	Channel
3MHz	QPSK	1	0	15.00	13.98	13.71	13.75
		1	7	15.00	14.02	13.69	13.71
		1	14	15.00	13.96	13.69	13.74
		8	0	15.00	13.88	13.91	13.92
		8	4	15.00	14.01	13.73	13.96
		8	7	15.00	14.04	13.70	13.94
		15	0	15.00	14.10	13.98	13.76
	16QAM	1	0	15.00	14.07	13.81	13.94
		1	7	15.00	14.06	13.68	13.95
		1	14	15.00	14.16	13.81	13.92
		8	0	15.00	13.81	13.82	13.87
		8	4	15.00	13.85	13.73	13.84
		8	7	15.00	14.03	13.72	13.85
		15	0	15.00	14.02	13.90	13.66
	64QAM	1	0	15.00	14.07	14.04	13.79
		1	7	15.00	14.24	13.87	13.83
		1	14	15.00	14.37	13.76	13.95
		8	0	15.00	14.01	13.74	13.83
		8	4	15.00	13.98	13.70	13.92
		8	7	15.00	14.04	13.72	13.87
		15	0	15.00	13.98	13.93	13.57
Bandwidth	Modulation	RB size	RB offset	Tune-up	Channel	Channel	Channel
3MHz	QPSK	1	0	15.00	13.98	13.71	13.75
		1	7	15.00	14.02	13.69	13.71
		1	14	15.00	13.96	13.69	13.74
		8	0	15.00	13.88	13.91	13.92
		8	4	15.00	14.01	13.73	13.96
		8	7	15.00	14.04	13.70	13.94
		15	0	15.00	14.10	13.98	13.76
	16QAM	1	0	15.00	14.07	13.81	13.94
		1	7	15.00	14.06	13.68	13.95
		1	14	15.00	14.16	13.81	13.92
		8	0	15.00	13.81	13.82	13.87
		8	4	15.00	13.85	13.73	13.84
		8	7	15.00	14.03	13.72	13.85
		15	0	15.00	14.02	13.90	13.66
	64QAM	1	0	15.00	14.07	14.04	13.79
		1	7	15.00	14.24	13.87	13.83
		1	14	15.00	14.37	13.76	13.95
		8	0	15.00	14.01	13.74	13.83
		8	4	15.00	13.98	13.70	13.92
		8	7	15.00	14.04	13.72	13.87
		15	0	15.00	13.98	13.93	13.57

Bandwidth	Modulation	RB size	RB offset	Tune-up	Channel	Channel	Channel
				Max.	18625CH	18900CH	19175CH
5MHz	QPSK	1	0	15.00	14.02	13.96	13.72
		1	13	15.00	13.95	13.76	13.67
		1	24	15.00	13.96	13.76	13.76
		12	0	15.00	14.12	13.95	13.77
		12	6	15.00	14.18	13.93	13.81
		12	13	15.00	14.14	13.96	13.82
		25	0	15.00	14.06	13.77	13.90
	16QAM	1	0	15.00	14.01	13.95	13.76
		1	13	15.00	14.18	14.05	13.79
		1	24	15.00	14.22	14.12	14.13
		12	0	15.00	13.85	13.71	13.88
		12	6	15.00	14.03	13.73	13.83
		12	13	15.00	13.79	13.74	13.76
		25	0	15.00	13.81	13.94	13.60
	64QAM	1	0	15.00	13.79	13.78	13.68
		1	13	15.00	14.09	13.79	13.93
		1	24	15.00	14.17	14.13	13.88
		12	0	15.00	14.03	13.67	13.81
		12	6	15.00	14.00	13.71	13.89
		12	13	15.00	14.07	13.73	13.87
		25	0	15.00	14.03	13.96	13.90
Bandwidth	Modulation	RB size	RB offset	Tune-up	Channel	Channel	Channel
10MHz	QPSK	1	0	15.00	13.97	13.74	13.84
		1	25	15.00	14.15	13.73	13.85
		1	49	15.00	14.12	13.78	13.85
		25	0	15.00	14.16	13.88	13.79
		25	13	15.00	14.16	13.77	13.99
		25	25	15.00	14.06	13.73	13.78
		50	0	15.00	14.07	13.87	13.80
	16QAM	1	0	15.00	13.89	13.91	13.87
		1	25	15.00	13.87	13.92	13.78
		1	49	15.00	13.87	13.78	13.93
		25	0	15.00	13.84	13.67	13.84
		25	13	15.00	13.88	13.77	13.95
		25	25	15.00	14.06	13.78	13.89
		50	0	15.00	13.71	13.80	13.72
	64QAM	1	0	15.00	14.02	13.86	13.98
		1	25	15.00	13.92	13.90	13.80
		1	49	15.00	13.87	13.91	13.93
		25	0	15.00	14.03	13.72	13.90
		25	13	15.00	14.02	13.69	13.95
		25	25	15.00	14.04	13.71	13.91
		50	0	15.00	14.02	13.82	13.79
Bandwidth	Modulation	RB size	RB offset	Tune-up	Channel	Channel	Channel
				Max.	18650CH	18900CH	19150CH

Bandwidth	Modulation	RB size	RB offset	Tune-up	Channel	Channel	Channel
				Max.	18675CH	18900CH	19125CH
15MHz	QPSK	1	0	15.00	14.10	13.87	13.96
		1	38	15.00	14.07	13.88	13.74
		1	74	15.00	14.05	13.86	13.65
		36	0	15.00	14.11	13.97	13.66
		36	18	15.00	14.01	14.02	13.73
		36	39	15.00	14.01	14.01	13.80
		75	0	15.00	14.04	13.94	13.81
	16QAM	1	0	15.00	14.04	14.13	14.05
		1	38	15.00	14.15	14.00	13.67
		1	74	15.00	14.06	14.09	13.59
		36	0	15.00	13.98	13.76	13.69
		36	18	15.00	13.98	13.86	13.71
		36	39	15.00	14.02	13.88	13.71
		75	0	15.00	13.91	13.89	13.70
	64QAM	1	0	15.00	13.92	13.80	13.78
		1	38	15.00	14.05	13.96	13.69
		1	74	15.00	14.00	14.10	13.64
		36	0	15.00	13.96	13.77	13.67
		36	18	15.00	14.04	13.79	13.61
		36	39	15.00	14.02	13.75	13.61
		75	0	15.00	13.85	13.90	13.74
Bandwidth	Modulation	RB size	RB offset	Tune-up	Channel	Channel	Channel
20MHz	QPSK	1	0	15.00	14.23	14.20	13.93
		1	50	15.00	14.24	14.19	14.02
		1	99	15.00	14.23	14.05	14.00
		50	0	15.00	13.95	14.00	14.00
		50	25	15.00	13.98	14.01	14.01
		50	50	15.00	13.97	13.97	14.00
		100	0	15.00	14.10	13.84	13.78
	16QAM	1	0	15.00	14.21	14.34	14.07
		1	50	15.00	14.28	14.31	14.31
		1	99	15.00	14.35	14.28	14.08
		50	0	15.00	14.14	13.82	13.71
		50	25	15.00	14.12	13.80	13.90
		50	50	15.00	13.87	13.79	13.93
		100	0	15.00	14.03	13.86	13.69
	64QAM	1	0	15.00	14.40	14.08	14.01
		1	50	15.00	14.04	14.32	13.85
		1	99	15.00	14.02	14.05	14.02
		50	0	15.00	14.11	13.85	13.79
		50	25	15.00	14.08	13.84	13.93
		50	50	15.00	13.97	13.84	13.91
		100	0	15.00	13.99	13.88	13.88
Bandwidth	Modulation	RB size	RB offset	Tune-up	Channel	Channel	Channel
				Max.	18700CH	18900CH	19100CH

Table 47: Conducted power measurement results of LTE Band 2 (Reduced Power Level D3)

Bandwidth	Modulation	RB size	RB offset	Tune-up	Channel	Channel	Channel
				Max.	18607CH	18900CH	19193CH
1.4MHz	QPSK	1	0	20.00	18.98	19.02	18.95
		1	3	20.00	19.01	18.86	18.82
		1	5	20.00	18.89	19.00	18.80
		3	0	20.00	19.01	18.98	18.79
		3	2	20.00	18.99	18.85	18.80
		3	3	20.00	19.11	18.96	18.92
		6	0	20.00	19.02	18.88	18.88
	16QAM	1	0	20.00	18.96	18.90	18.85
		1	3	20.00	19.10	18.83	19.09
		1	5	20.00	18.93	19.03	18.92
		3	0	20.00	18.91	18.83	18.76
		3	2	20.00	19.03	18.95	18.72
		3	3	20.00	18.93	18.85	18.84
		6	0	20.00	18.86	18.82	18.68
	64QAM	1	0	20.00	18.97	18.84	18.64
		1	3	20.00	18.82	19.09	18.72
		1	5	20.00	18.95	19.01	18.84
		3	0	20.00	18.94	19.03	18.92
		3	2	20.00	18.81	18.93	18.79
		3	3	20.00	19.00	18.93	18.88
		6	0	20.00	18.74	18.95	18.76
Bandwidth	Modulation	RB size	RB offset	Tune-up	Channel	Channel	Channel
3MHz	QPSK	1	0	20.00	18.83	18.99	18.94
		1	7	20.00	18.93	18.97	18.89
		1	14	20.00	18.85	19.00	18.92
		8	0	20.00	19.07	18.93	18.71
		8	4	20.00	18.93	18.76	18.72
		8	7	20.00	18.93	18.79	18.70
		15	0	20.00	19.06	18.86	18.90
	16QAM	1	0	20.00	19.05	19.02	18.97
		1	7	20.00	18.92	18.95	18.84
		1	14	20.00	18.88	19.09	18.97
		8	0	20.00	19.07	18.89	18.89
		8	4	20.00	19.07	18.71	18.67
		8	7	20.00	18.92	18.76	18.71
		15	0	20.00	18.98	18.84	18.78
	64QAM	1	0	20.00	19.20	18.89	18.84
		1	7	20.00	19.26	18.92	18.85
		1	14	20.00	19.20	18.86	18.98
		8	0	20.00	18.87	18.78	18.67
		8	4	20.00	18.90	18.76	18.67
		8	7	20.00	18.98	18.77	18.73
		15	0	20.00	18.97	18.77	18.74
Bandwidth	Modulation	RB size	RB offset	Tune-up	Channel	Channel	Channel
3MHz	QPSK	1	0	20.00	18.83	18.99	18.94
		1	7	20.00	18.93	18.97	18.89
		1	14	20.00	18.85	19.00	18.92
		8	0	20.00	19.07	18.93	18.71
		8	4	20.00	18.93	18.76	18.72
		8	7	20.00	18.93	18.79	18.70
		15	0	20.00	19.06	18.86	18.90
	16QAM	1	0	20.00	19.05	19.02	18.97
		1	7	20.00	18.92	18.95	18.84
		1	14	20.00	18.88	19.09	18.97
		8	0	20.00	19.07	18.89	18.89
		8	4	20.00	19.07	18.71	18.67
		8	7	20.00	18.92	18.76	18.71
		15	0	20.00	18.98	18.84	18.78
	64QAM	1	0	20.00	19.20	18.89	18.84
		1	7	20.00	19.26	18.92	18.85
		1	14	20.00	19.20	18.86	18.98
		8	0	20.00	18.87	18.78	18.67
		8	4	20.00	18.90	18.76	18.67
		8	7	20.00	18.98	18.77	18.73
		15	0	20.00	18.97	18.77	18.74

Bandwidth	Modulation	RB size	RB offset	Tune-up	Channel	Channel	Channel
				Max.	18625CH	18900CH	19175CH
5MHz	QPSK	1	0	20.00	18.86	18.97	18.96
		1	13	20.00	19.10	18.87	18.90
		1	24	20.00	19.15	18.87	18.94
		12	0	20.00	19.07	18.95	18.74
		12	6	20.00	19.09	18.93	18.99
		12	13	20.00	19.09	18.92	18.93
		25	0	20.00	18.98	18.90	18.90
	16QAM	1	0	20.00	19.36	19.06	19.18
		1	13	20.00	18.82	19.02	18.98
		1	24	20.00	18.89	19.21	18.97
		12	0	20.00	19.03	18.69	18.75
		12	6	20.00	18.84	18.75	18.68
		12	13	20.00	19.06	18.87	18.68
		25	0	20.00	18.95	18.89	18.72
	64QAM	1	0	20.00	18.79	19.09	19.05
		1	13	20.00	18.88	18.84	18.74
		1	24	20.00	18.83	18.92	19.01
		12	0	20.00	18.90	18.75	18.75
		12	6	20.00	18.92	18.80	18.83
		12	13	20.00	18.91	18.74	18.88
		25	0	20.00	19.00	18.76	18.83
Bandwidth	Modulation	RB size	RB offset	Tune-up	Channel	Channel	Channel
10MHz	QPSK	1	0	20.00	19.12	18.95	18.89
		1	25	20.00	18.99	18.97	18.95
		1	49	20.00	19.06	18.98	18.94
		25	0	20.00	19.09	18.90	18.84
		25	13	20.00	19.06	18.78	18.80
		25	25	20.00	18.90	18.89	18.85
		50	0	20.00	18.96	18.91	18.74
	16QAM	1	0	20.00	19.24	19.03	19.00
		1	25	20.00	19.42	19.18	19.02
		1	49	20.00	18.86	19.05	19.07
		25	0	20.00	19.04	18.74	18.70
		25	13	20.00	19.02	18.75	18.72
		25	25	20.00	18.97	18.74	18.71
		50	0	20.00	18.75	18.65	18.72
	64QAM	1	0	20.00	19.11	19.22	18.81
		1	25	20.00	19.22	18.87	19.06
		1	49	20.00	19.41	18.92	19.08
		25	0	20.00	19.04	18.74	18.69
		25	13	20.00	19.04	18.78	18.77
		25	25	20.00	19.05	18.77	18.73
		50	0	20.00	18.85	18.89	18.77

Bandwidth	Modulation	RB size	RB offset	Tune-up	Channel	Channel	Channel
				Max.	18675CH	18900CH	19125CH
15MHz	QPSK	1	0	20.00	18.85	19.00	18.92
		1	38	20.00	18.85	18.98	18.78
		1	74	20.00	18.86	18.96	18.78
		36	0	20.00	19.10	19.00	18.78
		36	18	20.00	19.19	18.96	18.79
		36	39	20.00	19.18	18.99	18.85
		75	0	20.00	18.88	18.82	18.88
	16QAM	1	0	20.00	18.95	19.12	18.95
		1	38	20.00	18.86	19.09	19.10
		1	74	20.00	18.92	19.14	18.94
		36	0	20.00	19.05	18.86	18.85
		36	18	20.00	19.07	18.94	18.88
		36	39	20.00	19.06	18.94	18.90
		75	0	20.00	19.07	18.75	18.79
	64QAM	1	0	20.00	18.93	18.96	18.97
		1	38	20.00	18.79	19.18	18.89
		1	74	20.00	18.92	19.12	19.01
		36	0	20.00	18.78	18.84	18.69
		36	18	20.00	19.01	18.85	18.68
		36	39	20.00	18.98	18.86	18.70
		75	0	20.00	18.91	18.76	18.71
Bandwidth	Modulation	RB size	RB offset	Tune-up	Channel	Channel	Channel
20MHz	QPSK	1	0	20.00	18700CH	18900CH	19100CH
		1	50	20.00	19.01	19.14	19.10
		1	99	20.00	18.97	19.10	19.12
		50	0	20.00	18.94	19.21	19.17
		50	25	20.00	19.13	18.95	18.90
		50	50	20.00	19.17	18.94	18.87
		100	0	20.00	19.16	18.96	18.88
	16QAM	1	0	20.00	18.90	18.98	19.00
		1	50	20.00	19.05	19.24	19.22
		1	99	20.00	19.26	19.21	19.27
		50	0	20.00	19.22	19.26	19.22
		50	0	20.00	18.89	18.91	18.79
		50	25	20.00	18.89	18.88	18.89
		50	50	20.00	18.91	18.89	18.90
	64QAM	100	0	20.00	18.87	18.77	18.90
		1	0	20.00	19.11	19.03	19.01
		1	50	20.00	19.13	19.09	18.97
		1	99	20.00	19.04	19.00	19.07
		50	0	20.00	19.02	18.90	18.76
		50	25	20.00	19.03	18.88	18.91
		50	50	20.00	19.02	18.92	18.95
100	0	20.00	18.77	18.78	18.72		

Table 48: Conducted power measurement results of LTE Band 2 (Reduced Power Level D2)

7.1.12 Conducted power measurements of LTE Band 2(Main antenna)

Bandwidth	Modulation	RB size	RB offset	Tune-up	Channel	Channel	Channel	
				Max.	18607CH	18900CH	19193CH	
1.4MHz	QPSK	1	0	24.50	23.10	23.02	22.86	
		1	3	24.50	23.08	23.00	22.94	
		1	5	24.50	23.12	23.00	22.83	
		3	0	24.50	23.17	22.84	22.99	
		3	2	24.50	23.15	22.82	22.98	
		3	3	24.50	23.14	22.82	22.97	
		6	0	23.50	22.20	21.92	21.99	
	16QAM	1	0	23.50	22.04	21.98	21.90	
		1	3	23.50	22.10	22.16	21.88	
		1	5	23.50	22.35	22.04	22.08	
		3	0	23.50	22.06	21.84	22.06	
		3	2	23.50	22.26	21.87	21.80	
		3	3	23.50	22.20	21.84	22.00	
		6	0	22.50	21.07	20.91	21.01	
	64QAM	1	0	22.50	21.43	20.99	21.15	
		1	3	22.50	21.39	21.08	20.87	
		1	5	22.50	21.26	21.04	21.22	
		3	0	22.50	21.12	20.91	20.99	
		3	2	22.50	21.36	20.90	20.85	
		3	3	22.50	21.27	20.83	21.02	
		6	0	21.50	20.01	19.99	20.09	
	Bandwidth	Modulation	RB size	RB offset	Tune-up	Channel	Channel	Channel
	3MHz	QPSK	1	0	24.50	23.05	22.82	22.83
			1	7	24.50	22.98	22.79	22.80
1			14	24.50	23.11	22.82	22.71	
8			0	23.50	21.98	21.92	21.83	
8			4	23.50	21.98	21.92	21.89	
8			7	23.50	22.00	21.92	21.85	
15			0	23.50	22.30	21.95	21.92	
16QAM		1	0	23.50	22.10	22.20	22.04	
		1	7	23.50	22.11	22.09	21.79	
		1	14	23.50	22.21	22.10	21.88	
		8	0	22.50	20.98	20.95	20.80	
		8	4	22.50	21.02	20.98	20.91	
		8	7	22.50	21.01	20.93	20.85	
		15	0	22.50	20.91	20.94	20.87	
64QAM		1	0	22.50	21.20	21.06	21.08	
		1	7	22.50	21.39	20.96	20.89	
		1	14	22.50	20.91	21.15	21.01	
		8	0	21.50	20.03	20.11	19.96	
		8	4	21.50	20.05	20.00	19.97	
		8	7	21.50	19.97	20.00	19.97	
		15	0	21.50	20.07	19.92	20.11	
Bandwidth		Modulation	RB size	RB offset	Tune-up	Channel	Channel	Channel
					Max.	18615CH	18900CH	19185CH

Bandwidth	Modulation	RB size	RB offset	Tune-up	Channel	Channel	Channel
				Max.	18625CH	18900CH	19175CH
5MHz	QPSK	1	0	24.50	23.03	22.97	22.75
		1	13	24.50	23.03	22.87	22.82
		1	24	24.50	23.08	22.83	22.82
		12	0	23.50	22.10	21.90	21.84
		12	6	23.50	21.99	21.89	21.86
		12	13	23.50	22.05	21.87	21.88
		25	0	23.50	22.05	21.91	21.90
	16QAM	1	0	23.50	22.33	22.00	22.19
		1	13	23.50	22.38	22.21	21.90
		1	24	23.50	22.46	22.14	22.04
		12	0	22.50	21.10	20.87	20.84
		12	6	22.50	20.98	20.92	20.79
		12	13	22.50	21.04	20.86	20.81
		25	0	22.50	20.96	20.94	20.84
	64QAM	1	0	22.50	21.11	21.06	21.10
		1	13	22.50	21.17	21.04	21.09
		1	24	22.50	20.96	20.95	21.36
		12	0	21.50	20.03	20.03	20.11
		12	6	21.50	20.04	20.03	20.10
		12	13	21.50	20.09	19.98	20.09
		25	0	21.50	19.89	20.11	20.12
Bandwidth	Modulation	RB size	RB offset	Tune-up	Channel	Channel	Channel
10MHz	QPSK	1	0	24.50	23.07	23.03	22.82
		1	25	24.50	23.10	23.00	22.87
		1	49	24.50	23.07	23.04	22.86
		25	0	23.50	22.07	21.91	22.05
		25	13	23.50	22.13	21.91	22.07
		25	25	23.50	22.08	21.92	22.06
		50	0	23.50	22.24	22.06	21.90
	16QAM	1	0	23.50	22.13	21.94	22.03
		1	25	23.50	22.36	22.09	21.98
		1	49	23.50	22.07	21.96	22.01
		25	0	22.50	21.00	20.86	21.09
		25	13	22.50	21.03	20.90	20.89
		25	25	22.50	21.03	20.90	20.90
		50	0	22.50	21.14	20.80	20.93
	64QAM	1	0	22.50	21.38	21.12	20.95
		1	25	22.50	21.32	21.06	21.19
		1	49	22.50	21.29	21.06	21.26
		25	0	21.50	20.01	19.93	19.94
		25	13	21.50	20.02	20.02	19.96
		25	25	21.50	20.05	19.98	19.90
		50	0	21.50	20.20	20.09	19.98

Bandwidth	Modulation	RB size	RB offset	Tune-up	Channel	Channel	Channel
				Max.	18675CH	18900CH	19125CH
15MHz	QPSK	1	0	24.50	23.04	22.97	23.06
		1	38	24.50	23.12	22.84	22.85
		1	74	24.50	23.01	22.86	22.81
		36	0	23.50	22.28	22.07	22.04
		36	18	23.50	22.32	21.90	22.03
		36	39	23.50	22.32	21.89	21.88
		75	0	23.50	22.07	22.11	21.85
	16QAM	1	0	23.50	22.18	22.09	21.74
		1	38	23.50	22.23	22.22	22.16
		1	74	23.50	22.16	21.98	21.99
		36	0	22.50	21.24	20.87	20.83
		36	18	22.50	21.25	20.85	20.81
		36	39	22.50	21.25	20.87	20.79
		75	0	22.50	21.02	21.11	21.04
	64QAM	1	0	22.50	21.10	20.95	21.10
		1	38	22.50	21.45	21.08	21.42
		1	74	22.50	21.27	21.23	21.15
		36	0	21.50	20.30	20.12	19.86
		36	18	21.50	20.26	20.13	19.91
		36	39	21.50	20.32	20.12	19.85
		75	0	21.50	20.04	20.15	19.93
Bandwidth	Modulation	RB size	RB offset	Tune-up	Channel	Channel	Channel
20MHz	QPSK	1	0	24.50	23.31	23.08	23.24
		1	50	24.50	23.30	23.07	23.07
		1	99	24.50	23.33	23.07	23.12
		50	0	23.50	22.34	21.88	21.98
		50	25	23.50	22.33	22.02	21.96
		50	50	23.50	22.30	21.90	21.98
		100	0	23.50	21.94	21.91	21.99
	16QAM	1	0	23.50	22.50	22.38	22.22
		1	50	23.50	22.59	22.23	22.47
		1	99	23.50	22.71	22.46	22.14
		50	0	22.50	21.26	20.82	21.04
		50	25	22.50	21.25	20.89	21.03
		50	50	22.50	21.28	20.90	20.92
		100	0	22.50	21.08	20.89	20.79
	64QAM	1	0	22.50	21.67	21.33	21.37
		1	50	22.50	21.53	21.39	21.31
		1	99	22.50	21.47	21.33	21.39
		50	0	21.50	20.34	19.97	20.19
		50	25	21.50	20.34	19.99	20.22
		50	50	21.50	20.30	19.95	20.18
		100	0	21.50	20.12	19.98	20.05
Bandwidth	Modulation	RB size	RB offset	Tune-up	Channel	Channel	Channel
20MHz	QPSK	1	0	24.50	23.31	23.08	23.24
		1	50	24.50	23.30	23.07	23.07
		1	99	24.50	23.33	23.07	23.12
		50	0	23.50	22.34	21.88	21.98
		50	25	23.50	22.33	22.02	21.96
		50	50	23.50	22.30	21.90	21.98
		100	0	23.50	21.94	21.91	21.99
	16QAM	1	0	23.50	22.50	22.38	22.22
		1	50	23.50	22.59	22.23	22.47
		1	99	23.50	22.71	22.46	22.14
		50	0	22.50	21.26	20.82	21.04
		50	25	22.50	21.25	20.89	21.03
		50	50	22.50	21.28	20.90	20.92
		100	0	22.50	21.08	20.89	20.79
	64QAM	1	0	22.50	21.67	21.33	21.37
		1	50	22.50	21.53	21.39	21.31
		1	99	22.50	21.47	21.33	21.39
		50	0	21.50	20.34	19.97	20.19
		50	25	21.50	20.34	19.99	20.22
		50	50	21.50	20.30	19.95	20.18
		100	0	21.50	20.12	19.98	20.05

Table 49: Conducted power measurement results of LTE Band 2 (Full Power)

Bandwidth	Modulation	RB size	RB offset	Tune-up	Channel	Channel	Channel
				Max.	18607CH	18900CH	19193CH
1.4MHz	QPSK	1	0	23.50	22.28	21.92	21.91
		1	3	23.50	22.29	21.88	22.04
		1	5	23.50	22.28	21.91	21.93
		3	0	23.50	22.34	22.01	22.08
		3	2	23.50	22.32	22.01	22.07
		3	3	23.50	22.26	22.00	22.08
		6	0	23.50	22.17	21.92	21.99
	16QAM	1	0	23.50	22.12	22.03	21.63
		1	3	23.50	22.19	21.98	21.95
		1	5	23.50	22.02	21.92	22.06
		3	0	23.50	22.04	21.80	21.87
		3	2	23.50	22.19	21.88	21.86
		3	3	23.50	22.22	21.82	22.06
		6	0	22.50	21.00	20.88	20.99
	64QAM	1	0	22.50	21.19	21.06	21.06
		1	3	22.50	21.14	20.95	21.15
		1	5	22.50	21.11	21.02	20.94
		3	0	22.50	21.13	20.90	21.01
		3	2	22.50	21.27	20.88	20.99
		3	3	22.50	21.09	21.01	21.00
		6	0	21.50	20.05	19.94	20.12
Bandwidth	Modulation	RB size	RB offset	Tune-up	Channel	Channel	Channel
3MHz	QPSK	1	0	23.50	22.18	21.99	21.88
		1	7	23.50	22.23	22.00	21.86
		1	14	23.50	22.19	22.02	21.81
		8	0	23.50	21.99	21.92	21.83
		8	4	23.50	22.03	21.91	21.88
		8	7	23.50	21.97	21.93	21.84
		15	0	23.50	21.98	21.93	21.92
	16QAM	1	0	23.50	21.86	22.06	22.13
		1	7	23.50	22.16	21.99	21.72
		1	14	23.50	22.07	21.96	22.06
		8	0	22.50	20.99	20.88	20.90
		8	4	22.50	20.87	20.91	20.83
		8	7	22.50	21.07	20.89	20.85
		15	0	22.50	20.93	20.92	20.89
	64QAM	1	0	22.50	21.04	21.21	21.04
		1	7	22.50	21.23	21.01	21.10
		1	14	22.50	21.13	21.11	21.12
		8	0	21.50	20.00	20.04	19.92
		8	4	21.50	20.09	20.06	19.90
		8	7	21.50	20.03	20.06	19.94
		15	0	21.50	20.03	19.93	20.11
Bandwidth	Modulation	RB size	RB offset	Tune-up	Channel	Channel	Channel
3MHz	QPSK	1	0	23.50	22.18	21.99	21.88
		1	7	23.50	22.23	22.00	21.86
		1	14	23.50	22.19	22.02	21.81
		8	0	23.50	21.99	21.92	21.83
		8	4	23.50	22.03	21.91	21.88
		8	7	23.50	21.97	21.93	21.84
		15	0	23.50	21.98	21.93	21.92
	16QAM	1	0	23.50	21.86	22.06	22.13
		1	7	23.50	22.16	21.99	21.72
		1	14	23.50	22.07	21.96	22.06
		8	0	22.50	20.99	20.88	20.90
		8	4	22.50	20.87	20.91	20.83
		8	7	22.50	21.07	20.89	20.85
		15	0	22.50	20.93	20.92	20.89
	64QAM	1	0	22.50	21.04	21.21	21.04
		1	7	22.50	21.23	21.01	21.10
		1	14	22.50	21.13	21.11	21.12
		8	0	21.50	20.00	20.04	19.92
		8	4	21.50	20.09	20.06	19.90
		8	7	21.50	20.03	20.06	19.94
		15	0	21.50	20.03	19.93	20.11

Bandwidth	Modulation	RB size	RB offset	Tune-up	Channel	Channel	Channel
				Max.	18625CH	18900CH	19175CH
5MHz	QPSK	1	0	23.50	22.15	21.85	21.83
		1	13	23.50	22.18	21.93	21.83
		1	24	23.50	22.14	21.97	21.80
		12	0	23.50	22.08	21.88	21.84
		12	6	23.50	22.03	21.88	21.84
		12	13	23.50	22.04	21.90	21.84
		25	0	23.50	22.06	21.91	21.90
	16QAM	1	0	23.50	22.33	22.01	21.99
		1	13	23.50	22.38	22.00	22.01
		1	24	23.50	22.25	22.19	22.13
		12	0	22.50	21.09	20.87	20.80
		12	6	22.50	21.03	20.88	20.84
		12	13	22.50	21.07	20.86	20.80
		25	0	22.50	21.04	20.87	20.83
	64QAM	1	0	22.50	21.27	20.91	21.22
		1	13	22.50	21.35	21.02	21.13
		1	24	22.50	21.31	21.16	21.27
		12	0	21.50	19.97	20.01	20.15
		12	6	21.50	20.00	20.03	20.15
		12	13	21.50	20.11	20.06	20.07
		25	0	21.50	19.92	20.13	20.09
Bandwidth	Modulation	RB size	RB offset	Tune-up	Channel	Channel	Channel
10MHz	QPSK	1	0	23.50	22.31	21.92	21.88
		1	25	23.50	22.30	21.87	21.92
		1	49	23.50	22.27	21.92	21.89
		25	0	23.50	22.07	21.90	22.04
		25	13	23.50	22.14	21.93	22.06
		25	25	23.50	22.04	21.87	22.06
		50	0	23.50	22.24	22.05	21.92
	16QAM	1	0	23.50	22.19	21.94	21.89
		1	25	23.50	22.30	21.94	22.08
		1	49	23.50	22.27	21.83	21.92
		25	0	22.50	21.05	20.86	21.10
		25	13	22.50	21.00	20.94	20.89
		25	25	22.50	21.03	20.88	20.92
		50	0	22.50	21.23	20.79	20.93
	64QAM	1	0	22.50	21.29	21.10	21.31
		1	25	22.50	21.25	21.18	21.18
		1	49	22.50	21.07	20.94	21.07
		25	0	21.50	20.00	19.98	19.94
		25	13	21.50	19.98	19.99	19.97
		25	25	21.50	20.05	19.97	19.91
		50	0	21.50	20.23	20.08	19.96

Bandwidth	Modulation	RB size	RB offset	Tune-up	Channel	Channel	Channel
				Max.	18675CH	18900CH	19125CH
15MHz	QPSK	1	0	23.50	22.27	21.86	21.86
		1	38	23.50	22.29	21.97	21.92
		1	74	23.50	22.30	21.94	21.89
		36	0	23.50	22.26	22.07	22.03
		36	18	23.50	22.28	21.84	22.03
		36	39	23.50	22.32	21.85	21.85
		75	0	23.50	22.06	22.09	21.87
	16QAM	1	0	23.50	22.14	21.90	22.02
		1	38	23.50	22.14	22.06	21.95
		1	74	23.50	22.26	22.16	21.83
		36	0	22.50	21.27	20.89	20.79
		36	18	22.50	21.27	20.87	20.83
		36	39	22.50	21.27	20.86	20.87
		75	0	22.50	21.01	21.07	21.03
	64QAM	1	0	22.50	21.23	21.08	21.18
		1	38	22.50	21.15	21.07	21.22
		1	74	22.50	21.45	21.21	21.31
		36	0	21.50	20.31	20.15	19.89
		36	18	21.50	20.35	20.13	19.96
		36	39	21.50	20.32	20.09	19.84
		75	0	21.50	20.05	20.14	19.88
Bandwidth	Modulation	RB size	RB offset	Tune-up	Channel	Channel	Channel
20MHz	QPSK	1	0	23.50	22.43	22.14	22.07
		1	50	23.50	22.44	22.14	22.14
		1	99	23.50	22.44	22.12	22.22
		50	0	23.50	22.06	21.92	21.96
		50	25	23.50	22.34	22.02	21.97
		50	50	23.50	22.34	21.85	21.97
		100	0	23.50	22.12	21.89	21.99
	16QAM	1	0	23.50	22.49	22.41	22.18
		1	50	23.50	22.53	22.10	22.18
		1	99	23.50	22.41	22.46	22.31
		50	0	22.50	21.29	20.85	21.02
		50	25	22.50	21.25	20.87	21.03
		50	50	22.50	21.27	20.87	20.92
		100	0	22.50	21.08	20.88	20.78
	64QAM	1	0	22.50	21.45	21.48	21.41
		1	50	22.50	21.50	21.32	21.54
		1	99	22.50	21.38	21.49	21.53
		50	0	21.50	20.33	20.00	20.17
		50	25	21.50	20.34	19.96	20.13
		50	50	21.50	20.32	19.93	20.15
		100	0	21.50	20.12	20.00	20.06
Bandwidth	Modulation	RB size	RB offset	Tune-up	Channel	Channel	Channel
20MHz	QPSK	1	0	23.50	22.43	22.14	22.07
		1	50	23.50	22.44	22.14	22.14
		1	99	23.50	22.44	22.12	22.22
		50	0	23.50	22.06	21.92	21.96
		50	25	23.50	22.34	22.02	21.97
		50	50	23.50	22.34	21.85	21.97
		100	0	23.50	22.12	21.89	21.99
	16QAM	1	0	23.50	22.49	22.41	22.18
		1	50	23.50	22.53	22.10	22.18
		1	99	23.50	22.41	22.46	22.31
		50	0	22.50	21.29	20.85	21.02
		50	25	22.50	21.25	20.87	21.03
		50	50	22.50	21.27	20.87	20.92
		100	0	22.50	21.08	20.88	20.78
	64QAM	1	0	22.50	21.45	21.48	21.41
		1	50	22.50	21.50	21.32	21.54
		1	99	22.50	21.38	21.49	21.53
		50	0	21.50	20.33	20.00	20.17
		50	25	21.50	20.34	19.96	20.13
		50	50	21.50	20.32	19.93	20.15
		100	0	21.50	20.12	20.00	20.06

Table 50: Conducted power measurement results of LTE Band 2 (Reduced Power Level D2/D4)

Bandwidth	Modulation	RB size	RB offset	Tune-up	Channel	Channel	Channel
				Max.	18607CH	18900CH	19193CH
1.4MHz	QPSK	1	0	21.50	20.21	20.14	20.07
		1	3	21.50	20.20	20.15	19.95
		1	5	21.50	20.24	20.16	20.07
		3	0	21.50	20.28	19.97	19.97
		3	2	21.50	20.28	19.98	19.98
		3	3	21.50	20.27	19.97	19.96
		6	0	21.50	20.19	20.06	19.97
	16QAM	1	0	21.50	20.26	20.08	20.25
		1	3	21.50	20.30	20.16	20.07
		1	5	21.50	20.18	20.12	20.02
		3	0	21.50	20.28	20.03	20.01
		3	2	21.50	20.06	20.01	20.05
		3	3	21.50	20.12	20.05	20.00
		6	0	21.50	20.20	20.04	20.02
	64QAM	1	0	21.50	20.40	20.11	20.12
		1	3	21.50	20.29	20.24	19.93
		1	5	21.50	20.41	20.19	20.06
		3	0	21.50	20.36	20.17	19.96
		3	2	21.50	20.15	20.08	20.03
		3	3	21.50	20.42	20.20	20.12
		6	0	21.50	19.97	19.91	20.17
Bandwidth	Modulation	RB size	RB offset	Tune-up	Channel	Channel	Channel
3MHz	QPSK	1	0	21.50	20.15	20.03	19.95
		1	7	21.50	20.06	20.01	19.91
		1	14	21.50	20.16	20.04	19.93
		8	0	21.50	20.09	20.00	19.97
		8	4	21.50	20.11	20.00	20.09
		8	7	21.50	20.11	20.01	19.97
		15	0	21.50	20.05	20.10	20.08
	16QAM	1	0	21.50	20.29	20.12	20.05
		1	7	21.50	20.26	20.14	19.90
		1	14	21.50	20.10	20.16	20.02
		8	0	21.50	20.06	19.99	19.86
		8	4	21.50	20.10	19.96	19.95
		8	7	21.50	20.16	20.01	19.84
		15	0	21.50	20.04	20.07	19.90
	64QAM	1	0	21.50	20.36	20.44	20.01
		1	7	21.50	20.44	20.22	19.98
		1	14	21.50	20.20	20.05	20.18
		8	0	21.50	20.03	20.10	19.94
		8	4	21.50	20.06	20.05	19.97
		8	7	21.50	20.05	20.00	19.98
		15	0	21.50	20.03	20.01	20.12
Bandwidth	Modulation	RB size	RB offset	Tune-up	Channel	Channel	Channel
				Max.	18615CH	18900CH	19185CH

Bandwidth	Modulation	RB size	RB offset	Tune-up	Channel	Channel	Channel
				Max.	18625CH	18900CH	19175CH
5MHz	QPSK	1	0	21.50	20.11	20.06	19.90
		1	13	21.50	20.11	20.02	19.89
		1	24	21.50	20.10	20.02	19.89
		12	0	21.50	20.17	19.96	19.93
		12	6	21.50	20.14	19.96	19.93
		12	13	21.50	20.14	19.95	19.93
		25	0	21.50	20.12	19.98	20.10
	16QAM	1	0	21.50	20.67	20.22	19.98
		1	13	21.50	20.58	20.15	20.02
		1	24	21.50	20.63	20.22	20.16
		12	0	21.50	20.13	19.93	19.89
		12	6	21.50	20.10	19.91	19.87
		12	13	21.50	20.11	19.91	19.89
		25	0	21.50	20.09	19.96	19.90
	64QAM	1	0	21.50	20.22	19.92	20.06
		1	13	21.50	20.27	20.28	20.15
		1	24	21.50	20.43	20.09	20.31
		12	0	21.50	20.07	20.00	20.14
		12	6	21.50	20.04	19.98	20.16
		12	13	21.50	20.10	20.00	20.08
		25	0	21.50	19.91	20.11	20.17
Bandwidth	Modulation	RB size	RB offset	Tune-up	Channel	Channel	Channel
10MHz	QPSK	1	0	21.50	20.29	20.00	20.12
		1	25	21.50	20.27	20.00	20.08
		1	49	21.50	20.30	19.92	19.99
		25	0	21.50	20.14	20.07	20.10
		25	13	21.50	20.23	20.05	20.14
		25	25	21.50	20.12	19.97	20.15
		50	0	21.50	20.26	20.19	19.98
	16QAM	1	0	21.50	20.43	20.13	20.05
		1	25	21.50	20.24	20.31	19.99
		1	49	21.50	20.30	19.99	20.21
		25	0	21.50	20.07	19.97	20.08
		25	13	21.50	20.07	20.06	19.94
		25	25	21.50	20.07	20.03	19.90
		50	0	21.50	20.20	19.87	20.01
	64QAM	1	0	21.50	20.42	20.04	20.20
		1	25	21.50	20.35	20.05	20.19
		1	49	21.50	20.31	20.17	20.13
		25	0	21.50	20.04	19.95	19.95
		25	13	21.50	20.00	19.98	19.97
		25	25	21.50	20.05	19.94	19.90
		50	0	21.50	20.23	20.07	19.99
Bandwidth	Modulation	RB size	RB offset	Tune-up	Channel	Channel	Channel
				Max.	18650CH	18900CH	19150CH

Bandwidth	Modulation	RB size	RB offset	Tune-up	Channel	Channel	Channel
				Max.	18675CH	18900CH	19125CH
15MHz	QPSK	1	0	21.50	20.27	19.94	20.09
		1	38	21.50	20.25	20.08	20.01
		1	74	21.50	20.26	20.10	19.96
		36	0	21.50	20.35	20.21	20.07
		36	18	21.50	20.36	19.94	20.07
		36	39	21.50	20.34	19.98	19.91
		75	0	21.50	20.25	20.16	19.93
	16QAM	1	0	21.50	20.11	20.06	20.14
		1	38	21.50	20.34	20.15	20.23
		1	74	21.50	20.37	20.20	20.24
		36	0	21.50	20.30	19.93	19.88
		36	18	21.50	20.38	19.92	19.80
		36	39	21.50	20.29	19.92	19.85
		75	0	21.50	20.08	20.08	19.98
	64QAM	1	0	21.50	20.17	20.04	20.05
		1	38	21.50	20.46	19.95	20.22
		1	74	21.50	20.45	20.13	20.25
		36	0	21.50	20.30	20.12	19.86
		36	18	21.50	20.30	20.11	19.89
		36	39	21.50	20.30	20.12	19.85
		75	0	21.50	20.07	20.15	19.88
Bandwidth	Modulation	RB size	RB offset	Tune-up	Channel	Channel	Channel
20MHz	QPSK	1	0	21.50	20.41	20.34	20.31
		1	50	21.50	20.42	20.25	20.10
		1	99	21.50	20.41	20.35	20.19
		50	0	21.50	20.35	19.97	20.11
		50	25	21.50	20.36	20.18	20.11
		50	50	21.50	20.35	19.95	20.11
		100	0	21.50	20.25	20.00	20.09
	16QAM	1	0	21.50	20.67	20.59	20.43
		1	50	21.50	20.69	20.45	20.39
		1	99	21.50	20.67	20.36	20.49
		50	0	21.50	20.23	19.91	20.10
		50	25	21.50	20.26	19.95	20.08
		50	50	21.50	20.28	19.92	19.94
		100	0	21.50	20.17	19.97	19.82
	64QAM	1	0	21.50	20.71	20.63	20.34
		1	50	21.50	20.72	20.40	20.60
		1	99	21.50	20.74	20.40	20.58
		50	0	21.50	20.31	19.99	20.17
		50	25	21.50	20.32	19.92	20.23
		50	50	21.50	20.37	19.93	20.19
		100	0	21.50	20.13	20.01	20.05
Bandwidth	Modulation	RB size	RB offset	Tune-up	Channel	Channel	Channel
				Max.	18700CH	18900CH	19100CH

Table 51: Conducted power measurement results of LTE Band 2 (Reduced Power Level D6/D8/D10)

Bandwidth	Modulation	RB size	RB offset	Tune-up	Channel	Channel	Channel
				Max.	18607CH	18900CH	19193CH
1.4MHz	QPSK	1	0	20.50	19.21	19.13	19.07
		1	3	20.50	19.24	19.16	19.12
		1	5	20.50	19.20	19.18	19.01
		3	0	20.50	19.26	18.99	18.94
		3	2	20.50	19.26	18.99	18.93
		3	3	20.50	19.25	18.98	18.94
		6	0	20.50	19.25	19.02	18.94
	16QAM	1	0	20.50	19.23	19.07	19.16
		1	3	20.50	19.29	19.02	19.13
		1	5	20.50	19.19	19.06	18.97
		3	0	20.50	19.10	18.97	18.94
		3	2	20.50	19.07	18.96	19.09
		3	3	20.50	19.12	18.98	19.03
		6	0	20.50	19.11	19.09	18.91
	64QAM	1	0	20.50	19.43	19.27	19.33
		1	3	20.50	19.19	19.24	19.14
		1	5	20.50	19.09	19.20	19.17
		3	0	20.50	19.33	19.02	19.17
		3	2	20.50	19.12	18.97	19.06
		3	3	20.50	19.25	18.94	19.18
		6	0	20.50	19.18	19.04	18.89
Bandwidth	Modulation	RB size	RB offset	Tune-up	Channel	Channel	Channel
3MHz	QPSK	1	0	20.50	19.15	19.10	18.98
		1	7	20.50	19.24	19.05	18.87
		1	14	20.50	19.09	19.08	18.97
		8	0	20.50	19.09	18.97	18.95
		8	4	20.50	19.12	18.97	19.08
		8	7	20.50	19.07	18.97	18.92
		15	0	20.50	19.02	19.05	19.08
	16QAM	1	0	20.50	19.17	19.18	18.85
		1	7	20.50	19.17	19.25	19.02
		1	14	20.50	19.10	19.23	19.11
		8	0	20.50	19.13	19.02	18.93
		8	4	20.50	19.09	18.98	18.96
		8	7	20.50	19.08	19.00	18.93
		15	0	20.50	19.03	19.05	18.93
	64QAM	1	0	20.50	19.38	19.17	19.11
		1	7	20.50	19.42	19.25	19.23
		1	14	20.50	19.17	19.39	19.08
		8	0	20.50	19.17	19.15	19.00
		8	4	20.50	19.12	19.15	19.04
		8	7	20.50	19.11	19.14	18.94
		15	0	20.50	19.11	19.03	19.15

Bandwidth	Modulation	RB size	RB offset	Tune-up	Channel	Channel	Channel
				Max.	18625CH	18900CH	19175CH
5MHz	QPSK	1	0	20.50	19.17	19.14	18.95
		1	13	20.50	19.13	19.06	18.93
		1	24	20.50	19.12	19.00	18.94
		12	0	20.50	19.16	18.96	18.96
		12	6	20.50	19.11	18.99	18.97
		12	13	20.50	19.11	18.97	18.99
		25	0	20.50	19.13	19.00	19.12
	16QAM	1	0	20.50	19.51	19.01	19.12
		1	13	20.50	19.72	19.20	19.08
		1	24	20.50	19.39	19.15	19.04
		12	0	20.50	19.14	18.94	19.05
		12	6	20.50	19.08	18.95	19.00
		12	13	20.50	19.08	18.94	18.99
		25	0	20.50	19.07	18.91	19.06
	64QAM	1	0	20.50	19.08	19.19	19.10
		1	13	20.50	19.53	19.00	19.30
		1	24	20.50	19.33	19.05	19.12
		12	0	20.50	19.10	19.08	19.18
		12	6	20.50	19.10	19.15	19.17
		12	13	20.50	19.17	19.07	19.13
		25	0	20.50	18.95	19.14	19.19
Bandwidth	Modulation	RB size	RB offset	Tune-up	Channel	Channel	Channel
10MHz	QPSK	1	0	20.50	19.28	19.02	19.10
		1	25	20.50	19.28	19.01	19.09
		1	49	20.50	19.25	19.03	19.00
		25	0	20.50	19.13	19.02	19.20
		25	13	20.50	19.16	19.03	19.19
		25	25	20.50	19.13	18.96	19.12
		50	0	20.50	19.27	19.16	19.00
	16QAM	1	0	20.50	19.34	19.02	19.08
		1	25	20.50	19.28	19.20	19.26
		1	49	20.50	19.40	19.01	19.27
		25	0	20.50	19.08	18.97	19.13
		25	13	20.50	19.05	19.04	18.94
		25	25	20.50	19.06	19.02	18.93
		50	0	20.50	19.17	18.88	19.06
	64QAM	1	0	20.50	19.64	19.27	19.12
		1	25	20.50	19.42	19.12	19.13
		1	49	20.50	19.22	19.25	19.13
		25	0	20.50	19.11	19.09	18.99
		25	13	20.50	19.09	19.10	18.96
		25	25	20.50	19.11	19.12	18.94
		50	0	20.50	19.21	19.13	19.02
Bandwidth	Modulation	RB size	RB offset	Tune-up	Channel	Channel	Channel
				Max.	18650CH	18900CH	19150CH

Bandwidth	Modulation	RB size	RB offset	Tune-up	Channel	Channel	Channel
				Max.	18675CH	18900CH	19125CH
15MHz	QPSK	1	0	20.50	19.26	19.11	19.15
		1	38	20.50	19.25	19.07	18.94
		1	74	20.50	19.24	19.10	18.98
		36	0	20.50	19.34	19.18	19.15
		36	18	20.50	19.37	18.96	19.12
		36	39	20.50	19.35	18.96	18.93
		75	0	20.50	19.28	19.16	19.06
	16QAM	1	0	20.50	19.15	18.95	19.04
		1	38	20.50	19.36	19.20	19.31
		1	74	20.50	19.05	19.20	19.11
		36	0	20.50	19.35	18.95	18.91
		36	18	20.50	19.36	18.97	18.91
		36	39	20.50	19.32	18.99	18.91
		75	0	20.50	19.18	19.10	19.06
	64QAM	1	0	20.50	19.51	19.17	19.26
		1	38	20.50	19.48	19.01	19.54
		1	74	20.50	19.36	19.36	19.32
		36	0	20.50	19.38	19.17	18.89
		36	18	20.50	19.41	19.10	18.94
		36	39	20.50	19.40	19.12	18.89
		75	0	20.50	19.12	19.16	18.94
Bandwidth	Modulation	RB size	RB offset	Tune-up	Channel	Channel	Channel
20MHz	QPSK	1	0	20.50	19.42	19.29	19.34
		1	50	20.50	19.43	19.30	19.12
		1	99	20.50	19.41	19.30	19.21
		50	0	20.50	19.17	19.00	19.11
		50	25	20.50	19.44	19.14	19.11
		50	50	20.50	19.42	18.97	19.11
		100	0	20.50	19.27	18.98	19.13
	16QAM	1	0	20.50	19.48	19.58	19.64
		1	50	20.50	19.48	19.41	19.32
		1	99	20.50	19.57	19.50	19.22
		50	0	20.50	19.29	18.94	19.15
		50	25	20.50	19.33	18.98	19.14
		50	50	20.50	19.34	18.94	19.08
		100	0	20.50	19.20	18.99	18.91
	64QAM	1	0	20.50	19.47	19.53	19.36
		1	50	20.50	19.43	19.55	19.51
		1	99	20.50	19.41	19.42	19.32
		50	0	20.50	19.32	18.99	19.21
		50	25	20.50	19.31	18.97	19.19
		50	50	20.50	19.34	19.01	19.27
		100	0	20.50	19.19	19.04	19.12
Bandwidth	Modulation	RB size	RB offset	Tune-up	Channel	Channel	Channel
20MHz	QPSK	1	0	20.50	18700CH	18900CH	19100CH
		1	50	20.50	18700CH	18900CH	19100CH
		1	99	20.50	18700CH	18900CH	19100CH
		50	0	20.50	18700CH	18900CH	19100CH
		50	25	20.50	18700CH	18900CH	19100CH
		50	50	20.50	18700CH	18900CH	19100CH
		100	0	20.50	18700CH	18900CH	19100CH
	16QAM	1	0	20.50	18700CH	18900CH	19100CH
		1	50	20.50	18700CH	18900CH	19100CH
		1	99	20.50	18700CH	18900CH	19100CH
		50	0	20.50	18700CH	18900CH	19100CH
		50	25	20.50	18700CH	18900CH	19100CH
		50	50	20.50	18700CH	18900CH	19100CH
		100	0	20.50	18700CH	18900CH	19100CH
	64QAM	1	0	20.50	18700CH	18900CH	19100CH
		1	50	20.50	18700CH	18900CH	19100CH
		1	99	20.50	18700CH	18900CH	19100CH
		50	0	20.50	18700CH	18900CH	19100CH
		50	25	20.50	18700CH	18900CH	19100CH
		50	50	20.50	18700CH	18900CH	19100CH
		100	0	20.50	18700CH	18900CH	19100CH

Table 52: Conducted power measurement results of LTE Band 2 (Reduced Power Level D7)

7.1.13 Conducted power measurements of LTE Band 4(Second antenna)

Bandwidth	Modulation	RB size	RB offset	Tune-up	Channel	Channel	Channel	
				Max.	19957CH	20175CH	20393CH	
1.4MHz	QPSK	1	0	17.50	16.10	16.07	16.36	
		1	3	17.50	16.17	16.09	16.27	
		1	5	17.50	16.07	16.06	16.38	
		3	0	17.50	16.13	16.15	16.29	
		3	2	17.50	16.11	16.15	16.31	
		3	3	17.50	16.09	16.15	16.30	
		6	0	17.50	16.12	16.33	16.32	
	16QAM	1	0	17.50	16.37	16.09	16.34	
		1	3	17.50	16.15	16.23	16.39	
		1	5	17.50	16.15	16.32	16.22	
		3	0	17.50	16.08	16.09	16.17	
		3	2	17.50	16.02	16.18	16.17	
		3	3	17.50	16.14	16.21	16.27	
		6	0	17.50	15.98	16.12	16.30	
	64QAM	1	0	17.50	16.01	16.32	16.35	
		1	3	17.50	16.09	16.26	16.43	
		1	5	17.50	16.08	16.24	16.38	
		3	0	17.50	16.09	16.17	16.22	
		3	2	17.50	16.03	16.21	16.34	
		3	3	17.50	16.05	16.10	16.19	
		6	0	17.50	15.91	16.11	16.01	
	Bandwidth	Modulation	RB size	RB offset	Tune-up	Channel	Channel	Channel
	3MHz	QPSK	1	0	17.50	16.20	16.15	16.13
			1	7	17.50	16.20	16.18	16.28
1			14	17.50	16.19	16.14	16.30	
8			0	17.50	16.22	16.31	16.15	
8			4	17.50	16.22	16.35	16.15	
8			7	17.50	16.21	16.30	16.12	
15			0	17.50	16.21	16.35	16.32	
16QAM		1	0	17.50	16.31	16.24	16.44	
		1	7	17.50	16.07	16.56	16.28	
		1	14	17.50	16.03	16.26	16.31	
		8	0	17.50	15.99	16.04	16.30	
		8	4	17.50	15.91	16.02	16.14	
		8	7	17.50	16.02	15.96	16.28	
		15	0	17.50	15.91	16.24	16.27	
64QAM		1	0	17.50	16.19	16.09	16.27	
		1	7	17.50	16.13	16.14	16.36	
		1	14	17.50	16.05	16.13	16.60	
		8	0	17.50	16.02	16.16	16.11	
		8	4	17.50	15.94	16.21	16.12	
		8	7	17.50	16.01	16.16	16.15	
		15	0	17.50	15.89	16.28	16.07	
Bandwidth		Modulation	RB size	RB offset	Tune-up	Channel	Channel	Channel
					Max.	19965CH	20175CH	20385CH

Bandwidth	Modulation	RB size	RB offset	Tune-up	Channel	Channel	Channel
				Max.	19975CH	20175CH	20375CH
5MHz	QPSK	1	0	17.50	16.23	16.11	16.31
		1	13	17.50	16.19	16.13	16.32
		1	24	17.50	16.14	16.14	16.30
		12	0	17.50	16.20	16.30	16.13
		12	6	17.50	16.21	16.32	16.14
		12	13	17.50	16.25	16.29	16.14
		25	0	17.50	16.22	16.32	16.11
	16QAM	1	0	17.50	16.26	16.28	16.46
		1	13	17.50	16.40	16.39	16.50
		1	24	17.50	16.27	16.20	16.36
		12	0	17.50	16.00	16.23	16.28
		12	6	17.50	16.00	16.26	16.24
		12	13	17.50	16.00	16.29	16.29
		25	0	17.50	15.98	16.20	16.21
	64QAM	1	0	17.50	16.20	16.18	16.36
		1	13	17.50	16.33	16.31	16.27
		1	24	17.50	16.10	16.16	16.36
		12	0	17.50	15.94	16.09	16.26
		12	6	17.50	15.96	16.15	16.17
		12	13	17.50	15.95	16.16	16.25
		25	0	17.50	16.02	16.27	16.06
Bandwidth	Modulation	RB size	RB offset	Tune-up	Channel	Channel	Channel
10MHz	QPSK	1	0	17.50	16.07	16.15	16.35
		1	25	17.50	16.27	16.10	16.36
		1	49	17.50	16.02	16.14	16.37
		25	0	17.50	16.01	16.32	16.15
		25	13	17.50	16.33	16.33	16.12
		25	25	17.50	16.02	16.33	16.15
		50	0	17.50	16.06	16.28	16.14
	16QAM	1	0	17.50	16.25	16.25	16.31
		1	25	17.50	16.23	16.26	16.41
		1	49	17.50	16.29	16.10	16.32
		25	0	17.50	16.03	16.23	16.38
		25	13	17.50	16.05	16.26	16.36
		25	25	17.50	16.14	16.30	16.33
		50	0	17.50	16.09	16.22	16.09
	64QAM	1	0	17.50	16.25	16.46	16.44
		1	25	17.50	16.33	16.50	16.58
		1	49	17.50	16.20	16.46	16.56
		25	0	17.50	16.09	16.27	16.22
		25	13	17.50	16.13	16.32	16.22
		25	25	17.50	16.10	16.27	16.25
		50	0	17.50	16.12	16.31	16.23
Bandwidth	Modulation	RB size	RB offset	Tune-up	Channel	Channel	Channel
				Max.	20000CH	20175CH	20350CH

Bandwidth	Modulation	RB size	RB offset	Tune-up	Channel	Channel	Channel
				Max.	20025CH	20175CH	20325CH
15MHz	QPSK	1	0	17.50	16.15	16.18	16.51
		1	38	17.50	16.16	16.20	16.51
		1	74	17.50	16.17	16.17	16.51
		36	0	17.50	16.37	16.39	16.47
		36	18	17.50	16.41	16.40	16.47
		36	39	17.50	16.39	16.41	16.47
		75	0	17.50	16.33	16.44	16.44
	16QAM	1	0	17.50	16.47	16.24	16.58
		1	38	17.50	16.45	16.30	16.44
		1	74	17.50	16.52	16.31	16.55
		36	0	17.50	16.19	16.32	16.38
		36	18	17.50	16.18	16.37	16.40
		36	39	17.50	16.16	16.32	16.41
		75	0	17.50	16.13	16.33	16.42
	64QAM	1	0	17.50	16.19	16.25	16.47
		1	38	17.50	16.26	16.33	16.40
		1	74	17.50	16.55	16.32	16.68
		36	0	17.50	16.12	16.20	16.38
		36	18	17.50	16.13	16.26	16.37
		36	39	17.50	16.14	16.25	16.38
		75	0	17.50	16.11	16.36	16.25
Bandwidth	Modulation	RB size	RB offset	Tune-up	Channel	Channel	Channel
20MHz	QPSK	1	0	17.50	16.39	16.54	16.61
		1	50	17.50	16.62	16.55	16.60
		1	99	17.50	16.41	16.54	16.60
		50	0	17.50	16.26	16.41	16.49
		50	25	17.50	16.27	16.42	16.51
		50	50	17.50	16.24	16.41	16.48
		100	0	17.50	16.28	16.50	16.44
	16QAM	1	0	17.50	16.74	16.73	16.79
		1	50	17.50	16.68	16.78	16.81
		1	99	17.50	16.80	16.92	16.88
		50	0	17.50	16.18	16.36	16.26
		50	25	17.50	16.10	16.30	16.44
		50	50	17.50	16.17	16.33	16.23
		100	0	17.50	16.21	16.20	16.34
	64QAM	1	0	17.50	16.63	16.40	16.96
		1	50	17.50	16.46	16.45	16.57
		1	99	17.50	16.60	16.62	16.67
		50	0	17.50	16.19	16.20	16.27
		50	25	17.50	16.19	16.19	16.26
		50	50	17.50	16.23	16.22	16.29
		100	0	17.50	16.30	16.19	16.25
Bandwidth	Modulation	RB size	RB offset	Tune-up	Channel	Channel	Channel
20MHz	QPSK	1	0	17.50	16.39	16.54	16.61
		1	50	17.50	16.62	16.55	16.60
		1	99	17.50	16.41	16.54	16.60
		50	0	17.50	16.26	16.41	16.49
		50	25	17.50	16.27	16.42	16.51
		50	50	17.50	16.24	16.41	16.48
		100	0	17.50	16.28	16.50	16.44
	16QAM	1	0	17.50	16.74	16.73	16.79
		1	50	17.50	16.68	16.78	16.81
		1	99	17.50	16.80	16.92	16.88
		50	0	17.50	16.18	16.36	16.26
		50	25	17.50	16.10	16.30	16.44
		50	50	17.50	16.17	16.33	16.23
		100	0	17.50	16.21	16.20	16.34
	64QAM	1	0	17.50	16.63	16.40	16.96
		1	50	17.50	16.46	16.45	16.57
		1	99	17.50	16.60	16.62	16.67
		50	0	17.50	16.19	16.20	16.27
		50	25	17.50	16.19	16.19	16.26
		50	50	17.50	16.23	16.22	16.29
		100	0	17.50	16.30	16.19	16.25

Table 53: Conducted power measurement results of LTE Band 4 (Reduced Power Level D1)

Bandwidth	Modulation	RB size	RB offset	Tune-up	Channel	Channel	Channel
				Max.	19957CH	20175CH	20393CH
1.4MHz	QPSK	1	0	24.00	22.72	22.70	22.77
		1	3	24.00	22.52	22.80	22.66
		1	5	24.00	22.75	22.70	22.83
		3	0	24.00	22.76	22.52	22.71
		3	2	24.00	22.75	22.52	22.72
		3	3	24.00	22.73	22.52	22.73
		6	0	23.00	21.76	21.72	21.87
	16QAM	1	0	23.00	21.64	21.68	21.76
		1	3	23.00	21.57	21.83	21.77
		1	5	23.00	21.78	21.71	21.89
		3	0	23.00	21.75	21.93	21.69
		3	2	23.00	21.76	21.84	21.60
		3	3	23.00	21.80	21.85	21.74
		6	0	22.00	20.52	20.81	20.74
	64QAM	1	0	22.00	20.66	20.62	20.69
		1	3	22.00	20.63	20.82	20.90
		1	5	22.00	20.66	20.96	20.82
		3	0	22.00	20.72	20.80	20.90
		3	2	22.00	20.72	20.78	20.84
		3	3	22.00	20.68	20.88	20.64
		6	0	21.00	19.67	19.75	19.69
Bandwidth	Modulation	RB size	RB offset	Tune-up	Channel	Channel	Channel
3MHz	QPSK	1	0	24.00	22.67	22.52	22.64
		1	7	24.00	22.70	22.52	22.56
		1	14	24.00	22.62	22.48	22.54
		8	0	23.00	21.38	21.52	21.63
		8	4	23.00	21.39	21.53	21.61
		8	7	23.00	21.39	21.55	21.57
		15	0	23.00	21.53	21.60	21.61
	16QAM	1	0	23.00	21.73	21.62	21.67
		1	7	23.00	21.76	21.53	21.70
		1	14	23.00	21.71	21.62	21.80
		8	0	22.00	20.41	20.56	20.60
		8	4	22.00	20.36	20.55	20.54
		8	7	22.00	20.33	20.60	20.61
		15	0	22.00	20.53	20.76	20.54
	64QAM	1	0	22.00	20.84	20.72	20.58
		1	7	22.00	20.92	20.88	20.69
		1	14	22.00	20.84	20.90	20.78
		8	0	21.00	19.39	19.52	19.59
		8	4	21.00	19.74	19.53	19.62
		8	7	21.00	19.41	19.54	19.59
		15	0	21.00	19.51	19.56	19.68

Bandwidth	Modulation	RB size	RB offset	Tune-up	Channel	Channel	Channel
				Max.	19975CH	20175CH	20375CH
5MHz	QPSK	1	0	24.00	22.70	22.74	22.56
		1	13	24.00	22.70	22.48	22.61
		1	24	24.00	22.71	22.50	22.55
		12	0	23.00	21.70	21.55	21.65
		12	6	23.00	21.70	21.57	21.65
		12	13	23.00	21.42	21.56	21.67
		25	0	23.00	21.50	21.61	21.61
	16QAM	1	0	23.00	21.97	21.76	21.88
		1	13	23.00	21.87	21.76	21.79
		1	24	23.00	21.88	21.95	21.69
		12	0	22.00	20.67	20.81	20.64
		12	6	22.00	20.65	20.48	20.62
		12	13	22.00	20.35	20.51	20.61
		25	0	22.00	20.48	20.73	20.53
	64QAM	1	0	22.00	20.46	21.04	20.75
		1	13	22.00	20.50	20.63	20.86
		1	24	22.00	20.53	20.84	20.80
		12	0	21.00	19.66	19.55	19.69
		12	6	21.00	19.71	19.60	19.64
		12	13	21.00	19.69	19.55	19.68
		25	0	21.00	19.50	19.54	19.61
Bandwidth	Modulation	RB size	RB offset	Tune-up	Channel	Channel	Channel
10MHz	QPSK	1	0	24.00	22.59	22.67	22.70
		1	25	24.00	22.44	22.68	22.66
		1	49	24.00	22.55	22.64	22.68
		25	0	23.00	21.65	21.63	21.68
		25	13	23.00	21.50	21.64	21.62
		25	25	23.00	21.64	21.61	21.62
		50	0	23.00	21.48	21.53	21.61
	16QAM	1	0	23.00	21.56	21.66	21.68
		1	25	23.00	21.57	21.79	21.81
		1	49	23.00	21.50	21.66	21.80
		25	0	22.00	20.54	20.54	20.62
		25	13	22.00	20.52	20.59	20.60
		25	25	22.00	20.46	20.54	20.64
		50	0	22.00	20.48	20.69	20.66
	64QAM	1	0	22.00	20.62	21.00	20.99
		1	25	22.00	20.69	20.88	20.93
		1	49	22.00	20.95	20.84	20.95
		25	0	21.00	19.60	19.79	19.68
		25	13	21.00	19.61	19.59	19.68
		25	25	21.00	19.62	19.78	19.75
		50	0	21.00	19.53	19.80	19.63
Bandwidth	Modulation	RB size	RB offset	Tune-up	Channel	Channel	Channel
				Max.	20000CH	20175CH	20350CH

Bandwidth	Modulation	RB size	RB offset	Tune-up	Channel	Channel	Channel
				Max.	20025CH	20175CH	20325CH
15MHz	QPSK	1	0	24.00	22.65	22.68	22.85
		1	38	24.00	22.67	22.71	22.85
		1	74	24.00	22.61	22.71	22.84
		36	0	23.00	21.72	21.69	21.69
		36	18	23.00	21.71	21.67	21.66
		36	39	23.00	21.71	21.67	21.67
		75	0	23.00	21.65	21.70	21.76
	16QAM	1	0	23.00	21.61	21.95	22.02
		1	38	23.00	21.72	21.81	21.90
		1	74	23.00	21.75	21.83	21.96
		36	0	22.00	20.54	20.61	20.69
		36	18	22.00	20.58	20.64	20.69
		36	39	22.00	20.54	20.68	20.70
		75	0	22.00	20.76	20.81	20.74
	64QAM	1	0	22.00	20.69	20.90	20.88
		1	38	22.00	20.71	20.97	20.98
		1	74	22.00	20.65	20.93	20.84
		36	0	21.00	19.60	19.62	19.70
		36	18	21.00	19.57	19.70	19.74
		36	39	21.00	19.63	19.63	19.69
		75	0	21.00	19.65	19.81	19.73
Bandwidth	Modulation	RB size	RB offset	Tune-up	Channel	Channel	Channel
20MHz	QPSK	1	0	24.00	22.71	22.85	22.79
		1	50	24.00	22.69	22.87	22.78
		1	99	24.00	22.72	22.91	22.76
		50	0	23.00	21.70	21.73	21.84
		50	25	23.00	21.71	21.76	21.82
		50	50	23.00	21.70	21.73	21.82
		100	0	23.00	21.86	21.74	21.92
	16QAM	1	0	23.00	22.03	21.96	22.41
		1	50	23.00	22.02	21.99	22.40
		1	99	23.00	22.03	22.14	22.40
		50	0	22.00	20.65	20.68	20.71
		50	25	22.00	20.69	20.57	20.72
		50	50	22.00	20.64	20.57	20.66
		100	0	22.00	20.89	20.69	20.84
	64QAM	1	0	22.00	20.75	21.12	20.98
		1	50	22.00	20.91	21.26	20.92
		1	99	22.00	20.84	20.99	20.84
		50	0	21.00	19.65	19.65	19.71
		50	25	21.00	19.65	19.60	19.72
		50	50	21.00	19.65	19.90	19.73
		100	0	21.00	19.76	19.70	19.81

Table 54: Conducted power measurement results of LTE Band 4 (Full Power)

Bandwidth	Modulation	RB size	RB offset	Tune-up	Channel	Channel	Channel
				Max.	19957CH	20175CH	20393CH
1.4MHz	QPSK	1	0	14.50	13.02	13.25	13.28
		1	3	14.50	13.11	13.12	13.19
		1	5	14.50	13.08	13.22	13.32
		3	0	14.50	13.04	13.16	13.24
		3	2	14.50	13.05	13.17	13.23
		3	3	14.50	13.02	13.18	13.24
		6	0	14.50	13.05	13.29	13.37
	16QAM	1	0	14.50	13.45	13.18	13.16
		1	3	14.50	13.30	13.28	13.27
		1	5	14.50	13.19	13.35	13.16
		3	0	14.50	13.19	13.10	13.08
		3	2	14.50	13.18	13.02	13.04
		3	3	14.50	13.13	13.08	13.37
		6	0	14.50	13.23	13.13	13.34
	64QAM	1	0	14.50	13.27	13.33	13.47
		1	3	14.50	13.22	13.16	13.56
		1	5	14.50	13.33	13.15	13.27
		3	0	14.50	13.12	13.09	13.35
		3	2	14.50	13.15	13.14	13.31
		3	3	14.50	13.10	13.11	13.14
		6	0	14.50	13.08	13.21	13.34
Bandwidth	Modulation	RB size	RB offset	Tune-up	Channel	Channel	Channel
3MHz	QPSK	1	0	14.50	13.11	13.14	13.28
		1	7	14.50	13.12	13.14	13.27
		1	14	14.50	13.08	13.12	13.27
		8	0	14.50	13.21	13.29	13.20
		8	4	14.50	13.28	13.34	13.19
		8	7	14.50	13.21	13.31	13.08
		15	0	14.50	13.24	13.31	13.35
	16QAM	1	0	14.50	13.23	13.39	13.25
		1	7	14.50	13.34	13.34	13.34
		1	14	14.50	13.31	13.21	13.53
		8	0	14.50	13.15	12.99	13.28
		8	4	14.50	13.23	13.03	13.37
		8	7	14.50	13.19	13.02	13.34
		15	0	14.50	12.99	13.32	13.29
	64QAM	1	0	14.50	13.36	13.17	13.52
		1	7	14.50	13.25	13.25	13.33
		1	14	14.50	13.49	13.01	13.48
		8	0	14.50	13.19	13.05	13.28
		8	4	14.50	13.18	13.37	13.36
		8	7	14.50	13.27	13.13	13.33
		15	0	14.50	13.20	13.23	13.30
Bandwidth	Modulation	RB size	RB offset	Tune-up	Channel	Channel	Channel
				Max.	19965CH	20175CH	20385CH

Bandwidth	Modulation	RB size	RB offset	Tune-up	Channel	Channel	Channel
				Max.	19975CH	20175CH	20375CH
5MHz	QPSK	1	0	14.50	13.23	13.12	13.31
		1	13	14.50	13.21	13.12	13.31
		1	24	14.50	13.11	13.12	13.29
		12	0	14.50	13.24	13.25	13.16
		12	6	14.50	13.25	13.34	13.16
		12	13	14.50	13.28	13.24	13.17
		25	0	14.50	13.26	13.29	13.34
	16QAM	1	0	14.50	13.58	13.52	13.50
		1	13	14.50	13.35	13.55	13.43
		1	24	14.50	13.33	13.57	13.42
		12	0	14.50	13.16	13.23	13.39
		12	6	14.50	13.19	13.32	13.33
		12	13	14.50	13.23	13.25	13.34
		25	0	14.50	13.09	13.23	13.23
	64QAM	1	0	14.50	13.32	13.11	13.40
		1	13	14.50	13.42	13.38	13.48
		1	24	14.50	13.27	13.23	13.60
		12	0	14.50	13.20	13.22	13.16
		12	6	14.50	13.21	13.31	13.19
		12	13	14.50	13.23	13.12	13.18
		25	0	14.50	13.20	13.28	13.27
Bandwidth	Modulation	RB size	RB offset	Tune-up	Channel	Channel	Channel
10MHz	QPSK	1	0	14.50	13.26	13.37	13.21
		1	25	14.50	13.20	13.38	13.22
		1	49	14.50	13.25	13.29	13.23
		25	0	14.50	13.27	13.36	13.41
		25	13	14.50	13.27	13.32	13.39
		25	25	14.50	13.28	13.36	13.38
		50	0	14.50	13.34	13.25	13.15
	16QAM	1	0	14.50	13.29	13.29	13.27
		1	25	14.50	13.46	13.08	13.19
		1	49	14.50	13.30	13.20	13.37
		25	0	14.50	13.27	13.30	13.36
		25	13	14.50	13.19	13.30	13.32
		25	25	14.50	13.28	13.33	13.36
		50	0	14.50	13.30	13.29	13.13
	64QAM	1	0	14.50	13.52	13.41	13.52
		1	25	14.50	13.49	13.51	13.35
		1	49	14.50	13.38	13.35	13.30
		25	0	14.50	13.29	13.36	13.38
		25	13	14.50	13.30	13.37	13.45
		25	25	14.50	13.33	13.37	13.43
		50	0	14.50	13.34	13.34	13.46

Bandwidth	Modulation	RB size	RB offset	Tune-up	Channel	Channel	Channel
				Max.	20025CH	20175CH	20325CH
15MHz	QPSK	1	0	14.50	13.39	13.40	13.44
		1	38	14.50	13.36	13.43	13.42
		1	74	14.50	13.37	13.37	13.45
		36	0	14.50	13.29	13.41	13.44
		36	18	14.50	13.29	13.40	13.46
		36	39	14.50	13.28	13.42	13.45
		75	0	14.50	13.34	13.46	13.44
	16QAM	1	0	14.50	13.44	13.43	13.40
		1	38	14.50	13.45	13.29	13.38
		1	74	14.50	13.37	13.31	13.44
		36	0	14.50	13.30	13.35	13.40
		36	18	14.50	13.31	13.38	13.38
		36	39	14.50	13.36	13.32	13.38
		75	0	14.50	13.32	13.31	13.39
	64QAM	1	0	14.50	13.32	13.08	13.50
		1	38	14.50	13.41	13.19	13.51
		1	74	14.50	13.56	13.55	13.67
		36	0	14.50	13.37	13.35	13.45
		36	18	14.50	13.35	13.40	13.45
		36	39	14.50	13.36	13.41	13.43
		75	0	14.50	13.33	13.33	13.41
Bandwidth	Modulation	RB size	RB offset	Tune-up	Channel	Channel	Channel
20MHz	QPSK	1	0	14.50	13.58	13.52	13.65
		1	50	14.50	13.58	13.49	13.64
		1	99	14.50	13.60	13.50	13.63
		50	0	14.50	13.31	13.44	13.45
		50	25	14.50	13.30	13.43	13.45
		50	50	14.50	13.30	13.42	13.45
		100	0	14.50	13.29	13.47	13.34
	16QAM	1	0	14.50	13.75	13.61	13.77
		1	50	14.50	13.80	13.75	13.68
		1	99	14.50	13.77	13.77	13.81
		50	0	14.50	13.21	13.40	13.25
		50	25	14.50	13.24	13.34	13.40
		50	50	14.50	13.23	13.37	13.24
		100	0	14.50	13.37	13.25	13.36
	64QAM	1	0	14.50	13.70	13.74	13.71
		1	50	14.50	13.73	13.79	13.60
		1	99	14.50	13.67	13.59	13.59
		50	0	14.50	13.42	13.37	13.31
		50	25	14.50	13.48	13.38	13.31
		50	50	14.50	13.48	13.42	13.30
		100	0	14.50	13.36	13.27	13.42
Bandwidth	Modulation	RB size	RB offset	Tune-up	Channel	Channel	Channel
20MHz	QPSK	1	0	14.50	13.58	13.52	13.65
		1	50	14.50	13.58	13.49	13.64
		1	99	14.50	13.60	13.50	13.63
		50	0	14.50	13.31	13.44	13.45
		50	25	14.50	13.30	13.43	13.45
		50	50	14.50	13.30	13.42	13.45
		100	0	14.50	13.29	13.47	13.34
	16QAM	1	0	14.50	13.75	13.61	13.77
		1	50	14.50	13.80	13.75	13.68
		1	99	14.50	13.77	13.77	13.81
		50	0	14.50	13.21	13.40	13.25
		50	25	14.50	13.24	13.34	13.40
		50	50	14.50	13.23	13.37	13.24
		100	0	14.50	13.37	13.25	13.36
	64QAM	1	0	14.50	13.70	13.74	13.71
		1	50	14.50	13.73	13.79	13.60
		1	99	14.50	13.67	13.59	13.59
		50	0	14.50	13.42	13.37	13.31
		50	25	14.50	13.48	13.38	13.31
		50	50	14.50	13.48	13.42	13.30
		100	0	14.50	13.36	13.27	13.42

Table 55: Conducted power measurement results of LTE Band 4 (Reduced Power Level D3)

Bandwidth	Modulation	RB size	RB offset	Tune-up	Channel	Channel	Channel
				Max.	19957CH	20175CH	20393CH
1.4MHz	QPSK	1	0	21.00	19.47	19.72	19.96
		1	3	21.00	19.71	19.86	19.80
		1	5	21.00	19.51	19.72	19.91
		3	0	21.00	19.54	19.63	19.84
		3	2	21.00	19.53	19.63	19.83
		3	3	21.00	19.51	19.62	19.83
		6	0	21.00	19.76	19.62	19.86
	16QAM	1	0	21.00	19.82	19.61	19.84
		1	3	21.00	19.68	19.61	20.02
		1	5	21.00	19.80	19.63	19.92
		3	0	21.00	19.67	19.85	19.96
		3	2	21.00	19.63	19.80	19.96
		3	3	21.00	19.72	19.84	19.60
		6	0	21.00	19.58	19.59	19.65
	64QAM	1	0	21.00	19.67	19.84	19.81
		1	3	21.00	19.91	19.92	19.81
		1	5	21.00	19.75	19.98	19.97
		3	0	21.00	19.64	19.66	19.54
		3	2	21.00	19.79	19.73	19.69
		3	3	21.00	19.77	19.67	19.76
		6	0	21.00	19.67	19.83	19.78
Bandwidth	Modulation	RB size	RB offset	Tune-up	Channel	Channel	Channel
3MHz	QPSK	1	0	21.00	19.84	19.65	19.81
		1	7	21.00	19.75	19.62	19.68
		1	14	21.00	19.79	19.68	19.69
		8	0	21.00	19.58	19.66	19.81
		8	4	21.00	19.58	19.67	19.78
		8	7	21.00	19.58	19.66	19.67
		15	0	21.00	19.78	19.62	19.69
	16QAM	1	0	21.00	19.74	20.02	19.68
		1	7	21.00	19.67	19.75	19.69
		1	14	21.00	19.71	19.72	19.72
		8	0	21.00	19.47	19.52	19.53
		8	4	21.00	19.49	19.65	19.69
		8	7	21.00	19.49	19.56	19.61
		15	0	21.00	19.44	19.79	19.64
	64QAM	1	0	21.00	19.52	19.90	19.86
		1	7	21.00	19.68	19.80	19.84
		1	14	21.00	19.57	20.04	19.65
		8	0	21.00	19.35	19.61	19.59
		8	4	21.00	19.65	19.50	19.59
		8	7	21.00	19.42	19.62	19.61
		15	0	21.00	19.56	19.58	19.72
Bandwidth	Modulation	RB size	RB offset	Tune-up	Channel	Channel	Channel
				Max.	19965CH	20175CH	20385CH

Bandwidth	Modulation	RB size	RB offset	Tune-up	Channel	Channel	Channel
				Max.	19975CH	20175CH	20375CH
5MHz	QPSK	1	0	21.00	19.84	19.77	19.78
		1	13	21.00	19.85	19.62	19.79
		1	24	21.00	19.80	19.57	19.77
		12	0	21.00	19.76	19.62	19.78
		12	6	21.00	19.76	19.64	19.78
		12	13	21.00	19.58	19.60	19.78
		25	0	21.00	19.75	19.61	19.76
	16QAM	1	0	21.00	19.87	19.68	19.84
		1	13	21.00	20.10	19.90	19.94
		1	24	21.00	19.92	20.07	19.98
		12	0	21.00	19.49	19.75	19.70
		12	6	21.00	19.52	19.54	19.72
		12	13	21.00	19.55	19.65	19.70
		25	0	21.00	19.40	19.75	19.56
	64QAM	1	0	21.00	19.57	19.90	19.70
		1	13	21.00	19.71	19.85	19.67
		1	24	21.00	19.67	19.88	19.95
		12	0	21.00	19.68	19.63	19.60
		12	6	21.00	19.69	19.51	19.70
		12	13	21.00	19.63	19.58	19.64
		25	0	21.00	19.47	19.54	19.56
Bandwidth	Modulation	RB size	RB offset	Tune-up	Channel	Channel	Channel
10MHz	QPSK	1	0	21.00	19.70	19.84	19.68
		1	25	21.00	19.54	19.80	19.71
		1	49	21.00	19.71	19.76	19.71
		25	0	21.00	19.81	19.69	19.66
		25	13	21.00	19.47	19.69	19.67
		25	25	21.00	19.82	19.70	19.66
		50	0	21.00	19.65	19.52	19.76
	16QAM	1	0	21.00	19.75	19.68	19.68
		1	25	21.00	19.72	19.80	19.81
		1	49	21.00	19.78	19.84	19.88
		25	0	21.00	19.63	19.60	19.58
		25	13	21.00	19.59	19.59	19.64
		25	25	21.00	19.53	19.59	19.61
		50	0	21.00	19.53	19.76	19.66
	64QAM	1	0	21.00	19.80	20.07	19.89
		1	25	21.00	19.76	19.85	19.88
		1	49	21.00	19.71	19.91	19.96
		25	0	21.00	19.59	19.81	19.65
		25	13	21.00	19.59	19.64	19.66
		25	25	21.00	19.58	19.81	19.68
		50	0	21.00	19.48	19.84	19.67
Bandwidth	Modulation	RB size	RB offset	Tune-up	Channel	Channel	Channel
				Max.	20000CH	20175CH	20350CH

Bandwidth	Modulation	RB size	RB offset	Tune-up	Channel	Channel	Channel
				Max.	20025CH	20175CH	20325CH
15MHz	QPSK	1	0	21.00	19.79	19.88	19.75
		1	38	21.00	19.76	19.90	19.77
		1	74	21.00	19.80	19.88	19.77
		36	0	21.00	19.92	19.75	19.78
		36	18	21.00	19.93	19.75	19.79
		36	39	21.00	19.92	19.75	19.79
		75	0	21.00	19.66	19.80	19.71
	16QAM	1	0	21.00	19.77	19.93	20.11
		1	38	21.00	19.92	20.03	20.08
		1	74	21.00	19.86	20.08	20.15
		36	0	21.00	19.60	19.62	19.73
		36	18	21.00	19.63	19.70	19.73
		36	39	21.00	19.61	19.66	19.74
		75	0	21.00	19.80	19.83	19.72
	64QAM	1	0	21.00	19.86	19.92	19.95
		1	38	21.00	19.78	20.02	19.86
		1	74	21.00	19.80	19.93	19.89
		36	0	21.00	19.58	19.66	19.73
		36	18	21.00	19.57	19.72	19.70
		36	39	21.00	19.55	19.66	19.70
		75	0	21.00	19.65	19.81	19.73
Bandwidth	Modulation	RB size	RB offset	Tune-up	Channel	Channel	Channel
20MHz	QPSK	1	0	21.00	19.82	19.92	20.20
		1	50	21.00	19.82	19.96	20.17
		1	99	21.00	19.84	19.96	20.20
		50	0	21.00	19.92	19.83	20.02
		50	25	21.00	19.92	19.82	20.04
		50	50	21.00	19.92	19.82	20.04
		100	0	21.00	19.94	19.85	19.87
	16QAM	1	0	21.00	19.94	19.99	20.10
		1	50	21.00	19.87	19.06	19.90
		1	99	21.00	19.96	19.84	20.14
		50	0	21.00	19.68	19.73	19.78
		50	25	21.00	19.69	19.65	19.89
		50	50	21.00	19.68	19.67	19.73
		100	0	21.00	19.65	19.80	19.86
	64QAM	1	0	21.00	20.09	19.99	20.11
		1	50	21.00	20.03	19.93	20.15
		1	99	21.00	19.95	19.86	20.11
		50	0	21.00	19.66	19.59	19.74
		50	25	21.00	19.70	19.66	19.73
		50	50	21.00	19.66	19.61	19.73
		100	0	21.00	19.76	19.73	19.83
Bandwidth	Modulation	RB size	RB offset	Tune-up	Channel	Channel	Channel
20MHz	QPSK	1	0	21.00	19.82	19.92	20.20
		1	50	21.00	19.82	19.96	20.17
		1	99	21.00	19.84	19.96	20.20
		50	0	21.00	19.92	19.83	20.02
		50	25	21.00	19.92	19.82	20.04
		50	50	21.00	19.92	19.82	20.04
		100	0	21.00	19.94	19.85	19.87
	16QAM	1	0	21.00	19.94	19.99	20.10
		1	50	21.00	19.87	19.06	19.90
		1	99	21.00	19.96	19.84	20.14
		50	0	21.00	19.68	19.73	19.78
		50	25	21.00	19.69	19.65	19.89
		50	50	21.00	19.68	19.67	19.73
		100	0	21.00	19.65	19.80	19.86
	64QAM	1	0	21.00	20.09	19.99	20.11
		1	50	21.00	20.03	19.93	20.15
		1	99	21.00	19.95	19.86	20.11
		50	0	21.00	19.66	19.59	19.74
		50	25	21.00	19.70	19.66	19.73
		50	50	21.00	19.66	19.61	19.73
		100	0	21.00	19.76	19.73	19.83

Table 56: Conducted power measurement results of LTE Band 4 (Reduced Power Level D2)

7.1.14 Conducted power measurements of LTE Band 4(Main antenna)

Bandwidth	Modulation	RB size	RB offset	Tune-up	Channel	Channel	Channel	
				Max.	19957CH	20175CH	20393CH	
1.4MHz	QPSK	1	0	25.00	23.87	23.60	23.77	
		1	3	25.00	23.85	23.74	23.74	
		1	5	25.00	23.74	23.78	23.83	
		3	0	25.00	23.65	23.63	23.67	
		3	2	25.00	23.65	23.62	23.67	
		3	3	25.00	23.65	23.62	23.66	
		6	0	24.00	22.74	22.72	22.81	
	16QAM	1	0	24.00	22.73	22.83	22.96	
		1	3	24.00	22.81	22.98	22.81	
		1	5	24.00	22.66	23.05	23.04	
		3	0	24.00	22.66	22.85	22.64	
		3	2	24.00	22.80	22.92	22.64	
		3	3	24.00	22.76	22.74	22.62	
		6	0	23.00	21.59	21.84	21.85	
	64QAM	1	0	23.00	21.90	21.88	21.97	
		1	3	23.00	21.98	21.87	22.01	
		1	5	23.00	21.81	22.04	21.96	
		3	0	23.00	21.72	21.78	21.69	
		3	2	23.00	21.76	21.72	21.75	
		3	3	23.00	21.74	21.71	21.70	
		6	0	22.00	20.55	20.79	20.80	
	Bandwidth	Modulation	RB size	RB offset	Tune-up	Channel	Channel	Channel
	3MHz	QPSK	1	0	25.00	23.57	23.68	23.78
			1	7	25.00	23.57	23.67	23.77
1			14	25.00	23.63	23.69	23.80	
8			0	24.00	22.82	22.73	22.66	
8			4	24.00	22.83	22.72	22.66	
8			7	24.00	22.83	22.74	22.66	
15			0	24.00	22.71	22.75	22.85	
16QAM		1	0	24.00	22.94	22.83	22.91	
		1	7	24.00	22.87	22.83	22.87	
		1	14	24.00	22.93	23.07	22.95	
		8	0	23.00	21.87	21.65	21.59	
		8	4	23.00	21.83	21.64	21.64	
		8	7	23.00	21.81	21.63	21.68	
		15	0	23.00	21.82	21.68	21.84	
64QAM		1	0	23.00	21.90	21.69	22.00	
		1	7	23.00	22.00	21.70	21.86	
		1	14	23.00	21.75	21.79	21.91	
		8	0	22.00	20.80	20.67	20.70	
		8	4	22.00	20.86	20.65	20.65	
		8	7	22.00	20.74	20.56	20.70	
		15	0	22.00	20.81	20.90	20.57	

Bandwidth	Modulation	RB size	RB offset	Tune-up	Channel	Channel	Channel
				Max.	19975CH	20175CH	20375CH
5MHz	QPSK	1	0	25.00	23.82	23.79	23.72
		1	13	25.00	23.86	23.77	23.74
		1	24	25.00	23.84	23.78	23.69
		12	0	24.00	22.58	22.71	22.69
		12	6	24.00	22.56	22.75	22.69
		12	13	24.00	22.61	22.74	22.69
		25	0	24.00	22.66	22.87	22.63
	16QAM	1	0	24.00	22.76	22.94	22.88
		1	13	24.00	23.03	22.92	23.06
		1	24	24.00	22.98	22.94	23.03
		12	0	23.00	21.83	21.73	21.67
		12	6	23.00	21.51	21.73	21.70
		12	13	23.00	21.55	21.64	21.68
		25	0	23.00	21.56	21.59	21.56
	64QAM	1	0	23.00	21.99	22.01	21.88
		1	13	23.00	21.83	21.96	21.95
		1	24	23.00	21.96	21.85	22.11
		12	0	22.00	20.63	20.66	20.72
		12	6	22.00	20.62	20.57	20.72
		12	13	22.00	20.52	20.83	20.74
		25	0	22.00	20.82	20.64	20.61
Bandwidth	Modulation	RB size	RB offset	Tune-up	Channel	Channel	Channel
10MHz	QPSK	1	0	25.00	23.85	23.86	23.69
		1	25	25.00	23.83	23.58	23.76
		1	49	25.00	23.84	23.84	23.68
		25	0	24.00	22.61	22.84	22.70
		25	13	24.00	22.69	22.70	22.66
		25	25	24.00	22.67	22.73	22.66
		50	0	24.00	22.63	22.86	22.60
	16QAM	1	0	24.00	22.98	22.95	22.74
		1	25	24.00	22.90	22.83	22.92
		1	49	24.00	22.85	22.69	22.85
		25	0	23.00	21.54	21.79	21.62
		25	13	23.00	21.56	21.59	21.61
		25	25	23.00	21.53	21.70	21.64
		50	0	23.00	21.57	21.58	21.61
	64QAM	1	0	23.00	22.01	22.20	21.87
		1	25	23.00	22.06	22.08	21.95
		1	49	23.00	21.75	21.99	21.76
		25	0	22.00	20.65	20.83	20.66
		25	13	22.00	20.58	20.57	20.70
		25	25	22.00	20.59	20.85	20.71
		50	0	22.00	20.60	20.81	20.64
Bandwidth	Modulation	RB size	RB offset	Tune-up	Channel	Channel	Channel
10MHz	QPSK	1	0	25.00	23.85	23.86	23.69
		1	25	25.00	23.83	23.58	23.76
		1	49	25.00	23.84	23.84	23.68
		25	0	24.00	22.61	22.84	22.70
		25	13	24.00	22.69	22.70	22.66
		25	25	24.00	22.67	22.73	22.66
		50	0	24.00	22.63	22.86	22.60
	16QAM	1	0	24.00	22.98	22.95	22.74
		1	25	24.00	22.90	22.83	22.92
		1	49	24.00	22.85	22.69	22.85
		25	0	23.00	21.54	21.79	21.62
		25	13	23.00	21.56	21.59	21.61
		25	25	23.00	21.53	21.70	21.64
		50	0	23.00	21.57	21.58	21.61
	64QAM	1	0	23.00	22.01	22.20	21.87
		1	25	23.00	22.06	22.08	21.95
		1	49	23.00	21.75	21.99	21.76
		25	0	22.00	20.65	20.83	20.66
		25	13	22.00	20.58	20.57	20.70
		25	25	22.00	20.59	20.85	20.71
		50	0	22.00	20.60	20.81	20.64

Bandwidth	Modulation	RB size	RB offset	Tune-up	Channel	Channel	Channel
				Max.	20025CH	20175CH	20325CH
15MHz	QPSK	1	0	25.00	23.57	23.72	23.73
		1	38	25.00	23.56	23.73	23.74
		1	74	25.00	23.56	23.71	23.73
		36	0	24.00	22.73	22.91	22.67
		36	18	24.00	22.72	22.91	22.68
		36	39	24.00	22.72	22.90	22.67
		75	0	24.00	22.78	22.70	22.65
	16QAM	1	0	24.00	22.93	23.01	22.74
		1	38	24.00	23.09	22.88	22.67
		1	74	24.00	22.60	22.83	23.05
		36	0	23.00	21.62	21.79	21.62
		36	18	23.00	21.66	21.85	21.61
		36	39	23.00	21.68	21.85	21.61
		75	0	23.00	21.63	21.56	21.62
	64QAM	1	0	23.00	22.02	21.57	21.74
		1	38	23.00	21.74	21.97	21.90
		1	74	23.00	22.06	21.81	21.92
		36	0	22.00	20.63	20.86	20.66
		36	18	22.00	20.61	20.90	20.60
		36	39	22.00	20.63	20.85	20.62
		75	0	22.00	20.65	20.70	20.67
Bandwidth	Modulation	RB size	RB offset	Tune-up	Channel	Channel	Channel
20MHz	QPSK	1	0	25.00	24.09	23.87	24.06
		1	50	25.00	24.10	23.88	24.07
		1	99	25.00	24.09	23.84	24.03
		50	0	24.00	22.79	22.75	22.76
		50	25	24.00	22.77	22.76	22.78
		50	50	24.00	22.78	22.77	22.77
		100	0	24.00	22.74	22.68	22.73
	16QAM	1	0	24.00	23.09	22.95	23.31
		1	50	24.00	23.27	23.13	23.27
		1	99	24.00	23.30	22.93	23.12
		50	0	23.00	21.71	21.69	21.72
		50	25	23.00	21.69	21.70	21.70
		50	50	23.00	21.70	21.71	21.69
		100	0	23.00	21.66	21.75	21.67
	64QAM	1	0	23.00	21.93	22.11	22.29
		1	50	23.00	21.90	22.22	21.92
		1	99	23.00	22.33	21.95	22.27
		50	0	22.00	20.75	20.69	20.76
		50	25	22.00	20.69	20.86	20.73
		50	50	22.00	20.72	20.86	20.75
		100	0	22.00	20.88	20.77	20.71
Bandwidth	Modulation	RB size	RB offset	Tune-up	Channel	Channel	Channel
20MHz	QPSK	1	0	25.00	24.09	23.87	24.06
		1	50	25.00	24.10	23.88	24.07
		1	99	25.00	24.09	23.84	24.03
		50	0	24.00	22.79	22.75	22.76
		50	25	24.00	22.77	22.76	22.78
		50	50	24.00	22.78	22.77	22.77
		100	0	24.00	22.74	22.68	22.73
	16QAM	1	0	24.00	23.09	22.95	23.31
		1	50	24.00	23.27	23.13	23.27
		1	99	24.00	23.30	22.93	23.12
		50	0	23.00	21.71	21.69	21.72
		50	25	23.00	21.69	21.70	21.70
		50	50	23.00	21.70	21.71	21.69
		100	0	23.00	21.66	21.75	21.67
	64QAM	1	0	23.00	21.93	22.11	22.29
		1	50	23.00	21.90	22.22	21.92
		1	99	23.00	22.33	21.95	22.27
		50	0	22.00	20.75	20.69	20.76
		50	25	22.00	20.69	20.86	20.73
		50	50	22.00	20.72	20.86	20.75
		100	0	22.00	20.88	20.77	20.71

Table 57: Conducted power measurement results of LTE Band 4 (Full Power)

Bandwidth	Modulation	RB size	RB offset	Tune-up	Channel	Channel	Channel
				Max.	19957CH	20175CH	20393CH
1.4MHz	QPSK	1	0	23.00	21.66	21.68	21.71
		1	3	23.00	21.63	21.66	21.67
		1	5	23.00	21.66	21.70	21.67
		3	0	23.00	21.57	21.63	21.53
		3	2	23.00	21.59	21.61	21.69
		3	3	23.00	21.58	21.63	21.77
		6	0	23.00	21.68	21.67	21.68
	16QAM	1	0	23.00	21.74	21.45	21.45
		1	3	23.00	21.63	21.54	21.54
		1	5	23.00	21.63	21.70	21.32
		3	0	23.00	21.60	21.58	21.54
		3	2	23.00	21.63	21.61	21.47
		3	3	23.00	21.69	21.64	21.48
		6	0	23.00	21.73	21.64	21.65
	64QAM	1	0	23.00	21.68	21.70	21.78
		1	3	23.00	21.64	21.87	21.71
		1	5	23.00	21.86	21.75	21.65
		3	0	23.00	21.96	21.75	21.72
		3	2	23.00	21.79	21.73	21.73
		3	3	23.00	21.76	21.75	21.84
		6	0	22.00	20.77	20.59	20.61
Bandwidth	Modulation	RB size	RB offset	Tune-up	Channel	Channel	Channel
3MHz	QPSK	1	0	23.00	21.81	21.86	21.66
		1	7	23.00	21.80	21.83	21.63
		1	14	23.00	21.79	21.82	21.64
		8	0	23.00	21.65	21.69	21.58
		8	4	23.00	21.64	21.66	21.54
		8	7	23.00	21.63	21.71	21.57
		15	0	23.00	21.68	21.73	21.64
	16QAM	1	0	23.00	21.96	21.77	21.57
		1	7	23.00	21.74	21.97	21.79
		1	14	23.00	21.89	21.95	21.71
		8	0	23.00	21.45	21.68	21.75
		8	4	23.00	21.44	21.51	21.72
		8	7	23.00	21.53	21.64	21.74
		15	0	23.00	21.49	21.65	21.73
	64QAM	1	0	23.00	21.75	21.88	21.68
		1	7	23.00	21.79	21.83	21.70
		1	14	23.00	21.97	21.73	21.59
		8	0	22.00	20.58	20.61	20.76
		8	4	22.00	20.51	20.63	20.64
		8	7	22.00	20.58	20.89	20.71
		15	0	22.00	20.56	20.70	20.61

Bandwidth	Modulation	RB size	RB offset	Tune-up	Channel	Channel	Channel
				Max.	19975CH	20175CH	20375CH
5MHz	QPSK	1	0	23.00	21.77	21.67	21.61
		1	13	23.00	21.75	21.67	21.62
		1	24	23.00	21.76	21.62	21.60
		12	0	23.00	21.67	21.78	21.61
		12	6	23.00	21.67	21.79	21.56
		12	13	23.00	21.69	21.78	21.55
		25	0	23.00	21.76	21.83	21.62
	16QAM	1	0	23.00	21.77	21.86	21.77
		1	13	23.00	21.83	21.93	21.73
		1	24	23.00	21.81	21.90	21.79
		12	0	23.00	21.62	21.83	21.75
		12	6	23.00	21.61	21.84	21.78
		12	13	23.00	21.57	21.83	21.75
		25	0	23.00	21.51	21.63	21.54
	64QAM	1	0	23.00	21.69	21.92	21.61
		1	13	23.00	21.87	21.97	21.77
		1	24	23.00	21.86	21.92	21.71
		12	0	22.00	20.62	20.80	20.79
		12	6	22.00	20.62	20.77	20.79
		12	13	22.00	20.65	20.85	20.78
		25	0	22.00	20.58	20.63	20.57
Bandwidth	Modulation	RB size	RB offset	Tune-up	Channel	Channel	Channel
10MHz	QPSK	1	0	23.00	21.81	21.67	21.88
		1	25	23.00	21.76	21.65	21.63
		1	49	23.00	21.85	21.65	21.86
		25	0	23.00	21.61	21.74	21.65
		25	13	23.00	21.64	21.75	21.65
		25	25	23.00	21.62	21.75	21.70
		50	0	23.00	21.56	21.62	21.65
	16QAM	1	0	23.00	21.88	21.69	21.71
		1	25	23.00	21.80	21.78	21.62
		1	49	23.00	21.90	21.71	21.68
		25	0	23.00	21.57	21.60	21.63
		25	13	23.00	21.55	21.78	21.61
		25	25	23.00	21.58	21.77	21.63
		50	0	23.00	21.60	21.56	21.72
	64QAM	1	0	23.00	21.84	21.73	21.86
		1	25	23.00	21.82	21.77	21.95
		1	49	23.00	22.00	21.69	21.83
		25	0	22.00	20.68	20.81	20.67
		25	13	22.00	20.69	20.86	20.62
		25	25	22.00	20.61	20.84	20.64
		50	0	22.00	20.61	20.53	20.70
Bandwidth	Modulation	RB size	RB offset	Tune-up	Channel	Channel	Channel
10MHz	QPSK	1	0	23.00	21.81	21.67	21.88
		1	25	23.00	21.76	21.65	21.63
		1	49	23.00	21.85	21.65	21.86
		25	0	23.00	21.61	21.74	21.65
		25	13	23.00	21.64	21.75	21.65
		25	25	23.00	21.62	21.75	21.70
		50	0	23.00	21.56	21.62	21.65
	16QAM	1	0	23.00	21.88	21.69	21.71
		1	25	23.00	21.80	21.78	21.62
		1	49	23.00	21.90	21.71	21.68
		25	0	23.00	21.57	21.60	21.63
		25	13	23.00	21.55	21.78	21.61
		25	25	23.00	21.58	21.77	21.63
		50	0	23.00	21.60	21.56	21.72
	64QAM	1	0	23.00	21.84	21.73	21.86
		1	25	23.00	21.82	21.77	21.95
		1	49	23.00	22.00	21.69	21.83
		25	0	22.00	20.68	20.81	20.67
		25	13	22.00	20.69	20.86	20.62
		25	25	22.00	20.61	20.84	20.64
		50	0	22.00	20.61	20.53	20.70

Bandwidth	Modulation	RB size	RB offset	Tune-up	Channel	Channel	Channel
				Max.	20025CH	20175CH	20325CH
15MHz	QPSK	1	0	23.00	21.72	21.83	21.72
		1	38	23.00	21.70	21.83	21.74
		1	74	23.00	21.71	21.80	21.70
		36	0	23.00	21.80	21.66	21.80
		36	18	23.00	21.71	21.66	21.80
		36	39	23.00	21.80	21.68	21.79
		75	0	23.00	21.63	21.72	21.69
	16QAM	1	0	23.00	21.79	21.74	22.04
		1	38	23.00	21.56	21.81	22.13
		1	74	23.00	21.77	21.95	22.04
		36	0	23.00	21.68	21.55	21.63
		36	18	23.00	21.70	21.56	21.65
		36	39	23.00	21.66	21.58	21.63
		75	0	23.00	21.58	21.56	21.55
	64QAM	1	0	23.00	21.85	21.91	21.91
		1	38	23.00	21.69	21.91	21.71
		1	74	23.00	21.76	21.74	21.64
		36	0	22.00	20.70	20.88	20.64
		36	18	22.00	20.65	20.86	20.66
		36	39	22.00	20.70	20.83	20.65
		75	0	22.00	20.56	20.67	20.62
Bandwidth	Modulation	RB size	RB offset	Tune-up	Channel	Channel	Channel
20MHz	QPSK	1	0	23.00	22.05	22.00	21.93
		1	50	23.00	22.04	22.02	21.97
		1	99	23.00	22.05	22.04	21.98
		50	0	23.00	21.92	21.69	21.90
		50	25	23.00	21.90	21.72	21.90
		50	50	23.00	21.90	21.82	21.91
		100	0	23.00	21.57	21.80	21.68
	16QAM	1	0	23.00	22.12	21.98	21.86
		1	50	23.00	22.09	21.98	21.89
		1	99	23.00	22.05	22.18	22.28
		50	0	23.00	21.74	21.83	21.77
		50	25	23.00	21.73	21.61	21.76
		50	50	23.00	21.75	21.56	21.78
		100	0	23.00	21.60	21.64	21.65
	64QAM	1	0	23.00	21.95	22.10	22.16
		1	50	23.00	21.81	22.00	22.16
		1	99	23.00	21.80	22.05	22.08
		50	0	22.00	20.76	20.70	20.72
		50	25	22.00	20.75	20.68	20.69
		50	50	22.00	20.76	20.63	20.69
		100	0	22.00	20.56	20.82	20.67

Table 58: Conducted power measurement results of LTE Band 4 (Reduced Power Level D4)

Bandwidth	Modulation	RB size	RB offset	Tune-up	Channel	Channel	Channel
				Max.	19957CH	20175CH	20393CH
1.4MHz	QPSK	1	0	21.50	20.46	20.38	20.37
		1	3	21.50	20.48	20.49	20.29
		1	5	21.50	20.28	20.48	20.31
		3	0	21.50	20.19	20.40	20.21
		3	2	21.50	20.19	20.39	20.22
		3	3	21.50	20.16	20.39	20.21
		6	0	21.50	20.27	20.38	20.22
	16QAM	1	0	21.50	20.52	20.52	20.34
		1	3	21.50	20.42	20.63	20.25
		1	5	21.50	20.57	20.53	20.17
		3	0	21.50	20.32	20.37	20.29
		3	2	21.50	20.21	20.37	20.36
		3	3	21.50	20.21	20.31	20.36
		6	0	21.50	20.13	20.31	20.34
	64QAM	1	0	21.50	20.45	20.49	20.52
		1	3	21.50	20.32	20.34	20.56
		1	5	21.50	20.34	20.53	20.58
		3	0	21.50	20.36	20.31	20.31
		3	2	21.50	20.38	20.28	20.39
		3	3	21.50	20.25	20.28	20.31
		6	0	21.50	20.31	20.26	20.26
Bandwidth	Modulation	RB size	RB offset	Tune-up	Channel	Channel	Channel
3MHz	QPSK	1	0	21.50	20.34	20.40	20.41
		1	7	21.50	20.32	20.39	20.40
		1	14	21.50	20.31	20.39	20.38
		8	0	21.50	20.41	20.34	20.33
		8	4	21.50	20.39	20.35	20.26
		8	7	21.50	20.41	20.34	20.31
		15	0	21.50	20.35	20.31	20.40
	16QAM	1	0	21.50	20.66	20.59	20.50
		1	7	21.50	20.64	20.67	20.51
		1	14	21.50	20.63	20.46	20.45
		8	0	21.50	20.23	20.17	20.24
		8	4	21.50	20.34	20.16	20.19
		8	7	21.50	20.31	20.17	20.30
		15	0	21.50	20.34	20.17	20.35
	64QAM	1	0	21.50	20.37	20.29	20.30
		1	7	21.50	20.57	19.99	20.30
		1	14	21.50	20.28	20.17	20.58
		8	0	21.50	20.30	20.09	20.09
		8	4	21.50	20.32	20.18	20.19
		8	7	21.50	20.36	20.14	20.16
		15	0	21.50	20.30	20.28	20.09
Bandwidth	Modulation	RB size	RB offset	Tune-up	Channel	Channel	Channel
				Max.	19965CH	20175CH	20385CH

Bandwidth	Modulation	RB size	RB offset	Tune-up	Channel	Channel	Channel
				Max.	19975CH	20175CH	20375CH
5MHz	QPSK	1	0	21.50	20.44	20.41	20.38
		1	13	21.50	20.50	20.37	20.35
		1	24	21.50	20.45	20.40	20.36
		12	0	21.50	20.20	20.24	20.35
		12	6	21.50	20.20	20.38	20.34
		12	13	21.50	20.21	20.41	20.34
		25	0	21.50	20.19	20.38	20.29
	16QAM	1	0	21.50	20.37	20.53	20.53
		1	13	21.50	20.66	20.62	20.48
		1	24	21.50	20.47	20.44	20.55
		12	0	21.50	20.36	20.25	20.27
		12	6	21.50	20.22	20.26	20.30
		12	13	21.50	20.18	20.03	20.20
		25	0	21.50	20.18	20.18	20.08
	64QAM	1	0	21.50	20.55	20.64	20.49
		1	13	21.50	20.44	20.53	20.44
		1	24	21.50	20.32	20.53	20.59
		12	0	21.50	20.04	20.15	20.21
		12	6	21.50	20.13	20.15	20.14
		12	13	21.50	20.19	20.34	20.22
		25	0	21.50	20.34	20.19	20.14
Bandwidth	Modulation	RB size	RB offset	Tune-up	Channel	Channel	Channel
10MHz	QPSK	1	0	21.50	20.46	20.44	20.39
		1	25	21.50	20.53	20.20	20.44
		1	49	21.50	20.51	20.40	20.32
		25	0	21.50	20.26	20.37	20.31
		25	13	21.50	20.27	20.23	20.31
		25	25	21.50	20.27	20.40	20.30
		50	0	21.50	20.21	20.43	20.17
	16QAM	1	0	21.50	20.61	20.48	20.49
		1	25	21.50	20.45	20.49	20.58
		1	49	21.50	20.31	20.30	20.45
		25	0	21.50	20.18	20.30	20.18
		25	13	21.50	20.17	20.11	20.11
		25	25	21.50	20.17	20.25	20.14
		50	0	21.50	20.21	20.08	20.26
	64QAM	1	0	21.50	20.60	20.48	20.56
		1	25	21.50	20.60	20.57	20.61
		1	49	21.50	20.59	20.48	20.42
		25	0	21.50	20.15	20.25	20.17
		25	13	21.50	20.14	20.12	20.19
		25	25	21.50	20.16	20.26	20.16
		50	0	21.50	20.08	20.28	20.28
Bandwidth	Modulation	RB size	RB offset	Tune-up	Channel	Channel	Channel
				Max.	20000CH	20175CH	20350CH

Bandwidth	Modulation	RB size	RB offset	Tune-up	Channel	Channel	Channel
				Max.	20025CH	20175CH	20325CH
15MHz	QPSK	1	0	21.50	20.23	20.41	20.45
		1	38	21.50	20.21	20.38	20.38
		1	74	21.50	20.24	20.40	20.39
		36	0	21.50	20.39	20.41	20.38
		36	18	21.50	20.40	20.46	20.39
		36	39	21.50	20.38	20.42	20.39
		75	0	21.50	20.38	20.26	20.22
	16QAM	1	0	21.50	20.57	20.44	20.58
		1	38	21.50	20.41	20.34	20.55
		1	74	21.50	20.29	20.53	20.47
		36	0	21.50	20.30	20.27	20.22
		36	18	21.50	20.37	20.40	20.21
		36	39	21.50	20.37	20.35	20.22
		75	0	21.50	20.15	20.09	20.14
	64QAM	1	0	21.50	20.54	20.24	20.37
		1	38	21.50	20.41	20.37	20.41
		1	74	21.50	20.35	20.37	20.61
		36	0	21.50	20.19	20.33	20.16
		36	18	21.50	20.22	20.33	20.21
		36	39	21.50	20.17	20.33	20.22
		75	0	21.50	20.10	20.16	20.33
Bandwidth	Modulation	RB size	RB offset	Tune-up	Channel	Channel	Channel
20MHz	QPSK	1	0	21.50	20.41	20.58	20.73
		1	50	21.50	20.43	20.56	20.71
		1	99	21.50	20.42	20.56	20.70
		50	0	21.50	20.40	20.36	20.37
		50	25	21.50	20.41	20.36	20.38
		50	50	21.50	20.43	20.37	20.38
		100	0	21.50	20.39	20.22	20.32
	16QAM	1	0	21.50	20.71	20.80	20.90
		1	50	21.50	20.83	20.82	20.65
		1	99	21.50	20.78	20.84	20.72
		50	0	21.50	20.33	20.23	20.37
		50	25	21.50	20.38	20.21	20.38
		50	50	21.50	20.36	20.24	20.39
		100	0	21.50	20.20	20.32	20.12
	64QAM	1	0	21.50	20.70	20.65	20.74
		1	50	21.50	20.46	20.71	20.65
		1	99	21.50	20.53	20.69	20.63
		50	0	21.50	20.34	20.22	20.41
		50	25	21.50	20.34	20.43	20.40
		50	50	21.50	20.31	20.47	20.44
		100	0	21.50	20.42	20.24	20.14
Bandwidth	Modulation	RB size	RB offset	Tune-up	Channel	Channel	Channel
20MHz	QPSK	1	0	21.50	20.41	20.58	20.73
		1	50	21.50	20.43	20.56	20.71
		1	99	21.50	20.42	20.56	20.70
		50	0	21.50	20.40	20.36	20.37
		50	25	21.50	20.41	20.36	20.38
		50	50	21.50	20.43	20.37	20.38
		100	0	21.50	20.39	20.22	20.32
	16QAM	1	0	21.50	20.71	20.80	20.90
		1	50	21.50	20.83	20.82	20.65
		1	99	21.50	20.78	20.84	20.72
		50	0	21.50	20.33	20.23	20.37
		50	25	21.50	20.38	20.21	20.38
		50	50	21.50	20.36	20.24	20.39
		100	0	21.50	20.20	20.32	20.12
	64QAM	1	0	21.50	20.70	20.65	20.74
		1	50	21.50	20.46	20.71	20.65
		1	99	21.50	20.53	20.69	20.63
		50	0	21.50	20.34	20.22	20.41
		50	25	21.50	20.34	20.43	20.40
		50	50	21.50	20.31	20.47	20.44
		100	0	21.50	20.42	20.24	20.14

Table 59: Conducted power measurement results of LTE Band 4 (Reduced Power Level D6/D8/D10)

Bandwidth	Modulation	RB size	RB offset	Tune-up	Channel	Channel	Channel
				Max.	19957CH	20175CH	20393CH
1.4MHz	QPSK	1	0	19.50	18.30	18.23	18.21
		1	3	19.50	18.32	18.24	18.19
		1	5	19.50	18.31	18.21	18.21
		3	0	19.50	18.26	18.41	18.37
		3	2	19.50	18.24	18.40	18.23
		3	3	19.50	18.24	18.40	18.36
		6	0	19.50	18.07	18.35	18.18
	16QAM	1	0	19.50	18.64	18.24	18.31
		1	3	19.50	18.34	18.34	18.35
		1	5	19.50	18.73	18.26	18.12
		3	0	19.50	18.30	18.15	18.18
		3	2	19.50	18.29	18.23	18.25
		3	3	19.50	18.24	18.37	18.17
		6	0	19.50	18.19	18.37	18.14
	64QAM	1	0	19.50	18.38	18.65	18.47
		1	3	19.50	18.50	18.56	18.44
		1	5	19.50	18.46	18.58	18.42
		3	0	19.50	18.17	18.49	18.56
		3	2	19.50	18.22	18.45	18.48
		3	3	19.50	18.25	18.43	18.38
		6	0	19.50	18.18	18.19	18.21
Bandwidth	Modulation	RB size	RB offset	Tune-up	Channel	Channel	Channel
3MHz	QPSK	1	0	19.50	18.39	18.35	18.22
		1	7	19.50	18.37	18.35	18.30
		1	14	19.50	18.42	18.38	18.28
		8	0	19.50	18.30	18.28	18.11
		8	4	19.50	18.26	18.29	18.09
		8	7	19.50	18.28	18.29	18.11
		15	0	19.50	18.29	18.37	18.34
	16QAM	1	0	19.50	18.56	18.56	18.32
		1	7	19.50	18.32	18.54	18.20
		1	14	19.50	18.40	18.32	18.53
		8	0	19.50	18.14	18.30	18.34
		8	4	19.50	18.12	18.20	18.32
		8	7	19.50	18.11	18.21	18.31
		15	0	19.50	18.08	18.26	18.35
	64QAM	1	0	19.50	18.38	18.35	18.29
		1	7	19.50	18.41	18.45	18.14
		1	14	19.50	18.54	18.45	18.29
		8	0	19.50	18.19	18.22	18.25
		8	4	19.50	18.21	18.18	18.26
		8	7	19.50	18.20	18.41	18.28
		15	0	19.50	18.19	18.29	18.13
Bandwidth	Modulation	RB size	RB offset	Tune-up	Channel	Channel	Channel
				Max.	19965CH	20175CH	20385CH

Bandwidth	Modulation	RB size	RB offset	Tune-up	Channel	Channel	Channel
				Max.	19975CH	20175CH	20375CH
5MHz	QPSK	1	0	19.50	18.36	18.13	18.18
		1	13	19.50	18.38	18.16	18.18
		1	24	19.50	18.35	18.14	18.17
		12	0	19.50	18.36	18.38	18.16
		12	6	19.50	18.35	18.38	18.16
		12	13	19.50	18.35	18.40	18.15
		25	0	19.50	18.36	18.42	18.29
	16QAM	1	0	19.50	18.49	18.53	18.33
		1	13	19.50	18.58	18.56	18.44
		1	24	19.50	18.63	18.51	18.42
		12	0	19.50	18.21	18.34	18.38
		12	6	19.50	18.15	18.33	18.36
		12	13	19.50	18.16	18.40	18.28
		25	0	19.50	18.11	18.18	18.25
	64QAM	1	0	19.50	18.30	18.62	18.16
		1	13	19.50	18.62	18.39	18.24
		1	24	19.50	18.57	18.52	18.34
		12	0	19.50	18.26	18.36	18.27
		12	6	19.50	18.27	18.30	18.25
		12	13	19.50	18.20	18.36	18.33
		25	0	19.50	18.14	18.22	18.09
Bandwidth	Modulation	RB size	RB offset	Tune-up	Channel	Channel	Channel
10MHz	QPSK	1	0	19.50	18.42	18.16	18.39
		1	25	19.50	18.34	18.19	18.25
		1	49	19.50	18.39	18.18	18.47
		25	0	19.50	18.24	18.36	18.35
		25	13	19.50	18.23	18.35	18.37
		25	25	19.50	18.23	18.37	18.38
		50	0	19.50	18.16	18.16	18.33
	16QAM	1	0	19.50	18.33	18.46	18.45
		1	25	19.50	18.32	18.40	18.40
		1	49	19.50	18.46	18.41	18.47
		25	0	19.50	18.20	18.16	18.30
		25	13	19.50	18.17	18.36	18.25
		25	25	19.50	18.19	18.38	18.31
		50	0	19.50	18.20	18.21	18.29
	64QAM	1	0	19.50	18.48	18.26	18.60
		1	25	19.50	18.41	18.25	18.59
		1	49	19.50	18.66	18.19	18.51
		25	0	19.50	18.17	18.37	18.29
		25	13	19.50	18.20	18.38	18.21
		25	25	19.50	18.21	18.33	18.17
		50	0	19.50	18.24	18.07	18.29
Bandwidth	Modulation	RB size	RB offset	Tune-up	Channel	Channel	Channel
				Max.	20000CH	20175CH	20350CH

Bandwidth	Modulation	RB size	RB offset	Tune-up	Channel	Channel	Channel
				Max.	20025CH	20175CH	20325CH
15MHz	QPSK	1	0	19.50	18.35	18.36	18.45
		1	38	19.50	18.38	18.37	18.47
		1	74	19.50	18.35	18.40	18.43
		36	0	19.50	18.42	18.22	18.40
		36	18	19.50	18.34	18.21	18.39
		36	39	19.50	18.40	18.23	18.40
		75	0	19.50	18.21	18.33	18.36
	16QAM	1	0	19.50	18.36	18.52	18.48
		1	38	19.50	18.45	18.35	18.51
		1	74	19.50	18.38	18.49	18.50
		36	0	19.50	18.18	18.15	18.26
		36	18	19.50	18.15	18.12	18.24
		36	39	19.50	18.29	18.15	18.24
		75	0	19.50	18.16	18.14	18.11
	64QAM	1	0	19.50	18.17	18.44	18.57
		1	38	19.50	18.27	18.48	18.57
		1	74	19.50	18.22	18.45	18.57
		36	0	19.50	18.26	18.35	18.40
		36	18	19.50	18.34	18.35	18.35
		36	39	19.50	18.33	18.35	18.36
		75	0	19.50	18.09	18.21	18.20
Bandwidth	Modulation	RB size	RB offset	Tune-up	Channel	Channel	Channel
20MHz	QPSK	1	0	19.50	18.66	18.62	18.66
		1	50	19.50	18.59	18.60	18.71
		1	99	19.50	18.66	18.57	18.67
		50	0	19.50	18.51	18.31	18.53
		50	25	19.50	18.50	18.31	18.47
		50	50	19.50	18.44	18.42	18.53
		100	0	19.50	18.18	18.39	18.43
	16QAM	1	0	19.50	18.66	18.77	18.42
		1	50	19.50	18.56	18.56	18.51
		1	99	19.50	18.79	18.64	18.91
		50	0	19.50	18.39	18.37	18.40
		50	25	19.50	18.34	18.16	18.35
		50	50	19.50	18.37	18.17	18.38
		100	0	19.50	18.15	18.28	18.33
	64QAM	1	0	19.50	18.63	18.81	18.70
		1	50	19.50	18.64	18.78	18.82
		1	99	19.50	18.69	18.69	18.93
		50	0	19.50	18.41	18.25	18.37
		50	25	19.50	18.39	18.24	18.38
		50	50	19.50	18.41	18.24	18.41
		100	0	19.50	18.10	18.34	18.32
Bandwidth	Modulation	RB size	RB offset	Tune-up	Channel	Channel	Channel
20MHz	QPSK	1	0	19.50	18.66	18.62	18.66
		1	50	19.50	18.59	18.60	18.71
		1	99	19.50	18.66	18.57	18.67
		50	0	19.50	18.51	18.31	18.53
		50	25	19.50	18.50	18.31	18.47
		50	50	19.50	18.44	18.42	18.53
		100	0	19.50	18.18	18.39	18.43
	16QAM	1	0	19.50	18.66	18.77	18.42
		1	50	19.50	18.56	18.56	18.51
		1	99	19.50	18.79	18.64	18.91
		50	0	19.50	18.39	18.37	18.40
		50	25	19.50	18.34	18.16	18.35
		50	50	19.50	18.37	18.17	18.38
		100	0	19.50	18.15	18.28	18.33
	64QAM	1	0	19.50	18.63	18.81	18.70
		1	50	19.50	18.64	18.78	18.82
		1	99	19.50	18.69	18.69	18.93
		50	0	19.50	18.41	18.25	18.37
		50	25	19.50	18.39	18.24	18.38
		50	50	19.50	18.41	18.24	18.41
		100	0	19.50	18.10	18.34	18.32

Table 60: Conducted power measurement results of LTE Band 4 (Reduced Power Level D7)

Bandwidth	Modulation	RB size	RB offset	Tune-up	Channel	Channel	Channel
				Max.	19957CH	20175CH	20393CH
1.4MHz	QPSK	1	0	24.50	23.32	23.38	23.29
		1	3	24.50	23.37	23.21	23.26
		1	5	24.50	23.31	23.24	23.25
		3	0	24.50	23.38	23.36	23.13
		3	2	24.50	23.34	23.38	23.11
		3	3	24.50	23.30	23.38	23.11
		6	0	24.00	22.74	22.70	22.80
	16QAM	1	0	24.00	22.74	22.74	22.85
		1	3	24.00	22.84	22.87	22.88
		1	5	24.00	22.77	23.02	23.00
		3	0	24.00	22.60	22.87	22.64
		3	2	24.00	22.79	22.77	22.73
		3	3	24.00	22.64	22.72	22.66
		6	0	23.00	21.64	21.74	21.81
	64QAM	1	0	23.00	21.83	21.77	21.97
		1	3	23.00	21.83	22.03	22.04
		1	5	23.00	21.77	22.16	21.81
		3	0	23.00	21.75	21.70	21.71
		3	2	23.00	21.79	21.76	21.70
		3	3	23.00	21.89	21.81	21.66
		6	0	22.00	20.57	20.74	20.81
Bandwidth	Modulation	RB size	RB offset	Tune-up	Channel	Channel	Channel
3MHz	QPSK	1	0	24.50	23.34	23.22	23.32
		1	7	24.50	23.35	23.22	23.33
		1	14	24.50	23.33	23.18	23.30
		8	0	24.00	22.80	22.71	22.65
		8	4	24.00	22.82	22.72	22.66
		8	7	24.00	22.81	22.87	22.64
		15	0	24.00	22.73	22.70	22.87
	16QAM	1	0	24.00	22.95	22.84	22.96
		1	7	24.00	23.08	22.93	22.88
		1	14	24.00	22.96	22.78	23.08
		8	0	23.00	21.76	21.67	21.67
		8	4	23.00	21.84	21.69	21.71
		8	7	23.00	21.80	21.67	21.62
		15	0	23.00	21.78	21.60	21.46
	64QAM	1	0	23.00	22.06	21.79	21.94
		1	7	23.00	21.88	21.85	22.11
		1	14	23.00	21.48	21.67	21.99
		8	0	22.00	20.78	20.63	20.67
		8	4	22.00	20.80	20.64	20.71
		8	7	22.00	20.84	20.55	20.68
		15	0	22.00	20.82	20.80	20.57

Bandwidth	Modulation	RB size	RB offset	Tune-up	Channel	Channel	Channel
				Max.	19975CH	20175CH	20375CH
5MHz	QPSK	1	0	24.50	23.35	23.26	23.26
		1	13	24.50	23.33	23.26	23.27
		1	24	24.50	23.32	23.22	23.25
		12	0	24.00	22.57	22.71	22.68
		12	6	24.00	22.58	22.92	22.68
		12	13	24.00	22.57	22.92	22.68
		25	0	24.00	22.63	22.85	22.63
	16QAM	1	0	24.00	22.62	23.01	22.94
		1	13	24.00	23.03	22.85	22.92
		1	24	24.00	23.01	23.08	22.83
		12	0	23.00	21.83	21.86	21.70
		12	6	23.00	21.49	21.90	21.64
		12	13	23.00	21.56	21.62	21.69
		25	0	23.00	21.57	21.64	21.58
	64QAM	1	0	23.00	21.99	22.09	22.00
		1	13	23.00	21.94	22.09	21.99
		1	24	23.00	21.84	21.98	21.86
		12	0	22.00	20.61	20.62	20.70
		12	6	22.00	20.56	20.66	20.65
		12	13	22.00	20.53	20.88	20.74
		25	0	22.00	20.82	20.65	20.62
Bandwidth	Modulation	RB size	RB offset	Tune-up	Channel	Channel	Channel
10MHz	QPSK	1	0	24.50	23.36	23.32	23.31
		1	25	24.50	23.32	23.15	23.34
		1	49	24.50	23.30	23.31	23.24
		25	0	24.00	22.61	22.83	22.69
		25	13	24.00	22.67	22.66	22.66
		25	25	24.00	22.67	22.91	22.67
		50	0	24.00	22.63	22.85	22.59
	16QAM	1	0	24.00	22.96	22.80	22.78
		1	25	24.00	22.83	22.86	22.70
		1	49	24.00	22.87	22.69	22.74
		25	0	23.00	21.61	21.78	21.63
		25	13	23.00	21.54	21.60	21.64
		25	25	23.00	21.58	21.82	21.61
		50	0	23.00	21.59	21.57	21.59
	64QAM	1	0	23.00	22.09	21.70	21.74
		1	25	23.00	22.10	21.79	21.97
		1	49	23.00	21.80	21.71	22.05
		25	0	22.00	20.61	20.83	20.68
		25	13	22.00	20.61	20.60	20.68
		25	25	22.00	20.64	20.85	20.69
		50	0	22.00	20.60	20.82	20.63
Bandwidth	Modulation	RB size	RB offset	Tune-up	Channel	Channel	Channel
10MHz	QPSK	1	0	24.50	23.36	23.32	23.31
		1	25	24.50	23.32	23.15	23.34
		1	49	24.50	23.30	23.31	23.24
		25	0	24.00	22.61	22.83	22.69
		25	13	24.00	22.67	22.66	22.66
		25	25	24.00	22.67	22.91	22.67
		50	0	24.00	22.63	22.85	22.59
	16QAM	1	0	24.00	22.96	22.80	22.78
		1	25	24.00	22.83	22.86	22.70
		1	49	24.00	22.87	22.69	22.74
		25	0	23.00	21.61	21.78	21.63
		25	13	23.00	21.54	21.60	21.64
		25	25	23.00	21.58	21.82	21.61
		50	0	23.00	21.59	21.57	21.59
	64QAM	1	0	23.00	22.09	21.70	21.74
		1	25	23.00	22.10	21.79	21.97
		1	49	23.00	21.80	21.71	22.05
		25	0	22.00	20.61	20.83	20.68
		25	13	22.00	20.61	20.60	20.68
		25	25	22.00	20.64	20.85	20.69
		50	0	22.00	20.60	20.82	20.63

Bandwidth	Modulation	RB size	RB offset	Tune-up	Channel	Channel	Channel
				Max.	20025CH	20175CH	20325CH
15MHz	QPSK	1	0	24.50	23.38	23.20	23.31
		1	38	24.50	23.39	23.21	23.30
		1	74	24.50	23.19	23.18	23.30
		36	0	24.00	22.72	22.89	22.68
		36	18	24.00	22.71	22.89	22.66
		36	39	24.00	22.74	22.90	22.65
		75	0	24.00	22.78	22.70	22.63
	16QAM	1	0	24.00	22.79	22.73	22.86
		1	38	24.00	22.98	22.84	22.90
		1	74	24.00	22.53	22.71	22.74
		36	0	23.00	21.63	21.78	21.60
		36	18	23.00	21.66	21.84	21.59
		36	39	23.00	21.68	21.86	21.59
		75	0	23.00	21.63	21.53	21.60
	64QAM	1	0	23.00	22.10	21.77	21.89
		1	38	23.00	21.85	21.82	21.87
		1	74	23.00	21.97	21.90	21.97
		36	0	22.00	20.69	20.84	20.61
		36	18	22.00	20.70	20.86	20.66
		36	39	22.00	20.63	20.85	20.61
		75	0	22.00	20.68	20.68	20.65
Bandwidth	Modulation	RB size	RB offset	Tune-up	Channel	Channel	Channel
20MHz	QPSK	1	0	24.50	23.58	23.50	23.49
		1	50	24.50	23.55	23.47	23.52
		1	99	24.50	23.56	23.52	23.51
		50	0	24.00	22.76	22.74	22.75
		50	25	24.00	22.77	22.75	22.77
		50	50	24.00	22.76	22.76	22.76
		100	0	24.00	22.72	22.68	22.68
	16QAM	1	0	24.00	23.18	22.93	23.39
		1	50	24.00	23.14	23.00	23.15
		1	99	24.00	23.29	23.02	23.15
		50	0	23.00	21.67	21.71	21.71
		50	25	23.00	21.69	21.68	21.71
		50	50	23.00	21.73	21.66	21.68
		100	0	23.00	21.67	21.75	21.63
	64QAM	1	0	23.00	21.92	21.91	22.10
		1	50	23.00	21.88	21.97	22.21
		1	99	23.00	22.31	22.22	22.19
		50	0	22.00	20.70	20.72	20.73
		50	25	22.00	20.68	20.83	20.69
		50	50	22.00	20.76	20.84	20.71
		100	0	22.00	20.64	20.76	20.68
Bandwidth	Modulation	RB size	RB offset	Tune-up	Channel	Channel	Channel
20MHz	QPSK	1	0	24.50	23.58	23.50	23.49
		1	50	24.50	23.55	23.47	23.52
		1	99	24.50	23.56	23.52	23.51
		50	0	24.00	22.76	22.74	22.75
		50	25	24.00	22.77	22.75	22.77
		50	50	24.00	22.76	22.76	22.76
		100	0	24.00	22.72	22.68	22.68
	16QAM	1	0	24.00	23.18	22.93	23.39
		1	50	24.00	23.14	23.00	23.15
		1	99	24.00	23.29	23.02	23.15
		50	0	23.00	21.67	21.71	21.71
		50	25	23.00	21.69	21.68	21.71
		50	50	23.00	21.73	21.66	21.68
		100	0	23.00	21.67	21.75	21.63
	64QAM	1	0	23.00	21.92	21.91	22.10
		1	50	23.00	21.88	21.97	22.21
		1	99	23.00	22.31	22.22	22.19
		50	0	22.00	20.70	20.72	20.73
		50	25	22.00	20.68	20.83	20.69
		50	50	22.00	20.76	20.84	20.71
		100	0	22.00	20.64	20.76	20.68

Table 61: Conducted power measurement results of LTE Band 4 (Reduced Power Level D1/D3/D9)

Bandwidth	Modulation	RB size	RB offset	Tune-up	Channel	Channel	Channel
				Max.	19957CH	20175CH	20393CH
1.4MHz	QPSK	1	0	22.50	21.25	21.13	21.36
		1	3	22.50	21.25	21.12	21.09
		1	5	22.50	21.25	21.11	21.03
		3	0	22.50	21.41	21.30	21.23
		3	2	22.50	21.39	21.30	21.09
		3	3	22.50	21.18	21.30	21.22
		6	0	22.50	21.14	21.09	21.06
	16QAM	1	0	22.50	21.51	21.39	21.24
		1	3	22.50	21.43	21.33	21.19
		1	5	22.50	21.29	21.16	21.12
		3	0	22.50	21.32	21.36	21.15
		3	2	22.50	21.39	21.30	21.25
		3	3	22.50	21.27	21.06	21.16
		6	0	22.50	21.04	21.42	21.22
	64QAM	1	0	22.50	21.28	21.21	21.19
		1	3	22.50	21.40	21.17	21.25
		1	5	22.50	21.28	21.18	21.20
		3	0	22.50	21.11	21.25	21.24
		3	2	22.50	21.18	21.24	21.23
		3	3	22.50	21.05	21.25	21.29
		6	0	22.00	20.73	20.60	20.62
Bandwidth	Modulation	RB size	RB offset	Tune-up	Channel	Channel	Channel
3MHz	QPSK	1	0	22.50	21.34	21.30	21.16
		1	7	22.50	21.36	21.34	21.13
		1	14	22.50	21.21	21.28	21.14
		8	0	22.50	21.25	21.13	21.12
		8	4	22.50	21.26	21.15	21.26
		8	7	22.50	21.24	21.10	21.27
		15	0	22.50	21.26	21.19	21.14
	16QAM	1	0	22.50	21.43	21.30	21.31
		1	7	22.50	21.24	21.44	21.27
		1	14	22.50	21.26	21.26	21.47
		8	0	22.50	21.09	21.16	21.28
		8	4	22.50	21.05	21.24	21.23
		8	7	22.50	21.02	21.13	21.28
		15	0	22.50	21.05	21.10	21.18
	64QAM	1	0	22.50	21.16	21.16	21.17
		1	7	22.50	21.50	21.14	21.33
		1	14	22.50	21.29	21.30	21.46
		8	0	22.00	20.60	20.59	20.72
		8	4	22.00	20.60	20.61	20.62
		8	7	22.00	20.55	20.84	20.75
		15	0	22.00	20.57	20.68	20.61

Bandwidth	Modulation	RB size	RB offset	Tune-up	Channel	Channel	Channel
				Max.	19975CH	20175CH	20375CH
5MHz	QPSK	1	0	22.50	21.33	21.10	21.32
		1	13	22.50	21.29	21.05	21.35
		1	24	22.50	21.31	21.06	21.38
		12	0	22.50	21.32	21.24	21.33
		12	6	22.50	21.30	21.24	21.32
		12	13	22.50	21.30	21.25	21.31
		25	0	22.50	21.35	21.27	21.12
	16QAM	1	0	22.50	21.29	21.46	21.50
		1	13	22.50	21.59	21.41	21.58
		1	24	22.50	21.71	21.42	21.49
		12	0	22.50	21.16	21.27	21.28
		12	6	22.50	21.17	21.25	21.25
		12	13	22.50	21.13	21.25	21.28
		25	0	22.50	21.10	21.02	20.99
	64QAM	1	0	22.50	21.33	21.46	21.39
		1	13	22.50	21.34	21.46	21.39
		1	24	22.50	21.50	21.48	21.49
		12	0	22.00	20.61	20.91	20.83
		12	6	22.00	20.61	20.90	20.78
		12	13	22.00	20.63	20.90	20.82
		25	0	22.00	20.58	20.62	20.53
Bandwidth	Modulation	RB size	RB offset	Tune-up	Channel	Channel	Channel
10MHz	QPSK	1	0	22.50	21.34	21.45	21.37
		1	25	22.50	21.25	21.41	21.39
		1	49	22.50	21.37	21.43	21.37
		25	0	22.50	21.22	21.20	21.16
		25	13	22.50	21.22	21.20	21.16
		25	25	22.50	21.22	21.20	21.29
		50	0	22.50	21.03	21.34	21.15
	16QAM	1	0	22.50	21.54	21.22	21.58
		1	25	22.50	21.41	21.31	21.36
		1	49	22.50	21.52	21.40	21.37
		25	0	22.50	21.14	21.10	21.12
		25	13	22.50	21.13	21.25	21.09
		25	25	22.50	21.12	21.25	21.12
		50	0	22.50	21.18	21.11	21.23
	64QAM	1	0	22.50	21.50	21.28	21.46
		1	25	22.50	21.18	21.36	21.62
		1	49	22.50	21.55	21.22	21.38
		25	0	22.00	20.63	20.78	20.69
		25	13	22.00	20.68	20.82	20.67
		25	25	22.00	20.61	20.83	20.69
		50	0	22.00	20.63	20.51	20.73
Bandwidth	Modulation	RB size	RB offset	Tune-up	Channel	Channel	Channel
10MHz	QPSK	1	0	22.50	20000CH	20175CH	20350CH
		1	25	22.50	20000CH	20175CH	20350CH
		1	49	22.50	20000CH	20175CH	20350CH
		25	0	22.50	20000CH	20175CH	20350CH
		25	13	22.50	20000CH	20175CH	20350CH
		25	25	22.50	20000CH	20175CH	20350CH
		50	0	22.50	20000CH	20175CH	20350CH
	16QAM	1	0	22.50	20000CH	20175CH	20350CH
		1	25	22.50	20000CH	20175CH	20350CH
		1	49	22.50	20000CH	20175CH	20350CH
		25	0	22.50	20000CH	20175CH	20350CH
		25	13	22.50	20000CH	20175CH	20350CH
		25	25	22.50	20000CH	20175CH	20350CH
		50	0	22.50	20000CH	20175CH	20350CH
	64QAM	1	0	22.50	20000CH	20175CH	20350CH
		1	25	22.50	20000CH	20175CH	20350CH
		1	49	22.50	20000CH	20175CH	20350CH
		25	0	22.00	20000CH	20175CH	20350CH
		25	13	22.00	20000CH	20175CH	20350CH
		25	25	22.00	20000CH	20175CH	20350CH
		50	0	22.00	20000CH	20175CH	20350CH

Bandwidth	Modulation	RB size	RB offset	Tune-up	Channel	Channel	Channel
				Max.	20025CH	20175CH	20325CH
15MHz	QPSK	1	0	22.50	21.36	21.33	21.42
		1	38	22.50	21.32	21.36	21.42
		1	74	22.50	21.31	21.35	21.45
		36	0	22.50	21.37	21.42	21.36
		36	18	22.50	21.31	21.44	21.36
		36	39	22.50	21.36	21.43	21.36
		75	0	22.50	21.07	21.18	21.19
	16QAM	1	0	22.50	21.39	21.44	21.58
		1	38	22.50	21.50	21.38	21.65
		1	74	22.50	21.48	21.27	21.52
		36	0	22.50	21.19	21.29	21.25
		36	18	22.50	21.17	21.31	21.24
		36	39	22.50	21.25	21.32	21.23
		75	0	22.50	21.06	21.32	21.03
	64QAM	1	0	22.50	21.32	21.28	21.52
		1	38	22.50	21.28	21.35	21.62
		1	74	22.50	21.61	21.15	21.38
		36	0	22.00	20.73	20.86	20.66
		36	18	22.00	20.64	20.88	20.65
		36	39	22.00	20.69	20.89	20.66
		75	0	22.00	20.54	20.68	20.65
Bandwidth	Modulation	RB size	RB offset	Tune-up	Channel	Channel	Channel
20MHz	QPSK	1	0	22.50	21.58	21.55	21.58
		1	50	22.50	21.61	21.55	21.60
		1	99	22.50	21.60	21.53	21.63
		50	0	22.50	21.46	21.18	21.46
		50	25	22.50	21.46	21.18	21.46
		50	50	22.50	21.42	21.27	21.44
		100	0	22.50	21.13	21.26	21.29
	16QAM	1	0	22.50	21.67	21.63	21.79
		1	50	22.50	21.80	21.56	21.90
		1	99	22.50	21.77	21.72	21.84
		50	0	22.50	21.35	21.44	21.39
		50	25	22.50	21.36	21.04	21.34
		50	50	22.50	21.33	21.02	21.37
		100	0	22.50	21.12	21.13	21.12
	64QAM	1	0	22.50	21.58	21.42	21.62
		1	50	22.50	21.47	21.57	21.54
		1	99	22.50	21.57	21.50	21.65
		50	0	22.00	20.77	20.81	20.67
		50	25	22.00	20.77	20.84	20.68
		50	50	22.00	20.77	20.82	20.68
		100	0	22.00	20.61	20.84	20.64

Table 62: Conducted power measurement results of LTE Band 4 (Reduced Power Level D2)

7.1.15 Conducted power measurements of LTE Band 5(Second antenna)

Bandwidth	Modulation	RB size	RB offset	Tune-up	Channel	Channel	Channel
				Max.	20407CH	20525CH	20643CH
1.4MHz	QPSK	1	0	18.50	17.85	17.80	17.82
		1	3	18.50	17.84	17.78	17.81
		1	5	18.50	17.80	17.86	17.81
		3	0	18.50	17.62	17.75	17.60
		3	2	18.50	17.62	17.58	17.59
		3	3	18.50	17.76	17.59	17.60
		6	0	18.50	17.81	17.76	17.74
	16QAM	1	0	18.50	18.03	17.71	17.78
		1	3	18.50	18.06	17.76	17.78
		1	5	18.50	17.91	17.90	17.92
		3	0	18.50	17.77	17.74	17.48
		3	2	18.50	17.84	17.71	17.53
		3	3	18.50	17.49	17.76	17.79
		6	0	18.50	17.78	17.80	17.78
	64QAM	1	0	18.50	17.88	17.86	17.69
		1	3	18.50	17.60	17.83	17.79
		1	5	18.50	17.61	17.87	17.98
		3	0	18.50	17.71	17.67	17.47
		3	2	18.50	17.72	17.75	17.78
		3	3	18.50	17.82	17.72	17.68
		6	0	18.50	17.73	17.68	17.44
Bandwidth	Modulation	RB size	RB offset	Tune-up	Channel	Channel	Channel
3MHz	QPSK	1	0	18.50	17.74	17.71	17.72
		1	7	18.50	17.70	17.77	17.74
		1	14	18.50	17.70	17.80	17.77
		8	0	18.50	17.73	17.56	17.80
		8	4	18.50	17.71	17.54	17.81
		8	7	18.50	17.71	17.52	17.80
		15	0	18.50	17.74	17.83	17.59
	16QAM	1	0	18.50	17.81	17.82	17.92
		1	7	18.50	17.85	17.95	18.01
		1	14	18.50	17.85	18.08	17.99
		8	0	18.50	17.52	17.75	17.72
		8	4	18.50	17.57	17.71	17.64
		8	7	18.50	17.57	17.79	17.66
		15	0	18.50	17.54	17.89	17.65
	64QAM	1	0	18.50	17.70	17.51	17.63
		1	7	18.50	17.53	17.62	17.79
		1	14	18.50	17.50	17.51	18.05
		8	0	18.50	17.86	17.71	17.54
		8	4	18.50	17.86	17.69	17.47
		8	7	18.50	17.46	17.59	17.48
		15	0	18.50	17.86	17.82	17.67
Bandwidth	Modulation	RB size	RB offset	Tune-up	Channel	Channel	Channel
				Max.	20415CH	20525CH	20635CH

Bandwidth	Modulation	RB size	RB offset	Tune-up	Channel	Channel	Channel
				Max.	20425CH	20525CH	20625CH
5MHz	QPSK	1	0	18.50	17.78	17.76	17.83
		1	13	18.50	17.76	17.77	17.81
		1	24	18.50	17.73	17.82	17.83
		12	0	18.50	17.80	17.90	17.77
		12	6	18.50	17.80	17.86	17.76
		12	13	18.50	17.80	17.87	17.80
		25	0	18.50	17.74	17.72	17.78
	16QAM	1	0	18.50	17.77	17.61	17.69
		1	13	18.50	17.89	18.07	17.60
		1	24	18.50	17.99	17.87	17.70
		12	0	18.50	17.55	17.73	17.65
		12	6	18.50	17.55	17.72	17.68
		12	13	18.50	17.61	17.53	17.63
		25	0	18.50	17.64	17.60	17.74
	64QAM	1	0	18.50	17.67	17.79	18.09
		1	13	18.50	17.71	17.68	17.83
		1	24	18.50	17.65	17.57	17.97
		12	0	18.50	17.52	17.72	17.61
		12	6	18.50	17.56	17.71	17.59
		12	13	18.50	17.56	17.75	17.60
		25	0	18.50	17.51	17.50	17.76
Bandwidth	Modulation	RB size	RB offset	Tune-up	Channel	Channel	Channel
10MHz	QPSK	1	0	18.50	17.74	17.87	17.93
		1	25	18.50	17.73	17.92	17.89
		1	49	18.50	17.79	17.91	17.94
		25	0	18.50	17.84	17.78	17.84
		25	13	18.50	17.83	17.76	17.81
		25	25	18.50	17.83	17.79	17.86
		50	0	18.50	17.59	17.77	17.86
	16QAM	1	0	18.50	17.66	17.68	17.83
		1	25	18.50	18.09	18.03	17.63
		1	49	18.50	17.91	17.72	17.79
		25	0	18.50	17.73	17.68	17.68
		25	13	18.50	17.76	17.52	17.68
		25	25	18.50	17.73	17.52	17.66
		50	0	18.50	17.77	17.83	17.45
	64QAM	1	0	18.50	17.99	17.94	17.56
		1	25	18.50	17.90	17.71	17.51
		1	49	18.50	17.93	17.65	17.65
		25	0	18.50	17.61	17.86	17.53
		25	13	18.50	17.62	17.46	17.70
		25	25	18.50	17.60	17.47	17.49
		50	0	18.50	17.67	17.60	17.79

Table 63: Conducted power measurement results of LTE Band 5 (Reduced Power Level D1/D3)

Bandwidth	Modulation	RB size	RB offset	Tune-up	Channel	Channel	Channel	
				Max.	20407CH	20525CH	20643CH	
1.4MHz	QPSK	1	0	24.50	23.60	23.57	23.54	
		1	3	24.50	23.60	23.59	23.57	
		1	5	24.50	23.59	23.49	23.56	
		3	0	24.50	23.72	23.47	23.60	
		3	2	24.50	23.72	23.59	23.59	
		3	3	24.50	23.59	23.60	23.59	
	16QAM	6	0	23.50	22.74	22.66	22.66	
		1	0	23.50	22.86	22.70	22.71	
		1	3	23.50	22.68	22.61	22.50	
		1	5	23.50	22.81	22.67	22.82	
		3	0	23.50	22.78	22.64	22.69	
		3	2	23.50	22.76	22.71	22.65	
	64QAM	3	3	23.50	22.72	22.62	22.61	
		6	0	22.50	21.66	21.45	21.56	
		1	0	22.50	21.79	21.77	21.79	
		1	3	22.50	21.85	21.70	21.82	
		1	5	22.50	21.86	21.60	21.53	
		3	0	22.50	21.83	21.75	21.66	
	3MHz	QPSK	3	2	22.50	21.46	21.75	21.78
			3	3	22.50	21.50	21.82	21.87
			6	0	21.50	20.64	20.55	20.72
1			0	24.50	23.54	23.59	23.72	
1			7	24.50	23.56	23.75	23.66	
1			14	24.50	23.56	23.77	23.68	
16QAM		8	0	23.50	22.67	22.42	22.44	
		8	4	23.50	22.68	22.47	22.38	
		8	7	23.50	22.68	22.44	22.44	
		15	0	23.50	22.49	22.80	22.54	
		1	0	23.50	22.66	22.71	22.82	
		1	7	23.50	22.70	22.70	22.94	
64QAM	1	14	23.50	22.76	22.86	22.88		
	8	0	22.50	21.68	21.47	21.35		
	8	4	22.50	21.70	21.38	21.72		
	8	7	22.50	21.63	21.47	21.43		
	15	0	22.50	21.66	21.81	21.35		
	1	0	22.50	21.79	21.80	21.68		
64QAM	1	7	22.50	21.96	21.55	21.50		
	1	14	22.50	21.74	21.69	21.78		
	8	0	21.50	20.70	20.39	20.75		
	8	4	21.50	20.73	20.40	20.76		
	8	7	21.50	20.50	20.43	20.71		
	15	0	21.50	20.72	20.69	20.46		

Bandwidth	Modulation	RB size	RB offset	Tune-up	Channel	Channel	Channel
				Max.	20425CH	20525CH	20625CH
5MHz	QPSK	1	0	24.50	23.57	23.61	23.43
		1	13	24.50	23.55	23.58	23.47
		1	24	24.50	23.58	23.75	23.42
		12	0	23.50	22.55	22.39	22.76
		12	6	23.50	22.55	22.40	22.77
		12	13	23.50	22.50	22.39	22.74
		25	0	23.50	22.80	22.62	22.71
	16QAM	1	0	23.50	22.76	22.58	22.57
		1	13	23.50	22.67	22.61	22.49
		1	24	23.50	22.85	22.51	22.62
		12	0	22.50	21.51	21.41	21.40
		12	6	22.50	21.46	21.43	21.35
		12	13	22.50	21.42	21.55	21.34
		25	0	22.50	21.77	21.64	21.50
	64QAM	1	0	22.50	21.91	21.64	21.54
		1	13	22.50	21.81	21.44	21.64
		1	24	22.50	21.75	21.42	21.50
		12	0	21.50	20.52	20.43	20.39
		12	6	21.50	20.53	20.41	20.49
		12	13	21.50	20.50	20.42	20.38
		25	0	21.50	20.77	20.68	20.64
Bandwidth	Modulation	RB size	RB offset	Tune-up	Channel	Channel	Channel
10MHz	QPSK	1	0	24.50	23.68	23.52	23.47
		1	25	24.50	23.67	23.53	23.51
		1	49	24.50	23.81	23.56	23.53
		25	0	23.50	22.86	22.76	22.81
		25	13	23.50	22.85	22.61	22.80
		25	25	23.50	22.83	22.76	22.81
		50	0	23.50	22.57	22.75	22.58
	16QAM	1	0	23.50	22.64	22.47	22.48
		1	25	23.50	22.90	22.64	22.58
		1	49	23.50	22.83	22.50	22.58
		25	0	22.50	21.79	21.69	21.33
		25	13	22.50	21.79	21.37	21.32
		25	25	22.50	21.46	21.37	21.40
		50	0	22.50	21.46	21.72	21.58
	64QAM	1	0	22.50	21.85	21.51	21.58
		1	25	22.50	22.00	21.63	21.63
		1	49	22.50	21.66	21.60	21.78
		25	0	21.50	20.44	20.68	20.74
		25	13	21.50	20.46	20.41	20.46
		25	25	21.50	20.50	20.47	20.72
		50	0	21.50	20.51	20.77	20.64

Table 64: Conducted power measurement results of LTE Band 5 (Full Power)

7.1.16 Conducted power measurements of LTE Band 5(Main antenna)

Bandwidth	Modulation	RB size	RB offset	Tune-up	Channel	Channel	Channel	
				Max.	20407CH	20525CH	20643CH	
1.4MHz	QPSK	1	0	25.00	23.70	23.70	23.70	
		1	3	25.00	23.67	23.73	23.74	
		1	5	25.00	23.69	23.69	23.77	
		3	0	25.00	23.68	23.88	23.80	
		3	2	25.00	23.74	23.88	23.79	
		3	3	25.00	23.74	23.88	23.65	
		6	0	24.00	22.69	22.81	22.74	
	16QAM	1	0	24.00	22.66	23.06	22.85	
		1	3	24.00	22.95	22.74	22.76	
		1	5	24.00	22.71	23.13	22.72	
		3	0	24.00	22.62	22.79	22.60	
		3	2	24.00	22.69	22.65	22.78	
		3	3	24.00	22.63	22.87	22.63	
		6	0	23.00	21.73	21.67	21.77	
	64QAM	1	0	23.00	21.90	21.82	21.67	
		1	3	23.00	21.89	21.75	21.80	
		1	5	23.00	21.81	21.64	21.59	
		3	0	23.00	21.78	21.88	21.82	
		3	2	23.00	21.80	21.94	21.79	
		3	3	23.00	21.83	21.85	21.88	
		6	0	22.00	20.79	20.93	20.65	
	Bandwidth	Modulation	RB size	RB offset	Tune-up	Channel	Channel	Channel
	3MHz	QPSK	1	0	25.00	23.75	23.60	23.85
			1	7	25.00	23.75	23.55	23.85
1			14	25.00	23.65	23.90	23.86	
8			0	24.00	22.74	22.69	22.91	
8			4	24.00	22.74	23.02	22.57	
8			7	24.00	22.76	23.01	22.53	
15			0	24.00	22.76	22.93	22.58	
16QAM		1	0	24.00	22.97	22.83	22.75	
		1	7	24.00	22.92	22.83	22.92	
		1	14	24.00	23.02	22.45	22.94	
		8	0	23.00	21.67	21.60	21.80	
		8	4	23.00	21.75	21.55	21.82	
		8	7	23.00	21.74	21.62	21.84	
		15	0	23.00	21.67	21.56	21.65	
64QAM		1	0	23.00	21.83	22.05	21.69	
		1	7	23.00	21.79	21.58	22.05	
		1	14	23.00	21.90	21.83	21.99	
		8	0	22.00	20.75	20.69	20.86	
		8	4	22.00	20.67	20.64	20.79	
		8	7	22.00	20.69	20.70	20.83	
		15	0	22.00	20.70	20.65	20.54	
Bandwidth		Modulation	RB size	RB offset	Tune-up	Channel	Channel	Channel
					Max.	20415CH	20525CH	20635CH

Bandwidth	Modulation	RB size	RB offset	Tune-up	Channel	Channel	Channel
				Max.	20425CH	20525CH	20625CH
5MHz	QPSK	1	0	25.00	23.65	23.92	23.66
		1	13	25.00	23.69	23.97	23.57
		1	24	25.00	23.62	23.98	23.88
		12	0	24.00	22.73	23.03	22.88
		12	6	24.00	22.74	23.02	22.89
		12	13	24.00	22.76	23.04	22.88
		25	0	24.00	22.99	22.71	22.82
	16QAM	1	0	24.00	22.64	23.06	22.71
		1	13	24.00	22.84	23.06	23.05
		1	24	24.00	22.88	23.40	22.69
		12	0	23.00	21.69	21.84	21.85
		12	6	23.00	21.70	22.00	21.91
		12	13	23.00	21.72	22.03	21.86
		25	0	23.00	21.87	21.67	21.78
	64QAM	1	0	23.00	21.77	21.56	21.55
		1	13	23.00	21.73	21.98	21.79
		1	24	23.00	21.71	22.21	21.71
		12	0	22.00	20.70	20.99	20.88
		12	6	22.00	20.71	20.67	20.86
		12	13	22.00	20.74	20.65	20.85
		25	0	22.00	20.95	20.70	20.81
Bandwidth	Modulation	RB size	RB offset	Tune-up	Channel	Channel	Channel
10MHz	QPSK	1	0	25.00	23.81	23.75	23.68
		1	25	25.00	23.92	23.76	23.67
		1	49	25.00	23.88	23.77	23.63
		25	0	24.00	22.99	22.77	22.91
		25	13	24.00	22.98	22.91	22.94
		25	25	24.00	22.98	22.74	22.92
		50	0	24.00	22.62	22.86	22.70
	16QAM	1	0	24.00	23.06	23.02	22.77
		1	25	24.00	22.83	22.82	22.88
		1	49	24.00	22.90	22.94	22.79
		25	0	23.00	21.98	21.86	21.77
		25	13	23.00	22.00	21.65	21.49
		25	25	23.00	22.00	21.67	21.76
		50	0	23.00	21.95	21.78	21.53
	64QAM	1	0	23.00	21.95	21.86	21.79
		1	25	23.00	21.92	21.92	21.69
		1	49	23.00	21.91	21.82	21.80
		25	0	22.00	21.01	20.87	20.52
		25	13	22.00	21.03	20.92	20.52
		25	25	22.00	21.05	20.69	20.49
		50	0	22.00	20.96	20.81	20.59
Bandwidth	Modulation	RB size	RB offset	Tune-up	Channel	Channel	Channel
10MHz	QPSK	1	0	25.00	23.81	23.75	23.68
		1	25	25.00	23.92	23.76	23.67
		1	49	25.00	23.88	23.77	23.63
		25	0	24.00	22.99	22.77	22.91
		25	13	24.00	22.98	22.91	22.94
		25	25	24.00	22.98	22.74	22.92
		50	0	24.00	22.62	22.86	22.70
	16QAM	1	0	24.00	23.06	23.02	22.77
		1	25	24.00	22.83	22.82	22.88
		1	49	24.00	22.90	22.94	22.79
		25	0	23.00	21.98	21.86	21.77
		25	13	23.00	22.00	21.65	21.49
		25	25	23.00	22.00	21.67	21.76
		50	0	23.00	21.95	21.78	21.53
	64QAM	1	0	23.00	21.95	21.86	21.79
		1	25	23.00	21.92	21.92	21.69
		1	49	23.00	21.91	21.82	21.80
		25	0	22.00	21.01	20.87	20.52
		25	13	22.00	21.03	20.92	20.52
		25	25	22.00	21.05	20.69	20.49
		50	0	22.00	20.96	20.81	20.59

Table 65: Conducted power measurement results of LTE Band 5

7.1.17 Conducted power measurements of LTE Band 7(Second antenna)

Bandwidth	Modulation	RB size	RB offset	Tune-up	Channel	Channel	Channel	
				Max.	20775CH	21100CH	21425CH	
5MHz	QPSK	1	0	15.50	14.52	14.56	14.53	
		1	13	15.50	14.46	14.60	14.79	
		1	24	15.50	14.47	14.52	14.54	
		12	0	15.50	14.53	14.74	14.63	
		12	6	15.50	14.60	14.74	14.62	
		12	13	15.50	14.60	14.83	14.63	
		25	0	15.50	14.46	14.73	14.63	
	16QAM	1	0	15.50	14.90	14.69	14.74	
		1	13	15.50	14.55	14.64	14.80	
		1	24	15.50	14.73	14.94	14.76	
		12	0	15.50	14.46	14.56	14.63	
		12	6	15.50	14.46	14.46	14.55	
		12	13	15.50	14.43	14.55	14.72	
		25	0	15.50	14.46	14.46	14.60	
	64QAM	1	0	15.50	14.54	14.58	14.72	
		1	13	15.50	14.85	14.71	14.78	
		1	24	15.50	14.58	14.65	14.76	
		12	0	15.50	14.55	14.81	14.74	
		12	6	15.50	14.54	14.54	14.77	
		12	13	15.50	14.52	14.55	14.77	
		25	0	15.50	14.45	14.67	14.58	
	Bandwidth	Modulation	RB size	RB offset	Tune-up	Channel	Channel	Channel
	10MHz	QPSK	1	0	15.50	14.57	14.69	14.75
			1	25	15.50	14.57	14.70	14.51
1			49	15.50	14.51	14.52	14.76	
25			0	15.50	14.70	14.57	14.61	
25			13	15.50	14.69	14.70	14.60	
25			25	15.50	14.70	14.58	14.64	
50			0	15.50	14.72	14.45	14.79	
16QAM		1	0	15.50	14.73	14.68	14.83	
		1	25	15.50	14.74	14.64	14.91	
		1	49	15.50	14.82	14.54	14.68	
		25	0	15.50	14.47	14.52	14.46	
		25	13	15.50	14.38	14.53	14.55	
		25	25	15.50	14.40	14.66	14.54	
		50	0	15.50	14.40	14.46	14.54	
64QAM		1	0	15.50	14.70	14.43	14.72	
		1	25	15.50	14.40	14.75	14.70	
		1	49	15.50	14.66	14.87	14.71	
		25	0	15.50	14.67	14.52	14.57	
		25	13	15.50	14.62	14.55	14.55	
		25	25	15.50	14.66	14.53	14.56	
		50	0	15.50	14.43	14.69	14.68	
Bandwidth		Modulation	RB size	RB offset	Tune-up	Channel	Channel	Channel
10MHz		QPSK	1	0	15.50	14.57	14.69	14.75
			1	25	15.50	14.57	14.70	14.51
	1		49	15.50	14.51	14.52	14.76	
	25		0	15.50	14.70	14.57	14.61	
	25		13	15.50	14.69	14.70	14.60	
	25		25	15.50	14.70	14.58	14.64	
	50		0	15.50	14.72	14.45	14.79	
	16QAM	1	0	15.50	14.73	14.68	14.83	
		1	25	15.50	14.74	14.64	14.91	
		1	49	15.50	14.82	14.54	14.68	
		25	0	15.50	14.47	14.52	14.46	
		25	13	15.50	14.38	14.53	14.55	
		25	25	15.50	14.40	14.66	14.54	
		50	0	15.50	14.40	14.46	14.54	
	64QAM	1	0	15.50	14.70	14.43	14.72	
		1	25	15.50	14.40	14.75	14.70	
		1	49	15.50	14.66	14.87	14.71	
		25	0	15.50	14.67	14.52	14.57	
		25	13	15.50	14.62	14.55	14.55	
		25	25	15.50	14.66	14.53	14.56	
		50	0	15.50	14.43	14.69	14.68	

Bandwidth	Modulation	RB size	RB offset	Tune-up	Channel	Channel	Channel
				Max.	20825CH	21100CH	21375CH
15MHz	QPSK	1	0	15.50	14.50	14.70	14.86
		1	38	15.50	14.50	14.74	14.85
		1	74	15.50	14.51	14.74	14.84
		36	0	15.50	14.57	14.57	14.83
		36	18	15.50	14.50	14.72	14.80
		36	39	15.50	14.55	14.68	14.82
		75	0	15.50	14.72	14.49	14.71
	16QAM	1	0	15.50	14.70	14.68	14.72
		1	38	15.50	14.73	14.77	14.92
		1	74	15.50	14.76	14.48	14.81
		36	0	15.50	14.60	14.60	14.73
		36	18	15.50	14.61	14.61	14.66
		36	39	15.50	14.60	14.45	14.64
		75	0	15.50	14.59	14.52	14.54
	64QAM	1	0	15.50	14.89	14.62	14.89
		1	38	15.50	14.57	14.63	15.03
		1	74	15.50	14.71	14.68	14.80
		36	0	15.50	14.48	14.54	14.71
		36	18	15.50	14.49	14.57	14.69
		36	39	15.50	14.64	14.48	14.54
		75	0	15.50	14.68	14.55	14.57
Bandwidth	Modulation	RB size	RB offset	Tune-up	Channel	Channel	Channel
20MHz	QPSK	1	0	15.50	14.77	14.62	14.81
		1	50	15.50	14.71	14.92	14.75
		1	99	15.50	14.72	14.91	14.76
		50	0	15.50	14.72	14.77	14.86
		50	25	15.50	14.69	14.74	14.83
		50	50	15.50	14.72	14.76	14.74
		100	0	15.50	14.63	14.49	14.87
	16QAM	1	0	15.50	14.86	14.93	14.99
		1	50	15.50	14.78	14.91	15.04
		1	99	15.50	14.77	14.98	15.06
		50	0	15.50	14.66	14.72	14.71
		50	25	15.50	14.59	14.74	14.76
		50	50	15.50	14.61	14.75	14.77
		100	0	15.50	14.39	14.57	14.60
	64QAM	1	0	15.50	15.02	15.03	14.86
		1	50	15.50	14.97	15.00	14.68
		1	99	15.50	14.96	15.06	14.74
		50	0	15.50	14.55	14.68	14.60
		50	25	15.50	14.57	14.72	14.66
		50	50	15.50	14.54	14.71	14.66
		100	0	15.50	14.55	14.59	14.54

Table 66: Conducted power measurement results of LTE Band 7 (Reduced Power Level D1)

Bandwidth	Modulation	RB size	RB offset	Tune-up	Channel	Channel	Channel
				Max.	20775CH	21100CH	21425CH
5MHz	QPSK	1	0	20.50	19.69	19.56	19.68
		1	13	20.50	19.50	19.78	19.77
		1	24	20.50	19.51	19.74	19.67
		12	0	20.50	19.50	19.75	19.63
		12	6	20.50	19.69	19.74	19.64
		12	13	20.50	19.73	19.76	19.60
		25	0	20.50	19.68	19.71	19.64
	16QAM	1	0	20.50	19.80	19.79	19.86
		1	13	20.50	19.79	19.83	19.96
		1	24	20.50	19.60	19.81	19.96
		12	0	20.50	19.63	19.69	19.72
		12	6	20.50	19.70	19.66	19.74
		12	13	20.50	19.68	19.72	19.58
		25	0	20.50	19.66	19.64	19.56
	64QAM	1	0	20.50	19.82	20.06	19.80
		1	13	20.50	19.53	19.82	19.70
		1	24	20.50	19.76	19.69	19.80
		12	0	20.50	19.11	19.09	19.34
		12	6	20.50	19.16	19.10	19.34
		12	13	20.50	19.19	19.07	19.37
		25	0	20.50	19.04	19.06	19.29
Bandwidth	Modulation	RB size	RB offset	Tune-up	Channel	Channel	Channel
10MHz	QPSK	1	0	20.50	19.59	19.69	19.90
		1	25	20.50	19.75	19.81	19.77
		1	49	20.50	19.73	19.79	19.92
		25	0	20.50	19.55	19.74	19.66
		25	13	20.50	19.56	19.56	19.66
		25	25	20.50	19.56	19.78	19.78
		50	0	20.50	19.50	19.68	19.59
	16QAM	1	0	20.50	19.56	19.60	19.83
		1	25	20.50	19.73	19.85	19.92
		1	49	20.50	19.54	19.80	19.89
		25	0	20.50	19.60	19.66	19.62
		25	13	20.50	19.46	19.70	19.70
		25	25	20.50	19.43	19.52	19.69
		50	0	20.50	19.62	19.48	19.58
	64QAM	1	0	20.50	19.68	19.68	19.76
		1	25	20.50	19.84	19.76	19.68
		1	49	20.50	19.68	19.63	19.91
		25	0	20.50	19.13	19.16	19.13
		25	13	20.50	19.14	19.12	19.10
		25	25	20.50	19.19	19.13	19.16
		50	0	20.50	19.07	19.01	19.31
Bandwidth	Modulation	RB size	RB offset	Tune-up	Channel	Channel	Channel
				Max.	20800CH	21100CH	21400CH

Bandwidth	Modulation	RB size	RB offset	Tune-up	Channel	Channel	Channel
				Max.	20825CH	21100CH	21375CH
15MHz	QPSK	1	0	20.50	19.70	19.63	19.64
		1	38	20.50	19.75	19.64	19.68
		1	74	20.50	19.78	19.65	19.67
		36	0	20.50	19.67	19.68	19.79
		36	18	20.50	19.67	19.58	19.79
		36	39	20.50	19.67	19.78	19.79
		75	0	20.50	19.75	19.58	19.78
	16QAM	1	0	20.50	20.06	19.89	19.75
		1	38	20.50	20.07	19.53	19.97
		1	74	20.50	19.95	19.64	20.03
		36	0	20.50	19.59	19.65	19.73
		36	18	20.50	19.62	19.68	19.58
		36	39	20.50	19.59	19.51	19.61
		75	0	20.50	19.60	19.47	19.59
	64QAM	1	0	20.50	19.80	19.90	19.94
		1	38	20.50	19.69	19.62	19.89
		1	74	20.50	19.73	19.68	19.88
		36	0	20.50	19.06	19.16	19.12
		36	18	20.50	19.03	19.13	19.12
		36	39	20.50	19.01	19.17	19.04
		75	0	20.50	19.01	19.03	19.14
Bandwidth	Modulation	RB size	RB offset	Tune-up	Channel	Channel	Channel
20MHz	QPSK	1	0	20.50	19.80	19.80	20.05
		1	50	20.50	19.93	19.85	19.95
		1	99	20.50	19.99	19.84	19.98
		50	0	20.50	19.58	19.59	19.85
		50	25	20.50	19.58	19.58	19.65
		50	50	20.50	19.58	19.59	19.67
		100	0	20.50	19.71	19.61	19.85
	16QAM	1	0	20.50	20.04	19.98	19.95
		1	50	20.50	19.93	19.94	19.93
		1	99	20.50	20.12	19.95	19.89
		50	0	20.50	19.54	19.70	19.77
		50	25	20.50	19.55	19.69	19.78
		50	50	20.50	19.58	19.71	19.75
		100	0	20.50	19.63	19.73	19.74
	64QAM	1	0	20.50	19.92	19.94	20.01
		1	50	20.50	19.98	19.96	20.00
		1	99	20.50	19.98	19.94	20.03
		50	0	20.50	19.15	19.22	19.32
		50	25	20.50	19.20	19.22	19.31
		50	50	20.50	19.18	19.22	19.35
		100	0	20.50	19.02	19.25	19.10
Bandwidth	Modulation	RB size	RB offset	Tune-up	Channel	Channel	Channel
20MHz	QPSK	1	0	20.50	19.80	19.80	20.05
		1	50	20.50	19.93	19.85	19.95
		1	99	20.50	19.99	19.84	19.98
		50	0	20.50	19.58	19.59	19.85
		50	25	20.50	19.58	19.58	19.65
		50	50	20.50	19.58	19.59	19.67
		100	0	20.50	19.71	19.61	19.85
	16QAM	1	0	20.50	20.04	19.98	19.95
		1	50	20.50	19.93	19.94	19.93
		1	99	20.50	20.12	19.95	19.89
		50	0	20.50	19.54	19.70	19.77
		50	25	20.50	19.55	19.69	19.78
		50	50	20.50	19.58	19.71	19.75
		100	0	20.50	19.63	19.73	19.74
	64QAM	1	0	20.50	19.92	19.94	20.01
		1	50	20.50	19.98	19.96	20.00
		1	99	20.50	19.98	19.94	20.03
		50	0	20.50	19.15	19.22	19.32
		50	25	20.50	19.20	19.22	19.31
		50	50	20.50	19.18	19.22	19.35
		100	0	20.50	19.02	19.25	19.10

Table 67: Conducted power measurement results of LTE Band 7 (Full Power)

Bandwidth	Modulation	RB size	RB offset	Tune-up	Channel	Channel	Channel
				Max.	20775CH	21100CH	21425CH
5MHz	QPSK	1	0	13.50	12.66	12.59	12.57
		1	13	13.50	12.52	12.58	12.74
		1	24	13.50	12.51	12.58	12.83
		12	0	13.50	12.65	12.50	12.65
		12	6	13.50	12.70	12.68	12.62
		12	13	13.50	12.69	12.49	12.64
		25	0	13.50	12.48	12.71	12.60
	16QAM	1	0	13.50	12.70	12.62	12.79
		1	13	13.50	12.79	12.70	12.69
		1	24	13.50	12.67	12.66	12.77
		12	0	13.50	12.45	12.51	12.63
		12	6	13.50	12.44	12.45	12.63
		12	13	13.50	12.54	12.50	12.68
		25	0	13.50	12.40	12.44	12.66
	64QAM	1	0	13.50	12.77	12.56	12.70
		1	13	13.50	12.64	12.63	12.89
		1	24	13.50	12.67	12.73	12.76
		12	0	13.50	12.51	12.82	12.74
		12	6	13.50	12.54	12.43	12.55
		12	13	13.50	12.51	12.50	12.79
		25	0	13.50	12.44	12.74	12.63
Bandwidth	Modulation	RB size	RB offset	Tune-up	Channel	Channel	Channel
10MHz	QPSK	1	0	13.50	12.70	12.73	12.71
		1	25	13.50	12.59	12.70	12.64
		1	49	13.50	12.63	12.49	12.69
		25	0	13.50	12.40	12.59	12.53
		25	13	13.50	12.69	12.64	12.56
		25	25	13.50	12.46	12.59	12.63
		50	0	13.50	12.70	12.54	12.76
	16QAM	1	0	13.50	12.76	12.55	12.75
		1	25	13.50	12.63	12.58	12.61
		1	49	13.50	12.76	12.49	12.58
		25	0	13.50	12.45	12.47	12.46
		25	13	13.50	12.37	12.49	12.55
		25	25	13.50	12.45	12.67	12.58
		50	0	13.50	12.36	12.45	12.57
	64QAM	1	0	13.50	12.53	12.53	12.67
		1	25	13.50	12.59	12.76	12.71
		1	49	13.50	12.62	12.90	12.78
		25	0	13.50	12.59	12.59	12.62
		25	13	13.50	12.61	12.55	12.58
		25	25	13.50	12.58	12.57	12.57
		50	0	13.50	12.41	12.68	12.73

Bandwidth	Modulation	RB size	RB offset	Tune-up	Channel	Channel	Channel
				Max.	20825CH	21100CH	21375CH
15MHz	QPSK	1	0	13.50	12.57	12.78	12.92
		1	38	13.50	12.57	12.82	12.91
		1	74	13.50	12.58	12.81	12.85
		36	0	13.50	12.53	12.57	12.75
		36	18	13.50	12.54	12.72	12.75
		36	39	13.50	12.57	12.62	12.75
		75	0	13.50	12.74	12.56	12.64
	16QAM	1	0	13.50	12.83	12.50	12.71
		1	38	13.50	12.66	12.46	12.70
		1	74	13.50	12.74	12.44	12.86
		36	0	13.50	12.54	12.51	12.65
		36	18	13.50	12.54	12.48	12.57
		36	39	13.50	12.54	12.37	12.58
		75	0	13.50	12.59	12.48	12.59
	64QAM	1	0	13.50	12.57	12.48	12.92
		1	38	13.50	12.76	12.60	12.97
		1	74	13.50	12.62	12.51	12.80
		36	0	13.50	12.48	12.52	12.72
		36	18	13.50	12.45	12.54	12.64
		36	39	13.50	12.56	12.56	12.77
		75	0	13.50	12.66	12.50	12.57
Bandwidth	Modulation	RB size	RB offset	Tune-up	Channel	Channel	Channel
20MHz	QPSK	1	0	13.50	12.88	12.71	12.94
		1	50	13.50	12.75	12.92	12.78
		1	99	13.50	12.78	12.95	12.81
		50	0	13.50	12.71	12.76	12.88
		50	25	13.50	12.51	12.75	12.67
		50	50	13.50	12.51	12.76	12.66
		100	0	13.50	12.70	12.55	12.84
	16QAM	1	0	13.50	12.84	13.09	13.13
		1	50	13.50	12.88	13.12	13.04
		1	99	13.50	12.95	13.07	13.12
		50	0	13.50	12.60	12.70	12.63
		50	25	13.50	12.60	12.68	12.66
		50	50	13.50	12.62	12.72	12.64
		100	0	13.50	12.34	12.54	12.53
	64QAM	1	0	13.50	13.07	12.91	12.96
		1	50	13.50	12.60	13.09	13.12
		1	99	13.50	12.96	12.90	13.01
		50	0	13.50	12.49	12.74	12.59
		50	25	13.50	12.50	12.72	12.60
		50	50	13.50	12.50	12.75	12.53
		100	0	13.50	12.44	12.46	12.56

Table 68: Conducted power measurement results of LTE Band 7 (Reduced Power Level D3)

Bandwidth	Modulation	RB size	RB offset	Tune-up	Channel	Channel	Channel
				Max.	20775CH	21100CH	21425CH
5MHz	QPSK	1	0	18.50	17.73	17.56	17.69
		1	13	18.50	17.73	17.78	17.82
		1	24	18.50	17.74	17.70	17.65
		12	0	18.50	17.78	17.69	17.77
		12	6	18.50	17.75	17.68	17.76
		12	13	18.50	17.76	17.80	17.74
		25	0	18.50	17.65	17.69	17.77
	16QAM	1	0	18.50	17.82	17.69	18.03
		1	13	18.50	17.91	17.89	17.92
		1	24	18.50	17.86	17.74	17.90
		12	0	18.50	17.80	17.78	17.76
		12	6	18.50	17.77	17.75	17.77
		12	13	18.50	17.76	17.80	17.85
		25	0	18.50	17.65	17.71	17.71
	64QAM	1	0	18.50	17.80	17.87	17.85
		1	13	18.50	17.81	17.88	17.75
		1	24	18.50	17.72	17.94	17.82
		12	0	18.50	17.66	17.70	17.86
		12	6	18.50	17.72	17.57	17.82
		12	13	18.50	17.67	17.67	17.79
		25	0	18.50	17.65	17.77	17.77
Bandwidth	Modulation	RB size	RB offset	Tune-up	Channel	Channel	Channel
10MHz	QPSK	1	0	18.50	17.64	17.69	17.88
		1	25	18.50	17.81	17.71	17.75
		1	49	18.50	17.82	17.75	17.81
		25	0	18.50	17.62	17.78	17.75
		25	13	18.50	17.62	17.57	17.74
		25	25	18.50	17.61	17.79	17.81
		50	0	18.50	17.76	17.70	17.65
	16QAM	1	0	18.50	17.59	17.72	17.96
		1	25	18.50	18.08	17.79	17.99
		1	49	18.50	17.84	17.94	17.91
		25	0	18.50	17.60	17.69	17.65
		25	13	18.50	17.48	17.79	17.73
		25	25	18.50	17.43	17.67	17.73
		50	0	18.50	17.65	17.51	17.60
	64QAM	1	0	18.50	17.93	17.72	17.75
		1	25	18.50	17.75	17.64	17.95
		1	49	18.50	17.63	17.57	17.95
		25	0	18.50	17.69	17.64	17.58
		25	13	18.50	17.68	17.67	17.62
		25	25	18.50	17.74	17.63	17.66
		50	0	18.50	17.65	17.75	17.74
Bandwidth	Modulation	RB size	RB offset	Tune-up	Channel	Channel	Channel
10MHz	QPSK	1	0	18.50	17.64	17.69	17.88
		1	25	18.50	17.81	17.71	17.75
		1	49	18.50	17.82	17.75	17.81
		25	0	18.50	17.62	17.78	17.75
		25	13	18.50	17.62	17.57	17.74
		25	25	18.50	17.61	17.79	17.81
		50	0	18.50	17.76	17.70	17.65
	16QAM	1	0	18.50	17.59	17.72	17.96
		1	25	18.50	18.08	17.79	17.99
		1	49	18.50	17.84	17.94	17.91
		25	0	18.50	17.60	17.69	17.65
		25	13	18.50	17.48	17.79	17.73
		25	25	18.50	17.43	17.67	17.73
		50	0	18.50	17.65	17.51	17.60
	64QAM	1	0	18.50	17.93	17.72	17.75
		1	25	18.50	17.75	17.64	17.95
		1	49	18.50	17.63	17.57	17.95
		25	0	18.50	17.69	17.64	17.58
		25	13	18.50	17.68	17.67	17.62
		25	25	18.50	17.74	17.63	17.66
		50	0	18.50	17.65	17.75	17.74

Bandwidth	Modulation	RB size	RB offset	Tune-up	Channel	Channel	Channel
				Max.	20825CH	21100CH	21375CH
15MHz	QPSK	1	0	18.50	17.77	17.67	17.70
		1	38	18.50	17.80	17.67	17.72
		1	74	18.50	17.77	17.72	17.75
		36	0	18.50	17.74	17.66	17.81
		36	18	18.50	17.74	17.60	17.83
		36	39	18.50	17.73	17.81	17.83
		75	0	18.50	17.77	17.57	17.81
	16QAM	1	0	18.50	17.81	17.38	17.86
		1	38	18.50	17.95	17.80	18.03
		1	74	18.50	17.85	17.77	17.88
		36	0	18.50	17.68	17.78	17.73
		36	18	18.50	17.71	17.79	17.61
		36	39	18.50	17.69	17.63	17.63
		75	0	18.50	17.63	17.51	17.66
	64QAM	1	0	18.50	17.86	17.51	17.87
		1	38	18.50	17.68	17.86	18.26
		1	74	18.50	17.74	17.65	18.00
		36	0	18.50	17.47	17.64	17.59
		36	18	18.50	17.57	17.65	17.58
		36	39	18.50	17.68	17.67	17.83
		75	0	18.50	17.65	17.51	17.63
Bandwidth	Modulation	RB size	RB offset	Tune-up	Channel	Channel	Channel
20MHz	QPSK	1	0	18.50	17.91	17.92	17.96
		1	50	18.50	17.95	17.93	17.96
		1	99	18.50	17.95	17.92	18.02
		50	0	18.50	17.67	17.60	17.89
		50	25	18.50	17.67	17.60	17.70
		50	50	18.50	17.67	17.63	17.72
		100	0	18.50	17.70	17.59	17.84
	16QAM	1	0	18.50	18.08	17.91	18.08
		1	50	18.50	18.07	18.05	18.04
		1	99	18.50	18.05	18.01	18.09
		50	0	18.50	17.62	17.74	17.79
		50	25	18.50	17.64	17.77	17.80
		50	50	18.50	17.65	17.75	17.80
		100	0	18.50	17.65	17.73	17.73
	64QAM	1	0	18.50	17.85	17.93	18.00
		1	50	18.50	18.00	17.97	18.04
		1	99	18.50	17.92	18.09	17.90
		50	0	18.50	17.70	17.69	17.80
		50	25	18.50	17.67	17.72	17.81
		50	50	18.50	17.70	17.73	17.77
		100	0	18.50	17.68	17.80	17.81

Table 69: Conducted power measurement results of LTE Band 7 (Reduced Power Level D2)

7.1.18 Conducted power measurements of LTE Band 7(Main antenna)

Bandwidth	Modulation	RB size	RB offset	Tune-up	Channel	Channel	Channel
				Max.	20775CH	21100CH	21425CH
5MHz	QPSK	1	0	24.50	23.31	23.43	23.55
		1	13	24.50	23.28	23.39	23.47
		1	24	24.50	23.29	23.44	23.48
		12	0	23.50	22.10	22.64	22.42
		12	6	23.50	22.16	22.64	22.42
		12	13	23.50	22.15	22.63	22.43
		25	0	23.50	22.06	22.43	22.47
	16QAM	1	0	23.50	22.62	22.53	22.51
		1	13	23.50	22.47	22.88	22.56
		1	24	23.50	22.36	22.58	22.66
		12	0	22.50	21.18	21.51	21.41
		12	6	22.50	21.14	21.51	21.44
		12	13	22.50	21.08	21.53	21.35
		25	0	22.50	21.13	21.41	21.47
	64QAM	1	0	22.50	21.24	21.70	21.58
		1	13	22.50	21.35	21.69	21.68
		1	24	22.50	21.24	21.50	21.65
		12	0	21.50	20.11	20.53	20.51
		12	6	21.50	20.16	20.48	20.43
		12	13	21.50	20.19	20.50	20.41
		25	0	21.50	20.15	20.50	20.45
Bandwidth	Modulation	RB size	RB offset	Tune-up	Channel	Channel	Channel
10MHz	QPSK	1	0	24.50	23.14	23.64	23.48
		1	25	24.50	23.09	23.36	23.53
		1	49	24.50	23.19	23.62	23.53
		25	0	23.50	22.10	22.52	22.42
		25	13	23.50	22.09	22.49	22.43
		25	25	23.50	22.12	22.49	22.51
		50	0	23.50	22.09	22.44	22.52
	16QAM	1	0	23.50	22.54	22.63	22.54
		1	25	23.50	22.58	22.60	22.43
		1	49	23.50	22.49	22.56	22.44
		25	0	22.50	21.09	21.37	21.34
		25	13	22.50	21.05	21.35	21.48
		25	25	22.50	21.04	21.46	21.55
		50	0	22.50	21.05	21.37	21.42
	64QAM	1	0	22.50	21.30	21.76	21.70
		1	25	22.50	21.42	21.50	21.79
		1	49	22.50	21.38	21.68	21.74
		25	0	21.50	20.15	20.53	20.49
		25	13	21.50	20.29	20.39	20.48
		25	25	21.50	20.29	20.44	20.48
		50	0	21.50	20.36	20.63	20.46

Bandwidth	Modulation	RB size	RB offset	Tune-up	Channel	Channel	Channel
				Max.	20825CH	21100CH	21375CH
15MHz	QPSK	1	0	24.50	23.13	23.41	23.58
		1	38	24.50	23.14	23.38	23.59
		1	74	24.50	23.20	23.38	23.58
		36	0	23.50	22.28	22.45	22.44
		36	18	23.50	22.24	22.44	22.50
		36	39	23.50	22.23	22.49	22.44
		75	0	23.50	22.24	22.65	22.51
	16QAM	1	0	23.50	22.39	22.36	22.54
		1	38	23.50	22.30	22.37	22.57
		1	74	23.50	22.52	22.45	22.66
		36	0	22.50	21.22	21.42	21.42
		36	18	22.50	21.17	21.37	21.40
		36	39	22.50	21.18	21.39	21.38
		75	0	22.50	21.15	21.57	21.44
	64QAM	1	0	22.50	21.60	21.86	21.54
		1	38	22.50	21.43	21.70	21.50
		1	74	22.50	21.38	21.66	21.57
		36	0	21.50	20.16	20.41	20.60
		36	18	21.50	20.15	20.41	20.60
		36	39	21.50	20.15	20.35	20.61
		75	0	21.50	20.13	20.69	20.41
Bandwidth	Modulation	RB size	RB offset	Tune-up	Channel	Channel	Channel
20MHz	QPSK	1	0	24.50	23.61	23.57	23.61
		1	50	24.50	23.58	23.54	23.66
		1	99	24.50	23.60	23.55	23.65
		50	0	23.50	22.24	22.51	22.58
		50	25	23.50	22.28	22.50	22.55
		50	50	23.50	22.26	22.50	22.49
		100	0	23.50	22.14	22.67	22.57
	16QAM	1	0	23.50	22.79	22.75	22.79
		1	50	23.50	22.80	22.74	22.78
		1	99	23.50	22.65	22.85	22.83
		50	0	22.50	21.22	21.68	21.50
		50	25	22.50	21.23	21.67	21.47
		50	50	22.50	21.21	21.64	21.46
		100	0	22.50	21.13	21.63	21.48
	64QAM	1	0	22.50	21.59	21.72	22.24
		1	50	22.50	21.69	21.73	22.03
		1	99	22.50	21.68	21.65	21.92
		50	0	21.50	20.21	20.60	20.43
		50	25	21.50	20.16	20.59	20.64
		50	50	21.50	20.23	20.58	20.46
		100	0	21.50	20.20	20.53	20.42
Bandwidth	Modulation	RB size	RB offset	Tune-up	Channel	Channel	Channel
20MHz	QPSK	1	0	24.50	23.61	23.57	23.61
		1	50	24.50	23.58	23.54	23.66
		1	99	24.50	23.60	23.55	23.65
		50	0	23.50	22.24	22.51	22.58
		50	25	23.50	22.28	22.50	22.55
		50	50	23.50	22.26	22.50	22.49
		100	0	23.50	22.14	22.67	22.57
	16QAM	1	0	23.50	22.79	22.75	22.79
		1	50	23.50	22.80	22.74	22.78
		1	99	23.50	22.65	22.85	22.83
		50	0	22.50	21.22	21.68	21.50
		50	25	22.50	21.23	21.67	21.47
		50	50	22.50	21.21	21.64	21.46
		100	0	22.50	21.13	21.63	21.48
	64QAM	1	0	22.50	21.59	21.72	22.24
		1	50	22.50	21.69	21.73	22.03
		1	99	22.50	21.68	21.65	21.92
		50	0	21.50	20.21	20.60	20.43
		50	25	21.50	20.16	20.59	20.64
		50	50	21.50	20.23	20.58	20.46
		100	0	21.50	20.20	20.53	20.42

Table 70: Conducted power measurement results of LTE Band 7 (Full Power)

Bandwidth	Modulation	RB size	RB offset	Tune-up	Channel	Channel	Channel
				Max.	20775CH	21100CH	21425CH
5MHz	QPSK	1	0	21.00	19.88	19.94	20.18
		1	13	21.00	19.86	19.95	20.17
		1	24	21.00	19.89	19.98	20.14
		12	0	21.00	19.70	20.20	20.07
		12	6	21.00	19.75	20.18	20.07
		12	13	21.00	19.71	20.19	20.05
		25	0	21.00	19.82	20.19	19.99
	16QAM	1	0	21.00	20.09	20.17	20.22
		1	13	21.00	20.11	20.04	20.29
		1	24	21.00	20.06	20.06	20.43
		12	0	21.00	19.72	20.06	19.98
		12	6	21.00	19.69	20.12	20.01
		12	13	21.00	19.69	20.10	20.00
		25	0	21.00	19.77	19.88	19.91
	64QAM	1	0	21.00	19.81	20.31	20.06
		1	13	21.00	19.76	20.27	20.14
		1	24	21.00	19.95	20.10	20.12
		12	0	21.00	19.73	20.03	20.04
		12	6	21.00	19.65	19.94	19.98
		12	13	21.00	19.73	19.96	19.97
		25	0	21.00	19.64	20.03	19.97
Bandwidth	Modulation	RB size	RB offset	Tune-up	Channel	Channel	Channel
10MHz	QPSK	1	0	21.00	19.77	20.12	20.14
		1	25	21.00	19.75	20.00	20.13
		1	49	21.00	19.77	20.13	20.12
		25	0	21.00	19.60	20.09	19.97
		25	13	21.00	19.71	20.01	20.00
		25	25	21.00	19.70	20.02	20.10
		50	0	21.00	19.70	20.02	20.05
	16QAM	1	0	21.00	19.76	20.22	20.20
		1	25	21.00	19.83	20.16	20.11
		1	49	21.00	19.78	20.10	20.20
		25	0	21.00	19.70	19.92	20.12
		25	13	21.00	19.69	19.93	20.12
		25	25	21.00	19.72	19.94	20.01
		50	0	21.00	19.59	19.88	19.92
	64QAM	1	0	21.00	19.93	20.12	20.14
		1	25	21.00	20.00	20.02	20.47
		1	49	21.00	20.00	20.13	20.50
		25	0	21.00	19.73	19.96	20.08
		25	13	21.00	19.68	20.20	20.09
		25	25	21.00	19.68	19.90	20.10
		50	0	21.00	19.71	20.04	20.00
Bandwidth	Modulation	RB size	RB offset	Tune-up	Channel	Channel	Channel
10MHz	QPSK	1	0	21.00	19.77	20.12	20.14
		1	25	21.00	19.75	20.00	20.13
		1	49	21.00	19.77	20.13	20.12
		25	0	21.00	19.60	20.09	19.97
		25	13	21.00	19.71	20.01	20.00
		25	25	21.00	19.70	20.02	20.10
		50	0	21.00	19.70	20.02	20.05
	16QAM	1	0	21.00	19.76	20.22	20.20
		1	25	21.00	19.83	20.16	20.11
		1	49	21.00	19.78	20.10	20.20
		25	0	21.00	19.70	19.92	20.12
		25	13	21.00	19.69	19.93	20.12
		25	25	21.00	19.72	19.94	20.01
		50	0	21.00	19.59	19.88	19.92
	64QAM	1	0	21.00	19.93	20.12	20.14
		1	25	21.00	20.00	20.02	20.47
		1	49	21.00	20.00	20.13	20.50
		25	0	21.00	19.73	19.96	20.08
		25	13	21.00	19.68	20.20	20.09
		25	25	21.00	19.68	19.90	20.10
		50	0	21.00	19.71	20.04	20.00

Bandwidth	Modulation	RB size	RB offset	Tune-up	Channel	Channel	Channel
				Max.	20825CH	21100CH	21375CH
15MHz	QPSK	1	0	21.00	19.80	19.93	20.24
		1	38	21.00	19.81	19.97	20.20
		1	74	21.00	19.81	19.92	20.25
		36	0	21.00	19.76	20.00	20.01
		36	18	21.00	19.72	19.99	20.00
		36	39	21.00	19.73	20.00	19.99
		75	0	21.00	19.73	20.24	20.20
	16QAM	1	0	21.00	20.09	20.10	20.18
		1	38	21.00	20.11	20.22	20.21
		1	74	21.00	20.22	20.18	20.32
		36	0	21.00	19.68	19.95	19.95
		36	18	21.00	19.70	19.92	20.19
		36	39	21.00	19.69	19.90	19.88
		75	0	21.00	19.69	20.04	20.04
	64QAM	1	0	21.00	20.04	20.22	20.09
		1	38	21.00	19.87	20.13	20.06
		1	74	21.00	20.15	20.26	20.33
		36	0	21.00	19.66	20.11	20.11
		36	18	21.00	19.66	20.11	20.11
		36	39	21.00	19.68	20.14	20.11
		75	0	21.00	19.61	20.10	19.90
Bandwidth	Modulation	RB size	RB offset	Tune-up	Channel	Channel	Channel
20MHz	QPSK	1	0	21.00	20.15	20.21	20.44
		1	50	21.00	20.10	20.19	20.41
		1	99	21.00	20.10	20.18	20.43
		50	0	21.00	19.80	20.03	20.14
		50	25	21.00	19.81	20.04	20.06
		50	50	21.00	19.78	20.03	20.08
		100	0	21.00	19.79	20.22	20.18
	16QAM	1	0	21.00	20.26	20.50	20.41
		1	50	21.00	20.27	20.12	20.58
		1	99	21.00	20.19	20.43	20.53
		50	0	21.00	19.73	20.13	20.03
		50	25	21.00	19.72	20.17	20.01
		50	50	21.00	19.72	20.15	19.99
		100	0	21.00	19.64	20.15	19.99
	64QAM	1	0	21.00	20.22	20.18	20.55
		1	50	21.00	20.37	20.21	20.45
		1	99	21.00	20.19	20.16	20.50
		50	0	21.00	19.68	19.99	20.18
		50	25	21.00	19.74	20.00	20.09
		50	50	21.00	19.72	20.00	20.19
		100	0	21.00	19.62	20.01	20.21
Bandwidth	Modulation	RB size	RB offset	Tune-up	Channel	Channel	Channel
				Max.	20850CH	21100CH	21350CH

Table 71: Conducted power measurement results of LTE Band 7 (Reduced Power Level D2/D4)

Bandwidth	Modulation	RB size	RB offset	Tune-up	Channel	Channel	Channel
				Max.	20775CH	21100CH	21425CH
5MHz	QPSK	1	0	22.00	20.89	21.00	20.95
		1	13	22.00	20.89	20.98	20.90
		1	24	22.00	20.84	20.96	20.93
		12	0	22.00	20.72	21.20	20.99
		12	6	22.00	20.72	21.19	20.98
		12	13	22.00	20.72	21.20	21.02
	16QAM	25	0	22.00	20.84	21.16	20.90
		1	0	22.00	21.01	21.02	21.39
		1	13	22.00	21.13	21.20	21.16
		1	24	22.00	20.82	21.13	21.53
		12	0	22.00	20.70	20.98	20.95
		12	6	22.00	20.69	20.99	20.95
	64QAM	12	13	22.00	20.62	21.00	20.92
		25	0	22.00	20.72	20.87	20.94
		1	0	22.00	20.67	21.25	21.11
		1	13	22.00	20.70	21.31	21.20
		1	24	22.00	20.71	21.36	21.28
		12	0	21.50	20.15	20.54	20.54
10MHz	QPSK	12	6	21.50	20.11	20.48	20.40
		12	13	21.50	20.21	20.44	20.43
		25	0	21.50	20.17	20.47	20.44
		1	0	22.00	20.73	21.20	21.19
		1	25	22.00	20.76	20.97	21.17
		1	49	22.00	20.73	21.18	21.20
	16QAM	25	0	22.00	20.62	21.00	20.95
		25	13	22.00	20.72	20.99	20.95
		25	25	22.00	20.74	21.02	20.99
		50	0	22.00	20.70	20.99	20.96
		1	0	22.00	20.83	21.14	21.10
		1	25	22.00	20.72	21.10	20.87
	64QAM	1	49	22.00	20.85	21.29	21.08
		25	0	22.00	20.61	20.77	21.04
		25	13	22.00	20.64	20.82	21.05
		25	25	22.00	20.66	20.90	21.13
		50	0	22.00	20.50	20.84	20.97
		1	0	22.00	20.81	21.16	20.90
	64QAM	1	25	22.00	20.81	21.27	21.01
		1	49	22.00	20.78	21.11	20.97
		25	0	21.50	20.21	20.51	20.50
		25	13	21.50	20.32	20.67	20.49
		25	25	21.50	20.31	20.46	20.50
		50	0	21.50	20.34	20.60	20.45

Bandwidth	Modulation	RB size	RB offset	Tune-up	Channel	Channel	Channel
				Max.	20825CH	21100CH	21375CH
15MHz	QPSK	1	0	22.00	20.80	21.00	21.25
		1	38	22.00	20.80	21.02	21.28
		1	74	22.00	20.78	20.95	21.21
		36	0	22.00	20.76	20.97	20.96
		36	18	22.00	20.77	21.00	21.02
		36	39	22.00	20.78	21.01	20.97
		75	0	22.00	20.76	21.19	21.16
	16QAM	1	0	22.00	21.04	21.17	21.39
		1	38	22.00	21.10	20.94	21.17
		1	74	22.00	20.97	21.20	21.18
		36	0	22.00	20.67	20.89	20.83
		36	18	22.00	20.74	21.12	21.13
		36	39	22.00	20.68	21.14	20.83
		75	0	22.00	20.67	21.00	20.96
	64QAM	1	0	22.00	21.04	21.31	21.27
		1	38	22.00	20.92	21.39	21.09
		1	74	22.00	21.01	21.12	21.09
		36	0	21.50	20.16	20.65	20.62
		36	18	21.50	20.16	20.64	20.63
		36	39	21.50	20.13	20.65	20.60
		75	0	21.50	20.17	20.66	20.44
Bandwidth	Modulation	RB size	RB offset	Tune-up	Channel	Channel	Channel
20MHz	QPSK	1	0	22.00	20.94	21.16	21.31
		1	50	22.00	20.94	21.16	21.31
		1	99	22.00	20.91	21.15	21.37
		50	0	22.00	20.78	21.04	21.10
		50	25	22.00	20.76	21.01	21.09
		50	50	22.00	20.76	21.04	21.05
		100	0	22.00	20.82	21.20	21.08
	16QAM	1	0	22.00	21.05	21.13	21.21
		1	50	22.00	21.09	21.30	21.32
		1	99	22.00	21.04	21.06	21.29
		50	0	22.00	20.72	21.15	20.95
		50	25	22.00	20.71	21.14	20.97
		50	50	22.00	20.68	21.16	21.22
		100	0	22.00	20.91	21.12	20.98
	64QAM	1	0	22.00	21.07	21.13	21.31
		1	50	22.00	21.18	21.11	21.27
		1	99	22.00	21.12	21.13	21.18
		50	0	21.50	20.24	20.58	20.75
		50	25	21.50	20.15	20.59	20.66
		50	50	21.50	20.22	20.57	20.72
		100	0	21.50	20.17	20.53	20.69
Bandwidth	Modulation	RB size	RB offset	Tune-up	Channel	Channel	Channel
				Max.	20850CH	21100CH	21350CH

Table 72: Conducted power measurement results of LTE Band 7 (Reduced Power Level D3/D5)

Bandwidth	Modulation	RB size	RB offset	Tune-up	Channel	Channel	Channel
				Max.	20775CH	21100CH	21425CH
5MHz	QPSK	1	0	21.50	20.40	20.49	20.74
		1	13	21.50	20.36	20.46	20.66
		1	24	21.50	20.34	20.48	20.65
		12	0	21.50	20.22	20.69	20.51
		12	6	21.50	20.21	20.72	20.47
		12	13	21.50	20.22	20.74	20.50
		25	0	21.50	20.32	20.48	20.47
	16QAM	1	0	21.50	20.53	20.69	20.76
		1	13	21.50	20.57	20.60	20.84
		1	24	21.50	20.37	20.74	20.84
		12	0	21.50	20.15	20.61	20.52
		12	6	21.50	20.21	20.64	20.45
		12	13	21.50	20.19	20.53	20.46
		25	0	21.50	20.18	20.45	20.47
	64QAM	1	0	21.50	20.41	20.88	20.53
		1	13	21.50	20.43	20.72	20.70
		1	24	21.50	20.19	20.83	20.87
		12	0	21.50	20.11	20.49	20.46
		12	6	21.50	20.12	20.51	20.46
		12	13	21.50	20.15	20.46	20.40
		25	0	21.50	20.17	20.51	20.43
Bandwidth	Modulation	RB size	RB offset	Tune-up	Channel	Channel	Channel
10MHz	QPSK	1	0	21.50	20.25	20.67	20.61
		1	25	21.50	20.47	20.43	20.60
		1	49	21.50	20.48	20.73	20.59
		25	0	21.50	20.11	20.65	20.46
		25	13	21.50	20.19	20.50	20.49
		25	25	21.50	20.19	20.49	20.49
		50	0	21.50	20.21	20.52	20.51
	16QAM	1	0	21.50	20.63	20.97	20.65
		1	25	21.50	20.68	20.66	20.60
		1	49	21.50	20.41	20.80	20.69
		25	0	21.50	20.14	20.36	20.38
		25	13	21.50	20.14	20.45	20.48
		25	25	21.50	20.13	20.44	20.61
		50	0	21.50	20.05	20.39	20.40
	64QAM	1	0	21.50	20.42	20.47	20.90
		1	25	21.50	20.33	20.51	20.95
		1	49	21.50	20.34	20.47	20.94
		25	0	21.50	20.12	20.51	20.49
		25	13	21.50	20.32	20.40	20.47
		25	25	21.50	20.31	20.47	20.49
		50	0	21.50	20.35	20.59	20.46
Bandwidth	Modulation	RB size	RB offset	Tune-up	Channel	Channel	Channel
				Max.	20800CH	21100CH	21400CH

Bandwidth	Modulation	RB size	RB offset	Tune-up	Channel	Channel	Channel
				Max.	20825CH	21100CH	21375CH
15MHz	QPSK	1	0	21.50	20.24	20.45	20.77
		1	38	21.50	20.26	20.50	20.79
		1	74	21.50	20.29	20.49	20.77
		36	0	21.50	20.29	20.54	20.57
		36	18	21.50	20.25	20.52	20.53
		36	39	21.50	20.29	20.53	20.54
		75	0	21.50	20.29	20.71	20.60
	16QAM	1	0	21.50	20.53	20.74	20.87
		1	38	21.50	20.59	20.71	20.69
		1	74	21.50	20.46	20.68	20.88
		36	0	21.50	20.23	20.47	20.47
		36	18	21.50	20.19	20.44	20.42
		36	39	21.50	20.18	20.41	20.42
		75	0	21.50	20.18	20.62	20.47
	64QAM	1	0	21.50	20.58	20.84	20.84
		1	38	21.50	20.38	20.84	20.75
		1	74	21.50	20.55	20.78	20.57
		36	0	21.50	20.14	20.37	20.62
		36	18	21.50	20.14	20.34	20.60
		36	39	21.50	20.16	20.34	20.63
		75	0	21.50	20.14	20.67	20.42
Bandwidth	Modulation	RB size	RB offset	Tune-up	Channel	Channel	Channel
20MHz	QPSK	1	0	21.50	20.59	20.64	20.75
		1	50	21.50	20.67	20.66	20.77
		1	99	21.50	20.66	20.64	20.79
		50	0	21.50	20.29	20.61	20.71
		50	25	21.50	20.30	20.62	20.61
		50	50	21.50	20.29	20.62	20.60
		100	0	21.50	20.30	20.72	20.58
	16QAM	1	0	21.50	21.00	20.92	20.95
		1	50	21.50	20.71	20.85	20.92
		1	99	21.50	21.00	20.94	21.05
		50	0	21.50	20.23	20.54	20.51
		50	25	21.50	20.21	20.57	20.54
		50	50	21.50	20.24	20.55	20.47
		100	0	21.50	20.15	20.50	20.41
	64QAM	1	0	21.50	20.76	20.70	20.87
		1	50	21.50	20.64	20.62	20.97
		1	99	21.50	20.78	20.61	20.86
		50	0	21.50	20.20	20.57	20.44
		50	25	21.50	20.16	20.57	20.65
		50	50	21.50	20.23	20.58	20.47
		100	0	21.50	20.17	20.52	20.45
Bandwidth	Modulation	RB size	RB offset	Tune-up	Channel	Channel	Channel
20MHz	QPSK	1	0	21.50	20.59	20.64	20.75
		1	50	21.50	20.67	20.66	20.77
		1	99	21.50	20.66	20.64	20.79
		50	0	21.50	20.29	20.61	20.71
		50	25	21.50	20.30	20.62	20.61
		50	50	21.50	20.29	20.62	20.60
		100	0	21.50	20.30	20.72	20.58
	16QAM	1	0	21.50	21.00	20.92	20.95
		1	50	21.50	20.71	20.85	20.92
		1	99	21.50	21.00	20.94	21.05
		50	0	21.50	20.23	20.54	20.51
		50	25	21.50	20.21	20.57	20.54
		50	50	21.50	20.24	20.55	20.47
		100	0	21.50	20.15	20.50	20.41
	64QAM	1	0	21.50	20.76	20.70	20.87
		1	50	21.50	20.64	20.62	20.97
		1	99	21.50	20.78	20.61	20.86
		50	0	21.50	20.20	20.57	20.44
		50	25	21.50	20.16	20.57	20.65
		50	50	21.50	20.23	20.58	20.47
		100	0	21.50	20.17	20.52	20.45

Table 73: Conducted power measurement results of LTE Band 7 (Reduced Power Level D6/D10)

Bandwidth	Modulation	RB size	RB offset	Tune-up	Channel	Channel	Channel
				Max.	20775CH	21100CH	21425CH
5MHz	QPSK	1	0	18.00	16.91	16.98	17.05
		1	13	18.00	16.96	16.96	17.18
		1	24	18.00	16.94	16.94	17.15
		12	0	18.00	16.70	17.17	16.99
		12	6	18.00	16.71	17.18	17.00
		12	13	18.00	16.70	17.19	17.01
		25	0	18.00	16.85	17.19	17.03
	16QAM	1	0	18.00	17.08	16.99	17.22
		1	13	18.00	16.95	17.20	17.04
		1	24	18.00	17.13	17.26	17.34
		12	0	18.00	16.69	17.06	16.99
		12	6	18.00	16.71	17.08	16.95
		12	13	18.00	16.67	17.06	16.96
		25	0	18.00	16.72	16.92	17.00
	64QAM	1	0	18.00	16.99	17.22	17.19
		1	13	18.00	17.10	17.31	17.28
		1	24	18.00	16.83	17.11	17.39
		12	0	18.00	16.72	17.05	17.04
		12	6	18.00	16.74	16.99	17.05
		12	13	18.00	16.69	17.01	16.99
		25	0	18.00	16.66	16.98	16.97
Bandwidth	Modulation	RB size	RB offset	Tune-up	Channel	Channel	Channel
10MHz	QPSK	1	0	18.00	16.84	17.27	17.06
		1	25	18.00	16.84	16.99	17.04
		1	49	18.00	16.79	17.20	17.05
		25	0	18.00	16.66	17.05	16.94
		25	13	18.00	16.73	16.98	16.98
		25	25	18.00	16.72	16.99	17.06
		50	0	18.00	16.78	17.00	17.08
	16QAM	1	0	18.00	16.79	17.35	17.15
		1	25	18.00	16.79	17.24	17.02
		1	49	18.00	16.90	17.36	17.17
		25	0	18.00	16.68	16.95	17.00
		25	13	18.00	16.67	16.94	16.98
		25	25	18.00	16.71	16.90	17.05
		50	0	18.00	16.61	16.84	16.94
	64QAM	1	0	18.00	17.13	17.07	17.44
		1	25	18.00	17.13	17.16	17.39
		1	49	18.00	16.90	16.94	17.45
		25	0	18.00	16.71	17.01	17.07
		25	13	18.00	16.82	17.15	17.05
		25	25	18.00	16.84	16.94	17.07
		50	0	18.00	16.81	17.05	16.98
Bandwidth	Modulation	RB size	RB offset	Tune-up	Channel	Channel	Channel
10MHz	QPSK	1	0	18.00	16.84	17.27	17.06
		1	25	18.00	16.84	16.99	17.04
		1	49	18.00	16.79	17.20	17.05
		25	0	18.00	16.66	17.05	16.94
		25	13	18.00	16.73	16.98	16.98
		25	25	18.00	16.72	16.99	17.06
		50	0	18.00	16.78	17.00	17.08
	16QAM	1	0	18.00	16.79	17.35	17.15
		1	25	18.00	16.79	17.24	17.02
		1	49	18.00	16.90	17.36	17.17
		25	0	18.00	16.68	16.95	17.00
		25	13	18.00	16.67	16.94	16.98
		25	25	18.00	16.71	16.90	17.05
		50	0	18.00	16.61	16.84	16.94
	64QAM	1	0	18.00	17.13	17.07	17.44
		1	25	18.00	17.13	17.16	17.39
		1	49	18.00	16.90	16.94	17.45
		25	0	18.00	16.71	17.01	17.07
		25	13	18.00	16.82	17.15	17.05
		25	25	18.00	16.84	16.94	17.07
		50	0	18.00	16.81	17.05	16.98

Bandwidth	Modulation	RB size	RB offset	Tune-up	Channel	Channel	Channel
				Max.	20825CH	21100CH	21375CH
15MHz	QPSK	1	0	18.00	16.88	16.97	17.26
		1	38	18.00	16.84	16.95	17.25
		1	74	18.00	16.88	17.01	17.25
		36	0	18.00	16.83	16.98	17.02
		36	18	18.00	16.84	17.02	17.02
		36	39	18.00	16.83	17.02	17.02
		75	0	18.00	16.85	17.20	17.11
	16QAM	1	0	18.00	17.29	17.20	17.33
		1	38	18.00	16.97	17.05	17.26
		1	74	18.00	17.19	17.21	17.41
		36	0	18.00	16.74	16.96	16.90
		36	18	18.00	16.72	16.91	17.21
		36	39	18.00	16.74	16.90	16.91
		75	0	18.00	16.70	17.08	16.93
	64QAM	1	0	18.00	16.90	17.35	17.09
		1	38	18.00	17.18	17.20	17.24
		1	74	18.00	17.12	17.16	17.36
		36	0	18.00	16.65	17.12	17.15
		36	18	18.00	16.66	17.12	17.13
		36	39	18.00	16.65	17.14	17.17
		75	0	18.00	16.65	17.12	16.95
Bandwidth	Modulation	RB size	RB offset	Tune-up	Channel	Channel	Channel
20MHz	QPSK	1	0	18.00	16.95	17.25	17.31
		1	50	18.00	16.94	17.19	17.31
		1	99	18.00	16.93	17.22	17.32
		50	0	18.00	16.91	17.01	17.18
		50	25	18.00	16.89	17.02	17.04
		50	50	18.00	16.91	17.02	17.08
		100	0	18.00	16.97	17.21	17.17
	16QAM	1	0	18.00	17.41	17.19	17.34
		1	50	18.00	17.53	17.28	17.42
		1	99	18.00	17.31	17.49	17.39
		50	0	18.00	16.82	17.21	16.99
		50	25	18.00	16.79	17.19	16.99
		50	50	18.00	16.76	17.16	16.96
		100	0	18.00	16.63	17.15	17.07
	64QAM	1	0	18.00	17.50	17.37	17.37
		1	50	18.00	17.24	17.18	17.56
		1	99	18.00	17.17	17.26	17.21
		50	0	18.00	16.73	17.05	17.19
		50	25	18.00	16.83	17.06	17.20
		50	50	18.00	16.73	17.05	17.25
		100	0	18.00	16.67	16.99	17.16
Bandwidth	Modulation	RB size	RB offset	Tune-up	Channel	Channel	Channel
20MHz	QPSK	1	0	18.00	16.95	17.25	17.31
		1	50	18.00	16.94	17.19	17.31
		1	99	18.00	16.93	17.22	17.32
		50	0	18.00	16.91	17.01	17.18
		50	25	18.00	16.89	17.02	17.04
		50	50	18.00	16.91	17.02	17.08
		100	0	18.00	16.97	17.21	17.17
	16QAM	1	0	18.00	17.41	17.19	17.34
		1	50	18.00	17.53	17.28	17.42
		1	99	18.00	17.31	17.49	17.39
		50	0	18.00	16.82	17.21	16.99
		50	25	18.00	16.79	17.19	16.99
		50	50	18.00	16.76	17.16	16.96
		100	0	18.00	16.63	17.15	17.07
	64QAM	1	0	18.00	17.50	17.37	17.37
		1	50	18.00	17.24	17.18	17.56
		1	99	18.00	17.17	17.26	17.21
		50	0	18.00	16.73	17.05	17.19
		50	25	18.00	16.83	17.06	17.20
		50	50	18.00	16.73	17.05	17.25
		100	0	18.00	16.67	16.99	17.16

Table 74: Conducted power measurement results of LTE Band 7 (Reduced Power Level D7)

Bandwidth	Modulation	RB size	RB offset	Tune-up	Channel	Channel	Channel
				Max.	20775CH	21100CH	21425CH
5MHz	QPSK	1	0	19.00	17.87	17.97	18.06
		1	13	19.00	17.94	17.95	17.95
		1	24	19.00	17.91	17.96	17.96
		12	0	19.00	17.76	18.19	18.05
		12	6	19.00	17.73	18.21	18.02
		12	13	19.00	17.75	18.22	18.04
		25	0	19.00	17.85	18.18	17.99
	16QAM	1	0	19.00	17.97	18.03	18.21
		1	13	19.00	17.89	18.20	18.33
		1	24	19.00	18.07	18.38	18.29
		12	0	19.00	17.76	18.04	17.94
		12	6	19.00	17.66	18.08	17.97
		12	13	19.00	17.68	18.07	17.94
		25	0	19.00	17.66	17.93	18.07
	64QAM	1	0	19.00	17.92	18.11	18.15
		1	13	19.00	17.81	18.34	18.32
		1	24	19.00	17.85	18.05	18.22
		12	0	19.00	17.75	18.03	18.00
		12	6	19.00	17.69	18.08	18.01
		12	13	19.00	17.73	18.07	18.07
		25	0	19.00	17.67	18.04	17.88
Bandwidth	Modulation	RB size	RB offset	Tune-up	Channel	Channel	Channel
10MHz	QPSK	1	0	19.00	17.72	18.19	18.16
		1	25	19.00	17.71	17.99	18.18
		1	49	19.00	17.76	18.17	18.21
		25	0	19.00	17.69	18.01	17.92
		25	13	19.00	17.74	18.00	17.95
		25	25	19.00	17.74	18.00	18.09
		50	0	19.00	17.79	17.98	18.03
	16QAM	1	0	19.00	17.84	18.25	18.16
		1	25	19.00	17.96	18.16	18.22
		1	49	19.00	17.84	18.16	18.12
		25	0	19.00	17.68	17.88	18.08
		25	13	19.00	17.70	17.89	18.11
		25	25	19.00	17.70	17.97	18.14
		50	0	19.00	17.58	17.87	18.01
	64QAM	1	0	19.00	17.88	18.13	18.23
		1	25	19.00	18.09	18.14	18.21
		1	49	19.00	17.95	18.16	18.24
		25	0	19.00	17.71	18.05	18.13
		25	13	19.00	17.87	18.18	18.13
		25	25	19.00	17.87	18.04	18.10
		50	0	19.00	17.83	18.19	17.99
Bandwidth	Modulation	RB size	RB offset	Tune-up	Channel	Channel	Channel
				Max.	20800CH	21100CH	21400CH

Bandwidth	Modulation	RB size	RB offset	Tune-up	Channel	Channel	Channel
				Max.	20825CH	21100CH	21375CH
15MHz	QPSK	1	0	19.00	17.80	17.98	18.20
		1	38	19.00	17.82	18.04	18.23
		1	74	19.00	17.78	17.96	18.27
		36	0	19.00	17.77	18.03	18.01
		36	18	19.00	17.77	18.02	18.04
		36	39	19.00	17.76	18.00	18.00
		75	0	19.00	17.78	18.20	18.06
	16QAM	1	0	19.00	18.06	18.08	18.29
		1	38	19.00	18.09	18.04	18.23
		1	74	19.00	18.16	18.15	18.54
		36	0	19.00	17.73	17.95	18.16
		36	18	19.00	17.71	18.22	18.23
		36	39	19.00	17.75	18.20	18.20
		75	0	19.00	17.70	18.03	18.04
	64QAM	1	0	19.00	18.17	18.31	18.27
		1	38	19.00	18.10	18.30	18.06
		1	74	19.00	18.23	18.28	18.14
		36	0	19.00	17.70	18.16	18.15
		36	18	19.00	17.63	18.18	18.21
		36	39	19.00	17.86	18.14	18.22
		75	0	19.00	17.64	18.15	17.98
Bandwidth	Modulation	RB size	RB offset	Tune-up	Channel	Channel	Channel
20MHz	QPSK	1	0	19.00	18.02	18.19	18.26
		1	50	19.00	18.01	18.15	18.29
		1	99	19.00	18.01	18.16	18.30
		50	0	19.00	17.90	18.02	18.12
		50	25	19.00	17.91	18.04	18.10
		50	50	19.00	17.91	18.06	18.09
		100	0	19.00	17.96	18.20	18.20
	16QAM	1	0	19.00	18.39	18.34	18.32
		1	50	19.00	18.47	18.37	18.46
		1	99	19.00	18.43	18.40	18.37
		50	0	19.00	17.71	18.13	17.99
		50	25	19.00	17.72	18.17	18.00
		50	50	19.00	17.73	18.11	18.27
		100	0	19.00	17.92	18.17	17.99
	64QAM	1	0	19.00	18.25	18.18	18.40
		1	50	19.00	18.30	18.09	18.47
		1	99	19.00	18.16	18.12	18.40
		50	0	19.00	17.70	18.14	18.27
		50	25	19.00	17.75	18.13	18.24
		50	50	19.00	17.68	18.14	18.23
		100	0	19.00	17.64	18.06	18.19
Bandwidth	Modulation	RB size	RB offset	Tune-up	Channel	Channel	Channel
20MHz	QPSK	1	0	19.00	18.02	18.19	18.26
		1	50	19.00	18.01	18.15	18.29
		1	99	19.00	18.01	18.16	18.30
		50	0	19.00	17.90	18.02	18.12
		50	25	19.00	17.91	18.04	18.10
		50	50	19.00	17.91	18.06	18.09
		100	0	19.00	17.96	18.20	18.20
	16QAM	1	0	19.00	18.39	18.34	18.32
		1	50	19.00	18.47	18.37	18.46
		1	99	19.00	18.43	18.40	18.37
		50	0	19.00	17.71	18.13	17.99
		50	25	19.00	17.72	18.17	18.00
		50	50	19.00	17.73	18.11	18.27
		100	0	19.00	17.92	18.17	17.99
	64QAM	1	0	19.00	18.25	18.18	18.40
		1	50	19.00	18.30	18.09	18.47
		1	99	19.00	18.16	18.12	18.40
		50	0	19.00	17.70	18.14	18.27
		50	25	19.00	17.75	18.13	18.24
		50	50	19.00	17.68	18.14	18.23
		100	0	19.00	17.64	18.06	18.19

Table 75: Conducted power measurement results of LTE Band 7 (Reduced Power Level D8)

7.1.19 Conducted power measurements of LTE Band 12(Second antenna)

Bandwidth	Modulation	RB size	RB offset	Tune-up	Channel	Channel	Channel	
				Max.	23017CH	23095CH	23173CH	
1.4MHz	QPSK	1	0	20.50	19.66	19.53	19.38	
		1	3	20.50	19.65	19.51	19.42	
		1	5	20.50	19.66	19.56	19.38	
		3	0	20.50	19.54	19.50	19.27	
		3	2	20.50	19.51	19.52	19.54	
		3	3	20.50	19.50	19.52	19.53	
		6	0	20.50	19.37	19.46	19.52	
	16QAM	1	0	20.50	19.64	19.63	19.31	
		1	3	20.50	19.77	19.65	19.37	
		1	5	20.50	19.56	19.58	19.53	
		3	0	20.50	19.33	19.36	19.37	
		3	2	20.50	19.38	19.48	19.49	
		3	3	20.50	19.44	19.55	19.52	
		6	0	20.50	19.44	19.55	19.35	
	64QAM	1	0	20.50	19.70	19.57	19.48	
		1	3	20.50	19.70	19.71	19.48	
		1	5	20.50	19.60	19.49	19.57	
		3	0	20.50	19.58	19.30	19.44	
		3	2	20.50	19.55	19.37	19.41	
		3	3	20.50	19.60	19.36	19.27	
		6	0	20.50	19.59	19.45	19.57	
	Bandwidth	Modulation	RB size	RB offset	Tune-up	Channel	Channel	Channel
	3MHz	QPSK	1	0	20.50	19.62	19.52	19.60
			1	7	20.50	19.59	19.53	19.64
1			14	20.50	19.61	19.52	19.57	
8			0	20.50	19.53	19.52	19.44	
8			4	20.50	19.53	19.53	19.42	
8			7	20.50	19.53	19.50	19.43	
15			0	20.50	19.46	19.50	19.56	
16QAM		1	0	20.50	19.75	19.66	19.66	
		1	7	20.50	19.93	19.75	19.53	
		1	14	20.50	19.85	19.63	19.53	
		8	0	20.50	19.44	19.46	19.30	
		8	4	20.50	19.38	19.55	19.33	
		8	7	20.50	19.42	19.50	19.35	
		15	0	20.50	19.61	19.43	19.49	
64QAM		1	0	20.50	19.58	19.71	19.61	
		1	7	20.50	19.61	19.52	19.59	
		1	14	20.50	19.49	19.44	19.52	
		8	0	20.50	19.32	19.55	19.56	
		8	4	20.50	19.37	19.48	19.49	
		8	7	20.50	19.36	19.48	19.27	
		15	0	20.50	19.33	19.45	19.20	
Bandwidth		Modulation	RB size	RB offset	Tune-up	Channel	Channel	Channel
					Max.	23025CH	23095CH	23165CH

Bandwidth	Modulation	RB size	RB offset	Tune-up	Channel	Channel	Channel
				Max.	23035CH	23095CH	23155CH
5MHz	QPSK	1	0	20.50	19.58	19.35	19.52
		1	13	20.50	19.63	19.38	19.47
		1	24	20.50	19.65	19.41	19.54
		12	0	20.50	19.59	19.64	19.53
		12	6	20.50	19.58	19.66	19.54
		12	13	20.50	19.61	19.68	19.55
		25	0	20.50	19.44	19.51	19.49
	16QAM	1	0	20.50	19.77	19.85	19.71
		1	13	20.50	19.74	19.91	19.65
		1	24	20.50	19.73	19.79	19.67
		12	0	20.50	19.45	19.57	19.44
		12	6	20.50	19.48	19.56	19.42
		12	13	20.50	19.51	19.54	19.49
		25	0	20.50	19.57	19.42	19.44
	64QAM	1	0	20.50	19.46	19.60	19.39
		1	13	20.50	19.55	19.60	19.69
		1	24	20.50	19.59	19.67	19.54
		12	0	20.50	19.37	19.50	19.45
		12	6	20.50	19.37	19.50	19.43
		12	13	20.50	19.37	19.52	19.44
		25	0	20.50	19.32	19.44	19.44
Bandwidth	Modulation	RB size	RB offset	Tune-up	Channel	Channel	Channel
10MHz	QPSK	1	0	20.50	19.63	19.45	19.62
		1	25	20.50	19.66	19.69	19.66
		1	49	20.50	19.62	19.73	19.67
		25	0	20.50	19.51	19.60	19.46
		25	13	20.50	19.53	19.59	19.38
		25	25	20.50	19.52	19.59	19.39
		50	0	20.50	19.47	19.51	19.35
	16QAM	1	0	20.50	19.69	19.59	19.43
		1	25	20.50	19.71	19.77	19.50
		1	49	20.50	19.61	19.83	19.46
		25	0	20.50	19.45	19.43	19.32
		25	13	20.50	19.41	19.46	19.31
		25	25	20.50	19.41	19.43	19.31
		50	0	20.50	19.44	19.41	19.46
	64QAM	1	0	20.50	19.69	19.77	19.65
		1	25	20.50	19.64	19.78	19.77
		1	49	20.50	19.57	19.67	19.65
		25	0	20.50	19.47	19.48	19.29
		25	13	20.50	19.45	19.30	19.28
		25	25	20.50	19.47	19.31	19.32
		50	0	20.50	19.39	19.41	19.26
Bandwidth	Modulation	RB size	RB offset	Tune-up	Channel	Channel	Channel
10MHz	QPSK	1	0	20.50	19.63	19.45	19.62
		1	25	20.50	19.66	19.69	19.66
		1	49	20.50	19.62	19.73	19.67
		25	0	20.50	19.51	19.60	19.46
		25	13	20.50	19.53	19.59	19.38
		25	25	20.50	19.52	19.59	19.39
		50	0	20.50	19.47	19.51	19.35
	16QAM	1	0	20.50	19.69	19.59	19.43
		1	25	20.50	19.71	19.77	19.50
		1	49	20.50	19.61	19.83	19.46
		25	0	20.50	19.45	19.43	19.32
		25	13	20.50	19.41	19.46	19.31
		25	25	20.50	19.41	19.43	19.31
		50	0	20.50	19.44	19.41	19.46
	64QAM	1	0	20.50	19.69	19.77	19.65
		1	25	20.50	19.64	19.78	19.77
		1	49	20.50	19.57	19.67	19.65
		25	0	20.50	19.47	19.48	19.29
		25	13	20.50	19.45	19.30	19.28
		25	25	20.50	19.47	19.31	19.32
		50	0	20.50	19.39	19.41	19.26

Table 76: Conducted power measurement results of LTE Band 12 (Reduced Power Level D1/D3)

Bandwidth	Modulation	RB size	RB offset	Tune-up	Channel	Channel	Channel
				Max.	23017CH	23095CH	23173CH
1.4MHz	QPSK	1	0	25.00	23.94	23.91	23.88
		1	3	25.00	23.97	23.87	23.87
		1	5	25.00	23.99	23.87	23.84
		3	0	25.00	23.89	23.97	23.92
		3	2	25.00	23.86	23.85	23.92
		3	3	25.00	23.86	23.85	23.92
		6	0	24.00	23.00	22.81	22.87
	16QAM	1	0	24.00	22.87	22.81	22.93
		1	3	24.00	22.87	22.79	22.83
		1	5	24.00	23.01	22.79	22.98
		3	0	24.00	23.01	22.81	22.77
		3	2	24.00	22.97	22.87	22.77
		3	3	24.00	23.01	22.98	22.79
		6	0	23.00	21.79	21.82	21.98
	64QAM	1	0	23.00	22.15	22.05	21.64
		1	3	23.00	21.89	21.92	21.86
		1	5	23.00	22.03	21.90	21.99
		3	0	23.00	22.14	21.97	21.90
		3	2	23.00	22.13	22.05	21.86
		3	3	23.00	22.06	22.02	21.92
		6	0	22.00	20.88	20.92	21.05
Bandwidth	Modulation	RB size	RB offset	Tune-up	Channel	Channel	Channel
3MHz	QPSK	1	0	25.00	23.89	23.71	23.81
		1	7	25.00	23.95	23.73	23.82
		1	14	25.00	23.95	23.76	23.75
		8	0	24.00	22.86	22.82	22.68
		8	4	24.00	22.84	22.81	22.68
		8	7	24.00	22.86	22.81	22.69
		15	0	24.00	22.79	22.73	22.83
	16QAM	1	0	24.00	23.17	22.95	22.82
		1	7	24.00	23.09	22.93	22.89
		1	14	24.00	23.06	22.83	22.92
		8	0	23.00	21.89	21.74	21.67
		8	4	23.00	21.84	21.81	21.75
		8	7	23.00	21.82	21.76	21.69
		15	0	23.00	21.94	21.73	21.87
	64QAM	1	0	23.00	21.80	22.07	22.09
		1	7	23.00	22.00	22.02	21.98
		1	14	23.00	21.80	21.95	21.90
		8	0	22.00	20.85	20.86	20.95
		8	4	22.00	20.85	20.81	20.93
		8	7	22.00	20.85	20.83	20.78
		15	0	22.00	20.81	20.83	20.71
Bandwidth	Modulation	RB size	RB offset	Tune-up	Channel	Channel	Channel
				Max.	23025CH	23095CH	23165CH

Bandwidth	Modulation	RB size	RB offset	Tune-up	Channel	Channel	Channel
				Max.	23035CH	23095CH	23155CH
5MHz	QPSK	1	0	25.00	24.05	23.78	23.84
		1	13	25.00	24.01	23.85	23.79
		1	24	25.00	24.02	23.82	23.81
		12	0	24.00	22.93	22.86	22.82
		12	6	24.00	22.92	22.86	22.84
		12	13	24.00	22.89	22.87	22.82
		25	0	24.00	22.78	22.78	22.77
	16QAM	1	0	24.00	23.04	23.01	23.14
		1	13	24.00	23.04	23.09	23.11
		1	24	24.00	23.38	23.08	23.14
		12	0	23.00	21.83	21.82	21.79
		12	6	23.00	21.90	21.77	21.80
		12	13	23.00	21.81	21.86	21.84
		25	0	23.00	21.76	21.75	21.70
	64QAM	1	0	23.00	21.98	22.16	21.96
		1	13	23.00	21.85	22.11	21.86
		1	24	23.00	21.97	22.05	21.91
		12	0	22.00	20.95	20.85	20.83
		12	6	22.00	20.93	20.88	20.85
		12	13	22.00	20.87	20.88	20.84
		25	0	22.00	20.81	20.77	20.78
Bandwidth	Modulation	RB size	RB offset	Tune-up	Channel	Channel	Channel
10MHz	QPSK	1	0	25.00	24.03	23.87	23.83
		1	25	25.00	24.00	23.91	23.81
		1	49	25.00	24.03	23.90	23.83
		25	0	24.00	22.86	22.84	22.73
		25	13	24.00	22.92	22.85	22.98
		25	25	24.00	22.89	22.85	22.98
		50	0	24.00	22.82	22.76	22.96
	16QAM	1	0	24.00	22.82	23.01	22.79
		1	25	24.00	22.94	23.06	23.02
		1	49	24.00	22.99	22.97	23.08
		25	0	23.00	21.84	21.83	21.73
		25	13	23.00	21.82	21.85	21.67
		25	25	23.00	21.79	21.81	21.63
		50	0	23.00	21.71	21.75	21.88
	64QAM	1	0	23.00	22.12	22.25	22.05
		1	25	23.00	21.92	21.91	21.96
		1	49	23.00	22.04	22.13	21.83
		25	0	22.00	20.88	20.95	20.69
		25	13	22.00	20.87	20.79	20.68
		25	25	22.00	20.84	20.77	20.72
		50	0	22.00	20.77	20.77	20.64
Bandwidth	Modulation	RB size	RB offset	Tune-up	Channel	Channel	Channel
10MHz	QPSK	1	0	25.00	24.03	23.87	23.83
		1	25	25.00	24.00	23.91	23.81
		1	49	25.00	24.03	23.90	23.83
		25	0	24.00	22.86	22.84	22.73
		25	13	24.00	22.92	22.85	22.98
		25	25	24.00	22.89	22.85	22.98
		50	0	24.00	22.82	22.76	22.96
	16QAM	1	0	24.00	22.82	23.01	22.79
		1	25	24.00	22.94	23.06	23.02
		1	49	24.00	22.99	22.97	23.08
		25	0	23.00	21.84	21.83	21.73
		25	13	23.00	21.82	21.85	21.67
		25	25	23.00	21.79	21.81	21.63
		50	0	23.00	21.71	21.75	21.88
	64QAM	1	0	23.00	22.12	22.25	22.05
		1	25	23.00	21.92	21.91	21.96
		1	49	23.00	22.04	22.13	21.83
		25	0	22.00	20.88	20.95	20.69
		25	13	22.00	20.87	20.79	20.68
		25	25	22.00	20.84	20.77	20.72
		50	0	22.00	20.77	20.77	20.64

Table 77: Conducted power measurement results of LTE Band 12 (Full Power)

7.1.20 Conducted power measurements of LTE Band 12(Main antenna)

Bandwidth	Modulation	RB size	RB offset	Tune-up	Channel	Channel	Channel
				Max.	23017CH	23095CH	23173CH
1.4MHz	QPSK	1	0	25.00	23.95	23.96	23.94
		1	3	25.00	23.97	23.98	23.91
		1	5	25.00	24.01	23.97	23.95
		3	0	25.00	23.89	23.86	24.02
		3	2	25.00	23.95	23.95	23.93
		3	3	25.00	24.01	23.94	24.01
		6	0	24.00	23.11	23.07	23.01
	16QAM	1	0	24.00	23.09	22.95	22.85
		1	3	24.00	23.08	23.05	22.64
		1	5	24.00	23.09	22.99	22.87
		3	0	24.00	22.83	22.97	22.90
		3	2	24.00	22.90	22.95	23.02
		3	3	24.00	23.06	23.03	23.00
		6	0	23.00	21.96	22.12	21.98
	64QAM	1	0	23.00	22.17	22.14	22.08
		1	3	23.00	22.13	22.12	22.10
		1	5	23.00	22.24	22.22	22.16
		3	0	23.00	22.04	21.96	21.96
		3	2	23.00	22.00	22.12	22.13
		3	3	23.00	21.99	22.02	22.05
		6	0	22.00	21.09	20.93	21.17
Bandwidth	Modulation	RB size	RB offset	Tune-up	Channel	Channel	Channel
3MHz	QPSK	1	0	25.00	23.97	24.05	23.87
		1	7	25.00	23.98	24.11	23.86
		1	14	25.00	23.89	24.04	23.87
		8	0	24.00	23.05	23.12	23.06
		8	4	24.00	23.04	23.07	23.06
		8	7	24.00	23.04	23.08	23.05
		15	0	24.00	23.16	23.03	22.95
	16QAM	1	0	24.00	23.11	23.19	23.05
		1	7	24.00	23.01	23.14	22.91
		1	14	24.00	22.97	23.18	23.04
		8	0	23.00	22.05	21.75	21.74
		8	4	23.00	21.95	21.79	21.79
		8	7	23.00	21.90	21.81	21.82
		15	0	23.00	22.10	22.03	21.99
	64QAM	1	0	23.00	22.13	21.89	22.15
		1	7	23.00	22.04	21.82	22.07
		1	14	23.00	22.21	21.93	22.19
		8	0	22.00	21.01	20.83	20.78
		8	4	22.00	21.02	20.82	20.82
		8	7	22.00	21.05	20.88	20.80
		15	0	22.00	20.95	21.07	21.06
Bandwidth	Modulation	RB size	RB offset	Tune-up	Channel	Channel	Channel
				Max.	23025CH	23095CH	23165CH

Bandwidth	Modulation	RB size	RB offset	Tune-up	Channel	Channel	Channel
				Max.	23035CH	23095CH	23155CH
5MHz	QPSK	1	0	25.00	23.89	23.94	24.09
		1	13	25.00	23.96	23.92	24.05
		1	24	25.00	23.97	23.93	24.07
		12	0	24.00	23.02	23.10	22.94
		12	6	24.00	22.99	23.17	22.94
		12	13	24.00	22.98	23.17	22.94
		25	0	24.00	22.91	23.02	22.91
	16QAM	1	0	24.00	23.10	22.92	22.96
		1	13	24.00	23.01	23.10	23.03
		1	24	24.00	23.06	23.00	22.96
		12	0	23.00	21.93	22.04	21.94
		12	6	23.00	22.09	22.05	21.97
		12	13	23.00	21.92	21.74	22.01
		25	0	23.00	21.86	21.99	21.88
	64QAM	1	0	23.00	22.29	22.05	22.01
		1	13	23.00	22.12	22.22	22.15
		1	24	23.00	22.28	22.13	22.01
		12	0	22.00	21.06	20.81	21.06
		12	6	22.00	21.03	20.81	21.06
		12	13	22.00	21.03	20.83	21.03
		25	0	22.00	20.92	21.05	21.04
Bandwidth	Modulation	RB size	RB offset	Tune-up	Channel	Channel	Channel
10MHz	QPSK	1	0	25.00	24.02	24.03	23.97
		1	25	25.00	24.01	23.96	23.96
		1	49	25.00	24.01	23.97	23.93
		25	0	24.00	22.99	23.02	22.98
		25	13	24.00	22.99	23.04	22.97
		25	25	24.00	22.98	23.14	22.98
		50	0	24.00	22.95	22.91	22.83
	16QAM	1	0	24.00	22.81	23.09	23.01
		1	25	24.00	22.95	23.03	23.19
		1	49	24.00	22.95	23.11	23.09
		25	0	23.00	21.99	22.01	22.06
		25	13	23.00	21.94	22.01	21.87
		25	25	23.00	21.94	21.77	21.87
		50	0	23.00	21.89	21.97	21.79
	64QAM	1	0	23.00	22.19	22.19	22.05
		1	25	23.00	22.24	22.28	22.06
		1	49	23.00	22.06	22.11	21.94
		25	0	22.00	21.06	20.84	20.99
		25	13	22.00	21.09	20.77	20.98
		25	25	22.00	21.11	20.80	21.01
		50	0	22.00	20.98	21.02	20.87
Bandwidth	Modulation	RB size	RB offset	Tune-up	Channel	Channel	Channel
10MHz	QPSK	1	0	25.00	24.02	24.03	23.97
		1	25	25.00	24.01	23.96	23.96
		1	49	25.00	24.01	23.97	23.93
		25	0	24.00	22.99	23.02	22.98
		25	13	24.00	22.99	23.04	22.97
		25	25	24.00	22.98	23.14	22.98
		50	0	24.00	22.95	22.91	22.83
	16QAM	1	0	24.00	22.81	23.09	23.01
		1	25	24.00	22.95	23.03	23.19
		1	49	24.00	22.95	23.11	23.09
		25	0	23.00	21.99	22.01	22.06
		25	13	23.00	21.94	22.01	21.87
		25	25	23.00	21.94	21.77	21.87
		50	0	23.00	21.89	21.97	21.79
	64QAM	1	0	23.00	22.19	22.19	22.05
		1	25	23.00	22.24	22.28	22.06
		1	49	23.00	22.06	22.11	21.94
		25	0	22.00	21.06	20.84	20.99
		25	13	22.00	21.09	20.77	20.98
		25	25	22.00	21.11	20.80	21.01
		50	0	22.00	20.98	21.02	20.87

Table 78: Conducted power measurement results of LTE Band 12

7.1.21 Conducted power measurements of LTE Band 17(Second antenna)

Bandwidth	Modulation	RB size	RB offset	Tune-up	Channel	Channel	Channel
				Max.	23755CH	23790CH	23825CH
5MHz	QPSK	1	0	20.50	19.53	19.47	19.51
		1	13	20.50	19.51	19.47	19.52
		1	24	20.50	19.52	19.52	19.45
		12	0	20.50	19.63	19.63	19.40
		12	6	20.50	19.63	19.45	19.40
		12	13	20.50	19.62	19.45	19.39
		25	0	20.50	19.48	19.36	19.40
	16QAM	1	0	20.50	19.75	19.80	19.57
		1	13	20.50	19.69	19.67	19.54
		1	24	20.50	19.67	19.74	19.57
		12	0	20.50	19.44	19.51	19.31
		12	6	20.50	19.44	19.47	19.30
		12	13	20.50	19.48	19.53	19.29
		25	0	20.50	19.48	19.27	19.20
	64QAM	1	0	20.50	19.51	19.65	19.42
		1	13	20.50	19.51	19.56	19.67
		1	24	20.50	19.58	19.65	19.38
		12	0	20.50	19.41	19.50	19.34
		12	6	20.50	19.42	19.34	19.30
		12	13	20.50	19.38	19.43	19.35
		25	0	20.50	19.41	19.26	19.37
Bandwidth	Modulation	RB size	RB offset	Tune-up	Channel	Channel	Channel
10MHz	QPSK	1	0	20.50	19.34	19.64	19.53
		1	25	20.50	19.31	19.63	19.49
		1	49	20.50	19.39	19.62	19.54
		25	0	20.50	19.35	19.26	19.62
		25	13	20.50	19.35	19.36	19.59
		25	25	20.50	19.35	19.29	19.61
		50	0	20.50	19.25	19.29	19.58
	16QAM	1	0	20.50	19.50	19.49	19.38
		1	25	20.50	19.62	19.29	19.59
		1	49	20.50	19.53	19.28	19.57
		25	0	20.50	19.38	19.48	19.47
		25	13	20.50	19.38	19.46	19.43
		25	25	20.50	19.43	19.46	19.48
		50	0	20.50	19.48	19.47	19.43
	64QAM	1	0	20.50	19.50	19.52	19.53
		1	25	20.50	19.39	19.65	19.51
		1	49	20.50	19.56	19.43	19.59
		25	0	20.50	19.33	19.39	19.42
		25	13	20.50	19.34	19.44	19.42
		25	25	20.50	19.36	19.41	19.44
		50	0	20.50	19.34	19.40	19.35
Bandwidth	Modulation	RB size	RB offset	Tune-up	Channel	Channel	Channel
				Max.	23780CH	23790CH	23800CH

Table 79: Conducted power measurement results of LTE Band 17 (Reduced Power Level D1/D3)

Bandwidth	Modulation	RB size	RB offset	Tune-up	Channel	Channel	Channel
				Max.	23755CH	23790CH	23825CH
5MHz	QPSK	1	0	25.00	23.73	23.93	23.83
		1	13	25.00	23.75	23.93	23.82
		1	24	25.00	23.71	23.91	23.86
		12	0	24.00	22.89	22.95	22.72
		12	6	24.00	22.88	22.77	22.72
		12	13	24.00	22.87	22.79	22.71
		25	0	24.00	22.74	22.91	22.70
	16QAM	1	0	24.00	22.79	23.06	23.30
		1	13	24.00	23.02	23.09	23.11
		1	24	24.00	22.91	23.01	23.02
		12	0	23.00	21.81	21.95	21.74
		12	6	23.00	21.84	21.97	21.72
		12	13	23.00	21.85	21.96	21.70
		25	0	23.00	21.92	21.66	21.67
	64QAM	1	0	23.00	21.89	21.81	21.86
		1	13	23.00	21.84	21.93	22.04
		1	24	23.00	21.79	21.92	21.92
		12	0	22.00	20.92	21.01	20.74
		12	6	22.00	20.91	20.82	20.74
		12	13	22.00	20.86	21.01	20.82
		25	0	22.00	20.92	20.71	20.72
Bandwidth	Modulation	RB size	RB offset	Tune-up	Channel	Channel	Channel
10MHz	QPSK	1	0	25.00	23.85	23.80	23.69
		1	25	25.00	23.92	23.78	23.72
		1	49	25.00	23.89	23.82	23.73
		25	0	24.00	22.72	22.96	22.92
		25	13	24.00	22.71	22.70	22.91
		25	25	24.00	22.70	22.96	22.91
		50	0	24.00	22.95	22.96	22.89
	16QAM	1	0	24.00	22.97	22.78	22.76
		1	25	24.00	22.98	22.88	22.82
		1	49	24.00	22.93	22.92	22.77
		25	0	23.00	21.68	21.90	21.90
		25	13	23.00	21.64	21.90	21.87
		25	25	23.00	21.64	21.92	21.93
		50	0	23.00	21.88	21.89	21.86
	64QAM	1	0	23.00	21.90	21.83	22.13
		1	25	23.00	21.93	21.84	21.93
		1	49	23.00	21.88	21.95	22.11
		25	0	22.00	20.67	20.95	20.95
		25	13	22.00	20.74	20.96	20.94
		25	25	22.00	20.75	21.00	20.99
		50	0	22.00	20.91	20.95	20.89

Table 80: Conducted power measurement results of LTE Band 17 (Full Power)

7.1.22 Conducted power measurements of LTE Band 17(Main antenna)

Bandwidth	Modulation	RB size	RB offset	Tune-up	Channel	Channel	Channel
				Max.	23755CH	23790CH	23825CH
5MHz	QPSK	1	0	25.00	23.92	23.95	24.21
		1	13	25.00	23.95	23.96	24.17
		1	24	25.00	23.99	23.97	24.19
		12	0	24.00	22.90	23.03	22.99
		12	6	24.00	22.84	23.02	23.05
		12	13	24.00	22.87	23.03	23.06
		25	0	24.00	22.98	22.98	22.94
	16QAM	1	0	24.00	23.06	23.24	23.26
		1	13	24.00	23.05	23.16	23.22
		1	24	24.00	22.98	23.16	23.09
		12	0	23.00	22.02	22.18	22.08
		12	6	23.00	21.81	22.19	22.09
		12	13	23.00	21.83	22.08	22.05
		25	0	23.00	21.87	21.92	21.90
	64QAM	1	0	23.00	22.06	22.00	22.17
		1	13	23.00	21.86	22.15	22.06
		1	24	23.00	22.26	22.00	22.15
		12	0	22.00	20.90	21.04	20.98
		12	6	22.00	20.88	21.16	21.14
		12	13	22.00	20.93	21.06	21.00
		25	0	22.00	20.94	20.97	20.99
Bandwidth	Modulation	RB size	RB offset	Tune-up	Channel	Channel	Channel
10MHz	QPSK	1	0	25.00	23.99	24.06	24.01
		1	25	25.00	24.00	24.17	24.17
		1	49	25.00	24.06	24.22	24.00
		25	0	24.00	23.02	23.19	23.03
		25	13	24.00	23.02	23.17	23.18
		25	25	24.00	23.03	23.02	23.19
		50	0	24.00	22.95	22.96	22.96
	16QAM	1	0	24.00	23.17	23.36	22.83
		1	25	24.00	23.17	23.19	23.13
		1	49	24.00	22.96	23.06	23.13
		25	0	23.00	21.98	22.11	22.02
		25	13	23.00	22.12	21.93	22.07
		25	25	23.00	22.18	22.11	22.06
		50	0	23.00	21.89	21.91	21.85
	64QAM	1	0	23.00	22.14	22.05	22.17
		1	25	23.00	22.29	22.29	22.14
		1	49	23.00	22.03	22.30	22.16
		25	0	22.00	21.06	21.18	21.12
		25	13	22.00	21.09	21.11	21.14
		25	25	22.00	21.10	20.97	21.13
		50	0	22.00	20.91	20.95	20.90
Bandwidth	Modulation	RB size	RB offset	Tune-up	Channel	Channel	Channel
10MHz	QPSK	1	0	25.00	23.99	24.06	24.01
		1	25	25.00	24.00	24.17	24.17
		1	49	25.00	24.06	24.22	24.00
		25	0	24.00	23.02	23.19	23.03
		25	13	24.00	23.02	23.17	23.18
		25	25	24.00	23.03	23.02	23.19
		50	0	24.00	22.95	22.96	22.96
	16QAM	1	0	24.00	23.17	23.36	22.83
		1	25	24.00	23.17	23.19	23.13
		1	49	24.00	22.96	23.06	23.13
		25	0	23.00	21.98	22.11	22.02
		25	13	23.00	22.12	21.93	22.07
		25	25	23.00	22.18	22.11	22.06
		50	0	23.00	21.89	21.91	21.85
	64QAM	1	0	23.00	22.14	22.05	22.17
		1	25	23.00	22.29	22.29	22.14
		1	49	23.00	22.03	22.30	22.16
		25	0	22.00	21.06	21.18	21.12
		25	13	22.00	21.09	21.11	21.14
		25	25	22.00	21.10	20.97	21.13
		50	0	22.00	20.91	20.95	20.90

Table 81: Conducted power measurement results of LTE Band 17

7.1.23 Conducted power measurements of LTE Band 26(Second antenna)

Bandwidth	Modulation	RB size	RB offset	Tune-up	Channel	Channel	Channel
				Max.	26697CH	26865CH	27033CH
1.4MHz	QPSK	1	0	19.20	18.31	18.31	18.07
		1	3	19.20	18.30	18.16	18.07
		1	5	19.20	18.27	18.18	18.12
		3	0	19.20	18.17	18.21	18.11
		3	2	19.20	18.17	18.08	18.10
		3	3	19.20	18.16	18.23	18.13
		6	0	19.20	18.06	18.17	18.22
	16QAM	1	0	19.20	18.09	18.02	18.25
		1	3	19.20	18.06	18.07	18.45
		1	5	19.20	18.28	18.45	18.33
		3	0	19.20	18.25	18.19	18.08
		3	2	19.20	18.14	18.25	18.13
		3	3	19.20	18.21	17.93	18.15
		6	0	19.20	18.20	17.98	17.98
	64QAM	1	0	19.20	18.40	18.28	18.11
		1	3	19.20	18.44	18.36	18.16
		1	5	19.20	18.46	18.07	18.19
		3	0	19.20	18.22	18.12	18.16
		3	2	19.20	18.17	18.21	18.07
		3	3	19.20	18.23	18.29	18.09
		6	0	19.20	18.18	18.07	18.15
Bandwidth	Modulation	RB size	RB offset	Tune-up	Channel	Channel	Channel
3MHz	QPSK	1	0	19.20	18.23	18.30	18.20
		1	7	19.20	18.21	18.28	18.22
		1	14	19.20	18.27	18.35	18.24
		8	0	19.20	18.27	17.97	18.26
		8	4	19.20	18.30	18.01	18.10
		8	7	19.20	18.28	18.01	18.23
		15	0	19.20	18.05	18.09	18.18
	16QAM	1	0	19.20	18.24	18.06	18.32
		1	7	19.20	18.20	18.10	18.54
		1	14	19.20	18.43	18.04	18.36
		8	0	19.20	18.25	18.14	18.07
		8	4	19.20	18.30	18.14	18.25
		8	7	19.20	18.31	18.12	18.27
		15	0	19.20	18.24	17.97	18.15
	64QAM	1	0	19.20	18.21	18.01	18.30
		1	7	19.20	18.13	18.10	18.28
		1	14	19.20	18.18	18.20	18.26
		8	0	19.20	18.28	18.22	18.09
		8	4	19.20	18.23	18.11	18.25
		8	7	19.20	18.27	18.15	18.05
		15	0	19.20	18.21	18.27	18.11
Bandwidth	Modulation	RB size	RB offset	Tune-up	Channel	Channel	Channel
				Max.	26705CH	26865CH	27025CH

Bandwidth	Modulation	RB size	RB offset	Tune-up	Channel	Channel	Channel
				Max.	26715CH	26865CH	27015CH
5MHz	QPSK	1	0	19.20	18.31	18.09	18.25
		1	13	19.20	18.29	18.10	18.24
		1	24	19.20	18.19	18.10	18.22
		12	0	19.20	18.33	18.17	18.23
		12	6	19.20	18.33	18.17	18.27
		12	13	19.20	18.35	18.17	18.28
		25	0	19.20	18.32	18.21	18.31
	16QAM	1	0	19.20	18.27	18.12	18.44
		1	13	19.20	18.50	18.26	18.44
		1	24	19.20	18.45	18.35	18.42
		12	0	19.20	18.32	18.16	18.15
		12	6	19.20	18.31	18.06	18.24
		12	13	19.20	18.32	18.09	18.24
		25	0	19.20	18.25	17.95	18.17
	64QAM	1	0	19.20	18.27	18.25	18.37
		1	13	19.20	18.33	18.24	18.20
		1	24	19.20	18.37	18.26	18.14
		12	0	19.20	18.39	18.17	18.25
		12	6	19.20	18.40	18.13	18.18
		12	13	19.20	18.35	18.13	18.22
		25	0	19.20	18.13	18.14	18.16
Bandwidth	Modulation	RB size	RB offset	Tune-up	Channel	Channel	Channel
10MHz	QPSK	1	0	19.20	18.25	18.30	18.04
		1	25	19.20	18.20	18.30	18.30
		1	49	19.20	18.19	18.28	18.29
		25	0	19.20	18.27	18.33	18.21
		25	13	19.20	18.26	18.33	18.25
		25	25	19.20	18.26	18.34	18.25
		50	0	19.20	18.07	18.23	18.25
	16QAM	1	0	19.20	18.33	18.39	18.25
		1	25	19.20	18.22	18.41	18.30
		1	49	19.20	18.42	18.29	18.24
		25	0	19.20	18.17	18.32	18.22
		25	13	19.20	18.16	18.26	18.18
		25	25	19.20	18.20	18.35	18.16
		50	0	19.20	18.19	18.13	18.13
	64QAM	1	0	19.20	18.30	18.31	18.07
		1	25	19.20	18.19	18.29	17.97
		1	49	19.20	18.26	18.30	17.99
		25	0	19.20	18.22	18.02	18.24
		25	13	19.20	18.23	18.00	18.22
		25	25	19.20	18.11	17.99	18.22
		50	0	19.20	18.25	18.16	18.00
Bandwidth	Modulation	RB size	RB offset	Tune-up	Channel	Channel	Channel
				Max.	26740CH	26865CH	26990CH

Bandwidth	Modulation	RB size	RB offset	Tune-up	Channel	Channel	Channel
				Max.	26765CH	26865CH	26965CH
15MHz	QPSK	1	0	19.20	18.28	18.27	18.29
		1	38	19.20	18.28	18.27	18.09
		1	74	19.20	18.31	18.28	18.35
		36	0	19.20	18.31	18.38	18.31
		36	18	19.20	18.30	18.34	18.30
		36	39	19.20	18.29	18.38	18.26
		75	0	19.20	18.02	18.26	18.09
	16QAM	1	0	19.20	18.35	18.52	18.29
		1	38	19.20	18.52	18.36	18.12
		1	74	19.20	18.18	18.31	18.10
		36	0	19.20	18.18	18.29	18.29
		36	18	19.20	18.21	18.27	18.25
		36	39	19.20	18.21	18.27	18.26
		75	0	19.20	18.15	18.00	17.91
	64QAM	1	0	19.20	18.37	18.48	18.09
		1	38	19.20	18.18	18.36	18.21
		1	74	19.20	18.43	18.38	18.05
		36	0	19.20	18.39	18.32	18.33
		36	18	19.20	18.41	18.34	18.26
		36	39	19.20	18.40	18.29	18.32
		75	0	19.20	18.25	18.18	18.15

Table 82: Conducted power measurement results of LTE Band 26 (Reduced Power Level D1/D3)

Bandwidth	Modulation	RB size	RB offset	Tune-up	Channel	Channel	Channel	
				Max.	26697CH	26865CH	27033CH	
1.4MHz	QPSK	1	0	24.70	23.81	23.52	23.52	
		1	3	24.70	23.80	23.60	23.49	
		1	5	24.70	23.80	23.59	23.49	
		3	0	24.70	23.62	23.44	23.44	
		3	2	24.70	23.73	23.55	23.43	
		3	3	24.70	23.71	23.43	23.42	
	16QAM	6	0	23.70	22.74	22.47	22.48	
		1	0	23.70	22.73	22.59	22.48	
		1	3	23.70	22.76	22.75	22.70	
		1	5	23.70	22.73	22.69	22.65	
		3	0	23.70	22.80	22.56	22.55	
		3	2	23.70	22.69	22.44	22.59	
	64QAM	3	3	23.70	22.66	22.54	22.51	
		6	0	22.70	21.77	21.62	21.47	
		1	0	22.70	21.64	21.57	21.88	
		1	3	22.70	21.85	21.55	21.84	
		1	5	22.70	21.74	21.66	21.85	
		3	0	22.70	21.78	21.50	21.67	
	3MHz	QPSK	3	2	22.70	21.69	21.55	21.71
			3	3	22.70	21.76	21.56	21.77
			6	0	21.70	20.82	20.49	20.27
1			0	24.70	23.54	23.43	23.45	
1			7	24.70	23.53	23.48	23.53	
1			14	24.70	23.58	23.44	23.55	
16QAM		8	0	23.70	22.72	22.66	22.66	
		8	4	23.70	22.71	22.40	22.33	
		8	7	23.70	22.71	22.44	22.67	
		15	0	23.70	21.44	21.50	21.66	
		1	0	23.70	22.74	22.53	22.72	
		1	7	23.70	22.52	22.41	22.57	
64QAM		1	14	23.70	22.66	22.58	22.65	
		8	0	22.70	21.75	21.52	21.31	
		8	4	22.70	21.70	21.46	21.65	
		8	7	22.70	21.75	21.54	21.65	
		15	0	22.70	21.50	21.39	21.60	
		1	0	22.70	21.58	21.60	21.73	
64QAM		1	7	22.70	21.68	21.41	21.82	
		1	14	22.70	21.56	21.55	21.82	
		8	0	21.70	20.72	20.51	20.43	
	8	4	21.70	20.71	20.52	20.65		
	8	7	21.70	20.79	20.50	20.40		
	15	0	21.70	20.59	20.63	20.64		

Bandwidth	Modulation	RB size	RB offset	Tune-up	Channel	Channel	Channel
				Max.	26715CH	26865CH	27015CH
5MHz	QPSK	1	0	24.70	23.64	23.49	23.51
		1	13	24.70	23.65	23.48	23.48
		1	24	24.70	23.52	23.47	23.49
		12	0	23.70	22.78	22.54	22.65
		12	6	23.70	22.77	22.52	22.65
		12	13	23.70	22.78	22.54	22.65
		25	0	23.70	22.76	22.56	22.68
	16QAM	1	0	23.70	22.88	22.64	22.71
		1	13	23.70	22.81	22.64	22.55
		1	24	23.70	23.02	22.58	22.73
		12	0	22.70	21.67	21.50	21.61
		12	6	22.70	21.74	21.50	21.64
		12	13	22.70	21.76	21.47	21.67
		25	0	22.70	21.68	21.37	21.59
	64QAM	1	0	22.70	21.63	21.56	21.47
		1	13	22.70	21.86	21.62	21.58
		1	24	22.70	21.84	21.54	21.60
		12	0	21.70	20.71	20.54	20.68
		12	6	21.70	20.77	20.55	20.66
		12	13	21.70	20.78	20.56	20.70
		25	0	21.70	20.77	20.50	20.65
Bandwidth	Modulation	RB size	RB offset	Tune-up	Channel	Channel	Channel
10MHz	QPSK	1	0	24.70	23.58	23.84	23.40
		1	25	24.70	23.53	23.79	23.49
		1	49	24.70	23.49	23.78	23.51
		25	0	23.70	22.81	22.60	22.47
		25	13	23.70	22.82	22.60	22.44
		25	25	23.70	22.79	22.52	22.46
		50	0	23.70	22.42	22.57	22.54
	16QAM	1	0	23.70	22.66	22.43	22.51
		1	25	23.70	22.54	22.49	22.66
		1	49	23.70	22.56	22.49	22.64
		25	0	22.70	21.73	21.61	21.39
		25	13	22.70	21.74	21.59	21.41
		25	25	22.70	21.76	21.59	21.40
		50	0	22.70	21.58	21.51	21.52
	64QAM	1	0	22.70	21.64	21.55	21.52
		1	25	22.70	21.59	21.45	21.63
		1	49	22.70	21.66	21.62	21.54
		25	0	21.70	20.39	20.50	20.54
		25	13	21.70	20.46	20.54	20.44
		25	25	21.70	20.54	20.53	20.46
		50	0	21.70	20.65	20.59	20.37

Bandwidth	Modulation	RB size	RB offset	Tune-up	Channel	Channel	Channel
				Max.	26765CH	26865CH	26965CH
15MHz	QPSK	1	0	24.70	23.52	23.81	23.61
		1	38	24.70	23.54	23.80	23.66
		1	74	24.70	23.58	23.85	23.59
		36	0	23.70	22.82	22.59	22.70
		36	18	23.70	22.84	22.58	22.70
		36	39	23.70	22.83	22.58	22.48
		75	0	23.70	22.40	22.57	22.43
	16QAM	1	0	23.70	22.64	22.56	22.48
		1	38	23.70	22.51	22.46	22.44
		1	74	23.70	22.71	22.48	22.37
		36	0	22.70	21.78	21.52	21.67
		36	18	22.70	21.74	21.51	21.66
		36	39	22.70	21.76	21.53	21.64
		75	0	22.70	21.50	21.36	21.36
	64QAM	1	0	22.70	21.58	21.52	21.56
		1	38	22.70	21.81	21.57	21.44
		1	74	22.70	21.73	21.40	21.32
		36	0	21.70	20.80	20.56	20.71
		36	18	21.70	20.82	20.59	20.74
		36	39	21.70	20.81	20.56	20.65
		75	0	21.70	20.53	20.61	20.53

Table 83: Conducted power measurement results of LTE Band 26 (Full Power)

7.1.24 Conducted power measurements of LTE Band 26(Main antenna)

Bandwidth	Modulation	RB size	RB offset	Tune-up	Channel	Channel	Channel	
				Max.	26697CH	26865CH	27033CH	
1.4MHz	QPSK	1	0	25.00	23.74	23.71	23.79	
		1	3	25.00	23.79	23.73	23.82	
		1	5	25.00	24.09	23.74	23.79	
		3	0	25.00	23.86	23.77	23.69	
		3	2	25.00	23.85	23.91	23.60	
		3	3	25.00	23.82	23.76	23.66	
		6	0	24.00	22.89	22.82	22.75	
	16QAM	1	0	24.00	22.95	22.82	22.70	
		1	3	24.00	22.97	22.74	22.74	
		1	5	24.00	22.97	22.78	22.81	
		3	0	24.00	22.89	22.78	22.71	
		3	2	24.00	22.84	22.88	22.74	
		3	3	24.00	22.80	22.82	22.67	
		6	0	23.00	21.91	21.74	21.71	
	64QAM	1	0	23.00	21.79	21.59	21.91	
		1	3	23.00	22.03	21.72	21.82	
		1	5	23.00	21.74	21.93	21.84	
		3	0	23.00	22.03	21.86	21.67	
		3	2	23.00	22.07	22.05	21.61	
		3	3	23.00	22.04	21.91	21.73	
		6	0	22.00	20.94	20.75	20.66	
	Bandwidth	Modulation	RB size	RB offset	Tune-up	Channel	Channel	Channel
	3MHz	QPSK	1	0	25.00	23.81	23.75	23.76
			1	7	25.00	23.84	23.70	23.77
1			14	25.00	23.79	23.71	23.78	
8			0	24.00	22.88	22.90	22.69	
8			4	24.00	22.87	22.89	22.68	
8			7	24.00	22.86	22.89	22.69	
15			0	24.00	21.83	21.86	21.69	
16QAM		1	0	24.00	23.08	22.86	22.49	
		1	7	24.00	22.98	22.78	22.56	
		1	14	24.00	22.98	22.85	22.72	
		8	0	23.00	21.83	21.84	21.65	
		8	4	23.00	21.85	21.93	21.67	
		8	7	23.00	21.87	21.85	21.72	
		15	0	23.00	21.81	21.79	21.64	
64QAM		1	0	23.00	22.15	21.77	21.74	
		1	7	23.00	22.09	21.82	21.73	
		1	14	23.00	21.77	22.11	21.75	
		8	0	22.00	20.93	20.60	20.79	
		8	4	22.00	20.95	20.64	20.78	
		8	7	22.00	20.94	20.63	20.73	
		15	0	22.00	20.77	20.85	20.61	
Bandwidth		Modulation	RB size	RB offset	Tune-up	Channel	Channel	Channel
					Max.	26705CH	26865CH	27025CH

Bandwidth	Modulation	RB size	RB offset	Tune-up	Channel	Channel	Channel
				Max.	26715CH	26865CH	27015CH
5MHz	QPSK	1	0	25.00	23.84	23.84	23.72
		1	13	25.00	23.85	23.84	23.69
		1	24	25.00	23.85	23.85	23.71
		12	0	24.00	22.91	22.96	22.75
		12	6	24.00	22.89	22.98	22.75
		12	13	24.00	22.89	22.92	22.75
		25	0	24.00	22.83	22.93	22.62
	16QAM	1	0	24.00	23.02	23.05	23.03
		1	13	24.00	22.97	23.10	22.81
		1	24	24.00	22.98	23.08	23.05
		12	0	23.00	21.89	21.98	21.60
		12	6	23.00	21.91	21.94	21.48
		12	13	23.00	21.92	21.91	21.52
		25	0	23.00	21.77	21.89	21.54
	64QAM	1	0	23.00	21.85	22.01	21.89
		1	13	23.00	21.89	22.18	22.02
		1	24	23.00	22.05	22.03	22.02
		12	0	22.00	21.02	20.96	20.59
		12	6	22.00	20.95	20.96	20.62
		12	13	22.00	20.99	20.98	20.62
		25	0	22.00	20.86	20.70	20.62
Bandwidth	Modulation	RB size	RB offset	Tune-up	Channel	Channel	Channel
10MHz	QPSK	1	0	25.00	23.82	23.81	23.94
		1	25	25.00	23.83	23.83	23.92
		1	49	25.00	23.86	23.80	23.93
		25	0	24.00	22.88	23.00	22.77
		25	13	24.00	22.87	22.85	22.92
		25	25	24.00	22.86	23.02	22.95
		50	0	24.00	22.95	22.95	22.82
	16QAM	1	0	24.00	22.87	22.90	22.98
		1	25	24.00	22.88	22.93	22.71
		1	49	24.00	22.65	22.91	22.62
		25	0	23.00	21.83	21.85	21.78
		25	13	23.00	21.86	21.86	21.88
		25	25	23.00	21.86	21.94	21.76
		50	0	23.00	21.87	21.66	21.83
	64QAM	1	0	23.00	22.15	21.85	21.99
		1	25	23.00	21.83	21.82	21.85
		1	49	23.00	21.99	21.92	21.94
		25	0	22.00	20.70	20.95	20.84
		25	13	22.00	20.68	20.91	20.85
		25	25	22.00	20.74	20.94	20.88
		50	0	22.00	20.96	20.81	20.83
Bandwidth	Modulation	RB size	RB offset	Tune-up	Channel	Channel	Channel
				Max.	26740CH	26865CH	26990CH

Bandwidth	Modulation	RB size	RB offset	Tune-up	Channel	Channel	Channel
				Max.	26765CH	26865CH	26965CH
15MHz	QPSK	1	0	25.00	23.85	23.87	23.74
		1	38	25.00	23.86	24.01	23.72
		1	74	25.00	23.85	23.98	23.71
		36	0	24.00	22.76	23.03	22.69
		36	18	24.00	22.78	23.03	22.68
		36	39	24.00	22.79	23.04	22.68
		75	0	24.00	22.93	22.99	22.68
	16QAM	1	0	24.00	23.07	23.11	22.83
		1	38	24.00	22.93	22.90	22.83
		1	74	24.00	22.93	23.07	22.85
		36	0	23.00	21.69	22.00	21.68
		36	18	23.00	21.75	21.99	21.65
		36	39	23.00	21.74	22.02	21.63
		75	0	23.00	21.84	21.61	21.60
	64QAM	1	0	23.00	21.87	22.24	22.11
		1	38	23.00	22.12	22.16	21.94
		1	74	23.00	22.35	21.92	21.78
		36	0	22.00	20.76	21.01	20.68
		36	18	22.00	20.74	20.97	20.70
		36	39	22.00	20.73	20.99	20.69
		75	0	22.00	20.92	20.70	20.67

Table 84: Conducted power measurement results of LTE Band 26

7.1.25 Conducted power measurements of LTE Band 38(Second antenna)

Bandwidth	Modulation	RB size	RB offset	Tune-up	Channel	Channel	Channel
				Max.	37775CH	38000CH	38225CH
5MHz	QPSK	1	0	19.00	18.42	18.30	18.05
		1	13	19.00	18.43	18.31	18.05
		1	24	19.00	18.53	18.31	18.06
		12	0	19.00	18.55	18.34	18.27
		12	6	19.00	18.55	18.35	18.15
		12	13	19.00	18.55	18.36	18.15
		25	0	19.00	18.44	18.18	18.09
	16QAM	1	0	19.00	18.54	18.42	18.33
		1	13	19.00	18.54	18.42	18.53
		1	24	19.00	18.65	18.42	18.34
		12	0	19.00	18.52	18.40	18.09
		12	6	19.00	18.51	18.41	18.10
		12	13	19.00	18.50	18.41	18.34
		25	0	19.00	18.28	18.10	18.18
	64QAM	1	0	19.00	18.77	18.67	18.60
		1	13	19.00	18.62	18.68	18.41
		1	24	19.00	18.61	18.67	18.41
		12	0	19.00	18.52	18.32	18.37
		12	6	19.00	18.52	18.33	18.16
		12	13	19.00	18.52	18.32	18.16
		25	0	19.00	18.18	18.16	18.02
Bandwidth	Modulation	RB size	RB offset	Tune-up	Channel	Channel	Channel
10MHz	QPSK	1	0	19.00	18.43	18.43	18.23
		1	25	19.00	18.43	18.43	18.22
		1	49	19.00	18.43	18.43	18.22
		25	0	19.00	18.53	18.43	18.16
		25	13	19.00	18.60	18.44	18.08
		25	25	19.00	18.61	18.44	18.16
		50	0	19.00	18.25	18.13	18.24
	16QAM	1	0	19.00	18.13	18.28	18.23
		1	25	19.00	18.22	18.28	18.07
		1	49	19.00	18.22	18.28	18.07
		25	0	19.00	18.38	18.34	18.12
		25	13	19.00	18.38	18.35	18.00
		25	25	19.00	18.39	18.35	18.01
		50	0	19.00	18.09	18.05	18.14
	64QAM	1	0	19.00	18.89	18.73	18.71
		1	25	19.00	18.89	18.71	18.52
		1	49	19.00	18.63	18.68	18.52
		25	0	19.00	18.27	18.31	18.07
		25	13	19.00	18.27	18.31	18.24
		25	25	19.00	18.27	18.32	18.32
		50	0	19.00	18.39	18.09	18.12
Bandwidth	Modulation	RB size	RB offset	Tune-up	Channel	Channel	Channel
				Max.	37800CH	38000CH	38200CH

Bandwidth	Modulation	RB size	RB offset	Tune-up	Channel	Channel	Channel
				Max.	37825CH	38000CH	38175CH
15MHz	QPSK	1	0	19.00	18.48	18.45	18.38
		1	38	19.00	18.38	18.45	18.37
		1	74	19.00	18.37	18.54	18.37
		36	0	19.00	18.40	18.38	18.34
		36	18	19.00	18.40	18.45	18.33
		36	39	19.00	18.39	18.45	18.33
		75	0	19.00	18.25	18.36	18.05
	16QAM	1	0	19.00	18.96	18.79	18.72
		1	38	19.00	18.95	18.62	18.75
		1	74	19.00	18.95	18.77	18.71
		36	0	19.00	18.20	18.31	18.31
		36	18	19.00	18.20	18.33	18.31
		36	39	19.00	18.20	18.33	18.31
		75	0	19.00	18.21	18.24	17.96
	64QAM	1	0	19.00	18.76	18.56	18.67
		1	38	19.00	18.75	18.72	18.73
		1	74	19.00	18.75	18.55	18.52
		36	0	19.00	18.34	18.10	18.16
		36	18	19.00	18.33	18.31	18.16
		36	39	19.00	18.45	18.21	18.16
		75	0	19.00	18.07	18.13	18.05
Bandwidth	Modulation	RB size	RB offset	Tune-up	Channel	Channel	Channel
20MHz	QPSK	1	0	19.00	18.36	18.41	18.19
		1	50	19.00	18.37	18.54	18.36
		1	99	19.00	18.36	18.47	18.35
		50	0	19.00	18.19	18.37	18.22
		50	25	19.00	18.19	18.39	18.21
		50	50	19.00	18.19	18.38	18.29
		100	0	19.00	18.41	18.23	18.06
	16QAM	1	0	19.00	18.74	18.66	18.39
		1	50	19.00	18.71	18.62	18.40
		1	99	19.00	18.54	18.56	18.40
		50	0	19.00	18.39	18.26	18.16
		50	25	19.00	18.39	18.17	18.16
		50	50	19.00	18.40	18.21	18.16
		100	0	19.00	18.20	18.13	18.11
	64QAM	1	0	19.00	18.69	18.73	18.68
		1	50	19.00	18.68	18.72	18.68
		1	99	19.00	18.68	18.72	18.68
		50	0	19.00	18.28	18.05	18.01
		50	25	19.00	18.28	18.19	18.07
		50	50	19.00	18.28	18.19	18.00
		100	0	19.00	18.15	18.05	18.05
Bandwidth	Modulation	RB size	RB offset	Tune-up	Channel	Channel	Channel
				Max.	37850CH	38000CH	38150CH

Table 85: Conducted power measurement results of LTE Band 38 (Reduced Power Level D1)

Bandwidth	Modulation	RB size	RB offset	Tune-up	Channel	Channel	Channel
				Max.	37775CH	38000CH	38225CH
5MHz	QPSK	1	0	23.50	22.68	22.60	22.51
		1	13	23.50	22.69	22.60	22.51
		1	24	23.50	22.81	22.60	22.51
		12	0	22.50	21.77	21.75	21.64
		12	6	22.50	21.77	21.76	21.54
		12	13	22.50	21.77	21.76	21.55
		25	0	22.50	21.71	21.62	21.52
	16QAM	1	0	22.50	21.81	21.81	21.67
		1	13	22.50	21.82	21.81	21.79
		1	24	22.50	21.92	21.81	21.68
		12	0	21.50	20.85	20.71	20.55
		12	6	21.50	20.84	20.69	20.54
		12	13	21.50	20.85	20.68	20.73
		25	0	21.50	20.69	20.56	20.51
	64QAM	1	0	21.50	21.13	21.06	20.92
		1	13	21.50	21.01	21.06	20.80
		1	24	21.50	21.01	21.05	20.79
		12	0	20.50	19.92	19.82	19.80
		12	6	20.50	19.92	19.82	19.64
		12	13	20.50	19.92	19.83	19.65
		25	0	20.50	19.68	19.62	19.53
Bandwidth	Modulation	RB size	RB offset	Tune-up	Channel	Channel	Channel
10MHz	QPSK	1	0	23.50	22.68	22.65	22.56
		1	25	23.50	22.70	22.66	22.56
		1	49	23.50	22.70	22.66	22.56
		25	0	22.50	21.83	21.78	21.44
		25	13	22.50	21.87	21.78	21.74
		25	25	22.50	21.87	21.78	21.44
		50	0	22.50	21.59	21.62	21.67
	16QAM	1	0	22.50	21.83	21.51	21.62
		1	25	22.50	21.53	21.51	21.45
		1	49	22.50	21.53	21.51	21.45
		25	0	21.50	20.75	20.71	20.49
		25	13	21.50	20.75	20.71	20.36
		25	25	21.50	20.75	20.71	20.36
		50	0	21.50	20.47	20.56	20.50
	64QAM	1	0	21.50	21.28	20.97	21.07
		1	25	21.50	21.27	20.97	20.89
		1	49	21.50	20.98	20.96	20.88
		25	0	20.50	19.77	19.74	19.56
		25	13	20.50	19.77	19.74	19.73
		25	25	20.50	19.77	19.74	19.79
		50	0	20.50	19.87	19.54	19.51
Bandwidth	Modulation	RB size	RB offset	Tune-up	Channel	Channel	Channel
				Max.	37800CH	38000CH	38200CH

Bandwidth	Modulation	RB size	RB offset	Tune-up	Channel	Channel	Channel
				Max.	37825CH	38000CH	38175CH
15MHz	QPSK	1	0	23.50	22.73	22.99	22.66
		1	38	23.50	23.00	22.98	22.69
		1	74	23.50	23.00	22.64	22.69
		36	0	22.50	21.71	21.64	21.70
		36	18	22.50	21.71	21.71	21.68
		36	39	22.50	21.71	21.71	21.68
		75	0	22.50	21.92	21.68	21.74
	16QAM	1	0	22.50	22.22	21.93	22.08
		1	38	22.50	22.21	22.25	22.08
		1	74	22.50	22.21	21.92	22.07
		36	0	21.50	20.59	20.46	20.58
		36	18	21.50	20.58	20.68	20.64
		36	39	21.50	20.58	20.68	20.63
		75	0	21.50	20.61	20.59	20.33
	64QAM	1	0	21.50	21.14	20.83	21.01
		1	38	21.50	21.14	20.98	21.07
		1	74	21.50	21.14	20.84	20.89
		36	0	20.50	19.83	19.57	19.64
		36	18	20.50	19.83	19.79	19.65
		36	39	20.50	19.94	19.63	19.65
		75	0	20.50	19.55	19.61	19.56
Bandwidth	Modulation	RB size	RB offset	Tune-up	Channel	Channel	Channel
20MHz	QPSK	1	0	23.50	22.96	22.95	22.74
		1	50	23.50	22.96	22.65	22.93
		1	99	23.50	22.95	22.75	22.93
		50	0	22.50	21.90	21.61	21.55
		50	25	22.50	21.90	21.61	21.55
		50	50	22.50	21.90	21.62	21.54
		100	0	22.50	21.75	21.57	21.45
	16QAM	1	0	22.50	22.15	21.88	21.98
		1	50	22.50	22.15	21.88	21.98
		1	99	22.50	22.19	22.19	21.98
		50	0	21.50	20.83	20.52	20.50
		50	25	21.50	20.83	20.75	20.50
		50	50	21.50	20.84	20.52	20.50
		100	0	21.50	20.61	20.48	20.45
	64QAM	1	0	21.50	21.21	20.85	21.01
		1	50	21.50	21.21	20.85	21.01
		1	99	21.50	21.20	20.85	21.00
		50	0	20.50	19.78	19.49	19.48
		50	25	20.50	19.78	19.71	19.56
		50	50	20.50	19.78	19.71	19.49
		100	0	20.50	19.65	19.53	19.46
Bandwidth	Modulation	RB size	RB offset	Tune-up	Channel	Channel	Channel
20MHz	QPSK	1	0	23.50	22.96	22.95	22.74
		1	50	23.50	22.96	22.65	22.93
		1	99	23.50	22.95	22.75	22.93
		50	0	22.50	21.90	21.61	21.55
		50	25	22.50	21.90	21.61	21.55
		50	50	22.50	21.90	21.62	21.54
		100	0	22.50	21.75	21.57	21.45
	16QAM	1	0	22.50	22.15	21.88	21.98
		1	50	22.50	22.15	21.88	21.98
		1	99	22.50	22.19	22.19	21.98
		50	0	21.50	20.83	20.52	20.50
		50	25	21.50	20.83	20.75	20.50
		50	50	21.50	20.84	20.52	20.50
		100	0	21.50	20.61	20.48	20.45
	64QAM	1	0	21.50	21.21	20.85	21.01
		1	50	21.50	21.21	20.85	21.01
		1	99	21.50	21.20	20.85	21.00
		50	0	20.50	19.78	19.49	19.48
		50	25	20.50	19.78	19.71	19.56
		50	50	20.50	19.78	19.71	19.49
		100	0	20.50	19.65	19.53	19.46

Table 86: Conducted power measurement results of LTE Band 38 (Full Power)

Bandwidth	Modulation	RB size	RB offset	Tune-up	Channel	Channel	Channel
				Max.	37775CH	38000CH	38225CH
5MHz	QPSK	1	0	18.00	17.33	17.20	17.25
		1	13	18.00	17.32	17.20	17.25
		1	24	18.00	17.57	17.21	17.25
		12	0	18.00	17.49	17.40	17.29
		12	6	18.00	17.48	17.41	17.20
		12	13	18.00	17.49	17.41	17.20
		25	0	18.00	17.30	17.17	17.06
	16QAM	1	0	18.00	17.48	17.47	17.58
		1	13	18.00	17.50	17.46	17.55
		1	24	18.00	17.32	17.46	17.57
		12	0	18.00	17.56	17.34	17.13
		12	6	18.00	17.57	17.35	17.14
		12	13	18.00	17.57	17.34	17.33
		25	0	18.00	17.35	17.12	17.17
	64QAM	1	0	18.00	17.60	17.71	17.62
		1	13	18.00	17.49	17.71	17.62
		1	24	18.00	17.38	17.71	17.62
		12	0	18.00	17.54	17.45	17.41
		12	6	18.00	17.55	17.46	17.24
		12	13	18.00	17.55	17.45	17.24
		25	0	18.00	17.20	17.18	17.09
Bandwidth	Modulation	RB size	RB offset	Tune-up	Channel	Channel	Channel
10MHz	QPSK	1	0	18.00	17.47	17.45	17.22
		1	25	18.00	17.47	17.45	17.21
		1	49	18.00	17.47	17.45	17.21
		25	0	18.00	17.48	17.46	17.11
		25	13	18.00	17.55	17.46	17.07
		25	25	18.00	17.55	17.46	17.12
		50	0	18.00	17.24	17.20	17.20
	16QAM	1	0	18.00	17.11	17.28	17.28
		1	25	18.00	17.24	17.27	17.07
		1	49	18.00	17.24	17.27	17.07
		25	0	18.00	17.42	17.33	17.19
		25	13	18.00	17.43	17.34	17.05
		25	25	18.00	17.43	17.34	17.07
		50	0	18.00	17.08	17.07	17.15
	64QAM	1	0	18.00	17.68	17.45	17.68
		1	25	18.00	17.67	17.44	17.73
		1	49	18.00	17.67	17.46	17.73
		25	0	18.00	17.32	17.37	17.10
		25	13	18.00	17.32	17.38	17.28
		25	25	18.00	17.32	17.37	17.38
		50	0	18.00	17.45	17.06	17.16
Bandwidth	Modulation	RB size	RB offset	Tune-up	Channel	Channel	Channel
				Max.	37800CH	38000CH	38200CH

Bandwidth	Modulation	RB size	RB offset	Tune-up	Channel	Channel	Channel
				Max.	37825CH	38000CH	38175CH
15MHz	QPSK	1	0	18.00	17.53	17.53	17.30
		1	38	18.00	17.43	17.52	17.30
		1	74	18.00	17.43	17.59	17.29
		36	0	18.00	17.36	17.51	17.36
		36	18	18.00	17.37	17.41	17.37
		36	39	18.00	17.37	17.41	17.37
		75	0	18.00	17.16	17.36	17.37
	16QAM	1	0	18.00	17.50	17.79	17.78
		1	38	18.00	17.51	17.62	17.76
		1	74	18.00	17.61	17.78	17.76
		36	0	18.00	17.19	17.26	17.26
		36	18	18.00	17.19	17.37	17.29
		36	39	18.00	17.19	17.37	17.31
		75	0	18.00	17.23	17.18	17.00
	64QAM	1	0	18.00	17.87	17.60	17.73
		1	38	18.00	17.86	17.81	17.73
		1	74	18.00	17.86	17.59	17.73
		36	0	18.00	17.40	17.13	17.28
		36	18	18.00	17.40	17.37	17.28
		36	39	18.00	17.50	17.26	17.27
		75	0	18.00	17.09	17.27	17.12
Bandwidth	Modulation	RB size	RB offset	Tune-up	Channel	Channel	Channel
20MHz	QPSK	1	0	18.00	17.41	17.53	17.19
		1	50	18.00	17.41	17.56	17.39
		1	99	18.00	17.41	17.45	17.42
		50	0	18.00	17.14	17.35	17.25
		50	25	18.00	17.13	17.35	17.24
		50	50	18.00	17.14	17.35	17.24
		100	0	18.00	17.37	17.24	17.14
	16QAM	1	0	18.00	17.68	17.54	17.40
		1	50	18.00	17.69	17.56	17.41
		1	99	18.00	17.65	17.60	17.41
		50	0	18.00	17.48	17.25	17.18
		50	25	18.00	17.49	17.11	17.17
		50	50	18.00	17.49	17.26	17.17
		100	0	18.00	17.21	17.08	17.04
	64QAM	1	0	18.00	17.54	17.55	17.44
		1	50	18.00	17.56	17.57	17.40
		1	99	18.00	17.52	17.52	17.41
		50	0	18.00	17.34	17.09	17.14
		50	25	18.00	17.34	17.23	17.14
		50	50	18.00	17.34	17.23	17.14
		100	0	18.00	17.16	17.14	17.13
Bandwidth	Modulation	RB size	RB offset	Tune-up	Channel	Channel	Channel
				Max.	37850CH	38000CH	38150CH

Table 87: Conducted power measurement results of LTE Band 38 (Reduced Power Level D3)

Bandwidth	Modulation	RB size	RB offset	Tune-up	Channel	Channel	Channel
				Max.	37775CH	38000CH	38225CH
5MHz	QPSK	1	0	22.50	21.82	21.69	21.54
		1	13	22.50	21.83	21.69	21.54
		1	24	22.50	21.96	21.69	21.54
		12	0	22.50	21.78	21.76	21.64
		12	6	22.50	21.78	21.76	21.55
		12	13	22.50	21.78	21.76	21.55
		25	0	22.50	21.71	21.60	21.50
	16QAM	1	0	22.50	21.81	21.81	21.68
		1	13	22.50	21.81	21.80	21.80
		1	24	22.50	21.92	21.81	21.68
		12	0	21.50	20.84	20.68	20.55
		12	6	21.50	20.84	20.68	20.55
		12	13	21.50	20.85	20.68	20.74
		25	0	21.50	20.68	20.58	20.51
	64QAM	1	0	21.50	21.13	21.06	20.93
		1	13	21.50	21.01	21.06	20.80
		1	24	21.50	21.01	21.06	20.80
		12	0	20.50	19.92	19.82	19.81
		12	6	20.50	19.92	19.83	19.65
		12	13	20.50	19.92	19.82	19.65
		25	0	20.50	19.68	19.62	19.53
Bandwidth	Modulation	RB size	RB offset	Tune-up	Channel	Channel	Channel
10MHz	QPSK	1	0	22.50	21.83	21.61	21.66
		1	25	22.50	21.84	21.61	21.65
		1	49	22.50	21.84	21.61	21.66
		25	0	22.50	21.84	21.79	21.45
		25	13	22.50	21.88	21.79	21.75
		25	25	22.50	21.88	21.79	21.44
		50	0	22.50	21.60	21.64	21.68
	16QAM	1	0	22.50	21.84	21.52	21.64
		1	25	22.50	21.54	21.52	21.47
		1	49	22.50	21.54	21.51	21.46
		25	0	21.50	20.75	20.71	20.51
		25	13	21.50	20.75	20.71	20.35
		25	25	21.50	20.75	20.72	20.35
		50	0	21.50	20.47	20.56	20.50
	64QAM	1	0	21.50	21.28	20.97	21.09
		1	25	21.50	21.27	20.97	20.90
		1	49	21.50	20.98	20.97	20.88
		25	0	20.50	19.77	19.74	19.56
		25	13	20.50	19.77	19.75	19.73
		25	25	20.50	19.77	19.75	19.78
		50	0	20.50	19.87	19.53	19.51

Bandwidth	Modulation	RB size	RB offset	Tune-up	Channel	Channel	Channel
				Max.	37825CH	38000CH	38175CH
15MHz	QPSK	1	0	22.50	21.88	22.10	21.75
		1	38	22.50	22.19	22.08	21.75
		1	74	22.50	22.19	21.82	21.77
		36	0	22.50	21.71	21.65	21.71
		36	18	22.50	21.71	21.72	21.69
		36	39	22.50	21.71	21.71	21.69
		75	0	22.50	21.93	21.69	21.75
	16QAM	1	0	22.50	22.22	21.93	22.10
		1	38	22.50	22.22	22.26	22.09
		1	74	22.50	22.21	21.93	22.08
		36	0	21.50	20.59	20.46	20.60
		36	18	21.50	20.59	20.68	20.65
		36	39	21.50	20.59	20.68	20.64
		75	0	21.50	20.61	20.60	20.33
	64QAM	1	0	21.50	21.15	20.84	21.01
		1	38	21.50	21.15	20.99	21.07
		1	74	21.50	21.15	20.83	20.90
		36	0	20.50	19.83	19.56	19.65
		36	18	20.50	19.83	19.79	19.66
		36	39	20.50	19.94	19.64	19.65
		75	0	20.50	19.55	19.62	19.56
Bandwidth	Modulation	RB size	RB offset	Tune-up	Channel	Channel	Channel
20MHz	QPSK	1	0	22.50	22.18	22.14	21.98
		1	50	22.50	22.18	21.82	22.04
		1	99	22.50	22.18	21.93	22.04
		50	0	22.50	21.91	21.62	21.56
		50	25	22.50	21.90	21.62	21.56
		50	50	22.50	21.91	21.62	21.55
		100	0	22.50	21.76	21.54	21.47
	16QAM	1	0	22.50	22.16	21.89	21.98
		1	50	22.50	22.16	21.89	21.99
		1	99	22.50	22.19	22.10	21.98
		50	0	21.50	20.84	20.53	20.51
		50	25	21.50	20.84	20.75	20.50
		50	50	21.50	20.84	20.53	20.50
		100	0	21.50	20.61	20.49	20.46
	64QAM	1	0	21.50	21.21	20.86	21.01
		1	50	21.50	21.21	20.86	21.01
		1	99	21.50	21.20	20.85	21.01
		50	0	20.50	19.78	19.49	19.52
		50	25	20.50	19.79	19.71	19.56
		50	50	20.50	19.79	19.71	19.51
		100	0	20.50	19.65	19.53	19.47
Bandwidth	Modulation	RB size	RB offset	Tune-up	Channel	Channel	Channel
				Max.	37850CH	38000CH	38150CH

Table 88: Conducted power measurement results of LTE Band 38 (Reduced Power Level D2)

7.1.26 Conducted power measurements of LTE Band 38(Main antenna)

Bandwidth	Modulation	RB size	RB offset	Tune-up	Channel	Channel	Channel
				Max.	37775CH	38000CH	38225CH
5MHz	QPSK	1	0	25.00	24.17	24.10	24.23
		1	13	25.00	24.17	24.11	24.14
		1	24	25.00	24.21	24.11	24.14
		12	0	24.00	23.29	23.26	23.26
		12	6	24.00	23.28	23.19	23.26
		12	13	24.00	23.27	23.19	23.26
		25	0	24.00	23.30	23.13	23.16
	16QAM	1	0	24.00	23.36	23.31	23.41
		1	13	24.00	23.36	23.31	23.32
		1	24	24.00	23.37	23.31	23.31
		12	0	23.00	22.35	22.31	22.31
		12	6	23.00	22.35	22.29	22.31
		12	13	23.00	22.35	22.30	22.32
		25	0	23.00	21.97	22.25	22.31
	64QAM	1	0	23.00	22.61	22.52	22.59
		1	13	23.00	22.60	22.53	22.58
		1	24	23.00	22.61	22.53	22.59
		12	0	22.00	21.36	21.36	21.44
		12	6	22.00	21.36	21.36	21.47
		12	13	22.00	21.36	21.36	21.43
		25	0	22.00	21.17	21.08	21.20
Bandwidth	Modulation	RB size	RB offset	Tune-up	Channel	Channel	Channel
10MHz	QPSK	1	0	25.00	24.11	24.20	24.16
		1	25	25.00	24.11	24.19	24.16
		1	49	25.00	24.10	24.19	24.16
		25	0	24.00	23.31	23.10	23.31
		25	13	24.00	23.31	23.17	23.31
		25	25	24.00	23.32	23.17	23.31
		50	0	24.00	23.28	23.14	23.23
	16QAM	1	0	24.00	23.38	23.28	23.12
		1	25	24.00	23.37	22.97	23.13
		1	49	24.00	23.37	22.97	23.15
		25	0	23.00	22.17	22.26	22.27
		25	13	23.00	22.27	22.26	22.18
		25	25	23.00	22.18	22.26	22.27
		50	0	23.00	22.24	22.19	22.07
	64QAM	1	0	23.00	22.62	22.62	22.53
		1	25	23.00	22.62	22.62	22.52
		1	49	23.00	22.63	22.62	22.68
		25	0	22.00	21.31	21.36	21.41
		25	13	22.00	21.32	21.36	21.38
		25	25	22.00	21.32	21.37	21.38
		50	0	22.00	21.14	21.06	21.31
Bandwidth	Modulation	RB size	RB offset	Tune-up	Channel	Channel	Channel
				Max.	37800CH	38000CH	38200CH

Bandwidth	Modulation	RB size	RB offset	Tune-up	Channel	Channel	Channel
				Max.	37825CH	38000CH	38175CH
15MHz	QPSK	1	0	25.00	24.36	24.30	24.34
		1	38	25.00	24.49	24.42	24.39
		1	74	25.00	24.36	24.42	24.38
		36	0	24.00	23.22	23.16	23.21
		36	18	24.00	23.22	23.16	23.21
		36	39	24.00	23.22	23.16	23.20
		75	0	24.00	23.31	23.11	23.18
	16QAM	1	0	24.00	23.79	23.73	23.60
		1	38	24.00	23.79	23.73	23.59
		1	74	24.00	23.61	23.56	23.58
		36	0	23.00	22.38	22.37	22.29
		36	18	23.00	22.38	22.32	22.28
		36	39	23.00	22.29	22.37	22.28
		75	0	23.00	22.02	22.11	22.16
	64QAM	1	0	23.00	22.49	22.45	22.52
		1	38	23.00	22.49	22.45	22.55
		1	74	23.00	22.49	22.57	22.53
		36	0	22.00	21.43	21.23	21.34
		36	18	22.00	21.43	21.38	21.34
		36	39	22.00	21.43	21.33	21.34
		75	0	22.00	21.16	21.27	21.11
Bandwidth	Modulation	RB size	RB offset	Tune-up	Channel	Channel	Channel
20MHz	QPSK	1	0	25.00	24.42	24.18	24.18
		1	50	25.00	24.42	24.46	24.19
		1	99	25.00	24.25	24.46	24.45
		50	0	24.00	23.32	23.01	23.14
		50	25	24.00	23.19	23.12	23.14
		50	50	24.00	23.33	23.12	23.14
		100	0	24.00	23.04	23.13	23.24
	16QAM	1	0	24.00	23.64	23.54	23.42
		1	50	24.00	23.49	23.70	23.52
		1	99	24.00	23.49	23.69	23.52
		50	0	23.00	22.31	22.04	22.23
		50	25	23.00	22.32	22.27	22.18
		50	50	23.00	22.32	22.05	22.18
		100	0	23.00	21.95	21.94	22.17
	64QAM	1	0	23.00	22.78	22.69	22.41
		1	50	23.00	22.78	22.54	22.66
		1	99	23.00	22.77	22.53	22.66
		50	0	22.00	21.21	21.20	21.14
		50	25	22.00	21.22	21.05	21.12
		50	50	22.00	21.22	21.05	21.12
		100	0	22.00	21.19	21.20	21.17

Table 89: Conducted power measurement results of LTE Band 38 (Full Power)

Bandwidth	Modulation	RB size	RB offset	Tune-up	Channel	Channel	Channel
				Max.	37775CH	38000CH	38225CH
5MHz	QPSK	1	0	24.00	23.27	23.13	23.20
		1	13	24.00	23.26	23.13	23.18
		1	24	24.00	23.38	23.14	23.18
		12	0	24.00	23.29	23.26	23.27
		12	6	24.00	23.28	23.19	23.26
		12	13	24.00	23.28	23.19	23.26
		25	0	24.00	23.31	23.13	23.17
	16QAM	1	0	24.00	23.36	23.31	23.41
		1	13	24.00	23.36	23.32	23.33
		1	24	24.00	23.36	23.31	23.31
		12	0	23.00	22.35	22.31	22.31
		12	6	23.00	22.35	22.30	22.31
		12	13	23.00	22.33	22.31	22.32
		25	0	23.00	21.98	22.07	22.32
	64QAM	1	0	23.00	22.61	22.52	22.59
		1	13	23.00	22.61	22.53	22.59
		1	24	23.00	22.61	22.53	22.59
		12	0	22.00	21.35	21.36	21.44
		12	6	22.00	21.36	21.37	21.47
		12	13	22.00	21.36	21.36	21.44
		25	0	22.00	20.97	21.10	21.20
Bandwidth	Modulation	RB size	RB offset	Tune-up	Channel	Channel	Channel
10MHz	QPSK	1	0	24.00	23.22	23.33	23.25
		1	25	24.00	23.22	23.33	23.26
		1	49	24.00	23.23	23.33	23.26
		25	0	24.00	23.32	23.10	23.31
		25	13	24.00	23.32	23.17	23.31
		25	25	24.00	23.32	23.17	23.32
		50	0	24.00	23.28	23.14	23.23
	16QAM	1	0	24.00	23.37	23.29	23.11
		1	25	24.00	23.37	22.97	23.13
		1	49	24.00	23.38	22.98	23.15
		25	0	23.00	22.18	22.26	22.29
		25	13	23.00	22.27	22.26	22.20
		25	25	23.00	22.18	22.26	22.26
		50	0	23.00	22.24	22.01	22.08
	64QAM	1	0	23.00	22.63	22.62	22.54
		1	25	23.00	22.63	22.62	22.53
		1	49	23.00	22.63	22.62	22.69
		25	0	22.00	21.31	21.36	21.40
		25	13	22.00	21.32	21.36	21.38
		25	25	22.00	21.32	21.37	21.39
		50	0	22.00	20.93	21.03	21.31
Bandwidth	Modulation	RB size	RB offset	Tune-up	Channel	Channel	Channel
				Max.	37800CH	38000CH	38200CH

Bandwidth	Modulation	RB size	RB offset	Tune-up	Channel	Channel	Channel
				Max.	37825CH	38000CH	38175CH
15MHz	QPSK	1	0	24.00	23.52	23.47	23.42
		1	38	24.00	23.54	23.49	23.30
		1	74	24.00	23.50	23.49	23.30
		36	0	24.00	23.22	23.16	23.22
		36	18	24.00	23.22	23.16	23.22
		36	39	24.00	23.23	23.17	23.21
		75	0	24.00	23.32	23.12	23.19
	16QAM	1	0	24.00	23.79	23.74	23.61
		1	38	24.00	23.80	23.73	23.60
		1	74	24.00	23.61	23.56	23.59
		36	0	23.00	22.39	22.36	22.30
		36	18	23.00	22.39	22.33	22.29
		36	39	23.00	22.29	22.35	22.29
		75	0	23.00	22.02	22.09	22.16
	64QAM	1	0	23.00	22.49	22.46	22.53
		1	38	23.00	22.49	22.45	22.56
		1	74	23.00	22.49	22.57	22.52
		36	0	22.00	21.43	21.24	21.35
		36	18	22.00	21.43	21.38	21.34
		36	39	22.00	21.43	21.33	21.34
		75	0	22.00	20.96	21.28	21.11
Bandwidth	Modulation	RB size	RB offset	Tune-up	Channel	Channel	Channel
20MHz	QPSK	1	0	24.00	23.58	23.43	23.32
		1	50	24.00	23.58	23.21	23.33
		1	99	24.00	23.35	23.21	23.19
		50	0	24.00	23.33	23.01	23.15
		50	25	24.00	23.19	23.13	23.15
		50	50	24.00	23.33	23.12	23.15
		100	0	24.00	23.04	23.06	23.25
	16QAM	1	0	24.00	23.64	23.38	23.42
		1	50	24.00	23.49	23.51	23.52
		1	99	24.00	23.50	23.50	23.52
		50	0	23.00	22.32	22.04	22.23
		50	25	23.00	22.32	22.27	22.18
		50	50	23.00	22.30	22.05	22.18
		100	0	23.00	21.95	21.95	22.18
	64QAM	1	0	23.00	22.78	22.69	22.41
		1	50	23.00	22.78	22.53	22.66
		1	99	23.00	22.78	22.53	22.66
		50	0	22.00	21.21	21.19	21.15
		50	25	22.00	21.22	21.06	21.12
		50	50	22.00	21.22	21.03	21.13
		100	0	22.00	21.09	21.29	21.18
Bandwidth	Modulation	RB size	RB offset	Tune-up	Channel	Channel	Channel
				Max.	37850CH	38000CH	38150CH

Table 90: Conducted power measurement results of LTE Band 38 (Reduced Power Level D3/D5)

Bandwidth	Modulation	RB size	RB offset	Tune-up	Channel	Channel	Channel
				Max.	37775CH	38000CH	38225CH
5MHz	QPSK	1	0	23.00	22.39	22.19	22.23
		1	13	23.00	22.39	22.19	22.22
		1	24	23.00	22.16	22.19	22.22
		12	0	23.00	22.33	22.30	22.27
		12	6	23.00	22.36	22.24	22.27
		12	13	23.00	22.38	22.18	22.26
		25	0	23.00	22.33	22.13	22.19
	16QAM	1	0	23.00	22.44	22.31	22.43
		1	13	23.00	22.44	22.32	22.40
		1	24	23.00	22.44	22.31	22.39
		12	0	23.00	22.35	22.31	22.31
		12	6	23.00	22.35	22.29	22.30
		12	13	23.00	22.35	22.30	22.31
		25	0	23.00	21.97	22.25	22.30
	64QAM	1	0	23.00	22.60	22.52	22.59
		1	13	23.00	22.60	22.53	22.58
		1	24	23.00	22.60	22.52	22.59
		12	0	22.00	21.35	21.36	21.43
		12	6	22.00	21.36	21.36	21.46
		12	13	22.00	21.36	21.36	21.43
		25	0	22.00	21.17	21.07	21.20
Bandwidth	Modulation	RB size	RB offset	Tune-up	Channel	Channel	Channel
10MHz	QPSK	1	0	23.00	22.30	22.41	22.30
		1	25	23.00	22.29	22.38	22.29
		1	49	23.00	22.29	22.41	22.29
		25	0	23.00	22.36	22.38	22.39
		25	13	23.00	22.36	22.29	22.39
		25	25	23.00	22.36	22.30	22.39
		50	0	23.00	22.34	22.17	22.24
	16QAM	1	0	23.00	22.40	22.29	22.15
		1	25	23.00	22.40	22.09	22.16
		1	49	23.00	22.41	22.09	22.18
		25	0	23.00	22.17	22.25	22.26
		25	13	23.00	22.27	22.26	22.16
		25	25	23.00	22.17	22.26	22.27
		50	0	23.00	22.24	22.19	22.08
	64QAM	1	0	23.00	22.62	22.62	22.53
		1	25	23.00	22.62	22.61	22.52
		1	49	23.00	22.62	22.61	22.68
		25	0	22.00	21.31	21.36	21.41
		25	13	22.00	21.32	21.36	21.38
		25	25	22.00	21.32	21.37	21.38
		50	0	22.00	21.10	21.04	21.30
Bandwidth	Modulation	RB size	RB offset	Tune-up	Channel	Channel	Channel
				Max.	37800CH	38000CH	38200CH

Bandwidth	Modulation	RB size	RB offset	Tune-up	Channel	Channel	Channel
				Max.	37825CH	38000CH	38175CH
15MHz	QPSK	1	0	23.00	22.32	22.31	22.49
		1	38	23.00	22.44	22.43	22.54
		1	74	23.00	22.33	22.44	22.53
		36	0	23.00	22.38	22.22	22.27
		36	18	23.00	22.38	22.22	22.26
		36	39	23.00	22.38	22.22	22.26
		75	0	23.00	22.37	22.20	22.21
	16QAM	1	0	23.00	22.82	22.76	22.66
		1	38	23.00	22.82	22.75	22.65
		1	74	23.00	22.77	22.71	22.64
		36	0	23.00	22.38	22.37	22.29
		36	18	23.00	22.38	22.32	22.28
		36	39	23.00	22.29	22.37	22.28
		75	0	23.00	22.02	22.12	22.16
	64QAM	1	0	23.00	22.48	22.45	22.52
		1	38	23.00	22.49	22.45	22.55
		1	74	23.00	22.49	22.57	22.54
		36	0	22.00	21.43	21.24	21.34
		36	18	22.00	21.43	21.38	21.34
		36	39	22.00	21.43	21.33	21.34
		75	0	22.00	21.16	21.27	21.11
Bandwidth	Modulation	RB size	RB offset	Tune-up	Channel	Channel	Channel
20MHz	QPSK	1	0	23.00	22.35	22.20	22.42
		1	50	23.00	22.35	22.29	22.43
		1	99	23.00	22.51	22.29	22.64
		50	0	23.00	22.37	22.10	22.12
		50	25	23.00	22.33	22.24	22.12
		50	50	23.00	22.36	22.25	22.15
		100	0	23.00	22.09	22.15	22.25
	16QAM	1	0	23.00	22.68	22.64	22.51
		1	50	23.00	22.58	22.65	22.61
		1	99	23.00	22.58	22.63	22.60
		50	0	23.00	22.31	22.04	22.22
		50	25	23.00	22.31	22.27	22.17
		50	50	23.00	22.32	22.05	22.17
		100	0	23.00	21.95	21.94	22.17
	64QAM	1	0	23.00	22.58	22.68	22.41
		1	50	23.00	22.68	22.53	22.66
		1	99	23.00	22.47	22.53	22.66
		50	0	22.00	21.22	21.20	21.14
		50	25	22.00	21.22	21.05	21.11
		50	50	22.00	21.22	21.03	21.12
		100	0	22.00	21.09	21.20	21.17

Table 91: Conducted power measurement results of LTE Band 38 (Reduced Power Level D2/D4/D6/D10)

Bandwidth	Modulation	RB size	RB offset	Tune-up	Channel	Channel	Channel
				Max.	37775CH	38000CH	38225CH
5MHz	QPSK	1	0	21.00	20.35	20.24	20.32
		1	13	21.00	20.35	20.21	20.24
		1	24	21.00	20.33	20.24	20.26
		12	0	21.00	20.33	20.37	20.40
		12	6	21.00	20.32	20.30	20.40
		12	13	21.00	20.32	20.38	20.39
		25	0	21.00	20.34	20.28	20.25
	16QAM	1	0	21.00	20.63	20.47	20.57
		1	13	21.00	20.64	20.47	20.51
		1	24	21.00	20.63	20.47	20.50
		12	0	21.00	20.29	20.38	20.31
		12	6	21.00	20.29	20.33	20.31
		12	13	21.00	20.29	20.39	20.32
		25	0	21.00	20.10	20.12	20.36
	64QAM	1	0	21.00	20.53	20.67	20.69
		1	13	21.00	20.53	20.67	20.68
		1	24	21.00	20.53	20.67	20.68
		12	0	21.00	20.39	20.40	20.44
		12	6	21.00	20.39	20.40	20.47
		12	13	21.00	20.39	20.40	20.45
		25	0	21.00	20.05	20.12	20.20
Bandwidth	Modulation	RB size	RB offset	Tune-up	Channel	Channel	Channel
10MHz	QPSK	1	0	21.00	20.42	20.46	20.32
		1	25	21.00	20.42	20.46	20.31
		1	49	21.00	20.42	20.46	20.30
		25	0	21.00	20.35	20.21	20.36
		25	13	21.00	20.35	20.38	20.36
		25	25	21.00	20.35	20.38	20.36
		50	0	21.00	20.35	20.29	20.36
	16QAM	1	0	21.00	20.41	20.17	20.20
		1	25	21.00	20.41	20.23	20.24
		1	49	21.00	20.41	20.23	20.26
		25	0	21.00	20.10	20.34	20.23
		25	13	21.00	20.25	20.35	20.15
		25	25	21.00	20.11	20.35	20.32
		50	0	21.00	20.29	20.05	20.13
	64QAM	1	0	21.00	20.62	20.62	20.60
		1	25	21.00	20.61	20.62	20.60
		1	49	21.00	20.61	20.62	20.72
		25	0	21.00	20.35	20.41	20.35
		25	13	21.00	20.35	20.37	20.35
		25	25	21.00	20.36	20.38	20.36
		50	0	21.00	20.06	20.07	20.34

Bandwidth	Modulation	RB size	RB offset	Tune-up	Channel	Channel	Channel
				Max.	37825CH	38000CH	38175CH
15MHz	QPSK	1	0	21.00	20.51	20.51	20.52
		1	38	21.00	20.58	20.59	20.55
		1	74	21.00	20.50	20.59	20.53
		36	0	21.00	20.43	20.38	20.30
		36	18	21.00	20.43	20.38	20.30
		36	39	21.00	20.44	20.39	20.29
		75	0	21.00	20.22	20.25	20.40
	16QAM	1	0	21.00	20.80	20.80	20.79
		1	38	21.00	20.80	20.80	20.81
		1	74	21.00	20.83	20.79	20.81
		36	0	21.00	20.36	20.34	20.27
		36	18	21.00	20.36	20.41	20.27
		36	39	21.00	20.22	20.34	20.26
		75	0	21.00	20.13	20.19	20.11
	64QAM	1	0	21.00	20.41	20.43	20.59
		1	38	21.00	20.41	20.43	20.58
		1	74	21.00	20.42	20.52	20.58
		36	0	21.00	20.46	20.27	20.31
		36	18	21.00	20.47	20.43	20.30
		36	39	21.00	20.47	20.42	20.31
		75	0	21.00	20.03	20.29	20.23
Bandwidth	Modulation	RB size	RB offset	Tune-up	Channel	Channel	Channel
20MHz	QPSK	1	0	21.00	20.57	20.27	20.53
		1	50	21.00	20.56	20.36	20.54
		1	99	21.00	20.57	20.36	20.34
		50	0	21.00	20.34	20.24	20.38
		50	25	21.00	20.37	20.38	20.38
		50	50	21.00	20.35	20.39	20.37
		100	0	21.00	20.23	20.25	20.35
	16QAM	1	0	21.00	20.85	20.49	20.79
		1	50	21.00	20.81	20.58	20.86
		1	99	21.00	20.81	20.57	20.85
		50	0	21.00	20.17	20.31	20.35
		50	25	21.00	20.17	20.35	20.21
		50	50	21.00	20.17	20.32	20.21
		100	0	21.00	20.09	20.08	20.28
	64QAM	1	0	21.00	20.66	20.81	20.75
		1	50	21.00	20.66	20.77	20.79
		1	99	21.00	20.66	20.77	20.79
		50	0	21.00	20.30	20.21	20.17
		50	25	21.00	20.39	20.09	20.14
		50	50	21.00	20.25	20.10	20.14
		100	0	21.00	20.18	20.26	20.18
Bandwidth	Modulation	RB size	RB offset	Tune-up	Channel	Channel	Channel
				Max.	37850CH	38000CH	38150CH

Table 92: Conducted power measurement results of LTE Band 38 (Reduced Power Level D7)

Bandwidth	Modulation	RB size	RB offset	Tune-up	Channel	Channel	Channel
				Max.	37775CH	38000CH	38225CH
5MHz	QPSK	1	0	22.00	21.38	21.21	21.37
		1	13	22.00	21.38	21.21	21.23
		1	24	22.00	21.38	21.21	21.24
		12	0	22.00	21.21	21.31	21.37
		12	6	22.00	21.20	21.25	21.37
		12	13	22.00	21.19	21.25	21.37
		25	0	22.00	21.31	21.25	21.24
	16QAM	1	0	22.00	21.55	21.39	21.51
		1	13	22.00	21.56	21.42	21.42
		1	24	22.00	21.56	21.41	21.41
		12	0	22.00	21.34	21.32	21.30
		12	6	22.00	21.34	21.31	21.29
		12	13	22.00	21.35	21.34	21.30
		25	0	22.00	21.07	21.26	21.31
	64QAM	1	0	22.00	21.67	21.57	21.60
		1	13	22.00	21.66	21.58	21.59
		1	24	22.00	21.67	21.58	21.60
		12	0	22.00	21.36	21.36	21.43
		12	6	22.00	21.36	21.36	21.46
		12	13	22.00	21.36	21.37	21.43
		25	0	22.00	20.97	21.09	21.20
Bandwidth	Modulation	RB size	RB offset	Tune-up	Channel	Channel	Channel
10MHz	QPSK	1	0	22.00	21.42	21.49	21.35
		1	25	22.00	21.45	21.49	21.36
		1	49	22.00	21.42	21.50	21.35
		25	0	22.00	21.22	21.16	21.22
		25	13	22.00	21.22	21.35	21.22
		25	25	22.00	21.22	21.35	21.22
		50	0	22.00	21.28	21.22	21.33
	16QAM	1	0	22.00	21.37	21.35	21.19
		1	25	22.00	21.36	21.14	21.20
		1	49	22.00	21.36	21.15	21.22
		25	0	22.00	21.28	21.28	21.30
		25	13	22.00	21.30	21.29	21.26
		25	25	22.00	21.28	21.29	21.24
		50	0	22.00	21.23	21.21	21.12
	64QAM	1	0	22.00	21.69	21.68	21.54
		1	25	22.00	21.69	21.68	21.54
		1	49	22.00	21.69	21.68	21.71
		25	0	22.00	21.31	21.36	21.40
		25	13	22.00	21.32	21.36	21.38
		25	25	22.00	21.32	21.37	21.38
		50	0	22.00	20.93	21.06	21.31
Bandwidth	Modulation	RB size	RB offset	Tune-up	Channel	Channel	Channel
				Max.	37800CH	38000CH	38200CH

Bandwidth	Modulation	RB size	RB offset	Tune-up	Channel	Channel	Channel
				Max.	37825CH	38000CH	38175CH
15MHz	QPSK	1	0	22.00	21.54	21.52	21.53
		1	38	22.00	21.54	21.54	21.33
		1	74	22.00	21.53	21.54	21.32
		36	0	22.00	21.16	21.26	21.30
		36	18	22.00	21.16	21.26	21.29
		36	39	22.00	21.17	21.26	21.28
		75	0	22.00	21.34	21.19	21.31
	16QAM	1	0	22.00	21.72	21.73	21.81
		1	38	22.00	21.72	21.73	21.80
		1	74	22.00	21.58	21.54	21.80
		36	0	22.00	21.41	21.40	21.27
		36	18	22.00	21.42	21.35	21.27
		36	39	22.00	21.40	21.41	21.29
		75	0	22.00	21.09	21.13	21.24
	64QAM	1	0	22.00	21.61	21.59	21.57
		1	38	22.00	21.61	21.59	21.55
		1	74	22.00	21.61	21.61	21.56
		36	0	22.00	21.43	21.23	21.34
		36	18	22.00	21.43	21.38	21.34
		36	39	22.00	21.43	21.33	21.34
		75	0	22.00	20.96	21.27	21.11
Bandwidth	Modulation	RB size	RB offset	Tune-up	Channel	Channel	Channel
20MHz	QPSK	1	0	22.00	21.64	21.26	21.56
		1	50	22.00	21.63	21.38	21.57
		1	99	22.00	21.59	21.38	21.36
		50	0	22.00	21.28	21.14	21.24
		50	25	22.00	21.13	21.29	21.24
		50	50	22.00	21.28	21.28	21.23
		100	0	22.00	21.14	21.28	21.28
	16QAM	1	0	22.00	21.59	21.44	21.63
		1	50	22.00	21.72	21.53	21.76
		1	99	22.00	21.72	21.62	21.75
		50	0	22.00	21.33	21.11	21.26
		50	25	22.00	21.33	21.28	21.20
		50	50	22.00	21.33	21.11	21.20
		100	0	22.00	21.04	21.03	21.18
	64QAM	1	0	22.00	21.61	21.52	21.51
		1	50	22.00	21.60	21.41	21.53
		1	99	22.00	21.61	21.41	21.53
		50	0	22.00	21.21	21.20	21.14
		50	25	22.00	21.22	21.05	21.12
		50	50	22.00	21.22	21.05	21.12
		100	0	22.00	21.09	21.21	21.17
Bandwidth	Modulation	RB size	RB offset	Tune-up	Channel	Channel	Channel
				Max.	37850CH	38000CH	38150CH

Table 93: Conducted power measurement results of LTE Band 38 (Reduced Power Level D8)

7.1.27 Conducted power measurements of LTE Band 41(Second antenna)

Bandwidth	Modulation	RB size	RB offset	Tune-up	Channel	Channel	Channel	Channel
				Max.	40065CH	40448CH	40832CH	41215CH
5MHz	QPSK	1	0	18.50	17.84	17.79	17.59	17.40
		1	13	18.50	17.88	17.79	17.62	17.64
		1	24	18.50	17.90	17.79	17.59	17.40
		12	0	18.50	17.91	17.84	17.54	17.69
		12	6	18.50	17.90	17.84	17.54	17.71
		12	13	18.50	17.90	17.85	17.55	17.69
		25	0	18.50	17.88	17.68	17.66	17.52
	16QAM	1	0	18.50	18.07	18.06	17.88	17.72
		1	13	18.50	18.21	17.99	17.88	17.71
		1	24	18.50	18.07	18.06	17.89	17.72
		12	0	18.50	17.98	17.92	17.63	17.63
		12	6	18.50	17.97	17.92	17.63	17.64
		12	13	18.50	17.98	17.93	17.63	17.63
		25	0	18.50	17.83	17.65	17.59	17.42
	64QAM	1	0	18.50	18.04	17.90	17.75	17.92
		1	13	18.50	18.05	17.90	17.86	17.92
		1	24	18.50	18.25	17.94	17.74	17.91
		12	0	18.50	17.89	17.75	17.64	17.50
		12	6	18.50	17.88	17.75	17.49	17.50
		12	13	18.50	17.88	17.75	17.49	17.50
		25	0	18.50	17.79	17.69	17.42	17.32
Bandwidth	Modulation	RB size	RB offset	Tune-up	Channel	Channel	Channel	Channel
10MHz	QPSK	1	0	18.50	17.98	17.88	17.90	17.64
		1	25	18.50	17.81	17.86	17.75	17.46
		1	49	18.50	17.88	17.85	17.85	17.60
		25	0	18.50	17.84	17.83	17.65	17.69
		25	13	18.50	17.85	17.81	17.65	17.69
		25	25	18.50	17.84	17.80	17.64	17.67
		50	0	18.50	17.89	17.61	17.51	17.65
	16QAM	1	0	18.50	17.86	17.71	17.55	17.84
		1	25	18.50	18.36	17.92	17.55	17.69
		1	49	18.50	17.99	17.75	17.55	17.87
		25	0	18.50	17.88	17.69	17.63	17.50
		25	13	18.50	17.87	17.79	17.61	17.49
		25	25	18.50	17.86	17.73	17.66	17.62
		50	0	18.50	17.82	17.60	17.66	17.42
	64QAM	1	0	18.50	17.71	17.63	17.43	17.63
		1	25	18.50	17.73	17.75	17.43	17.63
		1	49	18.50	17.73	17.75	17.43	17.81
		25	0	18.50	17.72	17.68	17.45	17.50
		25	13	18.50	17.72	17.68	17.45	17.47
		25	25	18.50	17.71	17.68	17.45	17.47
		50	0	18.50	17.73	17.56	17.45	17.49
Bandwidth	Modulation	RB size	RB offset	Tune-up	Channel	Channel	Channel	Channel
10MHz	QPSK	1	0	18.50	17.98	17.88	17.90	17.64
		1	25	18.50	17.81	17.86	17.75	17.46
		1	49	18.50	17.88	17.85	17.85	17.60
		25	0	18.50	17.84	17.83	17.65	17.69
		25	13	18.50	17.85	17.81	17.65	17.69
		25	25	18.50	17.84	17.80	17.64	17.67
		50	0	18.50	17.89	17.61	17.51	17.65
	16QAM	1	0	18.50	17.86	17.71	17.55	17.84
		1	25	18.50	18.36	17.92	17.55	17.69
		1	49	18.50	17.99	17.75	17.55	17.87
		25	0	18.50	17.88	17.69	17.63	17.50
		25	13	18.50	17.87	17.79	17.61	17.49
		25	25	18.50	17.86	17.73	17.66	17.62
		50	0	18.50	17.82	17.60	17.66	17.42
	64QAM	1	0	18.50	17.71	17.63	17.43	17.63
		1	25	18.50	17.73	17.75	17.43	17.63
		1	49	18.50	17.73	17.75	17.43	17.81
		25	0	18.50	17.72	17.68	17.45	17.50
		25	13	18.50	17.72	17.68	17.45	17.47
		25	25	18.50	17.71	17.68	17.45	17.47
		50	0	18.50	17.73	17.56	17.45	17.49

Bandwidth	Modulation	RB size	RB offset	Tune-up	Channel	Channel	Channel	Channel
				Max.	40115CH	40465CH	40815CH	41165CH
15MHz	QPSK	1	0	18.50	17.85	17.77	17.77	17.83
		1	38	18.50	17.84	17.87	17.76	17.83
		1	74	18.50	17.84	17.85	17.76	17.83
		36	0	18.50	17.92	17.89	17.74	17.76
		36	18	18.50	17.92	17.89	17.74	17.68
		36	39	18.50	17.92	17.89	17.74	17.71
		75	0	18.50	17.96	17.67	17.78	17.67
	16QAM	1	0	18.50	18.44	18.15	17.74	17.82
		1	38	18.50	18.16	18.18	18.02	17.82
		1	74	18.50	18.13	18.15	17.98	17.82
		36	0	18.50	17.91	17.86	17.61	17.60
		36	18	18.50	17.96	17.87	17.75	17.70
		36	39	18.50	17.91	17.80	17.74	17.70
		75	0	18.50	17.86	17.57	17.67	17.62
	64QAM	1	0	18.50	17.59	17.73	17.41	17.27
		1	38	18.50	17.76	17.78	17.41	17.79
		1	74	18.50	17.59	17.78	17.41	17.86
		36	0	18.50	17.69	17.66	17.65	17.57
		36	18	18.50	17.69	17.66	17.65	17.57
		36	39	18.50	17.69	17.66	17.65	17.52
		75	0	18.50	17.72	17.58	17.54	17.49
Bandwidth	Modulation	RB size	RB offset	Tune-up	Channel	Channel	Channel	Channel
20MHz	QPSK	1	0	18.50	17.72	17.75	17.60	17.67
		1	50	18.50	17.72	17.74	17.60	17.67
		1	99	18.50	17.72	17.74	17.59	17.71
		50	0	18.50	17.97	17.96	17.77	17.76
		50	25	18.50	17.96	17.96	17.77	17.76
		50	50	18.50	17.96	17.96	17.77	17.76
		100	0	18.50	17.98	17.67	17.77	17.70
	16QAM	1	0	18.50	17.94	17.97	17.65	17.86
		1	50	18.50	17.71	17.96	17.70	17.82
		1	99	18.50	17.80	17.81	17.65	17.81
		50	0	18.50	17.91	17.90	17.68	17.68
		50	25	18.50	17.91	17.93	17.68	17.67
		50	50	18.50	17.92	17.93	17.68	17.67
		100	0	18.50	17.87	17.62	17.72	17.52
	64QAM	1	0	18.50	17.96	17.90	17.67	17.84
		1	50	18.50	17.93	17.87	17.66	17.84
		1	99	18.50	17.95	17.89	17.66	17.84
		50	0	18.50	17.82	17.73	17.54	17.56
		50	25	18.50	17.82	17.75	17.54	17.56
		50	50	18.50	17.82	17.74	17.54	17.56
		100	0	18.50	17.94	17.81	17.60	17.55
Bandwidth	Modulation	RB size	RB offset	Tune-up	Channel	Channel	Channel	Channel
				Max.	40140CH	40473CH	40807CH	41140CH

Table 94: Conducted power measurement results of LTE Band 41 (Reduced Power Level D1)

Bandwidth	Modulation	RB size	RB offset	Tune-up	Channel	Channel	Channel	Channel
				Max.	40065CH	40448CH	40832CH	41215CH
5MHz	QPSK	1	0	23.50	22.70	22.61	22.28	22.32
		1	13	23.50	22.70	22.61	22.33	22.51
		1	24	23.50	22.70	22.60	22.27	22.31
		12	0	22.50	21.71	21.50	21.28	21.58
		12	6	22.50	21.71	21.50	21.28	21.58
		12	13	22.50	21.76	21.50	21.27	21.58
		25	0	22.50	21.74	21.78	21.51	21.36
	16QAM	1	0	22.50	21.93	21.86	21.53	21.80
		1	13	22.50	21.98	21.85	21.54	21.80
		1	24	22.50	21.93	21.86	21.54	21.80
		12	0	21.50	20.81	20.57	20.34	20.50
		12	6	21.50	20.81	20.57	20.34	20.50
		12	13	21.50	20.82	20.57	20.34	20.50
		25	0	21.50	20.64	20.74	20.55	20.33
	64QAM	1	0	21.50	20.94	20.85	20.77	20.78
		1	13	21.50	20.95	20.85	20.53	20.78
		1	24	21.50	21.20	20.85	20.76	20.77
		12	0	20.50	19.80	19.58	19.63	19.55
		12	6	20.50	19.80	19.58	19.36	19.55
		12	13	20.50	19.80	19.58	19.36	19.55
		25	0	20.50	19.73	19.54	19.44	19.34
Bandwidth	Modulation	RB size	RB offset	Tune-up	Channel	Channel	Channel	Channel
10MHz	QPSK	1	0	23.50	22.79	22.85	22.52	22.58
		1	25	23.50	22.80	22.90	22.93	22.53
		1	49	23.50	22.82	22.86	22.88	22.59
		25	0	22.50	21.71	21.64	21.32	21.46
		25	13	22.50	21.71	21.62	21.32	21.44
		25	25	22.50	21.70	21.61	21.31	21.44
		50	0	22.50	21.73	21.51	21.27	21.43
	16QAM	1	0	22.50	21.92	21.57	21.52	21.47
		1	25	22.50	21.81	21.70	21.66	21.63
		1	49	22.50	22.00	21.59	21.51	21.63
		25	0	21.50	20.69	20.58	20.34	20.41
		25	13	21.50	20.68	20.50	20.34	20.40
		25	25	21.50	20.66	20.59	20.34	20.46
		50	0	21.50	20.62	20.70	20.54	20.38
	64QAM	1	0	21.50	20.51	20.44	20.47	20.56
		1	25	21.50	20.60	20.55	20.46	20.57
		1	49	21.50	20.59	20.55	20.47	20.74
		25	0	20.50	19.70	19.52	19.33	19.44
		25	13	20.50	19.70	19.52	19.33	19.41
		25	25	20.50	19.65	19.54	19.34	19.41
		50	0	20.50	19.66	19.70	19.47	19.45
Bandwidth	Modulation	RB size	RB offset	Tune-up	Channel	Channel	Channel	Channel
				Max.	40090CH	40457CH	40823CH	41190CH

Bandwidth	Modulation	RB size	RB offset	Tune-up	Channel	Channel	Channel	Channel
				Max.	40115CH	40465CH	40815CH	41165CH
15MHz	QPSK	1	0	23.50	22.98	22.71	22.66	22.67
		1	38	23.50	22.97	22.72	22.66	22.67
		1	74	23.50	22.97	22.65	22.66	22.66
		36	0	22.50	21.78	21.62	21.39	21.55
		36	18	22.50	21.77	21.62	21.39	21.49
		36	39	22.50	21.77	21.62	21.39	21.50
		75	0	22.50	21.82	21.76	21.62	21.48
	16QAM	1	0	22.50	22.49	21.92	21.98	21.64
		1	38	22.50	22.00	21.84	21.93	21.65
		1	74	22.50	22.03	21.92	21.93	21.64
		36	0	21.50	20.72	20.56	20.58	20.51
		36	18	21.50	20.78	20.56	20.39	20.62
		36	39	21.50	20.72	20.63	20.39	20.62
		75	0	21.50	20.60	20.66	20.52	20.45
	64QAM	1	0	21.50	20.66	20.59	20.42	20.76
		1	38	21.50	20.58	20.59	20.42	20.73
		1	74	21.50	20.66	20.59	20.42	20.76
		36	0	20.50	19.63	19.49	19.47	19.49
		36	18	20.50	19.63	19.49	19.47	19.49
		36	39	20.50	19.63	19.49	19.47	19.40
		75	0	20.50	19.65	19.72	19.55	19.44
Bandwidth	Modulation	RB size	RB offset	Tune-up	Channel	Channel	Channel	Channel
20MHz	QPSK	1	0	23.50	22.69	22.78	22.35	22.40
		1	50	23.50	22.69	22.77	22.34	22.41
		1	99	23.50	22.71	22.77	22.34	22.47
		50	0	22.50	21.80	21.97	21.42	21.62
		50	25	22.50	21.80	21.96	21.41	21.61
		50	50	22.50	21.81	21.96	21.41	21.61
		100	0	22.50	21.81	21.78	21.65	21.50
	16QAM	1	0	22.50	21.92	22.10	21.60	21.57
		1	50	22.50	21.83	22.09	21.50	21.56
		1	99	22.50	21.86	22.02	21.61	21.56
		50	0	21.50	20.75	20.56	20.34	20.52
		50	25	21.50	20.75	20.90	20.34	20.51
		50	50	21.50	20.73	20.92	20.34	20.51
		100	0	21.50	20.66	20.80	20.57	20.41
	64QAM	1	0	21.50	20.84	20.99	20.56	20.63
		1	50	21.50	20.96	20.99	20.56	20.60
		1	99	21.50	20.83	21.00	20.56	20.61
		50	0	20.50	19.77	19.59	19.38	19.52
		50	25	20.50	19.76	19.59	19.39	19.52
		50	50	20.50	19.76	19.59	19.37	19.53
		100	0	20.50	19.73	19.64	19.62	19.49
Bandwidth	Modulation	RB size	RB offset	Tune-up	Channel	Channel	Channel	Channel
				Max.	40140CH	40473CH	40807CH	41140CH

Table 95: Conducted power measurement results of LTE Band 41 (Full Power)

Bandwidth	Modulation	RB size	RB offset	Tune-up	Channel	Channel	Channel	Channel
				Max.	40065CH	40448CH	40832CH	41215CH
5MHz	QPSK	1	0	16.50	15.85	15.79	15.54	15.59
		1	13	16.50	15.84	15.79	15.59	15.59
		1	24	16.50	15.84	15.78	15.54	15.59
		12	0	16.50	15.86	15.73	15.42	15.64
		12	6	16.50	15.85	15.74	15.43	15.63
		12	13	16.50	15.84	15.73	15.43	15.63
		25	0	16.50	15.84	15.64	15.62	15.45
	16QAM	1	0	16.50	16.02	15.97	15.79	15.93
		1	13	16.50	16.04	15.94	15.79	15.94
		1	24	16.50	16.02	15.97	15.79	15.94
		12	0	16.50	15.94	15.82	15.51	15.75
		12	6	16.50	15.94	15.83	15.52	15.74
		12	13	16.50	15.94	15.83	15.52	15.74
		25	0	16.50	15.84	15.59	15.65	15.44
	64QAM	1	0	16.50	16.23	15.94	15.72	15.90
		1	13	16.50	16.23	15.94	15.76	15.90
		1	24	16.50	16.23	15.94	15.71	15.90
		12	0	16.50	15.95	15.82	15.75	15.68
		12	6	16.50	15.95	15.82	15.53	15.68
		12	13	16.50	15.95	15.82	15.75	15.69
		25	0	16.50	15.81	15.72	15.56	15.50
Bandwidth	Modulation	RB size	RB offset	Tune-up	Channel	Channel	Channel	Channel
10MHz	QPSK	1	0	16.50	15.94	15.93	15.66	15.74
		1	25	16.50	15.99	15.86	15.78	15.40
		1	49	16.50	15.78	15.90	15.82	15.88
		25	0	16.50	15.81	15.71	15.56	15.63
		25	13	16.50	15.81	15.70	15.55	15.60
		25	25	16.50	15.81	15.69	15.54	15.66
		50	0	16.50	15.83	15.62	15.43	15.62
	16QAM	1	0	16.50	15.97	15.92	15.47	15.86
		1	25	16.50	16.00	15.83	15.46	15.56
		1	49	16.50	15.88	15.83	15.61	15.76
		25	0	16.50	15.85	15.68	15.57	15.61
		25	13	16.50	15.84	15.78	15.57	15.61
		25	25	16.50	15.83	15.64	15.57	15.63
		50	0	16.50	15.77	15.57	15.62	15.50
	64QAM	1	0	16.50	15.68	15.66	15.39	15.65
		1	25	16.50	15.69	15.67	15.38	15.60
		1	49	16.50	15.66	15.67	15.38	15.83
		25	0	16.50	15.80	15.75	15.55	15.68
		25	13	16.50	15.80	15.75	15.55	15.62
		25	25	16.50	15.80	15.76	15.55	15.63
		50	0	16.50	15.81	15.57	15.60	15.55

Bandwidth	Modulation	RB size	RB offset	Tune-up	Channel	Channel	Channel	Channel
				Max.	40115CH	40465CH	40815CH	41165CH
15MHz	QPSK	1	0	16.50	16.03	16.06	15.82	15.78
		1	38	16.50	16.02	16.05	15.82	15.79
		1	74	16.50	16.03	16.04	15.82	15.79
		36	0	16.50	15.90	15.85	15.65	15.69
		36	18	16.50	15.89	15.85	15.65	15.66
		36	39	16.50	15.89	15.85	15.65	15.66
		75	0	16.50	15.93	15.65	15.72	15.63
	16QAM	1	0	16.50	16.32	16.06	15.92	15.72
		1	38	16.50	16.28	16.18	15.94	15.72
		1	74	16.50	16.06	16.06	15.90	15.72
		36	0	16.50	15.89	15.84	15.59	15.67
		36	18	16.50	15.93	15.84	15.66	15.71
		36	39	16.50	15.89	15.74	15.67	15.72
		75	0	16.50	15.70	15.57	15.62	15.60
	64QAM	1	0	16.50	15.75	15.66	15.42	15.76
		1	38	16.50	15.71	15.72	15.41	15.77
		1	74	16.50	15.74	15.72	15.41	15.91
		36	0	16.50	15.78	15.71	15.66	15.62
		36	18	16.50	15.78	15.71	15.66	15.63
		36	39	16.50	15.78	15.72	15.67	15.59
		75	0	16.50	15.76	15.78	15.66	15.64
Bandwidth	Modulation	RB size	RB offset	Tune-up	Channel	Channel	Channel	Channel
20MHz	QPSK	1	0	16.50	15.72	15.76	15.66	15.62
		1	50	16.50	15.74	15.97	15.65	15.61
		1	99	16.50	15.77	15.76	15.65	15.60
		50	0	16.50	15.94	15.84	15.68	15.72
		50	25	16.50	15.94	15.85	15.68	15.72
		50	50	16.50	15.94	15.84	15.68	15.72
		100	0	16.50	15.92	15.66	15.74	15.67
	16QAM	1	0	16.50	15.97	15.94	15.64	15.82
		1	50	16.50	15.91	15.93	15.68	15.82
		1	99	16.50	15.89	15.85	15.64	15.81
		50	0	16.50	15.89	15.80	15.60	15.67
		50	25	16.50	15.89	15.83	15.61	15.66
		50	50	16.50	15.89	15.83	15.61	15.67
		100	0	16.50	15.81	15.56	15.68	15.63
	64QAM	1	0	16.50	15.90	15.96	15.67	15.85
		1	50	16.50	15.89	15.95	15.67	15.78
		1	99	16.50	15.89	15.94	15.67	15.84
		50	0	16.50	15.91	15.78	15.63	15.65
		50	25	16.50	15.91	15.78	15.64	15.66
		50	50	16.50	15.91	15.79	15.64	15.69
		100	0	16.50	15.92	15.85	15.71	15.67
Bandwidth	Modulation	RB size	RB offset	Tune-up	Channel	Channel	Channel	Channel
				Max.	40140CH	40473CH	40807CH	41140CH

Table 96: Conducted power measurement results of LTE Band 41 (Reduced Power Level D3)

Bandwidth	Modulation	RB size	RB offset	Tune-up	Channel	Channel	Channel	Channel
				Max.	40065CH	40448CH	40832CH	41215CH
5MHz	QPSK	1	0	21.50	20.85	20.68	20.42	20.33
		1	13	21.50	20.84	20.67	20.54	20.60
		1	24	21.50	20.84	20.69	20.42	20.33
		12	0	21.50	20.82	20.64	20.38	20.60
		12	6	21.50	20.82	20.64	20.38	20.59
		12	13	21.50	20.81	20.64	20.39	20.60
		25	0	21.50	20.84	20.82	20.59	20.34
	16QAM	1	0	21.50	20.99	20.84	20.65	20.89
		1	13	21.50	21.02	20.76	20.65	20.89
		1	24	21.50	20.99	20.84	20.65	20.89
		12	0	21.50	20.80	20.57	20.34	20.51
		12	6	21.50	20.80	20.58	20.34	20.51
		12	13	21.50	20.75	20.58	20.34	20.51
		25	0	21.50	20.64	20.69	20.55	20.32
	64QAM	1	0	21.50	20.95	20.86	20.77	20.78
		1	13	21.50	20.95	20.86	20.53	20.78
		1	24	21.50	21.14	20.85	20.77	20.78
		12	0	20.50	19.80	19.58	19.63	19.56
		12	6	20.50	19.80	19.58	19.36	19.56
		12	13	20.50	19.80	19.59	19.37	19.56
		25	0	20.50	19.74	19.54	19.44	19.33
Bandwidth	Modulation	RB size	RB offset	Tune-up	Channel	Channel	Channel	Channel
10MHz	QPSK	1	0	21.50	20.96	20.87	20.74	20.65
		1	25	21.50	20.97	20.86	20.71	20.60
		1	49	21.50	20.80	20.69	20.74	20.63
		25	0	21.50	20.75	20.61	20.42	20.55
		25	13	21.50	20.75	20.60	20.42	20.53
		25	25	21.50	20.75	20.59	20.43	20.51
		50	0	21.50	20.84	20.49	20.37	20.51
	16QAM	1	0	21.50	20.94	20.69	20.63	20.73
		1	25	21.50	21.07	20.67	20.63	20.44
		1	49	21.50	21.13	20.68	20.62	20.64
		25	0	21.50	20.69	20.57	20.34	20.41
		25	13	21.50	20.68	20.51	20.34	20.41
		25	25	21.50	20.67	20.59	20.34	20.46
		50	0	21.50	20.63	20.71	20.54	20.41
	64QAM	1	0	21.50	20.52	20.47	20.47	20.57
		1	25	21.50	20.60	20.56	20.47	20.58
		1	49	21.50	20.60	20.56	20.47	20.68
		25	0	20.50	19.70	19.52	19.34	19.44
		25	13	20.50	19.67	19.52	19.31	19.41
		25	25	20.50	19.68	19.54	19.33	19.42
		50	0	20.50	19.67	19.71	19.48	19.45
Bandwidth	Modulation	RB size	RB offset	Tune-up	Channel	Channel	Channel	Channel
				Max.	40090CH	40457CH	40823CH	41190CH

Bandwidth	Modulation	RB size	RB offset	Tune-up	Channel	Channel	Channel	Channel
				Max.	40115CH	40465CH	40815CH	41165CH
15MHz	QPSK	1	0	21.50	20.87	21.04	20.61	20.65
		1	38	21.50	20.90	21.03	20.95	20.65
		1	74	21.50	20.89	20.93	20.94	20.65
		36	0	21.50	20.83	20.71	20.51	20.64
		36	18	21.50	20.82	20.71	20.51	20.46
		36	39	21.50	20.82	20.71	20.51	20.46
		75	0	21.50	20.90	20.83	20.69	20.49
	16QAM	1	0	21.50	20.93	20.92	20.82	20.67
		1	38	21.50	20.98	21.00	21.07	20.68
		1	74	21.50	20.96	20.92	21.06	20.67
		36	0	21.50	20.72	20.57	20.58	20.53
		36	18	21.50	20.78	20.57	20.40	20.63
		36	39	21.50	20.72	20.64	20.40	20.62
		75	0	21.50	20.59	20.67	20.53	20.45
	64QAM	1	0	21.50	20.67	20.60	20.42	20.37
		1	38	21.50	20.58	20.59	20.43	20.74
		1	74	21.50	20.67	20.60	20.42	20.77
		36	0	20.50	19.63	19.49	19.47	19.50
		36	18	20.50	19.63	19.49	19.47	19.49
		36	39	20.50	19.63	19.49	19.48	19.40
		75	0	20.50	19.65	19.73	19.56	19.45
Bandwidth	Modulation	RB size	RB offset	Tune-up	Channel	Channel	Channel	Channel
20MHz	QPSK	1	0	21.50	20.77	20.93	20.47	20.61
		1	50	21.50	20.77	20.93	20.47	20.61
		1	99	21.50	20.77	20.94	20.47	20.65
		50	0	21.50	20.85	21.02	20.54	20.57
		50	25	21.50	20.86	21.03	20.54	20.57
		50	50	21.50	20.85	21.02	20.54	20.57
		100	0	21.50	20.94	20.87	20.71	20.52
	16QAM	1	0	21.50	20.55	21.08	20.78	20.63
		1	50	21.50	20.92	21.08	20.42	20.63
		1	99	21.50	20.89	21.15	20.78	20.62
		50	0	21.50	20.74	20.54	20.34	20.52
		50	25	21.50	20.75	20.94	20.34	20.52
		50	50	21.50	20.74	20.56	20.35	20.52
		100	0	21.50	20.66	20.66	20.58	20.42
	64QAM	1	0	21.50	20.85	20.90	20.56	20.61
		1	50	21.50	20.97	20.90	20.56	20.60
		1	99	21.50	20.84	20.90	20.56	20.60
		50	0	20.50	19.75	19.60	19.39	19.53
		50	25	20.50	19.76	19.59	19.40	19.53
		50	50	20.50	19.76	19.60	19.40	19.53
		100	0	20.50	19.73	19.63	19.63	19.49

Table 97: Conducted power measurement results of LTE Band 41 (Reduced Power Level D2)

Note: The conducted power measurements of LTE Band 41 is measured with RMS detector.

7.1.28 Conducted power measurements of LTE Band 41(Main antenna)

Bandwidth	Modulation	RB size	RB offset	Tune-up	Channel	Channel	Channel	Channel
				Max.	40065CH	40448CH	40832CH	41215CH
5MHz	QPSK	1	0	25.00	24.28	24.09	24.13	24.34
		1	13	25.00	24.27	24.20	24.13	24.34
		1	24	25.00	24.27	24.20	24.13	24.16
		12	0	24.00	23.26	23.17	23.15	23.35
		12	6	24.00	23.25	23.17	23.15	23.32
		12	13	24.00	23.25	23.17	23.15	23.34
		25	0	24.00	23.20	23.04	23.28	23.31
	16QAM	1	0	24.00	23.46	23.41	23.35	23.44
		1	13	24.00	23.39	23.29	23.34	23.49
		1	24	24.00	23.45	23.29	23.34	23.43
		12	0	23.00	22.21	22.15	22.16	22.25
		12	6	23.00	22.21	22.08	22.16	22.25
		12	13	23.00	22.21	22.08	22.17	22.27
		25	0	23.00	22.17	22.11	22.19	22.26
	64QAM	1	0	23.00	22.37	22.27	22.33	22.45
		1	13	23.00	22.37	22.27	22.33	22.47
		1	24	23.00	22.36	22.27	22.34	22.46
		12	0	22.00	21.33	21.28	21.30	21.38
		12	6	22.00	21.32	21.21	21.30	21.38
		12	13	22.00	21.32	21.21	21.30	21.42
		25	0	22.00	21.06	21.10	21.23	21.27
Bandwidth	Modulation	RB size	RB offset	Tune-up	Channel	Channel	Channel	Channel
10MHz	QPSK	1	0	25.00	24.07	24.03	23.89	24.13
		1	25	25.00	24.07	24.03	23.89	24.13
		1	49	25.00	24.07	23.98	23.89	24.21
		25	0	24.00	23.26	23.28	23.28	23.30
		25	13	24.00	23.26	23.29	23.28	23.30
		25	25	24.00	23.26	23.28	23.28	23.30
		50	0	24.00	23.14	23.19	23.25	23.35
	16QAM	1	0	24.00	23.08	23.17	23.12	23.24
		1	25	24.00	23.26	23.17	23.12	23.24
		1	49	24.00	23.27	23.17	23.12	23.23
		25	0	23.00	22.13	22.13	22.16	22.19
		25	13	23.00	22.13	22.14	22.17	22.19
		25	25	23.00	22.13	22.12	22.17	22.19
		50	0	23.00	22.06	22.06	22.13	22.22
	64QAM	1	0	23.00	22.41	22.50	22.40	22.53
		1	25	23.00	22.41	22.49	22.40	22.53
		1	49	23.00	22.41	22.49	22.40	22.53
		25	0	22.00	21.18	21.25	21.25	21.25
		25	13	22.00	21.18	21.23	21.25	21.25
		25	25	22.00	21.19	21.26	21.24	21.25
		50	0	22.00	21.10	21.10	21.18	21.05
Bandwidth	Modulation	RB size	RB offset	Tune-up	Channel	Channel	Channel	Channel
10MHz	QPSK	1	0	25.00	24.07	24.03	23.89	24.13
		1	25	25.00	24.07	24.03	23.89	24.13
		1	49	25.00	24.07	23.98	23.89	24.21
		25	0	24.00	23.26	23.28	23.28	23.30
		25	13	24.00	23.26	23.29	23.28	23.30
		25	25	24.00	23.26	23.28	23.28	23.30
		50	0	24.00	23.14	23.19	23.25	23.35
	16QAM	1	0	24.00	23.08	23.17	23.12	23.24
		1	25	24.00	23.26	23.17	23.12	23.24
		1	49	24.00	23.27	23.17	23.12	23.23
		25	0	23.00	22.13	22.13	22.16	22.19
		25	13	23.00	22.13	22.14	22.17	22.19
		25	25	23.00	22.13	22.12	22.17	22.19
		50	0	23.00	22.06	22.06	22.13	22.22
	64QAM	1	0	23.00	22.41	22.50	22.40	22.53
		1	25	23.00	22.41	22.49	22.40	22.53
		1	49	23.00	22.41	22.49	22.40	22.53
		25	0	22.00	21.18	21.25	21.25	21.25
		25	13	22.00	21.18	21.23	21.25	21.25
		25	25	22.00	21.19	21.26	21.24	21.25
		50	0	22.00	21.10	21.10	21.18	21.05

Bandwidth	Modulation	RB size	RB offset	Tune-up	Channel	Channel	Channel	Channel
				Max.	40115CH	40465CH	40815CH	41165CH
15MHz	QPSK	1	0	25.00	24.28	24.26	24.21	24.44
		1	38	25.00	24.31	24.26	24.21	24.44
		1	74	25.00	24.30	24.25	24.20	24.44
		36	0	24.00	23.18	23.25	23.31	23.29
		36	18	24.00	23.18	23.26	23.31	23.15
		36	39	24.00	23.18	23.26	23.30	23.29
		75	0	24.00	23.27	23.11	23.22	23.12
	16QAM	1	0	24.00	23.56	23.46	23.54	23.71
		1	38	24.00	23.56	23.58	23.54	23.71
		1	74	24.00	23.56	23.57	23.54	23.70
		36	0	23.00	22.12	22.25	22.28	22.29
		36	18	23.00	22.12	22.25	22.26	22.11
		36	39	23.00	22.12	22.25	22.27	22.12
		75	0	23.00	22.08	22.07	22.25	22.36
	64QAM	1	0	23.00	22.46	22.32	22.31	22.49
		1	38	23.00	22.46	22.34	22.32	22.49
		1	74	23.00	22.45	22.32	22.30	22.49
		36	0	22.00	21.14	21.28	21.29	21.14
		36	18	22.00	21.14	21.28	21.31	21.14
		36	39	22.00	21.14	21.28	21.30	21.14
		75	0	22.00	21.00	20.96	21.11	21.16
Bandwidth	Modulation	RB size	RB offset	Tune-up	Channel	Channel	Channel	Channel
20MHz	QPSK	1	0	25.00	24.13	24.04	24.06	24.31
		1	50	25.00	24.27	24.05	24.16	24.31
		1	99	25.00	24.27	24.04	24.06	24.10
		50	0	24.00	23.34	23.33	23.32	23.38
		50	25	24.00	23.34	23.29	23.32	23.38
		50	50	24.00	23.34	23.33	23.32	23.39
		100	0	24.00	23.01	23.15	23.24	23.32
	16QAM	1	0	24.00	23.49	23.42	23.41	23.44
		1	50	24.00	23.48	23.32	23.30	23.52
		1	99	24.00	23.54	23.31	23.41	23.52
		50	0	23.00	22.20	22.19	22.25	22.28
		50	25	23.00	22.21	22.18	22.24	22.29
		50	50	23.00	22.21	22.19	22.24	22.28
		100	0	23.00	22.21	22.15	22.19	22.26
	64QAM	1	0	23.00	22.34	22.33	22.32	22.53
		1	50	23.00	22.35	22.34	22.32	22.53
		1	99	23.00	22.34	22.32	22.32	22.34
		50	0	22.00	21.17	21.29	21.26	21.32
		50	25	22.00	21.17	21.29	21.27	21.33
		50	50	22.00	21.23	21.29	21.27	21.32
		100	0	22.00	21.26	21.26	21.28	21.23

Table 98: Conducted power measurement results of LTE Band 41 (Full Power)

Bandwidth	Modulation	RB size	RB offset	Tune-up	Channel	Channel	Channel	Channel
				Max.	40065CH	40448CH	40832CH	41215CH
5MHz	QPSK	1	0	23.00	22.38	22.29	22.30	22.39
		1	13	23.00	22.37	22.33	22.30	22.38
		1	24	23.00	22.37	22.33	22.29	22.15
		12	0	23.00	22.31	22.22	22.24	22.39
		12	6	23.00	22.30	22.22	22.25	22.33
		12	13	23.00	22.35	22.20	22.24	22.39
		25	0	23.00	22.25	22.14	22.30	22.35
	16QAM	1	0	23.00	22.51	22.45	22.45	22.49
		1	13	23.00	22.45	22.46	22.44	22.55
		1	24	23.00	22.51	22.45	22.44	22.49
		12	0	23.00	22.21	22.15	22.16	22.25
		12	6	23.00	22.21	22.08	22.16	22.25
		12	13	23.00	22.21	22.08	22.16	22.29
		25	0	23.00	22.17	22.12	22.20	22.26
	64QAM	1	0	23.00	22.36	22.27	22.34	22.46
		1	13	23.00	22.36	22.27	22.33	22.46
		1	24	23.00	22.37	22.27	22.33	22.46
		12	0	22.00	21.32	21.28	21.30	21.38
		12	6	22.00	21.33	21.22	21.30	21.38
		12	13	22.00	21.32	21.22	21.31	21.42
		25	0	22.00	21.06	21.10	21.23	21.27
Bandwidth	Modulation	RB size	RB offset	Tune-up	Channel	Channel	Channel	Channel
10MHz	QPSK	1	0	23.00	22.22	22.06	22.08	22.15
		1	25	23.00	22.22	22.10	22.08	22.16
		1	49	23.00	22.22	22.20	22.08	22.20
		25	0	23.00	22.31	22.30	22.32	22.34
		25	13	23.00	22.31	22.30	22.32	22.34
		25	25	23.00	22.31	22.30	22.32	22.34
		50	0	23.00	22.26	22.25	22.26	22.35
	16QAM	1	0	23.00	22.17	22.18	22.18	22.29
		1	25	23.00	22.32	22.18	22.18	22.29
		1	49	23.00	22.32	22.17	22.18	22.29
		25	0	23.00	22.13	22.13	22.17	22.19
		25	13	23.00	22.13	22.13	22.17	22.19
		25	25	23.00	22.13	22.12	22.17	22.19
		50	0	23.00	22.07	22.06	22.13	22.22
	64QAM	1	0	23.00	22.41	22.50	22.40	22.53
		1	25	23.00	22.41	22.50	22.40	22.53
		1	49	23.00	22.41	22.49	22.40	22.53
		25	0	22.00	21.18	21.26	21.26	21.25
		25	13	22.00	21.18	21.24	21.25	21.25
		25	25	22.00	21.19	21.24	21.24	21.26
		50	0	22.00	21.10	21.10	21.18	21.05

Bandwidth	Modulation	RB size	RB offset	Tune-up	Channel	Channel	Channel	Channel
				Max.	40115CH	40465CH	40815CH	41165CH
15MHz	QPSK	1	0	23.00	22.47	22.40	22.43	22.45
		1	38	23.00	22.45	22.40	22.43	22.48
		1	74	23.00	22.46	22.40	22.42	22.49
		36	0	23.00	22.30	22.32	22.37	22.14
		36	18	23.00	22.30	22.31	22.36	22.17
		36	39	23.00	22.30	22.31	22.37	22.15
		75	0	23.00	22.34	22.21	22.28	22.12
	16QAM	1	0	23.00	22.70	22.59	22.65	22.63
		1	38	23.00	22.70	22.68	22.66	22.63
		1	74	23.00	22.70	22.68	22.66	22.63
		36	0	23.00	22.12	22.25	22.27	22.28
		36	18	23.00	22.12	22.25	22.27	22.12
		36	39	23.00	22.13	22.25	22.26	22.12
		75	0	23.00	22.08	22.07	22.25	22.35
	64QAM	1	0	23.00	22.46	22.32	22.31	22.50
		1	38	23.00	22.45	22.32	22.32	22.49
		1	74	23.00	22.45	22.35	22.31	22.49
		36	0	22.00	21.13	21.28	21.30	21.14
		36	18	22.00	21.13	21.28	21.30	21.14
		36	39	22.00	21.14	21.27	21.30	21.14
		75	0	22.00	21.00	20.96	21.11	21.16
Bandwidth	Modulation	RB size	RB offset	Tune-up	Channel	Channel	Channel	Channel
20MHz	QPSK	1	0	23.00	22.18	22.35	22.29	22.31
		1	50	23.00	22.40	22.19	22.33	22.31
		1	99	23.00	22.39	22.35	22.29	22.32
		50	0	23.00	22.39	22.37	22.37	22.45
		50	25	23.00	22.39	22.36	22.37	22.46
		50	50	23.00	22.39	22.36	22.37	22.46
		100	0	23.00	22.12	22.24	22.31	22.37
	16QAM	1	0	23.00	22.58	22.52	22.45	22.53
		1	50	23.00	22.57	22.32	22.46	22.61
		1	99	23.00	22.60	22.32	22.48	22.60
		50	0	23.00	22.21	22.18	22.25	22.28
		50	25	23.00	22.21	22.19	22.24	22.29
		50	50	23.00	22.21	22.18	22.23	22.28
		100	0	23.00	22.21	22.15	22.20	22.26
	64QAM	1	0	23.00	22.34	22.33	22.32	22.53
		1	50	23.00	22.35	22.35	22.32	22.53
		1	99	23.00	22.34	22.32	22.31	22.35
		50	0	22.00	21.16	21.29	21.27	21.32
		50	25	22.00	21.17	21.29	21.28	21.32
		50	50	22.00	21.23	21.29	21.28	21.33
		100	0	22.00	21.26	21.26	21.29	21.23
Bandwidth	Modulation	RB size	RB offset	Tune-up	Channel	Channel	Channel	Channel
20MHz	QPSK	1	0	23.00	22.18	22.35	22.29	22.31
		1	50	23.00	22.40	22.19	22.33	22.31
		1	99	23.00	22.39	22.35	22.29	22.32
		50	0	23.00	22.39	22.37	22.37	22.45
		50	25	23.00	22.39	22.36	22.37	22.46
		50	50	23.00	22.39	22.36	22.37	22.46
		100	0	23.00	22.12	22.24	22.31	22.37
	16QAM	1	0	23.00	22.58	22.52	22.45	22.53
		1	50	23.00	22.57	22.32	22.46	22.61
		1	99	23.00	22.60	22.32	22.48	22.60
		50	0	23.00	22.21	22.18	22.25	22.28
		50	25	23.00	22.21	22.19	22.24	22.29
		50	50	23.00	22.21	22.18	22.23	22.28
		100	0	23.00	22.21	22.15	22.20	22.26
	64QAM	1	0	23.00	22.34	22.33	22.32	22.53
		1	50	23.00	22.35	22.35	22.32	22.53
		1	99	23.00	22.34	22.32	22.31	22.35
		50	0	22.00	21.16	21.29	21.27	21.32
		50	25	22.00	21.17	21.29	21.28	21.32
		50	50	22.00	21.23	21.29	21.28	21.33
		100	0	22.00	21.26	21.26	21.29	21.23

Table 99: Conducted power measurement results of LTE Band 41 (Reduced Power Level D6/D7/D8/D10)

Bandwidth	Modulation	RB size	RB offset	Tune-up	Channel	Channel	Channel	Channel
				Max.	40065CH	40448CH	40832CH	41215CH
5MHz	QPSK	1	0	24.50	23.68	23.75	23.58	23.87
		1	13	24.50	23.67	23.79	23.57	23.87
		1	24	24.50	23.67	23.79	23.57	23.67
		12	0	24.00	23.27	23.17	23.14	23.36
		12	6	24.00	23.26	23.16	23.15	23.32
		12	13	24.00	23.25	23.16	23.15	23.34
		25	0	24.00	23.24	23.04	23.28	23.31
	16QAM	1	0	24.00	23.46	23.41	23.35	23.44
		1	13	24.00	23.38	23.29	23.34	23.49
		1	24	24.00	23.46	23.29	23.34	23.43
		12	0	23.00	22.21	22.15	22.16	22.25
		12	6	23.00	22.21	22.09	22.16	22.25
		12	13	23.00	22.21	22.08	22.17	22.29
		25	0	23.00	22.17	22.11	22.21	22.26
	64QAM	1	0	23.00	22.34	22.28	22.34	22.45
		1	13	23.00	22.37	22.27	22.33	22.46
		1	24	23.00	22.37	22.27	22.34	22.46
		12	0	22.00	21.32	21.28	21.30	21.38
		12	6	22.00	21.32	21.21	21.30	21.38
		12	13	22.00	21.33	21.22	21.30	21.42
		25	0	22.00	21.06	21.10	21.23	21.27
Bandwidth	Modulation	RB size	RB offset	Tune-up	Channel	Channel	Channel	Channel
10MHz	QPSK	1	0	24.50	23.88	23.79	23.70	23.91
		1	25	24.50	23.88	23.78	23.70	23.90
		1	49	24.50	23.87	23.74	23.70	23.67
		25	0	24.00	23.27	23.29	23.28	23.29
		25	13	24.00	23.26	23.29	23.28	23.29
		25	25	24.00	23.26	23.29	23.28	23.30
		50	0	24.00	23.15	23.19	23.25	23.35
	16QAM	1	0	24.00	23.08	23.17	23.13	23.23
		1	25	24.00	23.27	23.17	23.12	23.23
		1	49	24.00	23.27	23.17	23.12	23.23
		25	0	23.00	22.13	22.15	22.17	22.19
		25	13	23.00	22.13	22.16	22.17	22.19
		25	25	23.00	22.14	22.13	22.17	22.19
		50	0	23.00	22.06	22.06	22.13	22.22
	64QAM	1	0	23.00	22.41	22.50	22.41	22.53
		1	25	23.00	22.41	22.50	22.40	22.53
		1	49	23.00	22.41	22.49	22.40	22.53
		25	0	22.00	21.18	21.26	21.26	21.25
		25	13	22.00	21.18	21.21	21.24	21.26
		25	25	22.00	21.18	21.24	21.26	21.25
		50	0	22.00	21.10	21.10	21.17	21.05
Bandwidth	Modulation	RB size	RB offset	Tune-up	Channel	Channel	Channel	Channel
				Max.	40090CH	40457CH	40823CH	41190CH

Bandwidth	Modulation	RB size	RB offset	Tune-up	Channel	Channel	Channel	Channel
				Max.	40115CH	40465CH	40815CH	41165CH
15MHz	QPSK	1	0	24.50	23.90	23.92	23.67	23.92
		1	38	24.50	23.89	23.92	23.67	23.92
		1	74	24.50	23.90	23.92	23.67	23.91
		36	0	24.00	23.18	23.25	23.30	23.28
		36	18	24.00	23.18	23.27	23.30	23.15
		36	39	24.00	23.18	23.27	23.30	23.29
		75	0	24.00	23.28	23.10	23.20	23.12
	16QAM	1	0	24.00	23.56	23.47	23.54	23.71
		1	38	24.00	23.56	23.57	23.54	23.70
		1	74	24.00	23.56	23.57	23.54	23.70
		36	0	23.00	22.12	22.25	22.27	22.28
		36	18	23.00	22.13	22.25	22.28	22.11
		36	39	23.00	22.13	22.25	22.26	22.12
		75	0	23.00	22.07	22.06	22.26	22.35
	64QAM	1	0	23.00	22.46	22.32	22.30	22.50
		1	38	23.00	22.45	22.33	22.29	22.49
		1	74	23.00	22.46	22.32	22.28	22.50
		36	0	22.00	21.13	21.28	21.32	21.14
		36	18	22.00	21.13	21.28	21.32	21.14
		36	39	22.00	21.14	21.28	21.29	21.14
		75	0	22.00	21.00	20.96	21.11	21.16
Bandwidth	Modulation	RB size	RB offset	Tune-up	Channel	Channel	Channel	Channel
20MHz	QPSK	1	0	24.50	23.88	23.79	23.75	23.82
		1	50	24.50	23.87	23.78	23.73	23.84
		1	99	24.50	23.87	23.78	23.75	23.56
		50	0	24.00	23.35	23.29	23.32	23.38
		50	25	24.00	23.34	23.29	23.34	23.38
		50	50	24.00	23.34	23.29	23.33	23.38
		100	0	24.00	23.02	23.14	23.27	23.30
	16QAM	1	0	24.00	23.50	23.42	23.41	23.44
		1	50	24.00	23.49	23.31	23.29	23.52
		1	99	24.00	23.54	23.31	23.41	23.51
		50	0	23.00	22.20	22.18	22.24	22.28
		50	25	23.00	22.21	22.18	22.24	22.30
		50	50	23.00	22.21	22.18	22.24	22.28
		100	0	23.00	22.21	22.15	22.23	22.25
	64QAM	1	0	23.00	22.34	22.33	22.32	22.53
		1	50	23.00	22.35	22.34	22.32	22.53
		1	99	23.00	22.35	22.32	22.32	22.35
		50	0	22.00	21.16	21.29	21.27	21.32
		50	25	22.00	21.17	21.28	21.27	21.32
		50	50	22.00	21.23	21.29	21.27	21.33
		100	0	22.00	21.27	21.26	21.29	21.23
Bandwidth	Modulation	RB size	RB offset	Tune-up	Channel	Channel	Channel	Channel
20MHz	QPSK	1	0	24.50	23.88	23.79	23.75	23.82
		1	50	24.50	23.87	23.78	23.73	23.84
		1	99	24.50	23.87	23.78	23.75	23.56
		50	0	24.00	23.35	23.29	23.32	23.38
		50	25	24.00	23.34	23.29	23.34	23.38
		50	50	24.00	23.34	23.29	23.33	23.38
		100	0	24.00	23.02	23.14	23.27	23.30
	16QAM	1	0	24.00	23.50	23.42	23.41	23.44
		1	50	24.00	23.49	23.31	23.29	23.52
		1	99	24.00	23.54	23.31	23.41	23.51
		50	0	23.00	22.20	22.18	22.24	22.28
		50	25	23.00	22.21	22.18	22.24	22.30
		50	50	23.00	22.21	22.18	22.24	22.28
		100	0	23.00	22.21	22.15	22.23	22.25
	64QAM	1	0	23.00	22.34	22.33	22.32	22.53
		1	50	23.00	22.35	22.34	22.32	22.53
		1	99	23.00	22.35	22.32	22.32	22.35
		50	0	22.00	21.16	21.29	21.27	21.32
		50	25	22.00	21.17	21.28	21.27	21.32
		50	50	22.00	21.23	21.29	21.27	21.33
		100	0	22.00	21.27	21.26	21.29	21.23

Table 100: Conducted power measurement results of LTE Band 41 (Reduced Power Level D1/D2/D3/D9)

7.1.29 Conducted power measurements of LTE Band 66(Second antenna)

Bandwidth	Modulation	RB size	RB offset	Tune-up	Channel	Channel	Channel
				Max.	131979CH	132322CH	132665CH
1.4MHz	QPSK	1	0	18.00	16.85	16.77	16.75
		1	3	18.00	16.48	16.55	16.56
		1	5	18.00	16.93	16.68	16.78
		3	0	18.00	16.56	16.58	16.52
		3	2	18.00	16.65	16.68	16.59
		3	3	18.00	16.48	16.59	16.71
		6	0	18.00	16.56	16.65	16.60
	16QAM	1	0	18.00	16.61	17.13	17.04
		1	3	18.00	16.37	16.85	16.87
		1	5	18.00	16.88	17.18	17.11
		3	0	18.00	16.57	16.35	16.42
		3	2	18.00	16.40	16.48	16.36
		3	3	18.00	16.50	16.42	16.39
		6	0	18.00	16.58	16.60	16.49
	64QAM	1	0	18.00	16.81	17.05	17.02
		1	3	18.00	16.39	16.84	16.89
		1	5	18.00	16.90	17.17	17.16
		3	0	18.00	16.57	16.48	16.42
		3	2	18.00	16.41	16.45	16.35
		3	3	18.00	16.49	16.43	16.38
		6	0	18.00	16.56	16.65	16.60
Bandwidth	Modulation	RB size	RB offset	Tune-up	Channel	Channel	Channel
3MHz	QPSK	1	0	18.00	16.89	16.86	16.79
		1	7	18.00	16.59	16.43	16.37
		1	14	18.00	16.68	16.76	16.56
		8	0	18.00	16.62	16.72	16.46
		8	4	18.00	16.41	16.48	16.39
		8	7	18.00	16.65	16.63	16.50
		15	0	18.00	16.55	16.72	16.48
	16QAM	1	0	18.00	16.63	17.15	16.68
		1	7	18.00	16.39	16.60	16.33
		1	14	18.00	16.75	16.97	16.67
		8	0	18.00	16.63	16.66	16.37
		8	4	18.00	16.51	16.46	16.30
		8	7	18.00	16.47	16.58	16.47
		15	0	18.00	16.49	16.64	16.42
	64QAM	1	0	18.00	16.62	17.09	16.68
		1	7	18.00	16.52	16.63	16.33
		1	14	18.00	16.68	17.02	16.55
		8	0	18.00	16.56	16.62	16.37
		8	4	18.00	16.37	16.61	16.29
		8	7	18.00	16.47	16.58	16.47
		15	0	18.00	16.55	16.72	16.48

Bandwidth	Modulation	RB size	RB offset	Tune-up	Channel	Channel	Channel
				Max.	131997CH	132322CH	132647CH
5MHz	QPSK	1	0	18.00	16.75	16.56	16.71
		1	13	18.00	16.55	16.60	16.72
		1	24	18.00	16.75	16.51	16.77
		12	0	18.00	16.64	16.66	16.86
		12	6	18.00	16.58	16.74	16.86
		12	13	18.00	16.60	16.66	16.76
		25	0	18.00	16.63	16.54	16.70
	16QAM	1	0	18.00	16.76	16.69	16.69
		1	13	18.00	16.61	16.72	16.71
		1	24	18.00	16.79	16.77	16.72
		12	0	18.00	16.64	16.58	16.56
		12	6	18.00	16.49	16.70	16.52
		12	13	18.00	16.61	16.70	16.51
		25	0	18.00	16.66	16.44	16.61
	64QAM	1	0	18.00	16.77	16.68	16.69
		1	13	18.00	16.62	16.71	16.70
		1	24	18.00	16.78	16.64	16.72
		12	0	18.00	16.64	16.67	16.57
		12	6	18.00	16.50	16.46	16.52
		12	13	18.00	16.61	16.60	16.51
		25	0	18.00	16.64	16.54	16.70
Bandwidth	Modulation	RB size	RB offset	Tune-up	Channel	Channel	Channel
10MHz	QPSK	1	0	18.00	16.94	16.87	16.84
		1	25	18.00	16.58	16.65	16.66
		1	49	18.00	17.02	16.78	16.87
		25	0	18.00	16.65	16.67	16.61
		25	13	18.00	16.75	16.77	16.68
		25	25	18.00	16.57	16.69	16.80
		50	0	18.00	16.65	16.75	16.69
	16QAM	1	0	18.00	16.70	17.23	17.13
		1	25	18.00	16.47	16.94	16.97
		1	49	18.00	16.98	17.27	17.20
		25	0	18.00	16.67	16.45	16.51
		25	13	18.00	16.50	16.57	16.46
		25	25	18.00	16.59	16.51	16.48
		50	0	18.00	16.67	16.70	16.59
	64QAM	1	0	18.00	16.91	17.14	17.11
		1	25	18.00	16.48	16.93	16.99
		1	49	18.00	16.99	17.26	17.25
		25	0	18.00	16.66	16.57	16.52
		25	13	18.00	16.50	16.54	16.45
		25	25	18.00	16.58	16.52	16.48
		50	0	18.00	16.66	16.74	16.69
Bandwidth	Modulation	RB size	RB offset	Tune-up	Channel	Channel	Channel
10MHz	QPSK	1	0	18.00	16.94	16.87	16.84
		1	25	18.00	16.58	16.65	16.66
		1	49	18.00	17.02	16.78	16.87
		25	0	18.00	16.65	16.67	16.61
		25	13	18.00	16.75	16.77	16.68
		25	25	18.00	16.57	16.69	16.80
		50	0	18.00	16.65	16.75	16.69
	16QAM	1	0	18.00	16.70	17.23	17.13
		1	25	18.00	16.47	16.94	16.97
		1	49	18.00	16.98	17.27	17.20
		25	0	18.00	16.67	16.45	16.51
		25	13	18.00	16.50	16.57	16.46
		25	25	18.00	16.59	16.51	16.48
		50	0	18.00	16.67	16.70	16.59
	64QAM	1	0	18.00	16.91	17.14	17.11
		1	25	18.00	16.48	16.93	16.99
		1	49	18.00	16.99	17.26	17.25
		25	0	18.00	16.66	16.57	16.52
		25	13	18.00	16.50	16.54	16.45
		25	25	18.00	16.58	16.52	16.48
		50	0	18.00	16.66	16.74	16.69

Bandwidth	Modulation	RB size	RB offset	Tune-up	Channel	Channel	Channel
				Max.	132047CH	132322CH	132597CH
15MHz	QPSK	1	0	18.00	16.80	16.72	16.76
		1	38	18.00	16.61	16.48	16.54
		1	74	18.00	16.67	16.57	16.57
		36	0	18.00	16.72	16.56	16.79
		36	18	18.00	16.55	16.57	16.62
		36	39	18.00	16.64	16.65	16.66
		75	0	18.00	16.69	16.48	16.56
	16QAM	1	0	18.00	16.86	16.94	16.73
		1	38	18.00	16.65	16.94	16.60
		1	74	18.00	16.84	16.76	16.74
		36	0	18.00	16.65	16.53	16.55
		36	18	18.00	16.59	16.41	16.57
		36	39	18.00	16.59	16.62	16.41
		75	0	18.00	16.65	16.41	16.52
	64QAM	1	0	18.00	16.83	16.94	16.68
		1	38	18.00	16.82	16.92	16.65
		1	74	18.00	16.84	16.77	16.70
		36	0	18.00	16.65	16.53	16.52
		36	18	18.00	16.59	16.43	16.49
		36	39	18.00	16.59	16.63	16.43
		75	0	18.00	16.69	16.47	16.56
Bandwidth	Modulation	RB size	RB offset	Tune-up	Channel	Channel	Channel
20MHz	QPSK	1	0	18.00	16.95	16.92	16.85
		1	50	18.00	16.96	16.97	16.86
		1	99	18.00	16.74	16.81	16.61
		50	0	18.00	16.67	16.78	16.51
		50	25	18.00	16.46	16.54	16.79
		50	50	18.00	16.71	16.68	16.55
		100	0	18.00	16.60	16.77	16.53
	16QAM	1	0	18.00	16.68	17.20	16.73
		1	50	18.00	16.45	16.66	16.38
		1	99	18.00	16.80	17.02	16.72
		50	0	18.00	16.68	16.71	16.42
		50	25	18.00	16.57	16.51	16.35
		50	50	18.00	16.52	16.64	16.52
		100	0	18.00	16.54	16.70	16.47
	64QAM	1	0	18.00	16.67	17.15	16.73
		1	50	18.00	16.58	16.68	16.38
		1	99	18.00	16.74	17.07	16.61
		50	0	18.00	16.62	16.68	16.42
		50	25	18.00	16.42	16.66	16.35
		50	50	18.00	16.52	16.63	16.52
		100	0	18.00	16.60	16.78	16.53

Table 101: Conducted power measurement results of LTE Band 66 (Reduced Power Level D1)

Bandwidth	Modulation	RB size	RB offset	Tune-up	Channel	Channel	Channel	
				Max.	131979CH	132322CH	132665CH	
1.4MHz	QPSK	1	0	23.00	21.80	21.78	21.85	
		1	3	23.00	21.79	21.77	21.92	
		1	5	23.00	22.06	21.89	22.04	
		3	0	23.00	21.89	21.92	21.99	
		3	2	23.00	21.94	21.92	21.97	
		3	3	23.00	21.93	21.81	22.03	
	16QAM	6	0	22.00	20.99	20.93	21.01	
		1	0	22.00	21.00	20.96	20.99	
		1	3	22.00	21.04	20.94	20.98	
		1	5	22.00	21.00	21.02	20.98	
		3	0	22.00	21.01	20.95	20.99	
		3	2	22.00	20.94	20.97	20.93	
	64QAM	3	3	22.00	20.90	20.91	20.92	
		6	0	21.00	20.00	19.88	20.04	
		1	0	21.00	20.03	19.98	19.99	
		1	3	21.00	20.00	20.94	20.01	
		1	5	21.00	19.96	20.01	20.02	
		3	0	21.00	19.92	19.86	19.90	
	3MHz	QPSK	3	2	21.00	19.95	20.88	19.88
			3	3	21.00	19.93	20.92	19.91
			6	0	20.00	18.89	18.94	18.92
1			0	23.00	21.61	21.60	21.67	
1			7	23.00	21.61	21.59	21.73	
1			14	23.00	21.88	21.71	21.86	
16QAM		8	0	22.00	20.71	20.74	20.81	
		8	4	22.00	20.76	20.74	20.79	
		8	7	22.00	20.75	20.63	20.85	
		15	0	22.00	20.81	20.75	20.83	
		1	0	22.00	20.82	20.78	20.81	
		1	7	22.00	20.86	20.76	20.80	
64QAM		1	14	22.00	20.82	20.83	20.80	
		8	0	21.00	19.83	19.77	19.80	
		8	4	21.00	19.75	19.59	19.85	
		8	7	21.00	19.76	19.72	19.94	
		15	0	21.00	19.82	19.70	19.86	
		1	0	21.00	19.85	19.80	19.81	
16QAM		1	7	21.00	19.82	20.76	19.83	
		1	14	21.00	19.78	19.83	19.84	
		8	0	20.00	18.74	18.68	18.72	
	8	4	20.00	18.77	19.70	18.70		
	8	7	20.00	18.75	19.74	18.73		
	15	0	20.00	18.71	18.76	18.74		

Bandwidth	Modulation	RB size	RB offset	Tune-up	Channel	Channel	Channel
				Max.	131997CH	132322CH	132647CH
5MHz	QPSK	1	0	23.00	21.79	21.88	21.74
		1	13	23.00	21.64	21.63	21.55
		1	24	23.00	22.01	21.90	22.00
		12	0	22.00	20.91	20.83	20.89
		12	6	22.00	20.78	20.65	20.89
		12	13	22.00	20.67	20.74	20.84
		25	0	22.00	20.73	20.68	20.62
	16QAM	1	0	22.00	21.07	21.25	20.75
		1	13	22.00	20.89	21.00	20.70
		1	24	22.00	20.97	20.98	21.00
		12	0	21.00	19.78	19.77	19.66
		12	6	21.00	19.60	19.64	19.72
		12	13	21.00	19.68	19.67	19.95
		25	0	21.00	19.70	19.63	19.53
	64QAM	1	0	21.00	19.71	19.70	19.78
		1	13	21.00	19.81	19.78	19.67
		1	24	21.00	19.80	19.75	19.83
		12	0	20.00	18.80	18.80	18.62
		12	6	20.00	18.60	18.64	18.58
		12	13	20.00	18.68	18.67	18.96
		25	0	20.00	18.73	18.69	18.63
Bandwidth	Modulation	RB size	RB offset	Tune-up	Channel	Channel	Channel
10MHz	QPSK	1	0	23.00	21.65	21.64	21.71
		1	25	23.00	21.65	21.63	21.77
		1	49	23.00	21.92	21.75	21.90
		25	0	22.00	20.75	20.78	20.85
		25	13	22.00	20.80	20.78	20.83
		25	25	22.00	20.78	20.66	20.89
		50	0	22.00	20.84	20.78	20.87
	16QAM	1	0	22.00	20.86	20.82	20.85
		1	25	22.00	20.89	20.80	20.84
		1	49	22.00	20.86	20.87	20.84
		25	0	21.00	19.86	19.80	19.84
		25	13	21.00	19.79	19.63	19.89
		25	25	21.00	19.79	19.76	19.98
		50	0	21.00	19.86	19.74	19.90
	64QAM	1	0	21.00	19.89	19.84	19.85
		1	25	21.00	19.86	20.80	19.87
		1	49	21.00	19.82	19.87	19.88
		25	0	20.00	18.78	18.72	18.76
		25	13	20.00	18.81	19.73	18.74
		25	25	20.00	18.79	19.78	18.77
		50	0	20.00	18.75	18.80	18.78
Bandwidth	Modulation	RB size	RB offset	Tune-up	Channel	Channel	Channel
10MHz	QPSK	1	0	23.00	21.65	21.64	21.71
		1	25	23.00	21.65	21.63	21.77
		1	49	23.00	21.92	21.75	21.90
		25	0	22.00	20.75	20.78	20.85
		25	13	22.00	20.80	20.78	20.83
		25	25	22.00	20.78	20.66	20.89
		50	0	22.00	20.84	20.78	20.87
	16QAM	1	0	22.00	20.86	20.82	20.85
		1	25	22.00	20.89	20.80	20.84
		1	49	22.00	20.86	20.87	20.84
		25	0	21.00	19.86	19.80	19.84
		25	13	21.00	19.79	19.63	19.89
		25	25	21.00	19.79	19.76	19.98
		50	0	21.00	19.86	19.74	19.90
	64QAM	1	0	21.00	19.89	19.84	19.85
		1	25	21.00	19.86	20.80	19.87
		1	49	21.00	19.82	19.87	19.88
		25	0	20.00	18.78	18.72	18.76
		25	13	20.00	18.81	19.73	18.74
		25	25	20.00	18.79	19.78	18.77
		50	0	20.00	18.75	18.80	18.78

Bandwidth	Modulation	RB size	RB offset	Tune-up	Channel	Channel	Channel
				Max.	132047CH	132322CH	132597CH
15MHz	QPSK	1	0	23.00	21.73	21.72	21.79
		1	38	23.00	21.73	21.71	21.85
		1	74	23.00	22.00	21.83	21.98
		36	0	22.00	20.83	20.86	20.93
		36	18	22.00	20.88	20.86	20.91
		36	39	22.00	20.86	20.75	20.97
		75	0	22.00	20.93	20.87	20.95
	16QAM	1	0	22.00	20.94	20.90	20.93
		1	38	22.00	20.97	20.88	20.92
		1	74	22.00	20.94	20.95	20.92
		36	0	21.00	19.95	19.89	19.92
		36	18	21.00	19.87	19.71	19.97
		36	39	21.00	19.88	19.84	20.06
		75	0	21.00	19.94	19.82	19.98
	64QAM	1	0	21.00	19.97	19.92	19.93
		1	38	21.00	19.94	20.88	19.95
		1	74	21.00	19.90	19.95	19.96
		36	0	20.00	18.86	18.80	18.84
		36	18	20.00	18.89	19.82	18.82
		36	39	20.00	18.87	19.86	18.85
		75	0	20.00	18.83	18.88	18.86
Bandwidth	Modulation	RB size	RB offset	Tune-up	Channel	Channel	Channel
20MHz	QPSK	1	0	23.00	21.71	21.80	21.65
		1	50	23.00	21.56	21.55	21.46
		1	99	23.00	21.93	21.81	21.92
		50	0	22.00	20.83	20.74	20.81
		50	25	22.00	20.70	20.56	20.81
		50	50	22.00	20.59	20.65	20.76
		100	0	22.00	20.64	20.60	20.54
	16QAM	1	0	22.00	20.98	21.17	20.67
		1	50	22.00	20.81	20.92	20.62
		1	99	22.00	20.89	20.90	20.92
		50	0	21.00	19.70	19.69	19.58
		50	25	21.00	19.51	19.55	19.63
		50	50	21.00	19.59	19.58	19.87
		100	0	21.00	19.62	19.55	19.45
	64QAM	1	0	21.00	19.63	19.62	19.70
		1	50	21.00	19.73	19.70	19.59
		1	99	21.00	19.72	19.67	19.75
		50	0	20.00	18.72	18.72	18.54
		50	25	20.00	18.52	18.56	18.50
		50	50	20.00	18.60	18.59	18.88
		100	0	20.00	18.65	18.61	18.55
Bandwidth	Modulation	RB size	RB offset	Tune-up	Channel	Channel	Channel
				Max.	132072CH	132322CH	132572CH

Table 102: Conducted power measurement results of LTE Band 66 (Full Power)

Bandwidth	Modulation	RB size	RB offset	Tune-up	Channel	Channel	Channel	
				Max.	131979CH	132322CH	132665CH	
1.4MHz	QPSK	1	0	15.00	13.75	13.56	13.71	
		1	3	15.00	13.55	13.60	13.72	
		1	5	15.00	13.75	13.51	13.77	
		3	0	15.00	13.64	13.66	13.86	
		3	2	15.00	13.58	13.74	13.86	
		3	3	15.00	13.60	13.66	13.76	
	16QAM	6	0	15.00	13.63	13.54	13.70	
		1	0	15.00	13.76	13.69	13.69	
		1	3	15.00	13.61	13.72	13.71	
		1	5	15.00	13.79	13.77	13.72	
		3	0	15.00	13.64	13.58	13.56	
		3	2	15.00	13.49	13.70	13.52	
	64QAM	3	3	15.00	13.61	13.70	13.51	
		6	0	15.00	13.66	13.44	13.61	
		1	0	15.00	13.77	13.68	13.69	
		1	3	15.00	13.62	13.71	13.70	
		1	5	15.00	13.78	13.64	13.72	
		3	0	15.00	13.64	13.67	13.57	
	3MHz	QPSK	3	2	15.00	13.50	13.46	13.52
			3	3	15.00	13.61	13.60	13.51
			6	0	15.00	13.64	13.54	13.70
1			0	15.00	13.95	13.92	13.85	
1			7	15.00	13.64	13.49	13.42	
1			14	15.00	13.74	13.81	13.61	
16QAM		8	0	15.00	13.67	13.78	13.51	
		8	4	15.00	13.46	13.54	13.44	
		8	7	15.00	13.71	13.68	13.55	
		15	0	15.00	13.60	13.77	13.53	
		1	0	15.00	13.68	14.20	13.73	
		1	7	15.00	13.45	13.66	13.38	
64QAM		1	14	15.00	13.80	14.02	13.72	
		8	0	15.00	13.68	13.71	13.42	
		8	4	15.00	13.57	13.51	13.35	
		8	7	15.00	13.52	13.64	13.52	
		15	0	15.00	13.54	13.70	13.47	
		1	0	15.00	13.67	14.15	13.73	
64QAM		1	7	15.00	13.58	13.68	13.38	
		1	14	15.00	13.74	14.07	13.61	
		8	0	15.00	13.62	13.68	13.42	
	8	4	15.00	13.42	13.66	13.35		
	8	7	15.00	13.52	13.63	13.52		
	15	0	15.00	13.60	13.78	13.53		

Bandwidth	Modulation	RB size	RB offset	Tune-up	Channel	Channel	Channel
				Max.	131997CH	132322CH	132647CH
5MHz	QPSK	1	0	15.00	13.84	13.77	13.74
		1	13	15.00	13.48	13.55	13.56
		1	24	15.00	13.92	13.68	13.77
		12	0	15.00	13.55	13.57	13.51
		12	6	15.00	13.65	13.67	13.58
		12	13	15.00	13.47	13.59	13.70
		25	0	15.00	13.55	13.65	13.59
	16QAM	1	0	15.00	13.60	14.13	14.03
		1	13	15.00	13.37	13.84	13.87
		1	24	15.00	13.88	14.17	14.10
		12	0	15.00	13.57	13.35	13.41
		12	6	15.00	13.40	13.47	13.36
		12	13	15.00	13.49	13.41	13.38
		25	0	15.00	13.57	13.60	13.49
	64QAM	1	0	15.00	13.81	14.04	14.01
		1	13	15.00	13.38	13.83	13.89
		1	24	15.00	13.89	14.16	14.15
		12	0	15.00	13.56	13.47	13.42
		12	6	15.00	13.40	13.44	13.35
		12	13	15.00	13.48	13.42	13.38
		25	0	15.00	13.56	13.64	13.59
Bandwidth	Modulation	RB size	RB offset	Tune-up	Channel	Channel	Channel
10MHz	QPSK	1	0	15.00	13.89	13.80	13.84
		1	25	15.00	13.41	13.29	13.51
		1	49	15.00	13.85	13.73	13.81
		25	0	15.00	13.70	13.63	13.75
		25	13	15.00	13.47	13.45	13.49
		25	25	15.00	13.43	13.40	13.75
		50	0	15.00	13.62	13.38	13.61
	16QAM	1	0	15.00	13.58	13.83	13.71
		1	25	15.00	13.47	13.69	13.56
		1	49	15.00	13.89	13.94	13.86
		25	0	15.00	13.47	13.58	13.65
		25	13	15.00	13.38	13.32	13.66
		25	25	15.00	13.44	13.39	13.67
		50	0	15.00	13.47	13.38	13.39
	64QAM	1	0	15.00	13.91	13.80	13.71
		1	25	15.00	13.58	13.70	13.41
		1	49	15.00	13.70	13.91	13.88
		25	0	15.00	13.56	13.61	13.65
		25	13	15.00	13.42	13.32	13.67
		25	25	15.00	13.43	13.39	13.67
		50	0	15.00	13.62	13.38	13.81
Bandwidth	Modulation	RB size	RB offset	Tune-up	Channel	Channel	Channel
				Max.	132022CH	132322CH	132622CH

Bandwidth	Modulation	RB size	RB offset	Tune-up	Channel	Channel	Channel
				Max.	132047CH	132322CH	132597CH
15MHz	QPSK	1	0	15.00	13.75	13.56	13.71
		1	38	15.00	13.55	13.60	13.72
		1	74	15.00	13.75	13.51	13.77
		36	0	15.00	13.64	13.66	13.86
		36	18	15.00	13.58	13.74	13.86
		36	39	15.00	13.60	13.66	13.76
		75	0	15.00	13.63	13.54	13.70
	16QAM	1	0	15.00	13.76	13.69	13.69
		1	38	15.00	13.61	13.72	13.71
		1	74	15.00	13.79	13.77	13.72
		36	0	15.00	13.64	13.58	13.56
		36	18	15.00	13.49	13.70	13.52
		36	39	15.00	13.61	13.70	13.51
		75	0	15.00	13.66	13.44	13.61
	64QAM	1	0	15.00	13.77	13.68	13.69
		1	38	15.00	13.62	13.71	13.70
		1	74	15.00	13.78	13.64	13.72
		36	0	15.00	13.64	13.67	13.57
		36	18	15.00	13.50	13.46	13.52
		36	39	15.00	13.61	13.60	13.51
		75	0	15.00	13.64	13.54	13.70
Bandwidth	Modulation	RB size	RB offset	Tune-up	Channel	Channel	Channel
20MHz	QPSK	1	0	15.00	13.94	13.87	13.84
		1	50	15.00	13.58	13.65	13.66
		1	99	15.00	14.02	13.78	13.87
		50	0	15.00	13.65	13.67	13.61
		50	25	15.00	13.75	13.77	13.68
		50	50	15.00	13.57	13.69	13.80
		100	0	15.00	13.65	13.75	13.69
	16QAM	1	0	15.00	13.70	13.93	13.83
		1	50	15.00	13.47	13.94	13.97
		1	99	15.00	13.98	13.97	13.90
		50	0	15.00	13.67	13.45	13.51
		50	25	15.00	13.50	13.57	13.46
		50	50	15.00	13.59	13.51	13.48
		100	0	15.00	13.67	13.70	13.59
	64QAM	1	0	15.00	13.91	13.84	13.81
		1	50	15.00	13.48	13.93	13.99
		1	99	15.00	13.99	13.96	13.95
		50	0	15.00	13.66	13.57	13.52
		50	25	15.00	13.50	13.54	13.45
		50	50	15.00	13.58	13.52	13.48
		100	0	15.00	13.66	13.74	13.69
Bandwidth	Modulation	RB size	RB offset	Tune-up	Channel	Channel	Channel
				Max.	132072CH	132322CH	132572CH

Table 103: Conducted power measurement results of LTE Band 66 (Reduced Power Level D3)

Bandwidth	Modulation	RB size	RB offset	Tune-up	Channel	Channel	Channel	
				Max.	131979CH	132322CH	132665CH	
1.4MHz	QPSK	1	0	20.00	18.94	18.87	18.84	
		1	3	20.00	18.58	18.65	18.66	
		1	5	20.00	19.02	18.78	18.87	
		3	0	20.00	18.65	18.67	18.61	
		3	2	20.00	18.75	18.77	18.68	
		3	3	20.00	18.57	18.69	18.80	
	16QAM	6	0	20.00	18.65	18.75	18.69	
		1	0	20.00	18.70	19.23	19.13	
		1	3	20.00	18.47	18.94	18.97	
		1	5	20.00	18.98	19.27	19.20	
		3	0	20.00	18.67	18.45	18.51	
		3	2	20.00	18.50	18.57	18.46	
	64QAM	3	3	20.00	18.59	18.51	18.48	
		6	0	20.00	18.67	18.70	18.59	
		1	0	20.00	18.91	19.14	19.11	
		1	3	20.00	18.48	18.93	18.99	
		1	5	20.00	18.99	19.26	19.25	
		3	0	20.00	18.66	18.57	18.52	
	3MHz	QPSK	3	2	20.00	18.50	18.54	18.45
			3	3	20.00	18.58	18.52	18.48
			6	0	20.00	18.66	18.74	18.69
1			0	20.00	18.84	18.77	18.74	
1			7	20.00	18.48	18.55	18.56	
1			14	20.00	18.92	18.68	18.77	
16QAM		8	0	20.00	18.55	18.57	18.51	
		8	4	20.00	18.65	18.67	18.58	
		8	7	20.00	18.47	18.59	18.70	
		15	0	20.00	18.55	18.65	18.59	
		1	0	20.00	18.60	19.13	19.03	
		1	7	20.00	18.37	18.84	18.87	
64QAM		1	14	20.00	18.88	19.17	19.10	
		8	0	20.00	18.57	18.35	18.41	
		8	4	20.00	18.40	18.47	18.36	
		8	7	20.00	18.49	18.41	18.38	
		15	0	20.00	18.57	18.60	18.49	
		1	0	20.00	18.81	19.04	19.01	
QPSK		1	7	20.00	18.38	18.83	18.89	
		1	14	20.00	18.89	19.16	19.15	
		8	0	20.00	18.56	18.47	18.42	
	8	4	20.00	18.40	18.44	18.35		
	8	7	20.00	18.48	18.42	18.38		
	15	0	20.00	18.56	18.64	18.59		

Bandwidth	Modulation	RB size	RB offset	Tune-up	Channel	Channel	Channel
				Max.	131997CH	132322CH	132647CH
5MHz	QPSK	1	0	20.00	18.95	18.92	18.85
		1	13	20.00	18.64	18.49	18.42
		1	24	20.00	18.74	18.81	18.61
		12	0	20.00	18.67	18.78	18.51
		12	6	20.00	18.46	18.54	18.44
		12	13	20.00	18.71	18.68	18.55
		25	0	20.00	18.60	18.77	18.53
	16QAM	1	0	20.00	18.68	19.20	18.73
		1	13	20.00	18.45	18.66	18.38
		1	24	20.00	18.80	19.02	18.72
		12	0	20.00	18.68	18.71	18.42
		12	6	20.00	18.57	18.51	18.35
		12	13	20.00	18.52	18.64	18.52
		25	0	20.00	18.54	18.70	18.47
	64QAM	1	0	20.00	18.67	19.15	18.73
		1	13	20.00	18.58	18.68	18.38
		1	24	20.00	18.74	19.07	18.61
		12	0	20.00	18.62	18.68	18.42
		12	6	20.00	18.42	18.66	18.35
		12	13	20.00	18.52	18.63	18.52
		25	0	20.00	18.60	18.78	18.53
Bandwidth	Modulation	RB size	RB offset	Tune-up	Channel	Channel	Channel
10MHz	QPSK	1	0	20.00	18.75	18.56	18.71
		1	25	20.00	18.55	18.60	18.72
		1	49	20.00	18.75	18.51	18.77
		25	0	20.00	18.64	18.66	18.86
		25	13	20.00	18.58	18.74	18.86
		25	25	20.00	18.60	18.66	18.76
		50	0	20.00	18.63	18.54	18.70
	16QAM	1	0	20.00	18.76	18.69	18.69
		1	25	20.00	18.61	18.72	18.71
		1	49	20.00	18.79	18.77	18.72
		25	0	20.00	18.64	18.58	18.56
		25	13	20.00	18.49	18.70	18.52
		25	25	20.00	18.61	18.70	18.51
		50	0	20.00	18.66	18.44	18.61
	64QAM	1	0	20.00	18.77	18.68	18.69
		1	25	20.00	18.62	18.71	18.70
		1	49	20.00	18.78	18.64	18.72
		25	0	20.00	18.64	18.67	18.57
		25	13	20.00	18.50	18.46	18.52
		25	25	20.00	18.61	18.60	18.51
		50	0	20.00	18.64	18.54	18.70
Bandwidth	Modulation	RB size	RB offset	Tune-up	Channel	Channel	Channel
				Max.	132022CH	132322CH	132622CH

Bandwidth	Modulation	RB size	RB offset	Tune-up	Channel	Channel	Channel
				Max.	132047CH	132322CH	132597CH
15MHz	QPSK	1	0	20.00	18.84	18.71	18.68
		1	38	20.00	18.63	18.65	18.69
		1	74	20.00	18.82	18.59	18.72
		36	0	20.00	18.82	18.69	18.82
		36	18	20.00	18.66	18.67	18.57
		36	39	20.00	18.78	18.66	18.72
		75	0	20.00	18.77	18.57	18.66
	16QAM	1	0	20.00	18.73	18.79	18.75
		1	38	20.00	18.58	18.72	18.89
		1	74	20.00	18.70	18.91	18.73
		36	0	20.00	18.74	18.66	18.55
		36	18	20.00	18.66	18.44	18.51
		36	39	20.00	18.79	18.69	18.49
		75	0	20.00	18.73	18.48	18.58
	64QAM	1	0	20.00	18.68	18.76	18.76
		1	38	20.00	18.53	18.87	18.90
		1	74	20.00	18.72	18.77	18.71
		36	0	20.00	18.74	18.67	18.55
		36	18	20.00	18.64	18.42	18.51
		36	39	20.00	18.80	18.68	18.49
		75	0	20.00	18.78	18.56	18.66
Bandwidth	Modulation	RB size	RB offset	Tune-up	Channel	Channel	Channel
20MHz	QPSK	1	0	20.00	18.89	18.80	18.84
		1	50	20.00	18.41	18.29	18.51
		1	99	20.00	18.85	18.73	18.81
		50	0	20.00	18.70	18.63	18.75
		50	25	20.00	18.47	18.45	18.49
		50	50	20.00	18.43	18.40	18.75
		100	0	20.00	18.62	18.38	18.61
	16QAM	1	0	20.00	18.58	18.83	18.71
		1	50	20.00	18.47	18.69	18.56
		1	99	20.00	18.89	18.94	18.86
		50	0	20.00	18.47	18.58	18.65
		50	25	20.00	18.38	18.32	18.66
		50	50	20.00	18.44	18.39	18.67
		100	0	20.00	18.47	18.38	18.39
	64QAM	1	0	20.00	18.95	18.80	18.71
		1	50	20.00	18.58	18.70	18.41
		1	99	20.00	18.70	18.91	18.88
		50	0	20.00	18.56	18.61	18.65
		50	25	20.00	18.42	18.32	18.67
		50	50	20.00	18.43	18.39	18.67
		100	0	20.00	18.62	18.38	18.81
Bandwidth	Modulation	RB size	RB offset	Tune-up	Channel	Channel	Channel
				Max.	132072CH	132322CH	132572CH

Table 104: Conducted power measurement results of LTE Band 66 (Reduced Power Level D2)

7.1.30 Conducted power measurements of LTE Band 66(Main antenna)

Bandwidth	Modulation	RB size	RB offset	Tune-up	Channel	Channel	Channel
				Max.	131979CH	132322CH	132665CH
1.4MHz	QPSK	1	0	24.00	22.66	22.82	22.92
		1	3	24.00	22.70	22.85	22.84
		1	5	24.00	22.65	22.97	23.04
		3	0	24.00	22.69	22.80	22.83
		3	2	24.00	22.79	22.65	22.95
		3	3	24.00	22.97	22.93	22.81
		6	0	23.00	21.90	21.71	21.84
	16QAM	1	0	23.00	21.79	22.10	22.09
		1	3	23.00	21.66	21.79	22.03
		1	5	23.00	21.75	22.09	22.00
		3	0	23.00	22.15	21.93	21.90
		3	2	23.00	21.93	21.67	22.04
		3	3	23.00	22.05	21.79	22.03
		6	0	22.00	20.92	20.73	20.86
	64QAM	1	0	22.00	20.63	20.98	20.89
		1	3	22.00	20.83	21.00	21.13
		1	5	22.00	20.71	20.79	21.22
		3	0	22.00	21.04	20.95	20.98
		3	2	22.00	21.03	20.91	21.00
		3	3	22.00	21.01	20.89	21.11
		6	0	21.00	19.97	19.85	19.89
Bandwidth	Modulation	RB size	RB offset	Tune-up	Channel	Channel	Channel
3MHz	QPSK	1	0	24.00	22.68	22.67	22.80
		1	7	24.00	22.87	22.75	22.97
		1	14	24.00	22.76	22.92	22.98
		8	0	23.00	21.96	21.72	21.79
		8	4	23.00	21.94	21.79	21.99
		8	7	23.00	21.77	21.90	21.95
		15	0	23.00	21.69	21.72	21.85
	16QAM	1	0	23.00	21.87	21.92	21.96
		1	7	23.00	22.17	21.85	22.21
		1	14	23.00	22.01	22.19	22.26
		8	0	22.00	20.93	20.76	20.86
		8	4	22.00	20.85	20.85	20.90
		8	7	22.00	20.80	20.73	20.97
		15	0	22.00	20.67	20.69	20.83
	64QAM	1	0	22.00	20.75	21.17	21.03
		1	7	22.00	21.17	20.84	21.15
		1	14	22.00	21.01	21.19	21.21
		8	0	21.00	19.81	19.96	19.76
		8	4	21.00	19.97	19.85	19.89
		8	7	21.00	19.80	19.93	19.87
		15	0	21.00	19.69	19.71	19.85
Bandwidth	Modulation	RB size	RB offset	Tune-up	Channel	Channel	Channel
3MHz	QPSK	1	0	24.00	22.68	22.67	22.80
		1	7	24.00	22.87	22.75	22.97
		1	14	24.00	22.76	22.92	22.98
		8	0	23.00	21.96	21.72	21.79
		8	4	23.00	21.94	21.79	21.99
		8	7	23.00	21.77	21.90	21.95
		15	0	23.00	21.69	21.72	21.85
	16QAM	1	0	23.00	21.87	21.92	21.96
		1	7	23.00	22.17	21.85	22.21
		1	14	23.00	22.01	22.19	22.26
		8	0	22.00	20.93	20.76	20.86
		8	4	22.00	20.85	20.85	20.90
		8	7	22.00	20.80	20.73	20.97
		15	0	22.00	20.67	20.69	20.83
	64QAM	1	0	22.00	20.75	21.17	21.03
		1	7	22.00	21.17	20.84	21.15
		1	14	22.00	21.01	21.19	21.21
		8	0	21.00	19.81	19.96	19.76
		8	4	21.00	19.97	19.85	19.89
		8	7	21.00	19.80	19.93	19.87
		15	0	21.00	19.69	19.71	19.85

Bandwidth	Modulation	RB size	RB offset	Tune-up	Channel	Channel	Channel
				Max.	131997CH	132322CH	132647CH
5MHz	QPSK	1	0	24.00	22.63	22.72	22.71
		1	13	24.00	22.96	22.85	22.86
		1	24	24.00	22.81	22.93	22.94
		12	0	23.00	21.95	21.72	22.05
		12	6	23.00	21.95	21.76	21.80
		12	13	23.00	21.75	21.84	21.90
		25	0	23.00	21.79	21.69	21.85
	16QAM	1	0	23.00	22.02	21.90	22.08
		1	13	23.00	21.97	21.83	21.90
		1	24	23.00	21.82	21.99	22.04
		12	0	22.00	20.89	20.75	21.01
		12	6	22.00	20.83	20.69	20.77
		12	13	22.00	20.75	20.65	20.87
		25	0	22.00	20.74	20.64	20.72
	64QAM	1	0	22.00	20.92	20.96	21.05
		1	13	22.00	21.06	21.01	20.93
		1	24	22.00	20.94	21.08	21.01
		12	0	21.00	19.74	19.91	19.68
		12	6	21.00	19.84	19.88	19.78
		12	13	21.00	19.76	19.91	19.87
		25	0	21.00	19.79	19.70	19.86
Bandwidth	Modulation	RB size	RB offset	Tune-up	Channel	Channel	Channel
10MHz	QPSK	1	0	24.00	22.91	22.72	22.99
		1	25	24.00	22.98	22.71	22.92
		1	49	24.00	22.80	22.90	22.74
		25	0	23.00	21.98	21.79	22.03
		25	13	23.00	21.95	21.80	22.04
		25	25	23.00	21.86	21.82	21.88
		50	0	23.00	21.77	21.70	21.98
	16QAM	1	0	23.00	21.91	21.74	21.73
		1	25	23.00	21.87	21.80	21.81
		1	49	23.00	22.04	21.94	21.87
		25	0	22.00	20.96	20.79	21.00
		25	13	22.00	20.92	20.82	21.05
		25	25	22.00	20.73	20.85	20.87
		50	0	22.00	20.70	20.68	20.95
	64QAM	1	0	22.00	20.91	20.75	20.90
		1	25	22.00	20.87	20.79	20.90
		1	49	22.00	21.03	20.94	20.99
		25	0	21.00	19.90	19.81	20.00
		25	13	21.00	19.83	19.83	20.06
		25	25	21.00	19.74	19.85	19.87
		50	0	21.00	19.78	19.72	19.89
Bandwidth	Modulation	RB size	RB offset	Tune-up	Channel	Channel	Channel
				Max.	132022CH	132322CH	132622CH

Bandwidth	Modulation	RB size	RB offset	Tune-up	Channel	Channel	Channel
				Max.	132047CH	132322CH	132597CH
15MHz	QPSK	1	0	24.00	22.74	22.73	23.03
		1	38	24.00	22.83	22.82	22.84
		1	74	24.00	23.01	22.57	22.79
		36	0	23.00	22.02	21.67	22.10
		36	18	23.00	21.98	21.72	22.01
		36	39	23.00	21.90	21.68	22.00
		75	0	23.00	21.84	21.72	21.80
	16QAM	1	0	23.00	21.90	21.61	21.93
		1	38	23.00	22.04	21.65	22.06
		1	74	23.00	21.94	21.77	21.98
		36	0	22.00	20.96	20.63	21.13
		36	18	22.00	20.92	20.71	21.00
		36	39	22.00	20.76	20.68	20.98
		75	0	22.00	20.76	20.64	21.05
	64QAM	1	0	22.00	21.03	20.84	20.94
		1	38	22.00	20.93	20.94	21.07
		1	74	22.00	20.88	20.61	21.00
		36	0	21.00	19.87	19.65	20.10
		36	18	21.00	19.81	19.72	19.99
		36	39	21.00	19.76	19.68	19.97
		75	0	21.00	19.80	19.73	19.79
Bandwidth	Modulation	RB size	RB offset	Tune-up	Channel	Channel	Channel
20MHz	QPSK	1	0	24.00	22.96	22.75	22.75
		1	50	24.00	22.76	22.50	22.79
		1	99	24.00	22.95	22.89	22.98
		50	0	23.00	21.96	21.75	21.92
		50	25	23.00	21.87	21.72	21.81
		50	50	23.00	21.72	21.67	21.67
		100	0	23.00	21.77	21.77	21.71
	16QAM	1	0	23.00	21.92	21.94	22.05
		1	50	23.00	21.71	21.59	21.89
		1	99	23.00	21.94	22.03	22.05
		50	0	22.00	20.80	20.74	20.68
		50	25	22.00	20.72	20.69	20.63
		50	50	22.00	20.69	20.69	20.64
		100	0	22.00	20.69	20.68	20.68
	64QAM	1	0	22.00	20.67	20.69	20.79
		1	50	22.00	20.66	20.61	20.77
		1	99	22.00	20.68	20.60	20.70
		50	0	21.00	19.81	19.76	19.71
		50	25	21.00	19.71	19.72	19.64
		50	50	21.00	19.69	19.68	19.65
		100	0	21.00	19.78	19.78	19.74
Bandwidth	Modulation	RB size	RB offset	Tune-up	Channel	Channel	Channel
				Max.	132072CH	132322CH	132572CH

Table 105: Conducted power measurement results of LTE Band 66 (Full Power)

Bandwidth	Modulation	RB size	RB offset	Tune-up	Channel	Channel	Channel	
				Max.	131979CH	132322CH	132665CH	
1.4MHz	QPSK	1	0	23.00	21.95	21.83	21.78	
		1	3	23.00	21.64	21.79	21.66	
		1	5	23.00	21.90	21.86	21.90	
		3	0	23.00	21.93	21.78	21.75	
		3	2	23.00	21.77	21.73	21.77	
		3	3	23.00	21.90	21.74	21.86	
	16QAM	6	0	23.00	21.68	21.70	21.83	
		1	0	23.00	21.87	21.64	21.85	
		1	3	23.00	21.78	21.80	21.63	
		1	5	23.00	21.95	22.07	21.74	
		3	0	23.00	21.74	21.85	21.71	
		3	2	23.00	21.86	21.74	21.72	
	64QAM	3	3	23.00	21.72	21.72	21.71	
		6	0	22.00	20.67	20.78	20.81	
		1	0	22.00	20.86	20.96	20.59	
		1	3	22.00	20.87	20.60	20.62	
		1	5	22.00	20.83	20.74	20.84	
		3	0	22.00	20.74	20.63	20.71	
	3MHz	QPSK	3	2	22.00	20.85	20.84	20.73
			3	3	22.00	20.82	20.70	20.86
			6	0	21.00	19.69	19.69	19.83
1			0	23.00	21.75	21.63	22.03	
1			7	23.00	22.02	21.72	22.14	
1			14	23.00	21.84	21.91	21.94	
16QAM		8	0	23.00	21.97	21.61	21.90	
		8	4	23.00	21.74	21.67	21.92	
		8	7	23.00	21.83	21.69	22.02	
		15	0	23.00	21.84	21.63	21.91	
		1	0	23.00	21.66	22.08	21.85	
		1	7	23.00	21.67	21.99	22.15	
64QAM	1	14	23.00	22.24	22.09	21.83		
	8	0	22.00	20.98	20.68	21.14		
	8	4	22.00	20.87	20.76	21.18		
	8	7	22.00	20.71	20.79	21.14		
	15	0	22.00	20.83	20.63	20.90		
	1	0	22.00	21.04	21.07	21.08		
64QAM	1	7	22.00	21.07	20.98	21.14		
	1	14	22.00	21.24	21.03	20.81		
	8	0	21.00	19.90	19.92	20.01		
	8	4	21.00	19.87	19.78	20.19		
	8	7	21.00	19.82	19.80	20.14		
	15	0	21.00	19.85	19.64	19.92		

Bandwidth	Modulation	RB size	RB offset	Tune-up	Channel	Channel	Channel
				Max.	131997CH	132322CH	132647CH
5MHz	QPSK	1	0	23.00	21.90	21.85	21.91
		1	13	23.00	21.99	21.81	21.85
		1	24	23.00	21.83	21.79	21.97
		12	0	23.00	21.97	21.76	22.09
		12	6	23.00	21.93	21.68	21.95
		12	13	23.00	21.78	21.76	21.88
		25	0	23.00	21.80	21.57	21.86
	16QAM	1	0	23.00	21.81	21.91	21.93
		1	13	23.00	22.02	21.78	21.84
		1	24	23.00	21.84	21.99	21.95
		12	0	22.00	20.95	20.65	21.03
		12	6	22.00	20.90	20.59	20.81
		12	13	22.00	20.83	20.81	20.88
		25	0	22.00	20.77	20.60	20.78
	64QAM	1	0	22.00	20.99	20.90	21.05
		1	13	22.00	20.89	20.77	20.82
		1	24	22.00	21.09	21.00	20.93
		12	0	21.00	19.98	19.67	20.09
		12	6	21.00	19.91	19.60	19.83
		12	13	21.00	19.83	19.81	19.91
		25	0	21.00	19.81	19.59	19.88
Bandwidth	Modulation	RB size	RB offset	Tune-up	Channel	Channel	Channel
10MHz	QPSK	1	0	23.00	21.94	21.87	21.92
		1	25	23.00	21.80	21.66	21.94
		1	49	23.00	21.95	21.83	22.04
		25	0	23.00	21.94	21.82	22.04
		25	13	23.00	21.92	21.72	21.91
		25	25	23.00	21.83	21.65	21.87
		50	0	23.00	21.89	21.60	21.77
	16QAM	1	0	23.00	21.89	21.57	21.98
		1	25	23.00	21.81	21.79	21.83
		1	49	23.00	22.01	21.84	22.04
		25	0	22.00	20.89	20.70	21.04
		25	13	22.00	20.89	20.72	21.09
		25	25	22.00	20.81	20.66	21.04
		50	0	22.00	20.82	20.53	20.73
	64QAM	1	0	22.00	20.89	20.67	21.06
		1	25	22.00	20.81	20.78	20.81
		1	49	22.00	21.01	20.85	20.93
		25	0	21.00	19.90	19.73	20.12
		25	13	21.00	19.90	19.73	20.12
		25	25	21.00	19.81	19.66	20.04
		50	0	21.00	19.89	19.61	19.78
Bandwidth	Modulation	RB size	RB offset	Tune-up	Channel	Channel	Channel
10MHz	QPSK	1	0	23.00	21.94	21.87	21.92
		1	25	23.00	21.80	21.66	21.94
		1	49	23.00	21.95	21.83	22.04
		25	0	23.00	21.94	21.82	22.04
		25	13	23.00	21.92	21.72	21.91
		25	25	23.00	21.83	21.65	21.87
		50	0	23.00	21.89	21.60	21.77
	16QAM	1	0	23.00	21.89	21.57	21.98
		1	25	23.00	21.81	21.79	21.83
		1	49	23.00	22.01	21.84	22.04
		25	0	22.00	20.89	20.70	21.04
		25	13	22.00	20.89	20.72	21.09
		25	25	22.00	20.81	20.66	21.04
		50	0	22.00	20.82	20.53	20.73
	64QAM	1	0	22.00	20.89	20.67	21.06
		1	25	22.00	20.81	20.78	20.81
		1	49	22.00	21.01	20.85	20.93
		25	0	21.00	19.90	19.73	20.12
		25	13	21.00	19.90	19.73	20.12
		25	25	21.00	19.81	19.66	20.04
		50	0	21.00	19.89	19.61	19.78

Bandwidth	Modulation	RB size	RB offset	Tune-up	Channel	Channel	Channel
				Max.	132047CH	132322CH	132597CH
15MHz	QPSK	1	0	23.00	22.00	21.84	22.09
		1	38	23.00	22.02	21.81	22.02
		1	74	23.00	21.87	21.58	21.92
		36	0	23.00	21.96	21.65	21.93
		36	18	23.00	21.96	21.70	21.86
		36	39	23.00	21.74	21.67	22.01
		75	0	23.00	21.92	21.71	21.80
	16QAM	1	0	23.00	21.94	21.78	21.93
		1	38	23.00	22.04	21.93	22.13
		1	74	23.00	21.95	21.62	21.97
		36	0	22.00	20.81	20.63	21.14
		36	18	22.00	20.78	20.70	21.05
		36	39	22.00	20.71	20.69	21.01
		75	0	22.00	20.87	20.64	20.75
	64QAM	1	0	22.00	21.02	20.72	20.98
		1	38	22.00	21.06	20.62	21.07
		1	74	22.00	20.92	20.75	21.01
		36	0	21.00	19.82	19.65	20.14
		36	18	21.00	19.78	19.71	20.04
		36	39	21.00	19.87	19.70	20.00
		75	0	21.00	19.92	19.71	19.81
Bandwidth	Modulation	RB size	RB offset	Tune-up	Channel	Channel	Channel
20MHz	QPSK	1	0	23.00	21.94	21.93	21.90
		1	50	23.00	21.71	21.67	21.77
		1	99	23.00	21.97	22.04	21.95
		50	0	23.00	22.01	21.86	21.88
		50	25	23.00	21.93	21.82	21.95
		50	50	23.00	21.82	21.79	21.86
		100	0	23.00	21.86	21.88	21.84
	16QAM	1	0	23.00	22.24	22.15	22.14
		1	50	23.00	22.13	21.76	21.87
		1	99	23.00	22.27	22.00	22.05
		50	0	22.00	20.88	20.82	20.81
		50	25	22.00	20.80	20.80	20.73
		50	50	22.00	20.77	20.77	20.82
		100	0	22.00	20.77	20.79	20.76
	64QAM	1	0	22.00	21.36	21.10	20.92
		1	50	22.00	21.00	20.76	20.84
		1	99	22.00	21.31	21.19	21.03
		50	0	21.00	19.89	19.84	19.81
		50	25	21.00	19.80	19.80	19.74
		50	50	21.00	19.78	19.77	19.82
		100	0	21.00	19.87	19.89	19.86
Bandwidth	Modulation	RB size	RB offset	Tune-up	Channel	Channel	Channel
				Max.	132072CH	132322CH	132572CH

Table 106: Conducted power measurement results of LTE Band 66 (Reduced Power Level D4)

Bandwidth	Modulation	RB size	RB offset	Tune-up	Channel	Channel	Channel	
				Max.	131979CH	132322CH	132665CH	
1.4MHz	QPSK	1	0	21.50	20.30	20.43	20.25	
		1	3	21.50	20.27	20.27	20.12	
		1	5	21.50	20.33	20.52	20.19	
		3	0	21.50	20.52	20.34	20.50	
		3	2	21.50	20.50	20.33	20.40	
		3	3	21.50	20.48	20.40	20.48	
	16QAM	6	0	21.50	20.42	20.44	20.35	
		1	0	21.50	20.74	20.17	20.56	
		1	3	21.50	20.66	20.32	20.52	
		1	5	21.50	20.59	20.15	20.33	
		3	0	21.50	20.40	20.23	20.22	
		3	2	21.50	20.30	20.18	20.15	
	64QAM	3	3	21.50	20.29	20.36	20.30	
		6	0	21.50	20.34	20.29	20.18	
		1	0	21.50	20.79	20.61	20.45	
		1	3	21.50	20.59	20.35	20.26	
		1	5	21.50	20.77	20.77	20.64	
		3	0	21.50	20.40	20.33	20.22	
	3MHz	QPSK	3	2	21.50	20.29	20.31	20.15
			3	3	21.50	20.35	20.36	20.31
			6	0	21.00	19.80	19.67	19.67
1			0	21.50	20.34	19.99	20.16	
1			7	21.50	20.25	20.18	20.08	
1			14	21.50	20.21	20.20	20.22	
8			0	21.50	20.30	20.21	20.13	
16QAM		8	4	21.50	20.61	20.56	20.32	
		8	7	21.50	20.32	20.08	20.17	
		15	0	21.50	20.56	20.42	20.49	
	1	0	21.50	20.36	20.12	19.97		
	1	7	21.50	20.27	20.09	20.05		
	1	14	21.50	20.26	20.07	20.15		
	8	0	21.50	20.22	20.09	20.09		
64QAM	8	4	21.50	20.61	20.44	20.28		
	8	7	21.50	20.32	20.08	20.17		
	15	0	21.50	20.56	20.42	20.53		
	1	0	21.50	20.31	20.12	19.99		
	1	7	21.50	20.21	20.07	20.05		
	1	14	21.50	20.26	20.07	20.15		
	8	0	21.00	19.97	19.90	19.97		
8	4	21.00	19.89	19.54	19.71			
8	7	21.00	19.80	19.73	19.63			
15	0	21.00	19.76	19.75	19.77			

Bandwidth	Modulation	RB size	RB offset	Tune-up	Channel	Channel	Channel
				Max.	131997CH	132322CH	132647CH
5MHz	QPSK	1	0	21.50	20.49	20.31	20.38
		1	13	21.50	20.46	20.38	20.46
		1	24	21.50	20.40	20.42	20.33
		12	0	21.50	20.72	20.15	20.54
		12	6	21.50	20.64	20.30	20.50
		12	13	21.50	20.57	20.13	20.31
		25	0	21.50	20.45	20.36	20.17
	16QAM	1	0	21.50	20.42	20.35	20.09
		1	13	21.50	20.38	20.42	20.09
		1	24	21.50	20.41	20.33	20.28
		12	0	21.50	20.71	20.35	20.32
		12	6	21.50	20.64	20.18	20.49
		12	13	21.50	20.50	20.20	20.33
		25	0	21.50	20.47	20.36	20.36
	64QAM	1	0	21.50	20.43	20.33	20.29
		1	13	21.50	20.38	20.42	20.10
		1	24	21.50	20.40	20.43	20.36
		12	0	21.00	20.11	20.06	19.82
		12	6	21.00	19.82	19.58	19.67
		12	13	21.00	20.06	19.92	19.99
		25	0	21.00	19.86	19.62	19.47
Bandwidth	Modulation	RB size	RB offset	Tune-up	Channel	Channel	Channel
10MHz	QPSK	1	0	21.50	20.28	20.41	20.23
		1	25	21.50	20.25	20.25	20.11
		1	49	21.50	20.32	20.50	20.17
		25	0	21.50	20.51	20.32	20.48
		25	13	21.50	20.49	20.31	20.38
		25	25	21.50	20.46	20.38	20.46
		50	0	21.50	20.40	20.42	20.33
	16QAM	1	0	21.50	20.52	20.15	20.54
		1	25	21.50	20.44	20.30	20.50
		1	49	21.50	20.37	20.13	20.31
		25	0	21.50	20.45	20.36	20.17
		25	13	21.50	20.42	20.35	20.09
		25	25	21.50	20.38	20.42	20.09
		50	0	21.50	20.41	20.33	20.28
	64QAM	1	0	21.50	20.51	20.35	20.32
		1	25	21.50	20.44	20.18	20.49
		1	49	21.50	20.40	20.20	20.33
		25	0	21.00	20.11	19.94	19.78
		25	13	21.00	19.82	19.58	19.67
		25	25	21.00	20.06	19.92	20.03
		50	0	21.00	19.31	19.12	18.99
Bandwidth	Modulation	RB size	RB offset	Tune-up	Channel	Channel	Channel
10MHz	QPSK	1	0	21.50	20.28	20.41	20.23
		1	25	21.50	20.25	20.25	20.11
		1	49	21.50	20.32	20.50	20.17
		25	0	21.50	20.51	20.32	20.48
		25	13	21.50	20.49	20.31	20.38
		25	25	21.50	20.46	20.38	20.46
		50	0	21.50	20.40	20.42	20.33
	16QAM	1	0	21.50	20.52	20.15	20.54
		1	25	21.50	20.44	20.30	20.50
		1	49	21.50	20.37	20.13	20.31
		25	0	21.50	20.45	20.36	20.17
		25	13	21.50	20.42	20.35	20.09
		25	25	21.50	20.38	20.42	20.09
		50	0	21.50	20.41	20.33	20.28
	64QAM	1	0	21.50	20.51	20.35	20.32
		1	25	21.50	20.44	20.18	20.49
		1	49	21.50	20.40	20.20	20.33
		25	0	21.00	20.11	19.94	19.78
		25	13	21.00	19.82	19.58	19.67
		25	25	21.00	20.06	19.92	20.03
		50	0	21.00	19.31	19.12	18.99

Bandwidth	Modulation	RB size	RB offset	Tune-up	Channel	Channel	Channel
				Max.	132047CH	132322CH	132597CH
15MHz	QPSK	1	0	21.50	20.21	20.10	20.29
		1	38	21.50	20.22	19.90	20.11
		1	74	21.50	20.11	20.04	20.02
		36	0	21.50	20.20	20.01	20.07
		36	18	21.50	20.18	20.17	20.06
		36	39	21.50	20.60	20.54	20.23
		75	0	21.50	20.21	20.15	20.10
	16QAM	1	0	21.50	20.53	20.45	20.42
		1	38	21.50	20.18	20.01	20.00
		1	74	21.50	20.08	19.96	19.93
		36	0	21.50	20.07	20.14	20.08
		36	18	21.50	20.12	20.07	19.96
		36	39	21.50	20.57	20.39	20.23
		75	0	21.50	20.37	20.13	20.04
	64QAM	1	0	21.50	20.55	20.55	20.42
		1	38	21.50	20.18	20.11	20.00
		1	74	21.50	20.07	20.09	19.93
		36	0	21.00	19.94	19.85	19.77
		36	18	21.00	19.73	19.53	19.62
		36	39	21.00	19.92	19.85	19.92
		75	0	21.00	19.84	19.49	19.66
Bandwidth	Modulation	RB size	RB offset	Tune-up	Channel	Channel	Channel
20MHz	QPSK	1	0	21.50	20.44	20.35	20.27
		1	50	21.50	20.23	20.03	20.12
		1	99	21.50	20.42	20.35	20.42
		50	0	21.50	20.34	20.20	20.22
		50	25	21.50	20.25	20.18	20.08
		50	50	21.50	20.21	19.99	20.01
		100	0	21.50	20.30	20.21	20.13
	16QAM	1	0	21.50	20.61	20.56	20.32
		1	50	21.50	20.32	20.08	20.17
		1	99	21.50	20.56	20.42	20.49
		50	0	21.50	20.36	20.12	19.97
		50	25	21.50	20.27	20.09	20.05
		50	50	21.50	20.26	20.07	20.15
		100	0	21.50	20.22	20.09	20.09
	64QAM	1	0	21.50	20.61	20.44	20.28
		1	50	21.50	20.32	20.08	20.17
		1	99	21.50	20.56	20.42	20.53
		50	0	21.00	19.81	19.62	19.49
		50	25	21.00	19.71	19.57	19.55
		50	50	21.00	19.76	19.57	19.65
		100	0	21.00	19.80	19.71	19.62

Table 107: Conducted power measurement results of LTE Band 66 (Reduced Power Level D6/D8/D10)

Bandwidth	Modulation	RB size	RB offset	Tune-up	Channel	Channel	Channel	
				Max.	131979CH	132322CH	132665CH	
1.4MHz	QPSK	1	0	20.50	19.44	19.35	19.27	
		1	3	20.50	19.23	19.03	19.12	
		1	5	20.50	19.42	19.35	19.42	
		3	0	20.50	19.34	18.99	19.16	
		3	2	20.50	19.25	19.18	19.08	
		3	3	20.50	19.21	19.20	19.22	
	16QAM	6	0	20.50	19.30	19.21	19.13	
		1	0	20.50	19.61	19.56	19.32	
		1	3	20.50	19.32	19.08	19.17	
		1	5	20.50	19.56	19.42	19.49	
		3	0	20.50	19.36	19.12	18.97	
		3	2	20.50	19.27	19.09	19.05	
	64QAM	3	3	20.50	19.26	19.07	19.15	
		6	0	20.50	19.22	19.09	19.09	
		1	0	20.50	19.61	19.44	19.28	
		1	3	20.50	19.32	19.08	19.17	
		1	5	20.50	19.56	19.42	19.53	
		3	0	20.50	19.31	19.12	18.99	
	3MHz	QPSK	3	2	20.50	19.21	19.07	19.05
			3	3	20.50	19.26	19.07	19.15
			6	0	20.50	19.30	19.21	19.12
1			0	20.50	19.30	19.43	19.25	
1			7	20.50	19.27	19.27	19.12	
1			14	20.50	19.33	19.52	19.19	
16QAM		8	0	20.50	19.52	19.34	19.50	
		8	4	20.50	19.50	19.33	19.40	
		8	7	20.50	19.48	19.40	19.48	
		15	0	20.50	19.42	19.44	19.35	
		1	0	20.50	19.74	19.17	19.56	
		1	7	20.50	19.66	19.32	19.52	
64QAM		1	14	20.50	19.59	19.15	19.33	
		8	0	20.50	19.40	19.23	19.22	
		8	4	20.50	19.30	19.18	19.15	
		8	7	20.50	19.29	19.36	19.30	
		15	0	20.50	19.34	19.29	19.18	
		1	0	20.50	19.79	19.61	19.45	
QPSK		1	7	20.50	19.59	19.35	19.26	
		1	14	20.50	19.77	19.77	19.64	
		8	0	20.50	19.40	19.33	19.22	
	8	4	20.50	19.29	19.31	19.15		
	8	7	20.50	19.35	19.36	19.31		
	15	0	20.50	19.40	19.39	19.26		

Bandwidth	Modulation	RB size	RB offset	Tune-up	Channel	Channel	Channel
				Max.	131997CH	132322CH	132647CH
5MHz	QPSK	1	0	20.50	19.38	19.51	19.33
		1	13	20.50	19.35	19.35	19.21
		1	24	20.50	19.42	19.60	19.27
		12	0	20.50	19.61	19.42	19.58
		12	6	20.50	19.59	19.41	19.48
		12	13	20.50	19.56	19.48	19.56
		25	0	20.50	19.50	19.52	19.43
	16QAM	1	0	20.50	19.82	19.25	19.64
		1	13	20.50	19.74	19.40	19.60
		1	24	20.50	19.67	19.23	19.41
		12	0	20.50	19.55	19.46	19.27
		12	6	20.50	19.52	19.45	19.19
		12	13	20.50	19.48	19.52	19.19
		25	0	20.50	19.51	19.43	19.38
	64QAM	1	0	20.50	19.81	19.45	19.42
		1	13	20.50	19.74	19.28	19.59
		1	24	20.50	19.60	19.30	19.43
		12	0	20.50	19.57	19.46	19.46
		12	6	20.50	19.53	19.43	19.39
		12	13	20.50	19.48	19.52	19.20
		25	0	20.50	19.50	19.53	19.46
Bandwidth	Modulation	RB size	RB offset	Tune-up	Channel	Channel	Channel
10MHz	QPSK	1	0	20.50	19.20	19.33	19.15
		1	25	20.50	19.17	19.17	19.02
		1	49	20.50	19.23	19.42	19.09
		25	0	20.50	19.42	19.24	19.40
		25	13	20.50	19.40	19.23	19.30
		25	25	20.50	19.38	19.30	19.38
		50	0	20.50	19.32	19.34	19.25
	16QAM	1	0	20.50	19.64	19.07	19.46
		1	25	20.50	19.56	19.22	19.42
		1	49	20.50	19.49	19.05	19.23
		25	0	20.50	19.30	19.13	19.12
		25	13	20.50	19.20	19.08	19.05
		25	25	20.50	19.19	19.26	19.20
		50	0	20.50	19.24	19.19	19.08
	64QAM	1	0	20.50	19.69	19.51	19.35
		1	25	20.50	19.49	19.25	19.16
		1	49	20.50	19.67	19.67	19.54
		25	0	20.50	19.30	19.23	19.12
		25	13	20.50	19.19	19.21	19.05
		25	25	20.50	19.25	19.26	19.21
		50	0	20.50	19.30	19.29	19.16
Bandwidth	Modulation	RB size	RB offset	Tune-up	Channel	Channel	Channel
10MHz	QPSK	1	0	20.50	19.20	19.33	19.15
		1	25	20.50	19.17	19.17	19.02
		1	49	20.50	19.23	19.42	19.09
		25	0	20.50	19.42	19.24	19.40
		25	13	20.50	19.40	19.23	19.30
		25	25	20.50	19.38	19.30	19.38
		50	0	20.50	19.32	19.34	19.25
	16QAM	1	0	20.50	19.64	19.07	19.46
		1	25	20.50	19.56	19.22	19.42
		1	49	20.50	19.49	19.05	19.23
		25	0	20.50	19.30	19.13	19.12
		25	13	20.50	19.20	19.08	19.05
		25	25	20.50	19.19	19.26	19.20
		50	0	20.50	19.24	19.19	19.08
	64QAM	1	0	20.50	19.69	19.51	19.35
		1	25	20.50	19.49	19.25	19.16
		1	49	20.50	19.67	19.67	19.54
		25	0	20.50	19.30	19.23	19.12
		25	13	20.50	19.19	19.21	19.05
		25	25	20.50	19.25	19.26	19.21
		50	0	20.50	19.30	19.29	19.16

Bandwidth	Modulation	RB size	RB offset	Tune-up	Channel	Channel	Channel
				Max.	132047CH	132322CH	132597CH
15MHz	QPSK	1	0	20.50	19.28	19.41	19.23
		1	38	20.50	19.25	19.25	19.11
		1	74	20.50	19.32	19.50	19.17
		36	0	20.50	19.51	19.32	19.48
		36	18	20.50	19.49	19.31	19.38
		36	39	20.50	19.46	19.38	19.46
		75	0	20.50	19.40	19.42	19.33
	16QAM	1	0	20.50	19.72	19.15	19.54
		1	38	20.50	19.64	19.30	19.50
		1	74	20.50	19.57	19.13	19.31
		36	0	20.50	19.45	19.36	19.17
		36	18	20.50	19.42	19.35	19.09
		36	39	20.50	19.38	19.42	19.09
		75	0	20.50	19.41	19.33	19.28
	64QAM	1	0	20.50	19.71	19.35	19.32
		1	38	20.50	19.64	19.18	19.49
		1	74	20.50	19.50	19.20	19.33
		36	0	20.50	19.47	19.36	19.36
		36	18	20.50	19.43	19.33	19.29
		36	39	20.50	19.38	19.42	19.10
		75	0	20.50	19.40	19.43	19.36
Bandwidth	Modulation	RB size	RB offset	Tune-up	Channel	Channel	Channel
20MHz	QPSK	1	0	20.50	19.46	19.41	19.35
		1	50	20.50	19.07	18.96	19.24
		1	99	20.50	19.31	19.20	19.39
		50	0	20.50	19.32	19.00	19.21
		50	25	20.50	19.21	19.14	19.12
		50	50	20.50	19.30	19.11	19.17
		100	0	20.50	19.28	19.27	19.16
	16QAM	1	0	20.50	19.60	19.54	19.33
		1	50	20.50	19.31	19.25	19.20
		1	99	20.50	19.53	19.55	19.52
		50	0	20.50	19.28	19.11	19.10
		50	25	20.50	19.18	19.06	19.03
		50	50	20.50	19.17	19.24	19.18
		100	0	20.50	19.22	19.17	19.06
	64QAM	1	0	20.50	19.57	19.49	19.33
		1	50	20.50	19.47	19.23	19.14
		1	99	20.50	19.55	19.45	19.42
		50	0	20.50	19.28	19.21	19.10
		50	25	20.50	19.17	19.19	19.03
		50	50	20.50	19.23	19.24	19.19
		100	0	20.50	19.28	19.27	19.14
Bandwidth	Modulation	RB size	RB offset	Tune-up	Channel	Channel	Channel
20MHz	QPSK	1	0	20.50	19.46	19.41	19.35
		1	50	20.50	19.07	18.96	19.24
		1	99	20.50	19.31	19.20	19.39
		50	0	20.50	19.32	19.00	19.21
		50	25	20.50	19.21	19.14	19.12
		50	50	20.50	19.30	19.11	19.17
		100	0	20.50	19.28	19.27	19.16
	16QAM	1	0	20.50	19.60	19.54	19.33
		1	50	20.50	19.31	19.25	19.20
		1	99	20.50	19.53	19.55	19.52
		50	0	20.50	19.28	19.11	19.10
		50	25	20.50	19.18	19.06	19.03
		50	50	20.50	19.17	19.24	19.18
		100	0	20.50	19.22	19.17	19.06
	64QAM	1	0	20.50	19.57	19.49	19.33
		1	50	20.50	19.47	19.23	19.14
		1	99	20.50	19.55	19.45	19.42
		50	0	20.50	19.28	19.21	19.10
		50	25	20.50	19.17	19.19	19.03
		50	50	20.50	19.23	19.24	19.19
		100	0	20.50	19.28	19.27	19.14

Table 108: Conducted power measurement results of LTE Band 66 (Reduced Power Level D7)

Bandwidth	Modulation	RB size	RB offset	Tune-up	Channel	Channel	Channel	
				Max.	131979CH	132322CH	132665CH	
1.4MHz	QPSK	1	0	23.50	22.27	22.09	22.05	
		1	3	23.50	22.26	22.07	22.15	
		1	5	23.50	22.22	22.09	22.09	
		3	0	23.50	22.61	22.44	22.28	
		3	2	23.50	22.32	22.08	22.17	
		3	3	23.50	22.56	22.42	22.53	
	16QAM	6	0	23.00	21.90	21.71	21.84	
		1	0	23.00	21.79	22.10	22.09	
		1	3	23.00	21.66	21.79	22.03	
		1	5	23.00	21.75	22.09	22.00	
		3	0	23.00	22.15	21.93	21.90	
		3	2	23.00	21.93	21.67	22.04	
	64QAM	3	3	23.00	22.05	21.79	22.03	
		6	0	22.00	20.92	20.73	20.86	
		1	0	22.00	20.63	20.98	20.89	
		1	3	22.00	20.83	21.00	21.13	
		1	5	22.00	20.71	20.79	21.22	
		3	0	22.00	21.04	20.95	20.98	
	3MHz	QPSK	3	2	22.00	21.03	20.91	21.00
			3	3	22.00	21.01	20.89	21.11
			6	0	21.00	19.97	19.85	19.89
1			0	23.50	22.18	22.17	22.30	
1			7	23.50	22.37	22.25	22.47	
1			14	23.50	22.26	22.42	22.48	
16QAM		8	0	23.00	21.96	21.72	21.79	
		8	4	23.00	21.94	21.79	21.99	
		8	7	23.00	21.77	21.90	21.95	
		15	0	23.00	21.69	21.72	21.85	
		1	0	23.00	21.87	21.92	21.96	
		1	7	23.00	22.17	21.85	22.21	
64QAM		1	14	23.00	22.01	22.19	22.26	
		8	0	22.00	20.93	20.76	20.86	
		8	4	22.00	20.85	20.85	20.90	
		8	7	22.00	20.80	20.73	20.97	
		15	0	22.00	20.67	20.69	20.83	
		1	0	22.00	20.75	21.17	21.03	
64QAM		1	7	22.00	21.17	20.84	21.15	
		1	14	22.00	21.01	21.19	21.21	
		8	0	21.00	19.81	19.96	19.76	
	8	4	21.00	19.97	19.85	19.89		
	8	7	21.00	19.80	19.93	19.87		
	15	0	21.00	19.69	19.71	19.85		

Bandwidth	Modulation	RB size	RB offset	Tune-up	Channel	Channel	Channel
				Max.	131997CH	132322CH	132647CH
5MHz	QPSK	1	0	23.50	22.30	22.43	22.25
		1	13	23.50	22.27	22.27	22.12
		1	24	23.50	22.33	22.52	22.19
		12	0	23.00	21.95	21.72	22.05
		12	6	23.00	21.95	21.76	21.80
		12	13	23.00	21.75	21.84	21.90
		25	0	23.00	21.79	21.69	21.85
	16QAM	1	0	23.00	22.02	21.90	22.08
		1	13	23.00	21.97	21.83	21.90
		1	24	23.00	21.82	21.99	22.04
		12	0	22.00	20.89	20.75	21.01
		12	6	22.00	20.83	20.69	20.77
		12	13	22.00	20.75	20.65	20.87
		25	0	22.00	20.74	20.64	20.72
	64QAM	1	0	22.00	20.92	20.96	21.05
		1	13	22.00	21.06	21.01	20.93
		1	24	22.00	20.94	21.08	21.01
		12	0	21.00	19.74	19.91	19.68
		12	6	21.00	19.84	19.88	19.78
		12	13	21.00	19.76	19.91	19.87
		25	0	21.00	19.79	19.70	19.86
Bandwidth	Modulation	RB size	RB offset	Tune-up	Channel	Channel	Channel
10MHz	QPSK	1	0	23.50	22.38	22.51	22.33
		1	25	23.50	22.35	22.35	22.21
		1	49	23.50	22.42	22.60	22.27
		25	0	23.00	21.98	21.79	22.03
		25	13	23.00	21.95	21.80	22.04
		25	25	23.00	21.86	21.82	21.88
		50	0	23.00	21.77	21.70	21.98
	16QAM	1	0	23.00	21.91	21.74	21.73
		1	25	23.00	21.87	21.80	21.81
		1	49	23.00	22.04	21.94	21.87
		25	0	22.00	20.96	20.79	21.00
		25	13	22.00	20.92	20.82	21.05
		25	25	22.00	20.73	20.85	20.87
		50	0	22.00	20.70	20.68	20.95
	64QAM	1	0	22.00	20.91	20.75	20.90
		1	25	22.00	20.87	20.79	20.90
		1	49	22.00	21.03	20.94	20.99
		25	0	21.00	19.90	19.81	20.00
		25	13	21.00	19.83	19.83	20.06
		25	25	21.00	19.74	19.85	19.87
		50	0	21.00	19.78	19.72	19.89

Bandwidth	Modulation	RB size	RB offset	Tune-up	Channel	Channel	Channel
				Max.	132047CH	132322CH	132597CH
15MHz	QPSK	1	0	23.50	22.21	22.10	22.29
		1	38	23.50	22.22	21.90	22.11
		1	74	23.50	22.11	22.04	22.02
		36	0	23.00	22.02	21.67	22.10
		36	18	23.00	21.98	21.72	22.01
		36	39	23.00	21.90	21.68	22.00
		75	0	23.00	21.84	21.72	21.80
	16QAM	1	0	23.00	21.90	21.61	21.93
		1	38	23.00	22.04	21.65	22.06
		1	74	23.00	21.94	21.77	21.98
		36	0	22.00	20.96	20.63	21.13
		36	18	22.00	20.92	20.71	21.00
		36	39	22.00	20.76	20.68	20.98
		75	0	22.00	20.76	20.64	21.05
	64QAM	1	0	22.00	21.03	20.84	20.94
		1	38	22.00	20.93	20.94	21.07
		1	74	22.00	20.88	20.61	21.00
		36	0	21.00	19.87	19.65	20.10
		36	18	21.00	19.81	19.72	19.99
		36	39	21.00	19.76	19.68	19.97
		75	0	21.00	19.80	19.73	19.79
Bandwidth	Modulation	RB size	RB offset	Tune-up	Channel	Channel	Channel
20MHz	QPSK	1	0	23.50	22.23	22.28	22.21
		1	50	23.50	22.17	21.90	22.11
		1	99	23.50	22.47	22.20	22.33
		50	0	23.00	21.87	21.62	21.76
		50	25	23.00	21.76	21.65	21.47
		50	50	23.00	21.59	21.67	21.71
		100	0	23.00	21.67	21.65	21.63
	16QAM	1	0	23.00	21.69	21.81	21.72
		1	50	23.00	21.52	21.47	21.59
		1	99	23.00	21.93	21.94	21.80
		50	0	22.00	20.68	20.66	20.64
		50	25	22.00	20.59	20.62	20.54
		50	50	22.00	20.56	20.57	20.68
		100	0	22.00	20.60	20.56	20.61
	64QAM	1	0	22.00	20.68	20.85	20.71
		1	50	22.00	20.52	20.61	20.57
		1	99	22.00	20.70	20.82	20.78
		50	0	21.00	19.71	19.62	19.66
		50	25	21.00	19.61	19.58	19.55
		50	50	21.00	19.57	19.57	19.69
		100	0	21.00	19.68	19.66	19.64
Bandwidth	Modulation	RB size	RB offset	Tune-up	Channel	Channel	Channel
20MHz	QPSK	1	0	23.50	22.23	22.28	22.21
		1	50	23.50	22.17	21.90	22.11
		1	99	23.50	22.47	22.20	22.33
		50	0	23.00	21.87	21.62	21.76
		50	25	23.00	21.76	21.65	21.47
		50	50	23.00	21.59	21.67	21.71
		100	0	23.00	21.67	21.65	21.63
	16QAM	1	0	23.00	21.69	21.81	21.72
		1	50	23.00	21.52	21.47	21.59
		1	99	23.00	21.93	21.94	21.80
		50	0	22.00	20.68	20.66	20.64
		50	25	22.00	20.59	20.62	20.54
		50	50	22.00	20.56	20.57	20.68
		100	0	22.00	20.60	20.56	20.61
	64QAM	1	0	22.00	20.68	20.85	20.71
		1	50	22.00	20.52	20.61	20.57
		1	99	22.00	20.70	20.82	20.78
		50	0	21.00	19.71	19.62	19.66
		50	25	21.00	19.61	19.58	19.55
		50	50	21.00	19.57	19.57	19.69
		100	0	21.00	19.68	19.66	19.64

Table 109: Conducted power measurement results of LTE Band 66 (Reduced Power Level D1/D9)

Bandwidth	Modulation	RB size	RB offset	Tune-up	Channel	Channel	Channel	
				Max.	131979CH	132322CH	132665CH	
1.4MHz	QPSK	1	0	22.50	21.21	21.20	21.22	
		1	3	22.50	21.30	21.21	21.13	
		1	5	22.50	21.61	21.56	21.32	
		3	0	22.50	21.32	21.08	21.17	
		3	2	22.50	21.56	21.42	21.49	
		3	3	22.50	21.36	21.12	21.23	
	16QAM	6	0	22.50	21.27	21.09	21.05	
		1	0	22.50	21.26	21.07	21.15	
		1	3	22.50	21.22	21.09	21.09	
		1	5	22.50	21.61	21.44	21.28	
		3	0	22.50	21.32	21.08	21.17	
		3	2	22.50	21.56	21.42	21.53	
	64QAM	3	3	22.50	21.31	21.12	20.99	
		6	0	22.00	20.67	20.78	20.81	
		1	0	22.00	20.86	20.96	20.59	
		1	3	22.00	20.87	20.60	20.62	
		1	5	22.00	20.83	20.74	20.84	
		3	0	22.00	20.74	20.63	20.71	
	3MHz	QPSK	3	2	22.00	20.85	20.84	20.73
			3	3	22.00	20.82	20.70	20.86
			6	0	21.00	19.69	19.69	19.83
1			0	22.50	21.21	21.20	21.22	
1			7	22.50	21.30	21.21	21.13	
1			14	22.50	21.61	21.56	21.32	
16QAM		8	0	22.50	21.32	21.08	21.17	
		8	4	22.50	21.56	21.42	21.49	
		8	7	22.50	21.36	21.12	20.97	
		15	0	22.50	21.27	21.09	21.05	
		1	0	22.50	21.26	21.07	21.15	
		1	7	22.50	21.22	21.09	21.09	
64QAM		1	14	22.50	21.61	21.44	21.28	
		8	0	22.00	20.98	20.68	21.14	
		8	4	22.00	20.87	20.76	21.18	
		8	7	22.00	20.71	20.79	21.14	
		15	0	22.00	20.83	20.63	20.90	
		1	0	22.00	21.04	21.07	21.08	
QPSK		1	7	22.00	21.07	20.98	21.14	
		1	14	22.00	21.24	21.03	20.81	
		8	0	21.00	19.90	19.92	20.01	
	8	4	21.00	19.87	19.78	20.19		
	8	7	21.00	19.82	19.80	20.14		
	15	0	21.00	19.85	19.64	19.92		

Bandwidth	Modulation	RB size	RB offset	Tune-up	Channel	Channel	Channel
				Max.	131997CH	132322CH	132647CH
5MHz	QPSK	1	0	22.50	21.29	21.36	21.30
		1	13	22.50	21.34	21.29	21.18
		1	24	22.50	21.79	21.61	21.45
		12	0	22.50	21.59	21.35	21.26
		12	6	22.50	21.77	21.77	21.64
		12	13	22.50	21.40	21.33	21.22
		25	0	22.50	21.29	21.31	21.15
	16QAM	1	0	22.50	21.35	21.36	21.31
		1	13	22.50	21.40	21.39	21.26
		1	24	22.50	21.40	21.42	21.33
		12	0	22.00	20.95	20.65	21.03
		12	6	22.00	20.90	20.59	20.81
		12	13	22.00	20.83	20.81	20.88
		25	0	22.00	20.77	20.60	20.78
	64QAM	1	0	22.00	20.99	20.90	21.05
		1	13	22.00	20.89	20.77	20.82
		1	24	22.00	21.09	21.00	20.93
		12	0	21.00	19.98	19.67	20.09
		12	6	21.00	19.91	19.60	19.83
		12	13	21.00	19.83	19.81	19.91
		25	0	21.00	19.81	19.59	19.88
Bandwidth	Modulation	RB size	RB offset	Tune-up	Channel	Channel	Channel
10MHz	QPSK	1	0	22.50	21.28	21.41	21.23
		1	25	22.50	21.25	21.25	21.11
		1	49	22.50	21.32	21.50	21.17
		25	0	22.50	21.51	21.32	21.48
		25	13	22.50	21.49	21.31	21.38
		25	25	22.50	21.46	21.38	21.46
		50	0	22.50	21.40	21.42	21.33
	16QAM	1	0	22.50	21.72	21.15	21.54
		1	25	22.50	21.64	21.30	21.50
		1	49	22.50	21.57	21.13	21.31
		25	0	22.00	20.89	20.70	21.04
		25	13	22.00	20.89	20.72	21.09
		25	25	22.00	20.81	20.66	21.04
		50	0	22.00	20.82	20.53	20.73
	64QAM	1	0	22.00	20.89	20.67	21.06
		1	25	22.00	20.81	20.78	20.81
		1	49	22.00	21.01	20.85	20.93
		25	0	21.00	19.90	19.73	20.12
		25	13	21.00	19.90	19.73	20.12
		25	25	21.00	19.81	19.66	20.04
		50	0	21.00	19.89	19.61	19.78

Bandwidth	Modulation	RB size	RB offset	Tune-up	Channel	Channel	Channel
				Max.	132047CH	132322CH	132597CH
15MHz	QPSK	1	0	22.50	21.28	21.11	21.10
		1	38	22.50	21.18	21.06	21.03
		1	74	22.50	21.17	21.24	21.18
		36	0	22.50	21.22	21.17	21.06
		36	18	22.50	21.67	21.49	21.33
		36	39	22.50	21.47	21.23	21.14
		75	0	22.50	21.65	21.65	21.52
	16QAM	1	0	22.50	21.28	21.21	21.10
		1	38	22.50	21.17	21.19	21.03
		1	74	22.50	21.23	21.24	21.19
		36	0	22.00	20.81	20.63	21.14
		36	18	22.00	20.78	20.70	21.05
		36	39	22.00	20.71	20.69	21.01
		75	0	22.00	20.87	20.64	20.75
	64QAM	1	0	22.00	21.02	20.72	20.98
		1	38	22.00	21.06	20.62	21.07
		1	74	22.00	20.92	20.75	21.01
		36	0	21.00	19.82	19.65	20.14
		36	18	21.00	19.78	19.71	20.04
		36	39	21.00	19.87	19.70	20.00
		75	0	21.00	19.92	19.71	19.81
Bandwidth	Modulation	RB size	RB offset	Tune-up	Channel	Channel	Channel
20MHz	QPSK	1	0	22.50	21.30	21.34	21.21
		1	50	22.50	21.16	21.25	21.04
		1	99	22.50	21.28	21.17	21.33
		50	0	22.50	21.36	20.98	21.32
		50	25	22.50	21.26	20.93	21.21
		50	50	22.50	21.18	21.07	21.07
		100	0	22.50	21.29	21.12	21.13
	16QAM	1	0	22.50	21.19	21.34	21.21
		1	50	22.50	21.19	21.19	20.95
		1	99	22.50	21.45	21.35	21.29
		50	0	22.00	20.70	20.57	20.49
		50	25	22.00	20.60	20.50	20.42
		50	50	22.00	20.57	20.42	20.68
		100	0	22.00	20.61	20.49	20.60
	64QAM	1	0	22.00	20.59	20.96	20.63
		1	50	22.00	20.58	20.58	20.35
		1	99	22.00	20.85	20.69	20.65
		50	0	21.00	20.12	19.98	20.04
		50	25	21.00	20.01	19.93	19.93
		50	50	21.00	19.97	19.82	20.08
		100	0	21.00	20.10	19.93	19.94

Table 110: Conducted power measurement results of LTE Band 66 (Reduced Power Level D2/D3)

7.1.31 Conducted power measurements of Downlink LTE CA

The following conducted power measurement results of downlink LTE carrier aggregation are provided to quantify downlink only carrier aggregation SAR test exclusion per KDB 941225 D05A.

Uplink maximum output power is measured with downlink carrier aggregation active, using the channel with highest measured maximum output power when downlink carrier aggregation is inactive, to confirm that when downlink carrier aggregation is active uplink maximum output power remains within the specified tune-up tolerance limits and not more than ¼dB higher than the maximum output power measured when downlink carrier aggregation inactive.

Power test equipment: R&S Radio Communication Tester CMW500 and/or Anritsu Radio Communication Analyzer MT8821C were used.

The power measurements result are in the table as below:

DL LTE CA Class	PCC				SCC1			SCC2			SCC3			SCC4			Power					
	PCC Band	PCC Bandwidth (MHz)	Modulation	PCC UL RB size	PCC UL RB offset	PCC UL Channel	PCC DL Channel	SCC Band	SCC Bandwidth (MHz)	SCC DL Channel	SCC Band	SCC Bandwidth (MHz)	SCC DL Channel	SCC Band	SCC Bandwidth (MHz)	SCC DL Channel	SCC Band	SCC Bandwidth (MHz)	SCC DL Channel	Ref # LTE Tx Power (dBm)	DL LTE CA Tx Power (dBm)	Tune-up
CA_2C	2	20	QPSK	1	0	18700	700	2	20	898	/	/	/	/	/	/	/	/	/	22.33	21.92	23.00
CA_5B	5	10	QPSK	1	49	20450	2450	5	10	2549	/	/	/	/	/	/	/	/	/	23.81	23.60	24.50
CA_38C	38	20	QPSK	1	0	37850	37850	38	20	38048	/	/	/	/	/	/	/	/	/	22.96	22.30	23.50
CA_41C	41	20	QPSK	1	0	40473	40473	41	20	40671	/	/	/	/	/	/	/	/	/	22.78	21.99	23.50
CA_66B	66	10	QPSK	1	49	132022	66486	66	10	66585	/	/	/	/	/	/	/	/	/	21.92	21.26	23.00
CA_2A-17A	2	20	QPSK	1	0	18700	700	17	10	5790	/	/	/	/	/	/	/	/	/	22.33	21.95	23.00
CA_2A-17A	17	10	QPSK	1	25	23780	5780	2	20	900	/	/	/	/	/	/	/	/	/	23.92	23.78	25.00
CA_4A-17A	4	20	QPSK	1	99	20175	2175	17	10	5790	/	/	/	/	/	/	/	/	/	22.91	22.67	23.00
CA_41D	41	20	QPSK	1	0	40473	40473	41	20	40671	41	20	40869	/	/	/	/	/	/	22.78	22.31	23.50
CA_66D	66	20	QPSK	1	99	132072	66536	66	20	66734	66	20	66932	/	/	/	/	/	/	21.93	21.45	23.00
CA_2A-4A-4A	2	20	QPSK	1	0	18700	700	4	20	2050	4	20	2300	/	/	/	/	/	/	22.33	21.90	23.00
CA_2A-4A-4A	4	20	QPSK	1	99	20175	2175	4	10	2350	2	20	900	/	/	/	/	/	/	22.91	22.77	23.00
CA_2A-4A-4A	4	20	QPSK	1	99	20175	2175	4	10	2350	5	10	2525	/	/	/	/	/	/	22.91	22.64	23.00
CA_4A-4A-5A	5	10	QPSK	1	49	20450	2450	4	20	2050	4	20	2300	/	/	/	/	/	/	23.81	23.49	24.50
CA_4A-4A-7A	4	20	QPSK	1	99	20175	2175	4	10	2350	7	20	3100	/	/	/	/	/	/	22.91	22.51	23.00
CA_4A-4A-7A	7	20	16QAM	1	99	20850	2850	4	20	2050	4	20	2300	/	/	/	/	/	/	20.12	19.88	20.50
CA_4A-4A-12A	4	20	QPSK	1	99	20175	2175	4	10	2350	12	10	5095	/	/	/	/	/	/	22.91	22.74	23.00
CA_4A-12B	4	20	QPSK	1	99	20175	2175	12	5	5095	12	5	5143	/	/	/	/	/	/	22.91	22.67	23.00
CA_5A-7C	5	10	QPSK	1	49	20450	2450	7	20	3100	7	20	3298	/	/	/	/	/	/	23.81	23.54	24.50
CA_5A-7C	7	20	16QAM	1	99	20850	2850	7	20	3048	5	10	2525	/	/	/	/	/	/	20.12	19.64	20.50
CA_5A-7A-7A	5	10	QPSK	1	49	20450	2450	7	20	2850	7	20	3350	/	/	/	/	/	/	23.81	23.58	24.50
CA_5A-7A-7A	7	20	16QAM	1	99	20850	2850	7	20	3350	5	10	2525	/	/	/	/	/	/	20.12	19.83	20.50
CA_12A-66A-66A	66	20	QPSK	1	99	132072	66536	66	20	67036	12	10	2095	/	/	/	/	/	/	21.93	21.70	23.00
CA_2A-4A-5A	2	20	QPSK	1	0	18700	700	4	20	2175	5	10	2525	/	/	/	/	/	/	22.33	21.90	23.00
CA_2A-4A-5A	4	20	QPSK	1	99	20175	2175	2	20	900	5	10	2525	/	/	/	/	/	/	22.91	22.76	23.00
CA_2A-4A-5A	5	10	QPSK	1	49	20450	2450	2	20	900	4	20	2175	/	/	/	/	/	/	23.81	23.54	24.50
CA_7A-7A-66A-66A	7	20	16QAM	1	99	20850	2850	7	20	3350	66	20	66536	66	20	67036	/	/	/	20.12	19.87	20.50
CA_7A-7A-66A-66A	66	20	QPSK	1	99	132072	66536	66	20	67036	7	20	2850	7	20	3350	/	/	/	21.93	21.35	23.00
CA_7C-66A-66A	7	20	16QAM	1	99	20850	2850	7	20	3048	66	20	66536	66	20	67036	/	/	/	20.12	19.82	20.50
CA_7C-66A-66A	66	20	QPSK	1	99	132072	66536	66	20	67036	7	20	3100	7	20	3298	/	/	/	21.93	21.71	23.00
CA_2A-4A-7A-7A	2	20	QPSK	1	0	18700	700	4	20	2175	7	20	2850	7	20	3350	/	/	/	22.33	22.05	23.00
CA_2A-4A-7A-7A	4	20	QPSK	1	99	20175	2175	2	20	900	7	20	2850	7	20	3350	/	/	/	22.91	22.67	23.00
CA_2A-4A-7C	7	20	16QAM	1	99	20850	2850	7	20	3350	2	20	900	4	20	2300	/	/	/	20.12	19.80	20.50
CA_2A-4A-7C	2	20	QPSK	1	0	18700	700	4	20	2175	7	20	3100	7	20	3298	/	/	/	22.33	21.98	23.00
CA_2A-4A-7C	4	20	QPSK	1	99	20175	2175	2	20	900	7	20	3100	7	20	3298	/	/	/	22.91	22.49	23.00
CA_2A-4A-7C	7	20	16QAM	1	99	20850	2850	7	20	3048	2	20	900	4	20	2175	/	/	/	20.12	19.81	20.50
CA_2A-4A-12A-12A	2	20	QPSK	1	0	18700	700	4	20	2175	12	5	5035	12	5	5155	/	/	/	22.33	21.57	23.00
CA_2A-4A-12A-12A	4	20	QPSK	1	99	20175	2175	2	20	900	12	5	5035	12	5	5155	/	/	/	22.91	22.64	23.00
CA_2A-2A-5A-66A	2	20	QPSK	1	0	18700	700	2	20	1100	5	10	2525	66	20	66786	/	/	/	22.33	21.98	23.00
CA_2A-2A-5A-66A	5	10	QPSK	1	49	20450	2450	2	20	700	2	20	1100	66	20	66786	/	/	/	23.81	23.49	24.50
CA_2A-2A-5A-66A	66	20	QPSK	1	99	132072	66536	2	20	700	2	20	1100	5	10	2525	/	/	/	21.93	21.76	23.00
CA_2A-7A-7A-66A	2	20	QPSK	1	0	18700	700	7	20	2850	7	20	3350	66	20	66786	/	/	/	22.33	21.83	23.00
CA_2A-7A-7A-66A	7	20	16QAM	1	99	20850	2850	7	20	3350	2	20	900	66	20	66786	/	/	/	20.12	19.88	20.50
CA_2A-7A-7A-66A	66	20	QPSK	1	99	132072	66536	2	20	900	7	20	2850	7	20	3350	/	/	/	21.93	21.47	23.00
CA_2A-7A-66A-66A	2	20	QPSK	1	0	18700	700	7	20	3100	66	20	66536	66	20	67036	/	/	/	22.33	21.84	23.00
CA_2A-7A-66A-66A	7	20	16QAM	1	99	20850	2850	2	20	900	66	20	66536	66	20	67036	/	/	/	20.12	19.70	20.50
CA_2A-7A-66A-66A	66	20	QPSK	1	99	132072	66536	66	20	67036	2	20	900	7	20	3100	/	/	/	21.93	21.61	23.00
CA_2A-4A-7A-12A	2	20	QPSK	1	0	18700	700	4	20	2175	7	20	3100	12	10	5095	/	/	/	22.33	21.99	23.00
CA_2A-4A-7A-12A	4	20	QPSK	1	99	20175	2175	2	20	900	7	20	3100	12	10	5095	/	/	/	22.91	22.62	23.00
CA_2A-4A-7A-12A	7	20	16QAM	1	99	20850	2850	2	20	900	4	20	2175	12	10	5095	/	/	/	20.12	19.77	20.50
CA_2A-2A-5A-66C	2	20	QPSK	1	0	18700	700	2	20	1100	5	10	2525	66	20	66786	66	20	66984	22.33	21.48	23.00
CA_2A-2A-5A-66C	5	10	QPSK	1	49	20450	2450	2	20	700	2	20	1100	66	20	66786	66	20	66984	23.81	23.47	24.50
CA_2A-2A-5A-66C	66	20	QPSK	1	99	132072	66536	66	20	66734	2	20	700	2	20	1100	5	10	2525	21.93	21.54	23.00
CA_2A-2A-7A-12A-66A	2	20	QPSK	1	0	18700	700	2	20	1100	7	20	3100	12	10	5095	66	20	66786	22.33	22.06	23.00
CA_2A-2A-7A-12A-66A	7	20	16QAM	1	99	20850	2850	2	20	700	2	20	1100	12	10	5095	66	20	66786	20.12	19.51	20.50
CA_2A-2A-7A-12A-66A	66	20	QPSK	1	99	132072	66536	2	20	700	2	20	1100	7	20	3100	12	10	5095	21.93	21.47	23.00
CA_2A-7A-12B-66A	2	20	QPSK	1	0	18700	700	7	20	3100	12	5	5095	12	5	5143	66	20	66786	22.33	21.83	23.00
CA_2A-7A-12B-66A	7	20	16QAM	1	99	20850	2850	2	20	900	12	5	5095	12	5	5143	66	20	66786	20.12	19.49	20.50
CA_2A-7A-12B-66A	66	20	QPSK	1	99	132072	66536	2	20	900	7	20	3100	12	5	5095	12	5	5143	21.93	21.35	23.00

Table 111: Conducted power measurement results of DL CA(Second Antenna, Full Power)

DL LTE CA Class	PCC						SCC1			SCC2			SCC3			SCC4			Power			
	PCC Band	PCC Bandwidth (MHz)	Modulation	PCC UL RB (RBs)	PCC UL RB (RBs)	PCC UL Channel	PCC DL Channel	SCC Band	SCC Bandwidth (MHz)	SCC DL Channel	SCC Band	SCC Bandwidth (MHz)	SCC DL Channel	SCC Band	SCC Bandwidth (MHz)	SCC DL Channel	SCC Band	SCC Bandwidth (MHz)	SCC DL Channel	Ref. LTE Tx Power (dBm)	DL LTE CA Tx Power (dBm)	Tune-up
CA_2C	2	20	16QAM	1	99	19100	1100	2	20	902	/	/	/	/	/	/	/	/	/	17.37	17.25	18.00
CA_5B	5	10	16QAM	1	25	20450	2450	5	10	2549	/	/	/	/	/	/	/	/	/	18.09	17.94	18.50
CA_38C	38	20	16QAM	1	0	37850	37850	38	20	38048	/	/	/	/	/	/	/	/	/	18.74	18.54	19.00
CA_41C	41	20	QPSK	100	0	40140	40140	41	20	40338	/	/	/	/	/	/	/	/	/	17.98	17.42	18.50
CA_66B	66	10	16QAM	1	49	132322	66786	66	10	66885	/	/	/	/	/	/	/	/	/	17.27	16.74	18.00
CA_2A-17A	2	20	16QAM	1	99	19100	1100	17	10	5790	/	/	/	/	/	/	/	/	/	17.37	17.01	18.00
	17	10	64QAM	1	25	23790	5790	2	20	900	/	/	/	/	/	/	/	/	/	19.65	19.24	20.50
CA_4A-17A	4	20	64QAM	1	0	20300	2300	17	10	5790	/	/	/	/	/	/	/	/	/	16.96	16.43	17.50
CA_41D	41	20	QPSK	100	0	40140	40140	41	20	40338	41	20	40536	/	/	/	/	/	/	17.98	17.42	18.50
CA_66D	66	20	16QAM	1	0	132322	66786	66	20	66984	66	5	67101	/	/	/	/	/	/	17.20	16.98	18.00
CA_2A-4A-4A	2	20	16QAM	1	99	19100	1100	4	20	2050	4	20	2300	/	/	/	/	/	/	17.37	17.06	18.00
	4	20	64QAM	1	0	20300	2300	4	20	2050	2	20	900	/	/	/	/	/	/	16.96	16.51	17.50
CA_4A-4A-5A	4	20	64QAM	1	0	20300	2300	4	20	2050	5	10	2525	/	/	/	/	/	/	16.96	16.67	17.50
	5	10	16QAM	1	25	20450	2450	4	20	2050	4	20	2300	/	/	/	/	/	/	18.09	17.54	18.50
CA_4A-4A-7A	4	20	64QAM	1	0	20300	2300	4	20	2050	7	20	3100	/	/	/	/	/	/	16.96	16.37	17.50
	7	20	16QAM	1	99	21350	3350	4	20	2050	4	10	2350	/	/	/	/	/	/	15.06	14.74	15.50
CA_4A-4A-12A	4	20	64QAM	1	0	20300	2300	4	20	2050	12	10	5095	/	/	/	/	/	/	16.96	16.77	17.50
CA_4A-12B	4	20	64QAM	1	0	20300	2300	12	5	5095	12	5	5143	/	/	/	/	/	/	16.96	16.43	17.50
	5	10	16QAM	1	25	20450	2450	7	20	3100	7	20	3298	/	/	/	/	/	/	18.09	17.60	18.50
CA_5A-7C	7	20	16QAM	1	99	21350	3350	7	20	3152	5	10	2525	/	/	/	/	/	/	15.06	14.71	15.50
	5	10	16QAM	1	25	20450	2450	7	20	2850	7	20	3350	/	/	/	/	/	/	18.09	17.55	18.50
CA_5A-7A-7A	7	20	16QAM	1	99	21350	3350	7	20	2850	5	10	2525	/	/	/	/	/	/	15.06	14.62	15.50
	66	20	16QAM	1	0	132322	66786	66	20	67036	12	10	5095	/	/	/	/	/	/	17.20	16.80	18.00
CA_2A-4A-5A	2	20	16QAM	1	99	19100	1100	4	20	2175	5	10	2525	/	/	/	/	/	/	17.37	16.98	18.00
	4	20	64QAM	1	0	20300	2300	2	20	900	5	10	2525	/	/	/	/	/	/	16.96	16.47	17.50
5	10	16QAM	1	25	20450	2450	2	20	900	4	20	2175	/	/	/	/	/	/	18.09	17.55	18.50	
CA_7A-7A-66A-66A	7	20	16QAM	1	99	21350	3350	7	20	2850	66	20	66536	66	20	67036	/	/	/	15.06	14.49	15.50
	66	20	16QAM	1	0	132322	66786	66	20	67036	7	20	2850	7	20	3350	/	/	/	17.20	16.84	18.00
CA_7C-66A-66A	7	20	16QAM	1	99	21350	3350	7	20	3152	66	20	66536	66	20	67036	/	/	/	15.06	14.35	15.50
	66	20	16QAM	1	0	132322	66786	66	20	67036	7	20	3100	7	20	3298	/	/	/	17.20	16.87	18.00
CA_2A-4A-7A-7A	2	20	16QAM	1	99	19100	1100	4	20	2175	7	20	2850	7	20	3350	/	/	/	17.37	16.98	18.00
	4	20	64QAM	1	0	20300	2300	2	20	900	7	20	2850	7	20	3350	/	/	/	16.96	16.69	17.50
CA_2A-4A-7C	2	20	16QAM	1	99	21350	3350	7	20	2850	2	20	900	4	20	2300	/	/	/	15.06	14.36	15.50
	7	20	16QAM	1	99	19100	1100	4	20	2175	7	20	3100	7	20	3298	/	/	/	17.37	17.05	18.00
CA_2A-4A-7C	4	20	64QAM	1	0	20300	2300	2	20	900	7	20	3100	7	20	3298	/	/	/	16.96	16.39	17.50
	7	20	16QAM	1	99	21350	3350	7	20	3152	2	20	900	4	20	2175	/	/	/	15.06	14.56	15.50
CA_2A-4A-12A-12A	2	20	16QAM	1	99	19100	1100	4	20	2175	12	5	5035	12	5	5155	/	/	/	17.37	17.07	18.00
	4	20	64QAM	1	0	20300	2300	2	20	900	12	5	5035	12	5	5155	/	/	/	16.96	16.54	17.50
CA_2A-2A-5A-66A	2	20	16QAM	1	99	19100	1100	2	20	700	5	10	2525	66	20	66786	/	/	/	17.37	17.13	18.00
	5	10	16QAM	1	25	20450	2450	2	20	700	2	20	1100	66	20	66786	/	/	/	18.09	17.66	18.50
CA_2A-2A-5A-66A	66	20	16QAM	1	0	132322	66786	2	20	700	2	20	1100	5	10	2525	/	/	/	17.20	16.73	18.00
	2	20	16QAM	1	99	19100	1100	7	20	2850	7	20	3350	66	20	66786	/	/	/	17.37	17.01	18.00
CA_2A-7A-7A-66A	7	20	16QAM	1	99	21350	3350	7	20	2850	2	20	900	66	20	66786	/	/	/	15.06	14.68	15.50
	66	20	16QAM	1	0	132322	66786	2	20	900	7	20	2850	7	20	3350	/	/	/	17.20	16.84	18.00
CA_2A-7A-66A-66A	2	20	16QAM	1	99	19100	1100	7	20	3100	66	20	66536	66	20	67036	/	/	/	17.37	16.98	18.00
	7	20	16QAM	1	99	21350	3350	2	20	900	66	20	66536	66	20	67036	/	/	/	15.06	14.37	15.50
66	20	16QAM	1	0	132322	66786	66	20	67036	2	20	900	7	20	3100	/	/	/	17.20	16.93	18.00	
CA_2A-4A-7A-12A	2	20	16QAM	1	99	19100	1100	4	20	2175	7	20	3100	12	10	5095	/	/	/	17.37	17.05	18.00
	4	20	64QAM	1	0	20300	2300	2	20	900	7	20	3100	12	10	5095	/	/	/	16.96	16.42	17.50
7	20	16QAM	1	99	21350	3350	2	20	900	4	20	2175	12	10	5095	/	/	/	15.06	14.42	15.50	
CA_2A-2A-5A-66C	2	20	16QAM	1	99	19100	1100	2	20	700	5	10	2525	66	20	66786	66	20	66984	17.37	17.11	18.00
	5	10	16QAM	1	25	20450	2450	2	20	700	2	20	1100	66	20	66786	66	20	66984	18.09	17.80	18.50
66	20	16QAM	1	0	132322	66786	66	20	66984	2	20	700	2	20	1100	5	10	2525	17.20	16.88	18.00	
CA_2A-2A-7A-12A-66A	2	20	16QAM	1	99	19100	1100	2	20	700	7	20	3100	12	10	5095	66	20	66786	17.37	17.03	18.00
	7	20	16QAM	1	99	21350	3350	2	20	700	2	20	1100	12	10	5095	66	20	66786	15.06	14.71	15.50
66	20	16QAM	1	0	132322	66786	2	20	700	2	20	1100	7	20	3100	12	10	5095	17.20	16.99	18.00	
CA_2A-7A-12B-66A	2	20	16QAM	1	99	19100	1100	7	20	3100	12	5	5095	12	5	5143	66	20	66786	17.37	17.10	18.00
	7	20	16QAM	1	99	21350	3350	2	20	900	12	5	5095	12	5	5143	66	20	66786	15.06	14.74	15.50
66	20	16QAM	1	0	132322	66786	2	20	900	7	20	3100	12	5	5095	12	5	5143	17.20	16.97	18.00	

Table 112: Conducted power measurement results of DL CA(Second Antenna, Reduced Power Level D1)



DL LTE CA Class	PCC								SCC1			SCC2			SCC3			SCC4			Power		
	PCC Band	PCC Bandwidth (MHz)	Modulation	PCC UL RB (1200)	PCC UL RB offset	PCC UL Channel	PCC DL Channel	SCC Band	SCC Bandwidth (MHz)	SCC DL Channel	SCC Band	SCC Bandwidth (MHz)	SCC DL Channel	SCC Band	SCC Bandwidth (MHz)	SCC DL Channel	SCC Band	SCC Bandwidth (MHz)	SCC DL Channel	Ref. LTE Tx Power (dBm)	DL LTE CA Tx Power (dBm)	Tune-up	
CA_2C	2	20	64QAM	1	0	18700	700	2	20	898	/	/	/	/	/	/	/	/	/	14.40	14.16	15.00	
CA_5B	5	10	16QAM	1	25	20450	2450	5	10	2549	/	/	/	/	/	/	/	/	/	18.09	17.90	18.50	
CA_38C	38	20	16QAM	1	50	37850	37850	38	20	38048	/	/	/	/	/	/	/	/	/	17.69	17.37	18.00	
CA_41C	41	20	QPSK	1	50	40473	40473	41	20	40671	/	/	/	/	/	/	/	/	/	15.97	15.45	16.50	
CA_66B	66	10	16QAM	1	49	132322	66786	66	10	66885	/	/	/	/	/	/	/	/	/	13.92	13.75	15.00	
CA_2A-17A	2	20	64QAM	1	0	18700	700	17	10	5790	/	/	/	/	/	/	/	/	/	14.40	14.15	15.00	
	17	10	64QAM	1	25	23790	5790	2	20	900	/	/	/	/	/	/	/	/	/	19.65	19.21	20.50	
CA_4A-17A	4	20	16QAM	1	99	20300	2300	17	10	5790	/	/	/	/	/	/	/	/	/	13.81	13.40	14.50	
CA_41D	41	20	QPSK	1	50	40473	40473	41	20	40671	41	20	40869	/	/	/	/	/	/	15.97	15.75	16.50	
CA_66D	66	20	QPSK	1	99	132072	66536	66	20	66734	66	20	66932	/	/	/	/	/	/	14.02	13.77	15.00	
CA_2A-4A-4A	2	20	64QAM	1	0	18700	700	4	20	2050	4	20	2300	/	/	/	/	/	/	14.40	14.19	15.00	
	4	20	64QAM	1	0	20300	2300	4	20	2050	2	20	900	/	/	/	/	/	/	13.81	13.38	14.50	
CA_4A-4A-5A	4	20	64QAM	1	0	20300	2300	4	20	2050	5	10	2525	/	/	/	/	/	/	13.81	13.40	14.50	
	5	10	16QAM	1	25	20450	2450	4	20	2050	4	20	2300	/	/	/	/	/	/	18.09	17.49	18.50	
CA_4A-4A-7A	4	20	64QAM	1	0	20300	2300	4	20	2050	7	20	3100	/	/	/	/	/	/	13.81	13.52	14.50	
	7	20	16QAM	1	0	21350	3350	4	20	2050	4	20	2300	/	/	/	/	/	/	13.13	12.78	13.50	
CA_4A-4A-12A	4	20	64QAM	1	0	20300	2300	4	20	2050	12	10	5095	/	/	/	/	/	/	13.81	13.50	14.50	
CA_4A-12B	4	20	64QAM	1	0	20300	2300	12	5	5095	12	5	5143	/	/	/	/	/	/	13.81	13.47	14.50	
	5	10	16QAM	1	25	20450	2450	7	20	3100	7	20	3298	/	/	/	/	/	/	18.09	17.51	18.50	
	7	20	16QAM	1	0	21350	3350	7	20	3152	5	10	2525	/	/	/	/	/	/	13.13	12.88	13.50	
CA_5A-7A-7A	5	10	16QAM	1	25	20450	2450	7	20	2850	7	20	3350	/	/	/	/	/	/	18.09	17.64	18.50	
	7	20	16QAM	1	0	21350	3350	7	20	2850	5	10	2525	/	/	/	/	/	/	13.13	12.79	13.50	
CA_12A-66A-66A	66	20	QPSK	1	99	132072	66536	66	20	67036	12	10	5095	/	/	/	/	/	/	14.02	13.60	15.00	
	2	20	64QAM	1	0	18700	700	4	20	2175	5	10	2525	/	/	/	/	/	/	14.40	14.09	15.00	
CA_2A-4A-5A	4	20	64QAM	1	0	20300	2300	2	20	900	5	10	2525	/	/	/	/	/	/	13.81	13.51	14.50	
	5	10	16QAM	1	25	20450	2450	2	20	900	4	20	2175	/	/	/	/	/	/	18.09	17.84	18.50	
CA_7A-7A-66A-66A	7	20	16QAM	1	0	21350	3350	7	20	2850	66	20	66536	66	20	67036	/	/	/	13.13	12.73	13.50	
	66	20	QPSK	1	99	132072	66536	66	20	67036	7	20	2850	7	20	3350	/	/	/	14.02	13.89	15.00	
CA_7C-66A-66A	7	20	16QAM	1	0	21350	3350	7	20	3152	66	20	66536	66	20	67036	/	/	/	13.13	12.75	13.50	
	66	20	QPSK	1	99	132072	66536	66	20	67036	7	20	3100	7	20	3298	/	/	/	14.02	13.80	15.00	
CA_2A-4A-7A-7A	2	20	64QAM	1	0	18700	700	4	20	2175	7	20	2850	7	20	3350	/	/	/	14.40	14.17	15.00	
	4	20	64QAM	1	0	20300	2300	2	20	900	7	20	2850	7	20	3350	/	/	/	13.81	13.42	14.50	
	7	20	16QAM	1	0	21350	3350	7	20	2850	2	20	900	4	20	2300	/	/	/	13.13	12.74	13.50	
CA_2A-4A-7C	2	20	64QAM	1	0	18700	700	4	20	2175	7	20	3100	7	20	3298	/	/	/	14.40	14.09	15.00	
	4	20	64QAM	1	0	20300	2300	2	20	900	7	20	3100	7	20	3298	/	/	/	13.81	13.33	14.50	
	7	20	16QAM	1	0	21350	3350	7	20	3152	2	20	900	4	20	2175	/	/	/	13.13	12.95	13.50	
CA_2A-4A-12A-12A	2	20	64QAM	1	0	18700	700	4	20	2175	12	5	5035	12	5	5155	/	/	/	14.40	14.07	15.00	
	4	20	64QAM	1	0	20300	2300	2	20	900	12	5	5035	12	5	5155	/	/	/	13.81	13.56	14.50	
CA_2A-2A-5A-66A	2	20	64QAM	1	0	18700	700	2	20	1100	5	10	2525	66	20	66786	/	/	/	14.40	14.10	15.00	
	5	10	16QAM	1	25	20450	2450	2	20	700	2	20	1100	66	20	66786	/	/	/	18.09	17.64	18.50	
	66	20	QPSK	1	99	132072	66536	2	20	700	2	20	1100	5	10	2525	/	/	/	14.02	13.53	15.00	
CA_2A-7A-7A-66A	2	20	64QAM	1	0	18700	700	7	20	2850	7	20	3350	66	20	66786	/	/	/	14.40	14.07	15.00	
	7	20	16QAM	1	0	21350	3350	7	20	2850	2	20	900	66	20	66786	/	/	/	13.13	12.88	13.50	
	66	20	QPSK	1	99	132072	66536	2	20	900	7	20	2850	7	20	3350	/	/	/	14.02	13.77	15.00	
CA_2A-7A-66A-66A	2	20	64QAM	1	0	18700	700	7	20	3100	66	20	66536	66	20	67036	/	/	/	14.40	14.12	15.00	
	7	20	16QAM	1	0	21350	3350	2	20	900	66	20	66536	66	20	67036	/	/	/	13.13	12.87	13.50	
	66	20	QPSK	1	99	132072	66536	66	20	67036	2	20	900	7	20	3100	/	/	/	14.02	13.68	15.00	
CA_2A-4A-7A-12A	2	20	64QAM	1	0	18700	700	4	20	2175	7	20	3100	12	10	5095	/	/	/	14.40	14.23	15.00	
	4	20	64QAM	1	0	20300	2300	2	20	900	7	20	3100	12	10	5095	/	/	/	13.81	13.50	14.50	
	7	20	16QAM	1	0	21350	3350	2	20	900	4	20	2175	12	10	5095	/	/	/	13.13	12.78	13.50	
CA_2A-2A-5A-66C	2	20	64QAM	1	0	18700	700	2	20	1100	5	10	2525	66	20	66786	66	20	66984	14.40	14.09	15.00	
	5	10	16QAM	1	25	20450	2450	2	20	700	2	20	1100	66	20	66786	66	20	66984	18.09	17.85	18.50	
	66	20	QPSK	1	99	132072	66536	66	20	66984	2	20	700	2	20	1100	5	10	2525	14.02	13.47	15.00	
CA_2A-2A-7A-12A-66A	2	20	64QAM	1	0	18700	700	2	20	1100	7	20	3100	12	10	5095	66	20	66786	14.40	14.13	15.00	
	7	20	16QAM	1	0	21350	3350	2	20	700	2	20	1100	12	10	5095	66	20	66786	13.13	12.88	13.50	
	66	20	QPSK	1	99	132072	66536	2	20	700	2	20	1100	7	20	3100	12	10	5095	14.02	13.74	15.00	
CA_2A-7A-12B-66A	2	20	64QAM	1	0	18700	700	7	20	3100	12	5	5095	12	5	5143	66	20	66786	14.40	14.09	15.00	
	7	20	16QAM	1	0	21350	3350	2	20	900	12	5	5095	12	5	5143	66	20	66786	13.13	12.86	13.50	
	66	20	QPSK	1	99	132072	66536	2	20	900	7	20	3100	12	5	5095	12	5	5143	14.02	13.78	15.00	

Table 113: Conducted power measurement results of DL CA (Second Antenna, Reduced Power Level D3)

DL LTE CA Class	PCC							SCC1			SCC2			SCC3			SCC4			Power		
	PCC Band	PCC Bandwidth (MHz)	Modulation	PCC UL RB #Start	PCC UL RB #End	PCC UL Channel	PCC DL Channel	SCC Band	SCC Bandwidth (MHz)	SCC DL Channel	SCC Band	SCC Bandwidth (MHz)	SCC DL Channel	SCC Band	SCC Bandwidth (MHz)	SCC DL Channel	SCC Band	SCC Bandwidth (MHz)	SCC DL Channel	Ref. LTE Tx Power (dBm)	DL LTE CA Tx Power (dBm)	Tune-up
CA_2C	2	20	16QAM	1	50	19100	1100	2	20	902	/	/	/	/	/	/	/	/	/	19.27	18.98	20.00
CA_5B	5	10	QPSK	1	49	20450	2450	5	10	2549	/	/	/	/	/	/	/	/	/	23.81	23.48	24.50
CA_38C	38	20	16QAM	1	99	37850	37850	38	20	38048	/	/	/	/	/	/	/	/	/	22.19	22.04	22.50
CA_41C	41	20	16QAM	1	99	40473	40473	41	20	40671	/	/	/	/	/	/	/	/	/	21.15	20.70	21.50
CA_66B	66	10	QPSK	25	0	132622	67086	66	10	66987	/	/	/	/	/	/	/	/	/	18.86	16.51	20.00
CA_2A-17A	2	20	16QAM	1	50	19100	1100	17	10	5790	/	/	/	/	/	/	/	/	/	19.27	18.89	20.00
	17	10	QPSK	1	25	23780	5780	2	20	900	/	/	/	/	/	/	/	/	/	23.92	23.54	25.00
CA_4A-17A	4	20	QPSK	1	99	20300	2300	17	10	5790	/	/	/	/	/	/	/	/	/	20.20	19.97	21.00
CA_41D	41	20	16QAM	1	99	40473	40473	41	20	40671	41	20	40869	/	/	/	/	/	/	21.15	20.84	21.50
CA_66D	66	20	64QAM	1	0	132072	66536	66	20	66734	66	20	66932	/	/	/	/	/	/	18.95	18.63	20.00
CA_2A-4A-4A	2	20	16QAM	1	50	19100	1100	4	20	2050	4	20	2300	/	/	/	/	/	/	19.27	18.84	20.00
	4	20	QPSK	1	99	20300	2300	4	20	2050	2	20	900	/	/	/	/	/	/	20.20	19.77	21.00
CA_4A-4A-5A	4	20	QPSK	1	99	20300	2300	4	20	2050	5	10	2525	/	/	/	/	/	/	20.20	19.90	21.00
	5	10	QPSK	1	49	20450	2450	4	20	2050	4	20	2300	/	/	/	/	/	/	23.81	23.42	24.50
CA_4A-4A-7A	4	20	QPSK	1	99	20300	2300	4	20	2050	7	20	3100	/	/	/	/	/	/	20.20	18.89	21.00
	7	20	16QAM	1	99	21350	3350	4	20	2050	4	10	2350	/	/	/	/	/	/	18.09	17.61	18.50
CA_4A-4A-12A	4	20	QPSK	1	99	20300	2300	4	20	2050	12	10	5095	/	/	/	/	/	/	20.20	19.87	21.00
CA_4A-12B	4	20	QPSK	1	99	20300	2300	12	5	5095	12	5	5143	/	/	/	/	/	/	20.20	19.84	21.00
CA_5A-7C	5	10	QPSK	1	49	20450	2450	7	20	3100	7	20	3298	/	/	/	/	/	/	23.81	23.51	24.50
	7	20	16QAM	1	99	21350	3350	7	20	3152	5	10	2525	/	/	/	/	/	/	18.09	17.69	18.50
	5	10	QPSK	1	49	20450	2450	7	20	2850	7	20	3350	/	/	/	/	/	/	23.81	23.43	24.50
CA_5A-7A-7A	7	20	16QAM	1	99	21350	3350	7	20	2850	5	10	2525	/	/	/	/	/	/	18.09	17.64	18.50
	66	20	64QAM	1	0	132072	66536	66	20	67036	12	10	5095	/	/	/	/	/	/	18.95	18.41	20.00
CA_2A-4A-5A	2	20	16QAM	1	50	19100	1100	4	20	2175	5	10	2525	/	/	/	/	/	/	19.27	18.94	20.00
	4	20	QPSK	1	99	20300	2300	2	20	900	5	10	2525	/	/	/	/	/	/	20.20	19.75	21.00
	5	10	QPSK	1	49	20450	2450	2	20	900	4	20	2175	/	/	/	/	/	/	23.81	23.37	24.50
CA_7A-7A-66A-66A	7	20	16QAM	1	99	21350	3350	7	20	2850	66	20	66536	66	20	67036	/	/	/	18.09	17.68	18.50
	66	20	64QAM	1	0	132072	66536	66	20	67036	7	20	2850	7	20	3350	/	/	/	18.95	18.43	20.00
CA_7C-66A-66A	7	20	16QAM	1	99	21350	3350	7	20	3152	66	20	66536	66	20	67036	/	/	/	18.09	17.43	18.50
	66	20	64QAM	1	0	132072	66536	66	20	67036	7	20	3100	7	20	3298	/	/	/	18.95	18.79	20.00
	2	20	16QAM	1	50	19100	1100	4	20	2175	7	20	2850	7	20	3350	/	/	/	19.27	18.99	20.00
CA_2A-4A-7A-7A	4	20	QPSK	1	99	20300	2300	2	20	900	7	20	2850	7	20	3350	/	/	/	20.20	19.75	21.00
	7	20	16QAM	1	99	21350	3350	7	20	2850	2	20	900	4	20	2300	/	/	/	18.09	17.64	18.50
	2	20	16QAM	1	50	19100	1100	4	20	2175	7	20	3100	7	20	3298	/	/	/	19.27	18.94	20.00
CA_2A-4A-7C	4	20	QPSK	1	99	20300	2300	2	20	900	7	20	3100	7	20	3298	/	/	/	20.20	19.86	21.00
	7	20	16QAM	1	99	21350	3350	7	20	3152	2	20	900	4	20	2175	/	/	/	18.09	17.74	18.50
	2	20	16QAM	1	50	19100	1100	4	20	2175	12	5	5035	12	5	5155	/	/	/	19.27	19.01	20.00
CA_2A-4A-12A-12A	4	20	QPSK	1	99	20300	2300	2	20	900	12	5	5035	12	5	5155	/	/	/	20.20	19.87	21.00
	2	20	16QAM	1	50	19100	1100	2	20	700	5	10	2525	66	20	66786	/	/	/	19.27	18.88	20.00
CA_2A-2A-5A-66A	5	10	QPSK	1	49	20450	2450	2	20	700	2	20	1100	66	20	66786	/	/	/	23.81	23.50	24.50
	66	20	64QAM	1	0	132072	66536	2	20	700	2	20	1100	5	10	2525	/	/	/	18.95	18.67	20.00
	2	20	16QAM	1	50	19100	1100	7	20	2850	7	20	3350	66	20	66786	/	/	/	19.27	18.94	20.00
CA_2A-7A-7A-66A	7	20	16QAM	1	99	21350	3350	7	20	3350	2	20	900	66	20	66786	/	/	/	18.09	17.86	18.50
	66	20	64QAM	1	0	132072	66536	2	20	900	7	20	2850	7	20	3350	/	/	/	18.95	18.57	20.00
	2	20	16QAM	1	50	19100	1100	7	20	3100	66	20	66536	66	20	67036	/	/	/	19.27	18.93	20.00
CA_2A-7A-66A-66A	7	20	16QAM	1	99	21350	3350	2	20	900	66	20	66536	66	20	67036	/	/	/	18.09	17.84	18.50
	66	20	64QAM	1	0	132072	66536	66	20	67036	2	20	900	7	20	3100	/	/	/	18.95	18.61	20.00
	2	20	16QAM	1	50	19100	1100	4	20	2175	7	20	3100	12	10	5095	/	/	/	19.27	18.99	20.00
CA_2A-4A-7A-12A	4	20	QPSK	1	99	20300	2300	2	20	900	7	20	3100	12	10	5095	/	/	/	20.20	19.90	21.00
	7	20	16QAM	1	99	21350	3350	2	20	900	4	20	2175	12	10	5095	/	/	/	18.09	17.47	18.50
	2	20	16QAM	1	50	19100	1100	2	20	700	5	10	2525	66	20	66786	66	20	66984	19.27	18.81	20.00
CA_2A-2A-5A-66C	5	10	QPSK	1	49	20450	2450	2	20	700	2	20	1100	66	20	66786	66	20	66984	23.81	23.49	24.50
	66	20	64QAM	1	0	132072	66536	66	20	66734	2	20	700	2	20	1100	5	10	2525	18.95	18.55	20.00
	2	20	16QAM	1	50	19100	1100	2	20	700	7	20	3100	12	10	5095	66	20	66786	19.27	18.86	20.00
CA_2A-2A-7A-12A-66A	7	20	16QAM	1	99	21350	3350	2	20	700	2	20	1100	12	10	5095	66	20	66786	18.09	17.77	18.50
	66	20	64QAM	1	0	132072	66536	2	20	700	2	20	1100	7	20	3100	12	10	5095	18.95	18.61	20.00
	2	20	16QAM	1	50	19100	1100	7	20	3100	12	5	5095	12	5	5143	66	20	66786	19.27	18.99	20.00
CA_2A-7A-12B-66A	7	20	16QAM	1	99	21350	3350	2	20	900	12	5	5095	12	5	5143	66	20	66786	18.09	17.47	18.50
	66	20	64QAM	1	0	132072	66536	2	20	900	7	20	3100	12	5	5095	12	5	5143	18.95	18.45	20.00

Table 114: Conducted power measurement results of DL CA(Second Antenna, Reduced Power Level D2)

DL LTE CA Class	PCC						SCC1			SCC2			SCC3			SCC4			Power			
	PCC Band	PCC Bandwidth (MHz)	Modulation	PCC UL RB	PCC UL RB offset	PCC UL Channel	PCC DL Channel	SCC Band	SCC Bandwidth (MHz)	SCC DL Channel	SCC Band	SCC Bandwidth (MHz)	SCC DL Channel	SCC Band	SCC Bandwidth (MHz)	SCC DL Channel	SCC Band	SCC Bandwidth (MHz)	SCC DL Channel	Ref. LTE Tx Power (dBm)	DL LTE CA Tx Power (dBm)	Tune-up
CA_2C	2	20	QPSK	1	99	18700	700	2	20	898	/	/	/	/	/	/	/	/	/	23.33	23.10	24.50
CA_5B	5	10	QPSK	1	25	20450	2450	5	10	2549	/	/	/	/	/	/	/	/	/	23.92	23.70	25.00
CA_38C	38	20	QPSK	1	99	38150	38150	38	20	37952	/	/	/	/	/	/	/	/	/	24.45	24.20	25.00
CA_41C	41	20	QPSK	1	0	41140	41140	41	20	40942	/	/	/	/	/	/	/	/	/	24.31	24.21	25.00
CA_66B	66	10	QPSK	1	0	132622	67086	66	10	66987	/	/	/	/	/	/	/	/	/	22.99	22.76	24.00
CA_2A-17A	2	20	QPSK	1	99	18700	700	17	10	5790	/	/	/	/	/	/	/	/	/	23.33	23.20	24.50
	17	10	QPSK	1	49	23790	5790	2	20	900	/	/	/	/	/	/	/	/	/	24.22	23.80	25.00
CA_4A-17A	4	20	QPSK	1	50	20050	2050	17	10	5790	/	/	/	/	/	/	/	/	/	24.10	23.60	25.00
CA_41D	41	20	QPSK	1	0	41140	41140	41	20	40942	41	20	40744	/	/	/	/	/	/	24.31	24.10	25.00
CA_66D	66	20	QPSK	1	99	132572	67036	66	20	66838	66	20	66640	/	/	/	/	/	/	22.98	22.60	24.00
CA_2A-4A-4A	2	20	QPSK	1	99	18700	700	4	20	2050	4	20	2350	/	/	/	/	/	/	23.33	23.11	24.50
	4	20	QPSK	1	50	20050	2050	4	20	2300	2	20	900	/	/	/	/	/	/	24.10	23.87	25.00
CA_4A-4A-5A	4	20	QPSK	1	50	20050	2050	4	20	2300	5	10	2525	/	/	/	/	/	/	24.10	23.94	25.00
	5	10	QPSK	1	25	20450	2450	4	20	2050	4	20	2300	/	/	/	/	/	/	23.92	23.58	25.00
CA_4A-4A-7A	4	20	QPSK	1	50	20050	2050	4	20	2300	7	20	3100	/	/	/	/	/	/	24.10	23.91	25.00
	7	20	QPSK	1	50	21350	3350	4	20	2050	4	20	2300	/	/	/	/	/	/	23.66	23.54	24.50
CA_4A-4A-12A	4	20	QPSK	1	50	20050	2050	4	20	2300	12	10	5095	/	/	/	/	/	/	24.10	24.01	25.00
CA_4A-12B	4	20	QPSK	1	50	20050	2050	12	5	5095	12	5	5143	/	/	/	/	/	/	24.10	23.91	25.00
CA_5A-7C	5	10	QPSK	1	25	20450	2450	7	20	3100	7	20	3298	/	/	/	/	/	/	23.92	23.88	25.00
	7	20	QPSK	1	50	21350	3350	7	20	3152	5	10	2525	/	/	/	/	/	/	23.66	23.25	24.50
CA_5A-7A-7A	5	10	QPSK	1	25	20450	2450	7	20	2850	7	20	3350	/	/	/	/	/	/	23.92	23.45	25.00
	7	20	QPSK	1	50	21350	3350	7	20	2850	5	10	2525	/	/	/	/	/	/	23.66	23.56	24.50
CA_12A-66A-66A	66	20	QPSK	1	99	132572	67036	66	20	66536	12	10	5095	/	/	/	/	/	/	22.98	22.61	24.00
CA_2A-4A-5A	2	20	QPSK	1	99	18700	700	4	20	2175	5	10	2525	/	/	/	/	/	/	23.33	23.00	24.50
	4	20	QPSK	1	50	20050	2050	2	20	900	5	10	2525	/	/	/	/	/	/	24.10	23.74	25.00
5	10	QPSK	1	25	20450	2450	2	20	900	4	20	2175	/	/	/	/	/	/	23.92	23.55	25.00	
CA_7A-7A-66A-66A	7	20	QPSK	1	50	21350	3350	7	20	2850	66	20	66536	66	20	67036	/	/	/	23.66	23.22	24.50
	66	20	QPSK	1	99	132572	67036	66	20	66536	7	20	2850	7	20	3350	/	/	/	22.98	22.84	24.00
CA_7C-66A-66A	7	20	QPSK	1	50	21350	3350	7	20	3152	66	20	66536	66	20	67036	/	/	/	23.66	22.95	24.50
	66	20	QPSK	1	99	132572	67036	66	20	66536	7	20	3100	7	20	3298	/	/	/	22.98	22.89	24.00
CA_2A-4A-7A-7A	2	20	QPSK	1	99	18700	700	4	20	2175	7	20	2850	7	20	3350	/	/	/	23.33	23.13	24.50
	4	20	QPSK	1	50	20050	2050	2	20	900	7	20	2850	7	20	3350	/	/	/	24.10	24.00	25.00
CA_2A-4A-7C	7	20	QPSK	1	50	21350	3350	7	20	2850	2	20	900	4	20	2300	/	/	/	23.66	23.50	24.50
	2	20	QPSK	1	99	18700	700	4	20	2175	7	20	3100	7	20	3298	/	/	/	23.33	23.30	24.50
CA_2A-4A-7C	4	20	QPSK	1	50	20050	2050	2	20	900	7	20	3100	7	20	3298	/	/	/	24.10	23.94	25.00
	7	20	QPSK	1	50	21350	3350	7	20	3152	2	20	900	4	20	2175	/	/	/	23.66	23.45	24.50
CA_2A-4A-12A-12A	2	20	QPSK	1	99	18700	700	4	20	2175	12	5	5035	12	5	5155	/	/	/	23.33	23.14	24.50
	4	20	QPSK	1	50	20050	2050	2	20	900	12	5	5035	12	5	5155	/	/	/	24.10	23.58	25.00
CA_2A-2A-5A-66A	2	20	QPSK	1	99	18700	700	2	20	1100	5	10	2525	66	20	66786	/	/	/	23.33	23.01	24.50
	5	10	QPSK	1	25	20450	2450	2	20	700	2	20	1100	66	20	66786	/	/	/	23.92	23.57	25.00
CA_2A-2A-5A-66A	66	20	QPSK	1	99	132572	67036	2	20	700	2	20	1100	5	10	2525	/	/	/	22.98	22.88	24.00
	2	20	QPSK	1	99	18700	700	7	20	2850	7	20	3350	66	20	66786	/	/	/	23.33	23.23	24.50
CA_2A-7A-7A-66A	7	20	QPSK	1	50	21350	3350	7	20	2850	2	20	900	66	20	66786	/	/	/	23.66	23.54	24.50
	66	20	QPSK	1	99	132572	67036	2	20	900	7	20	2850	7	20	3350	/	/	/	22.98	22.51	24.00
CA_2A-7A-66A-66A	2	20	QPSK	1	99	18700	700	7	20	3100	66	20	66536	66	20	67036	/	/	/	23.33	23.15	24.50
	7	20	QPSK	1	50	21350	3350	2	20	900	66	20	66536	66	20	67036	/	/	/	23.66	23.58	24.50
66	20	QPSK	1	99	132572	67036	66	20	66536	2	20	900	7	20	3100	/	/	/	22.98	22.91	24.00	
CA_2A-4A-7A-12A	2	20	QPSK	1	99	18700	700	4	20	2175	7	20	3100	12	10	5095	/	/	/	23.33	23.14	24.50
	4	20	QPSK	1	50	20050	2050	2	20	900	7	20	3100	12	10	5095	/	/	/	24.10	23.99	25.00
7	20	QPSK	1	50	21350	3350	2	20	900	4	20	2175	12	10	5095	/	/	/	23.66	23.54	24.50	
CA_2A-2A-5A-66C	2	20	QPSK	1	99	18700	700	2	20	1100	5	10	2525	66	20	66786	66	20	66984	23.33	23.25	24.50
	5	10	QPSK	1	25	20450	2450	2	20	700	2	20	1100	66	20	66786	66	20	66984	23.92	23.87	25.00
66	20	QPSK	1	99	132572	67036	66	20	66838	2	20	1100	5	10	2525	22.98	22.88	24.00				
CA_2A-2A-7A-12A-66A	2	20	QPSK	1	99	18700	700	2	20	1100	7	20	3100	12	10	5095	66	20	66786	23.33	23.31	24.50
	7	20	QPSK	1	50	21350	3350	2	20	700	2	20	1100	12	10	5095	66	20	66786	23.66	23.61	24.50
66	20	QPSK	1	99	132572	67036	2	20	700	2	20	1100	7	20	3100	12	10	5095	22.98	22.84	24.00	
CA_2A-7A-12B-66A	2	20	QPSK	1	99	18700	700	7	20	3100	12	5	5095	12	5	5143	66	20	66786	23.33	23.17	24.50
	7	20	QPSK	1	50	21350	3350	2	20	900	12	5	5095	12	5	5143	66	20	66786	23.66	23.58	24.50
66	20	QPSK	1	99	132572	67036	2	20	900	7	20	3100	12	5	5095	12	5	5143	22.98	22.84	24.00	

Table 115: Conducted power measurement results of DL CA(Second Antenna, Full Power)



DL LTE CA Class	PCC						SCC1			SCC2			SCC3			SCC4			Power			
	PCC Band	PCC Bandwidth (MHz)	Modulation	PCC UL RB (RBs)	PCC UL RB (RBs)	PCC UL Channel	PCC DL Channel	SCC Band	SCC Bandwidth (MHz)	SCC DL Channel	SCC Band	SCC Bandwidth (MHz)	SCC DL Channel	SCC Band	SCC Bandwidth (MHz)	SCC DL Channel	SCC Band	SCC Bandwidth (MHz)	SCC DL Channel	Ref LTE Tx Power (dBm)	DL LTE CA Tx Power (dBm)	Tune-up
CA_2C	2	20	16QAM	1	50	18700	700	2	20	898	/	/	/	/	/	/	/	/	/	22.53	22.51	23.50
CA_5B	5	10	QPSK	1	25	20450	2450	5	10	2549	/	/	/	/	/	/	/	/	/	23.92	23.72	25.00
CA_38C	38	20	16QAM	1	50	38150	38150	38	20	37952	/	/	/	/	/	/	/	/	/	22.61	22.54	23.00
CA_41C	41	20	16QAM	1	0	41140	41140	41	20	40942	/	/	/	/	/	/	/	/	/	24.31	24.21	25.00
CA_66B	66	10	16QAM	1	49	132622	67086	66	10	66987	/	/	/	/	/	/	/	/	/	22.04	21.90	23.00
CA_2A-17A	2	20	16QAM	1	50	18700	700	17	10	5790	/	/	/	/	/	/	/	/	/	22.53	22.35	23.50
	17	10	QPSK	1	49	23790	5790	2	20	900	/	/	/	/	/	/	/	/	/	24.22	24.12	25.00
CA_4A-17A	4	20	16QAM	1	99	20300	2300	17	10	5790	/	/	/	/	/	/	/	/	/	22.28	22.18	23.00
CA_41D	41	20	16QAM	1	0	41140	41140	41	20	40942	41	20	40744	/	/	/	/	/	/	24.31	24.20	25.00
CA_66D	66	20	16QAM	1	99	132072	66536	66	20	66734	66	20	66932	/	/	/	/	/	/	22.27	22.21	23.00
CA_2A-4A-4A	2	20	16QAM	1	50	18700	700	4	20	2050	4	20	2300	/	/	/	/	/	/	22.53	22.51	23.50
	4	20	16QAM	1	99	20300	2300	4	20	2050	2	20	900	/	/	/	/	/	/	22.28	22.21	23.00
	4	20	16QAM	1	99	20300	2300	4	20	2050	5	10	2525	/	/	/	/	/	/	22.28	22.18	23.00
CA_4A-4A-5A	4	20	16QAM	1	99	20300	2300	4	20	2050	4	20	2300	/	/	/	/	/	/	23.92	23.84	25.00
	5	10	QPSK	1	25	20450	2450	4	20	2050	4	20	2300	/	/	/	/	/	/	22.28	22.19	23.00
CA_4A-4A-7A	4	20	16QAM	1	99	20300	2300	4	20	2050	7	20	3100	/	/	/	/	/	/	20.58	20.21	21.00
	7	20	16QAM	1	50	21350	3350	4	20	2050	4	10	2350	/	/	/	/	/	/	22.28	22.18	23.00
CA_4A-4A-12A	4	20	16QAM	1	99	20300	2300	4	20	2050	12	10	5095	/	/	/	/	/	/	22.28	22.18	23.00
	4	20	16QAM	1	99	20300	2300	12	5	5095	12	5	5143	/	/	/	/	/	/	22.28	22.14	23.00
CA_5A-7C	5	10	QPSK	1	25	20450	2450	7	20	3100	7	20	3298	/	/	/	/	/	/	23.92	23.85	25.00
	7	20	16QAM	1	50	21350	3350	7	20	3152	5	10	2525	/	/	/	/	/	/	20.58	20.54	21.00
	5	10	QPSK	1	25	20450	2450	7	20	2850	7	20	3350	/	/	/	/	/	/	23.92	23.87	25.00
CA_5A-7A-7A	7	20	16QAM	1	50	21350	3350	7	20	2850	5	10	2525	/	/	/	/	/	/	20.58	20.54	21.00
	66	20	16QAM	1	99	132072	66536	66	20	67036	12	10	5095	/	/	/	/	/	/	22.27	22.07	23.00
CA_12A-66A-66A	2	20	16QAM	1	50	18700	700	4	20	2175	5	10	2525	/	/	/	/	/	/	22.53	22.51	23.50
	4	20	16QAM	1	99	20300	2300	2	20	900	5	10	2525	/	/	/	/	/	/	22.28	22.18	23.00
	5	10	QPSK	1	25	20450	2450	2	20	900	4	20	2175	/	/	/	/	/	/	23.92	23.90	25.00
CA_7A-7A-66A-66A	7	20	16QAM	1	50	21350	3350	7	20	2850	66	20	66536	66	20	67036	/	/	/	20.58	20.54	21.00
	66	20	16QAM	1	99	132072	66536	66	20	67036	7	20	2850	7	20	3350	/	/	/	22.27	22.14	23.00
CA_7C-66A-66A	7	20	16QAM	1	50	21350	3350	7	20	3152	66	20	66536	66	20	67036	/	/	/	20.58	20.41	21.00
	66	20	16QAM	1	99	132072	66536	66	20	67036	7	20	3100	7	20	3298	/	/	/	22.27	22.14	23.00
CA_2A-4A-7A-7A	2	20	16QAM	1	50	18700	700	4	20	2175	7	20	2850	7	20	3350	/	/	/	22.53	22.51	23.50
	4	20	16QAM	1	99	20300	2300	2	20	900	7	20	2850	7	20	3350	/	/	/	22.28	22.24	23.00
	7	20	16QAM	1	50	21350	3350	7	20	2850	2	20	900	4	20	2300	/	/	/	20.58	20.50	21.00
CA_2A-4A-7C	2	20	16QAM	1	50	18700	700	4	20	2175	7	20	3100	7	20	3298	/	/	/	22.53	22.51	23.50
	4	20	16QAM	1	99	20300	2300	2	20	900	7	20	3100	7	20	3298	/	/	/	22.28	22.18	23.00
	7	20	16QAM	1	50	21350	3350	7	20	3152	2	20	900	4	20	2175	/	/	/	20.58	20.50	21.00
CA_2A-4A-12A-12A	2	20	16QAM	1	50	18700	700	4	20	2175	12	5	5035	12	5	5155	/	/	/	22.53	22.50	23.50
	4	20	16QAM	1	99	20300	2300	2	20	900	12	5	5035	12	5	5155	/	/	/	22.28	22.19	23.00
CA_2A-2A-5A-66A	2	20	16QAM	1	50	18700	700	2	20	1100	5	10	2525	66	20	66786	/	/	/	22.53	22.52	23.50
	5	10	QPSK	1	25	20450	2450	2	20	700	2	20	1100	66	20	66786	/	/	/	23.92	23.90	25.00
	66	20	16QAM	1	99	132072	66536	2	20	700	2	20	1100	5	10	2525	/	/	/	22.27	22.21	23.00
CA_2A-7A-7A-66A	2	20	16QAM	1	50	18700	700	7	20	2850	7	20	3350	66	20	66786	/	/	/	22.53	22.50	23.50
	7	20	16QAM	1	50	21350	3350	7	20	2850	2	20	900	66	20	66786	/	/	/	20.58	20.45	21.00
	66	20	16QAM	1	99	132072	66536	2	20	900	7	20	2850	7	20	3350	/	/	/	22.27	22.14	23.00
CA_2A-7A-66A-66A	2	20	16QAM	1	50	18700	700	7	20	3100	66	20	66536	66	20	67036	/	/	/	22.53	22.51	23.50
	7	20	16QAM	1	50	21350	3350	2	20	900	66	20	66536	66	20	67036	/	/	/	20.58	20.48	21.00
	66	20	16QAM	1	99	132072	66536	66	20	67036	2	20	900	7	20	3100	/	/	/	22.27	22.27	23.00
CA_2A-4A-7A-12A	2	20	16QAM	1	50	18700	700	4	20	2175	7	20	3100	12	10	5095	/	/	/	22.53	22.49	23.50
	4	20	16QAM	1	99	20300	2300	2	20	900	7	20	3100	12	10	5095	/	/	/	22.28	22.24	23.00
	7	20	16QAM	1	50	21350	3350	2	20	900	4	20	2175	12	10	5095	/	/	/	20.58	20.54	21.00
CA_2A-2A-5A-66C	2	20	16QAM	1	50	18700	700	2	20	1100	5	10	2525	66	20	66786	66	20	66984	22.53	22.51	23.50
	5	10	QPSK	1	25	20450	2450	2	20	700	2	20	1100	66	20	66786	66	20	66984	23.92	23.90	25.00
	66	20	16QAM	1	99	132072	66536	66	20	66734	2	20	700	2	20	1100	5	10	2525	22.27	22.20	23.00
CA_2A-2A-7A-12A-66A	2	20	16QAM	1	50	18700	700	2	20	1100	7	20	3100	12	10	5095	66	20	66786	22.53	22.50	23.50
	7	20	16QAM	1	50	21350	3350	2	20	700	2	20	1100	12	10	5095	66	20	66786	20.58	20.48	21.00
	66	20	16QAM	1	99	132072	66536	2	20	700	2	20	1100	7	20	3100	12	10	5095	22.27	22.12	23.00
CA_2A-7A-12B-66A	2	20	16QAM	1	50	18700	700	7	20	3100	12	5	5095	12	5	5143	66	20	66786	22.53	22.43	23.50
	7	20	QPSK	1	50	21350	3350	2	20	900	12	5	5095	12	5	5143	66	20	66786	20.58	20.25	21.00
	66	20	16QAM	1	99	132072	66536	2	20	900	7	20	3100	12	5	5095	12	5	5143	22.27	22.17	23.00

Table 116: Conducted power measurement results of DL CA(Main Antenna, Reduced Power Level D4)



DL LTE CA Class	PCC						SCC1			SCC2			SCC3			SCC4			Power			
	PCC Band	PCC Bandwidth (MHz)	Modulation	PCC UL RB (RBs)	PCC UL RB (RBs)	PCC UL Channel	PCC DL Channel	SCC Band	SCC Bandwidth (MHz)	SCC DL Channel	SCC Band	SCC Bandwidth (MHz)	SCC DL Channel	SCC Band	SCC Bandwidth (MHz)	SCC DL Channel	SCC Band	SCC Bandwidth (MHz)	SCC DL Channel	Ref. LTE Tx Power (dBm)	DL LTE CA Tx Power (dBm)	Tune-up
CA_2C	2	20	QPSK	1	99	18700	700	2	20	898	/	/	/	/	/	/	/	/	/	23.33	23.10	24.50
CA_5B	5	10	QPSK	1	25	20450	2450	5	10	2549	/	/	/	/	/	/	/	/	/	23.92	23.72	25.00
CA_38C	38	20	16QAM	1	0	37850	37850	38	20	38048	/	/	/	/	/	/	/	/	/	23.64	23.44	24.00
CA_41C	41	20	QPSK	1	0	41140	41140	41	20	40942	/	/	/	/	/	/	/	/	/	24.31	24.21	25.00
CA_66B	66	10	QPSK	1	0	132622	67086	66	10	66987	/	/	/	/	/	/	/	/	/	22.99	22.76	24.00
CA_2A-17A	2	20	QPSK	1	99	18700	700	17	10	5790	/	/	/	/	/	/	/	/	/	23.33	23.20	24.50
	17	10	QPSK	1	49	23790	5790	2	20	900	/	/	/	/	/	/	/	/	/	24.22	24.03	25.00
CA_4A-17A	4	20	QPSK	1	50	20050	2050	17	10	5790	/	/	/	/	/	/	/	/	/	24.10	23.89	25.00
CA_41D	41	20	QPSK	1	0	41140	41140	41	20	40942	41	20	40744	/	/	/	/	/	/	24.31	24.05	25.00
CA_66D	66	20	QPSK	1	99	132572	67036	66	20	66838	66	20	66640	/	/	/	/	/	/	22.98	22.79	24.00
CA_2A-4A-4A	2	20	QPSK	1	99	18700	700	4	20	2050	4	20	2300	/	/	/	/	/	/	23.73	23.56	24.50
	4	20	QPSK	1	50	20050	2050	4	20	2300	2	20	900	/	/	/	/	/	/	24.10	23.92	25.00
CA_4A-4A-5A	4	20	QPSK	1	50	20050	2050	4	20	2300	5	10	2525	/	/	/	/	/	/	24.10	23.84	25.00
	5	10	QPSK	1	25	20450	2450	4	20	2050	4	10	2350	/	/	/	/	/	/	23.92	23.71	25.00
CA_4A-4A-7A	4	20	QPSK	1	50	20050	2050	4	20	2300	7	20	3100	/	/	/	/	/	/	24.10	23.89	25.00
	7	20	QPSK	1	99	21350	3350	4	20	2050	4	10	2350	/	/	/	/	/	/	21.37	21.26	22.00
CA_4A-4A-12A	4	20	QPSK	1	50	20050	2050	4	20	2300	12	10	5095	/	/	/	/	/	/	24.10	23.96	25.00
CA_4A-12B	4	20	QPSK	1	50	20050	2050	12	5	5095	12	5	5143	/	/	/	/	/	/	24.10	23.89	25.00
	5	10	QPSK	1	25	20450	2450	7	20	3100	7	20	3298	/	/	/	/	/	/	23.92	23.78	25.00
CA_5A-7C	7	20	QPSK	1	99	21350	3350	7	20	3152	5	10	2525	/	/	/	/	/	/	21.37	21.15	22.00
	5	10	QPSK	1	25	20450	2450	7	20	2850	7	20	3350	/	/	/	/	/	/	23.92	23.75	25.00
CA_5A-7A-7A	7	20	QPSK	1	99	21350	3350	7	20	2850	5	10	2525	/	/	/	/	/	/	21.37	21.13	22.00
	66	20	QPSK	1	99	132572	67036	66	20	66536	12	10	2095	/	/	/	/	/	/	22.98	22.77	24.00
CA_2A-4A-5A	2	20	QPSK	1	99	18700	700	4	20	2175	5	10	2525	/	/	/	/	/	/	23.73	23.51	24.50
	4	20	QPSK	1	50	20050	2050	2	20	900	5	10	2525	/	/	/	/	/	/	24.10	23.88	25.00
5	10	QPSK	1	25	20450	2450	2	20	900	4	20	2175	/	/	/	/	/	/	23.92	23.84	25.00	
CA_7A-7A-66A-66A	7	20	QPSK	1	99	21350	3350	7	20	2850	66	20	66536	66	20	67036	/	/	/	21.37	21.29	22.00
	66	20	QPSK	1	99	132572	67036	66	20	66536	7	20	2850	7	20	3350	/	/	/	22.98	22.86	24.00
CA_7C-66A-66A	7	20	QPSK	1	99	21350	3350	7	20	3152	66	20	66536	66	20	67036	/	/	/	21.37	21.24	22.00
	66	20	QPSK	1	99	132572	67036	66	20	66536	7	20	3100	7	20	3298	/	/	/	22.98	22.89	24.00
CA_2A-4A-7A-7A	2	20	QPSK	1	99	18700	700	4	20	2175	7	20	2850	7	20	3350	/	/	/	23.73	23.68	24.50
	4	20	QPSK	1	50	20050	2050	2	20	900	7	20	2850	7	20	3350	/	/	/	24.10	23.98	25.00
CA_2A-4A-7C	7	20	QPSK	1	99	21350	3350	7	20	2850	2	20	900	4	20	2300	/	/	/	21.37	21.25	22.00
	2	20	QPSK	1	99	18700	700	4	20	2175	7	20	3100	7	20	3298	/	/	/	23.73	23.68	24.50
CA_2A-4A-7C	4	20	QPSK	1	50	20050	2050	2	20	900	7	20	3100	7	20	3298	/	/	/	24.10	23.93	25.00
	7	20	QPSK	1	99	21350	3350	7	20	3152	2	20	900	4	20	2175	/	/	/	21.37	21.26	22.00
CA_2A-4A-12A-12A	2	20	QPSK	1	99	18700	700	4	20	2175	12	5	5035	12	5	5155	/	/	/	23.73	23.58	24.50
	4	20	QPSK	1	50	20050	2050	2	20	900	12	5	5035	12	5	5155	/	/	/	24.10	23.84	25.00
CA_2A-2A-5A-66A	2	20	QPSK	1	99	18700	700	2	20	1100	5	10	2525	66	20	66786	/	/	/	23.73	23.55	24.50
	5	10	QPSK	1	25	20450	2450	2	20	700	2	20	1100	66	20	66786	/	/	/	23.92	23.75	25.00
CA_2A-2A-5A-66A	66	20	QPSK	1	99	132572	67036	2	20	700	2	20	1100	5	10	2525	/	/	/	22.98	22.84	24.00
	2	20	QPSK	1	99	18700	700	7	20	2850	7	20	3350	66	20	66786	/	/	/	23.73	23.64	24.50
CA_2A-7A-7A-66A	7	20	QPSK	1	99	21350	3350	7	20	2850	2	20	900	66	20	66786	/	/	/	21.37	21.29	22.00
	66	20	QPSK	1	99	132572	67036	2	20	900	7	20	2850	7	20	3350	/	/	/	22.98	22.74	24.00
CA_2A-7A-66A-66A	2	20	QPSK	1	99	18700	700	7	20	3100	66	20	66536	66	20	67036	/	/	/	23.73	23.55	24.50
	7	20	QPSK	1	99	21350	3350	2	20	900	66	20	66536	66	20	67036	/	/	/	21.37	21.26	22.00
66	20	QPSK	1	99	132572	67036	66	20	66536	2	20	900	7	20	3100	/	/	/	22.98	22.84	24.00	
CA_2A-4A-7A-12A	2	20	QPSK	1	99	18700	700	4	20	2175	7	20	3100	12	10	5095	/	/	/	23.73	23.59	24.50
	4	20	QPSK	1	50	20050	2050	2	20	900	7	20	3100	12	10	5095	/	/	/	24.10	23.87	25.00
CA_2A-2A-5A-66C	7	20	QPSK	1	99	21350	3350	2	20	900	4	20	2175	12	10	5095	/	/	/	21.37	21.22	22.00
	2	20	QPSK	1	99	18700	700	2	20	1100	5	10	2525	66	20	66786	66	20	66984	23.73	23.58	24.50
CA_2A-2A-5A-66C	5	10	QPSK	1	25	20450	2450	2	20	700	2	20	1100	66	20	66786	66	20	66984	23.92	23.75	25.00
	66	20	QPSK	1	99	132572	67036	66	20	66838	2	20	700	2	20	1100	5	10	2525	22.98	22.79	24.00
CA_2A-2A-7A-12A-66A	2	20	QPSK	1	99	18700	700	2	20	1100	7	20	3100	12	10	5095	66	20	66786	23.73	23.65	24.50
	7	20	QPSK	1	99	21350	3350	2	20	700	2	20	1100	12	10	5095	66	20	66786	21.37	21.25	22.00
CA_2A-2A-7A-12A-66A	66	20	QPSK	1	99	132572	67036	2	20	700	2	20	1100	7	20	3100	12	10	5095	22.98	22.81	24.00
	2	20	QPSK	1	99	18700	700	7	20	3100	12	5	5095	12	5	5143	66	20	66786	23.73	23.58	24.50
CA_2A-7A-12B-66A	7	20	QPSK	1	99	21350	3350	2	20	900	12	5	5095	12	5	5143	66	20	66786	21.37	21.35	22.00
	66	20	QPSK	1	99	132572	67036	2	20	900	7	20	3100	12	5	5095	12	5	5143	22.98	22.78	24.00

Table 117: Conducted power measurement results of DL CA(Main Antenna, Reduced Power Level D5)

DL LTE CA Class	PCC						SCC1			SCC2			SCC3			SCC4			Power			
	PCC Band	PCC Bandwidth (MHz)	Modulation	PCC UL RB #front	PCC UL RB #rear	PCC UL Channel	PCC DL Channel	SCC Band	SCC Bandwidth (MHz)	SCC DL Channel	SCC Band	SCC Bandwidth (MHz)	SCC DL Channel	SCC Band	SCC Bandwidth (MHz)	SCC DL Channel	SCC Band	SCC Bandwidth (MHz)	SCC DL Channel	Ref. LTE Tx Power (dBm)	DL LTE CA Tx Power (dBm)	Tune-up
CA_2C	2	20	64QAM	1	99	18700	700	2	20	898	/	/	/	/	/	/	/	/	/	20.74	20.69	21.50
CA_5B	5	10	QPSK	1	25	20450	2450	5	10	2549	/	/	/	/	/	/	/	/	/	23.92	23.72	25.00
CA_38C	38	20	16QAM	1	0	37850	37850	38	20	38048	/	/	/	/	/	/	/	/	/	22.68	22.56	23.00
CA_41C	41	20	16QAM	1	50	41140	41140	41	20	40942	/	/	/	/	/	/	/	/	/	22.61	22.49	23.00
CA_66B	66	10	16QAM	1	0	132622	67086	66	10	66987	/	/	/	/	/	/	/	/	/	20.54	20.40	21.50
CA_2A-17A	2	20	64QAM	1	99	18700	700	17	10	5790	/	/	/	/	/	/	/	/	/	20.74	20.66	21.50
	17	10	QPSK	1	49	23790	5790	2	20	900	/	/	/	/	/	/	/	/	/	24.22	23.96	25.00
CA_4A-17A	4	20	16QAM	1	0	20300	2300	17	10	5790	/	/	/	/	/	/	/	/	/	20.90	20.78	21.50
CA_41D	41	20	16QAM	1	50	41140	41140	41	20	40942	41	20	40744	/	/	/	/	/	/	22.91	22.37	23.00
CA_66D	66	20	16QAM	1	0	132072	66536	66	20	66734	66	20	66932	/	/	/	/	/	/	20.61	20.53	21.50
CA_2A-4A-4A	2	20	64QAM	1	99	18700	700	4	20	2050	4	20	2300	/	/	/	/	/	/	20.74	20.71	21.50
	4	20	16QAM	1	0	20300	2300	4	20	2050	2	20	900	/	/	/	/	/	/	20.90	20.88	21.50
CA_4A-4A-5A	4	20	16QAM	1	0	20300	2300	4	20	2050	5	10	2525	/	/	/	/	/	/	20.90	20.81	21.50
	5	10	QPSK	1	25	20450	2450	4	20	2050	4	20	2300	/	/	/	/	/	/	23.92	23.86	25.00
CA_4A-4A-7A	4	20	16QAM	1	0	20300	2300	4	20	2050	7	20	3100	/	/	/	/	/	/	20.90	20.84	21.50
	7	20	16QAM	1	99	21350	3350	4	20	2050	4	10	2350	/	/	/	/	/	/	21.05	20.41	21.50
CA_4A-4A-12A	4	20	16QAM	1	0	20300	2300	4	20	2050	12	10	5095	/	/	/	/	/	/	20.90	20.87	21.50
CA_4A-12B	4	20	16QAM	1	0	20300	2300	12	5	5095	12	5	5143	/	/	/	/	/	/	20.90	20.79	21.50
	5	10	QPSK	1	25	20450	2450	7	20	3100	7	20	3298	/	/	/	/	/	/	23.92	23.78	25.00
CA_5A-7C	7	20	16QAM	1	99	21350	3350	7	20	3152	5	10	2525	/	/	/	/	/	/	21.05	21.01	21.50
	5	10	QPSK	1	25	20450	2450	7	20	2850	7	20	3350	/	/	/	/	/	/	23.92	23.69	25.00
CA_5A-7A-7A	7	20	16QAM	1	99	21350	3350	7	20	2850	5	10	2525	/	/	/	/	/	/	21.05	20.98	21.50
	66	20	16QAM	1	0	132072	66536	66	20	67036	12	10	5095	/	/	/	/	/	/	20.61	20.41	21.50
CA_12A-66A-66A	2	20	64QAM	1	99	18700	700	4	20	2175	5	10	2525	/	/	/	/	/	/	20.74	20.66	21.50
	4	20	16QAM	1	0	20300	2300	2	20	900	5	10	2525	/	/	/	/	/	/	20.90	20.84	21.50
CA_2A-4A-5A	5	10	QPSK	1	25	20450	2450	2	20	900	4	20	2175	/	/	/	/	/	/	23.92	23.68	25.00
	7	20	16QAM	1	99	21350	3350	7	20	2850	66	20	66536	66	20	67036	/	/	/	21.05	20.99	21.50
CA_7A-7A-66A-66A	66	20	16QAM	1	0	132072	66536	66	20	67036	7	20	2850	7	20	3350	/	/	/	20.61	20.58	21.50
	7	20	16QAM	1	99	21350	3350	7	20	3152	66	20	66536	66	20	67036	/	/	/	21.05	21.03	21.50
CA_7C-66A-66A	66	20	16QAM	1	0	132072	66536	66	20	67036	7	20	3100	7	20	3298	/	/	/	20.61	20.55	21.50
	2	20	64QAM	1	99	18700	700	4	20	2175	7	20	2850	7	20	3350	/	/	/	20.74	20.64	21.50
CA_2A-4A-7A-7A	4	20	16QAM	1	0	20300	2300	2	20	900	7	20	2850	7	20	3350	/	/	/	20.90	20.81	21.50
	7	20	16QAM	1	99	21350	3350	7	20	2850	2	20	900	4	20	2300	/	/	/	21.05	20.96	21.50
CA_2A-4A-7C	2	20	64QAM	1	99	18700	700	4	20	2175	7	20	3100	7	20	3298	/	/	/	20.74	20.68	21.50
	4	20	16QAM	1	0	20300	2300	2	20	900	7	20	3100	7	20	3298	/	/	/	20.90	20.85	21.50
CA_2A-4A-12A	7	20	16QAM	1	99	21350	3350	7	20	3152	2	20	900	4	20	2175	/	/	/	21.05	20.98	21.50
	2	20	64QAM	1	99	18700	700	4	20	2175	12	5	5035	12	5	5155	/	/	/	20.74	20.70	21.50
CA_2A-2A-12A	4	20	16QAM	1	0	20300	2300	2	20	900	12	5	5035	12	5	5155	/	/	/	20.90	20.79	21.50
	2	20	64QAM	1	99	18700	700	2	20	1100	5	10	2525	66	20	66786	/	/	/	20.74	20.69	21.50
CA_2A-2A-5A-66A	5	10	QPSK	1	25	20450	2450	2	20	700	2	20	1100	66	20	66786	/	/	/	23.92	23.74	25.00
	66	20	16QAM	1	0	132072	66536	2	20	700	2	20	1100	5	10	2525	/	/	/	20.61	20.54	21.50
CA_2A-7A-7A-66A	2	20	64QAM	1	99	18700	700	7	20	2850	7	20	3350	66	20	66786	/	/	/	20.74	20.65	21.50
	7	20	16QAM	1	99	21350	3350	7	20	2850	2	20	900	66	20	66786	/	/	/	21.05	20.97	21.50
CA_2A-7A-66A-66A	66	20	16QAM	1	0	132072	66536	2	20	900	7	20	2850	7	20	3350	/	/	/	20.61	20.53	21.50
	2	20	64QAM	1	99	18700	700	7	20	3100	66	20	66536	66	20	67036	/	/	/	20.74	20.61	21.50
CA_2A-7A-12A	7	20	16QAM	1	99	21350	3350	2	20	900	66	20	66536	66	20	67036	/	/	/	21.05	20.91	21.50
	66	20	16QAM	1	0	132072	66536	66	20	67036	2	20	900	7	20	3100	/	/	/	20.61	20.48	21.50
CA_2A-4A-7A-12A	2	20	64QAM	1	99	18700	700	4	20	2175	7	20	3100	12	10	5095	/	/	/	20.74	20.69	21.50
	4	20	16QAM	1	0	20300	2300	2	20	900	7	20	3100	12	10	5095	/	/	/	20.90	20.84	21.50
CA_2A-2A-5A-66C	7	20	16QAM	1	99	21350	3350	2	20	900	4	20	2175	12	10	5095	/	/	/	21.05	21.01	21.50
	2	20	64QAM	1	99	18700	700	2	20	1100	5	10	2525	66	20	66786	66	20	66984	20.74	20.64	21.50
CA_2A-2A-7A-12A-66A	5	10	QPSK	1	25	20450	2450	2	20	700	2	20	1100	66	20	66786	66	20	66984	23.92	23.63	25.00
	66	20	16QAM	1	0	132072	66536	66	20	66734	2	20	700	2	20	1100	5	10	2525	20.61	20.54	21.50
CA_2A-7A-12B-66A	2	20	64QAM	1	99	18700	700	2	20	1100	7	20	3100	12	10	5095	66	20	66786	20.74	20.63	21.50
	7	20	16QAM	1	99	21350	3350	2	20	700	2	20	1100	12	10	5095	66	20	66786	21.05	20.99	21.50
CA_2A-7A-12B-66A	66	20	16QAM	1	0	132072	66536	2	20	700	2	20	1100	7	20	3100	12	10	5095	20.61	20.54	21.50
	2	20	64QAM	1	99	18700	700	7	20	3100	12	5	5095	12	5	5143	66	20	66786	20.74	20.65	21.50
CA_2A-7A-12B-66A	7	20	16QAM	1	99	21350	3350	2	20	900	12	5	5095	12	5	5143	66	20	66786	21.05	20.97	21.50
	66	20	16QAM	1	0	132072	66536	2	20	900	7	20	3100	12	5	5095	12	5	5143	20.61	20.52	21.50

Table 118: Conducted power measurement results of DL CA(Main Antenna, Reduced Power Reduced Power Level D6/D10)

DL LTE CA Class	PCC							SCC1			SCC2			SCC3			SCC4			Power					
	PCC Band	PCC Bandwidth (MHz)	Modulation	PCC UL RB	PCC UL RB offset	PCC UL Channel	PCC DL Channel	SCC Band	SCC Bandwidth (MHz)	SCC DL Channel	SCC Band	SCC Bandwidth (MHz)	SCC DL Channel	SCC Band	SCC Bandwidth (MHz)	SCC DL Channel	SCC Band	SCC Bandwidth (MHz)	SCC DL Channel	Ref. LTE Tx Power (dBm)	DL LTE CA Tx Power (dBm)	Tune-up			
CA_2C	2	20	16QAM	1	0	19100	1100	2	20	902	/	/	/	/	/	/	/	/	/	19.64	19.33	20.50			
CA_5B	5	10	QPSK	1	25	20450	2450	5	10	2549	/	/	/	/	/	/	/	/	/	23.92	23.72	25.00			
CA_38C	38	20	16QAM	1	50	38150	38150	38	20	37952	/	/	/	/	/	/	/	/	/	20.86	20.44	21.00			
CA_41C	41	20	16QAM	1	0	41140	41140	41	20	40942	/	/	/	/	/	/	/	/	/	22.61	22.49	23.00			
CA_66B	66	10	64QAM	1	0	132022	66486	66	10	66585	/	/	/	/	/	/	/	/	/	19.69	19.40	20.50			
CA_2A-17A	2	20	16QAM	1	0	19100	1100	17	10	5790	/	/	/	/	/	/	/	/	/	19.64	19.48	20.50			
	17	10	QPSK	1	49	23790	5790	2	20	900	/	/	/	/	/	/	/	/	/	24.22	23.79	25.00			
CA_4A-17A	4	20	64QAM	1	99	20300	2300	17	10	5790	/	/	/	/	/	/	/	/	/	18.93	18.49	19.50			
CA_41D	41	20	16QAM	1	0	41140	41140	41	20	40942	41	20	40744	/	/	/	/	/	/	22.61	22.37	23.00			
CA_66D	66	20	16QAM	1	0	132072	66536	66	20	66734	66	20	66932	/	/	/	/	/	/	19.60	19.35	20.50			
CA_2A-4A-4A	2	20	16QAM	1	0	19100	1100	4	20	2050	4	20	2300	/	/	/	/	/	/	19.64	19.22	20.50			
	4	20	64QAM	1	99	20300	2300	4	20	2050	2	20	900	/	/	/	/	/	/	18.93	17.85	19.50			
CA_4A-4A-5A	4	20	64QAM	1	99	20300	2300	4	20	2050	5	10	2525	/	/	/	/	/	/	18.93	18.22	19.50			
	5	10	QPSK	1	25	20450	2450	4	20	2050	4	20	2300	/	/	/	/	/	/	23.92	23.60	25.00			
CA_4A-4A-7A	4	20	64QAM	1	99	20300	2300	4	20	2050	7	20	3100	/	/	/	/	/	/	18.93	18.10	19.50			
	7	20	64QAM	1	50	21350	3350	4	20	2050	4	10	2350	/	/	/	/	/	/	17.56	16.85	18.00			
CA_4A-4A-12A	4	20	64QAM	1	99	20300	2300	4	20	2050	12	10	5095	/	/	/	/	/	/	18.93	18.19	19.50			
CA_4A-12B	4	20	64QAM	1	99	20300	2300	12	5	5095	12	5	5143	/	/	/	/	/	/	18.93	18.15	19.50			
CA_5A-7C	5	10	QPSK	1	25	20450	2450	7	20	3100	7	20	3298	/	/	/	/	/	/	23.92	23.39	25.00			
	7	20	64QAM	1	50	21350	3350	7	20	3152	5	10	2525	/	/	/	/	/	/	17.56	16.44	18.00			
CA_5A-7A-7A	5	10	QPSK	1	25	20450	2450	7	20	2850	7	20	3350	/	/	/	/	/	/	23.92	23.37	25.00			
	7	20	64QAM	1	50	21350	3350	7	20	2850	5	10	2525	/	/	/	/	/	/	17.56	16.53	18.00			
CA_12A-66A-66A	66	20	16QAM	1	0	132072	66536	66	20	67036	12	10	5095	/	/	/	/	/	/	19.60	19.05	20.50			
CA_2A-4A-5A	2	20	16QAM	1	0	19100	1100	4	20	2175	5	10	2525	/	/	/	/	/	/	19.64	18.85	20.50			
	4	20	64QAM	1	99	20300	2300	2	20	900	5	10	2525	/	/	/	/	/	/	18.93	17.56	19.50			
5	10	QPSK	1	25	20450	2450	2	20	900	4	20	2175	/	/	/	/	/	/	23.92	23.47	25.00				
CA_7A-7A-66A-66A	7	20	64QAM	1	50	21350	3350	7	20	2850	66	20	66536	66	20	67036	/	/	/	17.56	17.06	18.00			
	66	20	16QAM	1	0	132072	66536	66	20	67036	7	20	2850	7	20	3350	/	/	/	19.60	19.16	20.50			
CA_7C-66A-66A	7	20	64QAM	1	50	21350	3350	7	20	3152	66	20	66536	66	20	67036	/	/	/	17.56	17.02	18.00			
	66	20	16QAM	1	0	132072	66536	66	20	67036	7	20	3100	7	20	3298	/	/	/	19.60	18.99	20.50			
CA_2A-4A-7A-7A	2	20	16QAM	1	0	19100	1100	4	20	2175	7	20	2850	7	20	3350	/	/	/	19.64	19.24	20.50			
	4	20	64QAM	1	99	20300	2300	2	20	900	7	20	2850	7	20	3350	/	/	/	18.93	18.44	19.50			
CA_2A-4A-7C	2	20	16QAM	1	0	19100	1100	4	20	2175	7	20	3100	7	20	3298	/	/	/	17.56	17.09	18.00			
	4	20	64QAM	1	99	20300	2300	2	20	900	7	20	3100	7	20	3298	/	/	/	18.93	18.42	19.50			
CA_2A-4A-12A-12A	2	20	16QAM	1	0	19100	1100	4	20	2175	12	5	5035	12	5	5155	/	/	/	19.64	19.01	20.50			
	4	20	64QAM	1	99	20300	2300	2	20	900	12	5	5035	12	5	5155	/	/	/	18.93	17.61	19.50			
CA_2A-2A-5A-66A	2	20	16QAM	1	0	19100	1100	2	20	900	5	10	2525	66	20	66786	/	/	/	19.64	18.90	20.50			
	5	10	QPSK	1	25	20450	2450	2	20	700	2	20	1100	66	20	66786	/	/	/	23.92	23.53	25.00			
CA_2A-7A-7A-66A	66	20	16QAM	1	0	132072	66536	2	20	700	2	20	1100	5	10	2525	/	/	/	19.60	19.21	20.50			
	2	20	16QAM	1	0	19100	1100	7	20	2850	7	20	3350	66	20	66786	/	/	/	19.64	18.54	20.50			
CA_2A-7A-66A-66A	7	20	64QAM	1	50	21350	3350	7	20	2850	2	20	900	66	20	66786	/	/	/	17.56	16.89	18.00			
	66	20	16QAM	1	0	132072	66536	2	20	900	7	20	2850	7	20	3350	/	/	/	19.60	19.12	20.50			
CA_2A-7A-12A-12A	2	20	16QAM	1	0	19100	1100	7	20	3100	66	20	66536	66	20	67036	/	/	/	19.64	19.12	20.50			
	7	20	64QAM	1	50	21350	3350	2	20	900	66	20	66536	66	20	67036	/	/	/	17.56	16.86	18.00			
66	20	16QAM	1	0	132072	66536	66	20	67036	2	20	900	7	20	3100	/	/	/	19.60	18.99	20.50				
CA_2A-4A-7A-7A	2	20	16QAM	1	0	19100	1100	4	20	2175	7	20	3100	12	10	5095	/	/	/	19.64	18.66	20.50			
	4	20	64QAM	1	99	20300	2300	2	20	900	7	20	3100	12	10	5095	/	/	/	18.93	17.97	19.50			
CA_2A-2A-5A-66C	2	20	16QAM	1	0	19100	1100	2	20	900	4	20	2175	12	10	5095	/	/	/	17.56	16.41	18.00			
	5	10	QPSK	1	25	20450	2450	2	20	700	5	10	2525	66	20	66786	66	20	66984	19.64	19.10	20.50			
CA_2A-2A-7A-12A-66A	66	20	16QAM	1	0	132072	66536	66	20	66932	2	20	700	2	20	1100	66	20	66786	66	20	66984	23.92	23.61	25.00
	2	20	16QAM	1	0	19100	1100	2	20	900	12	10	5095	66	20	66786	66	20	66786	19.64	19.10	20.50			
CA_2A-7A-12B-66A	7	20	64QAM	1	50	21350	3350	2	20	700	2	20	1100	12	10	5095	66	20	66786	17.56	17.21	18.00			
	66	20	16QAM	1	0	132072	66536	2	20	700	2	20	1100	7	20	3100	12	10	5095	19.60	19.28	20.50			
CA_2A-7A-12B-66A	2	20	16QAM	1	0	19100	1100	7	20	3100	12	5	5095	12	5	5143	66	20	66786	19.64	19.15	20.50			
	7	20	64QAM	1	50	21350	3350	2	20	900	12	5	5095	12	5	5143	66	20	66786	17.56	17.45	18.00			
66	20	16QAM	1	0	132072	66536	2	20	900	7	20	3100	12	5	5095	12	5	5143	19.60	19.25	20.50				

Table 119: Conducted power measurement results of DL CA(Main Antenna,Reduced Power Level D7)



DL LTE CA Class	PCC						SCC1			SCC2			SCC3			SCC4			Power			
	PCC Band	PCC Bandwidth (MHz)	Modulation	PCC UL RB	PCC UL RB offset	PCC UL Channel	PCC DL Channel	SCC Band	SCC Bandwidth (MHz)	SCC DL Channel	SCC Band	SCC Bandwidth (MHz)	SCC DL Channel	SCC Band	SCC Bandwidth (MHz)	SCC DL Channel	SCC Band	SCC Bandwidth (MHz)	SCC DL Channel	Ref LTE Tx Power (dBm)	DL LTE CA Tx Power (dBm)	Tune-up
CA_2C	2	20	64QAM	1	99	18700	700	2	20	898	/	/	/	/	/	/	/	/	/	20.74	20.69	21.50
CA_5B	5	10	QPSK	1	25	20450	2450	5	10	2549	/	/	/	/	/	/	/	/	/	23.92	23.72	25.00
CA_38C	38	20	16QAM	1	50	38150	38150	38	20	37952	/	/	/	/	/	/	/	/	/	21.76	21.38	22.00
CA_41C	41	20	16QAM	1	50	41140	41140	41	20	40942	/	/	/	/	/	/	/	/	/	22.61	22.49	23.00
CA_66B	66	10	16QAM	1	0	132622	67086	66	10	66987	/	/	/	/	/	/	/	/	/	20.54	20.40	21.50
CA_2A-17A	2	20	64QAM	1	99	18700	700	17	10	5790	/	/	/	/	/	/	/	/	/	20.74	20.66	21.50
	17	10	QPSK	1	49	23790	5790	2	20	900	/	/	/	/	/	/	/	/	/	24.22	23.96	25.00
CA_4A-17A	4	20	16QAM	1	0	20300	2300	17	10	5790	/	/	/	/	/	/	/	/	/	20.90	20.78	21.50
CA_41D	41	20	16QAM	1	50	41140	41140	41	20	40942	41	20	40744	/	/	/	/	/	/	22.61	22.37	23.00
CA_66D	66	20	16QAM	1	0	132072	66536	66	20	66734	66	20	66932	/	/	/	/	/	/	20.61	20.53	21.50
CA_2A-4A-4A	2	20	64QAM	1	99	18700	700	4	20	2050	4	20	2300	/	/	/	/	/	/	20.74	20.71	21.50
	4	20	16QAM	1	0	20300	2300	4	20	2050	2	20	900	/	/	/	/	/	/	20.90	20.88	21.50
CA_4A-4A-5A	4	20	16QAM	1	0	20300	2300	4	20	2050	5	10	2525	/	/	/	/	/	/	20.90	20.81	21.50
	5	10	QPSK	1	25	20450	2450	4	20	2050	4	20	2300	/	/	/	/	/	/	23.92	23.86	25.00
CA_4A-4A-7A	4	20	16QAM	1	0	20300	2300	4	20	2050	7	20	3100	/	/	/	/	/	/	20.90	20.23	21.50
	7	20	64QAM	1	50	21350	3350	4	20	2050	4	10	2350	/	/	/	/	/	/	18.47	17.85	19.00
CA_4A-4A-12A	4	20	16QAM	1	0	20300	2300	4	20	2050	12	10	5095	/	/	/	/	/	/	20.90	20.87	21.50
CA_4A-12B	4	20	16QAM	1	0	20300	2300	12	5	5095	12	5	5143	/	/	/	/	/	/	20.90	20.79	21.50
	5	10	QPSK	1	25	20450	2450	7	20	3100	7	20	3298	/	/	/	/	/	/	23.92	23.22	25.00
CA_5A-7C	7	20	64QAM	1	50	21350	3350	7	20	3152	5	10	2525	/	/	/	/	/	/	18.47	18.01	19.00
	5	10	QPSK	1	25	20450	2450	7	20	2850	7	20	3350	/	/	/	/	/	/	23.92	23.34	25.00
CA_5A-7A-7A	7	20	64QAM	1	50	21350	3350	7	20	2850	5	10	2525	/	/	/	/	/	/	18.47	17.95	19.00
	66	20	16QAM	1	0	132072	66536	66	20	67036	12	10	5095	/	/	/	/	/	/	20.61	20.20	21.50
CA_2A-4A-5A	2	20	64QAM	1	99	18700	700	4	20	2175	5	10	2525	/	/	/	/	/	/	20.74	20.66	21.50
	4	20	16QAM	1	0	20300	2300	2	20	900	5	10	2525	/	/	/	/	/	/	20.90	20.84	21.50
5	10	QPSK	1	25	20450	2450	2	20	900	4	20	2175	/	/	/	/	/	/	23.92	23.68	25.00	
CA_7A-7A-66A-66A	7	20	64QAM	1	50	21350	3350	7	20	2850	66	20	66536	66	20	67036	/	/	/	18.47	18.01	19.00
	66	20	16QAM	1	0	132072	66536	66	20	67036	7	20	2850	7	20	3350	/	/	/	20.61	20.23	21.50
CA_7C-66A-66A	7	20	64QAM	1	50	21350	3350	7	20	3152	66	20	66536	66	20	67036	/	/	/	18.47	17.96	19.00
	66	20	16QAM	1	0	132072	66536	66	20	67036	7	20	3100	7	20	3298	/	/	/	20.61	20.01	21.50
CA_2A-4A-7A-7A	2	20	64QAM	1	99	18700	700	4	20	2175	7	20	2850	7	20	3350	/	/	/	20.74	19.82	21.50
	4	20	16QAM	1	0	20300	2300	2	20	900	7	20	2850	7	20	3350	/	/	/	20.90	19.86	21.50
CA_2A-4A-7C	2	20	64QAM	1	99	18700	700	4	20	2175	7	20	3100	7	20	3298	/	/	/	18.47	18.02	19.00
	4	20	16QAM	1	0	20300	2300	2	20	900	7	20	3100	7	20	3298	/	/	/	20.90	19.82	21.50
CA_2A-4A-12A	7	20	64QAM	1	50	21350	3350	7	20	3152	2	20	900	4	20	2175	/	/	/	18.47	17.86	19.00
	2	20	64QAM	1	99	18700	700	4	20	2175	12	5	5035	12	5	5155	/	/	/	20.74	20.50	21.50
CA_2A-2A-12A	4	20	16QAM	1	0	20300	2300	2	20	900	12	5	5035	12	5	5155	/	/	/	20.90	20.79	21.50
	2	20	64QAM	1	99	18700	700	2	20	1100	5	10	2525	66	20	66786	/	/	/	20.74	20.69	21.50
CA_2A-2A-5A-66A	5	10	QPSK	1	25	20450	2450	2	20	700	2	20	1100	66	20	66786	/	/	/	23.92	23.84	25.00
	66	20	16QAM	1	0	132072	66536	2	20	700	2	20	1100	5	10	2525	/	/	/	20.61	20.11	21.50
CA_2A-7A-7A-66A	2	20	64QAM	1	99	18700	700	7	20	2850	7	20	3350	66	20	66786	/	/	/	20.74	19.76	21.50
	7	20	64QAM	1	50	21350	3350	7	20	2850	2	20	900	66	20	66786	/	/	/	18.47	18.02	19.00
66	20	16QAM	1	0	132072	66536	2	20	900	7	20	2850	7	20	3350	/	/	/	20.61	20.08	21.50	
CA_2A-7A-66A-66A	2	20	64QAM	1	99	18700	700	7	20	3100	66	20	66536	66	20	67036	/	/	/	20.74	19.76	21.50
	7	20	64QAM	1	50	21350	3350	2	20	900	66	20	66536	66	20	67036	/	/	/	18.47	18.01	19.00
66	20	16QAM	1	0	132072	66536	66	20	67036	2	20	900	7	20	3100	/	/	/	20.61	19.98	21.50	
CA_2A-4A-7A-12A	2	20	64QAM	1	99	18700	700	4	20	2175	7	20	3100	12	10	5095	/	/	/	20.74	19.92	21.50
	4	20	16QAM	1	0	20300	2300	2	20	900	7	20	3100	12	10	5095	/	/	/	20.90	19.95	21.50
7	20	64QAM	1	50	21350	3350	2	20	900	4	20	2175	12	10	5095	/	/	/	18.47	17.31	19.00	
CA_2A-2A-5A-66C	2	20	64QAM	1	99	18700	700	2	20	1100	5	10	2525	66	20	66786	66	20	66984	20.74	20.10	21.50
	5	10	QPSK	1	25	20450	2450	2	20	700	2	20	1100	66	20	66786	66	20	66984	23.92	23.45	25.00
66	20	16QAM	1	0	132072	66536	66	20	66734	2	20	700	2	20	1100	5	10	2525	20.61	20.11	21.50	
CA_2A-2A-7A-12A-66A	2	20	64QAM	1	99	18700	700	2	20	1100	7	20	3100	12	10	5095	66	20	66786	20.74	20.10	21.50
	7	20	64QAM	1	50	21350	3350	2	20	700	2	20	1100	12	10	5095	66	20	66786	18.47	17.95	19.00
66	20	16QAM	1	0	132072	66536	2	20	700	2	20	1100	7	20	3100	12	10	5095	20.61	20.21	21.50	
CA_2A-7A-12B-66A	2	20	64QAM	1	99	18700	700	7	20	3100	12	5	5095	12	5	5143	66	20	66786	20.74	20.06	21.50
	7	20	64QAM	1	50	21350	3350	2	20	900	12	5	5095	12	5	5143	66	20	66786	18.47	17.86	19.00
66	20	16QAM	1	0	132072	66536	2	20	900	7	20	3100	12	5	5095	12	5	5143	20.61	20.25	21.50	

Table 120: Conducted power measurement results of DL CA(Main Antenna, Reduced Power Reduced Power Level D8)



DL LTE CA Class	PCC						SCC1			SCC2			SCC3			SCC4			Power			
	PCC Band	PCC Bandwidth (MHz)	Modulation	PCC UL RB	PCC UL RB offset	PCC UL Channel	PCC DL Channel	SCC Band	SCC Bandwidth (MHz)	SCC DL Channel	SCC Band	SCC Bandwidth (MHz)	SCC DL Channel	SCC Band	SCC Bandwidth (MHz)	SCC DL Channel	SCC Band	SCC Bandwidth (MHz)	SCC DL Channel	Ref LTE Tx Power (dBm)	DL LTE CA Tx Power (dBm)	Tune-up
CA_2C	2	20	QPSK	1	99	18700	700	2	20	898	/	/	/	/	/	/	/	/	/	23.33	23.10	24.50
CA_5B	5	10	QPSK	1	25	20450	2450	5	10	2549	/	/	/	/	/	/	/	/	/	23.92	23.72	25.00
CA_38C	38	20	QPSK	1	99	38150	38150	38	20	37952	/	/	/	/	/	/	/	/	/	24.45	24.25	25.00
CA_41C	41	20	QPSK	1	0	40140	40140	41	20	40338	/	/	/	/	/	/	/	/	/	23.88	23.54	24.50
CA_66B	66	10	QPSK	1	49	132322	66786	66	10	66885	/	/	/	/	/	/	/	/	/	22.60	22.32	23.50
CA_2A-17A	2	20	QPSK	1	99	18700	700	17	10	5790	/	/	/	/	/	/	/	/	/	23.33	23.24	24.50
	17	10	QPSK	1	49	23790	5790	2	20	900	/	/	/	/	/	/	/	/	/	24.22	24.01	25.00
CA_4A-17A	4	20	QPSK	1	0	20050	2050	17	10	5790	/	/	/	/	/	/	/	/	/	23.58	23.50	24.50
CA_41D	41	20	QPSK	1	0	40140	40140	41	20	40338	41	20	40536	/	/	/	/	/	/	23.88	23.62	24.50
CA_66D	66	20	QPSK	1	99	132072	66536	66	20	66734	66	20	66932	/	/	/	/	/	/	22.47	22.09	23.50
CA_2A-4A-4A	2	20	QPSK	1	99	18700	700	4	20	2050	4	20	2300	/	/	/	/	/	/	23.33	22.85	24.50
	4	20	QPSK	1	0	20050	2050	4	20	2300	2	20	900	/	/	/	/	/	/	23.58	22.54	24.50
CA_4A-4A-5A	4	20	QPSK	1	0	20050	2050	4	20	2300	5	10	2525	/	/	/	/	/	/	23.58	23.17	24.50
	5	10	QPSK	1	25	20450	2450	4	20	2050	4	20	2300	/	/	/	/	/	/	23.92	23.51	25.00
CA_4A-4A-7A	4	20	QPSK	1	0	20050	2050	4	20	2300	7	20	3100	/	/	/	/	/	/	23.58	23.15	24.50
	7	20	QPSK	1	50	21350	3350	4	20	2050	4	10	2300	/	/	/	/	/	/	23.66	22.98	24.50
CA_4A-4A-12A	4	20	QPSK	1	0	20050	2050	4	20	2300	12	10	5095	/	/	/	/	/	/	23.58	23.13	24.50
CA_4A-12B	4	20	QPSK	1	0	20050	2050	12	5	5095	12	5	5143	/	/	/	/	/	/	23.58	23.33	24.50
	5	10	QPSK	1	25	20450	2450	7	20	3100	7	20	3298	/	/	/	/	/	/	23.92	23.84	25.00
CA_5A-7C	7	20	QPSK	1	50	21350	3350	7	20	3152	5	10	2525	/	/	/	/	/	/	23.66	23.56	24.50
	5	10	QPSK	1	25	20450	2450	7	20	2850	7	20	3350	/	/	/	/	/	/	23.92	23.91	25.00
CA_5A-7A-7A	7	20	QPSK	1	50	21350	3350	7	20	2850	5	10	2525	/	/	/	/	/	/	23.66	23.57	24.50
	66	20	QPSK	1	99	132072	66536	66	20	67036	12	10	5095	/	/	/	/	/	/	22.47	22.00	23.50
CA_2A-4A-5A	2	20	QPSK	1	99	18700	700	4	20	2175	5	10	2525	/	/	/	/	/	/	23.33	22.94	24.50
	4	20	QPSK	1	0	20050	2050	2	20	900	5	10	2525	/	/	/	/	/	/	23.58	22.67	24.50
5	10	QPSK	1	25	20450	2450	2	20	900	4	20	2175	/	/	/	/	/	/	23.92	22.70	25.00	
CA_7A-7A-66A-66A	7	20	QPSK	1	50	21350	3350	7	20	2850	66	20	66536	66	20	67036	/	/	/	23.66	23.27	24.50
	66	20	QPSK	1	99	132072	66536	66	20	67036	7	20	2850	7	20	3350	/	/	/	22.47	22.03	23.50
CA_7C-66A-66A	7	20	QPSK	1	50	21350	3350	7	20	3152	66	20	66536	66	20	67036	/	/	/	23.66	23.21	24.50
	66	20	QPSK	1	99	132072	66536	66	20	67036	7	20	3100	7	20	3298	/	/	/	22.47	22.01	23.50
CA_2A-4A-7A-7A	2	20	QPSK	1	99	18700	700	4	20	2175	7	20	2850	7	20	3350	/	/	/	23.33	22.46	24.50
	4	20	QPSK	1	0	20050	2050	2	20	900	7	20	2850	7	20	3350	/	/	/	23.58	22.68	24.50
CA_2A-4A-7C	7	20	QPSK	1	50	21350	3350	7	20	2850	2	20	900	4	20	2300	/	/	/	23.66	23.22	24.50
	2	20	QPSK	1	99	18700	700	4	20	2175	7	20	3100	7	20	3298	/	/	/	23.33	22.44	24.50
CA_2A-4A-7C	4	20	QPSK	1	0	20050	2050	2	20	900	7	20	3100	7	20	3298	/	/	/	23.58	22.75	24.50
	7	20	QPSK	1	50	21350	3350	7	20	3152	2	20	900	4	20	2175	/	/	/	23.66	23.18	24.50
CA_2A-4A-12A-12A	2	20	QPSK	1	99	18700	700	4	20	2175	12	5	5035	12	5	5155	/	/	/	23.33	22.87	24.50
	4	20	QPSK	1	0	20050	2050	2	20	900	12	5	5035	12	5	5155	/	/	/	23.58	22.55	24.50
CA_2A-2A-5A-66A	2	20	QPSK	1	99	18700	700	2	20	1100	5	10	2525	66	20	66786	/	/	/	23.33	22.77	24.50
	5	10	QPSK	1	25	20450	2450	2	20	700	2	20	1100	66	20	66786	/	/	/	23.92	23.71	25.00
CA_2A-2A-5A-66A	66	20	QPSK	1	99	132072	66536	2	20	700	2	20	1100	5	10	2525	/	/	/	22.47	22.11	23.50
	2	20	QPSK	1	99	18700	700	7	20	2850	7	20	3350	66	20	66786	/	/	/	23.33	22.44	24.50
CA_2A-7A-7A-66A	7	20	QPSK	1	50	21350	3350	7	20	2850	2	20	900	66	20	66786	/	/	/	23.66	23.15	24.50
	66	20	QPSK	1	99	132072	66536	2	20	900	7	20	2850	7	20	3350	/	/	/	22.47	21.99	23.50
CA_2A-7A-66A-66A	2	20	QPSK	1	99	18700	700	7	20	3100	66	20	66536	66	20	67036	/	/	/	23.33	22.47	24.50
	7	20	QPSK	1	50	21350	3350	2	20	900	66	20	66536	66	20	67036	/	/	/	23.66	23.30	24.50
66	20	QPSK	1	99	132072	66536	66	20	67036	2	20	900	7	20	3100	/	/	/	22.47	21.99	23.50	
CA_2A-4A-7A-12A	2	20	QPSK	1	99	18700	700	4	20	2175	7	20	3100	12	10	5095	/	/	/	23.33	22.62	24.50
	4	20	QPSK	1	0	20050	2050	2	20	900	7	20	3100	12	10	5095	/	/	/	23.58	22.72	24.50
7	20	QPSK	1	50	21350	3350	2	20	900	4	20	2175	12	10	5095	/	/	/	23.66	23.16	24.50	
CA_2A-2A-5A-66C	2	20	QPSK	1	99	18700	700	2	20	1100	5	10	2525	66	20	66786	66	20	66984	23.33	22.95	24.50
	5	10	QPSK	1	25	20450	2450	2	20	700	2	20	1100	66	20	66786	66	20	66984	23.92	23.58	25.00
66	20	QPSK	1	99	132072	66536	66	20	66734	2	20	700	2	20	1100	5	10	2525	22.47	22.01	23.50	
CA_2A-2A-7A-12A-66A	2	20	QPSK	1	99	18700	700	2	20	1100	7	20	3100	12	10	5095	66	20	66786	23.33	22.78	24.50
	7	20	QPSK	1	50	21350	3350	2	20	700	2	20	1100	12	10	5095	66	20	66786	23.66	22.84	24.50
66	20	QPSK	1	99	132072	66536	2	20	700	2	20	1100	7	20	3100	12	10	5095	22.47	22.28	23.50	
CA_2A-7A-12B-66A	2	20	QPSK	1	99	18700	700	7	20	3100	12	5	5095	12	5	5143	66	20	66786	23.33	22.71	24.50
	7	20	QPSK	1	50	21350	3350	2	20	900	12	5	5095	12	5	5143	66	20	66786	23.66	22.98	24.50
66	20	QPSK	1	99	132072	66536	2	20	900	7	20	3100	12	5	5095	12	5	5143	22.47	22.39	23.50	

Table 121: Conducted power measurement results of DL CA(Main Antenna,Reduced Power Level D1/D9)

DL LTE CA Class	PCC						SCC1			SCC2			SCC3			SCC4			Power						
	PCC Band	PCC Bandwidth (MHz)	Modulation	PCC UL RB (RBs)	PCC UL RB (RBs)	PCC UL Channel	PCC DL Channel	SCC Band	SCC Bandwidth (MHz)	SCC DL Channel	SCC Band	SCC Bandwidth (MHz)	SCC DL Channel	SCC Band	SCC Bandwidth (MHz)	SCC DL Channel	SCC Band	SCC Bandwidth (MHz)	SCC DL Channel	Ref. LTE Tx Power (dBm)	DL LTE CA Tx Power (dBm)	Tune-up			
CA_2C	2	20	16QAM	1	50	18700	700	2	20	898	/	/	/	/	/	/	/	/	/	22.53	22.51	23.50			
CA_5B	5	10	QPSK	1	25	20450	2450	5	10	2549	/	/	/	/	/	/	/	/	/	23.92	23.72	25.00			
CA_38C	38	20	16QAM	1	50	38150	38150	38	20	37952	/	/	/	/	/	/	/	/	/	22.61	22.54	23.00			
CA_41C	41	20	QPSK	1	0	40140	40140	41	20	40338	/	/	/	/	/	/	/	/	/	23.88	23.87	24.50			
CA_66B	66	10	16QAM	1	0	132022	66486	66	10	66585	/	/	/	/	/	/	/	/	/	21.72	21.60	22.50			
CA_2A-17A	2	20	16QAM	1	50	18700	700	17	10	5790	/	/	/	/	/	/	/	/	/	22.53	22.50	23.50			
	17	10	QPSK	1	49	23790	5790	2	20	900	/	/	/	/	/	/	/	/	/	24.22	24.11	25.00			
CA_4A-17A	4	20	16QAM	1	99	20300	2300	17	10	5790	/	/	/	/	/	/	/	/	/	21.90	21.21	22.50			
CA_41D	41	20	QPSK	1	0	40140	40140	41	20	40338	41	20	40536	/	/	/	/	/	/	23.88	23.67	24.50			
CA_66D	66	20	16QAM	1	99	132072	66536	66	20	66734	66	20	66932	/	/	/	/	/	/	21.45	21.14	22.50			
CA_2A-4A-4A	2	20	16QAM	1	50	18700	700	4	20	2050	4	20	2300	/	/	/	/	/	/	22.53	21.84	23.50			
	4	20	16QAM	1	99	20300	2300	4	20	2050	2	20	900	/	/	/	/	/	/	21.90	20.61	22.50			
CA_4A-4A-5A	4	20	16QAM	1	99	20300	2300	4	20	2050	5	10	2525	/	/	/	/	/	/	21.90	21.27	22.50			
	5	10	QPSK	1	25	20450	2450	4	20	2050	4	20	2300	/	/	/	/	/	/	23.92	23.11	25.00			
CA_4A-4A-7A	4	20	16QAM	1	99	20300	2300	4	20	2050	7	20	3100	/	/	/	/	/	/	21.90	21.30	22.50			
	7	20	16QAM	1	50	21350	3350	4	20	2050	4	10	2350	/	/	/	/	/	/	20.58	19.54	21.00			
CA_4A-4A-12A	4	20	16QAM	1	99	20300	2300	4	20	2050	12	10	5095	/	/	/	/	/	/	21.90	21.35	22.50			
CA_4A-12B	4	20	16QAM	1	99	20300	2300	12	5	5095	12	5	5143	/	/	/	/	/	/	21.90	21.40	22.50			
CA_5A-7C	5	10	QPSK	1	25	20450	2450	7	20	3100	7	20	3298	/	/	/	/	/	/	23.92	23.90	25.00			
	7	20	16QAM	1	50	21350	3350	7	20	3152	5	10	2525	/	/	/	/	/	/	20.58	20.55	21.00			
CA_5A-7A-7A	5	10	QPSK	1	25	20450	2450	7	20	2850	7	20	3350	/	/	/	/	/	/	23.92	23.58	25.00			
	7	20	16QAM	1	50	21350	3350	7	20	2850	5	10	2525	/	/	/	/	/	/	20.58	20.54	21.00			
CA_12A-66A-66A	66	20	16QAM	1	99	132072	66536	66	20	67036	12	10	5095	/	/	/	/	/	/	21.45	21.10	22.50			
CA_2A-4A-5A	2	20	16QAM	1	50	18700	700	4	20	2175	5	10	2525	/	/	/	/	/	/	22.53	21.76	23.50			
	4	20	16QAM	1	99	20300	2300	2	20	900	5	10	2525	/	/	/	/	/	/	21.90	20.88	22.50			
5	10	QPSK	1	25	20450	2450	2	20	900	4	20	2175	/	/	/	/	/	/	23.92	22.65	25.00				
CA_7A-7A-66A-66A	7	20	16QAM	1	50	21350	3350	7	20	2850	66	20	66536	66	20	67036	/	/	/	20.58	19.42	21.00			
	66	20	16QAM	1	99	132072	66536	66	20	67036	7	20	2850	7	20	3350	/	/	/	21.45	21.18	22.50			
CA_7C-66A-66A	7	20	16QAM	1	50	21350	3350	7	20	3152	66	20	66536	66	20	67036	/	/	/	20.58	19.63	21.00			
	66	20	16QAM	1	99	132072	66536	66	20	67036	7	20	3100	7	20	3298	/	/	/	21.45	21.19	22.50			
CA_2A-4A-7A-7A	2	20	16QAM	1	50	18700	700	4	20	2175	7	20	2850	7	20	3350	/	/	/	22.53	21.40	23.50			
	4	20	16QAM	1	99	20300	2300	2	20	900	7	20	2850	7	20	3350	/	/	/	21.90	20.99	22.50			
CA_2A-4A-7C	2	20	16QAM	1	50	18700	700	4	20	2175	7	20	3100	7	20	3298	/	/	/	22.53	21.45	23.50			
	4	20	16QAM	1	99	20300	2300	2	20	900	7	20	3100	7	20	3298	/	/	/	21.90	21.00	22.50			
CA_2A-4A-12A-12A	2	20	16QAM	1	50	21350	3350	7	20	3152	2	20	900	4	20	2175	/	/	/	20.58	19.44	21.00			
	4	20	16QAM	1	99	20300	2300	2	20	2175	12	5	5035	12	5	5155	/	/	/	22.53	22.01	23.50			
CA_2A-2A-5A-66A	2	20	16QAM	1	50	18700	700	2	20	1100	5	10	2525	66	20	66786	/	/	/	21.90	20.66	22.50			
	5	10	QPSK	1	25	20450	2450	2	20	700	2	20	1100	66	20	66786	/	/	/	23.92	22.70	25.00			
CA_2A-7A-7A-66A	66	20	16QAM	1	99	132072	66536	2	20	700	2	20	1100	5	10	2525	/	/	/	21.45	21.05	22.50			
	2	20	16QAM	1	50	18700	700	7	20	2850	7	20	3350	66	20	66786	/	/	/	22.53	21.40	23.50			
CA_2A-7A-7A-66A	7	20	16QAM	1	50	21350	3350	7	20	2850	2	20	900	66	20	66786	/	/	/	20.58	19.55	21.00			
	66	20	16QAM	1	99	132072	66536	2	20	900	7	20	2850	7	20	3350	/	/	/	21.45	21.19	22.50			
CA_2A-7A-66A-66A	2	20	16QAM	1	50	18700	700	7	20	3100	66	20	66536	66	20	67036	/	/	/	22.53	21.42	23.50			
	7	20	16QAM	1	50	21350	3350	2	20	900	66	20	66536	66	20	67036	/	/	/	20.58	19.62	21.00			
66	20	16QAM	1	99	132072	66536	66	20	67036	2	20	900	7	20	3100	/	/	/	21.45	21.21	22.50				
CA_2A-4A-7A-12A	2	20	16QAM	1	50	18700	700	4	20	2175	7	20	3100	12	10	5095	/	/	/	22.53	21.22	23.50			
	4	20	16QAM	1	99	20300	2300	2	20	900	7	20	3100	12	10	5095	/	/	/	21.90	21.12	22.50			
CA_2A-2A-5A-66C	2	20	16QAM	1	50	21350	3350	2	20	900	4	20	2175	12	10	5095	/	/	/	20.58	19.36	21.00			
	5	10	QPSK	1	25	20450	2450	2	20	1100	5	10	2525	66	20	66786	66	20	66984	22.53	21.94	23.50			
CA_2A-2A-7A-12A-66A	66	20	16QAM	1	99	132072	66536	66	20	66734	2	20	700	2	20	1100	66	20	66786	66	20	66984	23.92	23.64	25.00
	2	20	16QAM	1	50	18700	700	2	20	1100	7	20	3100	12	10	5095	66	20	66786	22.53	21.45	23.50			
CA_2A-2A-7A-12A-66A	7	20	16QAM	1	50	21350	3350	2	20	700	2	20	1100	12	10	5095	66	20	66786	20.58	20.03	21.00			
	66	20	16QAM	1	99	132072	66536	2	20	700	2	20	1100	7	20	3100	12	10	5095	21.45	21.25	22.50			
CA_2A-7A-12B-66A	2	20	16QAM	1	50	18700	700	7	20	3100	12	5	5095	12	5	5143	66	20	66786	22.53	21.77	23.50			
	7	20	16QAM	1	50	21350	3350	2	20	900	12	5	5095	12	5	5143	66	20	66786	20.58	20.50	21.00			
66	20	16QAM	1	99	132072	66536	2	20	900	7	20	3100	12	5	5095	12	5	5143	21.45	21.32	22.50				

Table 122: Conducted power measurement results of DL CA(Main Antenna,Reduced Power Level D2)

DL LTE CA Class	PCC						SCC1			SCC2			SCC3			SCC4			Power			
	PCC Band	PCC Bandwidth (MHz)	Modulation	PCC UL RB (RBs)	PCC UL RB (RBs)	PCC UL Channel	PCC DL Channel	SCC Band	SCC Bandwidth (MHz)	SCC DL Channel	SCC Band	SCC Bandwidth (MHz)	SCC DL Channel	SCC Band	SCC Bandwidth (MHz)	SCC DL Channel	SCC Band	SCC Bandwidth (MHz)	SCC DL Channel	Ref. LTE Tx Power (dBm)	DL LTE CA Tx Power (dBm)	Tune-up
CA_2C	2	20	QPSK	1	99	18700	700	2	20	898	/	/	/	/	/	/	/	/	/	23.33	23.10	24.50
CA_5B	5	10	QPSK	1	25	20450	2450	5	10	2549	/	/	/	/	/	/	/	/	/	23.92	23.72	25.00
CA_38C	38	20	16QAM	1	0	37850	37850	38	20	38048	/	/	/	/	/	/	/	/	/	23.64	23.54	24.00
CA_41C	41	20	QPSK	1	0	40140	40140	41	20	40338	/	/	/	/	/	/	/	/	/	23.88	23.78	24.50
CA_66B	66	10	QPSK	1	49	132322	66786	66	10	66885	/	/	/	/	/	/	/	/	/	22.60	22.50	23.50
CA_2A-17A	2	20	QPSK	1	99	18700	700	17	10	5790	/	/	/	/	/	/	/	/	/	23.33	23.15	24.50
	17	10	QPSK	1	49	23790	5790	2	20	900	/	/	/	/	/	/	/	/	/	24.22	24.11	25.00
CA_4A-17A	4	20	QPSK	1	0	20050	2050	17	10	5790	/	/	/	/	/	/	/	/	/	23.58	23.54	24.50
CA_41D	41	20	QPSK	1	0	40140	40140	41	20	40338	41	20	40536	/	/	/	/	/	/	23.88	23.78	24.50
CA_66D	66	20	QPSK	1	99	132072	66536	66	20	66734	66	20	66932	/	/	/	/	/	/	22.47	22.44	23.50
CA_2A-4A-4A	2	20	QPSK	1	99	18700	700	4	20	2050	4	20	2300	/	/	/	/	/	/	23.33	23.28	24.50
	4	20	QPSK	1	0	20050	2050	4	20	2300	2	20	900	/	/	/	/	/	/	23.58	23.19	24.50
CA_4A-4A-5A	4	20	QPSK	1	0	20050	2050	4	20	2300	5	10	2525	/	/	/	/	/	/	23.58	23.17	24.50
	5	10	QPSK	1	25	20450	2450	4	20	2050	4	20	2300	/	/	/	/	/	/	23.92	23.68	25.00
CA_4A-4A-7A	4	20	QPSK	1	0	20050	2050	4	20	2300	7	20	3100	/	/	/	/	/	/	23.58	23.43	24.50
	7	20	QPSK	1	99	21350	3350	4	20	2050	4	10	2350	/	/	/	/	/	/	21.37	20.70	22.00
CA_4A-4A-12A	4	20	QPSK	1	0	20050	2050	4	20	2300	12	10	5095	/	/	/	/	/	/	23.58	23.51	24.50
CA_4A-12B	4	20	QPSK	1	0	20050	2050	12	5	5095	12	5	5143	/	/	/	/	/	/	23.58	23.46	24.50
	5	10	QPSK	1	25	20450	2450	7	20	3100	7	20	3298	/	/	/	/	/	/	23.92	23.81	25.00
CA_5A-7C	7	20	QPSK	1	99	21350	3350	7	20	3152	5	10	2525	/	/	/	/	/	/	21.37	21.30	22.00
	5	10	QPSK	1	25	20450	2450	7	20	2850	7	20	3350	/	/	/	/	/	/	23.92	23.32	25.00
CA_5A-7A-7A	7	20	QPSK	1	99	21350	3350	7	20	2850	5	10	2525	/	/	/	/	/	/	21.37	20.99	22.00
	66	20	QPSK	1	99	132072	66536	66	20	67036	12	10	5095	/	/	/	/	/	/	22.47	22.21	23.50
CA_2A-4A-5A	2	20	QPSK	1	99	18700	700	4	20	2175	5	10	2525	/	/	/	/	/	/	23.33	23.30	24.50
	4	20	QPSK	1	0	20050	2050	2	20	900	5	10	2525	/	/	/	/	/	/	23.58	23.44	24.50
5	10	QPSK	1	25	20450	2450	2	20	900	4	20	2175	/	/	/	/	/	/	23.92	23.76	25.00	
CA_7A-7A-66A-66A	7	20	QPSK	1	99	21350	3350	7	20	2850	66	20	66536	66	20	67036	/	/	/	21.37	20.77	22.00
	66	20	QPSK	1	99	132072	66536	66	20	67036	7	20	2850	7	20	3350	/	/	/	22.47	22.27	23.50
CA_7C-66A-66A	7	20	QPSK	1	99	21350	3350	7	20	3152	66	20	66536	66	20	67036	/	/	/	21.37	21.34	22.00
	66	20	QPSK	1	99	132072	66536	66	20	67036	7	20	3100	7	20	3298	/	/	/	22.47	22.41	23.50
CA_2A-4A-7A-7A	2	20	QPSK	1	99	18700	700	4	20	2175	7	20	2850	7	20	3350	/	/	/	23.33	23.33	24.50
	4	20	QPSK	1	0	20050	2050	2	20	900	7	20	2850	7	20	3350	/	/	/	23.58	22.72	24.50
CA_2A-4A-7C	7	20	QPSK	1	99	21350	3350	7	20	2850	2	20	900	4	20	2300	/	/	/	21.37	20.75	22.00
	2	20	QPSK	1	99	18700	700	4	20	2175	7	20	3100	7	20	3298	/	/	/	23.33	22.29	24.50
CA_2A-4A-7C	4	20	QPSK	1	0	20050	2050	2	20	900	7	20	3100	7	20	3298	/	/	/	23.58	22.61	24.50
	7	20	QPSK	1	99	21350	3350	7	20	3152	2	20	900	4	20	2175	/	/	/	21.37	20.69	22.00
CA_2A-4A-12A-12A	2	20	QPSK	1	99	18700	700	4	20	2175	12	5	5035	12	5	5155	/	/	/	23.33	23.20	24.50
	4	20	QPSK	1	0	20050	2050	2	20	900	12	5	5035	12	5	5155	/	/	/	23.58	23.54	24.50
CA_2A-2A-5A-66A	2	20	QPSK	1	99	18700	700	2	20	1100	5	10	2525	66	20	66786	/	/	/	23.33	23.16	24.50
	5	10	QPSK	1	25	20450	2450	2	20	700	2	20	1100	66	20	66786	/	/	/	23.92	23.87	25.00
CA_2A-2A-5A-66A	66	20	QPSK	1	99	132072	66536	2	20	700	2	20	1100	5	10	2525	/	/	/	22.47	22.44	23.50
	2	20	QPSK	1	99	18700	700	7	20	2850	7	20	3350	66	20	66786	/	/	/	23.33	23.30	24.50
CA_2A-7A-7A-66A	7	20	QPSK	1	99	21350	3350	7	20	2850	2	20	900	66	20	66786	/	/	/	21.37	20.83	22.00
	66	20	QPSK	1	99	132072	66536	2	20	900	7	20	2850	7	20	3350	/	/	/	22.47	22.44	23.50
CA_2A-7A-66A-66A	2	20	QPSK	1	99	18700	700	7	20	3100	66	20	66536	66	20	67036	/	/	/	23.33	23.16	24.50
	7	20	QPSK	1	99	21350	3350	2	20	900	66	20	66536	66	20	67036	/	/	/	21.37	20.68	22.00
66	20	QPSK	1	99	132072	66536	66	20	67036	2	20	900	7	20	3100	/	/	/	22.47	22.40	23.50	
CA_2A-4A-7A-12A	2	20	QPSK	1	99	18700	700	4	20	2175	7	20	3100	12	10	5095	/	/	/	23.33	22.45	24.50
	4	20	QPSK	1	0	20050	2050	2	20	900	7	20	3100	12	10	5095	/	/	/	23.58	22.79	24.50
CA_2A-2A-5A-66C	7	20	QPSK	1	99	21350	3350	2	20	900	4	20	2175	12	10	5095	/	/	/	21.37	20.58	22.00
	2	20	QPSK	1	99	18700	700	2	20	1100	5	10	2525	66	20	66786	66	20	66984	23.33	22.95	24.50
CA_2A-2A-5A-66C	5	10	QPSK	1	25	20450	2450	2	20	700	2	20	1100	66	20	66786	66	20	66984	23.92	23.58	25.00
	66	20	QPSK	1	99	132072	66536	66	20	66734	2	20	700	2	20	1100	5	10	2525	22.47	22.15	23.50
CA_2A-2A-7A-12A-66A	2	20	QPSK	1	99	18700	700	2	20	1100	7	20	3100	12	10	5095	66	20	66786	23.33	22.78	24.50
	7	20	QPSK	1	99	21350	3350	2	20	700	2	20	1100	12	10	5095	66	20	66786	21.37	21.24	22.00
CA_2A-2A-7A-12A-66A	66	20	QPSK	1	99	132072	66536	2	20	700	2	20	1100	7	20	3100	12	10	5095	22.47	22.35	23.50
	2	20	QPSK	1	99	18700	700	7	20	3100	12	5	5095	12	5	5143	66	20	66786	23.33	22.71	24.50
CA_2A-7A-12B-66A	7	20	QPSK	1	99	21350	3350	2	20	900	12	5	5095	12	5	5143	66	20	66786	21.37	21.35	22.00
	66	20	QPSK	1	99	132072	66536	2	20	900	7	20	3100	12	5	5095	12	5	5143	22.47	22.33	23.50

Table 123: Conducted power measurement results of DL CA(Main Antenna,Reduced Power Level D3)

7.1.32 Conducted power measurements of LTE Downlink 4x4 MIMO

LTE Band	Bandwidth /MHz	Channel	Modulation	RB Size	RB Offset	4x4 DL MIMO Tx. Power (dBm)	Single Antenna Tx. Power (dBm)	Tune-up
LTE Band 2	20	18700	QPSK	1	0	22.14	22.33	23.00
LTE Band 4	20	20175	QPSK	1	99	22.58	22.91	23.00
LTE Band 7	20	20850	16QAM	1	99	19.68	20.12	20.50
LTE Band 66	20	132072	QPSK	1	99	21.67	21.93	23.00

Table 124: Conducted power measurement results of LTE Band 2/4/7/66 DL 4x4 MIMO(Second Antenna,Full Power)

DL LTE CA Class	POC Band	POC Bandwidth (MHz)	Modulation	POC		POC		DL Antenna Configuration	SCC1		SCC2		SCC3		SCC4		without DL 4x4MIMO Tx Power	Power with DL 4x4MIMO Tx Power	Tune-up				
				UL RB	DL RB	UL Channel	DL Channel		SCC Band	SCC Bandwidth (MHz)	SCC DL Channel	DL Antenna Configuration	SCC Band	SCC Bandwidth (MHz)	SCC DL Channel	DL Antenna Configuration				SCC Band	SCC Bandwidth (MHz)	SCC DL Channel	DL Antenna Configuration
CA_2C	2	20	QPSK	1	0	18700	700	4*4 MIMO	2	20	898	4*4 MIMO	/	/	/	/	/	/	22.33	22.01	23.00		
CA_66B	66	20	QPSK	1	49	132022	66486	4*4 MIMO	66	10	66585	4*4 MIMO	/	/	/	/	/	/	21.92	21.58	23.00		
CA_2A-17A	2	20	QPSK	1	0	18700	700	4*4 MIMO	17	10	5790	2*2 MIMO	/	/	/	/	/	/	22.33	21.95	23.00		
CA_4A-17A	4	20	QPSK	1	99	20175	2175	4*4 MIMO	17	10	5790	2*2 MIMO	/	/	/	/	/	/	22.91	22.61	23.00		
CA_5A-7A	5	10	QPSK	1	49	20450	2450	2*2 MIMO	7	20	3100	4*4 MIMO	/	/	/	/	/	/	23.81	23.50	24.50		
	7	20	16QAM	1	99	20850	2850	4*4 MIMO	5	10	2525	2*2 MIMO	/	/	/	/	/	/	20.12	19.68	20.50		
CA_66D	66	20	QPSK	1	99	132072	66536	4*4 MIMO	66	20	66734	4*4 MIMO	66	20	66932	4*4 MIMO	/	/	21.93	21.63	23.00		
CA_4A-4A-7A	4	20	QPSK	1	99	20175	2175	2*2 MIMO	4	10	2350	2*2 MIMO	7	20	3100	4*4 MIMO	/	/	22.91	22.80	23.00		
	7	20	16QAM	1	99	20850	2850	4*4 MIMO	4	20	2050	2*2 MIMO	4	10	2350	2*2 MIMO	/	/	20.12	19.81	20.50		
CA_4A-12B	4	20	QPSK	1	99	20175	2175	4*4 MIMO	12	5	5095	2*2 MIMO	12	5	5143	2*2 MIMO	/	/	22.91	22.67	23.00		
	5	10	QPSK	1	49	20450	2450	2*2 MIMO	7	20	3100	4*4 MIMO	7	20	3298	4*4 MIMO	/	/	23.81	23.38	24.50		
CA_5A-7C	7	20	16QAM	1	99	20850	2850	4*4 MIMO	7	20	3048	4*4 MIMO	5	10	2525	2*2 MIMO	/	/	20.12	19.69	20.50		
	2	20	QPSK	1	0	18700	700	4*4 MIMO	4	20	2175	4*4 MIMO	5	10	2525	2*2 MIMO	/	/	22.33	22.00	23.00		
CA_2A-4A-5A	4	20	QPSK	1	99	20175	2175	4*4 MIMO	2	20	900	4*4 MIMO	5	10	2525	2*2 MIMO	/	/	22.91	22.61	23.00		
	5	10	QPSK	1	49	20450	2450	2*2 MIMO	2	20	900	4*4 MIMO	4	20	2175	4*4 MIMO	/	/	23.81	23.56	24.50		
CA_7C-66A-66A	7	20	16QAM	1	99	20850	2850	4*4 MIMO	7	20	3048	4*4 MIMO	66	20	66536	2*2 MIMO	/	/	20.12	19.88	20.50		
	66	20	QPSK	1	99	132072	66536	2*2 MIMO	66	20	67036	2*2 MIMO	7	20	3100	4*4 MIMO	7	20	3298	4*4 MIMO	21.93	21.55	23.00
	2	20	QPSK	1	0	18700	700	4*4 MIMO	4	20	2175	2*2 MIMO	7	20	2850	2*2 MIMO	7	20	3350	2*2 MIMO	22.33	21.89	23.00
CA_2A-4A-7A-7A	4	20	QPSK	1	99	20175	2175	2*2 MIMO	2	20	900	4*4 MIMO	7	20	2850	2*2 MIMO	7	20	3350	2*2 MIMO	22.91	22.59	23.00
	7	20	16QAM	1	99	20850	2850	2*2 MIMO	7	20	3350	2*2 MIMO	2	20	900	4*4 MIMO	4	20	2175	2*2 MIMO	20.12	19.82	20.50
	2	20	QPSK	1	0	18700	700	4*4 MIMO	4	20	2175	4*4 MIMO	7	20	3100	2*2 MIMO	7	20	3298	2*2 MIMO	22.33	21.84	23.00
CA_2A-4A-7C	4	20	QPSK	1	99	20175	2175	4*4 MIMO	2	20	900	4*4 MIMO	7	20	3100	2*2 MIMO	7	20	3298	2*2 MIMO	22.91	22.61	23.00
	7	20	16QAM	1	99	20850	2850	2*2 MIMO	7	20	3048	2*2 MIMO	4	20	2175	4*4 MIMO	/	/	20.12	19.84	20.50		
CA_2A-4A-12A-12A	2	20	QPSK	1	0	18700	700	4*4 MIMO	4	20	2175	4*4 MIMO	12	5	5035	2*2 MIMO	12	5	5155	2*2 MIMO	22.33	19.98	23.00
	4	20	QPSK	1	99	20175	2175	4*4 MIMO	2	20	900	4*4 MIMO	12	5	5035	2*2 MIMO	12	5	5155	2*2 MIMO	22.91	22.58	23.00
CA_2A-2A-5A-66A	2	20	QPSK	1	0	18700	700	2*2 MIMO	2	20	1100	2*2 MIMO	5	10	2525	2*2 MIMO	66	20	66786	4*4 MIMO	22.33	22.01	23.00
	5	10	QPSK	1	49	20450	2450	2*2 MIMO	2	20	700	2*2 MIMO	66	20	66786	4*4 MIMO	66	20	66786	4*4 MIMO	23.81	23.51	24.50
	66	20	QPSK	1	99	132072	66536	4*4 MIMO	2	20	700	2*2 MIMO	5	10	2525	2*2 MIMO	/	/	21.93	21.68	23.00		
CA_2A-7A-7A-66A	2	20	QPSK	1	0	18700	700	4*4 MIMO	7	20	2850	2*2 MIMO	2	20	3350	2*2 MIMO	66	20	66786	2*2 MIMO	22.33	22.00	23.00
	7	20	16QAM	1	99	20850	2850	2*2 MIMO	7	20	3350	2*2 MIMO	2	20	900	4*4 MIMO	66	20	66786	2*2 MIMO	20.12	19.86	20.50
	66	20	QPSK	1	99	132072	66536	2*2 MIMO	2	20	900	4*4 MIMO	7	20	3350	2*2 MIMO	7	20	3350	2*2 MIMO	22.91	21.69	23.00
CA_2A-7A-66A-66A	2	20	QPSK	1	0	18700	700	2*2 MIMO	7	20	3100	4*4 MIMO	66	20	66536	2*2 MIMO	66	20	67036	2*2 MIMO	22.33	19.94	23.00
	7	20	16QAM	1	99	20850	2850	4*4 MIMO	2	20	900	2*2 MIMO	66	20	66536	2*2 MIMO	66	20	67036	2*2 MIMO	20.12	19.86	20.50
	66	20	QPSK	1	99	132072	66536	2*2 MIMO	66	20	67036	2*2 MIMO	2	20	900	2*2 MIMO	7	20	3100	4*4 MIMO	21.93	21.63	23.00
CA_2A-4A-7A-12A	2	20	QPSK	1	0	18700	700	4*4 MIMO	4	20	2175	4*4 MIMO	7	20	3100	2*2 MIMO	12	10	5095	2*2 MIMO	22.33	21.94	23.00
	4	20	QPSK	1	99	20175	2175	4*4 MIMO	2	20	900	4*4 MIMO	7	20	3100	2*2 MIMO	12	10	5095	2*2 MIMO	22.91	22.59	23.00
	7	20	16QAM	1	99	20850	2850	2*2 MIMO	2	20	900	4*4 MIMO	12	10	5095	2*2 MIMO	/	/	20.12	19.67	20.50		
CA_2A-2A-5A-66C	2	20	QPSK	1	0	18700	700	2*2 MIMO	2	20	1100	2*2 MIMO	5	10	2525	2*2 MIMO	66	20	66786	4*4 MIMO	22.33	21.86	23.00
	5	10	QPSK	1	49	20450	2450	2*2 MIMO	2	20	700	2*2 MIMO	66	20	66786	4*4 MIMO	66	20	66984	4*4 MIMO	23.81	23.60	24.50
	66	20	QPSK	1	99	132072	66536	4*4 MIMO	66	20	66734	4*4 MIMO	2	20	900	2*2 MIMO	5	10	2525	2*2 MIMO	21.93	21.66	23.00
CA_2A-2A-7A-12A-66A	2	20	QPSK	1	0	18700	700	2*2 MIMO	2	20	1100	2*2 MIMO	7	20	3100	4*4 MIMO	12	10	5095	2*2 MIMO	22.33	21.92	23.00
	7	20	16QAM	1	99	20850	2850	4*4 MIMO	2	20	700	2*2 MIMO	2	20	1100	2*2 MIMO	66	20	66786	2*2 MIMO	20.12	19.88	20.50
	66	20	QPSK	1	99	132072	66536	2*2 MIMO	2	20	700	2*2 MIMO	2	20	1100	2*2 MIMO	7	20	3100	4*4 MIMO	22.91	21.57	23.00
	2	20	QPSK	1	0	18700	700	4*4 MIMO	7	20	3100	4*4 MIMO	12	5	5095	2*2 MIMO	66	20	66786	2*2 MIMO	22.33	21.89	23.00
	7	20	16QAM	1	99	20850	2850	4*4 MIMO	2	20	900	4*4 MIMO	12	5	5095	2*2 MIMO	66	20	66786	2*2 MIMO	20.12	19.88	20.50
	66	20	QPSK	1	99	132072	66536	2*2 MIMO	2	20	900	4*4 MIMO	7	20	3100	4*4 MIMO	12	5	5095	2*2 MIMO	21.93	21.59	23.00

Table 125: Conducted power measurement results of LTE DL 4x4 MIMO with CA(Second Antenna,Full Power)

LTE Band	Bandwidth/MHz	Channel	Modulation	RB Size	RB Offset	4x4 DL MIMO Tx. Power (dBm)	Single Antenna Tx. Power (dBm)	Tune-up
LTE Band 2	20	19100	16QAM	1	99	17.16	17.37	18.00
LTE Band 4	20	20300	64QAM	1	0	16.58	16.96	17.50
LTE Band 7	20	21350	16QAM	1	99	14.80	15.06	15.50
LTE Band 66	20	132322	16QAM	1	0	16.84	17.20	18.00

Table 126: Conducted power measurement results of LTE Band 2/4/7/66 DL 4x4 MIMO(Second Antenna,Reduced Power Level D1)

DL LTE CA Class	PCC Band	PCC Bandwidth (MHz)	PCC Modulation	PCC				SCC1				SCC2				SCC3				SCC4				Power		Tune-up					
				PCC UL RB size	PCC UL RB offset	PCC UL Channel	PCC DL Channel	DL Antenna Configuration	SCC Band	SCC Bandwidth (MHz)	SCC DL Channel	DL Antenna Configuration	SCC Band	SCC Bandwidth (MHz)	SCC DL Channel	DL Antenna Configuration	SCC Band	SCC Bandwidth (MHz)	SCC DL Channel	DL Antenna Configuration	SCC Band	SCC Bandwidth (MHz)	SCC DL Channel	DL Antenna Configuration	without DL 4x4MIMO Tx Power		with DL 4x4MIMO Tx Power				
CA_2C	2	20	16QAM	1	99	19100	1100	4*4 MIMO	2	20	902	4*4 MIMO	/	/	/	/	/	/	/	/	/	/	/	/	/	/	/	/	17.37	17.01	18.00
CA_66B	66	10	16QAM	1	49	132322	66786	4*4 MIMO	66	10	66885	4*4 MIMO	/	/	/	/	/	/	/	/	/	/	/	/	/	/	/	/	17.27	16.93	18.00
CA_2A-17A	2	20	16QAM	1	99	19100	1100	4*4 MIMO	17	10	5790	2*2 MIMO	/	/	/	/	/	/	/	/	/	/	/	/	/	/	/	/	17.37	16.91	18.00
CA_4A-17A	4	20	64QAM	1	0	20300	2300	4*4 MIMO	17	10	5790	2*2 MIMO	/	/	/	/	/	/	/	/	/	/	/	/	/	/	/	/	16.96	16.85	17.50
CA_5A-7A	5	10	16QAM	1	25	20450	2450	2*2 MIMO	7	20	3100	4*4 MIMO	/	/	/	/	/	/	/	/	/	/	/	/	/	/	/	/	18.09	17.78	18.50
CA_5A-7A	7	20	16QAM	1	99	21350	3350	4*4 MIMO	5	10	2525	2*2 MIMO	/	/	/	/	/	/	/	/	/	/	/	/	/	/	/	/	15.06	14.68	15.50
CA_66D	66	20	16QAM	1	0	132322	66786	4*4 MIMO	66	20	66984	4*4 MIMO	66	5	57101	4*4 MIMO	/	/	/	/	/	/	/	/	/	/	/	/	17.20	16.90	18.00
CA_4A-4A-7A	4	20	64QAM	1	0	20300	2300	2*2 MIMO	4	20	2050	2*2 MIMO	7	20	3100	4*4 MIMO	/	/	/	/	/	/	/	/	/	/	/	/	16.96	16.80	17.50
CA_4A-12B	7	20	16QAM	1	99	21350	3350	4*4 MIMO	4	20	2050	2*2 MIMO	4	20	2300	2*2 MIMO	/	/	/	/	/	/	/	/	/	/	/	/	15.06	14.75	15.50
CA_4A-12B	4	20	64QAM	1	0	20300	2300	4*4 MIMO	12	5	5095	2*2 MIMO	12	5	5143	2*2 MIMO	/	/	/	/	/	/	/	/	/	/	/	16.96	16.70	17.50	
CA_5A-7C	5	10	16QAM	1	25	20450	2450	2*2 MIMO	7	20	3100	4*4 MIMO	7	20	3298	4*4 MIMO	/	/	/	/	/	/	/	/	/	/	/	18.09	17.66	18.50	
CA_5A-7C	7	20	16QAM	1	99	21350	3350	4*4 MIMO	7	20	3152	4*4 MIMO	5	10	2525	2*2 MIMO	/	/	/	/	/	/	/	/	/	/	/	15.06	14.60	15.50	
CA_2A-4A-7A	2	20	16QAM	1	99	19100	1100	4*4 MIMO	4	20	2175	4*4 MIMO	5	10	2525	2*2 MIMO	/	/	/	/	/	/	/	/	/	/	/	17.37	17.04	18.00	
CA_2A-4A-5A	4	20	64QAM	1	0	20300	2300	4*4 MIMO	2	20	900	4*4 MIMO	5	10	2525	2*2 MIMO	/	/	/	/	/	/	/	/	/	/	/	16.96	16.60	17.50	
CA_2A-4A-5A	5	10	16QAM	1	25	20450	2450	2*2 MIMO	2	20	900	4*4 MIMO	4	20	2175	4*4 MIMO	/	/	/	/	/	/	/	/	/	/	/	18.09	17.84	18.50	
CA_7C-66A-66A	7	20	16QAM	1	99	21350	3350	4*4 MIMO	7	20	3152	4*4 MIMO	66	20	66536	2*2 MIMO	66	20	67036	2*2 MIMO	/	/	/	/	/	/	/	15.06	14.80	15.50	
CA_7C-66A-66A	66	20	16QAM	1	0	132322	66786	2*2 MIMO	66	20	67036	2*2 MIMO	7	20	3100	4*4 MIMO	7	20	3298	4*4 MIMO	/	/	/	/	/	/	/	17.20	16.82	18.00	
CA_2A-4A-7A-7A	2	20	16QAM	1	99	19100	1100	4*4 MIMO	4	20	2175	4*4 MIMO	7	20	2850	2*2 MIMO	7	20	3350	2*2 MIMO	/	/	/	/	/	/	/	17.37	16.90	18.00	
CA_2A-4A-7A-7A	4	20	64QAM	1	0	20300	2300	2*2 MIMO	2	20	900	4*4 MIMO	7	20	2850	2*2 MIMO	7	20	3350	2*2 MIMO	/	/	/	/	/	/	/	16.96	16.64	17.50	
CA_2A-4A-7A-7A	7	20	16QAM	1	99	21350	3350	2*2 MIMO	7	20	2850	2*2 MIMO	2	20	900	4*4 MIMO	4	20	2175	2*2 MIMO	/	/	/	/	/	/	/	15.06	14.72	15.50	
CA_2A-4A-7C	2	20	16QAM	1	99	19100	1100	4*4 MIMO	4	20	2175	4*4 MIMO	7	20	3100	2*2 MIMO	7	20	3298	2*2 MIMO	/	/	/	/	/	/	/	17.37	16.80	18.00	
CA_2A-4A-7C	4	20	64QAM	1	0	20300	2300	4*4 MIMO	2	20	900	4*4 MIMO	7	20	3100	2*2 MIMO	7	20	3298	2*2 MIMO	/	/	/	/	/	/	/	16.96	16.66	17.50	
CA_2A-4A-12A-12A	7	20	16QAM	1	99	21350	3350	2*2 MIMO	7	20	3152	2*2 MIMO	2	20	900	4*4 MIMO	4	20	2175	4*4 MIMO	/	/	/	/	/	/	/	15.06	14.70	15.50	
CA_2A-4A-12A-12A	2	20	16QAM	1	99	19100	1100	4*4 MIMO	4	20	2175	4*4 MIMO	12	5	5035	2*2 MIMO	12	5	5155	2*2 MIMO	/	/	/	/	/	/	/	17.37	15.00	18.00	
CA_2A-4A-12A-12A	4	20	64QAM	1	0	20300	2300	4*4 MIMO	2	20	900	4*4 MIMO	12	5	5035	2*2 MIMO	12	5	5155	2*2 MIMO	/	/	/	/	/	/	16.96	16.63	17.50		
CA_2A-2A-5A-66A	2	20	16QAM	1	99	19100	1100	2*2 MIMO	2	20	700	2*2 MIMO	66	20	66786	4*4 MIMO	66	20	66786	4*4 MIMO	/	/	/	/	/	/	17.37	17.00	18.00		
CA_2A-2A-5A-66A	5	10	16QAM	1	25	20450	2450	2*2 MIMO	2	20	700	2*2 MIMO	2	20	1100	2*2 MIMO	66	20	66786	4*4 MIMO	/	/	/	/	/	/	18.09	17.79	18.50		
CA_2A-2A-5A-66A	66	20	16QAM	1	0	132322	66786	4*4 MIMO	2	20	700	2*2 MIMO	2	20	1100	2*2 MIMO	5	10	2525	2*2 MIMO	/	/	/	/	/	/	17.20	16.90	18.00		
CA_2A-7A-7A-66A	2	20	16QAM	1	99	19100	1100	4*4 MIMO	7	20	2850	2*2 MIMO	7	20	3350	2*2 MIMO	66	20	66786	2*2 MIMO	/	/	/	/	/	/	17.37	17.04	18.00		
CA_2A-7A-7A-66A	7	20	16QAM	1	99	21350	3350	2*2 MIMO	7	20	2850	2*2 MIMO	2	20	900	4*4 MIMO	66	20	66786	2*2 MIMO	/	/	/	/	/	/	15.06	14.82	15.50		
CA_2A-7A-7A-66A	66	20	16QAM	1	0	132322	66786	2*2 MIMO	2	20	900	4*4 MIMO	7	20	2850	2*2 MIMO	7	20	3350	2*2 MIMO	/	/	/	/	/	/	17.20	16.96	18.00		
CA_2A-7A-66A-66A	2	20	16QAM	1	99	19100	1100	2*2 MIMO	7	20	3100	4*4 MIMO	66	20	66536	2*2 MIMO	66	20	67036	2*2 MIMO	/	/	/	/	/	/	17.37	14.93	18.00		
CA_2A-7A-66A-66A	7	20	16QAM	1	99	21350	3350	4*4 MIMO	2	20	900	2*2 MIMO	66	20	66536	2*2 MIMO	66	20	67036	2*2 MIMO	/	/	/	/	/	/	15.06	14.80	15.50		
CA_2A-7A-66A-66A	66	20	16QAM	1	0	132322	66786	2*2 MIMO	66	20	67036	2*2 MIMO	2	20	900	4*4 MIMO	7	20	3100	4*4 MIMO	/	/	/	/	/	/	17.20	16.91	18.00		
CA_2A-4A-7A-12A	2	20	16QAM	1	99	19100	1100	4*4 MIMO	4	20	2175	4*4 MIMO	7	20	3100	2*2 MIMO	12	10	5095	2*2 MIMO	/	/	/	/	/	/	17.37	16.98	18.00		
CA_2A-4A-7A-12A	4	20	64QAM	1	0	20300	2300	4*4 MIMO	2	20	900	4*4 MIMO	7	20	3100	2*2 MIMO	12	10	5095	2*2 MIMO	/	/	/	/	/	/	16.96	16.61	17.50		
CA_2A-4A-7A-12A	7	20	16QAM	1	99	21350	3350	2*2 MIMO	2	20	900	4*4 MIMO	4	20	2175	4*4 MIMO	12	10	5095	2*2 MIMO	/	/	/	/	/	/	15.06	14.61	15.50		
CA_2A-2A-5A-66C	2	20	16QAM	1	99	19100	1100	2*2 MIMO	2	20	700	2*2 MIMO	5	10	2525	2*2 MIMO	66	20	66786	4*4 MIMO	66	20	66984	4*4 MIMO	17.37	16.92	18.00				
CA_2A-2A-5A-66C	5	10	16QAM	1	25	20450	2450	2*2 MIMO	2	20	700	2*2 MIMO	2	20	1100	2*2 MIMO	66	20	66786	4*4 MIMO	66	20	66984	4*4 MIMO	18.09	17.88	18.50				
CA_2A-2A-5A-66C	66	20	16QAM	1	0	132322	66786	4*4 MIMO	66	20	66984	4*4 MIMO	2	20	700	2*2 MIMO	2	20	900	4*4 MIMO	5	10	2525	2*2 MIMO	17.20	16.96	18.00				
CA_2A-2A-7A-12A-66A	2	20	16QAM	1	99	19100	1100	2*2 MIMO	2	20	700	2*2 MIMO	7	20	3100	4*4 MIMO	12	10	5095	2*2 MIMO	66	20	66786	2*2 MIMO	17.37	16.96	18.00				
CA_2A-2A-7A-12A-66A	7	20	16QAM	1	99	21350																									

LTE Band	Bandwidth/MHz	Channel	Modulation	RB Size	RB Offset	4x4 DL MIMO Tx. Power (dBm)	Single Antenna Tx. Power (dBm)	Tune-up
LTE Band 2	20	18700	64QAM	1	0	14.04	14.40	15.00
LTE Band 4	20	20300	16QAM	1	99	13.51	13.81	14.50
LTE Band 7	20	21350	16QAM	1	0	12.99	13.13	13.50
LTE Band 66	20	132072	QPSK	1	99	13.67	14.02	15.00

Table 128: Conducted power measurement results of LTE Band 2/4/7/66 DL 4x4 MIMO(Second Antenna,Reduced Power Level D3)

DL LTE CA Class	PCC Band	PCC Bandwidth (MHz)	PCC Modulation	PCC		PCC		PCC		SCC1		SCC2		SCC3		SCC4		without DL 4x4MIMO Tx Power	with DL 4x4MIMO Tx Power	Tune-up			
				UL RB Size	UL RB Offset	UL Channel	DL Channel	DL Antenna Configuration	SCC Band	SCC Bandwidth (MHz)	SCC DL Channel	DL Antenna Configuration	SCC Band	SCC Bandwidth (MHz)	SCC DL Channel	DL Antenna Configuration	SCC Band				SCC Bandwidth (MHz)	SCC DL Channel	DL Antenna Configuration
CA_2C	2	20	64QAM	1	0	18700	700	4*4 MIMO	2	20	898	4*4 MIMO	/	/	/	/	/	/	/	14.40	14.00	15.00	
CA_66B	66	10	16QAM	1	49	132322	66786	4*4 MIMO	66	10	66885	4*4 MIMO	/	/	/	/	/	/	/	13.92	13.58	15.00	
CA_2A-17A	2	20	64QAM	1	0	18700	700	4*4 MIMO	17	10	5790	2*2 MIMO	/	/	/	/	/	/	/	14.40	14.05	15.00	
CA_4A-17A	4	20	16QAM	1	99	20300	2300	4*4 MIMO	17	10	5790	2*2 MIMO	/	/	/	/	/	/	/	13.81	13.50	14.50	
CA_5A-7A	5	10	16QAM	1	25	20450	2450	2*2 MIMO	7	20	2850	4*4 MIMO	/	/	/	/	/	/	/	18.09	17.62	18.50	
7	20	16QAM	1	0	21350	3350	4*4 MIMO	5	10	2525	2*2 MIMO	/	/	/	/	/	/	/	/	13.13	12.70	13.50	
CA_66D	66	20	QPSK	1	99	132072	66536	4*4 MIMO	66	20	66734	4*4 MIMO	/	/	/	/	/	/	/	14.02	13.70	15.00	
CA_4A-4A-7A	4	20	64QAM	1	0	20300	2300	2*2 MIMO	4	20	2050	2*2 MIMO	7	20	3100	4*4 MIMO	/	/	/	13.81	13.37	14.50	
7	20	16QAM	1	0	21350	3350	4*4 MIMO	4	20	2050	2*2 MIMO	4	20	2300	2*2 MIMO	/	/	/	/	13.13	12.84	13.50	
CA_4A-12B	4	20	64QAM	1	0	20300	2300	4*4 MIMO	12	5	5095	2*2 MIMO	12	5	5143	2*2 MIMO	/	/	/	13.81	13.70	14.50	
CA_5A-7C	5	10	16QAM	1	25	20450	2450	2*2 MIMO	7	20	3100	4*4 MIMO	7	20	3298	2*2 MIMO	/	/	/	18.09	17.71	18.50	
7	20	16QAM	1	0	21350	3350	4*4 MIMO	7	20	3152	4*4 MIMO	5	10	2525	2*2 MIMO	/	/	/	13.13	12.89	13.50		
CA_2A-4A-5A	2	20	64QAM	1	0	18700	700	4*4 MIMO	4	20	2175	4*4 MIMO	5	10	2525	2*2 MIMO	/	/	/	14.40	14.03	15.00	
4	20	64QAM	1	0	20300	2300	4*4 MIMO	2	20	900	4*4 MIMO	5	10	2525	2*2 MIMO	/	/	/	13.81	13.51	14.50		
5	10	16QAM	1	25	20450	2450	2*2 MIMO	2	20	900	4*4 MIMO	4	20	2175	4*4 MIMO	/	/	/	18.09	17.85	18.50		
CA_7C-66A-66A	7	20	16QAM	1	0	21350	3350	4*4 MIMO	7	20	3152	4*4 MIMO	66	20	66536	2*2 MIMO	66	20	67036	2*2 MIMO	13.13	12.89	13.50
66	20	QPSK	1	99	132072	66536	2*2 MIMO	66	20	67036	2*2 MIMO	7	20	3100	4*4 MIMO	7	20	3298	4*4 MIMO	14.02	13.66	15.00	
CA_2A-4A-7A-7A	2	20	64QAM	1	0	18700	700	4*4 MIMO	4	20	2175	2*2 MIMO	7	20	2850	2*2 MIMO	7	20	3350	2*2 MIMO	14.40	13.96	15.00
4	20	64QAM	1	0	20300	2300	2*2 MIMO	2	20	900	4*4 MIMO	7	20	2850	2*2 MIMO	7	20	3350	2*2 MIMO	13.81	13.47	14.50	
7	20	16QAM	1	0	21350	3350	4*4 MIMO	2	20	900	2*2 MIMO	66	20	66536	2*2 MIMO	4	20	2175	2*2 MIMO	13.13	12.71	13.50	
CA_2A-4A-7C	2	20	64QAM	1	0	18700	700	4*4 MIMO	4	20	2175	4*4 MIMO	7	20	3100	2*2 MIMO	7	20	3298	2*2 MIMO	14.40	13.91	15.00
4	20	64QAM	1	0	20300	2300	4*4 MIMO	2	20	900	4*4 MIMO	7	20	3100	2*2 MIMO	7	20	3298	2*2 MIMO	13.81	13.50	14.50	
CA_2A-4A-12A-12A	2	20	64QAM	1	0	18700	700	4*4 MIMO	4	20	2175	4*4 MIMO	12	5	5095	2*2 MIMO	12	5	5155	2*2 MIMO	14.40	12.08	15.00
4	20	64QAM	1	0	20300	2300	4*4 MIMO	2	20	900	4*4 MIMO	12	5	5035	2*2 MIMO	12	5	5155	2*2 MIMO	13.81	13.48	14.50	
CA_2A-2A-5A-66A	2	20	64QAM	1	0	18700	700	2*2 MIMO	2	20	1100	2*2 MIMO	66	20	66786	4*4 MIMO	66	20	66786	4*4 MIMO	14.40	14.08	15.00
5	10	16QAM	1	25	20450	2450	2*2 MIMO	2	20	700	2*2 MIMO	2	20	1100	2*2 MIMO	66	20	66786	4*4 MIMO	18.09	17.70	18.50	
66	20	QPSK	1	99	132072	66536	4*4 MIMO	2	20	700	2*2 MIMO	5	10	2525	2*2 MIMO	5	10	2525	2*2 MIMO	14.02	13.77	15.00	
CA_2A-7A-7A-66A	2	20	64QAM	1	0	18700	700	4*4 MIMO	7	20	2850	2*2 MIMO	7	20	3350	2*2 MIMO	66	20	66786	2*2 MIMO	14.40	14.01	15.00
7	20	16QAM	1	0	21350	3350	2*2 MIMO	7	20	2850	2*2 MIMO	2	20	900	4*4 MIMO	66	20	66786	2*2 MIMO	13.13	12.87	13.50	
66	20	QPSK	1	99	132072	66536	2*2 MIMO	2	20	900	4*4 MIMO	7	20	2850	2*2 MIMO	7	20	3350	2*2 MIMO	14.02	13.72	15.00	
CA_2A-7A-66A-66A	2	20	64QAM	1	0	18700	700	2*2 MIMO	2	20	3100	4*4 MIMO	66	20	66536	2*2 MIMO	66	20	67036	2*2 MIMO	14.40	12.01	15.00
7	20	16QAM	1	0	21350	3350	4*4 MIMO	2	20	900	2*2 MIMO	66	20	66536	2*2 MIMO	66	20	67036	2*2 MIMO	13.13	12.80	13.50	
66	20	QPSK	1	99	132072	66536	2*2 MIMO	66	20	67036	2*2 MIMO	2	20	900	2*2 MIMO	7	20	3100	4*4 MIMO	14.02	13.73	15.00	
CA_2A-4A-7A-12A	2	20	64QAM	1	0	18700	700	4*4 MIMO	4	20	2175	4*4 MIMO	7	20	3100	2*2 MIMO	12	10	5095	2*2 MIMO	14.40	14.01	15.00
4	20	64QAM	1	0	20300	2300	4*4 MIMO	2	20	900	4*4 MIMO	7	20	3100	2*2 MIMO	12	10	5095	2*2 MIMO	13.81	13.44	14.50	
7	20	16QAM	1	0	21350	3350	2*2 MIMO	2	20	900	4*4 MIMO	4	20	2175	4*4 MIMO	12	10	5095	2*2 MIMO	13.13	12.68	13.50	
CA_2A-2A-5A-66C	2	20	64QAM	1	0	18700	700	2*2 MIMO	2	20	1100	2*2 MIMO	5	10	2525	2*2 MIMO	66	20	66786	4*4 MIMO	14.40	13.95	15.00
5	10	16QAM	1	25	20450	2450	2*2 MIMO	2	20	700	2*2 MIMO	2	20	1100	2*2 MIMO	66	20	66786	4*4 MIMO	18.09	17.88	18.50	
66	20	QPSK	1	99	132072	66536	4*4 MIMO	66	20	66984	4*4 MIMO	2	20	900	2*2 MIMO	5	10	2525	2*2 MIMO	14.02	13.76	15.00	
CA_2A-2A-7A-12A-66A	2	20	64QAM	1	0	18700	700	2*2 MIMO	2	20	1100	2*2 MIMO	7	20	3100	4*4 MIMO	12	10	5095	2*2 MIMO	14.40	13.99	15.00
7	20	16QAM	1	0	21350	3350	4*4 MIMO	2	20	700	2*2 MIMO	2	20	1100	2*2 MIMO	12	10	5095	2*2 MIMO	13.13	12.87	13.50	
66	20	QPSK	1	99	132072	66536	2*2 MIMO	2	20	700	2*2 MIMO	2	20	1100	2*2 MIMO	7	20	3100	4*4 MIMO	14.02	13.66	15.00	
CA_2A-7A-12B-66A	2	20	64QAM	1	0	18700	700	4*4 MIMO	7	20	3100	4*4 MIMO	12	5	5095	2*2 MIMO	12	5	5143	2*2 MIMO	14.40	13.98	15.00
7	20	16QAM	1	0	21350	3350	4*4 MIMO	2	20	900	4*4 MIMO	12	5	5143	2*2 MIMO	66	20	66786	2*2 MIMO	13.13	12.89	13.50	
66	20	QPSK	1	99	132072	66536	2*2 MIMO	2	20	900	4*4 MIMO	7	20	3100	4*4 MIMO	12	5	5095	2*2 MIMO	14.02	13.69	15.00	

Table 129: Conducted power measurement results of LTE DL 4x4 MIMO with CA(Second Antenna,Reduced Power Level D3)

LTE Band	Bandwidth/MHz	Channel	Modulation	RB Size	RB Offset	4x4 DL MIMO Tx. Power (dBm)	Single Antenna Tx. Power (dBm)	Tune-up
LTE Band 2	20	19100	16QAM	1	50	19.04	19.27	20.00
LTE Band 4	20	20300	QPSK	1	99	19.89	20.20	21.00
LTE Band 7	20	21350	16QAM	1	99	17.61	18.09	18.50
LTE Band 66	20	132072	64QAM	1	0	18.67	18.95	20.00

Table 130: Conducted power measurement results of LTE Band 2/4/7/66 DL 4x4 MIMO(Second Antenna,Reduced Power Level D2)

DL LTE CA Class	PCC Band	PCC Bandwidth (MHz)	PCC Modulation	PCC				SCC1				SCC2				SCC3				SCC4				without DL 4x4MIMO Tx Power	with DL 4x4MIMO Tx Power	Tune-up										
				PCC UL RB Size	PCC UL RB Offset	PCC UL Channel	PCC DL Channel	DL Antenna Configuration	SCC Band	SCC Bandwidth (MHz)	SCC DL Channel	DL Antenna Configuration	SCC Band	SCC Bandwidth (MHz)	SCC DL Channel	DL Antenna Configuration	SCC Band	SCC Bandwidth (MHz)	SCC DL Channel	DL Antenna Configuration	SCC Band	SCC Bandwidth (MHz)	SCC DL Channel				DL Antenna Configuration									
CA_2C	2	20	16QAM	1	50	19100	1100	4*4 MIMO	2	20	902	4*4 MIMO	/	/	/	/	/	/	/	/	/	/	/	/	/	/	/	/	/	/	19.27	18.95	20.00			
CA_66B	66	10	QPSK	25	0	132622	67086	4*4 MIMO	66	10	66987	4*4 MIMO	/	/	/	/	/	/	/	/	/	/	/	/	/	/	/	/	/	/	/	18.86	18.55	20.00		
CA_2A-17A	2	20	16QAM	1	50	19100	1100	4*4 MIMO	17	10	5790	2*2 MIMO	/	/	/	/	/	/	/	/	/	/	/	/	/	/	/	/	/	/	/	19.27	18.85	20.00		
CA_4A-17A	4	20	QPSK	1	99	20300	2300	4*4 MIMO	17	10	5790	2*2 MIMO	/	/	/	/	/	/	/	/	/	/	/	/	/	/	/	/	/	/	/	20.20	19.91	21.00		
CA_5A-7A	5	10	QPSK	1	49	20450	2450	2*2 MIMO	7	20	2850	4*4 MIMO	/	/	/	/	/	/	/	/	/	/	/	/	/	/	/	/	/	/	/	23.81	23.36	24.50		
7	20	16QAM	1	99	21350	3350	4*4 MIMO	5	10	2525	2*2 MIMO	/	/	/	/	/	/	/	/	/	/	/	/	/	/	/	/	/	/	/	/	18.09	17.86	18.50		
CA_6B	66	20	64QAM	1	0	132072	66536	4*4 MIMO	66	20	66734	4*4 MIMO	/	/	/	/	/	/	/	/	/	/	/	/	/	/	/	/	/	/	/	18.95	18.62	20.00		
CA_4A-4A-7A	4	20	QPSK	1	99	20300	2300	2*2 MIMO	4	20	2050	2*2 MIMO	7	20	3100	4*4 MIMO	/	/	/	/	/	/	/	/	/	/	/	/	/	/	/	/	20.20	19.73	21.00	
7	20	16QAM	1	99	21350	3350	4*4 MIMO	4	20	2050	2*2 MIMO	4	10	2350	2*2 MIMO	/	/	/	/	/	/	/	/	/	/	/	/	/	/	/	/	18.09	17.73	18.50		
CA_4A-12B	4	20	QPSK	1	99	20300	2300	4*4 MIMO	12	5	5095	2*2 MIMO	12	5	5143	2*2 MIMO	/	/	/	/	/	/	/	/	/	/	/	/	/	/	/	/	20.20	20.09	21.00	
5	10	QPSK	1	49	20450	2450	2*2 MIMO	7	20	3100	4*4 MIMO	7	20	3298	2*2 MIMO	/	/	/	/	/	/	/	/	/	/	/	/	/	/	/	/	23.81	23.54	24.50		
CA_5A-7C	7	20	16QAM	1	99	21350	3350	4*4 MIMO	7	20	3152	4*4 MIMO	5	10	2525	2*2 MIMO	/	/	/	/	/	/	/	/	/	/	/	/	/	/	/	/	18.09	17.84	18.50	
2	20	16QAM	1	50	19100	1100	4*4 MIMO	4	20	2175	4*4 MIMO	5	10	2525	2*2 MIMO	/	/	/	/	/	/	/	/	/	/	/	/	/	/	/	/	19.27	18.97	20.00		
CA_2A-4A-5A	4	20	QPSK	1	99	20300	2300	4*4 MIMO	2	20	900	4*4 MIMO	5	10	2525	2*2 MIMO	/	/	/	/	/	/	/	/	/	/	/	/	/	/	/	/	20.20	19.97	21.00	
5	10	QPSK	1	49	20450	2450	2*2 MIMO	2	20	900	4*4 MIMO	4	20	2175	4*4 MIMO	/	/	/	/	/	/	/	/	/	/	/	/	/	/	/	/	23.81	23.55	24.50		
CA_7C-66A-66A	7	20	16QAM	1	99	21350	3350	4*4 MIMO	7	20	3152	4*4 MIMO	66	20	66536	2*2 MIMO	66	20	67036	2*2 MIMO	/	/	/	/	/	/	/	/	/	/	/	/	18.09	17.85	18.50	
66	20	64QAM	1	0	132072	66536	2*2 MIMO	66	20	67036	2*2 MIMO	7	20	3100	4*4 MIMO	7	20	3298	4*4 MIMO	/	/	/	/	/	/	/	/	/	/	/	/	/	18.95	18.56	20.00	
CA_2A-4A-7A-7A	2	20	16QAM	1	50	19100	1100	4*4 MIMO	4	20	2175	2*2 MIMO	7	20	2850	2*2 MIMO	7	20	3350	2*2 MIMO	/	/	/	/	/	/	/	/	/	/	/	/	19.27	18.83	20.00	
4	20	QPSK	1	99	20300	2300	2*2 MIMO	2	20	900	4*4 MIMO	7	20	2850	2*2 MIMO	7	20	3350	2*2 MIMO	/	/	/	/	/	/	/	/	/	/	/	/	/	20.20	19.84	21.00	
7	20	16QAM	1	99	21350	3350	2*2 MIMO	7	20	3350	2*2 MIMO	2	20	900	4*4 MIMO	4	20	2175	2*2 MIMO	/	/	/	/	/	/	/	/	/	/	/	/	/	18.09	17.63	18.50	
CA_2A-4A-7C	2	20	16QAM	1	50	19100	1100	4*4 MIMO	4	20	2175	4*4 MIMO	7	20	3100	2*2 MIMO	7	20	3298	2*2 MIMO	/	/	/	/	/	/	/	/	/	/	/	/	/	19.27	18.78	20.00
4	20	QPSK	1	99	20300	2300	4*4 MIMO	2	20	900	4*4 MIMO	7	20	3100	2*2 MIMO	7	20	3298	2*2 MIMO	/	/	/	/	/	/	/	/	/	/	/	/	/	20.20	19.93	21.00	
7	20	16QAM	1	99	21350	3350	2*2 MIMO	7	20	3152	2*2 MIMO	2	20	900	4*4 MIMO	4	20	2175	4*4 MIMO	/	/	/	/	/	/	/	/	/	/	/	/	/	18.09	17.81	18.50	
CA_2A-4A-12A-12A	2	20	16QAM	1	50	19100	1100	4*4 MIMO	4	20	2175	4*4 MIMO	12	5	5035	2*2 MIMO	12	5	5155	2*2 MIMO	/	/	/	/	/	/	/	/	/	/	/	/	19.27	18.62	20.00	
4	20	QPSK	1	99	20300	2300	4*4 MIMO	2	20	900	4*4 MIMO	12	5	5035	2*2 MIMO	12	5	5155	2*2 MIMO	/	/	/	/	/	/	/	/	/	/	/	/	20.20	19.87	21.00		
CA_2A-2A-5A-66A	2	20	16QAM	1	50	19100	1100	4*4 MIMO	2	20	700	2*2 MIMO	5	10	2525	2*2 MIMO	66	20	66786	4*4 MIMO	66	20	66786	4*4 MIMO	66	20	66786	4*4 MIMO	66	20	66984	4*4 MIMO	19.27	18.85	20.00	
5	10	QPSK	1	49	20450	2450	2*2 MIMO	2	20	700	2*2 MIMO	2	20	1100	2*2 MIMO	66	20	66786	4*4 MIMO	66	20	66786	4*4 MIMO	66	20	66786	4*4 MIMO	66	20	66984	4*4 MIMO	23.81	23.51	24.50		
66	20	64QAM	1	0	132072	66536	4*4 MIMO	66	20	700	2*2 MIMO	2	20	1100	2*2 MIMO	5	10	2525	2*2 MIMO	/	/	/	/	/	/	/	/	/	/	/	/	18.95	18.60	20.00		
CA_2A-7A-7A-66A	2	20	16QAM	1	50	19100	1100	4*4 MIMO	7	20	2850	2*2 MIMO	7	20	3350	2*2 MIMO	66	20	66786	2*2 MIMO	/	/	/	/	/	/	/	/	/	/	/	/	19.27	18.94	20.00	
7	20	16QAM	1	99	21350	3350	2*2 MIMO	7	20	3350	2*2 MIMO	2	20	900	4*4 MIMO	66	20	66786	2*2 MIMO	/	/	/	/	/	/	/	/	/	/	/	/	/	18.09	17.73	18.50	
66	20	64QAM	1	0	132072	66536	2*2 MIMO	2	20	900	4*4 MIMO	7	20	2850	2*2 MIMO	7	20	3350	2*2 MIMO	/	/	/	/	/	/	/	/	/	/	/	/	/	18.95	18.71	20.00	
CA_2A-7A-66A-66A	2	20	16QAM	1	50	19100	1100	2*2 MIMO	2	20	3100	4*4 MIMO	66	20	66536	2*2 MIMO	66	20	67036	2*2 MIMO	/	/	/	/	/	/	/	/	/	/	/	/	19.27	18.81	20.00	
7	20	16QAM	1	99	21350	3350	4*4 MIMO	2	20	900	2*2 MIMO	66	20	66536	2*2 MIMO	66	20	67036	2*2 MIMO	/	/	/	/	/	/	/	/	/	/	/	/	/	18.09	17.81	18.50	
66	20	64QAM	1	0	132072	66536	2*2 MIMO	66	20	67036	2*2 MIMO	2	20	900	2*2 MIMO	7	20	3100	4*4 MIMO	/	/	/	/	/	/	/	/	/	/	/	/	/	18.95	18.65	20.00	
CA_2A-4A-7A-12A	2	20	16QAM	1	50	19100	1100	4*4 MIMO	4	20	2175	4*4 MIMO	7	20	3100	2*2 MIMO	12	10	5095	2*2 MIMO	/	/	/	/	/	/	/	/	/	/	/	/	19.27	18.82	20.00	
4	20	QPSK	1	99	20300	2300	4*4 MIMO	2	20	900	4*4 MIMO	7	20	3100	2*2 MIMO	12	10	5095	2*2 MIMO	/	/	/	/	/	/	/	/	/	/	/	/	20.20	19.82	21.00		
7	20	16QAM	1	99	21350	3350	2*2 MIMO	2	20	900	4*4 MIMO	4	20	2175	4*4 MIMO	12	10	5095	2*2 MIMO	/	/	/	/	/	/	/	/	/	/	/	/	/	18.09	17.64	18.50	
CA_2A-2A-5A-66C	2	20	16QAM	1	50	19100	1100	2*2 MIMO	2	20	700	2*2 MIMO	5	10	2525	2*2 MIMO	66	20	66786	4*4 MIMO	66	20	66786	4*4 MIMO	66	20	66786	4*4 MIMO	66	20	66984	4*4 MIMO	19.27	18.81		

LTE Band	Bandwidth/MHz	Channel	Modulation	RB Size	RB Offset	4x4 DL MIMO Tx. Power (dBm)	Single Antenna Tx. Power (dBm)	Tune-up
LTE Band 2	20	18700	QPSK	1	99	23.04	23.33	24.50
LTE Band 4	20	20050	QPSK	1	50	23.91	24.10	25.00
LTE Band 7	20	21350	QPSK	1	50	23.15	23.66	24.50
LTE Band 66	20	132572	QPSK	1	99	22.64	22.98	24.00

Table 132: Conducted power measurement results of LTE Band 2/4/7/66 DL 4x4 MIMO(Main Antenna,Full Power)

DL LTE CA Class	PCC Band	PCC Bandwidth (MHz)	Modulation	PCC		PCC		DL Antenna Configuration	SCC1		SCC2		SCC3		SCC4		Power		Tune-up				
				PCC UL RB	PCC DL RB	PCC UL Channel	PCC DL Channel		SCC Band	SCC Bandwidth (MHz)	SCC DL Channel	DL Antenna Configuration	SCC Band	SCC Bandwidth (MHz)	SCC DL Channel	DL Antenna Configuration	SCC Band	SCC Bandwidth (MHz)		SCC DL Channel	DL Antenna Configuration	without DL 4x4MIMO Tx Power	with DL 4x4MIMO Tx Power
CA_2C	2	20	QPSK	1	99	18700	700	4*4 MIMO	2	20	898	4*4 MIMO	/	/	/	/	/	/	/	23.33	24.50		
CA_66B	66	10	QPSK	1	0	132622	67036	4*4 MIMO	66	10	66987	4*4 MIMO	/	/	/	/	/	/	/	22.99	22.55	24.00	
CA_2A-17A	2	20	QPSK	1	99	18700	700	4*4 MIMO	17	10	5790	2*2 MIMO	/	/	/	/	/	/	/	23.33	22.95	24.50	
CA_5A-7A	5	10	QPSK	1	25	20450	2450	4*4 MIMO	7	20	2850	2*2 MIMO	/	/	/	/	/	/	/	23.92	23.49	25.00	
CA_4A-17A	4	20	QPSK	1	50	21350	3350	2*2 MIMO	5	10	2525	4*4 MIMO	/	/	/	/	/	/	/	23.66	23.13	24.50	
CA_66D	66	20	QPSK	1	99	132572	67036	4*4 MIMO	66	20	66838	4*4 MIMO	66	20	66640	4*4 MIMO	/	/	/	22.98	22.57	24.00	
CA_4A-4A-7A	4	20	QPSK	1	50	20050	2050	2*2 MIMO	4	20	2300	2*2 MIMO	7	20	3100	4*4 MIMO	/	/	/	24.10	23.62	25.00	
CA_4A-12B	4	20	QPSK	1	50	21350	3350	4*4 MIMO	4	20	2050	2*2 MIMO	4	10	2350	2*2 MIMO	/	/	/	23.66	23.36	24.50	
CA_5A-7C	5	10	QPSK	1	25	20450	2450	2*2 MIMO	7	20	3100	4*4 MIMO	7	20	3298	4*4 MIMO	/	/	/	23.92	23.61	25.00	
CA_2A-4A-5A	2	20	QPSK	1	99	18700	700	4*4 MIMO	4	20	2175	4*4 MIMO	5	10	2525	2*2 MIMO	/	/	/	23.33	23.00	24.50	
CA_7C-66A-66A	7	20	QPSK	1	50	21350	3350	4*4 MIMO	7	20	3152	4*4 MIMO	66	20	66536	2*2 MIMO	66	20	67036	2*2 MIMO	23.92	23.67	25.00
CA_2A-4A-7A-7A	2	20	QPSK	1	99	18700	700	4*4 MIMO	4	20	2175	4*4 MIMO	7	20	3100	4*4 MIMO	7	20	3298	4*4 MIMO	22.98	22.60	24.00
CA_2A-4A-7C	2	20	QPSK	1	99	18700	700	4*4 MIMO	4	20	2175	4*4 MIMO	7	20	3100	4*4 MIMO	7	20	3298	4*4 MIMO	23.33	22.74	24.50
CA_2A-4A-12A-12A	2	20	QPSK	1	99	18700	700	4*4 MIMO	4	20	2175	4*4 MIMO	12	5	5035	2*2 MIMO	12	5	5155	2*2 MIMO	23.33	20.88	24.50
CA_2A-2A-5A-66A	2	20	QPSK	1	99	18700	700	4*4 MIMO	2	20	1100	2*2 MIMO	5	10	2525	2*2 MIMO	66	20	66786	4*4 MIMO	23.33	23.00	24.50
CA_2A-7A-7A-66A	2	20	QPSK	1	99	18700	700	4*4 MIMO	7	20	2850	2*2 MIMO	2	20	1100	2*2 MIMO	66	20	66786	4*4 MIMO	23.92	23.62	25.00
CA_2A-7A-66A-66A	66	20	QPSK	1	99	132572	67036	4*4 MIMO	66	20	66536	2*2 MIMO	5	10	2525	2*2 MIMO	66	20	66786	4*4 MIMO	22.98	22.63	24.00
CA_2A-4A-7A-12A	2	20	QPSK	1	99	18700	700	4*4 MIMO	4	20	2175	4*4 MIMO	7	20	3100	4*4 MIMO	12	10	5095	2*2 MIMO	23.33	22.94	24.50
CA_2A-2A-5A-66C	2	20	QPSK	1	99	18700	700	4*4 MIMO	2	20	1100	2*2 MIMO	5	10	2525	2*2 MIMO	66	20	66786	4*4 MIMO	23.33	22.81	24.50
CA_2A-2A-7A-12A-66A	2	20	QPSK	1	99	18700	700	4*4 MIMO	2	20	1100	2*2 MIMO	7	20	3100	4*4 MIMO	12	10	5095	2*2 MIMO	23.33	22.66	24.00
CA_2A-7A-12B-66A	2	20	QPSK	1	99	18700	700	4*4 MIMO	2	20	1100	2*2 MIMO	12	5	5095	2*2 MIMO	66	20	66786	4*4 MIMO	23.33	22.79	24.50
	66	20	QPSK	1	99	132572	67036	2*2 MIMO	2	20	900	4*4 MIMO	7	20	3100	4*4 MIMO	12	5	5095	2*2 MIMO	22.98	22.66	24.00

Table 133: Conducted power measurement results of LTE DL 4x4 MIMO(Main Antenna,Full Power)

LTE Band	Bandwidth/MHz	Channel	Modulation	RB Size	RB Offset	4x4 DL MIMO Tx. Power (dBm)	Single Antenna Tx. Power (dBm)	Tune-up
LTE Band 2	20	18700	16QAM	1	50	22.15	22.53	23.50
LTE Band 4	20	20300	16QAM	1	99	22.00	22.28	23.00
LTE Band 7	20	21350	16QAM	1	50	20.19	20.58	21.00
LTE Band 66	20	132072	16QAM	1	99	21.98	22.27	23.00

Table 134: Conducted power measurement results of LTE Band 2/4/7/66 DL 4x4 MIMO(Main Antenna,Reduced Power Level D4)

DL LTE CA Class	PCC Band	PCC Bandwidth (MHz)	PCC Modulation	PCC		SCC1				SCC2				SCC3				SCC4				without DL 4x4MIMO Tx Power	with DL 4x4MIMO Tx Power	Tune-up						
				UL RB	DL RB	UL Channel	DL Channel	DL Antenna Configuration	SCC Band	SCC Bandwidth (MHz)	SCC DL Channel	DL Antenna Configuration	SCC Band	SCC Bandwidth (MHz)	SCC DL Channel	DL Antenna Configuration	SCC Band	SCC Bandwidth (MHz)	SCC DL Channel	DL Antenna Configuration										
CA_2C	2	20	16QAM	1	50	18700	700	4*4 MIMO	2	20	898	4*4 MIMO	/	/	/	/	/	/	/	/	/	/	/	/	/	/	22.53	22.21	23.50	
CA_66B	66	10	16QAM	1	49	132622	67086	4*4 MIMO	66	10	66987	4*4 MIMO	/	/	/	/	/	/	/	/	/	/	/	/	/	/	/	22.04	21.73	23.00
CA_2A-17A	2	20	16QAM	1	50	18700	700	4*4 MIMO	17	10	5790	2*2 MIMO	/	/	/	/	/	/	/	/	/	/	/	/	/	/	/	22.53	22.13	23.50
CA_4A-17A	4	20	16QAM	1	99	20300	2300	4*4 MIMO	17	10	5790	2*2 MIMO	/	/	/	/	/	/	/	/	/	/	/	/	/	/	/	22.28	21.99	23.00
CA_5A-7A	5	10	QPSK	1	25	20450	2450	2*2 MIMO	7	20	2850	4*4 MIMO	/	/	/	/	/	/	/	/	/	/	/	/	/	/	/	23.92	23.47	25.00
7	20	16QAM	1	50	21350	3350	4*4 MIMO	5	10	2525	2*2 MIMO	/	/	/	/	/	/	/	/	/	/	/	/	/	/	/	/	20.58	20.13	21.00
CA_6B	66	20	16QAM	1	99	132072	66536	4*4 MIMO	66	20	66734	4*4 MIMO	/	/	/	/	/	/	/	/	/	/	/	/	/	/	/	22.27	21.94	23.00
CA_4A-4A-7A	4	20	16QAM	1	99	20300	2300	2*2 MIMO	4	20	2050	2*2 MIMO	7	20	3100	4*4 MIMO	/	/	/	/	/	/	/	/	/	/	/	22.28	21.81	23.00
7	20	16QAM	1	50	21350	3350	4*4 MIMO	4	20	2050	2*2 MIMO	4	10	2350	2*2 MIMO	/	/	/	/	/	/	/	/	/	/	/	/	20.58	20.23	21.00
CA_4A-12B	4	20	16QAM	1	99	20300	2300	4*4 MIMO	12	5	5095	2*2 MIMO	12	5	5143	2*2 MIMO	/	/	/	/	/	/	/	/	/	/	22.28	22.17	23.00	
CA_5A-7C	5	10	QPSK	1	25	20450	2450	2*2 MIMO	7	20	3100	4*4 MIMO	7	20	3298	2*2 MIMO	/	/	/	/	/	/	/	/	/	/	23.92	23.65	25.00	
7	20	16QAM	1	50	21350	3350	4*4 MIMO	7	20	3152	4*4 MIMO	5	10	2525	2*2 MIMO	/	/	/	/	/	/	/	/	/	/	20.58	20.33	21.00		
CA_2A-4A-5A	2	20	16QAM	1	50	18700	700	4*4 MIMO	4	20	2175	4*4 MIMO	5	10	2525	2*2 MIMO	/	/	/	/	/	/	/	/	/	/	22.53	22.23	23.50	
4	20	16QAM	1	99	20300	2300	4*4 MIMO	2	20	900	4*4 MIMO	5	10	2525	2*2 MIMO	/	/	/	/	/	/	/	/	/	/	22.28	22.05	23.00		
5	10	QPSK	1	25	20450	2450	2*2 MIMO	2	20	900	4*4 MIMO	4	20	2175	4*4 MIMO	/	/	/	/	/	/	/	/	/	/	23.92	23.66	25.00		
CA_7C-66A-66A	7	20	16QAM	1	50	21350	3350	4*4 MIMO	7	20	3152	4*4 MIMO	66	20	66536	2*2 MIMO	66	20	67036	2*2 MIMO	/	/	/	/	/	20.58	20.34	21.00		
66	20	16QAM	1	99	132072	66536	2*2 MIMO	66	20	67036	2*2 MIMO	7	20	3100	4*4 MIMO	7	20	3298	4*4 MIMO	/	/	/	/	/	22.27	21.88	23.00			
CA_2A-4A-7A-7A	2	20	16QAM	1	50	18700	700	4*4 MIMO	4	20	2175	2*2 MIMO	7	20	2850	2*2 MIMO	7	20	3350	2*2 MIMO	/	/	/	/	/	22.53	22.03	23.50		
4	20	16QAM	1	99	20300	2300	2*2 MIMO	2	20	900	4*4 MIMO	7	20	2850	2*2 MIMO	7	20	3350	2*2 MIMO	/	/	/	/	/	22.28	21.92	23.00			
7	20	16QAM	1	50	21350	3350	2*2 MIMO	7	20	2850	2*2 MIMO	2	20	900	4*4 MIMO	4	20	2175	2*2 MIMO	/	/	/	/	/	20.58	20.20	21.00			
CA_2A-4A-7C	2	20	16QAM	1	50	18700	700	4*4 MIMO	4	20	2175	4*4 MIMO	7	20	3100	2*2 MIMO	7	20	3298	2*2 MIMO	/	/	/	/	/	22.53	22.04	23.50		
4	20	16QAM	1	99	20300	2300	4*4 MIMO	2	20	900	4*4 MIMO	7	20	3100	2*2 MIMO	7	20	3298	2*2 MIMO	/	/	/	/	/	22.28	22.01	23.00			
CA_2A-4A-12A-12A	2	20	16QAM	1	50	18700	700	4*4 MIMO	4	20	2175	4*4 MIMO	12	5	5035	2*2 MIMO	12	5	5155	2*2 MIMO	/	/	/	/	/	20.58	20.30	21.00		
4	20	16QAM	1	99	20300	2300	4*4 MIMO	2	20	900	4*4 MIMO	12	5	5035	2*2 MIMO	12	5	5155	2*2 MIMO	/	/	/	/	/	22.53	22.03	23.50			
CA_2A-2A-5A-66A	2	20	16QAM	1	50	18700	700	4*4 MIMO	2	20	1100	2*2 MIMO	5	10	2525	2*2 MIMO	66	20	66786	4*4 MIMO	/	/	/	/	/	22.28	22.11	23.50		
5	10	QPSK	1	25	20450	2450	2*2 MIMO	2	20	700	2*2 MIMO	2	20	1100	2*2 MIMO	66	20	66786	4*4 MIMO	/	/	/	/	/	23.92	23.62	25.00			
66	20	16QAM	1	99	132072	66536	4*4 MIMO	66	20	700	2*2 MIMO	2	20	1100	2*2 MIMO	5	10	2525	2*2 MIMO	/	/	/	/	/	22.27	21.92	23.00			
CA_2A-7A-7A-66A	2	20	16QAM	1	50	18700	700	4*4 MIMO	7	20	2850	2*2 MIMO	7	20	3350	2*2 MIMO	66	20	66786	4*4 MIMO	/	/	/	/	/	22.53	22.23	23.50		
7	20	16QAM	1	50	21350	3350	2*2 MIMO	7	20	2850	2*2 MIMO	2	20	900	4*4 MIMO	66	20	66786	4*4 MIMO	/	/	/	/	/	20.58	20.22	21.00			
66	20	16QAM	1	99	132072	66536	2*2 MIMO	2	20	900	4*4 MIMO	7	20	2850	2*2 MIMO	7	20	3350	2*2 MIMO	/	/	/	/	/	22.27	22.03	23.00			
CA_2A-7A-66A-66A	2	20	16QAM	1	50	18700	700	2*2 MIMO	2	20	3100	4*4 MIMO	66	20	66536	2*2 MIMO	66	20	67036	2*2 MIMO	/	/	/	/	/	22.53	20.07	23.50		
66	20	16QAM	1	99	132072	66536	2*2 MIMO	66	20	66536	2*2 MIMO	66	20	67036	2*2 MIMO	66	20	67036	2*2 MIMO	/	/	/	/	/	20.58	20.30	21.00			
CA_2A-4A-7A-12A	2	20	16QAM	1	50	18700	700	4*4 MIMO	4	20	2175	4*4 MIMO	7	20	3100	2*2 MIMO	12	10	5095	2*2 MIMO	/	/	/	/	/	22.53	22.03	23.50		
4	20	16QAM	1	99	20300	2300	4*4 MIMO	2	20	900	4*4 MIMO	7	20	3100	2*2 MIMO	12	10	5095	2*2 MIMO	/	/	/	/	/	22.28	21.90	23.00			
7	20	16QAM	1	50	21350	3350	2*2 MIMO	2	20	900	4*4 MIMO	4	20	2175	4*4 MIMO	12	10	5095	2*2 MIMO	/	/	/	/	/	20.58	20.13	21.00			
CA_2A-2A-5A-66C	2	20	16QAM	1	50	18700	700	2*2 MIMO	2	20	1100	2*2 MIMO	5	10	2525	2*2 MIMO	66	20	66786	4*4 MIMO	66	20	66984	4*4 MIMO	22.53	22.07	23.50			
5	10	QPSK	1	25	20450	2450	2*2 MIMO	2	20	700	2*2 MIMO	2	20	1100	2*2 MIMO	66	20	66786	4*4 MIMO	66	20	66786	4*4 MIMO	23.92	23.73	25.00				
66	20	16QAM	1	99	132072	66536	4*4 MIMO	66	20	66734	4*4 MIMO	2	20	900	2*2 MIMO	5	10	2525	2*2 MIMO	66	20	66984	4*4 MIMO	22.27	21.98	23.00				
CA_2A-2A-7A-12A-66A	2	20	16QAM	1	50	18700	700	2*2 MIMO	2	20	1100	2*2 MIMO	7	20	3100	4*4 MIMO	12	10	5095	2*2 MIMO	66	20	66786	4*4 MIMO	22.53	22.13	23.50			
66	20	16QAM	1	99	132072	66536	2*2 MIMO	2	20	700	2*2 MIMO	2	20	1100	2*2 MIMO	7	20	3100	4*4 MIMO	12	10	5095	2*2 MIMO	20.58	20.31	21.00				
CA_2A-7A-12B-66A	2	20	16QAM	1	50	18700	700	4*4 MIMO	7	20	3100	4*4 MIMO	12	5	5143	2*2 MIMO	66	20	66786	2*2 MIMO	22.53	21.88	23.50							
7	20	QPSK	1	50	21350	3350	4*4 MIMO	2	20	900	4*4 MIMO	12	5	5143	2*2 MIMO	66	20	66786	2*2 MIMO	20.58	20.24	21.00								
66	20	16QAM	1	99	132072	66536	2*2 MIMO	2	20	900	4*4 MIMO	12	5	5095	2*2 MIMO	12	5	5143	2*2 MIMO	22.27	21.84	23.00								

Table 135: Conducted power measurement results of LTE DL 4x4 MIMO with CA(Main Antenna,Reduced Power Level D4)

LTE Band	Bandwidth /MHz	Channel	Modulation	RB Size	RB Offset	4x4 DL MIMO Tx. Power (dBm)	Single Antenna Tx. Power (dBm)	Tune-up
LTE Band 2	20	18700	QPSK	1	99	23.45	23.73	24.50
LTE Band 4	20	20050	QPSK	1	50	23.78	24.10	25.00
LTE Band 7	20	21350	QPSK	1	99	21.14	21.37	22.00
LTE Band 66	20	132572	QPSK	1	99	22.48	22.98	24.00

Table 136: Conducted power measurement results of LTE Band 2/4/7/66 DL 4x4 MIMO(Main Antenna,Reduced Power Level D5)

DL LTE CA Class	PCC				SCC1				SCC2				SCC3				SCC4				Power						
	PCC Band	PCC Bandwidth (MHz)	Modulation	PCC UL RB	PCC UL RB	PCC DL Channel	PCC DL Channel	DL Antenna Configuration	SCC Band	SCC Bandwidth (MHz)	SCC DL Channel	DL Antenna Configuration	SCC Band	SCC Bandwidth (MHz)	SCC DL Channel	DL Antenna Configuration	SCC Band	SCC Bandwidth (MHz)	SCC DL Channel	DL Antenna Configuration	SCC Band	SCC Bandwidth (MHz)	SCC DL Channel	DL Antenna Configuration	without DL 4x4MIMO Tx Power	with DL 4x4MIMO Tx Power	Tune-up
CA_2C	2	20	QPSK	1	99	18700	700	4*4 MIMO	2	20	898	4*4 MIMO	2	20	898	4*4 MIMO	2	20	898	4*4 MIMO	2	20	898	4*4 MIMO	23.33	23.03	24.50
CA_6B	66	10	QPSK	1	0	132622	67086	4*4 MIMO	66	10	66987	4*4 MIMO	66	10	66987	4*4 MIMO	66	10	66987	4*4 MIMO	66	10	66987	4*4 MIMO	22.99	22.55	24.00
CA_2A-17A	2	20	QPSK	1	99	18700	700	4*4 MIMO	17	10	5790	2*2 MIMO	17	10	5790	2*2 MIMO	17	10	5790	2*2 MIMO	17	10	5790	2*2 MIMO	23.33	22.95	24.50
CA_4A-17A	4	20	QPSK	1	50	20050	2050	4*4 MIMO	17	10	5790	2*2 MIMO	17	10	5790	2*2 MIMO	17	10	5790	2*2 MIMO	17	10	5790	2*2 MIMO	24.10	23.82	25.00
CA_5A-7A	5	10	QPSK	1	25	20450	2450	2*2 MIMO	7	20	2850	4*4 MIMO	7	20	2850	4*4 MIMO	7	20	2850	4*4 MIMO	7	20	2850	4*4 MIMO	23.92	23.44	25.00
CA_6D	66	20	QPSK	1	99	132572	67036	4*4 MIMO	66	20	2525	2*2 MIMO	66	20	2525	2*2 MIMO	66	20	2525	2*2 MIMO	66	20	2525	2*2 MIMO	21.37	20.94	22.00
CA_4A-4A-7A	4	20	QPSK	1	50	20050	2050	2*2 MIMO	4	20	2300	2*2 MIMO	4	20	2300	2*2 MIMO	4	20	2300	2*2 MIMO	4	20	2300	2*2 MIMO	22.98	22.57	24.00
CA_4A-12B	4	20	QPSK	1	99	21350	3350	4*4 MIMO	4	20	2050	2*2 MIMO	4	10	2350	2*2 MIMO	4	10	2350	2*2 MIMO	4	10	2350	2*2 MIMO	24.10	23.07	22.00
CA_5A-7C	5	10	QPSK	1	25	20450	2450	2*2 MIMO	7	20	3100	4*4 MIMO	7	20	3298	4*4 MIMO	7	20	3298	4*4 MIMO	7	20	3298	4*4 MIMO	23.92	23.61	25.00
CA_2A-4A-5A	2	20	QPSK	1	99	18700	700	4*4 MIMO	4	20	2175	4*4 MIMO	4	20	2175	4*4 MIMO	4	20	2175	4*4 MIMO	4	20	2175	4*4 MIMO	21.37	21.13	22.00
CA_7C-66A-66A	7	10	QPSK	1	99	21350	3350	4*4 MIMO	2	20	900	4*4 MIMO	4	20	2175	4*4 MIMO	66	20	67036	2*2 MIMO	66	20	67036	2*2 MIMO	23.33	23.40	24.50
CA_2A-4A-7A-7A	4	20	QPSK	1	99	18700	700	4*4 MIMO	2	20	900	4*4 MIMO	2	20	900	4*4 MIMO	2	20	900	4*4 MIMO	2	20	900	4*4 MIMO	24.10	23.80	25.00
CA_2A-4A-7C	4	20	QPSK	1	99	18700	700	4*4 MIMO	2	20	900	4*4 MIMO	2	20	900	4*4 MIMO	2	20	900	4*4 MIMO	2	20	900	4*4 MIMO	23.92	23.67	25.00
CA_2A-4A-12A-12A	2	20	QPSK	1	99	18700	700	4*4 MIMO	2	20	1100	2*2 MIMO	2	20	1100	2*2 MIMO	2	20	1100	2*2 MIMO	2	20	1100	2*2 MIMO	21.37	21.14	22.00
CA_2A-2A-5A-66A	5	10	QPSK	1	25	20450	2450	2*2 MIMO	2	20	700	2*2 MIMO	2	20	700	2*2 MIMO	66	20	66786	4*4 MIMO	66	20	66786	4*4 MIMO	23.73	23.41	24.50
CA_2A-7A-7A-66A	66	20	QPSK	1	99	132572	67036	4*4 MIMO	2	20	700	2*2 MIMO	2	20	700	2*2 MIMO	5	10	2525	2*2 MIMO	66	20	66786	4*4 MIMO	22.98	22.73	24.00
CA_2A-7A-7A-66A	2	20	QPSK	1	99	18700	700	4*4 MIMO	7	20	2850	2*2 MIMO	7	20	3350	2*2 MIMO	66	20	66786	2*2 MIMO	66	20	66786	2*2 MIMO	23.73	23.40	24.50
CA_2A-7A-66A-66A	66	20	QPSK	1	99	132572	67036	2*2 MIMO	2	20	900	4*4 MIMO	2	20	900	4*4 MIMO	66	20	66786	2*2 MIMO	66	20	66786	2*2 MIMO	21.37	21.14	22.00
CA_2A-7A-66A-66A	2	20	QPSK	1	99	18700	700	2*2 MIMO	7	20	3100	4*4 MIMO	66	20	66536	2*2 MIMO	66	20	66536	2*2 MIMO	66	20	66536	2*2 MIMO	23.73	21.34	24.50
CA_2A-7A-66A-66A	7	20	QPSK	1	99	21350	3350	4*4 MIMO	2	20	900	4*4 MIMO	2	20	900	4*4 MIMO	7	20	3100	2*2 MIMO	7	20	3100	2*2 MIMO	23.92	23.24	24.50
CA_2A-4A-7A-12A	2	20	QPSK	1	99	18700	700	4*4 MIMO	2	20	900	4*4 MIMO	2	20	900	4*4 MIMO	2	20	900	4*4 MIMO	2	20	900	4*4 MIMO	24.10	23.80	25.00
CA_2A-2A-7A-12A-66A	7	20	QPSK	1	99	21350	3350	2*2 MIMO	2	20	1100	2*2 MIMO	5	10	2525	2*2 MIMO	66	20	66786	4*4 MIMO	66	20	66786	4*4 MIMO	23.73	23.34	24.50
CA_2A-2A-7A-12A-66A	2	20	QPSK	1	99	18700	700	4*4 MIMO	4	20	2175	4*4 MIMO	7	20	3100	2*2 MIMO	12	10	5095	2*2 MIMO	12	10	5095	2*2 MIMO	24.10	23.74	25.00
CA_2A-2A-7A-12A-66A	7	20	QPSK	1	99	21350	3350	2*2 MIMO	2	20	1100	2*2 MIMO	4	20	2175	4*4 MIMO	12	10	5095	2*2 MIMO	66	20	66786	4*4 MIMO	21.37	20.92	22.00
CA_2A-2A-7A-12A-66A	2	20	QPSK	1	99	18700	700	2*2 MIMO	2	20	1100	2*2 MIMO	66	20	66786	4*4 MIMO	66	20	66786	4*4 MIMO	66	20	66786	4*4 MIMO	23.73	23.26	24.50
CA_2A-2A-7A-12A-66A	5	10	QPSK	1	25	20450	2450	2*2 MIMO	2	20	700	2*2 MIMO	66	20	66786	4*4 MIMO	66	20	66984	4*4 MIMO	66	20	66984	4*4 MIMO	23.92	23.71	25.00
CA_2A-2A-7A-12A-66A	66	20	QPSK	1	99	132572	67036	4*4 MIMO	66	20	66838	4*4 MIMO	2	20	700	2*2 MIMO	5	10	2525	2*2 MIMO	66	20	66786	4*4 MIMO	22.98	22.74	24.00
CA_2A-2A-7A-12A-66A	2	20	QPSK	1	99	18700	700	2*2 MIMO	2	20	1100	2*2 MIMO	7	20	3100	4*4 MIMO	12	10	5095	2*2 MIMO	66	20	66786	4*4 MIMO	23.73	23.32	24.50
CA_2A-2A-7A-12A-66A	7	20	QPSK	1	99	21350	3350	4*4 MIMO	2	20	700	2*2 MIMO	2	20	1100	2*2 MIMO	12	10	5095	2*2 MIMO	66	20	66786	4*4 MIMO	21.37	21.13	22.00
CA_2A-2A-7A-12B-66A	66	20	QPSK	1	99	132572	67036	2*2 MIMO	2	20	700	2*2 MIMO	2	20	1100	2*2 MIMO	7	20	3100	4*4 MIMO	12	10	5095	2*2 MIMO	22.98	22.62	24.00
CA_2A-2A-7A-12B-66A	2	20	QPSK	1	99	18700	700	4*4 MIMO	7	20	3100	4*4 MIMO	12	5	5143	2*2 MIMO	12	5	5143	2*2 MIMO	66	20	66786	4*4 MIMO	23.73	23.24	24.50
CA_2A-2A-7A-12B-66A	7	20	QPSK	1	99	21350	3350	4*4 MIMO	2	20	900	4*4 MIMO	12	5	5143	2*2 MIMO	12	5	5143	2*2 MIMO	66	20	66786	4*4 MIMO	21.37	21.13	22.00
CA_2A-2A-7A-12B-66A	66	20	QPSK	1	99	132572	67036	2*2 MIMO	2	20	900	4*4 MIMO	7	20	3100	4*4 MIMO	12	5	5095	2*2 MIMO	12	5	5143	2*2 MIMO	22.98	22.61	24.00

Table 137: Conducted power measurement results of LTE DL 4x4 MIMO with CA(Main Antenna,Reduced Power Level D5)



LTE Band	Bandwidth /MHz	Channel	Modulation	RB Size	RB Offset	4x4 DL MIMO Tx. Power (dBm)	Single Antenna Tx. Power (dBm)	Tune-up
LTE Band 2	20	18700	64QAM	1	99	20.46	20.74	21.50
LTE Band 4	20	20300	16QAM	1	0	20.58	20.90	21.50
LTE Band 7	20	21350	16QAM	1	99	20.84	21.05	21.50
LTE Band 66	20	132072	16QAM	1	0	20.31	20.61	21.50

Table 138: Conducted power measurement results of LTE Band 2/4/7/66 DL 4x4 MIMO(Main Antenna,Reduced Power Level D6/D10)

DL LTE CA Class	PCC				SCC1				SCC2				SCC3				SCC4				Power				
	PCC Band	PCC Bandwidth (MHz)	Modulation	DL Antenna Configuration	SCC Band	SCC Bandwidth (MHz)	DL Antenna Configuration	DL Antenna Configuration	SCC Band	SCC Bandwidth (MHz)	DL Antenna Configuration	DL Antenna Configuration	SCC Band	SCC Bandwidth (MHz)	DL Antenna Configuration	DL Antenna Configuration	SCC Band	SCC Bandwidth (MHz)	DL Antenna Configuration	DL Antenna Configuration	without DL 4x4MIMO Tx.Power	with DL 4x4MIMO Tx.Power	Tune-up		
CA_2C	2	20	64QAM	1 99	18700	700	4*4 MIMO	2 20	898	4*4 MIMO	/ /	/ /	/ /	/ /	/ /	/ /	/ /	/ /	/ /	/ /	20.74	20.42	21.50		
CA_66B	66	20	16QAM	1 0	132622	67086	4*4 MIMO	66 10	66987	4*4 MIMO	/ /	/ /	/ /	/ /	/ /	/ /	/ /	/ /	/ /	/ /	20.54	20.20	21.50		
CA_2A-17A	2	20	64QAM	1 99	18700	700	4*4 MIMO	17 10	5790	2*2 MIMO	/ /	/ /	/ /	/ /	/ /	/ /	/ /	/ /	/ /	/ /	20.74	20.35	21.50		
CA_4A-17A	4	20	16QAM	1 0	20300	2300	4*4 MIMO	17 10	5790	2*2 MIMO	/ /	/ /	/ /	/ /	/ /	/ /	/ /	/ /	/ /	/ /	20.90	20.60	21.50		
CA_5A-7A	5	10	QPSK	1 25	20450	2450	2*2 MIMO	7 20	2850	4*4 MIMO	/ /	/ /	/ /	/ /	/ /	/ /	/ /	/ /	/ /	/ /	23.92	23.45	25.00		
CA_66D	66	20	16QAM	1 99	132072	66536	4*4 MIMO	66 20	66734	4*4 MIMO	66 20	66932	4*4 MIMO	/ /	/ /	/ /	/ /	/ /	/ /	/ /	20.61	20.30	21.50		
CA_4A-4A-7A	4	20	16QAM	1 0	20300	2300	2*2 MIMO	4 20	2050	2*2 MIMO	7 20	3100	4*4 MIMO	/ /	/ /	/ /	/ /	/ /	/ /	/ /	20.90	20.45	21.50		
CA_4A-12B	4	20	16QAM	1 99	21350	3350	4*4 MIMO	4 20	2050	2*2 MIMO	4 10	2350	2*2 MIMO	/ /	/ /	/ /	/ /	/ /	/ /	/ /	21.05	20.75	21.50		
CA_5A-7C	5	10	QPSK	1 25	20450	2450	2*2 MIMO	7 20	3100	4*4 MIMO	7 20	3298	4*4 MIMO	/ /	/ /	/ /	/ /	/ /	/ /	/ /	20.90	20.79	21.50		
CA_2A-4A-5A	2	20	64QAM	1 99	18700	700	4*4 MIMO	4 20	2175	4*4 MIMO	5 10	2525	2*2 MIMO	/ /	/ /	/ /	/ /	/ /	/ /	/ /	20.74	20.41	21.50		
CA_7C-66A-66A	7	20	16QAM	1 99	21350	3350	4*4 MIMO	7 20	3152	4*4 MIMO	66 20	66536	2*2 MIMO	66 20	67036	2*2 MIMO	/ /	/ /	/ /	/ /	21.05	20.81	21.50		
CA_2A-7A-7A	2	20	64QAM	1 99	18700	700	4*4 MIMO	4 20	2175	4*4 MIMO	7 20	2850	2*2 MIMO	7 20	3350	4*4 MIMO	/ /	/ /	/ /	/ /	20.61	20.23	21.50		
CA_12A-12A	4	20	16QAM	1 0	20300	2300	2*2 MIMO	2 20	900	4*4 MIMO	7 20	2850	2*2 MIMO	4 20	3350	2*2 MIMO	/ /	/ /	/ /	/ /	20.90	20.55	21.50		
CA_2A-2A-5A-66A	2	20	64QAM	1 99	21350	3350	4*4 MIMO	2 20	2850	2*2 MIMO	2 20	900	4*4 MIMO	66 20	66786	4*4 MIMO	/ /	/ /	/ /	/ /	20.90	20.79	21.50		
CA_2A-7A-7A-66A	2	20	64QAM	1 99	18700	700	4*4 MIMO	4 20	2175	4*4 MIMO	7 20	3100	2*2 MIMO	7 20	3298	2*2 MIMO	/ /	/ /	/ /	/ /	20.74	20.25	21.50		
CA_2A-4A-12A-12A	2	20	64QAM	1 99	18700	700	4*4 MIMO	4 20	2175	4*4 MIMO	2 20	900	4*4 MIMO	4 20	3298	2*2 MIMO	/ /	/ /	/ /	/ /	20.90	20.60	21.50		
CA_2A-2A-5A-66A	2	20	64QAM	1 99	18700	700	2*2 MIMO	2 20	1100	2*2 MIMO	5 10	2525	2*2 MIMO	66 20	66786	4*4 MIMO	/ /	/ /	/ /	/ /	20.74	20.42	21.50		
CA_2A-7A-7A-66A	2	20	64QAM	1 99	18700	700	4*4 MIMO	2 20	700	2*2 MIMO	2 20	1100	2*2 MIMO	66 20	66786	4*4 MIMO	/ /	/ /	/ /	/ /	23.92	23.62	25.00		
CA_2A-7A-66A-66A	66	20	16QAM	1 0	132072	66536	4*4 MIMO	2 20	700	2*2 MIMO	2 20	1100	2*2 MIMO	5 10	2525	2*2 MIMO	/ /	/ /	/ /	/ /	20.61	20.36	21.50		
CA_2A-4A-7A-12A	2	20	64QAM	1 99	18700	700	4*4 MIMO	7 20	2850	2*2 MIMO	66 20	66786	2*2 MIMO	66 20	66786	4*4 MIMO	/ /	/ /	/ /	/ /	20.74	20.41	21.50		
CA_2A-2A-5A-66C	2	20	64QAM	1 99	18700	700	2*2 MIMO	2 20	1100	2*2 MIMO	2 20	900	4*4 MIMO	66 20	66786	4*4 MIMO	/ /	/ /	/ /	/ /	21.05	20.79	21.50		
CA_2A-7A-12B-66A	66	20	16QAM	1 0	132072	66536	4*4 MIMO	2 20	900	4*4 MIMO	7 20	2850	2*2 MIMO	7 20	3350	2*2 MIMO	/ /	/ /	/ /	/ /	20.61	20.35	21.50		
CA_2A-2A-7A-12A-66A	2	20	64QAM	1 99	18700	700	2*2 MIMO	2 20	1100	2*2 MIMO	7 20	3100	4*4 MIMO	66 20	66786	4*4 MIMO	/ /	/ /	/ /	/ /	20.74	20.42	21.50		
CA_2A-2A-7A-12A-66A	2	20	64QAM	1 99	18700	700	2*2 MIMO	2 20	1100	2*2 MIMO	5 10	2525	2*2 MIMO	66 20	66786	4*4 MIMO	66 20	66984	4*4 MIMO	66 20	66984	4*4 MIMO	20.74	20.25	21.50
CA_2A-7A-12B-66A	7	20	16QAM	1 99	21350	3350	4*4 MIMO	2 20	700	2*2 MIMO	2 20	1100	2*2 MIMO	12 10	5095	2*2 MIMO	66 20	66786	2*2 MIMO	66 20	66786	2*2 MIMO	21.05	20.83	21.50
CA_2A-7A-12B-66A	66	20	16QAM	1 0	132072	66536	4*4 MIMO	2 20	700	2*2 MIMO	2 20	1100	2*2 MIMO	7 20	3100	4*4 MIMO	12 10	5095	2*2 MIMO	66 20	66786	2*2 MIMO	20.61	20.25	21.50
CA_2A-7A-12B-66A	7	20	16QAM	1 99	18700	700	4*4 MIMO	7 20	3100	4*4 MIMO	12 5	5095	2*2 MIMO	66 20	66786	4*4 MIMO	66 20	66786	2*2 MIMO	66 20	66786	2*2 MIMO	20.74	20.30	21.50
CA_2A-7A-12B-66A	66	20	16QAM	1 0	132072	66536	4*4 MIMO	2 20	900	4*4 MIMO	12 5	5095	2*2 MIMO	12 5	5143	2*2 MIMO	12 5	5143	2*2 MIMO	12 5	5143	2*2 MIMO	21.05	20.81	21.50
CA_2A-7A-12B-66A	66	20	16QAM	1 0	132072	66536	4*4 MIMO	2 20	900	4*4 MIMO	7 20	3100	4*4 MIMO	12 5	5095	2*2 MIMO	12 5	5095	2*2 MIMO	12 5	5095	2*2 MIMO	20.61	20.25	21.50

Table 139: Conducted power measurement results of LTE DL 4x4 MIMO with CA for Main Antenna(Main Antenna,Reduced Power Level D6/D10)



LTE Band	Bandwidth /MHz	Channel	Modulation	RB Size	RB Offset	4x4 DL MIMO Tx. Power (dBm)	Single Antenna Tx. Power (dBm)	Tune-up
LTE Band 2	20	19100	16QAM	1	0	19.46	19.64	20.50
LTE Band 4	20	20300	64QAM	1	99	18.57	18.93	19.50
LTE Band 7	20	21350	64QAM	1	50	18.30	17.56	18.00
LTE Band 66	20	132072	16QAM	1	0	19.23	19.60	20.50

Table 140: Conducted power measurement results of LTE Band 2/4/7/66 DL 4x4 MIMO(Main Antenna,Reduced Power Level D7)

DL LTE CA Class	PCC Band	PCC Bandwidth (MHz)	Modulation	PCC			SCC1			SCC2			SCC3			SCC4			without DL 4x4MIMO Tx Power	with DL 4x4MIMO Tx Power	Tune-up														
				PCC UL RB	PCC DL RB	PCC DL Channel	SCC Band	SCC DL Channel	DL Antenna Configuration	SCC Band	SCC DL Channel	DL Antenna Configuration	SCC Band	SCC DL Channel	DL Antenna Configuration	SCC Band	SCC DL Channel	DL Antenna Configuration																	
CA_2C	2	20	16QAM	1	0	19100	1100	4*4 MIMO	2	20	902	4*4 MIMO	/	/	/	/	/	/	/	/	19.64	19.36	20.50												
CA_66B	66	10	64QAM	1	0	132022	66486	4*4 MIMO	66	10	66585	4*4 MIMO	/	/	/	/	/	/	/	/	/	/	/	19.69	19.35	20.50									
CA_2A-17A	2	20	16QAM	1	0	19100	1100	4*4 MIMO	17	10	5790	2*2 MIMO	/	/	/	/	/	/	/	/	/	/	/	/	19.64	19.26	20.50								
CA_4A-17A	4	20	64QAM	1	99	20300	2300	4*4 MIMO	17	10	5790	2*2 MIMO	/	/	/	/	/	/	/	/	/	/	/	/	/	18.93	18.63	19.50							
CA_5A-7A	5	10	QPSK	1	25	20450	2450	2*2 MIMO	7	20	2850	4*4 MIMO	/	/	/	/	/	/	/	/	/	/	/	/	/	23.92	23.46	25.00							
CA_66D	66	20	16QAM	1	0	132072	66536	4*4 MIMO	66	20	2525	2*2 MIMO	/	/	/	/	/	/	/	/	/	/	/	/	/	17.56	17.13	18.00							
CA_4A-4A-7A	4	20	64QAM	1	99	20300	2300	2*2 MIMO	4	20	2050	2*2 MIMO	7	20	3100	4*4 MIMO	/	/	/	/	/	/	/	/	/	/	18.93	18.46	19.50						
CA_4A-12B	4	20	64QAM	1	99	20300	2300	4*4 MIMO	4	20	2050	2*2 MIMO	4	10	2350	2*2 MIMO	/	/	/	/	/	/	/	/	/	/	17.56	17.26	18.00						
CA_5A-7C	5	10	QPSK	1	25	20450	2450	2*2 MIMO	7	20	3100	4*4 MIMO	7	20	3298	2*2 MIMO	/	/	/	/	/	/	/	/	/	/	18.93	18.62	19.50						
CA_2A-4A-5A	2	20	16QAM	1	0	19100	1100	4*4 MIMO	4	20	2175	4*4 MIMO	5	10	2525	2*2 MIMO	/	/	/	/	/	/	/	/	/	/	17.56	17.32	18.00						
CA_7C-66A-66A	7	20	64QAM	1	50	21350	3350	4*4 MIMO	7	20	3152	4*4 MIMO	66	20	66536	2*2 MIMO	66	20	67036	2*2 MIMO	/	/	/	/	/	/	17.56	17.32	18.00						
CA_2A-4A-7A-7A	2	20	16QAM	1	0	19100	1100	4*4 MIMO	4	20	2175	2*2 MIMO	7	20	2850	2*2 MIMO	7	20	3350	2*2 MIMO	/	/	/	/	/	/	19.64	19.20	20.50						
CA_2A-4A-7C	2	20	16QAM	1	0	19100	1100	4*4 MIMO	2	20	900	4*4 MIMO	7	20	2850	2*2 MIMO	7	20	3350	2*2 MIMO	/	/	/	/	/	/	18.93	18.61	19.50						
CA_2A-4A-12A-12A	2	20	16QAM	1	0	19100	1100	4*4 MIMO	4	20	2175	4*4 MIMO	12	5	5035	2*2 MIMO	12	5	5155	2*2 MIMO	/	/	/	/	/	/	19.64	17.29	20.50						
CA_2A-2A-5A-66A	2	20	16QAM	1	0	19100	1100	2*2 MIMO	2	20	1100	2*2 MIMO	5	10	2525	2*2 MIMO	66	20	66786	4*4 MIMO	/	/	/	/	/	/	18.93	18.60	19.50						
CA_2A-7A-7A-66A	2	20	16QAM	1	0	19100	1100	4*4 MIMO	7	20	2850	2*2 MIMO	7	20	3350	2*2 MIMO	66	20	66786	2*2 MIMO	/	/	/	/	/	/	19.64	19.31	20.50						
CA_2A-7A-66A-66A	2	20	16QAM	1	0	132072	66536	2*2 MIMO	2	20	900	4*4 MIMO	7	20	2850	2*2 MIMO	7	20	3350	2*2 MIMO	/	/	/	/	/	/	19.60	19.36	20.50						
CA_2A-4A-7A-12A	2	20	16QAM	1	0	19100	1100	4*4 MIMO	4	20	2175	4*4 MIMO	7	20	3100	2*2 MIMO	12	10	5095	2*2 MIMO	/	/	/	/	/	/	19.64	19.25	20.50						
CA_2A-2A-7A-12A-66A	2	20	16QAM	1	0	19100	1100	2*2 MIMO	2	20	1100	2*2 MIMO	5	10	2525	2*2 MIMO	66	20	66786	4*4 MIMO	66	20	66984	4*4 MIMO	19.64	19.16	20.50								
CA_2A-2A-7A-12A-66A	2	20	16QAM	1	0	132072	66536	4*4 MIMO	66	20	66932	4*4 MIMO	2	20	700	2*2 MIMO	2	20	900	2*2 MIMO	5	10	2525	2*2 MIMO	66	20	66786	4*4 MIMO	66	20	66984	4*4 MIMO	23.92	23.71	25.00
CA_2A-2A-7A-12A-66A	2	20	16QAM	1	0	19100	1100	2*2 MIMO	2	20	1100	2*2 MIMO	7	20	3100	4*4 MIMO	12	10	5095	2*2 MIMO	66	20	66786	2*2 MIMO	19.60	19.33	20.50								
CA_2A-2A-7A-12A-66A	2	20	16QAM	1	0	132072	66536	2*2 MIMO	2	20	700	2*2 MIMO	2	20	1100	2*2 MIMO	2	20	900	2*2 MIMO	12	10	5095	2*2 MIMO	66	20	66786	2*2 MIMO	17.56	17.32	18.00				
CA_2A-7A-12B-66A	2	20	16QAM	1	0	19100	1100	4*4 MIMO	7	20	3100	4*4 MIMO	12	5	5095	2*2 MIMO	12	5	5143	2*2 MIMO	66	20	66786	2*2 MIMO	19.64	19.20	20.50								
CA_2A-7A-12B-66A	66	20	16QAM	1	0	132072	66536	2*2 MIMO	2	20	900	4*4 MIMO	7	20	3100	4*4 MIMO	12	5	5095	2*2 MIMO	12	5	5143	2*2 MIMO	19.60	19.20	20.50								

Table 141: Conducted power measurement results of LTE DL 4x4 MIMO with CA(Main Antenna,Reduced Power Level D7)



LTE Band	Bandwidth/MHz	Channel	Modulation	RB Size	RB Offset	4x4 DL MIMO Tx. Power (dBm)	Single Antenna Tx. Power (dBm)	Tune-up
LTE Band 2	20	18700	64QAM	1	99	20.57	20.74	21.50
LTE Band 4	20	20300	16QAM	1	0	20.68	20.90	21.50
LTE Band 7	20	21350	64QAM	1	50	18.21	18.47	19.00
LTE Band 66	20	132072	16QAM	1	0	23.25	20.61	21.50

Table 142: Conducted power measurement results of LTE Band 2/4/7/66 DL 4x4 MIMO(Main Antenna,Reduced Power Level D8)

DL LTE CA Class	PCC Band	PCC Bandwidth (MHz)	PCC Modulation	PCC				SCC1				SCC2				SCC3				SCC4				Power		Tune-up		
				UL RB size	DL RB offset	UL Channel	DL Channel	DL Antenna Configuration	SCC Band	SCC Bandwidth (MHz)	SCC DL Channel	DL Antenna Configuration	SCC Band	SCC Bandwidth (MHz)	SCC DL Channel	DL Antenna Configuration	SCC Band	SCC Bandwidth (MHz)	SCC DL Channel	DL Antenna Configuration	SCC Band	SCC Bandwidth (MHz)	SCC DL Channel	DL Antenna Configuration	without DL 4x4MIMO Tx Power		with DL 4x4MIMO Tx Power	
CA_2C	2	20	64QAM	1	99	18700	700	4*4 MIMO	2	20	898	4*4 MIMO	/	/	/	/	/	/	/	/	/	/	/	/	/	20.74	20.42	21.50
CA_66B	66	10	16QAM	1	0	132072	67036	4*4 MIMO	66	10	66987	4*4 MIMO	/	/	/	/	/	/	/	/	/	/	/	/	/	20.54	20.20	21.50
CA_2A-17A	2	20	64QAM	1	99	18700	700	4*4 MIMO	17	10	5790	2*2 MIMO	/	/	/	/	/	/	/	/	/	/	/	/	/	20.74	20.37	21.50
CA_4A-17A	4	20	16QAM	1	0	20300	2300	4*4 MIMO	17	10	5790	2*2 MIMO	/	/	/	/	/	/	/	/	/	/	/	/	/	20.90	20.60	21.50
CA_5A-7A	5	10	QPSK	1	25	20450	2450	2*2 MIMO	7	20	2850	4*4 MIMO	/	/	/	/	/	/	/	/	/	/	/	/	/	23.92	23.49	25.00
	7	20	64QAM	1	50	21350	3350	4*4 MIMO	5	10	2525	2*2 MIMO	/	/	/	/	/	/	/	/	/	/	/	/	/	18.47	18.04	19.00
CA_6D	66	20	16QAM	1	0	132072	66536	4*4 MIMO	66	20	66734	4*4 MIMO	66	20	66932	4*4 MIMO	/	/	/	/	/	/	/	/	/	20.61	20.30	21.50
CA_4A-4A-7A	4	20	16QAM	1	0	20300	2300	2*2 MIMO	4	20	2050	2*2 MIMO	7	20	3100	4*4 MIMO	/	/	/	/	/	/	/	/	/	20.90	20.46	21.50
	7	20	64QAM	1	50	21350	3350	4*4 MIMO	4	20	2050	2*2 MIMO	4	10	2350	2*2 MIMO	/	/	/	/	/	/	/	/	/	18.47	18.17	19.00
CA_4A-12B	4	20	16QAM	1	0	20300	2300	4*4 MIMO	12	5	5095	2*2 MIMO	12	5	5143	2*2 MIMO	/	/	/	/	/	/	/	/	/	20.90	20.77	21.50
CA_5A-7C	5	10	QPSK	1	25	20450	2450	2*2 MIMO	7	20	3100	4*4 MIMO	7	20	3298	4*4 MIMO	/	/	/	/	/	/	/	/	/	23.92	23.61	25.00
	7	20	64QAM	1	50	21350	3350	4*4 MIMO	7	20	3152	4*4 MIMO	5	10	2525	2*2 MIMO	/	/	/	/	/	/	/	/	/	18.47	18.23	19.00
CA_2A-4A-5A	2	20	64QAM	1	99	18700	700	4*4 MIMO	4	20	2175	4*4 MIMO	5	10	2525	2*2 MIMO	/	/	/	/	/	/	/	/	/	20.74	20.47	21.50
	4	20	16QAM	1	0	20300	2300	4*4 MIMO	2	20	900	4*4 MIMO	5	10	2525	2*2 MIMO	/	/	/	/	/	/	/	/	/	20.90	20.80	21.50
	5	10	QPSK	1	25	20450	2450	2*2 MIMO	2	20	900	4*4 MIMO	4	20	2175	4*4 MIMO	/	/	/	/	/	/	/	/	/	23.92	23.67	25.00
CA_7C-66A-66A	7	20	64QAM	1	50	21350	3350	4*4 MIMO	7	20	3152	4*4 MIMO	66	20	66536	2*2 MIMO	66	20	67036	2*2 MIMO	/	/	/	/	/	18.47	18.23	19.00
	66	20	16QAM	1	0	132072	66536	2*2 MIMO	66	20	67036	2*2 MIMO	7	20	3100	4*4 MIMO	7	20	3298	4*4 MIMO	/	/	/	/	/	20.61	20.23	21.50
CA_2A-4A-7A-7A	2	20	64QAM	1	99	18700	700	4*4 MIMO	4	20	2175	2*2 MIMO	7	20	2850	2*2 MIMO	7	20	3350	2*2 MIMO	/	/	/	/	/	20.74	20.37	21.50
	4	20	16QAM	1	0	20300	2300	2*2 MIMO	2	20	900	4*4 MIMO	7	20	2850	2*2 MIMO	7	20	3350	2*2 MIMO	/	/	/	/	/	20.90	20.58	21.50
	7	20	64QAM	1	50	21350	3350	2*2 MIMO	7	20	2850	2*2 MIMO	2	20	900	4*4 MIMO	4	20	2175	2*2 MIMO	/	/	/	/	/	18.47	18.01	19.00
CA_2A-4A-7C	2	20	64QAM	1	99	18700	700	4*4 MIMO	4	20	2175	4*4 MIMO	7	20	3100	2*2 MIMO	7	20	3298	2*2 MIMO	/	/	/	/	/	20.74	20.25	21.50
	4	20	16QAM	1	0	20300	2300	4*4 MIMO	2	20	900	4*4 MIMO	7	20	3100	2*2 MIMO	7	20	3298	2*2 MIMO	/	/	/	/	/	20.90	20.60	21.50
	7	20	64QAM	1	50	21350	3350	2*2 MIMO	7	20	3152	2*2 MIMO	2	20	900	4*4 MIMO	4	20	2175	4*4 MIMO	/	/	/	/	/	18.47	18.19	19.00
CA_2A-4A-12A-12A	2	20	64QAM	1	99	18700	700	4*4 MIMO	4	20	2175	4*4 MIMO	12	5	5035	2*2 MIMO	12	5	5155	2*2 MIMO	/	/	/	/	/	20.74	18.37	21.50
	4	20	16QAM	1	0	20300	2300	4*4 MIMO	2	20	900	4*4 MIMO	12	5	5035	2*2 MIMO	12	5	5155	2*2 MIMO	/	/	/	/	/	20.90	20.57	21.50
CA_2A-2A-5A-66A	2	20	64QAM	1	99	18700	700	2*2 MIMO	2	20	1100	2*2 MIMO	5	10	2525	2*2 MIMO	66	20	66786	4*4 MIMO	/	/	/	/	/	20.74	20.42	21.50
	5	10	QPSK	1	25	20450	2450	2*2 MIMO	2	20	700	2*2 MIMO	2	20	1100	2*2 MIMO	66	20	66786	4*4 MIMO	/	/	/	/	/	23.92	23.62	25.00
	66	20	16QAM	1	0	132072	66536	4*4 MIMO	2	20	700	2*2 MIMO	2	20	1100	2*2 MIMO	5	10	2525	2*2 MIMO	/	/	/	/	/	20.61	20.36	21.50
CA_2A-7A-7A-66A	2	20	64QAM	1	99	18700	700	4*4 MIMO	7	20	2850	2*2 MIMO	7	20	3350	2*2 MIMO	66	20	66786	2*2 MIMO	/	/	/	/	/	20.74	20.41	21.50
	7	20	64QAM	1	50	21350	3350	2*2 MIMO	7	20	2850	2*2 MIMO	2	20	900	4*4 MIMO	66	20	66786	2*2 MIMO	/	/	/	/	/	18.47	18.21	19.00
	66	20	16QAM	1	0	132072	66536	2*2 MIMO	2	20	900	4*4 MIMO	7	20	2850	2*2 MIMO	7	20	3350	2*2 MIMO	/	/	/	/	/	20.61	20.37	21.50
CA_2A-7A-66A-66A	2	20	64QAM	1	99	18700	700	2*2 MIMO	7	20	3100	4*4 MIMO	66	20	66536	2*2 MIMO	66	20	67036	2*2 MIMO	/	/	/	/	/	20.74	18.37	21.50
	7	20	64QAM	1	50	21350	3350	4*4 MIMO	2	20	900	2*2 MIMO	66	20	66536	2*2 MIMO	66	20	67036	2*2 MIMO	/	/	/	/	/	18.47	18.21	19.00
	66	20	16QAM	1	0	132072	66536	2*2 MIMO	66	20	67036	2*2 MIMO	2	20	900	2*2 MIMO	7	20	3100	4*4 MIMO	/	/	/	/	/	20.61	20.31	21.50
CA_2A-4A-7A-12A	2	20	64QAM	1	99	18700	700	4*4 MIMO	4	20	2175	4*4 MIMO	7	20	3100	2*2 MIMO	12	10	5095	2*2 MIMO	/	/	/	/	/	20.74	20.35	21.50
	4	20	16QAM	1	0	20300	2300	4*4 MIMO	2	20	900	4*4 MIMO	7	20	3100	2*2 MIMO	12	10	5095	2*2 MIMO	/	/	/	/	/	20.90	20.58	21.50
	7	20	64QAM	1	50	21350	3350	2*2 MIMO	2	20	900	4*4 MIMO	4	20	2175	4*4 MIMO	12	10	5095	2*2 MIMO	/	/	/	/	/	18.47	18.02	19.00
CA_2A-2A-5A-66C	2	20	64QAM	1	99	18700	700	2*2 MIMO	2	20	1100	2*2 MIMO	5	10	2525	2*2 MIMO	66	20	66786	4*4 MIMO	66	20	66984	4*4 MIMO	20.74	20.27	21.50	
	5	10	QPSK	1	25	20450	2450	2*2 MIMO	2	20	700	2*2 MIMO	2	20	1100	2*2 MIMO	66	20	66786	4*4 MIMO	66	20	66984	4*4 MIMO	23.92	23.77	25.00	
	66	20	16QAM	1	0	132072	66536	4*4 MIMO	66	20	66734	4*4 MIMO	2	20	700	2*2 MIMO	2	20	900	2*2 MIMO	5	10	2525	2*2 MIMO	20.61	20.34	21.50	
CA_2A-2A-7A-12A-66A	2	20	64QAM	1	99	18700	700	2*2 MIMO	2	20	1100	2*2 MIMO	7	20	3100	4*4 MIMO	12	10	5095	2*2 MIMO	66	20	66786	2*2 MIMO	20.74	20.33	21.50	
	7	20	64QAM	1	50	21350	3350	4*4 MIMO	2	20	700	2*2 MIMO	2	20	1100	2*2 MIMO	12	10	5095	2*2 MIMO	66	20	66786	2*2 MIMO	18.47	18.23	19.00	
	66	20	16QAM	1	0	132072	66536	2*2 MIMO	2	20	700	2*2 MIMO	2	20	1100	2*2 MIMO	7	20	3100	4*4 MIMO	12	10	5095	2*2 MIMO	20.61	20.25	21.50	
CA_2A-7A-12B-66A	2	20	64QAM	1	99	18700	700	4*4 MIMO	7	20	3100	4*4 MIMO	12	5	5143	2*2 MIMO	66	20	66786	2*2 MIMO	20.74	20.37	21.50					
	7	20	64QAM	1	50	21350	3350	4*4 MIMO	2	20	900	4*4 MIMO	12	5	5095	2*2 MIMO	66	20	66786	2*2 MIMO	18.47	18.23	19.00					
	66	20	16QAM	1	0	132072	66536	2*2 MIMO	2	20	900	4*4 MIMO	7	20	3100	4*4 MIMO	12	5	5095	2*2 MIMO	12	5	5143	2*2 MIMO	20.61	20.21	21.50	

Table 143: Conducted power measurement results of LTE DL 4x4 MIMO with CA(Main Antenna,Reduced Power Level D8)

LTE Band	Bandwidth /MHz	Channel	Modulation	RB Size	RB Offset	4x4 DL MIMO Tx. Power (dBm)	Single Antenna Tx. Power (dBm)	Tune-up
LTE Band 2	20	18700	16QAM	1	50	22.31	22.53	23.50
LTE Band 4	20	20300	16QAM	1	99	21.64	21.90	22.50
LTE Band 7	20	21350	16QAM	1	50	20.15	20.58	21.00
LTE Band 66	20	132072	16QAM	1	99	21.27	21.45	22.50

Table 146: Conducted power measurement results of LTE Band 2/4/7/66 DL 4x4 MIMO(Main Antenna,Reduced Power Level D2)

DL LTE CA Class	PCC				SCC1				SCC2				SCC3				SCC4				Power				
	PCC Band	PCC Bandwidth (MHz)	Modulation	DL Antenna Configuration	SCC Band	SCC Bandwidth (MHz)	DL Antenna Configuration	DL Antenna Configuration	SCC Band	SCC Bandwidth (MHz)	DL Antenna Configuration	DL Antenna Configuration	SCC Band	SCC Bandwidth (MHz)	DL Antenna Configuration	DL Antenna Configuration	SCC Band	SCC Bandwidth (MHz)	DL Antenna Configuration	DL Antenna Configuration	without DL 4x4MIMO Tx.Power	with DL 4x4MIMO Tx.Power	Tune-up		
CA_2C	2	20	16QAM	1	50	18700	700	4*4 MIMO	2	20	898	4*4 MIMO	/	/	/	/	/	/	/	/	/	/	/	23.50	
CA_66B	66	20	16QAM	1	0	132022	66486	4*4 MIMO	66	10	66585	4*4 MIMO	/	/	/	/	/	/	/	/	/	/	/	22.22	
CA_2A-17A	2	20	16QAM	1	50	18700	700	4*4 MIMO	17	10	5790	2*2 MIMO	/	/	/	/	/	/	/	/	/	/	/	21.72	
CA_4A-17A	4	20	16QAM	1	99	20300	2300	4*4 MIMO	17	10	5790	2*2 MIMO	/	/	/	/	/	/	/	/	/	/	/	21.90	
CA_5A-7A	5	10	QPSK	1	25	20450	2450	2*2 MIMO	7	20	2850	4*4 MIMO	/	/	/	/	/	/	/	/	/	/	/	21.60	
CA_66D	66	20	16QAM	1	99	132072	66536	4*4 MIMO	66	20	66734	4*4 MIMO	66	20	66932	4*4 MIMO	/	/	/	/	/	/	/	21.45	
CA_4A-4A-7A	4	20	16QAM	1	99	20300	2300	2*2 MIMO	4	20	2050	2*2 MIMO	7	20	3100	4*4 MIMO	/	/	/	/	/	/	/	21.90	
CA_4A-12B	4	20	16QAM	1	99	20300	2300	4*4 MIMO	4	20	2050	2*2 MIMO	4	10	2350	2*2 MIMO	/	/	/	/	/	/	/	20.58	
CA_5A-7C	5	10	QPSK	1	25	20450	2450	2*2 MIMO	7	20	3100	4*4 MIMO	7	20	3298	4*4 MIMO	/	/	/	/	/	/	/	21.90	
CA_2A-4A-5A	2	20	16QAM	1	50	18700	700	4*4 MIMO	4	20	2175	4*4 MIMO	5	10	2525	2*2 MIMO	/	/	/	/	/	/	/	22.53	
CA_7C-66A-66A	66	20	16QAM	1	99	132072	66536	2*2 MIMO	66	20	67036	2*2 MIMO	66	20	67036	2*2 MIMO	/	/	/	/	/	/	/	21.45	
CA_2A-7A-7A	2	20	16QAM	1	50	18700	700	4*4 MIMO	4	20	2175	4*4 MIMO	7	20	2850	2*2 MIMO	/	/	/	/	/	/	/	22.53	
CA_2A-4A-7C	2	20	16QAM	1	50	18700	700	4*4 MIMO	4	20	2175	4*4 MIMO	7	20	3100	2*2 MIMO	/	/	/	/	/	/	/	21.90	
CA_2A-4A-12A-12A	2	20	16QAM	1	50	18700	700	4*4 MIMO	4	20	2175	4*4 MIMO	12	5	5035	2*2 MIMO	/	/	/	/	/	/	/	22.53	
CA_2A-2A-5A-66A	2	20	16QAM	1	50	18700	700	2*2 MIMO	2	20	1100	2*2 MIMO	5	10	2525	2*2 MIMO	66	20	66786	4*4 MIMO	/	/	/	22.53	
CA_2A-7A-7A-66A	66	20	16QAM	1	99	132072	66536	4*4 MIMO	66	20	66786	4*4 MIMO	66	20	66786	4*4 MIMO	/	/	/	/	/	/	/	21.45	
CA_2A-7A-66A-66A	66	20	16QAM	1	99	132072	66536	2*2 MIMO	66	20	66786	4*4 MIMO	66	20	66786	4*4 MIMO	/	/	/	/	/	/	/	22.53	
CA_2A-4A-7A-12A	2	20	16QAM	1	50	18700	700	4*4 MIMO	4	20	2175	4*4 MIMO	7	20	3100	2*2 MIMO	/	/	/	/	/	/	/	21.45	
CA_2A-2A-5A-66C	66	20	16QAM	1	99	132072	66536	4*4 MIMO	66	20	66734	4*4 MIMO	2	20	700	2*2 MIMO	2	20	1100	2*2 MIMO	5	10	2525	2*2 MIMO	21.45
CA_2A-2A-7A-12A-66A	66	20	16QAM	1	99	132072	66536	2*2 MIMO	66	20	66786	4*4 MIMO	66	20	66786	4*4 MIMO	66	20	66786	4*4 MIMO	66	20	66984	4*4 MIMO	23.92
CA_2A-7A-12B-66A	66	20	16QAM	1	99	132072	66536	2*2 MIMO	66	20	66786	4*4 MIMO	66	20	66786	4*4 MIMO	66	20	66786	4*4 MIMO	66	20	66984	4*4 MIMO	23.92

Table 147: Conducted power measurement results of LTE DL 4x4 MIMO with CA for Main Antenna(Main Antenna,Reduced Power Level D2)

LTE Band	Bandwidth /MHz	Channel	Modulation	RB Size	RB Offset	4x4 DL MIMO Tx. Power (dBm)	Single Antenna Tx. Power (dBm)	Tune-up
LTE Band 2	20	18700	QPSK	1	99	23.00	23.33	24.50
LTE Band 4	20	20050	QPSK	1	0	23.22	23.58	24.50
LTE Band 7	20	21350	QPSK	1	99	21.10	21.37	22.00
LTE Band 66	20	132072	QPSK	1	99	22.14	22.47	23.50

Table 148: Conducted power measurement results of LTE Band 2/4/7/66 DL 4x4 MIMO(Main Antenna,Reduced Power Level D3)

DL LTE CA Class	PCC Band	PCC Bandwidth (MHz)	Modulation	PCC			SCC1			SCC2			SCC3			SCC4			without DL 4x4MIMO Tx Power	with DL 4x4MIMO Tx Power	Tune-up					
				UL RB size	UL Channel	DL Channel	DL Antenna Configuration	SCC Band	SCC Bandwidth (MHz)	SCC DL Channel	DL Antenna Configuration	SCC Band	SCC Bandwidth (MHz)	SCC DL Channel	DL Antenna Configuration	SCC Band	SCC Bandwidth (MHz)	SCC DL Channel				DL Antenna Configuration				
CA_2C	2	20	QPSK	1	18700	700	4*4 MIMO	2	20	898	4*4 MIMO	/	/	/	/	/	/	/	23.33	22.97	24.50					
CA_66B	66	10	QPSK	1	132322	66786	4*4 MIMO	66	10	66885	4*4 MIMO	/	/	/	/	/	/	/	22.60	22.26	23.50					
CA_2A-17A	2	20	QPSK	1	18700	700	4*4 MIMO	17	10	5790	2*2 MIMO	/	/	/	/	/	/	/	23.33	22.87	24.50					
CA_4A-17A	4	20	QPSK	1	20050	2050	4*4 MIMO	17	10	5790	2*2 MIMO	/	/	/	/	/	/	/	23.58	23.27	24.50					
CA_5A-7A	5	10	QPSK	1	21350	3350	4*4 MIMO	5	10	2525	2*2 MIMO	/	/	/	/	/	/	/	23.92	23.48	25.00					
CA_66D	66	20	QPSK	1	132072	66536	4*4 MIMO	66	20	66734	4*4 MIMO	66	20	66932	4*4 MIMO	/	/	/	21.37	20.91	22.00					
CA_4A-4A-7A	4	20	QPSK	1	0	20050	2050	2*2 MIMO	4	20	2300	2*2 MIMO	7	20	3100	4*4 MIMO	/	/	/	22.47	22.16	23.50				
CA_4A-12B	4	20	QPSK	1	99	21350	3350	4*4 MIMO	4	20	2050	2*2 MIMO	4	10	2350	2*2 MIMO	/	/	/	23.58	23.42	24.50				
CA_5A-7C	5	10	QPSK	1	25	20450	2450	2*2 MIMO	7	20	3100	4*4 MIMO	7	20	3298	4*4 MIMO	/	/	/	23.92	23.61	25.00				
CA_2A-4A-5A	2	20	QPSK	1	99	18700	700	4*4 MIMO	4	20	2175	4*4 MIMO	5	10	2525	2*2 MIMO	/	/	/	21.37	21.11	22.00				
CA_7C-66A-66A	7	20	QPSK	1	99	132072	66536	4*4 MIMO	66	20	67036	2*2 MIMO	66	20	67036	2*2 MIMO	/	/	/	23.33	23.00	24.50				
CA_2A-4A-7A-7A	2	20	QPSK	1	99	18700	700	4*4 MIMO	4	20	2175	4*4 MIMO	7	20	2850	2*2 MIMO	7	20	3350	2*2 MIMO	/	/	/	23.58	23.22	24.50
CA_2A-4A-7C	2	20	QPSK	1	99	18700	700	4*4 MIMO	7	20	2850	2*2 MIMO	2	20	900	4*4 MIMO	4	20	2175	2*2 MIMO	/	/	/	23.33	23.22	24.50
CA_2A-4A-12A-12A	2	20	QPSK	1	99	18700	700	4*4 MIMO	4	20	2175	4*4 MIMO	12	5	5035	2*2 MIMO	12	5	5155	2*2 MIMO	/	/	/	23.92	23.62	25.00
CA_2A-2A-5A-66A	66	20	QPSK	1	99	132072	66536	4*4 MIMO	2	20	700	2*2 MIMO	2	20	1100	2*2 MIMO	5	10	2525	2*2 MIMO	/	/	/	22.47	22.17	23.50
CA_2A-7A-7A-66A	2	20	QPSK	1	99	18700	700	4*4 MIMO	7	20	2850	2*2 MIMO	66	20	66786	4*4 MIMO	/	/	/	23.33	23.00	24.50				
CA_2A-7A-66A-66A	66	20	QPSK	1	99	132072	66536	4*4 MIMO	66	20	66786	4*4 MIMO	66	20	66786	4*4 MIMO	/	/	/	21.37	21.13	22.00				
CA_2A-4A-7A-12A	2	20	QPSK	1	99	18700	700	4*4 MIMO	4	20	2175	4*4 MIMO	12	10	5095	2*2 MIMO	/	/	/	22.47	22.28	23.50				
CA_2A-2A-5A-66C	66	20	QPSK	1	99	132072	66536	4*4 MIMO	66	20	66734	4*4 MIMO	66	20	66786	4*4 MIMO	66	20	66984	4*4 MIMO	23.33	22.88	24.50			
CA_2A-2A-7A-12A-66A	66	20	QPSK	1	99	132072	66536	4*4 MIMO	66	20	66734	4*4 MIMO	66	20	66786	4*4 MIMO	66	20	66786	2*2 MIMO	22.47	22.23	23.50			
CA_2A-2A-7A-12B-66A	66	20	QPSK	1	99	132072	66536	4*4 MIMO	66	20	66734	4*4 MIMO	66	20	66786	4*4 MIMO	66	20	66786	2*2 MIMO	21.37	21.18	22.00			

Table 149: Conducted power measurement results of LTE DL 4x4 MIMO with CA for Main Antenna(Main Antenna,Reduced Power Level D3)

7.1.33 Conducted Power measurements of Uplink LTE CA

For Intra-band uplink LTE CA measurement (Uplink CA_7C, CA_38C, CA_41C), the following procedure is applied:

Maximum output power is measured for each UL CA configuration for the required test channels :

- UL PCC configuration is determined by the required test channel
- SCC and subsequent CCs are added alternatively to either side of the PCC or within the transmission band for channels at the ends of a frequency band.

The MPR information for Intra-band uplink LTE CA is as below:

For intra-band contiguous carrier aggregation the allowed Maximum Power Reduction (MPR) for the maximum output power in Table 6.2.2A.0-2 due to higher order modulation and contiguously allocated transmissions (resource blocks) is specified in Table 6.2.3A.1.3-1. In case the modulation format is different on different component carriers then the MPR is determined by the rules applied to higher order of those modulations.

Modulation	CA bandwidth Class B and C							MPR (dB)
	25 RB + 50 RB	50 RB + 50 RB	25 RB + 100 RB	50 RB + 100 RB	75 RB + 75 RB	75 RB + 100 RB	100 RB + 100 RB	
QPSK	> 8 and ≤ 25	> 12 and ≤ 50	> 8 and ≤ 25	> 12 and ≤ 50	> 16 and ≤ 75	> 16 and ≤ 75	> 18 and ≤ 100	≤ 1
QPSK	> 25	> 50	> 25	> 50	> 75	> 75	> 100	≤ 2
16 QAM	≤ 8	≤ 12	≤ 8	≤ 12	≤ 16	≤ 16	≤ 18	≤ 1
16 QAM	> 8 and ≤ 25	> 12 and ≤ 50	> 8 and ≤ 25	> 12 and ≤ 50	> 16 and ≤ 75	> 16 and ≤ 75	> 18 and ≤ 100	≤ 2
16 QAM	> 25	> 50	> 25	> 50	> 75	> 75	> 100	≤ 3

Table 150: MPR information for Uplink intra-band contiguous CA(QPSK and 16QAM)

For intra-band contiguous carrier aggregation the allowed Maximum Power Reduction (MPR) for the maximum output power in Table 6.2.2A.0-2 due to higher order modulation and contiguously aggregated transmit bandwidth configuration (resource blocks) is specified in Table 6.2.3A.1_1.3-1. In case the modulation format is different on different component carriers then the MPR is determined by the rules applied to higher order of those modulations.

Modulation	CA bandwidth Class B and C							MPR (dB)
	25 RB + 50 RB	50 RB + 50 RB	25 RB + 100 RB	50 RB + 100 RB	75 RB + 75 RB	75 RB + 100 RB	100 RB + 100 RB	
64 QAM	≤ 8 and allocation wholly contained within a single CC	≤ 12 and allocation wholly contained within a single CC	≤ 8 and allocation wholly contained within a single CC	≤ 12 and allocation wholly contained within a single CC	≤ 16 and allocation wholly contained within a single CC	≤ 16 and allocation wholly contained within a single CC	≤ 18 and allocation wholly contained within a single CC	≤ 2
64 QAM	> 8 or allocation extends across two CC's	> 12 or allocation extends across two CC's	> 8 or allocation extends across two CC's	> 12 or allocation extends across two CC's	> 16 or allocation extends across two CC's	> 16 or allocation extends across two CC's	> 18 or allocation extends across two CC's	≤ 3

Table 151: MPR information for Uplink intra-band contiguous CA(64QAM)

The UL CA conducted power measurements results are as below:



Antenna	CA Combination	Test Scenario	Modulation	PCC (UL)					SCC1 (UL)					SCC2 (DL)			conducted power (dbm)	Tune up (dbm)	
				PCC Band	PCC Bandwidth (MHz)	PCC UL RB size	PCC UL RB offset	PCC UL Channel	PCC DL Channel	SCC Band	SCC Bandwidth (MHz)	SCC UL Channel	SCC UL RB size	SCC UL RB offset	SCC Band	SCC Bandwidth (MHz)			SCC DL Channel
SEC ANT	CA_7C	Full Power	QPSK	7	20	1	0	20850	2850	7	20	21048	1	0	/	/	/	19.43	20.50
SEC ANT	CA_7C	Full Power	QPSK	7	20	1	99	21100	3100	7	20	21298	1	0	/	/	/	19.52	20.50
SEC ANT	CA_7C	Full Power	QPSK	7	20	1	0	21100	3100	7	20	20902	1	99	/	/	/	19.34	20.50
SEC ANT	CA_7C	Full Power	QPSK	7	20	1	0	21350	3350	7	20	21152	1	99	/	/	/	19.63	20.50
SEC ANT	UL CA_7C with DL CA_7C-66A	Full Power	QPSK	7	20	1	0	21350	3350	7	20	21152	1	99	66	20	132322	19.33	20.50
SEC ANT	CA_7C	Reduced Power Level D1	QPSK	7	20	1	99	20850	2850	7	20	21048	1	0	/	/	/	14.40	15.50
SEC ANT	CA_7C	Reduced Power Level D1	QPSK	7	20	1	99	21100	3100	7	20	21298	1	0	/	/	/	14.37	15.50
SEC ANT	CA_7C	Reduced Power Level D1	QPSK	7	20	1	0	21100	3100	7	20	20902	1	99	/	/	/	14.44	15.50
SEC ANT	CA_7C	Reduced Power Level D1	QPSK	7	20	1	0	21350	3350	7	20	21152	1	99	/	/	/	14.58	15.50
SEC ANT	UL CA_7C with DL CA_7C-66A	Reduced Power Level D1	QPSK	7	20	1	0	21350	3350	7	20	21152	1	99	66	20	132322	14.49	15.50
SEC ANT	CA_7C	Reduced Power Level D3	QPSK	7	20	1	99	20850	2850	7	20	21048	1	0	/	/	/	12.33	13.50
SEC ANT	CA_7C	Reduced Power Level D3	QPSK	7	20	1	99	21100	3100	7	20	21298	1	0	/	/	/	12.56	13.50
SEC ANT	CA_7C	Reduced Power Level D3	QPSK	7	20	1	0	21100	3100	7	20	20902	1	99	/	/	/	12.25	13.50
SEC ANT	CA_7C	Reduced Power Level D3	QPSK	7	20	1	0	21350	3350	7	20	21152	1	99	/	/	/	12.68	13.50
SEC ANT	UL CA_7C with DL CA_7C-66A	Reduced Power Level D3	QPSK	7	20	1	0	21350	3350	7	20	21152	1	99	66	20	132322	12.46	13.50
SEC ANT	CA_7C	Reduced Power Level D2	QPSK	7	20	1	99	20850	2850	7	20	21048	1	0	/	/	/	17.48	18.50
SEC ANT	CA_7C	Reduced Power Level D2	QPSK	7	20	1	99	21100	3100	7	20	21298	1	0	/	/	/	17.52	18.50
SEC ANT	CA_7C	Reduced Power Level D2	QPSK	7	20	1	0	21100	3100	7	20	20902	1	99	/	/	/	17.38	18.50
SEC ANT	CA_7C	Reduced Power Level D2	QPSK	7	20	1	0	21350	3350	7	20	21152	1	99	/	/	/	17.63	18.50
SEC ANT	UL CA_7C with DL CA_7C-66A	Reduced Power Level D2	QPSK	7	20	1	0	21350	3350	7	20	21152	1	99	66	20	132322	17.58	18.50
MAIN ANT	CA_7C	Full Power	QPSK	7	20	1	99	20850	2850	7	20	21048	1	0	/	/	/	23.10	24.50
MAIN ANT	CA_7C	Full Power	QPSK	7	20	1	99	21100	3100	7	20	21298	1	0	/	/	/	23.20	24.50
MAIN ANT	CA_7C	Full Power	QPSK	7	20	1	0	21100	3100	7	20	20902	1	99	/	/	/	23.18	24.50
MAIN ANT	CA_7C	Full Power	QPSK	7	20	1	0	21350	3350	7	20	21152	1	99	/	/	/	23.53	24.50
MAIN ANT	UL CA_7C with DL CA_7C-66A	Full Power	QPSK	7	20	1	0	21350	3350	7	20	21152	1	99	66	20	132322	23.41	24.50
MAIN ANT	CA_7C	Reduced Power Level D2/D4	QPSK	7	20	1	99	20850	2850	7	20	21048	1	0	/	/	/	19.80	21.00
MAIN ANT	CA_7C	Reduced Power Level D2/D4	QPSK	7	20	1	99	21100	3100	7	20	21298	1	0	/	/	/	20.12	21.00
MAIN ANT	CA_7C	Reduced Power Level D2/D4	QPSK	7	20	1	0	21100	3100	7	20	20902	1	99	/	/	/	19.87	21.00
MAIN ANT	CA_7C	Reduced Power Level D2/D4	QPSK	7	20	1	0	21350	3350	7	20	21152	1	99	/	/	/	20.13	21.00
MAIN ANT	UL CA_7C with DL CA_7C-66A	Reduced Power Level D2/D4	QPSK	7	20	1	0	21350	3350	7	20	21152	1	99	66	20	132322	19.98	21.00
MAIN ANT	CA_7C	Reduced Power Level D3/D5	QPSK	7	20	1	99	20850	2850	7	20	21048	1	0	/	/	/	20.77	22.00
MAIN ANT	CA_7C	Reduced Power Level D3/D5	QPSK	7	20	1	99	21100	3100	7	20	21298	1	0	/	/	/	21.14	22.00
MAIN ANT	CA_7C	Reduced Power Level D3/D5	QPSK	7	20	1	0	21100	3100	7	20	20902	1	99	/	/	/	20.92	22.00
MAIN ANT	CA_7C	Reduced Power Level D3/D5	QPSK	7	20	1	0	21350	3350	7	20	21152	1	99	/	/	/	21.19	22.00
MAIN ANT	UL CA_7C with DL CA_7C-66A	Reduced Power Level D3/D5	QPSK	7	20	1	0	21350	3350	7	20	21152	1	99	66	20	132322	21.09	22.00
MAIN ANT	CA_7C	Reduced Power Level D6/D10	QPSK	7	20	1	99	20850	2850	7	20	21048	1	0	/	/	/	20.25	21.50
MAIN ANT	CA_7C	Reduced Power Level D6/D10	QPSK	7	20	1	99	21100	3100	7	20	21298	1	0	/	/	/	20.61	21.50
MAIN ANT	CA_7C	Reduced Power Level D6/D10	QPSK	7	20	1	0	21100	3100	7	20	20902	1	99	/	/	/	20.35	21.50
MAIN ANT	CA_7C	Reduced Power Level D6/D10	QPSK	7	20	1	0	21350	3350	7	20	21152	1	99	/	/	/	20.62	21.50
MAIN ANT	UL CA_7C with DL CA_7C-66A	Reduced Power Level D6/D10	QPSK	7	20	1	0	21350	3350	7	20	21152	1	99	66	20	132322	20.41	21.50
MAIN ANT	CA_7C	Reduced Power Level D7	QPSK	7	20	1	99	20850	2850	7	20	21048	1	0	/	/	/	16.61	18.00
MAIN ANT	CA_7C	Reduced Power Level D7	QPSK	7	20	1	99	21100	3100	7	20	21298	1	0	/	/	/	17.10	18.00
MAIN ANT	CA_7C	Reduced Power Level D7	QPSK	7	20	1	0	21100	3100	7	20	20902	1	99	/	/	/	16.66	18.00
MAIN ANT	CA_7C	Reduced Power Level D7	QPSK	7	20	1	0	21350	3350	7	20	21152	1	99	/	/	/	17.12	18.00
MAIN ANT	UL CA_7C with DL CA_7C-66A	Reduced Power Level D7	QPSK	7	20	1	0	21350	3350	7	20	21152	1	99	66	20	132322	16.99	18.00
MAIN ANT	CA_7C	Reduced Power Level D8	QPSK	7	20	1	99	20850	2850	7	20	21048	1	0	/	/	/	17.74	19.00
MAIN ANT	CA_7C	Reduced Power Level D8	QPSK	7	20	1	99	21100	3100	7	20	21298	1	0	/	/	/	18.06	19.00
MAIN ANT	CA_7C	Reduced Power Level D8	QPSK	7	20	1	0	21100	3100	7	20	20902	1	99	/	/	/	17.77	19.00
MAIN ANT	CA_7C	Reduced Power Level D8	QPSK	7	20	1	0	21350	3350	7	20	21152	1	99	/	/	/	18.12	19.00
MAIN ANT	UL CA_7C with DL CA_7C-66A	Reduced Power Level D8	QPSK	7	20	1	0	21350	3350	7	20	21152	1	99	66	20	132322	18.01	19.00
SEC ANT	CA_38C	Full Power	QPSK	38	20	1	99	37850	37850	38	20	38048	1	0	/	/	/	22.46	23.50
SEC ANT	CA_38C	Full Power	QPSK	38	20	1	0	38150	38150	38	20	37952	1	99	/	/	/	22.45	23.50
SEC ANT	CA_38C	Reduced Power Level D1	QPSK	38	20	1	99	37850	37850	38	20	38048	1	0	/	/	/	18.18	19.00
SEC ANT	CA_38C	Reduced Power Level D1	QPSK	38	20	1	0	38150	38150	38	20	37952	1	99	/	/	/	18.14	19.00
SEC ANT	CA_38C	Reduced Power Level D3	QPSK	38	20	1	99	37850	37850	38	20	38048	1	0	/	/	/	17.22	18.00
SEC ANT	CA_38C	Reduced Power Level D3	QPSK	38	20	1	0	38150	38150	38	20	37952	1	99	/	/	/	17.15	18.00
SEC ANT	CA_38C	Reduced Power Level D2	QPSK	38	20	1	99	37850	37850	38	20	38048	1	0	/	/	/	21.64	22.50
SEC ANT	CA_38C	Reduced Power Level D2	QPSK	38	20	1	0	38150	38150	38	20	37952	1	99	/	/	/	21.63	22.50

MAIN ANT	CA_38C	Full Power	QPSK	38	20	1	99	37850	37850	38	20	38048	1	0	/	/	/	23.88	25.00
MAIN ANT	CA_38C	Full Power	QPSK	38	20	1	0	38150	38150	38	20	37952	1	99	/	/	/	23.86	25.00
MAIN ANT	CA_38C	Reduced Power Level D2/D4/D6/D10	QPSK	38	20	1	99	37850	37850	38	20	38048	1	0	/	/	/	22.19	23.00
MAIN ANT	CA_38C	Reduced Power Level D2/D4/D6/D10	QPSK	38	20	1	0	38150	38150	38	20	37952	1	99	/	/	/	22.16	23.00
MAIN ANT	CA_38C	Reduced Power Level D3/D5	QPSK	38	20	1	99	37850	37850	38	20	38048	1	0	/	/	/	23.03	24.00
MAIN ANT	CA_38C	Reduced Power Level D3/D5	QPSK	38	20	1	0	38150	38150	38	20	37952	1	99	/	/	/	23.01	24.00
MAIN ANT	CA_38C	Reduced Power Level D7	QPSK	38	20	1	99	37850	37850	38	20	38048	1	0	/	/	/	19.99	21.00
MAIN ANT	CA_38C	Reduced Power Level D7	QPSK	38	20	1	0	38150	38150	38	20	37952	1	99	/	/	/	19.98	21.00
MAIN ANT	CA_38C	Reduced Power Level D8	QPSK	38	20	1	99	37850	37850	38	20	38048	1	0	/	/	/	21.13	22.00
MAIN ANT	CA_38C	Reduced Power Level D8	QPSK	38	20	1	0	38150	38150	38	20	37952	1	99	/	/	/	21.11	22.00
SEC ANT	CA_41C	Full Power	QPSK	41	20	1	99	40140	40140	41	20	40338	1	0	/	/	/	22.55	23.50
SEC ANT	CA_41C	Full Power	QPSK	41	20	1	0	40473	40473	41	20	40671	1	0	/	/	/	22.48	23.50
SEC ANT	CA_41C	Full Power	QPSK	41	20	1	99	40473	40473	41	20	40275	1	99	/	/	/	22.51	23.50
SEC ANT	CA_41C	Full Power	QPSK	41	20	1	0	40807	40807	41	20	41005	1	0	/	/	/	22.29	23.50
SEC ANT	CA_41C	Full Power	QPSK	41	20	1	0	40807	40807	41	20	40609	1	99	/	/	/	22.33	23.50
SEC ANT	CA_41C	Full Power	QPSK	41	20	1	0	41140	41140	41	20	40942	1	99	/	/	/	22.32	23.50
SEC ANT	UL CA_41C With DL CA_41D	Full Power	QPSK	41	20	1	0	41140	41140	41	20	40942	1	99	41	20	40744	22.51	23.50
SEC ANT	CA_41C	Reduced Power Level D1	QPSK	41	20	1	99	40140	40140	41	20	40338	1	0	/	/	/	17.65	18.50
SEC ANT	CA_41C	Reduced Power Level D1	QPSK	41	20	1	0	40473	40473	41	20	40671	1	0	/	/	/	17.44	18.50
SEC ANT	CA_41C	Reduced Power Level D1	QPSK	41	20	1	99	40473	40473	41	20	40275	1	99	/	/	/	17.64	18.50
SEC ANT	CA_41C	Reduced Power Level D1	QPSK	41	20	1	0	40807	40807	41	20	41005	1	0	/	/	/	17.22	18.50
SEC ANT	CA_41C	Reduced Power Level D1	QPSK	41	20	1	0	40807	40807	41	20	40609	1	99	/	/	/	17.35	18.50
SEC ANT	CA_41C	Reduced Power Level D1	QPSK	41	20	1	0	41140	41140	41	20	40942	1	99	/	/	/	17.43	18.50
SEC ANT	UL CA_41C With DL CA_41D	Reduced Power Level D1	QPSK	41	20	1	99	40140	40140	41	20	40338	1	0	41	20	40744	17.48	18.50
SEC ANT	CA_41C	Reduced Power Level D3	QPSK	41	20	1	99	40140	40140	41	20	40338	1	0	/	/	/	15.58	16.50
SEC ANT	CA_41C	Reduced Power Level D3	QPSK	41	20	1	0	40473	40473	41	20	40671	1	0	/	/	/	15.35	16.50
SEC ANT	CA_41C	Reduced Power Level D3	QPSK	41	20	1	99	40473	40473	41	20	40275	1	99	/	/	/	15.56	16.50
SEC ANT	CA_41C	Reduced Power Level D3	QPSK	41	20	1	0	40807	40807	41	20	41005	1	0	/	/	/	14.89	16.50
SEC ANT	CA_41C	Reduced Power Level D3	QPSK	41	20	1	0	40807	40807	41	20	40609	1	99	/	/	/	15.51	16.50
SEC ANT	CA_41C	Reduced Power Level D3	QPSK	41	20	1	0	41140	41140	41	20	40942	1	99	/	/	/	15.35	16.50
SEC ANT	UL CA_41C With DL CA_41D	Reduced Power Level D3	QPSK	41	20	1	99	40140	40140	41	20	40338	1	0	41	20	40536	15.42	16.50
SEC ANT	CA_41C	Reduced Power Level D2	QPSK	41	20	1	99	40140	40140	41	20	40338	1	0	/	/	/	20.71	21.50
SEC ANT	CA_41C	Reduced Power Level D2	QPSK	41	20	1	0	40473	40473	41	20	40671	1	0	/	/	/	20.60	21.50
SEC ANT	CA_41C	Reduced Power Level D2	QPSK	41	20	1	99	40473	40473	41	20	40275	1	99	/	/	/	20.37	21.50
SEC ANT	CA_41C	Reduced Power Level D2	QPSK	41	20	1	0	40807	40807	41	20	41005	1	0	/	/	/	20.31	21.50
SEC ANT	CA_41C	Reduced Power Level D2	QPSK	41	20	1	0	40807	40807	41	20	40609	1	99	/	/	/	20.32	21.50
SEC ANT	CA_41C	Reduced Power Level D2	QPSK	41	20	1	0	41140	41140	41	20	40942	1	99	/	/	/	20.35	21.50
SEC ANT	UL CA_41C With DL CA_41D	Reduced Power Level D2	QPSK	41	20	1	99	40140	40140	41	20	40338	1	0	41	20	40536	20.36	21.50
MAIN ANT	CA_41C	Full Power	QPSK	41	20	1	99	40140	40140	41	20	40338	1	0	/	/	/	24.15	25.00
MAIN ANT	CA_41C	Full Power	QPSK	41	20	1	0	40473	40473	41	20	40671	1	0	/	/	/	23.84	25.00
MAIN ANT	CA_41C	Full Power	QPSK	41	20	1	99	40473	40473	41	20	40275	1	99	/	/	/	24.00	25.00
MAIN ANT	CA_41C	Full Power	QPSK	41	20	1	0	40807	40807	41	20	41005	1	0	/	/	/	23.79	25.00
MAIN ANT	CA_41C	Full Power	QPSK	41	20	1	0	40807	40807	41	20	40609	1	99	/	/	/	23.83	25.00
MAIN ANT	CA_41C	Full Power	QPSK	41	20	1	0	41140	41140	41	20	40942	1	99	/	/	/	24.08	25.00
MAIN ANT	UL CA_41C With DL CA_41D	Full Power	QPSK	41	20	1	99	40140	40140	41	20	40338	1	0	41	20	40536	24.02	25.00
MAIN ANT	CA_41C	Reduced Power Level D6/D7/D8/D10	QPSK	41	20	1	99	40140	40140	41	20	40338	1	0	/	/	/	22.20	23.00
MAIN ANT	CA_41C	Reduced Power Level D6/D7/D8/D10	QPSK	41	20	1	0	40473	40473	41	20	40671	1	0	/	/	/	21.86	23.00
MAIN ANT	CA_41C	Reduced Power Level D6/D7/D8/D10	QPSK	41	20	1	99	40473	40473	41	20	40275	1	99	/	/	/	22.12	23.00
MAIN ANT	CA_41C	Reduced Power Level D6/D7/D8/D10	QPSK	41	20	1	0	40807	40807	41	20	41005	1	0	/	/	/	22.04	23.00
MAIN ANT	CA_41C	Reduced Power Level D6/D7/D8/D10	QPSK	41	20	1	0	40807	40807	41	20	40609	1	99	/	/	/	21.87	23.00
MAIN ANT	CA_41C	Reduced Power Level D6/D7/D8/D10	QPSK	41	20	1	0	41140	41140	41	20	40942	1	99	/	/	/	22.14	23.00
MAIN ANT	UL CA_41C With DL CA_41D	Reduced Power Level D6/D7/D8/D10	QPSK	41	20	1	99	40140	40140	41	20	40338	1	0	41	20	40536	22.11	23.00
MAIN ANT	CA_41C	Reduced Power Level D1/D2/D3/D9	QPSK	41	20	1	99	40140	40140	41	20	40338	1	0	/	/	/	23.68	24.50
MAIN ANT	CA_41C	Reduced Power Level D1/D2/D3/D9	QPSK	41	20	1	0	40473	40473	41	20	40671	1	0	/	/	/	23.46	24.50
MAIN ANT	CA_41C	Reduced Power Level D1/D2/D3/D9	QPSK	41	20	1	99	40473	40473	41	20	40275	1	99	/	/	/	23.67	24.50
MAIN ANT	CA_41C	Reduced Power Level D1/D2/D3/D9	QPSK	41	20	1	0	40807	40807	41	20	41005	1	0	/	/	/	23.33	24.50
MAIN ANT	CA_41C	Reduced Power Level D1/D2/D3/D9	QPSK	41	20	1	0	40807	40807	41	20	40609	1	99	/	/	/	23.41	24.50
MAIN ANT	CA_41C	Reduced Power Level D1/D2/D3/D9	QPSK	41	20	1	0	41140	41140	41	20	40942	1	99	/	/	/	23.63	24.50
MAIN ANT	UL CA_41C With DL CA_41D	Reduced Power Level D1/D2/D3/D9	QPSK	41	20	1	99	40140	40140	41	20	40338	1	0	41	20	40536	23.35	24.50

Table 152: Additional Conducted Power test results of UL intra-band CA

Note: For uplink CA, additional SAR test is only required on the uplink CA configurations with 2 component carriers downlink. Additional SAR test is not required for uplink CA configurations with 3~4 component carriers downlink because the highest UL CA output power configuration with 3~4 component carriers downlink is $\frac{1}{4}$ dB higher than the same UL CA output power configuration with 2 component carriers downlink.

7.1.34 Conducted power measurements of WiFi 2.4G

Mode	Antenna	Channel	Frequency (MHz)	Data Rate (Mbps)	Tune-up	Average Power (dBm)
					Max.	
802.11b	Ant3(Core0)	1	2412	1Mbps	14.50	13.33
		6	2437		14.50	13.46
		11	2462		14.50	13.19
	Ant4(Core1)	1	2412	1Mbps	14.50	12.68
		6	2437		14.50	12.83
		11	2462		14.50	12.51
802.11g SISO	Ant3(Core0)	1	2412	6Mbps	11.50	9.58
		2	2417		11.50	9.58
		3	2422		14.50	12.61
		6	2437		14.50	12.62
		9	2452		14.50	12.60
		10	2457		10.00	7.25
		11	2462		8.50	5.69
	Ant4(Core1)	1	2412	6Mbps	11.50	9.43
		2	2417		11.50	9.52
		3	2422		14.50	12.30
		6	2437		14.50	12.31
		9	2452		14.50	11.99
		10	2457		10.00	7.48
		11	2462		8.50	6.02
802.11n SISO 20M	Ant3(Core0)	1	2412	MCS0	11.50	9.51
		2	2417		11.50	9.79
		3	2422		14.50	12.53
		6	2437		14.50	12.59
		9	2452		14.50	12.64
		10	2457		10.00	7.26
		11	2462		8.50	5.84
	Ant4(Core1)	1	2412	MCS0	11.50	9.35
		2	2417		11.50	9.28
		3	2422		14.50	12.23
		6	2437		14.50	12.19
		9	2452		14.50	11.97
		10	2457		10.00	7.39
		11	2462		8.50	5.97
802.11n SISO 40M	Ant3(Core0)	3	2422	MCS0	7.00	5.10
		4	2427		8.50	6.51
		5	2432		14.50	12.51
		6	2437		14.50	12.67
		7	2442		8.00	6.02
		8	2447		7.00	5.11
		9	2452		6.50	5.10
	Ant4(Core1)	3	2422	MCS0	7.00	5.01
		4	2427		8.50	6.51
		5	2432		14.50	12.68
		6	2437		14.50	12.76
		7	2442		8.00	6.02
		8	2447		7.00	5.01
		9	2452		6.50	4.75

Table 153: Conducted power measurement results of WiFi 2.4G SISO (Receiver on)

Mode	Antenna	Channel	Frequency (MHz)	Data Rate (Mbps)	Tune-up	Average Power (dBm)
					Max.	
802.11b	Ant3(Core0)	1	2412	1Mbps	18.00	16.61
		6	2437		18.00	16.48
		11	2462		18.00	16.36
	Ant4(Core1)	1	2412	1Mbps	17.00	15.27
		6	2437		17.00	15.04
		11	2462		17.00	15.01
802.11g SISO	Ant3(Core0)	1	2412	6Mbps	11.50	10.46
		2	2417		11.50	10.55
		3	2422		18.00	16.23
		6	2437		18.00	16.34
		9	2452		18.00	16.19
		10	2457		10.00	9.21
		11	2462		8.50	7.02
	Ant4(Core1)	1	2412	6Mbps	11.50	9.80
		2	2417		11.50	9.83
		3	2422		17.00	15.15
		6	2437		17.00	15.19
		9	2452		17.00	15.01
		10	2457		10.00	8.30
		11	2462		8.50	6.83
802.11n SISO 20M	Ant3(Core0)	1	2412	MCS0	11.50	9.70
		2	2417		11.50	9.73
		3	2422		17.00	15.20
		6	2437		17.00	14.97
		9	2452		17.00	15.15
		10	2457		10.00	7.28
		11	2462		8.50	5.80
	Ant4(Core1)	1	2412	MCS0	11.50	9.36
		2	2417		11.50	9.57
		3	2422		16.00	13.81
		6	2437		16.00	13.83
		9	2452		16.00	13.43
		10	2457		10.00	7.30
		11	2462		8.50	6.03
802.11n SISO 40M	Ant3(Core0)	3	2422	MCS0	7.00	4.90
		4	2427		8.50	6.04
		5	2432		15.50	13.28
		6	2437		15.50	13.32
		7	2442		8.00	5.15
		8	2447		7.00	4.46
		9	2452		6.50	4.59
	Ant4(Core1)	3	2422	MCS0	7.00	4.17
		4	2427		8.50	5.85
		5	2432		14.50	12.71
		6	2437		14.50	12.64
		7	2442		8.00	4.94
		8	2447		7.00	3.97
		9	2452		6.50	4.86

Table 154: Conducted power measurement results of WiFi 2.4G SISO (Receiver off)

Mode	Antenna	Channel	Frequency(MHz)	Data Rate (Mbps)	Tune-up	Average Power (dBm)
					Max.	
802.11g CDD	Ant3(Core0)	1	2412	6Mbps	11.50	9.58
		2	2417		11.50	9.58
		3	2422		14.50	12.61
		6	2437		14.50	12.62
		9	2452		14.50	12.60
		10	2457		10.00	7.25
		11	2462		8.50	5.69
	Ant4(Core1)	1	2412		11.50	9.43
		2	2417		11.50	9.52
		3	2422		14.50	12.30
		6	2437		14.50	12.31
		9	2452		14.50	11.99
		10	2457		10.00	7.48
		11	2462		8.50	6.02
	Sum	1	2412		14.51	12.52
		2	2417		14.51	12.56
		3	2422		17.51	15.47
		6	2437		17.51	15.48
		9	2452		17.51	15.32
		10	2457		13.01	10.38
		11	2462		11.51	8.87
	802.11n MIMO 20M	Ant3(Core0)	1		2412	MCS8
2			2417	11.50	9.79	
3			2422	14.50	12.53	
6			2437	14.50	12.59	
9			2452	14.50	12.64	
10			2457	10.00	7.26	
11			2462	8.50	5.84	
Ant4(Core1)		1	2412	11.50	9.35	
		2	2417	11.50	9.28	
		3	2422	14.50	12.23	
		6	2437	14.50	12.19	
		9	2452	14.50	11.97	
		10	2457	10.00	7.39	
		11	2462	8.50	5.97	
Sum		1	2412	14.51	12.44	
		2	2417	14.51	12.55	
		3	2422	17.51	15.39	
		6	2437	17.51	15.40	
		9	2452	17.51	15.33	
		10	2457	13.01	10.34	
		11	2462	11.51	8.92	

802.11n MIMO 40M	Ant3(Core0)	3	2422	MCS8	7.00	5.10	
		4	2427		8.50	6.51	
		5	2432		14.50	12.51	
		6	2437		14.50	12.67	
		7	2442		8.00	6.02	
		8	2447		7.00	5.11	
	Ant4(Core1)	9	2452		6.50	5.10	
		3	2422		7.00	5.01	
		4	2427		8.50	6.51	
		5	2432		14.50	12.68	
		6	2437		14.50	12.76	
		7	2442		8.00	6.02	
	Sum	8	2447		7.00	5.01	
		9	2452		6.50	4.75	
		3	2422		10.01	8.07	
		4	2427		11.51	9.52	
		5	2432		17.51	15.61	
		6	2437		17.51	15.73	
			7		2442	11.01	9.03
			8		2447	10.01	8.07
			9		2452	9.51	7.94

Table 155: Conducted power measurement results of WiFi 2.4G CDD/MIMO (Receiver ON)

Mode	Antenna	Channel	Frequency(MHz)	Data Rate (Mbps)	Tune-up	Average Power (dBm)	
					Max.		
802.11g CDD	Ant3(Core0)	1	2412	6Mbps	11.50	10.46	
		2	2417		11.50	10.55	
		3	2422		18.00	16.23	
		6	2437		18.00	16.34	
		9	2452		18.00	16.19	
		10	2457		10.00	9.21	
	Ant4(Core1)	11	2462		8.50	7.02	
		1	2412		11.50	9.80	
		2	2417		11.50	9.83	
		3	2422		17.00	15.15	
		6	2437		17.00	15.19	
		9	2452		17.00	15.01	
	Sum	10	2457		10.00	8.30	
		11	2462		8.50	6.83	
		1	2412		14.51	13.15	
		2	2417		14.51	13.22	
		3	2422		20.54	18.73	
		6	2437		20.54	18.81	
			9		2452	20.54	18.65
			10		2457	13.01	11.79
			11		2462	11.51	9.94

802.11n MIMO 20M	Ant3(Core0)	1	2412	MCS0	11.50	9.70
		2	2417		11.50	9.73
		3	2422		17.00	15.20
		6	2437		17.00	14.97
		9	2452		17.00	15.15
		10	2457		10.00	7.28
		11	2462		8.50	5.80
	Ant4(Core1)	1	2412		11.50	9.36
		2	2417		11.50	9.57
		3	2422		16.00	13.81
		6	2437		16.00	13.83
		9	2452		16.00	13.43
		10	2457		10.00	7.30
	Sum	11	2462		8.50	6.03
		1	2412		14.51	12.54
		2	2417		14.51	12.66
		3	2422		19.54	17.57
		6	2437		19.54	17.45
		9	2452		19.54	17.38
		10	2457		13.01	10.30
	802.11n MIMO 40M	Ant3(Core0)	11		2462	11.51
3			2422	7.00	4.90	
4			2427	8.50	6.04	
5			2432	15.50	13.28	
6			2437	15.50	13.32	
7			2442	8.00	5.15	
8			2447	7.00	4.46	
Ant4(Core1)		9	2452	6.50	4.59	
		3	2422	7.00	4.17	
		4	2427	8.50	5.85	
		5	2432	14.50	12.71	
		6	2437	14.50	12.64	
		7	2442	8.00	4.94	
		8	2447	7.00	3.97	
Sum		9	2452	6.50	4.86	
		3	2422	10.01	7.56	
		4	2427	11.51	8.96	
		5	2432	18.04	16.01	
		6	2437	18.04	16.00	
		7	2442	11.01	8.06	
		8	2447	10.01	7.23	
MCS0	9	2452	9.51	7.74		

Table 156: Conducted power measurement results of WiFi 2.4G CDD/MIMO (Receiver Off)

Note:

- 1) The Average conducted power of WiFi is measured with RMS detector.
- 2) As different maximum tune-up output power is specified across the different channels range. So the additional conducted power measurement for the adjacent channel of each power level stage is also performed in this report to ensure compliance.
- 3) The MCC should be set to the FCC mobile country code. WIFI SAR Test should be evaluated at the power level of FCC mobile country code for each exposure conditions.

7.1.35 Conducted power measurements of WiFi 5G

Mode	Antenna	Channel	Frequency (MHz)	Data Rate (Mbps)	Tune-up	Average Power (dBm)	
					Max.		
802.11a	Ant3(Core0)	CH 36	5180	6Mbps	10.50	9.16	
		CH 40	5200		11.00	10.43	
		CH 44	5220		11.00	10.35	
		CH 48	5240		11.00	9.38	
		CH 52	5260		11.00	9.75	
		CH 56	5280		11.00	10.04	
		CH 60	5300		11.00	10.10	
		CH 64	5320		10.50	9.11	
		CH 100	5500		10.50	8.79	
		CH 104	5520		11.00	9.18	
		CH 108	5540		11.00	9.02	
		CH 112	5560		11.00	9.27	
		CH 116	5580		11.00	9.44	
		CH 120	5600		11.00	9.67	
		CH 124	5620		11.00	10.07	
		CH 128	5640		11.00	10.39	
		CH 132	5660		11.00	10.22	
		CH 136	5680		11.00	10.12	
		CH 140	5700		11.00	9.82	
		CH 149	5745		11.00	9.48	
	CH 153	5765	11.00	9.28			
	CH 157	5785	11.00	9.17			
	CH 161	5805	11.00	9.16			
	CH 165	5825	11.00	9.81			
		Ant4(Core1)	CH 36	5180	6Mbps	10.50	7.55
			CH 40	5200		11.00	7.97
			CH 44	5220		11.00	8.72
			CH 48	5240		11.00	9.04
			CH 52	5260		11.00	9.07
			CH 56	5280		11.00	8.82
			CH 60	5300		11.00	8.54
			CH 64	5320		10.50	7.37
			CH 100	5500		10.50	8.54
			CH 104	5520		11.00	9.15
	CH 108		5540	11.00		9.10	
	CH 112		5560	11.00		9.14	
	CH 116		5580	11.00		9.42	
	CH 120		5600	11.00		9.78	
	CH 124	5620	11.00	9.80			
	CH 128	5640	11.00	9.96			
	CH 132	5660	11.00	10.22			
	CH 136	5680	11.00	9.89			
	CH 140	5700	11.00	9.54			
	CH 149	5745	11.00	9.40			
	CH 153	5765	11.00	9.30			
	CH 157	5785	11.00	9.45			
	CH 161	5805	11.00	9.61			
	CH 165	5825	11.00	10.04			

Mode	Antenna	Channel	Frequency (MHz)	Data Rate (Mbps)	Tune-up	Average Power (dBm)	
					Max.		
802.11n SISO 20M	Ant3(Core0)	CH 36	5180	MCS0	10.50	9.70	
		CH 40	5200		11.00	10.54	
		CH 44	5220		11.00	10.68	
		CH 48	5240		11.00	10.78	
		CH 52	5260		11.00	10.67	
		CH 56	5280		11.00	10.78	
		CH 60	5300		11.00	10.77	
		CH 64	5320		10.50	10.06	
		CH 100	5500		10.50	9.77	
		CH 104	5520		11.00	10.26	
		CH 108	5540		11.00	10.26	
		CH 112	5560		11.00	10.21	
		CH 116	5580		11.00	10.26	
		CH 120	5600		11.00	10.32	
		CH 124	5620		11.00	10.30	
		CH 128	5640		11.00	10.42	
		CH 132	5660		11.00	10.66	
		CH 136	5680		11.00	10.47	
		CH 140	5700		11.00	10.28	
		CH 149	5745		11.00	10.33	
	CH 153	5765	11.00	10.36			
	CH 157	5785	11.00	10.09			
	CH 161	5805	11.00	10.08			
	CH 165	5825	11.00	10.26			
		Ant4(Core1)	CH 36	5180	MCS0	10.50	9.05
			CH 40	5200		11.00	10.02
			CH 44	5220		11.00	10.15
			CH 48	5240		11.00	9.92
			CH 52	5260		11.00	10.01
			CH 56	5280		11.00	9.81
			CH 60	5300		11.00	9.65
			CH 64	5320		10.50	8.97
			CH 100	5500		10.50	8.43
			CH 104	5520		11.00	9.11
	CH 108		5540	11.00		9.17	
	CH 112		5560	11.00		9.08	
	CH 116		5580	11.00		9.24	
	CH 120		5600	11.00		9.33	
	CH 124	5620	11.00	9.40			
	CH 128	5640	11.00	9.38			
	CH 132	5660	11.00	9.70			
	CH 136	5680	11.00	9.64			
	CH 140	5700	11.00	9.37			
	CH 149	5745	11.00	9.21			
	CH 153	5765	11.00	9.14			
	CH 157	5785	11.00	9.25			
	CH 161	5805	11.00	9.32			
	CH 165	5825	11.00	9.30			

Mode	Antenna	Channel	Frequency (MHz)	Data Rate (Mbps)	Tune-up	Average Power (dBm)
					Max.	
802.11n SISO 40M	Ant3(Core0)	CH 38	5190	MCS0	9.50	8.11
		CH 46	5230		11.00	9.61
		CH 54	5270		11.00	9.62
		CH 62	5310		9.00	7.78
		CH 102	5510		9.50	8.84
		CH 110	5550		11.00	10.02
		CH 118	5590		11.00	10.12
		CH 126	5630		11.00	10.10
		CH 134	5670		9.50	8.48
		CH 151	5755		11.00	9.61
	CH 159	5795	11.00		9.62	
	Ant4(Core1)	CH 38	5190		9.50	8.33
		CH 46	5230		11.00	10.00
		CH 54	5270		11.00	9.72
		CH 62	5310		9.00	7.05
		CH 102	5510		9.50	7.89
		CH 110	5550		11.00	9.34
		CH 118	5590		11.00	9.66
		CH 126	5630		11.00	9.61
		CH 134	5670		9.50	8.36
CH 151		5755	11.00	9.44		
CH 159	5795	11.00	9.54			
Mode	Antenna	Channel	Frequency (MHz)	Data Rate (Mbps)	Tune-up Max.	Average Power (dBm)
802.11ac SISO 20M	Ant3(Core0)	CH 36	5180	MCS0	10.50	9.01
		CH 40	5200		11.00	9.58
		CH 44	5220		11.00	9.77
		CH 48	5240		11.00	9.67
		CH 52	5260		11.00	9.85
		CH 56	5280		11.00	9.74
		CH 60	5300		11.00	9.69
		CH 64	5320		10.50	9.44
		CH 100	5500		10.50	9.19
		CH 104	5520		11.00	9.70
		CH 108	5540		11.00	9.79
		CH 112	5560		11.00	10.04
		CH 116	5580		11.00	10.16
		CH 120	5600		11.00	10.14
		CH 124	5620		11.00	10.03
		CH 128	5640		11.00	10.12
		CH 132	5660		11.00	9.60
		CH 136	5680		11.00	9.33
		CH 140	5700		11.00	9.04
		CH 149	5745		11.00	8.60
CH 153	5765	11.00	8.76			
CH 157	5785	11.00	8.82			
CH 161	5805	11.00	9.08			
CH 165	5825	11.00	9.21			

		CH 36	5180		10.50	9.04
		CH 40	5200		11.00	9.53
		CH 44	5220		11.00	9.65
		CH 48	5240		11.00	9.57
		CH 52	5260		11.00	9.43
		CH 56	5280		11.00	9.29
		CH 60	5300		11.00	9.14
		CH 64	5320		10.50	8.59
		CH 100	5500		10.50	8.16
		CH 104	5520		11.00	8.60
		CH 108	5540		11.00	8.60
		CH 112	5560		11.00	8.58
		CH 116	5580		11.00	8.84
		CH 120	5600		11.00	9.02
		CH 124	5620		11.00	8.99
		CH 128	5640		11.00	8.90
		CH 132	5660		11.00	9.31
		CH 136	5680		11.00	9.00
		CH 140	5700		11.00	8.91
		CH 149	5745		11.00	8.90
		CH 153	5765		11.00	8.93
		CH 157	5785		11.00	9.11
		CH 161	5805		11.00	9.07
		CH 165	5825		11.00	9.16
	Ant4(Core1)			MCS0		
Mode	Antenna	Channel	Frequency (MHz)	Data Rate (Mbps)	Tune-up Max.	Average Power (dBm)
802.11ac SISO 40M	Ant3(Core0)	CH 38	5190	MCS0	9.50	7.57
		CH 46	5230		11.00	9.96
		CH 54	5270		11.00	9.98
		CH 62	5310		9.50	7.67
		CH 102	5510		11.00	8.21
		CH 110	5550		11.00	10.03
		CH 118	5590		11.00	10.23
		CH 126	5630		11.00	10.39
		CH 134	5670		9.50	8.00
		CH 151	5755		11.00	8.87
	CH 159	5795	11.00	9.17		
	Ant4(Core1)	CH 38	5190	MCS0	9.50	8.33
		CH 46	5230		11.00	9.60
		CH 54	5270		11.00	9.30
		CH 62	5310		9.50	7.68
		CH 102	5510		11.00	7.70
		CH 110	5550		11.00	8.65
		CH 118	5590		11.00	8.92
		CH 126	5630		11.00	9.06
		CH 134	5670		9.50	8.10
CH 151		5755	11.00		9.03	
CH 159	5795	11.00	9.23			

Mode	Antenna	Channel	Frequency (MHz)	Data Rate (Mbps)	Tune-up	Average Power (dBm)
					Max.	
802.11ac SISO 80M	Ant3(Core0)	CH 42	5210	MCS0	6.50	3.85
		CH 58	5290		6.50	3.60
		CH 106	5530		6.50	3.32
		CH 122	5610		6.50	3.32
		CH 155	5775		11.00	9.01
	Ant4(Core1)	CH 42	5210	MCS0	6.50	4.32
		CH 58	5290		6.50	4.60
		CH 106	5530		6.50	3.65
		CH 122	5610		6.50	3.25
		CH 155	5775		11.00	9.05
Mode	Antenna	Channel	Frequency (MHz)	Data Rate (Mbps)	Tune-up	Average Power (dBm)
802.11ac SISO 160M	Ant3(Core0)	CH 50	5250	MCS0	6.50	3.63
		CH 114	5570		6.50	3.84
	Ant4(Core1)	CH 50	5250	MCS0	6.50	4.38
		CH 114	5570		6.50	4.17

Table 157: Conducted power measurement results of WiFi 5G SISO (Receiver ON)

Mode	Antenna	Channel	Frequency (MHz)	Data Rate (Mbps)	Tune-up	Average Power (dBm)
					Max.	
802.11a	Ant3(Core0)	CH 36	5180	6Mbps	10.50	9.01
		CH 40	5200		16.00	14.08
		CH 44	5220		16.00	14.08
		CH 48	5240		16.00	14.28
		CH 52	5260		16.00	14.44
		CH 56	5280		16.00	14.59
		CH 60	5300		16.00	14.71
		CH 64	5320		10.50	9.45
		CH 100	5500		10.50	9.79
		CH 104	5520		16.00	14.55
		CH 108	5540		16.00	14.16
		CH 112	5560		16.00	14.01
		CH 116	5580		16.00	14.57
		CH 120	5600		16.00	14.26
		CH 124	5620		16.00	14.39
		CH 128	5640		16.00	14.54
		CH 132	5660		16.00	14.51
		CH 136	5680		16.00	14.56
		CH 140	5700		11.00	10.06
		CH 149	5745		16.00	14.07
		CH 153	5765		16.00	14.15
		CH 157	5785		16.00	14.21
		CH 161	5805		16.00	14.21
		CH 165	5825		15.00	13.42

		CH 36	5180		10.50	9.35
		CH 40	5200		15.50	14.05
		CH 44	5220		15.50	14.13
		CH 48	5240		15.50	14.23
		CH 52	5260		15.50	14.36
		CH 56	5280		15.50	14.45
		CH 60	5300		15.50	14.46
		CH 64	5320		10.50	9.68
		CH 100	5500		10.50	9.48
		CH 104	5520		15.50	13.63
		CH 108	5540		15.50	13.62
		CH 112	5560		15.50	13.55
		CH 116	5580		15.50	13.59
		CH 120	5600		15.50	13.55
		CH 124	5620		15.50	13.55
		CH 128	5640		15.50	13.57
		CH 132	5660		15.50	13.66
		CH 136	5680		15.50	13.67
		CH 140	5700		11.00	10.13
		CH 149	5745		15.50	13.73
		CH 153	5765		15.50	13.59
		CH 157	5785		15.50	13.61
		CH 161	5805		15.50	13.66
		CH 165	5825		15.00	13.07
	Ant4(Core1)			6Mbps		
Mode	Antenna	Channel	Frequency (MHz)	Data Rate (Mbps)	Tune-up Max.	Average Power (dBm)
802.11n SISO 20M	Ant3(Core0)	CH 36	5180		10.50	9.11
		CH 40	5200		16.00	13.97
		CH 44	5220		16.00	14.09
		CH 48	5240		16.00	14.22
		CH 52	5260		16.00	14.27
		CH 56	5280		16.00	14.25
		CH 60	5300		16.00	14.22
		CH 64	5320		10.50	9.44
		CH 100	5500		10.50	9.61
		CH 104	5520		16.00	14.06
		CH 108	5540		16.00	14.09
		CH 112	5560		16.00	14.18
		CH 116	5580		16.00	14.25
		CH 120	5600		16.00	14.33
		CH 124	5620		16.00	14.56
		CH 128	5640		16.00	14.77
		CH 132	5660		16.00	14.42
		CH 136	5680		16.00	14.37
		CH 140	5700		11.00	9.89
		CH 149	5745		16.00	12.92
		CH 153	5765		16.00	12.77
		CH 157	5785		16.00	13.00
		CH 161	5805		16.00	13.02
		CH 165	5825		15.00	12.49
	Ant3(Core0)			MCS0		

		CH 36	5180		10.50	9.01
		CH 40	5200		15.50	13.93
		CH 44	5220		15.50	13.98
		CH 48	5240		15.50	13.94
		CH 52	5260		15.50	13.97
		CH 56	5280		15.50	13.81
		CH 60	5300		15.50	13.55
		CH 64	5320		10.50	8.36
		CH 100	5500		10.50	8.42
		CH 104	5520		15.50	12.86
		CH 108	5540		15.50	12.82
		CH 112	5560		15.50	12.88
		CH 116	5580		15.50	12.96
		CH 120	5600		15.50	12.89
		CH 124	5620		15.50	13.04
		CH 128	5640		15.50	13.13
		CH 132	5660		15.50	13.63
		CH 136	5680		15.50	13.49
		CH 140	5700		11.00	9.80
		CH 149	5745		15.50	13.08
		CH 153	5765		15.50	12.99
		CH 157	5785		15.50	13.04
		CH 161	5805		15.50	12.98
		CH 165	5825		15.00	12.59
	Ant4(Core1)			MCS0		
Mode	Antenna	Channel	Frequency (MHz)	Data Rate (Mbps)	Tune-up Max.	Average Power (dBm)
802.11n SISO 40M	Ant3(Core0)	CH 38	5190	MCS0	9.50	8.46
		CH 46	5230		15.50	12.78
		CH 54	5270		15.50	12.82
		CH 62	5310		9.00	8.73
		CH 102	5510		9.50	8.88
		CH 110	5550		15.50	12.60
		CH 118	5590		15.50	12.77
		CH 126	5630		15.50	12.90
		CH 134	5670		9.50	8.64
		CH 151	5755		15.50	12.30
	CH 159	5795	14.50	11.70		
	Ant4(Core1)	CH 38	5190	MCS0	9.50	8.32
		CH 46	5230		15.00	13.62
		CH 54	5270		15.00	13.32
		CH 62	5310		9.00	7.61
		CH 102	5510		9.50	7.89
		CH 110	5550		15.00	12.73
		CH 118	5590		15.00	12.95
		CH 126	5630		15.00	13.08
		CH 134	5670		9.50	8.33
CH 151		5755	15.00		12.94	
CH 159	5795	14.50	12.66			

Mode	Antenna	Channel	Frequency (MHz)	Data Rate (Mbps)	Tune-up	Average Power (dBm)	
					Max.		
802.11ac SISO 20M	Ant3(Core0)	CH 36	5180	MCS0	10.50	8.96	
		CH 40	5200		16.00	13.36	
		CH 44	5220		16.00	13.46	
		CH 48	5240		16.00	13.62	
		CH 52	5260		16.00	13.40	
		CH 56	5280		16.00	13.42	
		CH 60	5300		16.00	13.42	
		CH 64	5320		10.50	9.33	
		CH 100	5500		10.50	9.38	
		CH 104	5520		16.00	13.27	
		CH 108	5540		16.00	13.49	
		CH 112	5560		16.00	13.62	
		CH 116	5580		16.00	13.82	
		CH 120	5600		16.00	14.01	
		CH 124	5620		16.00	14.01	
		CH 128	5640		16.00	14.04	
		CH 132	5660		16.00	12.98	
		CH 136	5680		16.00	12.81	
		CH 140	5700		11.00	9.11	
		CH 149	5745		16.00	12.72	
	CH 153	5765	16.00	12.81			
	CH 157	5785	16.00	12.77			
	CH 161	5805	16.00	12.81			
	CH 165	5825	15.00	12.36			
		Ant4(Core1)	CH 36	5180	MCS0	10.50	9.14
			CH 40	5200		15.50	13.27
			CH 44	5220		15.50	13.33
			CH 48	5240		15.50	13.43
			CH 52	5260		15.50	13.15
			CH 56	5280		15.50	13.26
			CH 60	5300		15.50	12.92
			CH 64	5320		10.50	8.54
			CH 100	5500		10.50	8.26
			CH 104	5520		15.50	12.35
			CH 108	5540		15.50	12.21
			CH 112	5560		15.50	12.19
	CH 116		5580	15.50		12.35	
	CH 120		5600	15.50		12.59	
	CH 124		5620	15.50		12.66	
	CH 128		5640	15.50		12.65	
	CH 132	5660	15.50	12.82			
	CH 136	5680	15.50	12.91			
	CH 140	5700	11.00	9.12			
	CH 149	5745	15.50	12.39			
	CH 153	5765	15.50	12.34			
	CH 157	5785	15.50	12.49			
	CH 161	5805	15.50	12.53			
	CH 165	5825	15.00	12.49			

Mode	Antenna	Channel	Frequency (MHz)	Data Rate (Mbps)	Tune-up	Average Power (dBm)
					Max.	
802.11ac SISO 40M	Ant3(Core0)	CH 38	5190	MCS0	9.50	7.84
		CH 46	5230		15.50	13.23
		CH 54	5270		15.50	13.17
		CH 62	5310		9.00	7.55
		CH 102	5510		9.50	8.21
		CH 110	5550		15.50	13.26
		CH 118	5590		15.50	13.66
		CH 126	5630		15.50	13.60
		CH 134	5670		9.50	7.98
		CH 151	5755		15.50	12.21
	CH 159	5795	14.50	11.81		
	Ant4(Core1)	CH 38	5190	MCS0	9.50	8.32
		CH 46	5230		15.00	12.83
		CH 54	5270		15.00	12.66
		CH 62	5310		9.00	7.69
		CH 102	5510		9.50	7.37
		CH 110	5550		15.00	11.72
		CH 118	5590		15.00	11.98
		CH 126	5630		15.00	12.03
		CH 134	5670		9.50	8.07
CH 151		5755	15.00		11.69	
CH 159	5795	14.50	11.82			
Mode	Antenna	Channel	Frequency (MHz)	Data Rate (Mbps)	Tune-up Max.	Average Power (dBm)
802.11ac SISO 80M	Ant3(Core0)	CH 42	5210	MCS0	6.50	3.87
		CH 58	5290		6.50	3.37
		CH 106	5530		6.50	3.51
		CH 122	5610		6.50	3.35
		CH 155	5775		11.50	9.21
	Ant4(Core1)	CH 42	5210	MCS0	6.50	4.29
		CH 58	5290		6.50	4.52
		CH 106	5530		6.50	3.60
		CH 122	5610		6.50	3.96
		CH 155	5775		11.50	9.36
Mode	Antenna	Channel	Frequency (MHz)	Data Rate (Mbps)	Tune-up Max.	Average Power (dBm)
802.11ac SISO 160M	Ant3(Core0)	CH 50	5250	MCS0	6.50	3.30
		CH 114	5570		6.50	3.33
	Ant4(Core1)	CH 50	5250	MCS0	6.50	4.29
		CH 114	5570		6.50	3.09

Table 158: Conducted power measurement results of WiFi 5G SISO (Receiver off)

Mode	Antenna	Channel	Frequency (MHz)	Data Rate (Mbps)	Tune-up	Average Power (dBm)	
					Max.		
802.11a CDD	Ant3(Core0)	CH 36	5180	6Mbps	10.50	9.16	
		CH 40	5200		11.00	10.43	
		CH 44	5220		11.00	10.35	
		CH 48	5240		11.00	9.38	
		CH 52	5260		11.00	9.75	
		CH 56	5280		11.00	10.04	
		CH 60	5300		11.00	10.10	
		CH 64	5320		10.50	9.11	
		CH 100	5500		10.50	8.79	
		CH 104	5520		11.00	9.18	
		CH 108	5540		11.00	9.02	
		CH 112	5560		11.00	9.27	
		CH 116	5580		11.00	9.44	
		CH 120	5600		11.00	9.67	
		CH 124	5620		11.00	10.07	
		CH 128	5640		11.00	10.39	
		CH 132	5660		11.00	10.22	
		CH 136	5680		11.00	10.12	
		CH 140	5700		11.00	9.82	
		CH 149	5745		11.00	9.48	
	CH 153	5765	11.00		9.28		
	CH 157	5785	11.00		9.17		
	CH 161	5805	11.00		9.16		
	CH 165	5825	11.00		9.81		
		Ant4(Core1)	CH 36		5180	10.50	7.55
			CH 40		5200	11.00	7.97
			CH 44		5220	11.00	8.72
			CH 48		5240	11.00	9.04
			CH 52		5260	11.00	9.07
			CH 56		5280	11.00	8.82
			CH 60		5300	11.00	8.54
			CH 64		5320	10.50	7.37
			CH 100		5500	10.50	8.54
			CH 104		5520	11.00	9.15
			CH 108		5540	11.00	9.10
			CH 112		5560	11.00	9.14
	CH 116		5580	11.00	9.42		
	CH 120		5600	11.00	9.78		
	CH 124		5620	11.00	9.80		
	CH 128		5640	11.00	9.96		
	CH 132	5660	11.00	10.22			
	CH 136	5680	11.00	9.89			
	CH 140	5700	11.00	9.54			
	CH 149	5745	11.00	9.40			
	CH 153	5765	11.00	9.30			
	CH 157	5785	11.00	9.45			
	CH 161	5805	11.00	9.61			
	CH 165	5825	11.00	10.04			

		CH 36	5180		13.51	11.44
		CH 40	5200		14.01	12.38
		CH 44	5220		14.01	12.62
		CH 48	5240		14.01	12.22
		CH 52	5260		14.01	12.43
		CH 56	5280		14.01	12.48
		CH 60	5300		14.01	12.40
		CH 64	5320		13.51	11.34
		CH 100	5500		13.50	11.68
		CH 104	5520		14.01	12.18
		CH 108	5540		14.01	12.07
		CH 112	5560		14.01	12.22
		CH 116	5580		14.01	12.44
		CH 120	5600		14.01	12.74
		CH 124	5620		14.01	12.95
		CH 128	5640		14.01	13.19
		CH 132	5660		14.01	13.23
		CH 136	5680		14.01	13.02
		CH 140	5700		14.01	12.69
		CH 149	5745		14.01	12.45
		CH 153	5765		14.01	12.30
		CH 157	5785		14.01	12.32
		CH 161	5805		14.01	12.40
		CH 165	5825		14.01	12.94
	Sum					
Mode	Antenna	Channel	Frequency (MHz)	Data Rate (Mbps)	Tune-up Max.	Average Power (dBm)
802.11n MIMO 20M	Ant3(Core0)	CH 36	5180	MCS8	10.50	9.70
		CH 40	5200		11.00	10.54
		CH 44	5220		11.00	10.68
		CH 48	5240		11.00	10.78
		CH 52	5260		11.00	10.67
		CH 56	5280		11.00	10.78
		CH 60	5300		11.00	10.77
		CH 64	5320		10.50	10.06
		CH 100	5500		10.50	9.77
		CH 104	5520		11.00	10.26
		CH 108	5540		11.00	10.26
		CH 112	5560		11.00	10.21
		CH 116	5580		11.00	10.26
		CH 120	5600		11.00	10.32
		CH 124	5620		11.00	10.30
		CH 128	5640		11.00	10.42
		CH 132	5660		11.00	10.66
		CH 136	5680		11.00	10.47
		CH 140	5700		11.00	10.28
		CH 149	5745		11.00	10.33
CH 153	5765	11.00	10.36			
CH 157	5785	11.00	10.09			
CH 161	5805	11.00	10.08			
CH 165	5825	11.00	10.26			

		CH 36	5180		10.50	9.05
		CH 40	5200		11.00	10.02
		CH 44	5220		11.00	10.15
		CH 48	5240		11.00	9.92
		CH 52	5260		11.00	10.01
		CH 56	5280		11.00	9.81
		CH 60	5300		11.00	9.65
		CH 64	5320		10.50	8.97
		CH 100	5500		10.50	8.43
		CH 104	5520		11.00	9.11
		CH 108	5540		11.00	9.17
		CH 112	5560		11.00	9.08
		CH 116	5580		11.00	9.24
		CH 120	5600		11.00	9.33
		CH 124	5620		11.00	9.40
		CH 128	5640		11.00	9.38
		CH 132	5660		11.00	9.70
		CH 136	5680		11.00	9.64
		CH 140	5700		11.00	9.37
		CH 149	5745		11.00	9.21
		CH 153	5765		11.00	9.14
		CH 157	5785		11.00	9.25
		CH 161	5805		11.00	9.32
		CH 165	5825		11.00	9.30
	Ant4(Core1)	CH 36	5180		13.51	12.40
		CH 40	5200		14.01	13.30
		CH 44	5220		14.01	13.43
		CH 48	5240		14.01	13.38
		CH 52	5260		14.01	13.36
		CH 56	5280		14.01	13.33
		CH 60	5300		14.01	13.26
		CH 64	5320		13.51	12.56
		CH 100	5500		13.51	12.16
		CH 104	5520		14.01	12.73
		CH 108	5540		14.01	12.76
		CH 112	5560		14.01	12.69
		CH 116	5580		14.01	12.79
		CH 120	5600		14.01	12.86
		CH 124	5620		14.01	12.88
		CH 128	5640		14.01	12.94
		CH 132	5660		14.01	13.22
		CH 136	5680		14.01	13.09
		CH 140	5700		14.01	12.86
		CH 149	5745		14.01	12.82
		CH 153	5765		14.01	12.80
		CH 157	5785		14.01	12.70
		CH 161	5805		14.01	12.73
		CH 165	5825		14.01	12.82
	Sum	CH 36	5180		13.51	12.40
		CH 40	5200		14.01	13.30
		CH 44	5220		14.01	13.43
		CH 48	5240		14.01	13.38
		CH 52	5260		14.01	13.36
		CH 56	5280		14.01	13.33
		CH 60	5300		14.01	13.26
		CH 64	5320		13.51	12.56
		CH 100	5500		13.51	12.16
		CH 104	5520		14.01	12.73
		CH 108	5540		14.01	12.76
		CH 112	5560		14.01	12.69
		CH 116	5580		14.01	12.79
		CH 120	5600		14.01	12.86
		CH 124	5620		14.01	12.88
		CH 128	5640		14.01	12.94
		CH 132	5660		14.01	13.22
		CH 136	5680		14.01	13.09
		CH 140	5700		14.01	12.86
		CH 149	5745		14.01	12.82
		CH 153	5765		14.01	12.80
		CH 157	5785		14.01	12.70
		CH 161	5805		14.01	12.73
		CH 165	5825		14.01	12.82

Mode	Antenna	Channel	Frequency (MHz)	Data Rate (Mbps)	Tune-up	Average Power (dBm)
					Max.	
802.11n MIMO 40M	Ant3(Core0)	CH 38	5190	MCS8	9.50	8.11
		CH 46	5230		11.00	9.61
		CH 54	5270		11.00	9.62
		CH 62	5310		9.00	7.78
		CH 102	5510		9.50	8.84
		CH 110	5550		11.00	10.02
		CH 118	5590		11.00	10.02
		CH 126	5630		11.00	10.12
		CH 134	5670		9.50	8.48
		CH 151	5755		11.00	9.61
	CH 159	5795	11.00		9.62	
	Ant4(Core1)	CH 38	5190		9.50	8.33
		CH 46	5230		11.00	10.00
		CH 54	5270		11.00	9.72
		CH 62	5310		9.00	7.05
		CH 102	5510		9.50	7.89
		CH 110	5550		11.00	9.34
		CH 118	5590		11.00	9.56
		CH 126	5630		11.00	9.91
		CH 134	5670		9.50	8.36
		CH 151	5755		11.00	9.44
	CH 159	5795	11.00		9.54	
	Sum	CH 38	5190		12.51	11.23
		CH 46	5230		14.01	12.82
		CH 54	5270		14.01	12.68
		CH 62	5310		12.01	10.44
		CH 102	5510		12.51	11.40
		CH 110	5550		14.01	12.70
		CH 118	5590		14.01	12.81
		CH 126	5630		14.01	13.03
CH 134		5670	12.51	11.43		
CH 151		5755	14.01	12.54		
CH 159	5795	14.01	12.59			

Mode	Antenna	Channel	Frequency(MHz)	Data Rate (Mbps)	Tune-up	Average Power(dBm)
					Max.	
802.11ac MIMO 20M	Ant3(Core0)	CH 36	5180	MCS0	10.50	9.01
		CH 40	5200		11.00	9.58
		CH 44	5220		11.00	9.77
		CH 48	5240		11.00	9.67
		CH 52	5260		11.00	9.85
		CH 56	5280		11.00	9.74
		CH 60	5300		11.00	9.69
		CH 64	5320		10.50	9.44
		CH 100	5500		10.50	9.19
		CH 104	5520		11.00	9.70
		CH 108	5540		11.00	9.79
		CH 112	5560		11.00	10.04
		CH 116	5580		11.00	10.16
		CH 120	5600		11.00	10.14
		CH 124	5620		11.00	10.03
		CH 128	5640		11.00	10.12
		CH 132	5660		11.00	9.60
		CH 136	5680		11.00	9.33
		CH 140	5700		11.00	9.04
		CH 149	5745		11.00	8.60
	CH 153	5765	11.00		8.76	
	CH 157	5785	11.00		8.82	
	CH 161	5805	11.00		9.08	
	CH 165	5825	11.00		9.21	
	Ant4(Core1)	CH 36	5180		10.50	9.04
		CH 40	5200		11.00	9.53
		CH 44	5220		11.00	9.65
		CH 48	5240		11.00	9.57
		CH 52	5260		11.00	9.43
		CH 56	5280		11.00	9.29
		CH 60	5300		11.00	9.14
		CH 64	5320		10.50	8.59
		CH 100	5500		10.50	8.16
		CH 104	5520		11.00	8.60
		CH 108	5540		11.00	8.60
		CH 112	5560		11.00	8.58
CH 116		5580	11.00	8.84		
CH 120		5600	11.00	9.02		
CH 124		5620	11.00	8.99		
CH 128		5640	11.00	8.90		
CH 132	5660	11.00	9.31			
CH 136	5680	11.00	9.00			
CH 140	5700	11.00	8.91			
CH 149	5745	11.00	8.90			
CH 153	5765	11.00	8.93			
CH 157	5785	11.00	9.11			
CH 161	5805	11.00	9.07			
CH 165	5825	11.00	9.16			

		CH 36	5180		13.51	12.04
		CH 40	5200		14.01	12.57
		CH 44	5220		14.01	12.72
		CH 48	5240		14.01	12.63
		CH 52	5260		14.01	12.66
		CH 56	5280		14.01	12.53
		CH 60	5300		14.01	12.43
		CH 64	5320		13.51	12.05
		CH 100	5500		13.51	11.72
		CH 104	5520		14.01	12.20
		CH 108	5540		14.01	12.25
		CH 112	5560		14.01	12.38
		CH 116	5580		14.01	12.56
		CH 120	5600		14.01	12.63
		CH 124	5620		14.01	12.55
		CH 128	5640		14.01	12.56
		CH 132	5660		14.01	12.47
		CH 136	5680		14.01	12.18
		CH 140	5700		14.01	11.99
		CH 149	5745		14.01	11.76
		CH 153	5765		14.01	11.86
		CH 157	5785		14.01	11.98
		CH 161	5805		14.01	12.09
		CH 165	5825		14.01	12.20
	Sum					
Mode	Antenna	Channel	Frequency (MHz)	Data Rate (Mbps)	Tune-up Max.	Average Power (dBm)
802.11ac MIMO 40M	Ant3(Core0)	CH 38	5190	MCS0	9.50	7.57
		CH 46	5230		11.00	9.96
		CH 54	5270		11.00	9.98
		CH 62	5310		9.50	7.67
		CH 102	5510		11.00	8.21
		CH 110	5550		11.00	10.03
		CH 118	5590		11.00	10.23
		CH 126	5630		11.00	10.39
		CH 134	5670		9.50	8.00
		CH 151	5755		11.00	8.87
	CH 159	5795	11.00		9.17	
	Ant4(Core1)	CH 38	5190		9.50	8.33
		CH 46	5230		11.00	9.60
		CH 54	5270		11.00	9.30
		CH 62	5310		9.50	7.68
		CH 102	5510		11.00	7.70
		CH 110	5550		11.00	8.65
		CH 118	5590		11.00	8.92
		CH 126	5630		11.00	9.06
		CH 134	5670		9.50	8.10
CH 151		5755	11.00	9.03		
CH 159	5795	11.00	9.23			

Mode	Antenna	Channel	Frequency (MHz)	Data Rate (Mbps)	Tune-up	Average Power (dBm)
					Max.	
	Sum	CH 38	5190		12.51	10.98
		CH 46	5230		14.01	12.79
		CH 54	5270		14.01	12.66
		CH 62	5310		12.51	10.69
		CH 102	5510		14.01	10.97
		CH 110	5550		14.01	12.40
		CH 118	5590		14.01	12.63
		CH 126	5630		14.01	12.79
		CH 134	5670		12.51	11.06
		CH 151	5755		14.01	11.96
		CH 159	5795		14.01	12.21
802.11ac MIMO 80M	Ant3(Core0)	CH 42	5210	MCS0	6.50	3.85
		CH 58	5290		6.50	3.60
		CH 106	5530		6.50	3.32
		CH 122	5610		6.50	3.32
		CH 155	5775		11.00	9.01
	Ant4(Core1)	CH 42	5210		6.50	4.32
		CH 58	5290		6.50	4.60
		CH 106	5530		6.50	3.65
		CH 122	5610		6.50	3.25
		CH 155	5775		11.00	9.05
	Sum	CH 42	5210		9.51	7.10
		CH 58	5290		9.51	7.14
		CH 106	5530		9.51	6.50
		CH 122	5610		9.51	6.30
		CH 155	5775		14.01	12.04
Mode	Antenna	Channel	Frequency (MHz)	Data Rate (Mbps)	Tune-up	Average Power (dBm)
					Max.	
802.11ac MIMO 160M	Ant3(Core0)	CH 50	5250	MCS0	6.50	3.63
		CH 114	5570		6.50	3.84
	Ant4(Core1)	CH 50	5250		6.50	4.38
		CH 114	5570		6.50	4.17
	Sum	CH 50	5250		9.51	7.03
		CH 114	5570		9.51	7.02

Table 159: Conducted power measurement results of WiFi 5G CDD/MIMO (Receiver ON)

Mode	Antenna	Channel	Frequency (MHz)	Data Rate (Mbps)	Tune-up	Average Power (dBm)
					Max.	
802.11a CDD	Ant3(Core0)	CH 36	5180	6Mbps	10.50	9.01
		CH 40	5200		16.00	14.08
		CH 44	5220		16.00	14.08
		CH 48	5240		16.00	14.28
		CH 52	5260		16.00	14.44
		CH 56	5280		16.00	14.59
		CH 60	5300		16.00	14.71
		CH 64	5320		10.50	9.45
		CH 100	5500		10.50	9.79
		CH 104	5520		16.00	14.55
		CH 108	5540		16.00	14.16
		CH 112	5560		16.00	14.01
		CH 116	5580		16.00	14.57
		CH 120	5600		16.00	14.26

		CH 124	5620		16.00	14.39
		CH 128	5640		16.00	14.54
		CH 132	5660		16.00	14.51
		CH 136	5680		16.00	14.56
		CH 140	5700		11.00	10.06
		CH 149	5745		16.00	14.07
		CH 153	5765		16.00	14.15
		CH 157	5785		16.00	14.21
		CH 161	5805		16.00	14.21
		CH 165	5825		15.00	13.42
	Ant4(Core1)	CH 36	5180		10.50	9.35
		CH 40	5200		15.50	14.05
		CH 44	5220		15.50	14.13
		CH 48	5240		15.50	14.23
		CH 52	5260		15.50	14.36
		CH 56	5280		15.50	14.45
		CH 60	5300		15.50	14.46
		CH 64	5320		10.50	9.68
		CH 100	5500		10.50	9.48
		CH 104	5520		15.50	13.63
		CH 108	5540		15.50	13.62
		CH 112	5560		15.50	13.55
		CH 116	5580		15.50	13.59
		CH 120	5600		15.50	13.55
		CH 124	5620		15.50	13.55
		CH 128	5640		15.50	13.57
		CH 132	5660		15.50	13.66
		CH 136	5680		15.50	13.67
		CH 140	5700		11.00	10.13
		CH 149	5745		15.50	13.73
	Sum	CH 153	5765		15.50	13.59
		CH 157	5785		15.50	13.61
		CH 161	5805		15.50	13.66
		CH 165	5825		15.00	13.07
		CH 36	5180		13.51	12.19
		CH 40	5200		18.77	17.08
		CH 44	5220		18.77	17.12
		CH 48	5240		18.77	17.27
		CH 52	5260		18.77	17.41
		CH 56	5280		18.77	17.53
		CH 60	5300		18.77	17.60
		CH 64	5320		13.51	12.58
		CH 100	5500		13.51	12.65
		CH 104	5520		18.77	17.12
		CH 108	5540		18.77	16.91
		CH 112	5560		18.77	16.80
		CH 116	5580		18.77	17.12
		CH 120	5600		18.77	16.93
		CH 124	5620		18.77	17.00
		CH 128	5640		18.77	17.09
	CH 132	5660		18.77	17.12	
	CH 136	5680		18.77	17.15	
	CH 140	5700		14.01	13.11	
	CH 149	5745		18.77	16.91	

Mode	Antenna	Channel	Frequency (MHz)	Data Rate (Mbps)	Tune-up	Average Power (dBm)	
					Max.		
802.11n MIMO 20M		CH 153	5765		18.77	16.89	
		CH 157	5785		18.77	16.93	
		CH 161	5805		18.77	16.95	
		CH 165	5825		18.77	16.26	
	802.11n MIMO 20M	Ant3(Core0)	CH 36	5180	MCS8	10.50	9.11
			CH 40	5200		16.00	13.97
			CH 44	5220		16.00	14.09
			CH 48	5240		16.00	14.22
			CH 52	5260		16.00	14.27
			CH 56	5280		16.00	14.25
			CH 60	5300		16.00	14.22
			CH 64	5320		10.50	9.44
			CH 100	5500		10.50	9.61
			CH 104	5520		16.00	14.06
			CH 108	5540		16.00	14.09
			CH 112	5560		16.00	14.18
			CH 116	5580		16.00	14.25
			CH 120	5600		16.00	14.33
			CH 124	5620		16.00	14.56
			CH 128	5640		16.00	14.77
			CH 132	5660		16.00	14.42
			CH 136	5680		16.00	14.37
			CH 140	5700		11.00	9.89
			CH 149	5745		16.00	12.92
		CH 153	5765	16.00		12.77	
		CH 157	5785	16.00		13.00	
		CH 161	5805	16.00		13.02	
		CH 165	5825	15.00		12.49	
		Ant4(Core1)	CH 36	5180		10.50	9.01
			CH 40	5200		15.50	13.93
			CH 44	5220		15.50	13.98
			CH 48	5240		15.50	13.94
			CH 52	5260		15.50	13.97
			CH 56	5280		15.50	13.81
CH 60			5300	15.50		13.55	
CH 64			5320	10.50		8.36	
CH 100			5500	10.50		8.42	
CH 104			5520	15.50		12.86	
CH 108	5540		15.50	12.82			
CH 112	5560		15.50	12.88			
CH 116	5580		15.50	12.96			
CH 120	5600		15.50	12.89			
CH 124	5620		15.50	13.04			
CH 128	5640		15.50	13.13			
CH 132	5660		15.50	13.63			
CH 136	5680		15.50	13.49			
CH 140	5700		11.00	9.80			
CH 149	5745		15.50	13.08			
CH 153	5765	15.50	12.99				
CH 157	5785	15.50	13.04				
CH 161	5805	15.50	12.98				

		CH 165	5825		15.00	12.59
	Sum	CH 36	5180		13.51	12.07
		CH 40	5200		18.77	16.96
		CH 44	5220		18.77	17.05
		CH 48	5240		18.77	17.09
		CH 52	5260		18.77	17.13
		CH 56	5280		18.77	17.05
		CH 60	5300		18.77	16.91
		CH 64	5320		13.51	11.94
		CH 100	5500		13.51	12.07
		CH 104	5520		18.77	16.51
		CH 108	5540		18.77	16.51
		CH 112	5560		18.77	16.59
		CH 116	5580		18.77	16.66
		CH 120	5600		18.77	16.68
		CH 124	5620		18.77	16.88
		CH 128	5640		18.77	17.04
		CH 132	5660		18.77	17.05
		CH 136	5680		18.77	16.96
		CH 140	5700		14.01	12.86
		CH 149	5745		18.77	16.01
	CH 153	5765		18.77	15.89	
	CH 157	5785		18.77	16.03	
	CH 161	5805		18.77	16.01	
	CH 165	5825		18.01	15.55	
Mode	Antenna	Channel	Frequency (MHz)	Data Rate (Mbps)	Tune-up Max.	Average Power (dBm)
802.11n MIMO 40M	Ant3(Core0)	CH 38	5190	MCS8	9.50	8.46
		CH 46	5230		15.50	12.78
		CH 54	5270		15.50	12.82
		CH 62	5310		9.00	8.73
		CH 102	5510		9.50	8.88
		CH 110	5550		15.50	12.60
		CH 118	5590		15.50	12.77
		CH 126	5630		15.50	12.90
		CH 134	5670		9.50	8.64
		CH 151	5755		15.50	12.30
	CH 159	5795	14.50		11.70	
	Ant4(Core1)	CH 38	5190		9.50	8.32
		CH 46	5230		15.00	13.62
		CH 54	5270		15.00	13.32
		CH 62	5310		9.00	7.61
		CH 102	5510		9.50	7.89
		CH 110	5550		15.00	12.73
		CH 118	5590		15.00	12.95
		CH 126	5630		15.00	13.08
		CH 134	5670		9.50	8.33
CH 151		5755	15.00	12.94		
CH 159	5795	14.50	12.66			

Mode	Antenna	Channel	Frequency(MHz)	Data Rate (Mbps)	Tune-up	Average
					Max.	Power(dBm)
Sum		CH 38	5190		12.51	11.40
		CH 46	5230		18.27	16.23
		CH 54	5270		18.27	16.09
		CH 62	5310		12.01	11.22
		CH 102	5510		12.51	11.42
		CH 110	5550		18.27	15.68
		CH 118	5590		18.27	15.87
		CH 126	5630		18.27	16.00
		CH 134	5670		12.51	11.50
		CH 151	5755		18.27	15.64
		CH 159	5795		17.51	15.22
802.11ac MIMO 20M	Ant3(Core0)	CH 36	5180	MCS0	10.50	8.96
		CH 40	5200		16.00	13.36
		CH 44	5220		16.00	13.46
		CH 48	5240		16.00	13.62
		CH 52	5260		16.00	13.40
		CH 56	5280		16.00	13.42
		CH 60	5300		16.00	13.42
		CH 64	5320		10.50	9.33
		CH 100	5500		10.50	9.38
		CH 104	5520		16.00	13.27
		CH 108	5540		16.00	13.49
		CH 112	5560		16.00	13.62
		CH 116	5580		16.00	13.82
		CH 120	5600		16.00	14.01
		CH 124	5620		16.00	14.01
		CH 128	5640		16.00	14.04
		CH 132	5660		16.00	12.98
		CH 136	5680		16.00	12.81
		CH 140	5700		11.00	9.11
		CH 149	5745		16.00	12.72
	CH 153	5765	16.00		12.81	
	CH 157	5785	16.00		12.77	
	CH 161	5805	16.00		12.81	
	CH 165	5825	15.00		12.36	
	Ant4(Core1)	CH 36	5180		10.50	9.14
		CH 40	5200		15.50	13.27
		CH 44	5220		15.50	13.33
		CH 48	5240		15.50	13.43
		CH 52	5260		15.50	13.15
		CH 56	5280		15.50	13.26
		CH 60	5300		15.50	12.92
		CH 64	5320		10.50	8.54
		CH 100	5500		10.50	8.26
		CH 104	5520		15.50	12.35
CH 108		5540	15.50	12.21		
CH 112		5560	15.50	12.19		
CH 116		5580	15.50	12.35		
CH 120		5600	15.50	12.59		
CH 124	5620	15.50	12.66			
CH 128	5640	15.50	12.65			

		CH 132	5660		15.50	12.82	
		CH 136	5680		15.50	12.91	
		CH 140	5700		11.00	9.12	
		CH 149	5745		15.50	12.39	
		CH 153	5765		15.50	12.34	
		CH 157	5785		15.50	12.49	
		CH 161	5805		15.50	12.53	
		CH 165	5825		15.00	12.49	
	Sum	CH 36	5180		13.51	12.06	
		CH 40	5200		18.77	16.33	
		CH 44	5220		18.77	16.41	
		CH 48	5240		18.77	16.54	
		CH 52	5260		18.77	16.29	
		CH 56	5280		18.77	16.35	
		CH 60	5300		18.77	16.19	
		CH 64	5320		13.51	11.96	
		CH 100	5500		13.51	11.87	
		CH 104	5520		18.77	15.84	
		CH 108	5540		18.77	15.91	
		CH 112	5560		18.77	15.97	
		CH 116	5580		18.77	16.16	
		CH 120	5600		18.77	16.37	
		CH 124	5620		18.77	16.40	
		CH 128	5640		18.77	16.41	
		CH 132	5660		18.77	15.91	
		CH 136	5680		18.77	15.87	
		CH 140	5700		14.01	12.13	
		CH 149	5745		18.77	15.57	
		CH 153	5765		18.77	15.59	
		CH 157	5785		18.77	15.64	
		CH 161	5805		18.77	15.68	
		CH 165	5825		18.01	15.44	
Mode		Antenna	Channel	Frequency (MHz)	Data Rate (Mbps)	Tune-up Max.	Average Power (dBm)
802.11ac MIMO 40M		Ant3(Core0)	CH 38	5190	MCS0	9.50	7.84
			CH 46	5230		15.50	13.23
			CH 54	5270		15.50	13.17
	CH 62		5310	9.00		7.55	
	CH 102		5510	9.50		8.21	
	CH 110		5550	15.50		13.26	
	CH 118		5590	15.50		13.66	
	CH 126		5630	15.50		13.60	
	CH 134		5670	9.50		7.98	
	CH 151		5755	15.50		12.21	
	CH 159		5795	14.50		11.81	

	Ant4(Core1)	CH 38	5190	MCS0	9.50	8.32
		CH 46	5230		15.00	12.83
		CH 54	5270		15.00	12.66
		CH 62	5310		9.00	7.69
		CH 102	5510		9.50	7.37
		CH 110	5550		15.00	11.72
		CH 118	5590		15.00	11.98
		CH 126	5630		15.00	12.03
		CH 134	5670		9.50	8.07
		CH 151	5755		15.00	11.69
	CH 159	5795	14.50		11.82	
	Sum	CH 38	5190		12.51	11.10
		CH 46	5230		18.27	16.04
		CH 54	5270		18.27	15.93
		CH 62	5310		12.01	10.63
		CH 102	5510		12.51	10.82
		CH 110	5550		18.27	15.57
		CH 118	5590		18.27	15.91
		CH 126	5630		18.27	15.90
		CH 134	5670		12.51	11.04
CH 151		5755	18.27	14.97		
CH 159	5795	17.51	14.83			
Mode	Antenna	Channel	Frequency (MHz)	Data Rate (Mbps)	Tune-up Max.	Average Power (dBm)
802.11ac MIMO 80M	Ant3(Core0)	CH 42	5210	MCS0	6.50	3.87
		CH 58	5290		6.50	3.37
		CH 106	5530		6.50	3.51
		CH 122	5610		6.50	3.35
		CH 155	5775		11.50	9.21
	Ant4(Core1)	CH 42	5210		6.50	4.29
		CH 58	5290		6.50	4.52
		CH 106	5530		6.50	3.60
		CH 122	5610		6.50	3.96
		CH 155	5775		11.50	9.36
	Sum	CH 42	5210		9.51	7.10
		CH 58	5290		9.51	6.99
		CH 106	5530		9.51	6.57
		CH 122	5610		9.51	6.68
		CH 155	5775		14.51	12.30
Mode	Antenna	Channel	Frequency (MHz)	Data Rate (Mbps)	Tune-up Max.	Average Power (dBm)
802.11ac MIMO 160	Ant3(Core0)	CH 50	5250	MCS0	6.50	3.30
		CH 114	5570		6.50	3.33
	Ant4(Core1)	CH 50	5250		6.50	4.29
		CH 114	5570		6.50	3.09
	Sum	CH 50	5250		9.51	6.83
		CH 114	5570		9.51	6.22

Table 160: Conducted power measurement results of WiFi 5G CDD/MIMO (Receiver off)

Note:

- 1) The Average conducted power of WiFi is measured with RMS detector.
- 2) As different maximum tune-up output power is specified across the different channels range. So the additional conducted power measurement for the adjacent channel of each power level stage is also performed in this report to ensure compliance.
- 3) The MCC should be set to the FCC mobile country code. WIFI SAR Test should be evaluated at the power level of FCC mobile country code for each exposure conditions.

7.1.36 Conducted power measurements of BT

BT	Tune-up	Average Conducted Power (dBm)		
	Max.	0CH	13CH	26CH
DH5	17.30	15.86	16.87	16.05
2DH5	15.30	13.94	14.97	14.15
3DH5	15.30	13.93	14.93	14.15
BT	Tune-up	Average Conducted Power (dBm)		
	Max.	27CH	41CH	65CH
DH5	16.30	15.96	15.35	14.96
2DH5	14.30	14.07	13.45	13.09
3DH5	14.30	14.06	13.45	13.07
BT	Tune-up	Average Conducted Power (dBm)		
	Max.	66CH	72CH	78CH
DH5	15.30	14.89	14.44	13.46
2DH5	13.40	13.03	12.57	11.63
3DH5	13.40	13.00	12.55	11.59

Table 161: Conducted power measurement results of BT (High Power level A)

BT	Tune-up	Average Conducted Power (dBm)		
	Max.	0CH	5CH	10CH
DH5	10.50	9.35	9.47	8.78
2DH5	8.50	7.54	7.48	6.79
3DH5	8.50	7.54	7.49	6.71
BT	Tune-up	Average Conducted Power (dBm)		
	Max.	11CH	39CH	68CH
DH5	11.00	9.40	9.58	9.14
2DH5	9.00	6.81	7.74	7.71
3DH5	9.00	6.81	7.75	7.72
BT	Tune-up	Average Conducted Power (dBm)		
	Max.	69CH	73CH	78CH
DH5	10.00	9.42	8.93	7.91
2DH5	8.50	7.66	7.10	6.07
3DH5	8.50	7.66	7.11	6.07
BT	Tune-up	Average Conducted Power (dBm)		
	Max.	0CH	2CH	5CH
BLE	8.00	7.65	7.90	7.91
BT	Tune-up	Average Conducted Power (dBm)		
	Max.	6CH	18CH	31CH
BLE	9.00	8.07	8.46	8.10
BT	Tune-up	Average Conducted Power (dBm)		
	Max.	32CH	35CH	39CH
BLE	7.50	7.33	7.32	7.37

Table 162: Conducted power measurement results of BT (Normal Power level B)

BT	Tune-up	Average Conducted Power (dBm)		
	Max.	0CH	4CH	8CH
UHD GFSK 1Mbps HP	16.3	13.91	14.49	14.75
UHD GFSK 2Mbps HP	16.3	14.04	14.58	14.88
UHD 2M HP	16.2	14.03	14.60	14.86
UHD 2M 8DPSK HP	16.3	14.18	14.73	14.98
BT	Tune-up	Average Conducted Power (dBm)		
	Max.	9CH	14CH	18CH
UHD GFSK 1Mbps HP	16	14.71	13.55	13.42
UHD GFSK 2Mbps HP	15.8	14.80	13.68	13.53
UHD 2M HP	15.7	14.79	13.66	13.55
UHD 2M 8DPSK HP	15.8	14.93	13.79	13.66
BT	Tune-up	Average Conducted Power (dBm)		
	Max.	19CH	26CH	32CH
UHD GFSK 1Mbps HP	15.7	13.33	14.08	12.89
UHD GFSK 2Mbps HP	15.5	13.43	14.19	13.02
UHD 2M HP	15.2	13.46	14.21	13.02
UHD 2M 8DPSK HP	15.5	13.58	14.31	13.13
BT	Tune-up	Average Conducted Power (dBm)		
	Max.	33CH	35CH	37CH
UHD GFSK 1Mbps HP	14.5	12.61	12.33	12.02
UHD GFSK 2Mbps HP	14.3	12.72	12.44	12.15
UHD 2M HP	14.2	12.75	12.46	12.16
UHD 2M 8DPSK HP	14.3	12.85	12.56	12.26
BT	Tune-up	Average Conducted Power (dBm)		
	Max.	0CH	6CH	10CH
UHD 4M	14.9	13.96	14.65	14.53
	Max.	12CH	16CH	20CH
	14	13.99	13.46	13.36
	Max.	22CH	26CH	28CH
	14.3	13.73	14.12	14.02
	Max.	30CH	34CH	36CH
	13.5	13.48	12.38	12.28

Table 163: Conducted power measurement results of BT UHD(High Power Level A)

BT	Tune-up	Average Conducted Power (dBm)		
	Max.	0CH	2CH	3CH
UHD GFSK 1Mbps HP	7.20	4.98	5.12	5.24
UHD GFSK 2Mbps HP	7.20	5.18	5.31	5.38
UHD 2M HP	7.10	5.87	5.99	6.08
UHD 2M 8DPSK HP	7.70	5.96	6.08	6.16
BT	Tune-up	Average Conducted Power (dBm)		
	Max.	4CH	8CH	11CH
UHD GFSK 1Mbps HP	7.70	5.38	5.28	5.70
UHD GFSK 2Mbps HP	7.70	5.52	5.35	5.81
UHD 2M HP	7.50	6.23	6.14	6.47
UHD 2M 8DPSK HP	8.00	6.30	6.21	6.54
BT	Tune-up	Average Conducted Power (dBm)		
	Max.	12CH	19CH	26CH
UHD GFSK 1Mbps HP	8.00	5.81	6.12	5.45
UHD GFSK 2Mbps HP	8.00	5.92	6.23	5.54
UHD 2M HP	7.90	6.58	6.91	6.26
UHD 2M 8DPSK HP	8.50	6.63	6.98	6.33
BT	Tune-up	Average Conducted Power (dBm)		
	Max.	27CH	32CH	37CH
UHD GFSK 1Mbps HP	7.50	5.68	5.78	5.03
UHD GFSK 2Mbps HP	7.50	5.77	5.88	5.10
UHD 2M HP	7.70	6.46	6.49	5.76
UHD 2M 8DPSK HP	8.00	6.53	6.56	5.84
BT	Tune-up	Average Conducted Power (dBm)		
	Max.	0CH	4CH	8CH
UHD 4M	6.50	5.17	5.52	5.36
	Max.	10CH	22CH	32CH
	7.10	5.71	5.78	5.79
	Max.	34CH	/	36CH
	6.50	5.50		5.34

Table 164: Conducted power measurement results of BT UHD(Power Level B)

Note:

- 1)The conducted power of BT is measured with RMS detector.
- 2)The bolded mode was selected for SAR testing.
- 3)As different maximum tune-up output power is specified across the different channels range. So the additional conducted power measurement for the adjacent channel of each power level stage is also performed in this report to ensure compliance.
- 4) BT BLE does not support High power level A mode.

Figure: Bluetooth Transmission Plot

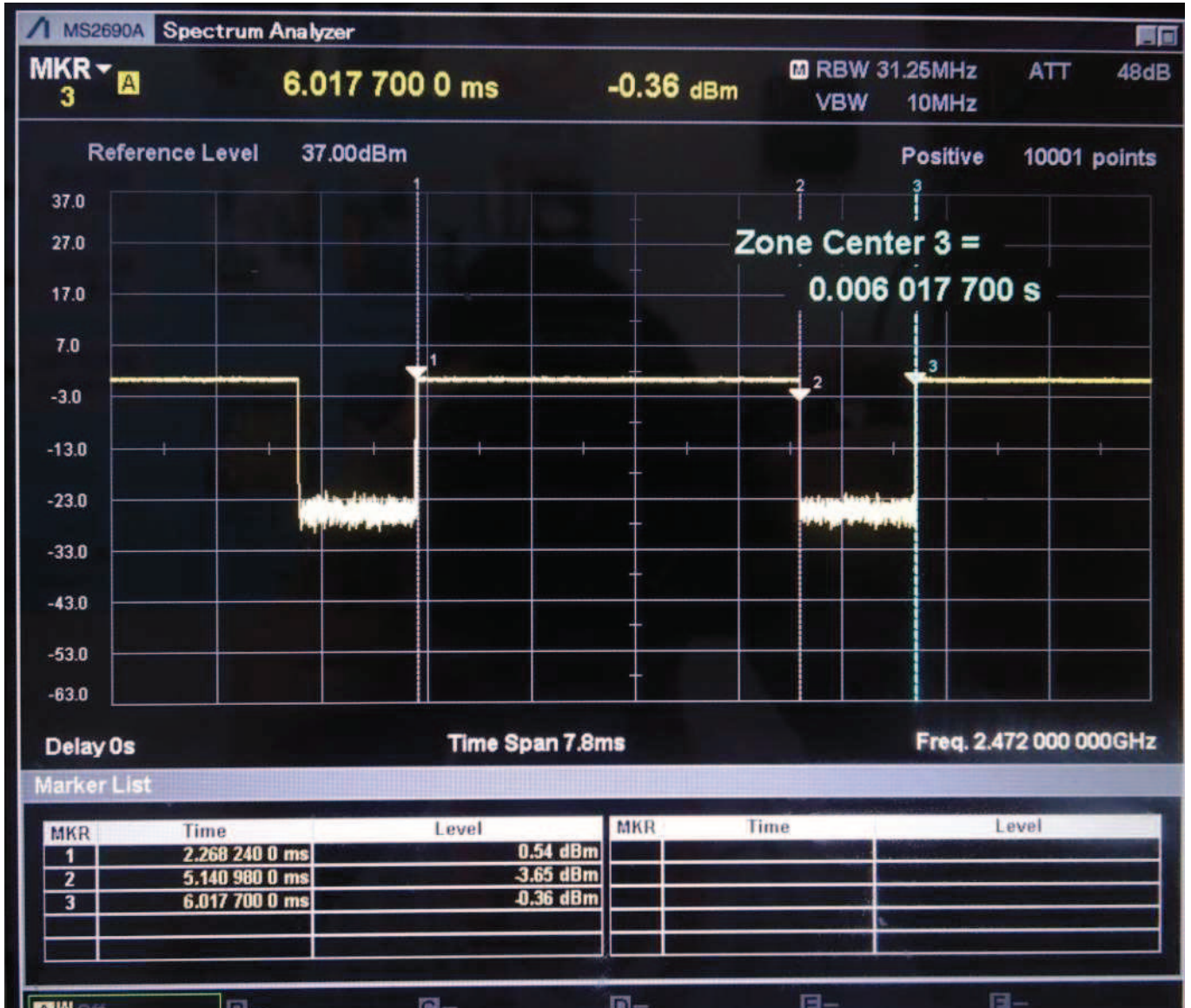

So the actual bluetooth duty cycle is calculated as below:

$$\text{Dutycycle} = \text{pulse} \frac{\text{width}}{\text{period}} * 100\% = \frac{2.87274\text{ms}}{3.74946\text{ms}} * 100\% = 76.6\%$$

7.2 SAR measurement Results

General Notes:

- 1) Per KDB 447498 D01, all SAR measurement results are scaled to the maximum tune-up tolerance limit to demonstrate SAR compliance.
- 2) Per KDB 447498 D01, testing of other required channels within the operating mode of a frequency band is not required when the reported 1-g or 10-g SAR for the mid-band or highest output power channel is:
 - $\leq 0.8\text{W/kg}$ for 1-g or 2.0W/kg for 10-g respectively, when the transmission band is $\leq 100\text{MHz}$.
 - $\leq 0.6\text{ W/kg}$ or 1.5 W/kg , for 1-g or 10-g respectively, when the transmission band is between 100 MHz and 200 MHz.
 - $\leq 0.4\text{ W/kg}$ or 1.0 W/kg , for 1-g or 10-g respectively, when the transmission band is $\geq 200\text{ MHz}$.When the maximum output power variation across the required test channels is $> \frac{1}{2}\text{ dB}$, instead of the middle channel, the highest output power channel must be used.
- 3) Per KDB 865664 D01, for each frequency band, repeated SAR measurement is required only when the measured SAR is $\geq 0.8\text{W/kg}$; if the deviation among the repeated measurement is $\leq 20\%$, and the measured SAR $< 1.45\text{W/kg}$, only one repeated measurement is required.
- 4) Per KDB 941225 D06, the DUT Dimension is bigger than 9 cm x 5 cm, so 10mm is chosen as the test separation distance for Hotspot mode. When the antenna-to-edge distance is greater than 2.5cm, such position does not need to be tested.
- 5) Per KDB 648474 D04, SAR is evaluated without a headset connected to the device. When the standalone reported body-worn SAR is $\leq 1.2\text{ W/kg}$, no additional SAR evaluations using a headset are required.
- 6) Per KDB 865664 D02, SAR plot is only required for the highest measured SAR in each exposure configuration, wireless mode and frequency band combination; Plots are also required when the measured SAR is $> 1.5\text{ W/kg}$, or $> 7.0\text{ W/kg}$ for occupational exposure. The published RF exposure KDB procedures may require additional plots; for example, to support SAR to peak location separation ratio test exclusion and/or volume scan post-processing (Refer to appendix B for details).
- 7) Per KDB 648474 D04, Body-worn accessories that do not contain metallic or conductive components is tested according to worst-case exposure configurations, typically according to the smallest test separation distance required for the group of body-worn accessories with similar operating and exposure characteristics.
- 8) Per KDB 648474 D04, Phones with built-in NFC functions do not require separate SAR testing and can generally be tested according to the SAR measurement procedures normally required for the phone. Influences of the hardware introduced by the built-in NFC functions are inherently considered through testing of the other transmitters that require SAR evaluation.
- 9) For this device, the receiver is designed under the screen and invisible. In order to solve the head positioning issue and locate the receiver accurately during Head SAR test, the test lab should follow the manufacturer specification and precisely identify the earpiece location and the best acoustic position on the handset. For Head SAR test, full SAR test is performed with the normal audio receiver position per IEEE 1528-2013. Additional Head SAR spot check tests are also performed with the best acoustic position based on the Head SAR worst case of each Tx antenna to ensure SAR compliance.

GSM Notes:

1) Per KDB941225 D01, SAR test reduction for GPRS and EDGE modes is determined by the source-based time-averaged output power specified for production units, including tune-up tolerance. The data mode with highest specified time-averaged output power should be tested for SAR compliance in the applicable exposure conditions. For modes with the same specified maximum output power and tolerance, the higher number time-slot configuration should be tested.

2) Per KDB 648474 D04, the device does not support DTM function. Body-worn accessory testing is typically associated with voice operations. Therefore, GSM voice was evaluated for body-worn SAR.

UMTS Notes:

1) Per KDB 941225 D01, When the maximum output power and tune-up tolerance specified for production units in a Second mode is $\leq \frac{1}{4}$ dB higher than the primary mode or when the highest reported SAR of the primary mode is scaled by the ratio of specified maximum output power and tune-up tolerance of Second to primary mode and the adjusted SAR is ≤ 1.2 W/kg, SAR measurement is not required for the Second mode.

LTE Notes:

1) The LTE test configurations are determined according to KDB 941225 D05 SAR for LTE Devices. The general test procedures used for SAR testing can be found in Section 6.5.

2) A-MPR was disabled for all SAR test by setting NS_01 on the base station simulator. SAR tests were performed with the same number of RB and RB offsets transmitting on all TTI frames (maximum TTI)

3) According to KDB 941225 D05 SAR for LTE Devices, for Time-Division Duplex (TDD) systems, SAR is tested using a fixed periodic duty factor according to the highest transmission duty factor (63.33%) implemented for the device and supported by the defined 3GPP LTE TDD configurations.

WiFi Notes:

Per KDB 248227D01:

1) When reported SAR for the initial test position is ≤ 0.4 W/kg, no additional testing for the remaining test position is required. Otherwise, SAR is evaluated at the subsequent highest peak SAR position until the reported SAR result is ≤ 0.8 W/kg or all test position are measured. For all positions/configurations tested using the initial test position and subsequent test positions, when the *reported* SAR is > 0.8 W/kg, SAR is measured for these test positions/configurations on the subsequent next highest measured output power channel(s) until the *reported* SAR is ≤ 1.2 W/kg or all required channels are tested..

2) When the DSSS *reported* SAR of the highest measured maximum output power channel for the exposure configuration is ≤ 0.8 W/kg, no further SAR testing is required for 802.11b DSSS in that exposure configuration.

3) When the highest *reported* SAR for DSSS is adjusted by the ratio of OFDM to DSSS specified maximum output power and the adjusted SAR is ≤ 1.2 W/kg, SAR measurement is required for 2.4 GHz 802.11g/n OFDM configurations

4) The highest SAR measured for the initial test position or initial test configuration should be used to determine SAR test exclusion according to the sum of 1-g SAR and SAR peak to location ratio provisions in KDB 447498. In addition, a test lab may also choose to perform standalone SAR measurements for test positions and 802.11 configurations that are not required by the initial test position or initial test configuration procedures and apply the results to determine simultaneous transmission SAR test exclusion, according to sum of 1-g and SAR peak to location ratio requirements to reduce the number of simultaneous transmission SAR measurements.

7.2.1 SAR measurement Results of GSM850

Test Position of Head	Test Channel /Freq.(MHz)	Test Mode	Measured SAR(W/kg)		Power Drift (dB)	Conducted Power (dBm)	Tune-up Power (dBm)	Reported 1-g SAR (W/kg)	Accessory Information	SAR Plot.
			1-g	10-g						
Second Antenna										
Left cheek	190/836.6	GSM	0.355	0.173	0.00	28.07	29.00	0.440	Battery 1#	/
Left tilt	190/836.6	GSM	0.336	0.159	0.01	28.07	29.00	0.416	Battery 1#	/
Right cheek	190/836.6	GSM	0.343	0.179	-0.03	28.07	29.00	0.425	Battery 1#	/
Right tilt	190/836.6	GSM	0.313	0.150	-0.04	28.07	29.00	0.388	Battery 1#	/
Left cheek	190/836.6	GSM	0.352	0.171	-0.05	28.07	29.00	0.436	Battery 2#	/
Left cheek	128/824.2	GSM	0.353	0.175	-0.03	27.88	29.00	0.457	Battery 1#	/
Left cheek	251/848.8	GSM	0.361	0.178	-0.03	28.10	29.00	0.444	Battery 1#	Yes
Main Antenna										
Left cheek	190/836.6	GSM	0.093	0.071	0.06	33.43	34.00	0.105	Battery 1#	/
Left tilt	190/836.6	GSM	0.057	0.039	0.04	33.43	34.00	0.065	Battery 1#	/
Right cheek	190/836.6	GSM	0.115	0.089	0.19	33.43	34.00	0.131	Battery 1#	/
Right tilt	190/836.6	GSM	0.041	0.029	-0.04	33.43	34.00	0.047	Battery 1#	/
Right cheek	190/836.6	GSM	0.113	0.087	-0.03	33.43	34.00	0.129	Battery 2#	/
Right cheek	128/824.2	GSM	0.103	0.080	-0.02	33.48	34.00	0.116	Battery 1#	/
Right cheek	251/848.8	GSM	0.130	0.101	-0.12	33.41	34.00	0.149	Battery 1#	Yes

Table 165: Head SAR test results of GSM850

Test Position of Body-Worn	Dist.	Test Channel /Freq.(MHz)	Test Mode	Measured SAR(W/kg)		Power Drift (dB)	Conducted Power (dBm)	Tune-up Power (dBm)	Reported 1-g SAR (W/kg)	Accessory Information	SAR Plot.
				1-g	10-g						
Second Antenna											
Front Side	15mm	190/836.6	GSM	0.266	0.176	-0.02	33.40	34.00	0.305	Battery 1#	/
Back Side	15mm	190/836.6	GSM	0.270	0.183	-0.15	33.40	34.00	0.310	Battery 1#	Yes
Back Side	15mm	190/836.6	GSM	0.260	0.174	-0.06	33.40	34.00	0.299	Battery 2#	/
Back Side	15mm	128/824.2	GSM	0.229	0.157	-0.12	33.37	34.00	0.265	Battery 1#	/
Back Side	15mm	251/848.8	GSM	0.199	0.134	-0.07	33.45	34.00	0.226	Battery 1#	/
Main Antenna											
Front Side	15mm	190/836.6	GSM	0.233	0.159	0.16	33.43	34.00	0.266	Battery 1#	/
Back Side	15mm	190/836.6	GSM	0.242	0.171	-0.16	33.43	34.00	0.276	Battery 1#	/
Back Side	15mm	190/836.6	GSM	0.255	0.180	-0.07	33.43	34.00	0.291	Battery 2#	/
Back Side	15mm	128/824.2	GSM	0.242	0.172	-0.04	33.48	34.00	0.273	Battery 2#	/
Back Side	15mm	251/848.8	GSM	0.288	0.202	-0.08	33.41	34.00	0.330	Battery 2#	Yes

Table 166: Body Worn SAR test results of GSM850

Test Position of Hotspot	Dist.	Test Channel /Freq.(MHz)	Test Mode	Measured SAR(W/kg)		Power Drift (dB)	Conducted Power (dBm)	Tune-up Power (dBm)	Reported 1-g SAR (W/kg)	Accessory Information	SAR Plot.
				1-g	10-g						
Second Antenna											
Front Side	10mm	190/836.6	GPRS 2TS	0.622	0.377	-0.03	31.10	32.00	0.765	Battery 1#	/
Back Side	10mm	190/836.6	GPRS 2TS	0.647	0.359	-0.06	31.10	32.00	0.796	Battery 1#	Yes
Left Side	10mm	190/836.6	GPRS 2TS	0.215	0.144	-0.01	31.10	32.00	0.265	Battery 1#	/
Top Side	10mm	190/836.6	GPRS 2TS	0.364	0.172	-0.02	31.10	32.00	0.448	Battery 1#	/
Back Side	10mm	190/836.6	GPRS 2TS	0.589	0.328	-0.06	31.10	32.00	0.725	Battery 2#	/
Back Side	10mm	128/824.2	GPRS 2TS	0.578	0.326	-0.04	30.82	32.00	0.758	Battery 1#	/
Back Side	10mm	251/848.8	GPRS 2TS	0.511	0.302	-0.05	30.99	32.00	0.645	Battery 1#	/
Main Antenna											
Front Side	10mm	190/836.6	GPRS 2TS	0.307	0.210	-0.05	31.17	32.00	0.372	Battery 1#	/
Back Side	10mm	190/836.6	GPRS 2TS	0.404	0.275	-0.04	31.17	32.00	0.489	Battery 1#	/
Left Side	10mm	190/836.6	GPRS 2TS	0.271	0.140	-0.13	31.17	32.00	0.328	Battery 1#	/
Right Side	10mm	190/836.6	GPRS 2TS	0.134	0.089	-0.02	31.17	32.00	0.162	Battery 1#	/
Bottom Side	10mm	190/836.6	GPRS 2TS	0.289	0.182	0.06	31.17	32.00	0.350	Battery 1#	/
Back Side	10mm	190/836.6	GPRS 2TS	0.437	0.298	0.06	31.17	32.00	0.529	Battery 2#	/
Back Side	10mm	128/824.2	GPRS 2TS	0.402	0.275	-0.09	31.16	32.00	0.488	Battery 2#	/
Back Side	10mm	251/848.8	GPRS 2TS	0.495	0.336	0.01	31.28	32.00	0.584	Battery 2#	Yes

Table 167: Hotspot SAR test results of GSM850

Note: Per KDB 648474 D04, Product Specific 10-g SAR test is not required for this frequency band since hotspot mode 1-g reported SAR < 1.2 W/kg.

7.2.2 SAR measurement Results of GSM1900

Test Position of Head	Test Channel /Freq.(MHz)	Test Mode	Measured SAR(W/kg)		Power Drift (dB)	Conducted Power (dBm)	Tune-up Power (dBm)	Reported 1-g SAR (W/kg)	Accessory Information	SAR Plot.
			1-g	10-g						
Second Antenna										
Left cheek	661/1880	GSM	0.155	0.087	0.10	27.10	28.00	0.191	Battery 1#	/
Left tilt	661/1880	GSM	0.213	0.100	0.10	27.10	28.00	0.262	Battery 1#	/
Right cheek	661/1880	GSM	0.224	0.110	-0.03	27.10	28.00	0.276	Battery 1#	/
Right tilt	661/1880	GSM	0.354	0.169	0.13	27.10	28.00	0.436	Battery 1#	/
Right tilt	661/1880	GSM	0.387	0.187	0.00	27.10	28.00	0.476	Battery 2#	/
Right tilt	512/1850.2	GSM	0.366	0.177	0.06	26.77	28.00	0.486	Battery 2#	/
Right tilt	810/1909.8	GSM	0.475	0.228	0.00	27.32	28.00	0.556	Battery 2#	Yes
Main Antenna										
Left cheek	661/1880	GSM	0.065	0.040	0.08	30.20	31.00	0.078	Battery 1#	/
Left tilt	661/1880	GSM	0.040	0.024	-0.07	30.20	31.00	0.048	Battery 1#	/
Right cheek	661/1880	GSM	0.081	0.051	0.14	30.20	31.00	0.098	Battery 1#	Yes
Right tilt	661/1880	GSM	0.033	0.019	0.11	30.20	31.00	0.039	Battery 1#	/
Right cheek	661/1880	GSM	0.071	0.042	0.16	30.20	31.00	0.086	Battery 2#	/
Right cheek	512/1850.2	GSM	0.068	0.043	-0.03	29.95	31.00	0.086	Battery 1#	/
Right cheek	810/1909.8	GSM	0.070	0.045	-0.10	30.22	31.00	0.083	Battery 1#	/

Table 168: Head SAR test results of GSM1900

Test Position of Body-Worn	Dist.	Test Channel /Freq.(MHz)	Test Mode	Measured SAR(W/kg)		Power Drift (dB)	Conducted Power (dBm)	Tune-up Power (dBm)	Reported 1-g SAR (W/kg)	Accessory Information	SAR Plot.
				1-g	10-g						
Second Antenna											
Front Side	15mm	661/1880	GSM	0.027	0.015	0.08	29.48	30.00	0.030	Battery 1#	/
Back Side	15mm	661/1880	GSM	0.031	0.019	0.03	29.48	30.00	0.035	Battery 1#	/
Back Side	15mm	661/1880	GSM	0.066	0.041	-0.09	29.48	30.00	0.075	Battery 2#	Yes
Back Side	15mm	512/1850.2	GSM	0.030	0.017	0.16	29.14	30.00	0.037	Battery 2#	/
Back Side	15mm	810/1909.8	GSM	0.033	0.020	0.11	29.57	30.00	0.036	Battery 2#	/
Main Antenna											
Front Side	15mm	661/1880	GSM	0.102	0.061	0.10	30.20	31.00	0.123	Battery 1#	/
Back Side	15mm	661/1880	GSM	0.131	0.089	-0.06	30.20	31.00	0.157	Battery 1#	/
Back Side	15mm	661/1880	GSM	0.129	0.087	-0.06	30.20	31.00	0.155	Battery 2#	/
Back Side	15mm	512/1850.2	GSM	0.135	0.092	0.03	29.95	31.00	0.172	Battery 1#	/
Back Side	15mm	810/1909.8	GSM	0.139	0.095	0.03	30.22	31.00	0.166	Battery 1#	Yes

Table 169: Body Worn SAR test results of GSM1900

Test Position of Hotspot	Dist.	Test Channel /Freq.(MHz)	Test Mode	Measured SAR(W/kg)		Power Drift (dB)	Conducted Power (dBm)	Tune-up Power (dBm)	Reported 1-g SAR (W/kg)	Accessory Information	SAR Plot.
				1-g	10-g						
Second Antenna											
Front Side	10mm	661/1880	GPRS 2TS	0.099	0.052	0.03	26.21	27.00	0.119	Battery 1#	/
Back Side	10mm	661/1880	GPRS 2TS	0.084	0.046	0.15	26.21	27.00	0.100	Battery 1#	/
Left Side	10mm	661/1880	GPRS 2TS	0.023	0.012	0.05	26.21	27.00	0.027	Battery 1#	/
Top Side	10mm	661/1880	GPRS 2TS	0.195	0.105	-0.12	26.21	27.00	0.234	Battery 1#	/
Top Side	10mm	661/1880	GPRS 2TS	0.213	0.115	0.11	26.21	27.00	0.255	Battery 2#	/
Top Side	10mm	512/1850.2	GPRS 2TS	0.225	0.121	0.18	25.88	27.00	0.291	Battery 2#	/
Top Side	10mm	810/1909.8	GPRS 2TS	0.255	0.137	0.12	26.45	27.00	0.289	Battery 2#	Yes
Main Antenna											
Front Side	10mm	661/1880	GPRS 2TS	0.219	0.123	-0.05	27.64	28.50	0.267	Battery 1#	/
Back Side	10mm	661/1880	GPRS 2TS	0.247	0.161	-0.04	27.64	28.50	0.301	Battery 1#	/
Left Side	10mm	661/1880	GPRS 2TS	0.051	0.030	-0.15	27.64	28.50	0.062	Battery 1#	/
Right Side	10mm	661/1880	GPRS 2TS	0.094	0.057	-0.19	27.64	28.50	0.115	Battery 1#	/
Bottom Side	10mm	661/1880	GPRS 2TS	0.465	0.267	-0.15	27.64	28.50	0.567	Battery 1#	Yes
Bottom Side	10mm	661/1880	GPRS 2TS	0.404	0.233	-0.07	27.64	28.50	0.492	Battery 2#	/
Bottom Side	10mm	512/1850.2	GPRS 2TS	0.426	0.247	-0.05	27.59	28.50	0.525	Battery 1#	/
Bottom Side	10mm	810/1909.8	GPRS 2TS	0.429	0.247	-0.07	27.63	28.50	0.524	Battery 1#	/

Table 170: Hotspot SAR test results of GSM1900

Per KDB648474D04, when hotspot mode applies, Product Specific 10-g SAR is required only for the surfaces and edges with hotspot mode 1-g reported SAR > 1.2 W/kg; however, when power reduction applies to hotspot mode the measured SAR must be scaled to the maximum output power, including tolerance, allowed for phablet modes to compare with the 1.2 W/kg SAR test reduction threshold:

Test Position of Hotspot	Dist.	Test Channel /Freq.(MHz)	Test Mode	Measured SAR(W/kg)		Power Drift (dB)	Conducted Power (dBm)	Max Power Without Reduction	Scaled-up 1-g SAR (W/kg)	Product Specific 10-g SAR Exclusion
				1-g	10-g					
Second Antenna										
Front Side	10mm	661/1880	GPRS 2TS	0.099	0.052	0.03	26.21	28.00	0.150	Yes
Back Side	10mm	661/1880	GPRS 2TS	0.084	0.046	0.15	26.21	28.00	0.126	Yes
Left Side	10mm	661/1880	GPRS 2TS	0.023	0.012	0.05	26.21	28.00	0.034	Yes
Top Side	10mm	661/1880	GPRS 2TS	0.195	0.105	-0.12	26.21	28.00	0.294	Yes
Top Side	10mm	661/1880	GPRS 2TS	0.213	0.115	0.11	26.21	28.00	0.322	Yes
Top Side	10mm	512/1850.2	GPRS 2TS	0.225	0.121	0.18	25.88	28.00	0.367	Yes
Top Side	10mm	810/1909.8	GPRS 2TS	0.255	0.137	0.12	26.45	28.00	0.364	Yes
Main Antenna										
Front Side	10mm	661/1880	GPRS 2TS	0.219	0.123	-0.05	27.64	29.00	0.300	Yes
Back Side	10mm	661/1880	GPRS 2TS	0.247	0.161	-0.04	27.64	29.00	0.338	Yes
Left Side	10mm	661/1880	GPRS 2TS	0.051	0.030	-0.15	27.64	29.00	0.070	Yes
Right Side	10mm	661/1880	GPRS 2TS	0.094	0.057	-0.19	27.64	29.00	0.129	Yes
Bottom Side	10mm	661/1880	GPRS 2TS	0.465	0.267	-0.15	27.64	29.00	0.636	Yes
Bottom Side	10mm	661/1880	GPRS 2TS	0.404	0.233	-0.07	27.64	29.00	0.553	Yes
Bottom Side	10mm	512/1850.2	GPRS 2TS	0.426	0.247	-0.05	27.59	29.00	0.589	Yes
Bottom Side	10mm	810/1909.8	GPRS 2TS	0.429	0.247	-0.07	27.63	29.00	0.588	Yes

Table 171: Product Specific 10-g SAR test reduction evaluation of GSM1900

Note: Per KDB 648474 D04, Product Specific 10-g SAR test is not required for this frequency band.

7.2.3 SAR measurement Results of UMTS Band II

Test Position of Head	Test Channel /Freq.(MHz)	Test Mode	Measured SAR(W/kg)		Power Drift (dB)	Conducted Power (dBm)	Tune-up Power (dBm)	Reported 1-g SAR (W/kg)	Accessory Information	SAR Plot.
			1-g	10-g						
Second Antenna										
Left cheek	9400/1880	RMC	0.233	0.113	0.14	17.54	18.50	0.291	Battery 1#	/
Left tilt	9400/1880	RMC	0.331	0.155	0.13	17.54	18.50	0.413	Battery 1#	/
Right cheek	9400/1880	RMC	0.297	0.144	0.12	17.54	18.50	0.370	Battery 1#	/
Right tilt	9400/1880	RMC	0.406	0.195	0.07	17.54	18.50	0.506	Battery 1#	/
Right tilt	9400/1880	RMC	0.409	0.197	-0.07	17.54	18.50	0.510	Battery 2#	/
Right tilt	9262/1852.4	RMC	0.441	0.211	0.05	17.65	18.50	0.536	Battery 2#	/
Right tilt	9538/1907.6	RMC	0.443	0.212	0.05	17.62	18.50	0.543	Battery 2#	Yes
Main Antenna										
Left cheek	9400/1880	RMC	0.137	0.079	0.15	23.77	25.00	0.182	Battery 1#	/
Left tilt	9400/1880	RMC	0.068	0.038	0.18	23.77	25.00	0.091	Battery 1#	/
Right cheek	9400/1880	RMC	0.144	0.091	0.04	23.77	25.00	0.191	Battery 1#	/
Right tilt	9400/1880	RMC	0.072	0.039	0.12	23.77	25.00	0.095	Battery 1#	/
Right cheek	9400/1880	RMC	0.160	0.101	0.10	23.77	25.00	0.212	Battery 2#	/
Right cheek	9262/1852.4	RMC	0.150	0.095	-0.02	23.80	25.00	0.198	Battery 2#	/
Right cheek	9538/1907.6	RMC	0.175	0.109	-0.01	23.94	25.00	0.223	Battery 2#	Yes

Table 172: Head SAR test results of UMTS Band II

Test Position of Body-Worn	Dist.	Test Channel /Freq.(MHz)	Test Mode	Measured SAR(W/kg)		Power Drift (dB)	Conducted Power (dBm)	Tune-up Power (dBm)	Reported 1-g SAR (W/kg)	Accessory Information	SAR Plot.
				1-g	10-g						
Second Antenna											
Front Side	15mm	9400/1880	RMC	0.080	0.045	-0.15	22.54	23.50	0.100	Battery 1#	/
Back Side	15mm	9400/1880	RMC	0.109	0.069	-0.10	22.54	23.50	0.136	Battery 1#	/
Back Side	15mm	9400/1880	RMC	0.118	0.074	-0.11	22.54	23.50	0.147	Battery 2#	/
Back Side	15mm	9262/1852.4	RMC	0.125	0.079	0.11	22.61	23.50	0.153	Battery 2#	Yes
Back Side	15mm	9538/1907.6	RMC	0.108	0.062	0.11	22.63	23.50	0.132	Battery 2#	/
Main Antenna											
Front Side	15mm	9400/1880	RMC	0.200	0.122	-0.15	23.77	25.00	0.265	Battery 1#	/
Back Side	15mm	9400/1880	RMC	0.285	0.190	-0.17	23.77	25.00	0.378	Battery 1#	/
Back Side	15mm	9400/1880	RMC	0.370	0.247	0.00	23.77	25.00	0.491	Battery 2#	/
Back Side	15mm	9262/1852.4	RMC	0.357	0.239	-0.08	23.80	25.00	0.471	Battery 2#	/
Back Side	15mm	9538/1907.6	RMC	0.389	0.259	-0.06	23.94	25.00	0.497	Battery 2#	Yes

Table 173: Body Worn SAR test results of UMTS Band II

Test Position of Hotspot	Dist.	Test Channel /Freq.(MHz)	Test Mode	Measured SAR(W/kg)		Power Drift (dB)	Conducted Power (dBm)	Tune-up Power (dBm)	Reported 1-g SAR (W/kg)	Accessory Information	SAR Plot.
				1-g	10-g						
Second Antenna											
Front Side	10mm	9400/1880	RMC	0.088	0.047	0.03	19.52	20.50	0.110	Battery 1#	/
Back Side	10mm	9400/1880	RMC	0.110	0.057	-0.17	19.52	20.50	0.138	Battery 1#	/
Left Side	10mm	9400/1880	RMC	0.022	0.012	-0.14	19.52	20.50	0.027	Battery 1#	/
Top Side	10mm	9400/1880	RMC	0.247	0.132	0.11	19.52	20.50	0.310	Battery 1#	Yes
Top Side	10mm	9400/1880	RMC	0.203	0.104	0.03	19.52	20.50	0.254	Battery 2#	/
Top Side	10mm	9262/1852.4	RMC	0.222	0.113	0.06	19.58	20.50	0.274	Battery 1#	/
Top Side	10mm	9538/1907.6	RMC	0.237	0.121	-0.01	19.49	20.50	0.299	Battery 1#	/
Main Antenna											
Front Side	10mm	9400/1880	RMC	0.237	0.132	-0.12	20.72	22.00	0.318	Battery 1#	/
Back Side	10mm	9400/1880	RMC	0.170	0.095	-0.14	20.72	22.00	0.228	Battery 1#	/
Left Side	10mm	9400/1880	RMC	0.054	0.031	0.06	20.72	22.00	0.072	Battery 1#	/
Right Side	10mm	9400/1880	RMC	0.089	0.050	-0.16	20.72	22.00	0.120	Battery 1#	/
Bottom Side	10mm	9400/1880	RMC	0.489	0.283	-0.04	20.72	22.00	0.657	Battery 1#	/
Bottom Side	10mm	9400/1880	RMC	0.454	0.245	0.01	20.72	22.00	0.610	Battery 2#	/
Bottom Side	10mm	9262/1852.4	RMC	0.511	0.296	-0.09	20.77	22.00	0.678	Battery 1#	Yes
Bottom Side	10mm	9538/1907.6	RMC	0.293	0.162	-0.07	20.89	22.00	0.378	Battery 1#	/

Table 174: Hotspot SAR test results of UMTS Band II

Per KDB648474D04, when hotspot mode applies, Product Specific 10-g SAR is required only for the surfaces and edges with hotspot mode 1-g reported SAR > 1.2 W/kg; however, when power reduction applies to hotspot mode the measured SAR must be scaled to the maximum output power, including tolerance, allowed for phablet modes to compare with the 1.2 W/kg SAR test reduction threshold:

Test Position of Hotspot	Dist.	Test Channel /Freq.(MHz)	Test Mode	Measured SAR(W/kg)		Power Drift (dB)	Conducted Power (dBm)	Max Power Without Reduction	Scaled-up 1-g SAR (W/kg)	Product Specific 10-g SAR Exclusion
				1-g	10-g					
Second Antenna										
Front Side	10mm	9400/1880	RMC	0.088	0.047	0.03	19.52	23.50	0.219	Yes
Back Side	10mm	9400/1880	RMC	0.110	0.057	-0.17	19.52	23.50	0.275	Yes
Left Side	10mm	9400/1880	RMC	0.022	0.012	-0.14	19.52	23.50	0.055	Yes
Top Side	10mm	9400/1880	RMC	0.247	0.132	0.11	19.52	23.50	0.618	Yes
Top Side	10mm	9400/1880	RMC	0.203	0.104	0.03	19.52	23.50	0.508	Yes
Top Side	10mm	9262/1852.4	RMC	0.222	0.113	0.06	19.58	23.50	0.547	Yes
Top Side	10mm	9538/1907.6	RMC	0.237	0.121	-0.01	19.49	23.50	0.597	Yes
Main Antenna										
Front Side	10mm	9400/1880	RMC	0.237	0.132	-0.12	20.72	25.00	0.635	Yes
Back Side	10mm	9400/1880	RMC	0.170	0.095	-0.14	20.72	25.00	0.455	Yes
Left Side	10mm	9400/1880	RMC	0.054	0.031	0.06	20.72	25.00	0.144	Yes
Right Side	10mm	9400/1880	RMC	0.089	0.050	-0.16	20.72	25.00	0.239	Yes
Bottom Side	10mm	9400/1880	RMC	0.489	0.283	-0.04	20.72	25.00	1.310	No
Bottom Side	10mm	9400/1880	RMC	0.454	0.245	0.01	20.72	25.00	1.216	No
Bottom Side	10mm	9262/1852.4	RMC	0.511	0.296	-0.09	20.77	25.00	1.353	No
Bottom Side	10mm	9538/1907.6	RMC	0.293	0.162	-0.07	20.89	25.00	0.755	Yes

Table 175: Product Specific 10-g SAR test reduction evaluation of UMTS Band II

Note: According to the table above , only Bottom side is required for Product Specific 10-g SAR test in this frequency band.

Product Specific 10-g SAR	Dist.	Test Channel /Freq.(MHz)	Test Mode	Measured SAR(W/kg)		Power Drift (dB)	Conducted Power (dBm)	Tune-up Power (dBm)	Reported 10-g SAR (W/kg)	Accessory Information	SAR Plot.
				1-g	10-g						
Main Antenna											
Bottom Side	0mm	9400/1880	RMC	4.600	1.990	-0.19	19.25	20.50	2.654	Battery 1#	/
Bottom Side	0mm	9262/1852.4	RMC	3.640	1.490	-0.19	19.32	20.50	1.955	Battery 1#	/
Bottom Side	0mm	9538/1907.6	RMC	4.120	1.660	-0.18	19.42	20.50	2.129	Battery 1#	/
Bottom Side	0mm	9400/1880	RMC	4.830	2.030	-0.14	19.25	20.50	2.707	Battery 2#	/
Bottom Side -repeated	0mm	9400/1880	RMC	4.860	2.040	-0.19	19.25	20.50	2.720	Battery 2#	Yes
Additional SAR test at a conservative distance(triggering distance minus 1mm)											
Bottom Side	7mm	9400/1880	RMC	1.670	0.830	-0.19	23.77	25.00	1.102	Battery 1#	/

Table 176: Product Specific 10-g SAR test results of UMTS Band II

7.2.4 SAR measurement Results of UMTS Band IV

Test Position of Head	Test Channel /Freq.(MHz)	Test Mode	Measured SAR(W/kg)		Power Drift (dB)	Conducted Power (dBm)	Tune-up Power (dBm)	Reported 1-g SAR (W/kg)	Accessory Information	SAR Plot.
			1-g	10-g						
Second Antenna										
Left cheek	1413/1732.6	RMC	0.284	0.133	-0.11	17.38	18.50	0.368	Battery 1#	/
Left tilt	1413/1732.6	RMC	0.413	0.185	0.09	17.38	18.50	0.535	Battery 1#	/
Right cheek	1413/1732.6	RMC	0.257	0.138	0.03	17.38	18.50	0.333	Battery 1#	/
Right tilt	1413/1732.6	RMC	0.435	0.205	0.04	17.38	18.50	0.563	Battery 1#	/
Right tilt	1413/1732.6	RMC	0.428	0.201	0.06	17.38	18.50	0.554	Battery 2#	/
Right tilt	1312/1712.4	RMC	0.452	0.212	0.01	17.38	18.50	0.585	Battery 1#	Yes
Right tilt	1513/1752.6	RMC	0.415	0.194	0.01	17.32	18.50	0.545	Battery 1#	/
Main Antenna										
Left cheek	1413/1732.6	RMC	0.294	0.187	0.14	23.98	25.00	0.372	Battery 1#	Yes
Left tilt	1413/1732.6	RMC	0.106	0.061	0.08	23.98	25.00	0.134	Battery 1#	/
Right cheek	1413/1732.6	RMC	0.234	0.154	-0.19	23.98	25.00	0.296	Battery 1#	/
Right tilt	1413/1732.6	RMC	0.113	0.066	0.09	23.98	25.00	0.143	Battery 1#	/
Left cheek	1413/1732.6	RMC	0.240	0.157	0.05	23.98	25.00	0.304	Battery 2#	/
Left cheek	1312/1712.4	RMC	0.244	0.160	0.11	24.01	25.00	0.306	Battery 1#	/
Left cheek	1513/1752.6	RMC	0.232	0.151	0.14	23.87	25.00	0.301	Battery 1#	/
Test at the best acoustic position										
Left cheek	1413/1732.6	RMC	0.279	0.179	0.10	23.98	25.00	0.353	Battery 1#	/

Table 177: Head SAR test results of UMTS Band IV

Test Position of Body-Worn	Dist.	Test Channel /Freq.(MHz)	Test Mode	Measured SAR(W/kg)		Power Drift (dB)	Conducted Power (dBm)	Tune-up Power (dBm)	Reported 1-g SAR (W/kg)	Accessory Information	SAR Plot.
				1-g	10-g						
Second Antenna											
Front Side	15mm	1413/1732.6	RMC	0.150	0.088	-0.10	23.01	24.00	0.188	Battery 1#	/
Back Side	15mm	1413/1732.6	RMC	0.153	0.091	-0.05	23.01	24.00	0.192	Battery 1#	Yes
Back Side	15mm	1413/1732.6	RMC	0.141	0.084	-0.06	23.01	24.00	0.177	Battery 2#	/
Back Side	15mm	1312/1712.4	RMC	0.131	0.076	-0.11	23.02	24.00	0.164	Battery 1#	/
Back Side	15mm	1513/1752.6	RMC	0.124	0.072	-0.05	22.90	24.00	0.160	Battery 1#	/
Main Antenna											
Front Side	15mm	1413/1732.6	RMC	0.424	0.279	0.00	23.98	25.00	0.536	Battery 1#	/
Back Side	15mm	1413/1732.6	RMC	0.431	0.284	0.01	23.98	25.00	0.545	Battery 1#	/
Back Side	15mm	1413/1732.6	RMC	0.454	0.301	-0.03	23.98	25.00	0.574	Battery 2#	/
Back Side	15mm	1312/1712.4	RMC	0.463	0.309	-0.03	24.01	25.00	0.582	Battery 2#	/
Back Side	15mm	1513/1752.6	RMC	0.463	0.304	-0.11	23.87	25.00	0.601	Battery 2#	Yes

Table 178: Body Worn SAR test results of UMTS Band IV

Test Position of Hotspot	Dist.	Test Channel /Freq.(MHz)	Test Mode	Measured SAR(W/kg)		Power Drift (dB)	Conducted Power (dBm)	Tune-up Power (dBm)	Reported 1-g SAR (W/kg)	Accessory Information	SAR Plot.
				1-g	10-g						
Second Antenna											
Front Side	10mm	1413/1732.6	RMC	0.121	0.066	0.00	20.00	21.00	0.152	Battery 1#	/
Back Side	10mm	1413/1732.6	RMC	0.136	0.075	-0.10	20.00	21.00	0.171	Battery 1#	/
Left Side	10mm	1413/1732.6	RMC	0.029	0.017	-0.14	20.00	21.00	0.036	Battery 1#	/
Top Side	10mm	1413/1732.6	RMC	0.261	0.138	0.17	20.00	21.00	0.329	Battery 1#	/
Top Side	10mm	1413/1732.6	RMC	0.253	0.135	0.14	20.00	21.00	0.319	Battery 2#	/
Top Side	10mm	1312/1712.4	RMC	0.261	0.139	0.16	20.02	21.00	0.327	Battery 1#	/
Top Side	10mm	1513/1752.6	RMC	0.271	0.144	0.15	19.90	21.00	0.349	Battery 1#	Yes
Main Antenna											
Front Side	10mm	1413/1732.6	RMC	0.359	0.212	0.01	20.88	22.00	0.465	Battery 1#	/
Back Side	10mm	1413/1732.6	RMC	0.339	0.190	-0.12	20.88	22.00	0.439	Battery 1#	/
Left Side	10mm	1413/1732.6	RMC	0.078	0.045	0.07	20.88	22.00	0.101	Battery 1#	/
Right Side	10mm	1413/1732.6	RMC	0.147	0.082	0.10	20.88	22.00	0.190	Battery 1#	/
Bottom Side	10mm	1413/1732.6	RMC	0.479	0.278	0.17	20.88	22.00	0.620	Battery 1#	/
Bottom Side	10mm	1413/1732.6	RMC	0.532	0.310	0.19	20.88	22.00	0.689	Battery 2#	/
Bottom Side	10mm	1312/1712.4	RMC	0.520	0.303	-0.19	20.81	22.00	0.684	Battery 2#	/
Bottom Side	10mm	1513/1752.6	RMC	0.538	0.312	-0.09	20.79	22.00	0.711	Battery 2#	Yes

Table 179: Hotspot SAR test results of UMTS Band IV

Per KDB648474D04, when hotspot mode applies, Product Specific 10-g SAR is required only for the surfaces and edges with hotspot mode 1-g reported SAR > 1.2 W/kg; however, when power reduction applies to hotspot mode the measured SAR must be scaled to the maximum output power, including tolerance, allowed for phablet modes to compare with the 1.2 W/kg SAR test reduction threshold:

Test Position of Hotspot	Dist.	Test Channel /Freq.(MHz)	Test Mode	Measured SAR(W/kg)		Power Drift (dB)	Conducted Power (dBm)	Max Power Without Reduction	Scaled-up 1-g SAR (W/kg)	Product Specific 10-g SAR Exclusion
				1-g	10-g					
Second Antenna										
Front Side	10mm	1413/1732.6	RMC	0.121	0.066	0.00	20.00	24.00	0.304	Yes
Back Side	10mm	1413/1732.6	RMC	0.136	0.075	-0.10	20.00	24.00	0.342	Yes
Left Side	10mm	1413/1732.6	RMC	0.029	0.017	-0.14	20.00	24.00	0.073	Yes
Top Side	10mm	1413/1732.6	RMC	0.261	0.138	0.17	20.00	24.00	0.656	Yes
Top Side	10mm	1413/1732.6	RMC	0.253	0.135	0.14	20.00	24.00	0.636	Yes
Top Side	10mm	1312/1712.4	RMC	0.261	0.139	0.16	20.02	24.00	0.653	Yes
Top Side	10mm	1513/1752.6	RMC	0.271	0.144	0.15	19.90	24.00	0.697	Yes
Main Antenna										
Front Side	10mm	1413/1732.6	RMC	0.359	0.212	0.01	20.88	25.00	0.927	Yes
Back Side	10mm	1413/1732.6	RMC	0.339	0.190	-0.12	20.88	25.00	0.875	Yes
Left Side	10mm	1413/1732.6	RMC	0.078	0.045	0.07	20.88	25.00	0.202	Yes
Right Side	10mm	1413/1732.6	RMC	0.147	0.082	0.10	20.88	25.00	0.380	Yes
Bottom Side	10mm	1413/1732.6	RMC	0.479	0.278	0.17	20.88	25.00	1.237	No
Bottom Side	10mm	1413/1732.6	RMC	0.532	0.310	0.19	20.88	25.00	1.374	No
Bottom Side	10mm	1312/1712.4	RMC	0.520	0.303	-0.19	20.81	25.00	1.365	No
Bottom Side	10mm	1513/1752.6	RMC	0.538	0.312	-0.09	20.79	25.00	1.418	No

Table 180: Product Specific 10-g SAR test reduction evaluation of UMTS Band IV

Note: According to the table above , only Bottom side is required for Product Specific 10-g SAR test in this frequency band.

Product Specific 10-g SAR	Dist.	Test Channel /Freq.(MHz)	Test Mode	Measured SAR(W/kg)		Power Drift (dB)	Conducted Power (dBm)	Tune-up Power (dBm)	Reported 10-g SAR (W/kg)	Accessory Information	SAR Plot.
				1-g	10-g						
Main Antenna											
Bottom Side	0mm	1413/1732.6	RMC	4.270	1.800	0.01	22.48	23.50	2.277	Battery 1#	/
Bottom Side	0mm	1312/1712.4	RMC	4.390	1.860	0.04	22.50	23.50	2.342	Battery 1#	Yes
Bottom Side	0mm	1513/1752.6	RMC	4.160	1.750	0.03	22.35	23.50	2.281	Battery 1#	/
Bottom Side	0mm	1312/1712.4	RMC	4.250	1.830	-0.17	22.50	23.50	2.304	Battery 2#	/
Additional SAR test at a conservative distance(triggering distance minus 1mm)											
Bottom Side	7mm	1413/1732.6	RMC	1.680	0.933	-0.15	23.98	25.00	1.180	Battery 1#	/

Table 181: Product Specific 10-g SAR test results of UMTS Band IV

7.2.5 SAR measurement Results of UMTS Band V

Test Position of Head	Test Channel /Freq.(MHz)	Test Mode	Measured SAR(W/kg)		Power Drift (dB)	Conducted Power (dBm)	Tune-up Power (dBm)	Reported 1-g SAR (W/kg)	Accessory Information	SAR Plot.
			1-g	10-g						
Second Antenna										
Left cheek	4182/836.4	RMC	0.298	0.148	0.00	17.65	18.50	0.362	Battery 1#	/
Left tilt	4182/836.4	RMC	0.283	0.138	0.08	17.65	18.50	0.344	Battery 1#	/
Right cheek	4182/836.4	RMC	0.327	0.176	0.02	17.65	18.50	0.398	Battery 1#	/
Right tilt	4182/836.4	RMC	0.346	0.167	-0.02	17.65	18.50	0.421	Battery 1#	Yes
Right tilt	4182/836.4	RMC	0.309	0.153	-0.03	17.65	18.50	0.376	Battery 2#	/
Right tilt	4132/826.4	RMC	0.326	0.159	0.00	17.61	18.50	0.400	Battery 1#	/
Right tilt	4233/846.6	RMC	0.256	0.126	0.00	17.56	18.50	0.318	Battery 1#	/
Main Antenna										
Left cheek	4182/836.4	RMC	0.105	0.081	0.11	23.52	25.00	0.148	Battery 1#	/
Left tilt	4182/836.4	RMC	0.072	0.054	0.18	23.52	25.00	0.101	Battery 1#	/
Right cheek	4182/836.4	RMC	0.143	0.110	-0.06	23.52	25.00	0.201	Battery 1#	/
Right tilt	4182/836.4	RMC	0.059	0.041	0.01	23.52	25.00	0.084	Battery 1#	/
Right cheek	4182/836.4	RMC	0.150	0.115	0.18	23.52	25.00	0.211	Battery 2#	/
Right cheek	4132/826.4	RMC	0.144	0.111	0.14	23.70	25.00	0.194	Battery 2#	/
Right cheek	4233/846.6	RMC	0.155	0.119	0.04	23.40	25.00	0.224	Battery 2#	Yes

Table 182: Head SAR test results of UMTS Band V

Test Position of Body-Worn	Dist.	Test Channel /Freq.(MHz)	Test Mode	Measured SAR(W/kg)		Power Drift (dB)	Conducted Power (dBm)	Tune-up Power (dBm)	Reported 1-g SAR (W/kg)	Accessory Information	SAR Plot.
				1-g	10-g						
Second Antenna											
Front Side	15mm	4182/836.4	RMC	0.239	0.159	-0.14	23.54	24.50	0.298	Battery 1#	/
Back Side	15mm	4182/836.4	RMC	0.245	0.166	-0.04	23.54	24.50	0.306	Battery 1#	Yes
Back Side	15mm	4182/836.4	RMC	0.237	0.160	-0.04	23.54	24.50	0.296	Battery 2#	/
Back Side	15mm	4132/826.4	RMC	0.223	0.152	-0.04	23.60	24.50	0.274	Battery 1#	/
Back Side	15mm	4233/846.6	RMC	0.211	0.143	-0.02	23.37	24.50	0.274	Battery 1#	/
Main Antenna											
Front Side	15mm	4182/836.4	RMC	0.198	0.135	-0.19	23.52	25.00	0.278	Battery 1#	/
Back Side	15mm	4182/836.4	RMC	0.258	0.183	-0.16	23.52	25.00	0.363	Battery 1#	/
Back Side	15mm	4182/836.4	RMC	0.259	0.183	-0.04	23.52	25.00	0.364	Battery 2#	/
Back Side	15mm	4132/826.4	RMC	0.252	0.179	-0.02	23.70	25.00	0.340	Battery 2#	/
Back Side	15mm	4233/846.6	RMC	0.263	0.185	-0.12	23.40	25.00	0.380	Battery 2#	Yes

Table 183: Body Worn SAR test results of UMTS Band V

Test Position of Hotspot	Dist.	Test Channel /Freq.(MHz)	Test Mode	Measured SAR(W/kg)		Power Drift (dB)	Conducted Power (dBm)	Tune-up Power (dBm)	Reported 1-g SAR (W/kg)	Accessory Information	SAR Plot.
				1-g	10-g						
Second Antenna											
Front Side	10mm	4182/836.4	RMC	0.489	0.269	-0.01	23.54	24.50	0.610	Battery 1#	/
Back Side	10mm	4182/836.4	RMC	0.546	0.301	-0.02	23.54	24.50	0.681	Battery 1#	/
Left Side	10mm	4182/836.4	RMC	0.199	0.131	-0.02	23.54	24.50	0.248	Battery 1#	/
Top Side	10mm	4182/836.4	RMC	0.361	0.171	0.08	23.54	24.50	0.450	Battery 1#	/
Back Side	10mm	4182/836.4	RMC	0.560	0.309	-0.02	23.54	24.50	0.699	Battery 2#	Yes
Back Side	10mm	4132/826.4	RMC	0.519	0.286	-0.03	23.60	24.50	0.639	Battery 2#	/
Back Side	10mm	4233/846.6	RMC	0.553	0.306	-0.15	23.37	24.50	0.717	Battery 2#	/
Main Antenna											
Front Side	10mm	4182/836.4	RMC	0.317	0.214	-0.19	23.52	25.00	0.446	Battery 1#	/
Back Side	10mm	4182/836.4	RMC	0.464	0.312	-0.19	23.52	25.00	0.652	Battery 1#	Yes
Left Side	10mm	4182/836.4	RMC	0.263	0.147	-0.03	23.52	25.00	0.370	Battery 1#	/
Right Side	10mm	4182/836.4	RMC	0.140	0.094	-0.05	23.52	25.00	0.197	Battery 1#	/
Bottom Side	10mm	4182/836.4	RMC	0.240	0.156	-0.05	23.52	25.00	0.337	Battery 1#	/
Back Side	10mm	4182/836.4	RMC	0.446	0.303	0.00	23.52	25.00	0.627	Battery 2#	/
Back Side	10mm	4132/826.4	RMC	0.420	0.287	-0.01	23.70	25.00	0.567	Battery 1#	/
Back Side	10mm	4233/846.6	RMC	0.449	0.304	-0.03	23.40	25.00	0.649	Battery 1#	/

Table 184: Hotspot SAR test results of UMTS Band V

Note: Per KDB 648474 D04, Product Specific 10-g SAR test is not required for this frequency band since hotspot mode 1-g reported SAR < 1.2 W/kg.

7.2.6 SAR measurement Results of LTE Band 2

Test Position of Head	Test Channel /Freq.(MHz)	Test Mode	Measured SAR(W/kg)		Power Drift (dB)	Conducted Power (dBm)	Tune-up Power (dBm)	Reported 1-g SAR (W/kg)	Accessory Information	SAR Plot.
			1-g	10-g						
Second Antenna										
Left cheek	18700/1860	20M QPSK 1RB#0	0.207	0.103	0.17	17.22	18.00	0.248	Battery 1#	/
Left tilt	18700/1860	20M QPSK 1RB#0	0.352	0.165	-0.05	17.22	18.00	0.421	Battery 1#	/
Right cheek	18700/1860	20M QPSK 1RB#0	0.304	0.147	0.04	17.22	18.00	0.364	Battery 1#	/
Right tilt	18700/1860	20M QPSK 1RB#0	0.425	0.202	0.02	17.22	18.00	0.509	Battery 1#	/
Left cheek	19100/1900	20M QPSK 50%RB#50	0.218	0.107	-0.09	16.97	18.00	0.276	Battery 1#	/
Left tilt	19100/1900	20M QPSK 50%RB#50	0.352	0.165	0.18	16.97	18.00	0.446	Battery 1#	/
Right cheek	19100/1900	20M QPSK 50%RB#50	0.269	0.130	0.17	16.97	18.00	0.341	Battery 1#	/
Right tilt	19100/1900	20M QPSK 50%RB#50	0.396	0.144	0.13	16.97	18.00	0.502	Battery 1#	/
Right tilt	18700/1860	20M QPSK 1RB#0	0.424	0.202	0.13	17.22	18.00	0.507	Battery 2#	/
Right tilt	18900/1880	20M QPSK 1RB#0	0.405	0.199	0.16	17.09	18.00	0.499	Battery 1#	/
Right tilt	19100/1900	20M QPSK 1RB#50	0.453	0.148	0.12	16.95	18.00	0.577	Battery 1#	Yes
Main Antenna										
Left cheek	18700/1860	20M QPSK 1RB#99	0.137	0.078	0.14	23.33	24.50	0.179	Battery 1#	/
Left tilt	18700/1860	20M QPSK 1RB#99	0.086	0.050	0.05	23.33	24.50	0.112	Battery 1#	/
Right cheek	18700/1860	20M QPSK 1RB#99	0.210	0.131	0.13	23.33	24.50	0.275	Battery 1#	Yes
Right tilt	18700/1860	20M QPSK 1RB#99	0.078	0.043	0.10	23.33	24.50	0.101	Battery 1#	/
Left cheek	18700/1860	20M QPSK 50%RB#0	0.111	0.063	0.03	22.34	23.50	0.145	Battery 1#	/
Left tilt	18700/1860	20M QPSK 50%RB#0	0.066	0.037	0.19	22.34	23.50	0.087	Battery 1#	/
Right cheek	18700/1860	20M QPSK 50%RB#0	0.171	0.097	0.13	22.34	23.50	0.223	Battery 1#	/
Right tilt	18700/1860	20M QPSK 50%RB#0	0.066	0.036	0.16	22.34	23.50	0.086	Battery 1#	/
Right cheek	18700/1860	20M QPSK 1RB#99	0.178	0.109	0.00	23.33	24.50	0.233	Battery 2#	/
Right cheek	18900/1880	20M QPSK 1RB#0	0.163	0.100	0.13	23.08	24.50	0.226	Battery 1#	/
Right cheek	19100/1900	20M QPSK 1RB#0	0.175	0.110	-0.10	23.24	24.50	0.234	Battery 1#	/

Table 185: Head SAR test results of LTE Band 2

Test Position of Body-Worn	Dist.	Test Channel /Freq.(MHz)	Test Mode	Measured SAR(W/kg)		Power Drift (dB)	Conducted Power (dBm)	Tune-up Power (dBm)	Reported 1-g SAR (W/kg)	Accessory Information	SAR Plot.
				1-g	10-g						
Second Antenna											
Front Side	15mm	18700/1860	20M QPSK 1RB#0	0.079	0.043	-0.09	22.33	23.00	0.092	Battery 1#	/
Back Side	15mm	18700/1860	20M QPSK 1RB#0	0.111	0.070	0.12	22.33	23.00	0.130	Battery 1#	Yes
Front Side	15mm	18700/1860	20M QPSK 50%RB#25	0.074	0.040	0.14	21.56	22.50	0.092	Battery 1#	/
Back Side	15mm	18700/1860	20M QPSK 50%RB#25	0.081	0.046	0.12	21.56	22.50	0.101	Battery 1#	/
Back Side	15mm	18700/1860	20M QPSK 1RB#0	0.106	0.067	-0.16	22.33	23.00	0.124	Battery 2#	/
Back Side	15mm	18900/1880	20M QPSK 1RB#99	0.088	0.051	0.03	21.96	23.00	0.112	Battery 1#	/
Back Side	15mm	19100/1900	20M QPSK 1RB#50	0.104	0.065	-0.08	22.17	23.00	0.126	Battery 1#	/
Main Antenna											
Front Side	15mm	18700/1860	20M QPSK 1RB#99	0.216	0.137	-0.08	23.33	24.50	0.283	Battery 1#	/
Back Side	15mm	18700/1860	20M QPSK 1RB#99	0.250	0.170	-0.05	23.33	24.50	0.327	Battery 1#	/
Front Side	15mm	18700/1860	20M QPSK 50%RB#0	0.164	0.094	-0.14	22.34	23.50	0.214	Battery 1#	/
Back Side	15mm	18700/1860	20M QPSK 50%RB#0	0.190	0.116	-0.07	22.34	23.50	0.248	Battery 1#	/
Back Side	15mm	18700/1860	20M QPSK 1RB#99	0.281	0.188	-0.05	23.33	24.50	0.368	Battery 2#	/
Back Side	15mm	18900/1880	20M QPSK 1RB#0	0.327	0.218	-0.08	23.08	24.50	0.453	Battery 2#	/
Back Side	15mm	19100/1900	20M QPSK 1RB#0	0.334	0.221	-0.09	23.24	24.50	0.446	Battery 2#	Yes

Table 186: Body Worn SAR test results of LTE Band 2

Test Position of Hotspot	Dist.	Test Channel /Freq.(MHz)	Test Mode	Measured SAR(W/kg)		Power Drift (dB)	Conducted Power (dBm)	Tune-up Power (dBm)	Reported 1-g SAR (W/kg)	Accessory Information	SAR Plot.
				1-g	10-g						
Second Antenna											
Front Side	10mm	18900/1880	20M QPSK 1RB#99	0.094	0.050	0.01	19.21	20.00	0.113	Battery 1#	/
Back Side	10mm	18900/1880	20M QPSK 1RB#99	0.105	0.063	0.10	19.21	20.00	0.126	Battery 1#	/
Left Side	10mm	18900/1880	20M QPSK 1RB#99	0.048	0.027	0.03	19.21	20.00	0.058	Battery 1#	/
Top Side	10mm	18900/1880	20M QPSK 1RB#99	0.236	0.128	-0.09	19.21	20.00	0.283	Battery 1#	/
Front Side	10mm	18700/1860	20M QPSK 50%RB#25	0.097	0.050	0.01	19.17	20.00	0.118	Battery 1#	/
Back Side	10mm	18700/1860	20M QPSK 50%RB#25	0.096	0.053	0.16	19.17	20.00	0.117	Battery 1#	/
Left Side	10mm	18700/1860	20M QPSK 50%RB#25	0.023	0.013	0.08	19.17	20.00	0.028	Battery 1#	/
Top Side	10mm	18700/1860	20M QPSK 50%RB#25	0.212	0.106	-0.14	19.17	20.00	0.257	Battery 1#	/
Top Side	10mm	18900/1880	20M QPSK 1RB#99	0.201	0.102	-0.01	19.21	20.00	0.241	Battery 2#	/
Top Side	10mm	18700/1860	20M QPSK 1RB#0	0.192	0.098	-0.07	19.01	20.00	0.241	Battery 1#	/
Top Side	10mm	19100/1900	20M QPSK 1RB#99	0.244	0.133	0.11	19.17	20.00	0.295	Battery 1#	Yes
Main Antenna											
Front Side	10mm	18700/1860	20M QPSK 1RB#50	0.165	0.099	-0.02	20.42	21.50	0.212	Battery 1#	/
Back Side	10mm	18700/1860	20M QPSK 1RB#50	0.181	0.112	-0.05	20.42	21.50	0.232	Battery 1#	/
Left Side	10mm	18700/1860	20M QPSK 1RB#50	0.051	0.030	-0.10	20.42	21.50	0.065	Battery 1#	/
Right Side	10mm	18700/1860	20M QPSK 1RB#50	0.089	0.050	-0.09	20.42	21.50	0.113	Battery 1#	/
Bottom Side	10mm	18700/1860	20M QPSK 1RB#50	0.431	0.251	-0.19	20.42	21.50	0.553	Battery 1#	/
Front Side	10mm	18700/1860	20M QPSK 50%RB#25	0.168	0.100	-0.01	20.36	21.50	0.218	Battery 1#	/
Back Side	10mm	18700/1860	20M QPSK 50%RB#25	0.167	0.101	-0.04	20.36	21.50	0.217	Battery 1#	/
Left Side	10mm	18700/1860	20M QPSK 50%RB#25	0.053	0.033	-0.09	20.36	21.50	0.069	Battery 1#	/
Right Side	10mm	18700/1860	20M QPSK 50%RB#25	0.087	0.049	-0.07	20.36	21.50	0.113	Battery 1#	/
Bottom Side	10mm	18700/1860	20M QPSK 50%RB#25	0.418	0.221	-0.13	20.36	21.50	0.543	Battery 1#	/
Bottom Side	10mm	18700/1860	20M QPSK 1RB#50	0.428	0.249	-0.06	20.42	21.50	0.549	Battery 2#	/
Bottom Side	10mm	18900/1880	20M QPSK 1RB#99	0.456	0.264	-0.13	20.35	21.50	0.594	Battery 1#	Yes
Bottom Side	10mm	19100/1900	20M QPSK 1RB#0	0.455	0.263	0.02	20.31	21.50	0.598	Battery 1#	/

Table 187: Hotspot SAR test results of LTE Band 2



Per KDB648474D04, when hotspot mode applies, Product Specific 10-g SAR is required only for the surfaces and edges with hotspot mode 1-g reported SAR > 1.2 W/kg; however, when power reduction applies to hotspot mode the measured SAR must be scaled to the maximum output power, including tolerance, allowed for phablet modes to compare with the 1.2 W/kg SAR test reduction threshold:

Test Position of Hotspot	Dist.	Test Channel /Freq.(MHz)	Test Mode	Measured SAR(W/kg)		Power Drift (dB)	Conducted Power (dBm)	Max Power Without Reduction	Scaled-up 1-g SAR (W/kg)	Product Specific 10-g SAR Exclusion
				1-g	10-g					
Second Antenna										
Front Side	10mm	18900/1880	20M QPSK 1RB#99	0.094	0.050	0.01	19.21	23.00	0.225	Yes
Back Side	10mm	18900/1880	20M QPSK 1RB#99	0.105	0.063	0.10	19.21	23.00	0.251	Yes
Left Side	10mm	18900/1880	20M QPSK 1RB#99	0.048	0.027	0.03	19.21	23.00	0.115	Yes
Top Side	10mm	18900/1880	20M QPSK 1RB#99	0.236	0.128	-0.09	19.21	23.00	0.565	Yes
Front Side	10mm	18700/1860	20M QPSK 50%RB#25	0.097	0.050	0.01	19.17	22.50	0.209	Yes
Back Side	10mm	18700/1860	20M QPSK 50%RB#25	0.096	0.053	0.16	19.17	22.50	0.208	Yes
Left Side	10mm	18700/1860	20M QPSK 50%RB#25	0.023	0.013	0.08	19.17	22.50	0.049	Yes
Top Side	10mm	18700/1860	20M QPSK 50%RB#25	0.212	0.106	-0.14	19.17	22.50	0.456	Yes
Top Side	10mm	18900/1880	20M QPSK 1RB#99	0.201	0.102	-0.01	19.21	23.00	0.481	Yes
Top Side	10mm	18700/1860	20M QPSK 1RB#0	0.192	0.098	-0.07	19.01	23.00	0.481	Yes
Top Side	10mm	19100/1900	20M QPSK 1RB#99	0.244	0.133	0.11	19.17	23.00	0.589	Yes
Main Antenna										
Front Side	10mm	18700/1860	20M QPSK 1RB#50	0.165	0.099	-0.02	20.42	24.50	0.422	Yes
Back Side	10mm	18700/1860	20M QPSK 1RB#50	0.181	0.112	-0.05	20.42	24.50	0.463	Yes
Left Side	10mm	18700/1860	20M QPSK 1RB#50	0.051	0.030	-0.10	20.42	24.50	0.130	Yes
Right Side	10mm	18700/1860	20M QPSK 1RB#50	0.089	0.050	-0.09	20.42	24.50	0.226	Yes
Bottom Side	10mm	18700/1860	20M QPSK 1RB#50	0.431	0.251	-0.19	20.42	24.50	1.103	Yes
Front Side	10mm	18700/1860	20M QPSK 50%RB#25	0.168	0.100	-0.01	20.36	23.50	0.346	Yes
Back Side	10mm	18700/1860	20M QPSK 50%RB#25	0.167	0.101	-0.04	20.36	23.50	0.344	Yes
Left Side	10mm	18700/1860	20M QPSK 50%RB#25	0.053	0.033	-0.09	20.36	23.50	0.109	Yes
Right Side	10mm	18700/1860	20M QPSK 50%RB#25	0.087	0.049	-0.07	20.36	23.50	0.179	Yes
Bottom Side	10mm	18700/1860	20M QPSK 50%RB#25	0.418	0.221	-0.13	20.36	23.50	0.861	Yes
Bottom Side	10mm	18700/1860	20M QPSK 1RB#50	0.428	0.249	-0.06	20.42	24.50	1.095	Yes
Bottom Side	10mm	18900/1880	20M QPSK 1RB#99	0.456	0.264	-0.13	20.35	24.50	1.186	Yes
Bottom Side	10mm	19100/1900	20M QPSK 1RB#0	0.455	0.263	0.02	20.31	24.50	1.194	Yes

Table 188: Product Specific 10-g SAR test reduction evaluation of LTE Band 2

Note: Per KDB 648474 D04, Product Specific 10-g SAR test is not required for this frequency band.

7.2.7 SAR measurement Results of LTE Band 4

Test Position of Head	Test Channel /Freq.(MHz)	Test Mode	Measured SAR(W/kg)		Power Drift (dB)	Conducted Power (dBm)	Tune-up Power (dBm)	Reported 1-g SAR (W/kg)	Accessory Information	SAR Plot.
			1-g	10-g						
Second Antenna										
Left cheek	20050/1720	20M QPSK 1RB#50	0.237	0.111	-0.09	16.62	17.50	0.290	Battery 1#	/
Left tilt	20050/1720	20M QPSK 1RB#50	0.318	0.144	0.08	16.62	17.50	0.389	Battery 1#	/
Right cheek	20050/1720	20M QPSK 1RB#50	0.248	0.118	-0.19	16.62	17.50	0.304	Battery 1#	/
Right tilt	20050/1720	20M QPSK 1RB#50	0.241	0.101	0.17	16.62	17.50	0.295	Battery 1#	/
Left cheek	20300/1745	20M QPSK 50%RB#25	0.251	0.117	0.14	16.51	17.50	0.315	Battery 1#	/
Left tilt	20300/1745	20M QPSK 50%RB#25	0.333	0.151	0.10	16.51	17.50	0.418	Battery 1#	/
Right cheek	20300/1745	20M QPSK 50%RB#25	0.264	0.126	0.07	16.51	17.50	0.332	Battery 1#	/
Right tilt	20300/1745	20M QPSK 50%RB#25	0.303	0.144	0.00	16.51	17.50	0.381	Battery 1#	/
Left tilt	20300/1745	20M QPSK 50%RB#25	0.330	0.150	0.06	16.51	17.50	0.414	Battery 2#	/
Left tilt	20050/1720	20M QPSK 50%RB#25	0.341	0.154	0.10	16.27	17.50	0.453	Battery 1#	/
Left tilt	20175/1732.5	20M QPSK 50%RB#25	0.352	0.158	0.12	16.42	17.50	0.451	Battery 1#	Yes
Main Antenna										
Left cheek	20050/1720	20M QPSK 1RB#50	0.218	0.141	-0.06	24.10	25.00	0.268	Battery 1#	/
Left tilt	20050/1720	20M QPSK 1RB#50	0.099	0.055	0.06	24.10	25.00	0.121	Battery 1#	/
Right cheek	20050/1720	20M QPSK 1RB#50	0.219	0.143	0.18	24.10	25.00	0.269	Battery 1#	Yes
Right tilt	20050/1720	20M QPSK 1RB#50	0.095	0.054	-0.04	24.10	25.00	0.117	Battery 1#	/
Left cheek	20050/1720	20M QPSK 50%RB#0	0.187	0.112	0.11	22.79	24.00	0.247	Battery 1#	/
Left tilt	20050/1720	20M QPSK 50%RB#0	0.087	0.048	0.08	22.79	24.00	0.115	Battery 1#	/
Right cheek	20050/1720	20M QPSK 50%RB#0	0.172	0.114	0.19	22.79	24.00	0.227	Battery 1#	/
Right tilt	20050/1720	20M QPSK 50%RB#0	0.079	0.045	0.11	22.79	24.00	0.104	Battery 1#	/
Right cheek	20050/1720	20M QPSK 1RB#50	0.215	0.141	0.19	24.10	25.00	0.265	Battery 2#	/
Right cheek	20175/1732.5	20M QPSK 1RB#50	0.208	0.138	0.05	23.88	25.00	0.269	Battery 1#	/
Right cheek	20300/1745	20M QPSK 1RB#50	0.219	0.142	0.11	24.07	25.00	0.271	Battery 1#	/

Table 189: Head SAR test results of LTE Band 4

Test Position of Body-Worn	Dist.	Test Channel /Freq.(MHz)	Test Mode	Measured SAR(W/kg)		Power Drift (dB)	Conducted Power (dBm)	Tune-up Power (dBm)	Reported 1-g SAR (W/kg)	Accessory Information	SAR Plot.
				1-g	10-g						
Second Antenna											
Front Side	15mm	20175/1732.5	20M QPSK 1RB#99	0.152	0.090	0.07	22.91	24.00	0.195	Battery 1#	/
Back Side	15mm	20175/1732.5	20M QPSK 1RB#99	0.175	0.105	-0.01	22.91	24.00	0.225	Battery 1#	Yes
Front Side	15mm	20300/1745	20M QPSK 50%RB#0	0.119	0.067	0.15	21.84	23.00	0.155	Battery 1#	/
Back Side	15mm	20300/1745	20M QPSK 50%RB#0	0.133	0.073	0.01	21.84	23.00	0.174	Battery 1#	/
Back Side	15mm	20175/1732.5	20M QPSK 1RB#99	0.142	0.085	-0.17	22.91	24.00	0.183	Battery 2#	/
Back Side	15mm	20050/1720	20M QPSK 1RB#99	0.148	0.089	-0.02	22.72	24.00	0.199	Battery 1#	/
Back Side	15mm	20300/1745	20M QPSK 1RB#0	0.166	0.100	0.06	22.79	24.00	0.219	Battery 1#	/
Back Side	15mm	20175/1732.5	20M QPSK 1RB#99	0.111	0.068	0.06	22.91	24.00	0.143	Battery 1#	/
Back Side	15mm	20175/1732.5	20M QPSK 1RB#99	0.111	0.068	0.06	22.91	24.00	0.143	with protective cover	/
Main Antenna											
Front Side	15mm	20050/1720	20M QPSK 1RB#50	0.379	0.220	0.00	24.10	25.00	0.466	Battery 1#	/
Back Side	15mm	20050/1720	20M QPSK 1RB#50	0.453	0.291	-0.01	24.10	25.00	0.557	Battery 1#	/
Front Side	15mm	20050/1720	20M QPSK 50%RB#0	0.263	0.158	0.09	22.79	24.00	0.348	Battery 1#	/
Back Side	15mm	20050/1720	20M QPSK 50%RB#0	0.308	0.194	0.00	22.79	24.00	0.407	Battery 1#	/
Back Side	15mm	20050/1720	20M QPSK 1RB#50	0.406	0.271	0.03	24.10	25.00	0.499	Battery 2#	/
Back Side	15mm	20175/1732.5	20M QPSK 1RB#50	0.495	0.314	-0.08	23.88	25.00	0.641	Battery 1#	Yes
Back Side	15mm	20300/1745	20M QPSK 1RB#50	0.480	0.301	-0.08	24.07	25.00	0.595	Battery 1#	/
Back Side	15mm	20175/1732.5	20M QPSK 1RB#50	0.338	0.212	0.00	23.88	25.00	0.437	with protective cover	/

Table 190: Body Worn SAR test results of LTE Band 4

Test Position of Hotspot	Dist.	Test Channel /Freq.(MHz)	Test Mode	Measured SAR(W/kg)		Power Drift (dB)	Conducted Power (dBm)	Tune-up Power (dBm)	Reported 1-g SAR (W/kg)	Accessory Information	SAR Plot.
				1-g	10-g						
Second Antenna											
Front Side	10mm	20300/1745	20M QPSK 1RB#99	0.099	0.049	0.13	20.20	21.00	0.119	Battery 1#	/
Back Side	10mm	20300/1745	20M QPSK 1RB#99	0.156	0.082	-0.04	20.20	21.00	0.188	Battery 1#	/
Left Side	10mm	20300/1745	20M QPSK 1RB#99	0.036	0.022	-0.02	20.20	21.00	0.043	Battery 1#	/
Top Side	10mm	20300/1745	20M QPSK 1RB#99	0.380	0.203	0.14	20.20	21.00	0.457	Battery 1#	Yes
Front Side	10mm	20300/1745	20M QPSK 50%RB#25	0.169	0.089	0.13	20.04	21.00	0.211	Battery 1#	/
Back Side	10mm	20300/1745	20M QPSK 50%RB#25	0.170	0.095	-0.11	20.04	21.00	0.212	Battery 1#	/
Left Side	10mm	20300/1745	20M QPSK 50%RB#25	0.038	0.022	-0.09	20.04	21.00	0.048	Battery 1#	/
Top Side	10mm	20300/1745	20M QPSK 50%RB#25	0.376	0.203	0.10	20.04	21.00	0.469	Battery 1#	/
Top Side	10mm	20300/1745	20M QPSK 50%RB#25	0.364	0.195	0.11	20.04	21.00	0.454	Battery 2#	/
Top Side	10mm	20050/1720	20M QPSK 50%RB#0	0.350	0.188	0.14	19.92	21.00	0.449	Battery 1#	/
Top Side	10mm	20175/1732.5	20M QPSK 50%RB#0	0.355	0.190	0.17	19.83	21.00	0.465	Battery 1#	/
Main Antenna											
Front Side	10mm	20300/1745	20M QPSK 1RB#0	0.318	0.189	0.08	20.73	21.50	0.380	Battery 1#	/
Back Side	10mm	20300/1745	20M QPSK 1RB#0	0.384	0.223	0.14	20.73	21.50	0.458	Battery 1#	/
Left Side	10mm	20300/1745	20M QPSK 1RB#0	0.089	0.051	-0.07	20.73	21.50	0.106	Battery 1#	/
Right Side	10mm	20300/1745	20M QPSK 1RB#0	0.153	0.085	-0.19	20.73	21.50	0.183	Battery 1#	/
Bottom Side	10mm	20300/1745	20M QPSK 1RB#0	0.598	0.347	-0.17	20.73	21.50	0.714	Battery 1#	Yes
Front Side	10mm	20050/1720	20M QPSK 50%RB#50	0.328	0.196	-0.17	20.43	21.50	0.420	Battery 1#	/
Back Side	10mm	20050/1720	20M QPSK 50%RB#50	0.352	0.206	-0.02	20.43	21.50	0.450	Battery 1#	/
Left Side	10mm	20050/1720	20M QPSK 50%RB#50	0.083	0.048	0.04	20.43	21.50	0.106	Battery 1#	/
Right Side	10mm	20050/1720	20M QPSK 50%RB#50	0.142	0.079	-0.14	20.43	21.50	0.182	Battery 1#	/
Bottom Side	10mm	20050/1720	20M QPSK 50%RB#50	0.580	0.335	0.02	20.43	21.50	0.742	Battery 1#	/
Bottom Side	10mm	20050/1720	20M QPSK 50%RB#50	0.564	0.326	-0.03	20.43	21.50	0.722	Battery 2#	/
Bottom Side	10mm	20175/1732.5	20M QPSK 50%RB#50	0.563	0.327	0.05	20.37	21.50	0.730	Battery 1#	/
Bottom Side	10mm	20300/1745	20M QPSK 50%RB#50	0.546	0.306	-0.15	20.38	21.50	0.707	Battery 1#	/

Table 191: Hotspot SAR test results of LTE Band 4

Per KDB648474D04, when hotspot mode applies, Product Specific 10-g SAR is required only for the surfaces and edges with hotspot mode 1-g reported SAR > 1.2 W/kg; however, when power reduction applies to hotspot mode the measured SAR must be scaled to the maximum output power, including tolerance, allowed for phablet modes to compare with the 1.2 W/kg SAR test reduction threshold:

Test Position of Hotspot	Dist.	Test Channel /Freq.(MHz)	Test Mode	Measured SAR(W/kg)		Power Drift (dB)	Conducted Power (dBm)	Max Power Without Reduction	Scaled-up 1-g SAR (W/kg)	Product Specific 10-g SAR Exclusion
				1-g	10-g					
Second Antenna										
Front Side	10mm	20300/1745	20M QPSK 1RB#99	0.099	0.049	0.13	20.20	24.00	0.238	Yes
Back Side	10mm	20300/1745	20M QPSK 1RB#99	0.156	0.082	-0.04	20.20	24.00	0.374	Yes
Left Side	10mm	20300/1745	20M QPSK 1RB#99	0.036	0.022	-0.02	20.20	24.00	0.086	Yes
Top Side	10mm	20300/1745	20M QPSK 1RB#99	0.380	0.203	0.14	20.20	24.00	0.912	Yes
Front Side	10mm	20300/1745	20M QPSK 50%RB#25	0.169	0.089	0.13	20.04	23.00	0.334	Yes
Back Side	10mm	20300/1745	20M QPSK 50%RB#25	0.170	0.095	-0.11	20.04	23.00	0.336	Yes
Left Side	10mm	20300/1745	20M QPSK 50%RB#25	0.038	0.022	-0.09	20.04	23.00	0.076	Yes
Top Side	10mm	20300/1745	20M QPSK 50%RB#25	0.376	0.203	0.10	20.04	23.00	0.743	Yes
Top Side	10mm	20300/1745	20M QPSK 50%RB#25	0.364	0.195	0.11	20.04	23.00	0.720	Yes
Top Side	10mm	20050/1720	20M QPSK 50%RB#0	0.350	0.188	0.14	19.92	23.00	0.711	Yes
Top Side	10mm	20175/1732.5	20M QPSK 50%RB#0	0.355	0.190	0.17	19.83	23.00	0.737	Yes
Main Antenna										
Front Side	10mm	20300/1745	20M QPSK 1RB#0	0.318	0.189	0.08	20.73	25.00	0.850	Yes
Back Side	10mm	20300/1745	20M QPSK 1RB#0	0.384	0.223	0.14	20.73	25.00	1.026	Yes
Left Side	10mm	20300/1745	20M QPSK 1RB#0	0.089	0.051	-0.07	20.73	25.00	0.237	Yes
Right Side	10mm	20300/1745	20M QPSK 1RB#0	0.153	0.085	-0.19	20.73	25.00	0.409	Yes
Bottom Side	10mm	20300/1745	20M QPSK 1RB#0	0.598	0.347	-0.17	20.73	25.00	1.598	No
Front Side	10mm	20050/1720	20M QPSK 50%RB#50	0.328	0.196	-0.17	20.43	24.00	0.746	Yes
Back Side	10mm	20050/1720	20M QPSK 50%RB#50	0.352	0.206	-0.02	20.43	24.00	0.801	Yes
Left Side	10mm	20050/1720	20M QPSK 50%RB#50	0.083	0.048	0.04	20.43	24.00	0.189	Yes
Right Side	10mm	20050/1720	20M QPSK 50%RB#50	0.142	0.079	-0.14	20.43	24.00	0.323	Yes
Bottom Side	10mm	20050/1720	20M QPSK 50%RB#50	0.580	0.335	0.02	20.43	24.00	1.320	No
Bottom Side	10mm	20050/1720	20M QPSK 50%RB#50	0.564	0.326	-0.03	20.43	24.00	1.283	No
Bottom Side	10mm	20175/1732.5	20M QPSK 50%RB#50	0.563	0.327	0.05	20.37	24.00	1.299	No
Bottom Side	10mm	20300/1745	20M QPSK 50%RB#50	0.546	0.306	-0.15	20.38	24.00	1.257	No

Table 192: Product Specific 10-g SAR test reduction evaluation of LTE Band 4

Note: According to the table above , only Bottom side is required for Product Specific 10-g SAR test in this frequency band.

Product Specific 10-g SAR	Dist.	Test Channel /Freq.(MHz)	Test Mode	Measured SAR(W/kg)		Power Drift (dB)	Conducted Power (dBm)	Tune-up Power (dBm)	Reported 10-g SAR (W/kg)	Accessory Information	SAR Plot.
				1-g	10-g						
Main Antenna											
Bottom Side	0mm	20050/1720	20M QPSK 1RB#0	4.190	1.840	-0.14	22.05	23.00	2.290	Battery 1#	/
Bottom Side	0mm	20175/1732.5	20M QPSK 1RB#99	4.220	1.870	-0.14	22.04	23.00	2.333	Battery 1#	/
Bottom Side	0mm	20300/1745	20M QPSK 1RB#99	4.050	1.790	-0.14	21.98	23.00	2.264	Battery 1#	/
Bottom Side	0mm	20050/1720	20M QPSK 50%RB#0	4.230	1.840	-0.15	21.92	23.00	2.359	Battery 1#	/
Bottom Side	0mm	20175/1732.5	20M QPSK 50%RB#50	4.190	1.840	-0.13	21.82	23.00	2.414	Battery 1#	/
Bottom Side	0mm	20300/1745	20M QPSK 50%RB#50	4.010	1.770	0.14	21.91	23.00	2.275	Battery 1#	/
Bottom Side	0mm	20175/1732.5	20M QPSK 100%RB#0	4.310	1.900	0.14	21.80	23.00	2.505	Battery 1#	Yes
Bottom Side	0mm	20175/1732.5	20M QPSK 100%RB#0	4.180	1.850	-0.13	21.80	23.00	2.439	Battery 2#	/
Additional SAR test at a conservative distance(triggering distance minus 1mm)											
Bottom Side	7mm	20050/1720	20M QPSK 1RB#50	1.870	1.030	0.03	24.10	25.00	1.267	Battery 1#	/
Bottom Side	7mm	20050/1720	20M QPSK 50%RB#0	1.480	0.824	-0.06	22.79	24.00	1.089	Battery 1#	/

Table 193: Product Specific 10-g SAR test results of LTE Band 4

7.2.8 SAR measurement Results of LTE Band 5

Test Position of Head	Test Channel /Freq.(MHz)	Test Mode	Measured SAR(W/kg)		Power Drift (dB)	Conducted Power (dBm)	Tune-up Power (dBm)	Reported 1-g SAR (W/kg)	Accessory Information	SAR Plot.
			1-g	10-g						
Second Antenna										
Left cheek	20600/844	10M QPSK 1RB#49	0.303	0.152	0.08	17.94	18.50	0.345	Battery 1#	/
Left tilt	20600/844	10M QPSK 1RB#49	0.276	0.134	-0.11	17.94	18.50	0.314	Battery 1#	/
Right cheek	20600/844	10M QPSK 1RB#49	0.282	0.155	0.00	17.94	18.50	0.321	Battery 1#	/
Right tilt	20600/844	10M QPSK 1RB#49	0.268	0.117	0.01	17.94	18.50	0.305	Battery 1#	/
Left cheek	20600/844	10M QPSK 50%RB#25	0.339	0.166	0.15	17.86	18.50	0.393	Battery 1#	Yes
Left tilt	20600/844	10M QPSK 50%RB#25	0.272	0.132	0.00	17.86	18.50	0.315	Battery 1#	/
Right cheek	20600/844	10M QPSK 50%RB#25	0.301	0.164	-0.03	17.86	18.50	0.349	Battery 1#	/
Right tilt	20600/844	10M QPSK 50%RB#25	0.273	0.135	-0.05	17.86	18.50	0.316	Battery 1#	/
Left cheek	20600/844	10M QPSK 50%RB#25	0.337	0.163	-0.19	17.86	18.50	0.391	Battery 2#	/
Left cheek	20450/829	10M QPSK 50%RB#0	0.301	0.150	-0.09	17.84	18.50	0.350	Battery 1#	/
Left cheek	20525/836.5	10M QPSK 50%RB#25	0.319	0.158	0.13	17.79	18.50	0.376	Battery 1#	/
Main Antenna										
Left cheek	20450/829	10M QPSK 1RB#25	0.113	0.078	-0.09	23.92	25.00	0.145	Battery 1#	/
Left tilt	20450/829	10M QPSK 1RB#25	0.084	0.057	-0.01	23.92	25.00	0.108	Battery 1#	/
Right cheek	20450/829	10M QPSK 1RB#25	0.146	0.114	0.10	23.92	25.00	0.187	Battery 1#	/
Right tilt	20450/829	10M QPSK 1RB#25	0.066	0.046	0.02	23.92	25.00	0.085	Battery 1#	/
Left cheek	20450/829	10M QPSK 50%RB#0	0.095	0.066	0.18	22.99	24.00	0.120	Battery 1#	/
Left tilt	20450/829	10M QPSK 50%RB#0	0.067	0.047	-0.03	22.99	24.00	0.085	Battery 1#	/
Right cheek	20450/829	10M QPSK 50%RB#0	0.110	0.086	-0.11	22.99	24.00	0.139	Battery 1#	/
Right tilt	20450/829	10M QPSK 50%RB#0	0.056	0.043	0.16	22.99	24.00	0.070	Battery 1#	/
Right cheek	20450/829	10M QPSK 1RB#25	0.152	0.118	0.03	23.92	25.00	0.195	Battery 2#	/
Right cheek	20525/836.5	10M QPSK 1RB#49	0.146	0.113	0.15	23.77	25.00	0.194	Battery 2#	/
Right cheek	20600/844	10M QPSK 1RB#0	0.153	0.118	0.10	23.68	25.00	0.207	Battery 2#	Yes

Table 194: Head SAR test results of LTE Band 5

Test Position of Body-Worn	Dist.	Test Channel /Freq.(MHz)	Test Mode	Measured SAR(W/kg)		Power Drift (dB)	Conducted Power (dBm)	Tune-up Power (dBm)	Reported 1-g SAR (W/kg)	Accessory Information	SAR Plot.
				1-g	10-g						
Second Antenna											
Front Side	15mm	20450/829	10M QPSK 1RB#49	0.246	0.164	-0.01	23.81	24.50	0.288	Battery 1#	/
Back Side	15mm	20450/829	10M QPSK 1RB#49	0.246	0.149	-0.14	23.81	24.50	0.288	Battery 1#	/
Front Side	15mm	20450/829	10M QPSK 50%RB#0	0.185	0.123	-0.03	22.86	23.50	0.214	Battery 1#	/
Back Side	15mm	20450/829	10M QPSK 50%RB#0	0.169	0.114	-0.03	22.86	23.50	0.196	Battery 1#	/
Front Side	15mm	20450/829	10M QPSK 1RB#49	0.229	0.153	-0.06	23.81	24.50	0.268	Battery 2#	/
Front Side	15mm	20525/836.5	10M QPSK 1RB#49	0.261	0.171	-0.03	23.56	24.50	0.324	Battery 1#	Yes
Front Side	15mm	20600/844	10M QPSK 1RB#49	0.251	0.165	-0.02	23.53	24.50	0.314	Battery 1#	/
Main Antenna											
Front Side	15mm	20450/829	10M QPSK 1RB#25	0.217	0.148	-0.05	23.92	25.00	0.278	Battery 1#	/
Back Side	15mm	20450/829	10M QPSK 1RB#25	0.275	0.194	-0.01	23.92	25.00	0.353	Battery 1#	/
Front Side	15mm	20450/829	10M QPSK 50%RB#0	0.164	0.112	-0.05	22.99	24.00	0.207	Battery 1#	/
Back Side	15mm	20450/829	10M QPSK 50%RB#0	0.201	0.136	0.01	22.99	24.00	0.254	Battery 1#	/
Back Side	15mm	20450/829	10M QPSK 1RB#25	0.285	0.170	-0.15	23.92	25.00	0.365	Battery 2#	/
Back Side	15mm	20525/836.5	10M QPSK 1RB#49	0.271	0.190	-0.07	23.77	25.00	0.360	Battery 2#	/
Back Side	15mm	20600/844	10M QPSK 1RB#0	0.292	0.205	0.05	23.68	25.00	0.396	Battery 2#	Yes

Table 195: Body Worn SAR test results of LTE Band 5

Test Position of Hotspot	Dist.	Test Channel /Freq.(MHz)	Test Mode	Measured SAR(W/kg)		Power Drift (dB)	Conducted Power (dBm)	Tune-up Power (dBm)	Reported 1-g SAR (W/kg)	Accessory Information	SAR Plot.
				1-g	10-g						
Second Antenna											
Front Side	10mm	20450/829	10M QPSK 1RB#49	0.482	0.265	-0.01	23.81	24.50	0.565	Battery 1#	/
Back Side	10mm	20450/829	10M QPSK 1RB#49	0.464	0.258	-0.19	23.81	24.50	0.544	Battery 1#	/
Left Side	10mm	20450/829	10M QPSK 1RB#49	0.214	0.130	0.00	23.81	24.50	0.251	Battery 1#	/
Top Side	10mm	20450/829	10M QPSK 1RB#49	0.326	0.158	-0.10	23.81	24.50	0.382	Battery 1#	/
Front Side	10mm	20450/829	10M QPSK 50%RB#0	0.486	0.295	-0.01	22.86	23.50	0.563	Battery 1#	/
Back Side	10mm	20450/829	10M QPSK 50%RB#0	0.389	0.226	-0.04	22.86	23.50	0.451	Battery 1#	/
Left Side	10mm	20450/829	10M QPSK 50%RB#0	0.162	0.108	0.02	22.86	23.50	0.188	Battery 1#	/
Top Side	10mm	20450/829	10M QPSK 50%RB#0	0.217	0.106	0.07	22.86	23.50	0.251	Battery 1#	/
Front Side	10mm	20450/829	10M QPSK 1RB#49	0.549	0.297	0.00	23.81	24.50	0.644	Battery 2#	/
Front Side	10mm	20525/836.5	10M QPSK 1RB#49	0.544	0.295	-0.14	23.56	24.50	0.675	Battery 2#	/
Front Side	10mm	20600/844	10M QPSK 1RB#49	0.572	0.307	-0.12	23.53	24.50	0.715	Battery 2#	Yes
Main Antenna											
Front Side	10mm	20450/829	10M QPSK 1RB#25	0.368	0.221	-0.02	23.92	25.00	0.472	Battery 1#	/
Back Side	10mm	20450/829	10M QPSK 1RB#25	0.430	0.293	-0.19	23.92	25.00	0.551	Battery 1#	/
Left Side	10mm	20450/829	10M QPSK 1RB#25	0.255	0.133	-0.09	23.92	25.00	0.327	Battery 1#	/
Right Side	10mm	20450/829	10M QPSK 1RB#25	0.138	0.093	-0.05	23.92	25.00	0.177	Battery 1#	/
Bottom Side	10mm	20450/829	10M QPSK 1RB#25	0.286	0.175	-0.02	23.92	25.00	0.367	Battery 1#	/
Front Side	10mm	20450/829	10M QPSK 50%RB#0	0.239	0.163	0.00	22.99	24.00	0.302	Battery 1#	/
Back Side	10mm	20450/829	10M QPSK 50%RB#0	0.337	0.215	-0.02	22.99	24.00	0.425	Battery 1#	/
Left Side	10mm	20450/829	10M QPSK 50%RB#0	0.193	0.100	-0.04	22.99	24.00	0.244	Battery 1#	/
Right Side	10mm	20450/829	10M QPSK 50%RB#0	0.106	0.071	-0.04	22.99	24.00	0.134	Battery 1#	/
Bottom Side	10mm	20450/829	10M QPSK 50%RB#0	0.228	0.139	-0.02	22.99	24.00	0.288	Battery 1#	/
Back Side	10mm	20450/829	10M QPSK 1RB#25	0.433	0.294	0.06	23.92	25.00	0.555	Battery 2#	Yes
Back Side	10mm	20525/836.5	10M QPSK 1RB#49	0.410	0.279	0.17	23.77	25.00	0.544	Battery 2#	/
Back Side	10mm	20600/844	10M QPSK 1RB#0	0.432	0.292	-0.02	23.68	25.00	0.585	Battery 2#	/

Table 196: Hotspot SAR test results of LTE Band 5

Note: Per KDB 648474 D04, Product Specific 10-g SAR test is not required for this frequency band since hotspot mode 1-g reported SAR < 1.2 W/kg.

7.2.9 SAR measurement Results of LTE Band 7

Test Position of Head	Test Channel /Freq.(MHz)	Test Mode	Measured SAR(W/kg)		Power Drift (dB)	Conducted Power (dBm)	Tune-up Power (dBm)	Reported 1-g SAR (W/kg)	Accessory Information	SAR Plot.
			1-g	10-g						
Second Antenna										
Left cheek	21100/2535	20M QPSK 1RB#50	0.135	0.064	0.00	14.92	15.50	0.154	Battery 1#	/
Left tilt	21100/2535	20M QPSK 1RB#50	0.165	0.078	0.16	14.92	15.50	0.189	Battery 1#	/
Right cheek	21100/2535	20M QPSK 1RB#50	0.247	0.118	0.01	14.92	15.50	0.282	Battery 1#	/
Right tilt	21100/2535	20M QPSK 1RB#50	0.353	0.154	0.10	14.92	15.50	0.403	Battery 1#	Yes
Left cheek	21350/2560	20M QPSK 50%RB#0	0.129	0.060	0.05	14.86	15.50	0.149	Battery 1#	/
Left tilt	21350/2560	20M QPSK 50%RB#0	0.148	0.069	0.05	14.86	15.50	0.171	Battery 1#	/
Right cheek	21350/2560	20M QPSK 50%RB#0	0.166	0.070	0.08	14.86	15.50	0.192	Battery 1#	/
Right tilt	21350/2560	20M QPSK 50%RB#0	0.295	0.139	-0.04	14.86	15.50	0.342	Battery 1#	/
Right tilt	21100/2535	20M QPSK 1RB#50	0.303	0.133	0.04	14.92	15.50	0.346	Battery 2#	/
Right tilt	20850/2510	20M QPSK 1RB#0	0.286	0.126	0.01	14.77	15.50	0.338	Battery 1#	/
Right tilt	21350/2560	20M QPSK 1RB#0	0.285	0.124	-0.14	14.81	15.50	0.334	Battery 1#	/
Right tilt	21350/2560(PCC)	20M QPSK 1RB#0	0.297	0.134	0.11	14.58	15.50	0.367	Battery 1#	/
	21152/2540.2(SCC)	20M QPSK 1RB#99								
Main Antenna										
Left cheek	21350/2560	20M QPSK 1RB#50	0.148	0.078	-0.02	23.66	24.50	0.180	Battery 1#	/
Left tilt	21350/2560	20M QPSK 1RB#50	0.103	0.050	-0.08	23.66	24.50	0.125	Battery 1#	/
Right cheek	21350/2560	20M QPSK 1RB#50	0.220	0.120	0.08	23.66	24.50	0.267	Battery 1#	Yes
Right tilt	21350/2560	20M QPSK 1RB#50	0.059	0.029	0.17	23.66	24.50	0.071	Battery 1#	/
Left cheek	21350/2560	20M QPSK 50%RB#0	0.114	0.060	0.08	22.58	23.50	0.141	Battery 1#	/
Left tilt	21350/2560	20M QPSK 50%RB#0	0.082	0.039	-0.13	22.58	23.50	0.101	Battery 1#	/
Right cheek	21350/2560	20M QPSK 50%RB#0	0.159	0.081	0.00	22.58	23.50	0.197	Battery 1#	/
Right tilt	21350/2560	20M QPSK 50%RB#0	0.046	0.023	0.14	22.58	23.50	0.057	Battery 1#	/
Right cheek	21350/2560	20M QPSK 1RB#50	0.177	0.099	-0.02	23.66	24.50	0.215	Battery 2#	/
Right cheek	20850/2510	20M QPSK 1RB#0	0.183	0.102	-0.03	23.61	24.50	0.225	Battery 1#	/
Right cheek	21100/2535	20M QPSK 1RB#0	0.187	0.104	-0.04	23.57	24.50	0.232	Battery 1#	/
Right cheek	21350/2560(PCC)	20M QPSK 1RB#0	0.161	0.088	-0.16	23.53	24.50	0.201	Battery 1#	/
	21152/2540.2(SCC)	20M QPSK 1RB#99								

Table 197: Head SAR test results of LTE Band 7

Test Position of Body-Worn	Dist.	Test Channel /Freq.(MHz)	Test Mode	Measured SAR(W/kg)		Power Drift (dB)	Conducted Power (dBm)	Tune-up Power (dBm)	Reported 1-g SAR (W/kg)	Accessory Information	SAR Plot.
				1-g	10-g						
Second Antenna											
Front Side	15mm	21350/2560	20M QPSK 1RB#0	0.052	0.030	0.12	20.05	20.50	0.057	Battery 1#	/
Back Side	15mm	21350/2560	20M QPSK 1RB#0	0.170	0.086	0.02	20.05	20.50	0.189	Battery 1#	/
Front Side	15mm	21350/2560	20M QPSK 50%RB#0	0.050	0.028	-0.01	19.85	20.50	0.057	Battery 1#	/
Back Side	15mm	21350/2560	20M QPSK 50%RB#0	0.163	0.082	0.03	19.85	20.50	0.189	Battery 1#	/
Back Side	15mm	21350/2560	20M QPSK 1RB#0	0.229	0.118	-0.02	20.05	20.50	0.254	Battery 2#	/
Back Side	15mm	20850/2510	20M QPSK 1RB#99	0.241	0.126	0.19	19.99	20.50	0.271	Battery 2#	Yes
Back Side	15mm	21100/2535	20M QPSK 1RB#50	0.208	0.106	-0.14	19.85	20.50	0.242	Battery 2#	/
Back Side	15mm	21350/2560(PCC)	20M QPSK 1RB#0	0.176	0.093	0.00	19.63	20.50	0.215	Battery 2#	/
		21152/2540.2(SCC)	20M QPSK 1RB#99								
Main Antenna											
Front Side	15mm	21350/2560	20M QPSK 1RB#50	0.142	0.076	-0.01	23.66	24.50	0.172	Battery 1#	/
Back Side	15mm	21350/2560	20M QPSK 1RB#50	0.380	0.211	0.04	23.66	24.50	0.461	Battery 1#	/
Front Side	15mm	21350/2560	20M QPSK 50%RB#0	0.135	0.072	-0.03	22.58	23.50	0.167	Battery 1#	/
Back Side	15mm	21350/2560	20M QPSK 50%RB#0	0.204	0.109	-0.14	22.58	23.50	0.252	Battery 1#	/
Back Side	15mm	21350/2560	20M QPSK 1RB#50	0.326	0.182	-0.02	23.66	24.50	0.396	Battery 2#	/
Back Side	15mm	20850/2510	20M QPSK 1RB#0	0.354	0.200	0.09	23.61	24.50	0.435	Battery 1#	/
Back Side	15mm	21100/2535	20M QPSK 1RB#0	0.459	0.254	-0.02	23.57	24.50	0.569	Battery 1#	Yes
Back Side	15mm	21350/2560(PCC)	20M QPSK 1RB#0	0.453	0.249	-0.18	23.53	24.50	0.566	Battery 1#	/
		21152/2540.2(SCC)	20M QPSK 1RB#99								

Table 198: Body Worn SAR test results of LTE Band 7

Test Position of Hotspot	Dist.	Test Channel /Freq.(MHz)	Test Mode	Measured SAR(W/kg)		Power Drift (dB)	Conducted Power (dBm)	Tune-up Power (dBm)	Reported 1-g SAR (W/kg)	Accessory Information	SAR Plot.
				1-g	10-g						
Second Antenna											
Front Side	10mm	21350/2560	20M QPSK 1RB#99	0.062	0.032	0.05	18.02	18.50	0.070	Battery 1#	/
Back Side	10mm	21350/2560	20M QPSK 1RB#99	0.241	0.108	0.00	18.02	18.50	0.269	Battery 1#	/
Left Side	10mm	21350/2560	20M QPSK 1RB#99	0.025	0.011	0.10	18.02	18.50	0.028	Battery 1#	/
Top Side	10mm	21350/2560	20M QPSK 1RB#99	0.160	0.080	0.03	18.02	18.50	0.179	Battery 1#	/
Front Side	10mm	21350/2560	20M QPSK 50%RB#0	0.070	0.036	-0.02	17.89	18.50	0.080	Battery 1#	/
Back Side	10mm	21350/2560	20M QPSK 50%RB#0	0.255	0.115	-0.01	17.89	18.50	0.293	Battery 1#	Yes
Left Side	10mm	21350/2560	20M QPSK 50%RB#0	0.024	0.010	-0.11	17.89	18.50	0.028	Battery 1#	/
Top Side	10mm	21350/2560	20M QPSK 50%RB#0	0.190	0.094	0.03	17.89	18.50	0.219	Battery 1#	/
Back Side	10mm	21350/2560	20M QPSK 50%RB#0	0.222	0.105	0.01	17.89	18.50	0.255	Battery 2#	/
Back Side	10mm	20850/2510	20M QPSK 50%RB#0	0.211	0.099	0.00	17.67	18.50	0.255	Battery 1#	/
Back Side	10mm	21100/2535	20M QPSK 50%RB#50	0.163	0.079	-0.08	17.63	18.50	0.199	Battery 1#	/
Back Side	10mm	21350/2560(PCC)	20M QPSK 1RB#0	0.204	0.099	0.12	17.63	18.50	0.249	Battery 1#	/
		21152/2540.2(SCC)	20M QPSK 1RB#99								
Main Antenna											
Front Side	10mm	21350/2560	20M QPSK 1RB#99	0.149	0.073	-0.02	20.79	21.50	0.175	Battery 1#	/
Back Side	10mm	21350/2560	20M QPSK 1RB#99	0.169	0.090	-0.14	20.79	21.50	0.199	Battery 1#	/
Left Side	10mm	21350/2560	20M QPSK 1RB#99	0.049	0.029	0.11	20.79	21.50	0.058	Battery 1#	/
Right Side	10mm	21350/2560	20M QPSK 1RB#99	0.070	0.038	0.10	20.79	21.50	0.083	Battery 1#	/
Bottom Side	10mm	21350/2560	20M QPSK 1RB#99	0.353	0.179	-0.15	18.30	19.00	0.415	Battery 1#	/
Front Side	10mm	21350/2560	20M QPSK 50%RB#0	0.147	0.072	-0.09	20.71	21.50	0.176	Battery 1#	/
Back Side	10mm	21350/2560	20M QPSK 50%RB#0	0.159	0.080	-0.15	20.71	21.50	0.191	Battery 1#	/
Left Side	10mm	21350/2560	20M QPSK 50%RB#0	0.049	0.029	0.15	20.71	21.50	0.059	Battery 1#	/
Right Side	10mm	21350/2560	20M QPSK 50%RB#0	0.075	0.041	0.05	20.71	21.50	0.090	Battery 1#	/
Bottom Side	10mm	21350/2560	20M QPSK 50%RB#0	0.335	0.171	-0.09	18.12	19.00	0.410	Battery 1#	/
Bottom Side	10mm	21350/2560	20M QPSK 1RB#99	0.384	0.194	0.13	18.30	19.00	0.451	Battery 2#	/
Bottom Side	10mm	20850/2510	20M QPSK 1RB#0	0.312	0.156	-0.12	18.02	19.00	0.391	Battery 2#	/
Bottom Side	10mm	21100/2535	20M QPSK 1RB#0	0.291	0.145	-0.04	18.19	19.00	0.351	Battery 2#	/
Bottom Side	10mm	21350/2560(PCC)	20M QPSK 1RB#0	0.323	0.156	-0.03	18.12	19.00	0.396	Battery 2#	/
		21152/2540.2(SCC)	20M QPSK 1RB#99								
Additional SAR test at a conservative distance(triggering distance minus 1mm)											
Bottom Side	12mm	21350/2560	20M QPSK 1RB#99	0.467	0.246	-0.09	20.79	21.50	0.550	Battery 2#	/
Bottom Side	12mm	21350/2560	20M QPSK 50%RB#0	0.486	0.257	-0.08	20.71	21.50	0.583	Battery 2#	Yes
Bottom Side	12mm	21350/2560(PCC)	20M QPSK 1RB#0	0.449	0.236	-0.16	20.62	21.50	0.550	Battery 2#	/
		21152/2540.2(SCC)	20M QPSK 1RB#99								

Table 199: Hotspot SAR test results of LTE Band 7



Per KDB648474D04, when hotspot mode applies, Product Specific 10-g SAR is required only for the surfaces and edges with hotspot mode 1-g reported SAR > 1.2 W/kg; however, when power reduction applies to hotspot mode the measured SAR must be scaled to the maximum output power, including tolerance, allowed for phablet modes to compare with the 1.2 W/kg SAR test reduction threshold:

Test Position of Hotspot	Dist.	Test Channel /Freq.(MHz)	Test Mode	Measured SAR(W/kg)		Power Drift (dB)	Conducted Power (dBm)	Max Power Without Reduction	Scaled-up 1-g SAR (W/kg)	Product Specific 10-g SAR Exclusion
				1-g	10-g					
Second Antenna										
Front Side	10mm	21350/2560	20M QPSK 1RB#99	0.062	0.032	0.05	18.02	20.50	0.110	Yes
Back Side	10mm	21350/2560	20M QPSK 1RB#99	0.241	0.108	0.00	18.02	20.50	0.427	Yes
Left Side	10mm	21350/2560	20M QPSK 1RB#99	0.025	0.011	0.10	18.02	20.50	0.045	Yes
Top Side	10mm	21350/2560	20M QPSK 1RB#99	0.160	0.080	0.03	18.02	20.50	0.283	Yes
Front Side	10mm	21350/2560	20M QPSK 50%RB#0	0.070	0.036	-0.02	17.89	20.50	0.127	Yes
Back Side	10mm	21350/2560	20M QPSK 50%RB#0	0.255	0.115	-0.01	17.89	20.50	0.465	Yes
Left Side	10mm	21350/2560	20M QPSK 50%RB#0	0.024	0.010	-0.11	17.89	20.50	0.045	Yes
Top Side	10mm	21350/2560	20M QPSK 50%RB#0	0.190	0.094	0.03	17.89	20.50	0.347	Yes
Back Side	10mm	21350/2560	20M QPSK 50%RB#0	0.222	0.105	0.01	17.89	20.50	0.405	Yes
Back Side	10mm	20850/2510	20M QPSK 50%RB#0	0.211	0.099	0.00	17.67	20.50	0.405	Yes
Back Side	10mm	21100/2535	20M QPSK 50%RB#50	0.163	0.079	-0.08	17.63	20.50	0.316	Yes
Back Side	10mm	21350/2560(PCC)	20M QPSK 1RB#0	0.204	0.099	0.12	17.63	20.50	0.395	Yes
		21152/2540.2(SCC)	20M QPSK 1RB#99							
Main Antenna										
Front Side	10mm	21350/2560	20M QPSK 1RB#99	0.149	0.073	-0.02	20.79	24.50	0.350	Yes
Back Side	10mm	21350/2560	20M QPSK 1RB#99	0.169	0.090	-0.14	20.79	24.50	0.397	Yes
Left Side	10mm	21350/2560	20M QPSK 1RB#99	0.049	0.029	0.11	20.79	24.50	0.116	Yes
Right Side	10mm	21350/2560	20M QPSK 1RB#99	0.070	0.038	0.10	20.79	24.50	0.165	Yes
Bottom Side	10mm	21350/2560	20M QPSK 1RB#99	0.353	0.179	-0.15	18.30	24.50	1.472	No
Front Side	10mm	21350/2560	20M QPSK 50%RB#0	0.147	0.072	-0.09	20.71	23.50	0.279	Yes
Back Side	10mm	21350/2560	20M QPSK 50%RB#0	0.159	0.080	-0.15	20.71	23.50	0.302	Yes
Left Side	10mm	21350/2560	20M QPSK 50%RB#0	0.049	0.029	0.15	20.71	23.50	0.094	Yes
Right Side	10mm	21350/2560	20M QPSK 50%RB#0	0.075	0.041	0.05	20.71	23.50	0.143	Yes
Bottom Side	10mm	21350/2560	20M QPSK 50%RB#0	0.335	0.171	-0.09	18.12	24.50	1.456	No
Bottom Side	10mm	21350/2560	20M QPSK 1RB#99	0.384	0.194	0.13	18.30	24.50	1.601	No
Bottom Side	10mm	20850/2510	20M QPSK 1RB#0	0.312	0.156	-0.12	18.02	24.50	1.387	No
Bottom Side	10mm	21100/2535	20M QPSK 1RB#0	0.291	0.145	-0.04	18.19	24.50	1.244	No
Bottom Side	10mm	21350/2560(PCC)	20M QPSK 1RB#0	0.323	0.156	-0.03	18.12	24.50	1.403	No
		21152/2540.2(SCC)	20M QPSK 1RB#99							
Additional SAR test at a conservative distance(triggering distance minus 1mm)										
Bottom Side	12mm	21350/2560	20M QPSK 1RB#99	0.467	0.246	-0.09	20.79	24.50	1.097	Yes
Bottom Side	12mm	21350/2560	20M QPSK 50%RB#0	0.486	0.257	-0.08	20.71	23.50	0.924	Yes
Bottom Side	12mm	21350/2560(PCC)	20M QPSK 1RB#0	0.449	0.236	-0.16	20.62	24.50	1.097	Yes
		21152/2540.2(SCC)	20M QPSK 1RB#99							

Table 200: Product Specific 10-g SAR test reduction evaluation of LTE Band 7

Note: According to the table above , only Bottom side is required for Product Specific 10-g SAR test in this frequency band.

Product Specific 10-g SAR	Dist.	Test Channel /Freq.(MHz)	Test Mode	Measured SAR(W/kg)		Power Drift (dB)	Conducted Power (dBm)	Tune-up Power (dBm)	Reported 10-g SAR (W/kg)	Accessory Information	SAR Plot.
				1-g	10-g						
Main Antenna											
Bottom Side	0mm	21350/2560	20M QPSK 1RB#0	3.650	1.300	0.01	20.44	21.00	1.479	Battery 1#	/
Bottom Side	0mm	21350/2560	20M QPSK 50%RB#0	3.060	1.200	-0.07	20.14	21.00	1.463	Battery 1#	/
Bottom Side	0mm	21350/2560	20M QPSK 1RB#0	4.470	1.450	-0.12	20.44	21.00	1.650	Battery 2#	Yes
Bottom Side	0mm	20850/2510	20M QPSK 1RB#0	3.440	1.300	-0.02	20.15	21.00	1.581	Battery 2#	/
Bottom Side	0mm	21100/2535	20M QPSK 1RB#0	3.450	1.290	-0.05	20.21	21.00	1.547	Battery 2#	/
Bottom Side	0mm	21350/2560(PCC)	20M QPSK 1RB#0	3.780	1.230	-0.08	20.13	21.00	1.503	Battery 2#	/
		21152/2540.2(SCC)	20M QPSK 1RB#99								
Additional SAR test at a conservative distance(triggering distance minus 1mm)											
Bottom Side	7mm	21350/2560	20M QPSK 1RB#99	1.990	0.961	-0.05	21.37	22.00	1.111	Battery 2#	/
Bottom Side	7mm	21350/2560	20M QPSK 50%RB#0	1.470	0.666	0.04	21.10	22.00	0.819	Battery 2#	/
Bottom Side	7mm	21350/2560(PCC)	20M QPSK 1RB#0	0.931	0.452	-0.11	21.19	22.00	1.122	Battery 2#	/
		21152/2540.2(SCC)	20M QPSK 1RB#99								
Bottom Side	12mm	21350/2560	20M QPSK 1RB#50	1.140	0.585	-0.06	23.66	24.50	0.710	Battery 2#	/
Bottom Side	12mm	21350/2560	20M QPSK 50%RB#0	0.916	0.454	-0.03	22.58	23.50	0.561	Battery 2#	/
Bottom Side	12mm	21350/2560(PCC)	20M QPSK 1RB#0	0.887	0.465	-0.12	23.53	24.50	1.109	Battery 2#	/
		21152/2540.2(SCC)	20M QPSK 1RB#99								

Table 201: Product Specific 10-g SAR test results of LTE Band 7

7.2.10 SAR measurement Results of LTE Band 12

Test Position of Head	Test Channel /Freq.(MHz)	Test Mode	Measured SAR(W/kg)		Power Drift (dB)	Conducted Power (dBm)	Tune-up Power (dBm)	Reported 1-g SAR (W/kg)	Accessory Information	SAR Plot.
			1-g	10-g						
Second Antenna										
Left cheek	23095/707.5	10M QPSK 1RB#49	0.310	0.155	0.17	19.73	20.50	0.370	Battery 1#	/
Left tilt	23095/707.5	10M QPSK 1RB#49	0.301	0.145	0.03	19.73	20.50	0.359	Battery 1#	/
Right cheek	23095/707.5	10M QPSK 1RB#49	0.295	0.153	-0.01	19.73	20.50	0.352	Battery 1#	/
Right tilt	23095/707.5	10M QPSK 1RB#49	0.343	0.171	-0.05	19.73	20.50	0.410	Battery 1#	/
Left cheek	23095/707.5	10M QPSK 50%RB#0	0.284	0.140	-0.10	19.60	20.50	0.349	Battery 1#	/
Left tilt	23095/707.5	10M QPSK 50%RB#0	0.301	0.142	0.05	19.60	20.50	0.370	Battery 1#	/
Right cheek	23095/707.5	10M QPSK 50%RB#0	0.289	0.151	0.07	19.60	20.50	0.356	Battery 1#	/
Right tilt	23095/707.5	10M QPSK 50%RB#0	0.357	0.173	-0.02	19.60	20.50	0.439	Battery 1#	/
Right tilt	23095/707.5	10M QPSK 50%RB#0	0.368	0.176	-0.03	19.60	20.50	0.453	Battery 2#	/
Right tilt	23060/704	10M QPSK 50%RB#13	0.369	0.176	-0.02	19.53	20.50	0.461	Battery 2#	Yes
Right tilt	23130/711	10M QPSK 50%RB#0	0.357	0.172	-0.04	19.46	20.50	0.454	Battery 2#	/
Main Antenna										
Left cheek	23095/707.5	10M QPSK 1RB#0	0.054	0.043	0.14	24.03	25.00	0.068	Battery 1#	/
Left tilt	23095/707.5	10M QPSK 1RB#0	0.035	0.025	0.05	24.03	25.00	0.044	Battery 1#	/
Right cheek	23095/707.5	10M QPSK 1RB#0	0.064	0.050	0.11	24.03	25.00	0.080	Battery 1#	/
Right tilt	23095/707.5	10M QPSK 1RB#0	0.031	0.022	0.12	24.03	25.00	0.039	Battery 1#	/
Left cheek	23095/707.5	10M QPSK 50%RB#25	0.059	0.046	0.02	23.14	24.00	0.072	Battery 1#	/
Left tilt	23095/707.5	10M QPSK 50%RB#25	0.041	0.029	-0.12	23.14	24.00	0.050	Battery 1#	/
Right cheek	23095/707.5	10M QPSK 50%RB#25	0.058	0.045	0.13	23.14	24.00	0.070	Battery 1#	/
Right tilt	23095/707.5	10M QPSK 50%RB#25	0.028	0.020	0.14	23.14	24.00	0.034	Battery 1#	/
Right cheek	23095/707.5	10M QPSK 1RB#0	0.064	0.051	0.04	24.03	25.00	0.080	Battery 2#	/
Right cheek	23060/704	10M QPSK 1RB#0	0.065	0.051	0.17	24.02	25.00	0.082	Battery 2#	/
Right cheek	23130/711	10M QPSK 1RB#0	0.073	0.057	0.10	23.97	25.00	0.093	Battery 2#	Yes

Table 202: Head SAR test results of LTE Band 12

Test Position of Body-Worn	Dist.	Test Channel /Freq.(MHz)	Test Mode	Measured SAR(W/kg)		Power Drift (dB)	Conducted Power (dBm)	Tune-up Power (dBm)	Reported 1-g SAR (W/kg)	Accessory Information	SAR Plot.
				1-g	10-g						
Second Antenna											
Front Side	15mm	23060/704	10M QPSK 1RB#0	0.139	0.099	-0.01	24.03	25.00	0.174	Battery 1#	/
Back Side	15mm	23060/704	10M QPSK 1RB#0	0.132	0.081	-0.13	24.03	25.00	0.165	Battery 1#	/
Front Side	15mm	23130/711	10M QPSK 50%RB#13	0.132	0.091	-0.02	22.98	24.00	0.167	Battery 1#	/
Back Side	15mm	23130/711	10M QPSK 50%RB#13	0.113	0.070	-0.04	22.98	24.00	0.143	Battery 1#	/
Front Side	15mm	23060/704	10M QPSK 1RB#0	0.139	0.104	0.06	24.03	25.00	0.174	Battery 2#	/
Front Side	15mm	23095/707.5	10M QPSK 1RB#25	0.172	0.129	0.03	23.91	25.00	0.221	Battery 2#	Yes
Front Side	15mm	23130/711	10M QPSK 1RB#0	0.169	0.127	0.04	23.83	25.00	0.221	Battery 2#	/
Main Antenna											
Front Side	15mm	23095/707.5	10M QPSK 1RB#0	0.123	0.086	-0.03	24.03	25.00	0.154	Battery 1#	/
Back Side	15mm	23095/707.5	10M QPSK 1RB#0	0.163	0.121	0.01	24.03	25.00	0.204	Battery 1#	/
Front Side	15mm	23095/707.5	10M QPSK 50%RB#25	0.111	0.078	-0.14	23.14	24.00	0.135	Battery 1#	/
Back Side	15mm	23095/707.5	10M QPSK 50%RB#25	0.153	0.113	-0.07	23.14	24.00	0.187	Battery 1#	/
Back Side	15mm	23095/707.5	10M QPSK 1RB#0	0.199	0.146	-0.16	24.03	25.00	0.249	Battery 2#	/
Back Side	15mm	23060/704	10M QPSK 1RB#0	0.181	0.133	-0.02	24.02	25.00	0.227	Battery 2#	/
Back Side	15mm	23130/711	10M QPSK 1RB#0	0.225	0.165	-0.10	23.97	25.00	0.285	Battery 2#	Yes

Table 203: Body Worn SAR test results of LTE Band 12

Test Position of Hotspot	Dist.	Test Channel /Freq.(MHz)	Test Mode	Measured SAR(W/kg)		Power Drift (dB)	Conducted Power (dBm)	Tune-up Power (dBm)	Reported 1-g SAR (W/kg)	Accessory Information	SAR Plot.
				1-g	10-g						
Second Antenna											
Front Side	10mm	23060/704	10M QPSK 1RB#0	0.232	0.144	-0.02	24.03	25.00	0.290	Battery 1#	/
Back Side	10mm	23060/704	10M QPSK 1RB#0	0.272	0.155	-0.03	24.03	25.00	0.340	Battery 1#	/
Left Side	10mm	23060/704	10M QPSK 1RB#0	0.089	0.061	-0.13	24.03	25.00	0.112	Battery 1#	/
Top Side	10mm	23060/704	10M QPSK 1RB#0	0.222	0.120	0.10	24.03	25.00	0.278	Battery 1#	/
Front Side	10mm	23130/711	10M QPSK 50%RB#13	0.246	0.153	0.01	22.98	24.00	0.311	Battery 1#	/
Back Side	10mm	23130/711	10M QPSK 50%RB#13	0.245	0.156	-0.11	22.98	24.00	0.310	Battery 1#	/
Left Side	10mm	23130/711	10M QPSK 50%RB#13	0.094	0.064	0.00	22.98	24.00	0.119	Battery 1#	/
Top Side	10mm	23130/711	10M QPSK 50%RB#13	0.206	0.110	0.09	22.98	24.00	0.261	Battery 1#	/
Back Side	10mm	23060/704	10M QPSK 1RB#0	0.249	0.178	0.13	24.03	25.00	0.311	Battery 2#	/
Back Side	10mm	23095/707.5	10M QPSK 1RB#25	0.300	0.215	0.07	23.91	25.00	0.386	Battery 1#	/
Back Side	10mm	23130/711	10M QPSK 1RB#0	0.306	0.219	0.04	23.83	25.00	0.401	Battery 1#	Yes
Main Antenna											
Front Side	10mm	23095/707.5	10M QPSK 1RB#0	0.150	0.104	-0.02	24.03	25.00	0.188	Battery 1#	/
Back Side	10mm	23095/707.5	10M QPSK 1RB#0	0.244	0.174	-0.13	24.03	25.00	0.305	Battery 1#	/
Left Side	10mm	23095/707.5	10M QPSK 1RB#0	0.180	0.105	0.01	24.03	25.00	0.225	Battery 1#	/
Right Side	10mm	23095/707.5	10M QPSK 1RB#0	0.090	0.061	-0.11	24.03	25.00	0.112	Battery 1#	/
Bottom Side	10mm	23095/707.5	10M QPSK 1RB#0	0.080	0.048	-0.10	24.03	25.00	0.100	Battery 1#	/
Front Side	10mm	23095/707.5	10M QPSK 50%RB#25	0.133	0.092	0.01	23.14	24.00	0.162	Battery 1#	/
Back Side	10mm	23095/707.5	10M QPSK 50%RB#25	0.199	0.138	-0.06	23.14	24.00	0.243	Battery 1#	/
Left Side	10mm	23095/707.5	10M QPSK 50%RB#25	0.151	0.088	-0.06	23.14	24.00	0.184	Battery 1#	/
Right Side	10mm	23095/707.5	10M QPSK 50%RB#25	0.087	0.060	0.03	23.14	24.00	0.106	Battery 1#	/
Bottom Side	10mm	23095/707.5	10M QPSK 50%RB#25	0.079	0.048	-0.14	23.14	24.00	0.096	Battery 1#	/
Back Side	10mm	23095/707.5	10M QPSK 1RB#0	0.264	0.188	0.03	24.03	25.00	0.330	Battery 2#	/
Back Side	10mm	23060/704	10M QPSK 1RB#0	0.244	0.174	0.19	24.02	25.00	0.306	Battery 2#	/
Back Side	10mm	23130/711	10M QPSK 1RB#0	0.292	0.209	-0.02	23.97	25.00	0.370	Battery 2#	Yes

Table 204: Hotspot SAR test results of LTE Band 12

Note: Per KDB 648474 D04, Product Specific 10-g SAR test is not required for this frequency band since hotspot mode 1-g reported SAR < 1.2 W/kg.

7.2.11 SAR measurement Results of LTE Band 26

Test Position of Head	Test Channel /Freq.(MHz)	Test Mode	Measured SAR(W/kg)		Power Drift (dB)	Conducted Power (dBm)	Tune-up Power (dBm)	Reported 1-g SAR (W/kg)	Accessory Information	SAR Plot.
			1-g	10-g						
Second Antenna										
Left cheek	26965/841.5	15M QPSK 1RB#74	0.344	0.169	0.03	18.35	19.20	0.418	Battery 1#	/
Left tilt	26965/841.5	15M QPSK 1RB#74	0.151	0.074	-0.18	18.35	19.20	0.184	Battery 1#	/
Right cheek	26965/841.5	15M QPSK 1RB#74	0.361	0.188	0.02	18.35	19.20	0.439	Battery 1#	/
Right tilt	26965/841.5	15M QPSK 1RB#74	0.303	0.145	-0.02	18.35	19.20	0.369	Battery 1#	/
Left cheek	26865/831.5	15M QPSK 50%RB#0	0.338	0.167	0.02	18.38	19.20	0.408	Battery 1#	/
Left tilt	26865/831.5	15M QPSK 50%RB#0	0.377	0.179	0.04	18.38	19.20	0.455	Battery 1#	/
Right cheek	26865/831.5	15M QPSK 50%RB#0	0.397	0.206	-0.01	18.38	19.20	0.480	Battery 1#	Yes
Right tilt	26865/831.5	15M QPSK 50%RB#0	0.390	0.186	-0.04	18.38	19.20	0.471	Battery 1#	/
Right cheek	26865/831.5	15M QPSK 50%RB#0	0.379	0.201	-0.01	18.38	19.20	0.458	Battery 2#	/
Right cheek	26765/821.5	15M QPSK 50%RB#0	0.381	0.197	-0.04	18.31	19.20	0.468	Battery 1#	/
Right cheek	26965/841.5	15M QPSK 50%RB#0	0.353	0.184	-0.02	18.31	19.20	0.433	Battery 1#	/
Main Antenna										
Left cheek	26865/831.5	15M QPSK 1RB#38	0.108	0.077	0.11	24.01	25.00	0.136	Battery 1#	/
Left tilt	26865/831.5	15M QPSK 1RB#38	0.071	0.050	-0.03	24.01	25.00	0.089	Battery 1#	/
Right cheek	26865/831.5	15M QPSK 1RB#38	0.126	0.097	-0.04	24.01	25.00	0.158	Battery 1#	/
Right tilt	26865/831.5	15M QPSK 1RB#38	0.059	0.041	0.16	24.01	25.00	0.074	Battery 1#	/
Left cheek	26865/831.5	15M QPSK 50%RB#39	0.073	0.051	-0.19	23.04	24.00	0.091	Battery 1#	/
Left tilt	26865/831.5	15M QPSK 50%RB#39	0.060	0.041	0.02	23.04	24.00	0.075	Battery 1#	/
Right cheek	26865/831.5	15M QPSK 50%RB#39	0.093	0.065	-0.01	23.04	24.00	0.117	Battery 1#	/
Right tilt	26865/831.5	15M QPSK 50%RB#39	0.047	0.032	0.11	23.04	24.00	0.058	Battery 1#	/
Right cheek	26865/831.5	15M QPSK 1RB#38	0.140	0.107	0.04	24.01	25.00	0.176	Battery 2#	/
Right cheek	26765/821.5	15M QPSK 1RB#38	0.127	0.098	0.13	23.86	25.00	0.165	Battery 2#	/
Right cheek	26965/841.5	15M QPSK 1RB#0	0.140	0.107	0.16	23.74	25.00	0.187	Battery 2#	Yes

Table 205: Head SAR test results of LTE Band 26

Test Position of Body-Worn	Dist.	Test Channel /Freq.(MHz)	Test Mode	Measured SAR(W/kg)		Power Drift (dB)	Conducted Power (dBm)	Tune-up Power (dBm)	Reported 1-g SAR (W/kg)	Accessory Information	SAR Plot.
				1-g	10-g						
Second Antenna											
Front Side	15mm	26865/831.5	15M QPSK 1RB#74	0.232	0.154	0.00	23.85	24.70	0.282	Battery 1#	/
Back Side	15mm	26865/831.5	15M QPSK 1RB#74	0.241	0.162	-0.04	23.85	24.70	0.293	Battery 1#	/
Front Side	15mm	26765/821.5	15M QPSK 50%RB#18	0.164	0.110	-0.06	22.84	23.70	0.200	Battery 1#	/
Back Side	15mm	26765/821.5	15M QPSK 50%RB#18	0.168	0.113	-0.01	22.84	23.70	0.205	Battery 1#	/
Back Side	15mm	26865/831.5	15M QPSK 1RB#74	0.246	0.164	-0.05	23.85	24.70	0.299	Battery 2#	/
Back Side	15mm	26765/821.5	15M QPSK 1RB#74	0.246	0.165	-0.04	23.58	24.70	0.318	Battery 2#	/
Back Side	15mm	26965/841.5	15M QPSK 1RB#38	0.262	0.175	-0.08	23.66	24.70	0.333	Battery 2#	Yes
Main Antenna											
Front Side	15mm	26865/831.5	15M QPSK 1RB#38	0.208	0.142	0.04	24.01	25.00	0.261	Battery 1#	/
Back Side	15mm	26865/831.5	15M QPSK 1RB#38	0.264	0.186	0.06	24.01	25.00	0.332	Battery 1#	/
Front Side	15mm	26865/831.5	15M QPSK 50%RB#39	0.168	0.115	-0.03	23.04	24.00	0.210	Battery 1#	/
Back Side	15mm	26865/831.5	15M QPSK 50%RB#39	0.213	0.145	-0.01	23.04	24.00	0.266	Battery 1#	/
Back Side	15mm	26865/831.5	15M QPSK 1RB#38	0.273	0.192	-0.09	24.01	25.00	0.343	Battery 2#	/
Back Side	15mm	26765/821.5	15M QPSK 1RB#38	0.277	0.195	-0.01	23.86	25.00	0.360	Battery 2#	Yes
Back Side	15mm	26965/841.5	15M QPSK 1RB#0	0.270	0.190	-0.08	23.74	25.00	0.361	Battery 2#	/

Table 206: Body Worn SAR test results of LTE Band 26

Test Position of Hotspot	Dist.	Test Channel /Freq.(MHz)	Test Mode	Measured SAR(W/kg)		Power Drift (dB)	Conducted Power (dBm)	Tune-up Power (dBm)	Reported 1-g SAR (W/kg)	Accessory Information	SAR Plot.
				1-g	10-g						
Second Antenna											
Front Side	10mm	26865/831.5	15M QPSK 1RB#74	0.497	0.273	-0.03	23.85	24.70	0.604	Battery 1#	/
Back Side	10mm	26865/831.5	15M QPSK 1RB#74	0.550	0.302	-0.08	23.85	24.70	0.669	Battery 1#	/
Left Side	10mm	26865/831.5	15M QPSK 1RB#74	0.282	0.133	-0.02	23.85	24.70	0.343	Battery 1#	/
Top Side	10mm	26865/831.5	15M QPSK 1RB#74	0.319	0.155	0.00	23.85	24.70	0.388	Battery 1#	/
Front Side	10mm	26765/821.5	15M QPSK 50%RB#18	0.360	0.210	-0.04	22.84	23.70	0.439	Battery 1#	/
Back Side	10mm	26765/821.5	15M QPSK 50%RB#18	0.374	0.233	-0.05	22.84	23.70	0.456	Battery 1#	/
Left Side	10mm	26765/821.5	15M QPSK 50%RB#18	0.148	0.098	0.00	22.84	23.70	0.180	Battery 1#	/
Top Side	10mm	26765/821.5	15M QPSK 50%RB#18	0.238	0.116	0.01	22.84	23.70	0.290	Battery 1#	/
Back Side	10mm	26865/831.5	15M QPSK 1RB#74	0.474	0.264	-0.15	23.85	24.70	0.576	Battery 2#	/
Back Side	10mm	26765/821.5	15M QPSK 1RB#74	0.489	0.270	0.02	23.58	24.70	0.633	Battery 1#	/
Back Side	10mm	26965/841.5	15M QPSK 1RB#38	0.578	0.320	-0.07	23.66	24.70	0.734	Battery 1#	Yes
Main Antenna											
Front Side	10mm	26865/831.5	15M QPSK 1RB#38	0.319	0.218	-0.14	24.01	25.00	0.401	Battery 1#	/
Back Side	10mm	26865/831.5	15M QPSK 1RB#38	0.450	0.304	-0.06	24.01	25.00	0.565	Battery 1#	/
Left Side	10mm	26865/831.5	15M QPSK 1RB#38	0.245	0.137	-0.13	24.01	25.00	0.308	Battery 1#	/
Right Side	10mm	26865/831.5	15M QPSK 1RB#38	0.145	0.098	-0.08	24.01	25.00	0.182	Battery 1#	/
Bottom Side	10mm	26865/831.5	15M QPSK 1RB#38	0.298	0.191	0.10	24.01	25.00	0.374	Battery 1#	/
Front Side	10mm	26865/831.5	15M QPSK 50%RB#39	0.261	0.179	-0.03	23.04	24.00	0.326	Battery 1#	/
Back Side	10mm	26865/831.5	15M QPSK 50%RB#39	0.367	0.245	-0.08	23.04	24.00	0.458	Battery 1#	/
Left Side	10mm	26865/831.5	15M QPSK 50%RB#39	0.211	0.117	-0.07	23.04	24.00	0.263	Battery 1#	/
Right Side	10mm	26865/831.5	15M QPSK 50%RB#39	0.113	0.076	-0.03	23.04	24.00	0.141	Battery 1#	/
Bottom Side	10mm	26865/831.5	15M QPSK 50%RB#39	0.250	0.163	-0.12	23.04	24.00	0.312	Battery 1#	/
Back Side	10mm	26865/831.5	15M QPSK 1RB#38	0.464	0.314	-0.09	24.01	25.00	0.583	Battery 2#	Yes
Back Side	10mm	26765/821.5	15M QPSK 1RB#38	0.461	0.313	0.03	23.86	25.00	0.599	Battery 2#	/
Back Side	10mm	26965/841.5	15M QPSK 1RB#0	0.444	0.299	-0.13	23.74	25.00	0.593	Battery 2#	/

Table 207: Hotspot SAR test results of LTE Band 26

Note: Per KDB 648474 D04, Product Specific 10-g SAR test is not required for this frequency band since hotspot mode 1-g reported SAR < 1.2 W/kg.

7.2.12 SAR measurement Results of LTE Band 38

Test Position of Head	Test Channel /Freq.(MHz)	Test Mode	Measured SAR(W/kg)		Power Drift (dB)	Conducted Power (dBm)	Tune-up Power (dBm)	Reported 1-g SAR (W/kg)	Accessory Information	SAR Plot.
			1-g	10-g						
Second Antenna										
Left cheek	38000/2595	20M QPSK 1RB#50	0.148	0.068	-0.16	18.54	19.00	0.165	Battery 1#	/
Left tilt	38000/2595	20M QPSK 1RB#50	0.201	0.092	0.10	18.54	19.00	0.223	Battery 1#	/
Right cheek	38000/2595	20M QPSK 1RB#50	0.232	0.109	0.06	18.54	19.00	0.258	Battery 1#	/
Right tilt	38000/2595	20M QPSK 1RB#50	0.313	0.141	0.01	18.54	19.00	0.348	Battery 1#	/
Left cheek	38000/2595	20M QPSK 50%RB#25	0.131	0.060	-0.01	18.39	19.00	0.151	Battery 1#	/
Left tilt	38000/2595	20M QPSK 50%RB#25	0.171	0.078	0.02	18.39	19.00	0.197	Battery 1#	/
Right cheek	38000/2595	20M QPSK 50%RB#25	0.205	0.097	-0.14	18.39	19.00	0.236	Battery 1#	/
Right tilt	38000/2595	20M QPSK 50%RB#25	0.290	0.129	-0.12	18.39	19.00	0.334	Battery 1#	/
Right tilt	38000/2595	20M QPSK 1RB#50	0.389	0.176	-0.02	18.54	19.00	0.432	Battery 2#	/
Right tilt	37850/2580	20M QPSK 1RB#50	0.430	0.196	-0.19	18.37	19.00	0.497	Battery 2#	Yes
Right tilt	38150/2610	20M QPSK 1RB#50	0.372	0.169	0.12	18.36	19.00	0.431	Battery 2#	/
Right tilt	37850/2580(PCC)	20M QPSK 1RB#99	0.390	0.158	0.05	18.18	19.00	0.471	Battery 2#	/
	38048/2599.8(SCC)	20M QPSK 1RB#0								
Main Antenna										
Left cheek	38000/2595	20M QPSK 1RB#50	0.099	0.052	0.03	24.46	25.00	0.112	Battery 1#	/
Left tilt	38000/2595	20M QPSK 1RB#50	0.074	0.034	-0.19	24.46	25.00	0.083	Battery 1#	/
Right cheek	38000/2595	20M QPSK 1RB#50	0.139	0.076	0.01	24.46	25.00	0.157	Battery 1#	Yes
Right tilt	38000/2595	20M QPSK 1RB#50	0.043	0.021	0.19	24.46	25.00	0.049	Battery 1#	/
Left cheek	37850/2580	20M QPSK 50%RB#50	0.073	0.038	0.10	23.33	24.00	0.086	Battery 1#	/
Left tilt	37850/2580	20M QPSK 50%RB#50	0.057	0.027	-0.02	23.33	24.00	0.067	Battery 1#	/
Right cheek	37850/2580	20M QPSK 50%RB#50	0.093	0.047	0.09	23.33	24.00	0.108	Battery 1#	/
Right tilt	37850/2580	20M QPSK 50%RB#50	0.027	0.013	0.12	23.33	24.00	0.032	Battery 1#	/
Right cheek	38000/2595	20M QPSK 1RB#50	0.120	0.065	-0.14	24.46	25.00	0.136	Battery 2#	/
Right cheek	37850/2580	20M QPSK 1RB#50	0.121	0.066	0.01	24.42	25.00	0.138	Battery 1#	/
Right cheek	38150/2610	20M QPSK 1RB#99	0.111	0.060	-0.09	24.45	25.00	0.126	Battery 1#	/
Right cheek	37850/2580(PCC)	20M QPSK 1RB#99	0.109	0.056	-0.01	23.88	25.00	0.141	Battery 1#	/
	38048/2599.8(SCC)	20M QPSK 1RB#0								

Table 208: Head SAR test results of LTE Band 38



Test Position of Body-Worn	Dist.	Test Channel /Freq.(MHz)	Test Mode	Measured SAR(W/kg)		Power Drift (dB)	Conducted Power (dBm)	Tune-up Power (dBm)	Reported 1-g SAR (W/kg)	Accessory Information	SAR Plot.
				1-g	10-g						
Second Antenna											
Front Side	15mm	37850/2580	20M QPSK 1RB#0	0.068	0.036	0.07	22.96	23.50	0.076	Battery 1#	/
Back Side	15mm	37850/2580	20M QPSK 1RB#0	0.170	0.089	0.16	22.96	23.50	0.193	Battery 1#	/
Front Side	15mm	37850/2580	20M QPSK 50%RB#0	0.051	0.028	-0.06	21.90	22.50	0.058	Battery 1#	/
Back Side	15mm	37850/2580	20M QPSK 50%RB#0	0.119	0.061	0.15	21.90	22.50	0.137	Battery 1#	/
Back Side	15mm	37850/2580	20M QPSK 1RB#0	0.184	0.095	-0.02	22.96	23.50	0.208	Battery 2#	Yes
Back Side	15mm	38000/2595	20M QPSK 1RB#0	0.156	0.077	-0.17	22.95	23.50	0.177	Battery 2#	/
Back Side	15mm	38150/2610	20M QPSK 1RB#50	0.169	0.087	-0.04	22.93	23.50	0.193	Battery 2#	/
Back Side	15mm	37850/2580	20M QPSK 1RB#99	0.161	0.088	0.01	22.46	23.50	0.205	Battery 2#	/
		38048/2599.8	20M QPSK 1RB#0								
Main Antenna											
Front Side	15mm	38000/2595	20M QPSK 1RB#50	0.198	0.106	-0.06	24.46	25.00	0.224	Battery 1#	/
Back Side	15mm	38000/2595	20M QPSK 1RB#50	0.312	0.171	0.01	24.46	25.00	0.353	Battery 1#	Yes
Front Side	15mm	37850/2580	20M QPSK 50%RB#50	0.138	0.074	-0.06	23.33	24.00	0.161	Battery 1#	/
Back Side	15mm	37850/2580	20M QPSK 50%RB#50	0.192	0.102	-0.11	23.33	24.00	0.224	Battery 1#	/
Back Side	15mm	38000/2595	20M QPSK 1RB#50	0.295	0.162	-0.18	24.46	25.00	0.334	Battery 2#	/
Back Side	15mm	37850/2580	20M QPSK 1RB#50	0.273	0.152	0.13	24.42	25.00	0.312	Battery 1#	/
Back Side	15mm	38150/2610	20M QPSK 1RB#99	0.259	0.143	0.05	24.45	25.00	0.294	Battery 1#	/
Back Side	15mm	37850/2580(PCC)	20M QPSK 1RB#99	0.267	0.150	0.06	23.88	25.00	0.346	Battery 1#	/
		38048/2599.8(SCC)	20M QPSK 1RB#0								

Table 209: Body Worn SAR test results of LTE Band 38

Test Position of Hotspot	Dist.	Test Channel /Freq.(MHz)	Test Mode	Measured SAR(W/kg)		Power Drift (dB)	Conducted Power (dBm)	Tune-up Power (dBm)	Reported 1-g SAR (W/kg)	Accessory Information	SAR Plot.
				1-g	10-g						
Second Antenna											
Front Side	10mm	37850/2580	20M QPSK 1RB#0	0.141	0.075	-0.02	22.18	22.50	0.152	Battery 1#	/
Back Side	10mm	37850/2580	20M QPSK 1RB#0	0.387	0.183	-0.08	22.18	22.50	0.417	Battery 1#	/
Left Side	10mm	37850/2580	20M QPSK 1RB#0	0.041	0.017	-0.12	22.18	22.50	0.044	Battery 1#	/
Top Side	10mm	37850/2580	20M QPSK 1RB#0	0.264	0.131	0.02	22.18	22.50	0.284	Battery 1#	/
Front Side	10mm	37850/2580	20M QPSK 50%RB#0	0.129	0.068	0.17	21.91	22.50	0.148	Battery 1#	/
Back Side	10mm	37850/2580	20M QPSK 50%RB#0	0.350	0.171	0.08	21.91	22.50	0.401	Battery 1#	/
Left Side	10mm	37850/2580	20M QPSK 50%RB#0	0.053	0.024	-0.09	21.91	22.50	0.060	Battery 1#	/
Top Side	10mm	37850/2580	20M QPSK 50%RB#0	0.258	0.128	-0.03	21.91	22.50	0.296	Battery 1#	/
Back Side	10mm	37850/2580	20M QPSK 1RB#0	0.378	0.173	0.15	22.18	22.50	0.407	Battery 2#	/
Back Side	10mm	38000/2595	20M QPSK 1RB#0	0.439	0.201	-0.16	22.14	22.50	0.477	Battery 1#	Yes
Back Side	10mm	38150/2610	20M QPSK 1RB#99	0.360	0.167	0.09	22.04	22.50	0.400	Battery 1#	/
Back Side	10mm	37850/2580(PCC)	20M QPSK 1RB#99	0.300	0.147	0.15	21.64	22.50	0.366	Battery 1#	/
		38048/2599.8(SCC)	20M QPSK 1RB#0								
Main Antenna											
Front Side	10mm	38150/2610	20M QPSK 1RB#99	0.231	0.116	0.15	22.64	23.00	0.251	Battery 1#	/
Back Side	10mm	38150/2610	20M QPSK 1RB#99	0.348	0.170	0.11	22.64	23.00	0.378	Battery 1#	/
Left Side	10mm	38150/2610	20M QPSK 1RB#99	0.037	0.022	0.06	22.64	23.00	0.040	Battery 1#	/
Right Side	10mm	38150/2610	20M QPSK 1RB#99	0.047	0.025	0.04	22.64	23.00	0.051	Battery 1#	/
Bottom Side	10mm	37850/2580	20M QPSK 1RB#0	0.432	0.221	-0.04	21.64	22.00	0.469	Battery 1#	/
Front Side	10mm	37850/2580	20M QPSK 50%RB#0	0.222	0.113	-0.16	22.37	23.00	0.257	Battery 1#	/
Back Side	10mm	37850/2580	20M QPSK 50%RB#0	0.278	0.141	-0.10	22.37	23.00	0.321	Battery 1#	/
Left Side	10mm	37850/2580	20M QPSK 50%RB#0	0.039	0.023	0.19	22.37	23.00	0.045	Battery 1#	/
Right Side	10mm	37850/2580	20M QPSK 50%RB#0	0.053	0.029	0.11	22.37	23.00	0.061	Battery 1#	/
Bottom Side	10mm	38000/2595	20M QPSK 50%RB#25	0.408	0.195	-0.05	21.29	22.00	0.480	Battery 1#	/
Bottom Side	10mm	37850/2580	20M QPSK 1RB#0	0.483	0.244	-0.01	21.64	22.00	0.525	Battery 2#	/
Bottom Side	10mm	38000/2595	20M QPSK 1RB#50	0.524	0.263	-0.04	21.38	22.00	0.604	Battery 2#	/
Bottom Side	10mm	38150/2610	20M QPSK 1RB#50	0.668	0.340	-0.04	21.57	22.00	0.738	Battery 2#	Yes
Bottom Side	10mm	37850/2580(PCC)	20M QPSK 1RB#99	0.503	0.256	-0.01	21.13	22.00	0.615	Battery 2#	/
		38048/2599.8(SCC)	20M QPSK 1RB#0								
Additional SAR test at a conservative distance(triggering distance minus 1mm)											
Bottom Side	12mm	38150/2610	20M QPSK 1RB#99	0.395	0.207	0.05	22.64	23.00	0.429	Battery 2#	/
Bottom Side	12mm	37850/2580	20M QPSK 50%RB#0	0.366	0.194	0.06	22.37	23.00	0.423	Battery 2#	/
Bottom Side	12mm	37850/2580(PCC)	20M QPSK 1RB#99	0.398	0.208	-0.16	22.19	23.00	0.480	Battery 2#	/
		38048/2599.8(SCC)	20M QPSK 1RB#0								

Table 210: Hotspot SAR test results of LTE Band 38

Per KDB648474D04, when hotspot mode applies, Product Specific 10-g SAR is required only for the surfaces and edges with hotspot mode 1-g reported SAR > 1.2 W/kg; however, when power reduction applies to hotspot mode the measured SAR must be scaled to the maximum output power, including tolerance, allowed for phablet modes to compare with the 1.2 W/kg SAR test reduction threshold:

Test Position of Hotspot	Dist.	Test Channel /Freq.(MHz)	Test Mode	Measured SAR(W/kg)		Power Drift (dB)	Conducted Power (dBm)	Max Power Without Reduction	Scaled-up 1-g SAR (W/kg)	Product Specific 10-g SAR Exclusion
				1-g	10-g					
Second Antenna										
Front Side	10mm	37850/2580	20M QPSK 1RB#0	0.141	0.075	-0.02	22.18	23.50	0.191	Yes
Back Side	10mm	37850/2580	20M QPSK 1RB#0	0.387	0.183	-0.08	22.18	23.50	0.524	Yes
Left Side	10mm	37850/2580	20M QPSK 1RB#0	0.041	0.017	-0.12	22.18	23.50	0.056	Yes
Top Side	10mm	37850/2580	20M QPSK 1RB#0	0.264	0.131	0.02	22.18	23.50	0.358	Yes
Front Side	10mm	37850/2580	20M QPSK 50%RB#0	0.129	0.068	0.17	21.91	22.50	0.148	Yes
Back Side	10mm	37850/2580	20M QPSK 50%RB#0	0.350	0.171	0.08	21.91	22.50	0.401	Yes
Left Side	10mm	37850/2580	20M QPSK 50%RB#0	0.053	0.024	-0.09	21.91	22.50	0.060	Yes
Top Side	10mm	37850/2580	20M QPSK 50%RB#0	0.258	0.128	-0.03	21.91	22.50	0.296	Yes
Back Side	10mm	37850/2580	20M QPSK 1RB#0	0.378	0.173	0.15	22.18	23.50	0.512	Yes
Back Side	10mm	38000/2595	20M QPSK 1RB#0	0.439	0.201	-0.16	22.14	23.50	0.600	Yes
Back Side	10mm	38150/2610	20M QPSK 1RB#99	0.360	0.167	0.09	22.04	23.50	0.504	Yes
Back Side	10mm	37850/2580(PCC)	20M QPSK 1RB#99	0.300	0.147	0.15	21.64	23.50	0.460	Yes
		38048/2599.8(SCC)	20M QPSK 1RB#0							
Main Antenna										
Front Side	10mm	38150/2610	20M QPSK 1RB#99	0.231	0.116	0.15	22.64	25.00	0.398	Yes
Back Side	10mm	38150/2610	20M QPSK 1RB#99	0.348	0.170	0.11	22.64	25.00	0.599	Yes
Left Side	10mm	38150/2610	20M QPSK 1RB#99	0.037	0.022	0.06	22.64	25.00	0.064	Yes
Right Side	10mm	38150/2610	20M QPSK 1RB#99	0.047	0.025	0.04	22.64	25.00	0.081	Yes
Bottom Side	10mm	37850/2580	20M QPSK 1RB#0	0.432	0.221	-0.04	21.64	25.00	0.936	Yes
Front Side	10mm	37850/2580	20M QPSK 50%RB#0	0.222	0.113	-0.16	22.37	24.00	0.323	Yes
Back Side	10mm	37850/2580	20M QPSK 50%RB#0	0.278	0.141	-0.10	22.37	24.00	0.405	Yes
Left Side	10mm	37850/2580	20M QPSK 50%RB#0	0.039	0.023	0.19	22.37	24.00	0.057	Yes
Right Side	10mm	37850/2580	20M QPSK 50%RB#0	0.053	0.029	0.11	22.37	24.00	0.076	Yes
Bottom Side	10mm	38000/2595	20M QPSK 50%RB#25	0.408	0.195	-0.05	21.29	24.00	0.761	Yes
Bottom Side	10mm	37850/2580	20M QPSK 1RB#0	0.483	0.244	-0.01	21.64	25.00	1.047	Yes
Bottom Side	10mm	38000/2595	20M QPSK 1RB#50	0.524	0.263	-0.04	21.38	25.00	1.206	No
Bottom Side	10mm	38150/2610	20M QPSK 1RB#50	0.668	0.340	-0.04	21.57	25.00	1.472	No
Bottom Side	10mm	37850/2580(PCC)	20M QPSK 1RB#99	0.503	0.256	-0.01	21.13	25.00	1.226	No
		38048/2599.8(SCC)	20M QPSK 1RB#0							
Additional SAR test at a conservative distance(triggering distance minus 1mm)										
Bottom Side	12mm	38150/2610	20M QPSK 1RB#99	0.395	0.207	0.05	22.64	25.00	0.680	Yes
Bottom Side	12mm	37850/2580	20M QPSK 50%RB#0	0.366	0.194	0.06	22.37	25.00	0.671	Yes
Bottom Side	12mm	37850/2580(PCC)	20M QPSK 1RB#99	0.398	0.208	-0.16	22.17	25.00	0.764	Yes
		38048/2599.8(SCC)	20M QPSK 1RB#0							

Table 211: Product Specific 10-g SAR test reduction evaluation of LTE Band 38

Note: According to the table above , only Bottom side is required for Product Specific 10-g SAR test in this frequency band.

Product Specific 10-g SAR	Dist.	Test Channel /Freq.(MHz)	Test Mode	Measured SAR(W/kg)		Power Drift (dB)	Conducted Power (dBm)	Tune-up Power (dBm)	Reported 10-g SAR (W/kg)	Accessory Information	SAR Plot.
				1-g	10-g						
Main Antenna											
Bottom Side	0mm	38150/2610	20M QPSK 1RB#99	3.410	1.110	-0.12	22.64	23.00	1.206	Battery 1#	/
Bottom Side	0mm	37850/2580	20M QPSK 50%RB#0	3.600	1.170	-0.07	22.37	23.00	1.353	Battery 1#	/
Bottom Side	0mm	37850/2580	20M QPSK 50%RB#0	4.760	1.530	0.01	22.37	23.00	1.769	Battery 2#	Yes
Bottom Side	0mm	38000/2595	20M QPSK 50%RB#50	3.630	1.190	0.06	22.25	23.00	1.414	Battery 2#	/
Bottom Side	0mm	38150/2610	20M QPSK 50%RB#50	3.960	1.300	-0.12	22.15	23.00	1.581	Battery 2#	/
Bottom Side	0mm	37850/2580(PCC)	20M QPSK 1RB#99	4.100	1.350	-0.03	22.19	23.00	1.627	Battery 2#	/
		38048/2599.8(SCC)	20M QPSK 1RB#0								
Additional SAR test at a conservative distance(triggering distance minus 1mm)											
Bottom Side	7mm	37850/2580	20M QPSK 1RB#0	1.220	0.577	0.01	23.58	24.00	0.636	Battery 1#	/
Bottom Side	7mm	37850/2580	20M QPSK 50%RB#50	1.290	0.617	-0.08	23.33	24.00	0.720	Battery 1#	/
Bottom Side	7mm	37850/2580(PCC)	20M QPSK 1RB#99	1.010	0.488	-0.10	23.03	24.00	1.263	Battery 2#	/
		38048/2599.8(SCC)	20M QPSK 1RB#0								
Bottom Side	12mm	38000/2595	20M QPSK 1RB#50	0.718	0.379	-0.05	24.46	25.00	0.429	Battery 2#	/
Bottom Side	12mm	37850/2580	20M QPSK 50%RB#50	0.510	0.269	-0.03	23.33	24.00	0.314	Battery 2#	/
Bottom Side	12mm	37850/2580(PCC)	20M QPSK 1RB#99	0.658	0.344	0.00	23.88	25.00	0.852	Battery 2#	/
		38048/2599.8(SCC)	20M QPSK 1RB#0								

Table 212: Product Specific 10-g SAR test results of LTE Band 38

7.2.13 SAR measurement Results of LTE Band 41

Test Position of Head	Test Channel /Freq.(MHz)	Test Mode	Measured SAR(W/kg)		Power Drift (dB)	Conducted Power (dBm)	Tune-up Power (dBm)	Reported 1-g SAR (W/kg)	Accessory Information	SAR Plot
			1-g	10-g						
Second Antenna										
Left cheek	40473/2578.3	20M QPSK 1RB#0	0.147	0.068	-0.15	17.75	18.50	0.175	Battery 1#	/
Left tilt	40473/2578.3	20M QPSK 1RB#0	0.180	0.084	0.09	17.75	18.50	0.214	Battery 1#	/
Right cheek	40473/2578.3	20M QPSK 1RB#0	0.246	0.114	-0.10	17.75	18.50	0.292	Battery 1#	/
Right tilt	40473/2578.3	20M QPSK 1RB#0	0.311	0.138	0.04	17.75	18.50	0.370	Battery 1#	/
Left cheek	40140/2545	20M QPSK 50%RB#0	0.170	0.081	0.01	17.97	18.50	0.192	Battery 1#	/
Left tilt	40140/2545	20M QPSK 50%RB#0	0.211	0.100	-0.01	17.97	18.50	0.238	Battery 1#	/
Right cheek	40140/2545	20M QPSK 50%RB#0	0.277	0.132	0.03	17.97	18.50	0.313	Battery 1#	/
Right tilt	40140/2545	20M QPSK 50%RB#0	0.348	0.154	0.14	17.97	18.50	0.393	Battery 1#	/
Right tilt	40140/2545	20M QPSK 50%RB#0	0.522	0.232	-0.02	17.97	18.50	0.590	Battery 2#	Yes
Right tilt	40473/2578.3	20M QPSK 50%RB#0	0.431	0.197	-0.05	17.96	18.50	0.488	Battery 2#	/
Right tilt	40807/2611.7	20M QPSK 50%RB#0	0.353	0.158	-0.18	17.77	18.50	0.418	Battery 2#	/
Right tilt	41140/2645	20M QPSK 50%RB#0	0.300	0.131	0.00	17.76	18.50	0.356	Battery 2#	/
Right tilt	40140/2545(PCC)	20M QPSK 1RB#99	0.468	0.215	0.07	17.65	18.50	0.569	Battery 2#	/
	40338/2564.8(SCC)	20M QPSK 1RB#0								
Test at the best acoustic position										
Right tilt	40140/2545	20M QPSK 50%RB#0	0.389	0.174	0.15	17.97	18.50	0.439	Battery 2#	/
Main Antenna										
Left cheek	41140/2645	20M QPSK 1RB#0	0.089	0.046	-0.08	24.31	25.00	0.104	Battery 1#	/
Left tilt	41140/2645	20M QPSK 1RB#0	0.076	0.035	0.17	24.31	25.00	0.089	Battery 1#	/
Right cheek	41140/2645	20M QPSK 1RB#0	0.139	0.074	0.19	24.31	25.00	0.163	Battery 1#	/
Right tilt	41140/2645	20M QPSK 1RB#0	0.044	0.021	0.13	24.31	25.00	0.051	Battery 1#	/
Left cheek	41140/2645	20M QPSK 50%RB#50	0.069	0.036	0.19	23.39	24.00	0.080	Battery 1#	/
Left tilt	41140/2645	20M QPSK 50%RB#50	0.061	0.029	0.16	23.39	24.00	0.070	Battery 1#	/
Right cheek	41140/2645	20M QPSK 50%RB#50	0.106	0.053	0.19	23.39	24.00	0.122	Battery 1#	/
Right tilt	41140/2645	20M QPSK 50%RB#50	0.040	0.019	0.12	23.39	24.00	0.045	Battery 1#	/
Right cheek	41140/2645	20M QPSK 1RB#0	0.118	0.059	-0.07	24.31	25.00	0.138	Battery 2#	/
Right cheek	40140/2545	20M QPSK 1RB#50	0.147	0.081	0.14	24.27	25.00	0.174	Battery 1#	/
Right cheek	40473/2578.3	20M QPSK 1RB#50	0.153	0.083	-0.04	24.05	25.00	0.190	Battery 1#	Yes
Right cheek	40807/2611.7	20M QPSK 1RB#50	0.140	0.076	-0.11	24.16	25.00	0.170	Battery 1#	/
Right cheek	40140/2545(PCC)	20M QPSK 1RB#99	0.120	0.061	0.12	24.15	25.00	0.146	Battery 1#	/
	40338/2564.8(SCC)	20M QPSK 1RB#0								

Table 213: Head SAR test results of LTE Band 41

Test Position of Body-Worn	Dist.	Test Channel /Freq.(MHz)	Test Mode	Measured SAR(W/kg)		Power Drift (dB)	Conducted Power (dBm)	Tune-up Power (dBm)	Reported 1-g SAR (W/kg)	Accessory Information	SAR Plot.
				1-g	10-g						
Second Antenna											
Front Side	15mm	40473/2578.3	20M QPSK 1RB#0	0.085	0.047	0.06	22.78	23.50	0.100	Battery 1#	/
Back Side	15mm	40473/2578.3	20M QPSK 1RB#0	0.224	0.111	0.19	22.78	23.50	0.264	Battery 1#	/
Front Side	15mm	40473/2578.3	20M QPSK 50%RB#0	0.066	0.037	0.16	21.97	22.50	0.075	Battery 1#	/
Back Side	15mm	40473/2578.3	20M QPSK 50%RB#0	0.176	0.086	-0.05	21.97	22.50	0.199	Battery 1#	/
Back Side	15mm	40473/2578.3	20M QPSK 1RB#0	0.218	0.109	0.04	22.78	23.50	0.257	Battery 2#	/
Back Side	15mm	40140/2545	20M QPSK 1RB#99	0.252	0.127	0.18	22.71	23.50	0.302	Battery 1#	Yes
Back Side	15mm	40807/2611.7	20M QPSK 1RB#0	0.174	0.086	0.11	22.35	23.50	0.227	Battery 1#	/
Back Side	15mm	41140/2645	20M QPSK 1RB#99	0.152	0.071	-0.18	22.47	23.50	0.193	Battery 1#	/
Back Side	15mm	40140/2545(PCC)	20M QPSK 1RB#99	0.182	0.091	0.07	22.55	23.50	0.227	Battery 1#	/
		40338/2564.8(SCC)	20M QPSK 1RB#0								
Main Antenna											
Front Side	15mm	41140/2645	20M QPSK 1RB#0	0.211	0.111	0.16	24.31	25.00	0.247	Battery 1#	/
Back Side	15mm	41140/2645	20M QPSK 1RB#0	0.290	0.154	-0.10	24.31	25.00	0.340	Battery 1#	/
Front Side	15mm	41140/2645	20M QPSK 50%RB#50	0.156	0.082	0.08	23.39	24.00	0.180	Battery 1#	/
Back Side	15mm	41140/2645	20M QPSK 50%RB#50	0.231	0.122	0.04	23.39	24.00	0.266	Battery 1#	/
Back Side	15mm	41140/2645	20M QPSK 1RB#0	0.315	0.166	0.05	24.31	25.00	0.369	Battery 2#	Yes
Back Side	15mm	40140/2545	20M QPSK 1RB#50	0.277	0.151	0.02	24.27	25.00	0.328	Battery 2#	/
Back Side	15mm	40473/2578.3	20M QPSK 1RB#50	0.277	0.147	-0.12	24.05	25.00	0.345	Battery 2#	/
Back Side	15mm	40807/2611.7	20M QPSK 1RB#50	0.296	0.158	0.04	24.16	25.00	0.359	Battery 2#	/
Back Side	15mm	40140/2545(PCC)	20M QPSK 1RB#99	0.207	0.113	0.18	24.15	25.00	0.252	Battery 2#	/
		40338/2564.8(SCC)	20M QPSK 1RB#0								

Table 214: Body Worn SAR test results of LTE Band 41

Test Position of Hotspot	Dist.	Test Channel /Freq.(MHz)	Test Mode	Measured SAR(W/kg)		Power Drift (dB)	Conducted Power (dBm)	Tune-up Power (dBm)	Reported 1-g SAR (W/kg)	Accessory Information	SAR Plot.
				1-g	10-g						
Second Antenna											
Front Side	10mm	40473/2578.3	20M QPSK 1RB#99	0.091	0.048	0.06	20.94	21.50	0.104	Battery 1#	/
Back Side	10mm	40473/2578.3	20M QPSK 1RB#99	0.345	0.150	0.02	20.94	21.50	0.392	Battery 1#	/
Left Side	10mm	40473/2578.3	20M QPSK 1RB#99	0.032	0.016	-0.11	20.94	21.50	0.037	Battery 1#	/
Top Side	10mm	40473/2578.3	20M QPSK 1RB#99	0.260	0.132	0.11	20.94	21.50	0.296	Battery 1#	/
Front Side	10mm	40473/2578.3	20M QPSK 50%RB#25	0.098	0.051	-0.19	21.03	21.50	0.109	Battery 1#	/
Back Side	10mm	40473/2578.3	20M QPSK 50%RB#25	0.282	0.126	0.17	21.03	21.50	0.314	Battery 1#	/
Left Side	10mm	40473/2578.3	20M QPSK 50%RB#25	0.034	0.016	0.12	21.03	21.50	0.038	Battery 1#	/
Top Side	10mm	40473/2578.3	20M QPSK 50%RB#25	0.244	0.127	-0.10	21.03	21.50	0.272	Battery 1#	/
Back Side	10mm	40473/2578.3	20M QPSK 1RB#99	0.345	0.152	0.14	20.94	21.50	0.392	Battery 2#	/
Back Side	10mm	40140/2545	20M QPSK 1RB#99	0.359	0.160	0.14	20.77	21.50	0.425	Battery 2#	Yes
Back Side	10mm	40807/2611.7	20M QPSK 1RB#99	0.277	0.121	0.12	20.47	21.50	0.351	Battery 2#	/
Back Side	10mm	41140/2645	20M QPSK 1RB#99	0.223	0.094	0.10	20.65	21.50	0.271	Battery 2#	/
Back Side	10mm	40140/2545(PCC)	20M QPSK 1RB#99	0.343	0.152	0.19	20.71	21.50	0.411	Battery 2#	/
		40338/2564.8(SCC)	20M QPSK 1RB#0								
Main Antenna											
Front Side	10mm	40140/2545	20M QPSK 1RB#50	0.270	0.138	-0.08	22.40	23.00	0.310	Battery 1#	/
Back Side	10mm	40140/2545	20M QPSK 1RB#50	0.369	0.191	0.13	22.40	23.00	0.424	Battery 1#	/
Left Side	10mm	40140/2545	20M QPSK 1RB#50	0.051	0.030	0.15	22.40	23.00	0.059	Battery 1#	/
Right Side	10mm	40140/2545	20M QPSK 1RB#50	0.062	0.034	0.17	22.40	23.00	0.071	Battery 1#	/
Bottom Side	10mm	40140/2545	20M QPSK 1RB#50	0.712	0.355	0.15	22.40	23.00	0.817	Battery 1#	/
Bottom Side	10mm	40473/2578.3	20M QPSK 1RB#99	0.662	0.319	0.16	22.35	23.00	0.769	Battery 1#	/
Bottom Side	10mm	40807/2611.7	20M QPSK 1RB#50	0.755	0.370	0.10	22.33	23.00	0.881	Battery 1#	Yes
Bottom Side	10mm	41140/2645	20M QPSK 1RB#99	0.713	0.337	0.12	22.32	23.00	0.834	Battery 1#	/
Front Side	10mm	41140/2645	20M QPSK 50%RB#25	0.264	0.133	0.18	22.46	23.00	0.299	Battery 1#	/
Back Side	10mm	41140/2645	20M QPSK 50%RB#25	0.249	0.172	0.07	22.46	23.00	0.282	Battery 1#	/
Left Side	10mm	41140/2645	20M QPSK 50%RB#25	0.042	0.025	0.10	22.46	23.00	0.048	Battery 1#	/
Right Side	10mm	41140/2645	20M QPSK 50%RB#25	0.045	0.025	0.12	22.46	23.00	0.051	Battery 1#	/
Bottom Side	10mm	41140/2645	20M QPSK 50%RB#25	0.500	0.238	0.02	22.46	23.00	0.566	Battery 1#	/
Bottom Side	10mm	41140/2645	20M QPSK 100%RB#0	0.674	0.328	0.13	22.37	23.00	0.779	Battery 1#	/
Bottom Side	10mm	40807/2611.7	20M QPSK 1RB#50	0.667	0.321	0.19	22.33	23.00	0.778	Battery 2#	/
Bottom Side	10mm	40140/2545(PCC)	20M QPSK 1RB#99	0.573	0.289	0.15	22.20	23.00	0.689	Battery 1#	/
		40338/2564.8(SCC)	20M QPSK 1RB#0								

Table 215: Hotspot SAR test results of LTE Band 41

Per KDB648474D04, when hotspot mode applies, Product Specific 10-g SAR is required only for the surfaces and edges with hotspot mode 1-g reported SAR > 1.2 W/kg; however, when power reduction applies to hotspot mode the measured SAR must be scaled to the maximum output power, including tolerance, allowed for phablet modes to compare with the 1.2 W/kg SAR test reduction threshold:

Test Position of Hotspot	Dist.	Test Channel /Freq.(MHz)	Test Mode	Measured SAR(W/kg)		Power Drift (dB)	Conducted Power (dBm)	Max Power Without Reduction	Scaled-up 1-g SAR (W/kg)	Product Specific 10-g SAR Exclusion
				1-g	10-g					
Second Antenna										
Front Side	10mm	40473/2578.3	20M QPSK 1RB#99	0.091	0.048	0.06	20.94	23.50	0.164	Yes
Back Side	10mm	40473/2578.3	20M QPSK 1RB#99	0.345	0.150	0.02	20.94	23.50	0.622	Yes
Left Side	10mm	40473/2578.3	20M QPSK 1RB#99	0.032	0.016	-0.11	20.94	23.50	0.058	Yes
Top Side	10mm	40473/2578.3	20M QPSK 1RB#99	0.260	0.132	0.11	20.94	23.50	0.469	Yes
Front Side	10mm	40473/2578.3	20M QPSK 50%RB#25	0.098	0.051	-0.19	21.03	22.50	0.137	Yes
Back Side	10mm	40473/2578.3	20M QPSK 50%RB#25	0.282	0.126	0.17	21.03	22.50	0.396	Yes
Left Side	10mm	40473/2578.3	20M QPSK 50%RB#25	0.034	0.016	0.12	21.03	22.50	0.047	Yes
Top Side	10mm	40473/2578.3	20M QPSK 50%RB#25	0.244	0.127	-0.10	21.03	22.50	0.342	Yes
Back Side	10mm	40473/2578.3	20M QPSK 1RB#99	0.345	0.152	0.14	20.94	23.50	0.622	Yes
Back Side	10mm	40140/2545	20M QPSK 1RB#99	0.359	0.160	0.14	20.77	23.50	0.673	Yes
Back Side	10mm	40807/2611.7	20M QPSK 1RB#99	0.277	0.121	0.12	20.47	23.50	0.557	Yes
Back Side	10mm	41140/2645	20M QPSK 1RB#99	0.223	0.094	0.10	20.65	23.50	0.430	Yes
Back Side	10mm	40140/2545(PCC)	20M QPSK 1RB#99	0.343	0.152	0.19	20.71	23.50	0.652	Yes
		40338/2564.8(SCC)	20M QPSK 1RB#0							
Main Antenna										
Front Side	10mm	40140/2545	20M QPSK 1RB#50	0.270	0.138	-0.08	22.40	25.00	0.491	Yes
Back Side	10mm	40140/2545	20M QPSK 1RB#50	0.369	0.191	0.13	22.40	25.00	0.671	Yes
Left Side	10mm	40140/2545	20M QPSK 1RB#50	0.051	0.030	0.15	22.40	25.00	0.093	Yes
Right Side	10mm	40140/2545	20M QPSK 1RB#50	0.062	0.034	0.17	22.40	25.00	0.113	Yes
Bottom Side	10mm	40140/2545	20M QPSK 1RB#50	0.712	0.355	0.15	22.40	25.00	1.296	No
Bottom Side	10mm	40473/2578.3	20M QPSK 1RB#99	0.662	0.319	0.16	22.35	25.00	1.219	No
Bottom Side	10mm	40807/2611.7	20M QPSK 1RB#50	0.755	0.370	0.10	22.33	25.00	1.396	No
Bottom Side	10mm	41140/2645	20M QPSK 1RB#99	0.713	0.337	0.12	22.32	25.00	1.322	No
Front Side	10mm	41140/2645	20M QPSK 50%RB#25	0.264	0.133	0.18	22.46	24.00	0.376	Yes
Back Side	10mm	41140/2645	20M QPSK 50%RB#25	0.249	0.172	0.07	22.46	24.00	0.355	Yes
Left Side	10mm	41140/2645	20M QPSK 50%RB#25	0.042	0.025	0.10	22.46	24.00	0.060	Yes
Right Side	10mm	41140/2645	20M QPSK 50%RB#25	0.045	0.025	0.12	22.46	24.00	0.064	Yes
Bottom Side	10mm	41140/2645	20M QPSK 50%RB#25	0.500	0.238	0.02	22.46	24.00	0.713	Yes
Bottom Side	10mm	41140/2645	20M QPSK 100%RB#0	0.674	0.328	0.13	22.37	24.00	0.981	Yes
Bottom Side	10mm	40807/2611.7	20M QPSK 1RB#50	0.667	0.321	0.19	22.33	25.00	1.233	No
Bottom Side	10mm	40140/2545(PCC)	20M QPSK 1RB#99	0.573	0.289	0.15	22.20	25.00	1.092	Yes
		40338/2564.8(SCC)	20M QPSK 1RB#0							

Table 216: Product Specific 10-g SAR test reduction evaluation of LTE Band 41

Note: According to the table above , only Bottom side is required for Product Specific 10-g SAR test in this frequency band.



Product Specific 10-g SAR	Dist.	Test Channel /Freq.(MHz)	Test Mode	Measured SAR(W/kg)		Power Drift (dB)	Conducted Power (dBm)	Tune- up Power (dBm)	Reported 10-g SAR (W/kg)	Accessory Information	SAR Plot.
				1-g	10-g						
Main Antenna											
Bottom Side	0mm	41140/2645	20M QPSK 1RB#0	6.770	2.140	0.15	24.31	25.00	2.508	Battery 1#	/
Bottom Side	0mm	40140/2545	20M QPSK 1RB#50	5.610	1.930	0.10	24.27	25.00	2.283	Battery 1#	/
Bottom Side	0mm	40473/2578.3	20M QPSK 1RB#50	7.130	2.270	0.10	24.05	25.00	2.825	Battery 1#	/
Bottom Side	0mm	40807/2611.7	20M QPSK 1RB#50	7.710	2.440	0.12	24.16	25.00	2.961	Battery 1#	Yes
Bottom Side Repeat	0mm	40807/2611.7	20M QPSK 1RB#50	6.530	2.070	-0.19	24.16	25.00	2.512	Battery 1#	/
Bottom Side	0mm	41140/2645	20M QPSK 50%RB#50	4.240	1.410	0.17	23.39	24.00	1.623	Battery 1#	/
Bottom Side	0mm	41140/2645	20M QPSK 100%RB#0	4.770	1.480	0.11	23.32	24.00	1.731	Battery 1#	/
Bottom Side	0mm	40807/2611.7	20M QPSK 1RB#50	6.300	1.990	0.11	24.16	25.00	2.415	Battery 2#	/
Bottom Side	0mm	40140/2545(PCC)	20M QPSK 1RB#99	5.780	1.850	0.10	24.15	25.00	2.250	Battery 1#	/
		40338/2564.8(SCC)	20M QPSK 1RB#0								

Table 217: Product Specific 10-g SAR test results of LTE Band 41

7.2.14 SAR measurement Results of LTE Band 66

Test Position of Head	Test Channel /Freq.(MHz)	Test Mode	Measured SAR(W/kg)		Power Drift (dB)	Conducted Power (dBm)	Tune-up Power (dBm)	Reported 1-g SAR (W/kg)	Accessory Information	SAR Plot.
			1-g	10-g						
Second Antenna										
Left cheek	132322/1745	20M QPSK 1RB#50	0.257	0.122	0.10	16.97	18.00	0.326	Battery 1#	/
Left tilt	132322/1745	20M QPSK 1RB#50	0.339	0.153	0.08	16.97	18.00	0.430	Battery 1#	/
Right cheek	132322/1745	20M QPSK 1RB#50	0.323	0.125	0.01	16.97	18.00	0.409	Battery 1#	/
Right tilt	132322/1745	20M QPSK 1RB#50	0.409	0.192	0.14	16.97	18.00	0.518	Battery 1#	/
Left cheek	132572/1770	20M QPSK 50%RB#25	0.253	0.119	0.15	16.79	18.00	0.334	Battery 1#	/
Left tilt	132572/1770	20M QPSK 50%RB#25	0.306	0.140	0.07	16.79	18.00	0.404	Battery 1#	/
Right cheek	132572/1770	20M QPSK 50%RB#25	0.261	0.124	0.01	16.79	18.00	0.345	Battery 1#	/
Right tilt	132572/1770	20M QPSK 50%RB#25	0.395	0.185	0.04	16.79	18.00	0.522	Battery 1#	/
Right tilt	132572/1770	20M QPSK 50%RB#25	0.402	0.190	0.04	16.79	18.00	0.531	Battery 2#	/
Right tilt	132072/1720	20M QPSK 50%RB#50	0.422	0.199	0.00	16.71	18.00	0.568	Battery 1#	Yes
Right tilt	132322/1745	20M QPSK 50%RB#0	0.383	0.181	0.03	16.78	18.00	0.507	Battery 1#	/
Main Antenna										
Left cheek	132572/1770	20M QPSK 1RB#99	0.175	0.115	-0.10	22.98	24.00	0.221	Battery 1#	/
Left tilt	132572/1770	20M QPSK 1RB#99	0.071	0.040	0.05	22.98	24.00	0.089	Battery 1#	/
Right cheek	132572/1770	20M QPSK 1RB#99	0.181	0.120	0.17	22.98	24.00	0.229	Battery 1#	/
Right tilt	132572/1770	20M QPSK 1RB#99	0.082	0.048	-0.08	22.98	24.00	0.103	Battery 1#	/
Left cheek	132072/1720	20M QPSK 50%RB#0	0.137	0.083	0.09	21.96	23.00	0.174	Battery 1#	/
Left tilt	132072/1720	20M QPSK 50%RB#0	0.053	0.029	0.12	21.96	23.00	0.067	Battery 1#	/
Right cheek	132072/1720	20M QPSK 50%RB#0	0.138	0.084	0.00	21.96	23.00	0.175	Battery 1#	/
Right tilt	132072/1720	20M QPSK 50%RB#0	0.064	0.038	-0.01	21.96	23.00	0.081	Battery 1#	/
Right cheek	132572/1770	20M QPSK 1RB#99	0.171	0.102	0.02	22.98	24.00	0.216	Battery 2#	/
Right cheek	132072/1720	20M QPSK 1RB#0	0.193	0.128	0.15	22.96	24.00	0.245	Battery 1#	Yes
Right cheek	132322/1745	20M QPSK 1RB#99	0.166	0.109	-0.01	22.89	24.00	0.214	Battery 1#	/

Table 218: Head SAR test results of LTE Band 66

Test Position of Body-Worn	Dist.	Test Channel /Freq.(MHz)	Test Mode	Measured SAR(W/kg)		Power Drift (dB)	Conducted Power (dBm)	Tune-up Power (dBm)	Reported 1-g SAR (W/kg)	Accessory Information	SAR Plot.
				1-g	10-g						
Second Antenna											
Front Side	15mm	132072/1720	20M QPSK 1RB#99	0.141	0.082	0.10	21.93	23.00	0.180	Battery 1#	Yes
Back Side	15mm	132072/1720	20M QPSK 1RB#99	0.111	0.064	-0.10	21.93	23.00	0.142	Battery 1#	/
Front Side	15mm	132072/1720	20M QPSK 50%RB#0	0.096	0.053	0.09	20.83	22.00	0.125	Battery 1#	/
Back Side	15mm	132072/1720	20M QPSK 50%RB#0	0.080	0.044	0.10	20.83	22.00	0.105	Battery 1#	/
Front Side	15mm	132072/1720	20M QPSK 1RB#99	0.128	0.074	0.14	21.93	23.00	0.164	Battery 2#	/
Front Side	15mm	132322/1745	20M QPSK 1RB#99	0.132	0.077	0.06	21.81	23.00	0.174	Battery 1#	/
Front Side	15mm	132572/1770	20M QPSK 1RB#99	0.106	0.058	0.01	21.92	23.00	0.136	Battery 1#	/
Main Antenna											
Front Side	15mm	132572/1770	20M QPSK 1RB#99	0.318	0.202	0.06	22.98	24.00	0.402	Battery 1#	/
Back Side	15mm	132572/1770	20M QPSK 1RB#99	0.345	0.216	-0.03	22.98	24.00	0.436	Battery 1#	Yes
Front Side	15mm	132072/1720	20M QPSK 50%RB#0	0.267	0.176	-0.02	21.96	23.00	0.339	Battery 1#	/
Back Side	15mm	132072/1720	20M QPSK 50%RB#0	0.260	0.178	0.00	21.96	23.00	0.330	Battery 1#	/
Back Side	15mm	132572/1770	20M QPSK 1RB#99	0.315	0.197	-0.08	22.98	24.00	0.398	Battery 2#	/
Back Side	15mm	132072/1720	20M QPSK 1RB#0	0.288	0.196	0.02	22.96	24.00	0.366	Battery 1#	/
Back Side	15mm	132322/1745	20M QPSK 1RB#99	0.285	0.180	0.04	22.89	24.00	0.368	Battery 1#	/

Table 219: Body Worn SAR test results of LTE Band 66

Test Position of Hotspot	Dist.	Test Channel /Freq.(MHz)	Test Mode	Measured SAR(W/kg)		Power Drift (dB)	Conducted Power (dBm)	Tune-up Power (dBm)	Reported 1-g SAR (W/kg)	Accessory Information	SAR Plot.
				1-g	10-g						
Second Antenna											
Front Side	10mm	132072/1720	20M QPSK 1RB#0	0.122	0.063	0.14	18.89	20.00	0.158	Battery 1#	/
Back Side	10mm	132072/1720	20M QPSK 1RB#0	0.121	0.069	-0.04	18.89	20.00	0.156	Battery 1#	/
Left Side	10mm	132072/1720	20M QPSK 1RB#0	0.030	0.018	0.07	18.89	20.00	0.039	Battery 1#	/
Top Side	10mm	132072/1720	20M QPSK 1RB#0	0.309	0.164	0.16	18.89	20.00	0.399	Battery 1#	/
Front Side	10mm	132572/1770	20M QPSK 50%RB#0	0.113	0.058	0.17	18.75	20.00	0.151	Battery 1#	/
Back Side	10mm	132572/1770	20M QPSK 50%RB#0	0.124	0.068	0.07	18.75	20.00	0.165	Battery 1#	/
Left Side	10mm	132572/1770	20M QPSK 50%RB#0	0.026	0.015	-0.15	18.75	20.00	0.035	Battery 1#	/
Top Side	10mm	132572/1770	20M QPSK 50%RB#0	0.342	0.173	0.04	18.75	20.00	0.456	Battery 1#	Yes
Top Side	10mm	132572/1770	20M QPSK 50%RB#0	0.314	0.166	0.14	18.75	20.00	0.419	Battery 2#	/
Top Side	10mm	132072/1720	20M QPSK 50%RB#0	0.272	0.137	0.19	18.70	20.00	0.367	Battery 1#	/
Top Side	10mm	132322/1745	20M QPSK 50%RB#0	0.299	0.149	0.17	18.63	20.00	0.410	Battery 1#	/
Main Antenna											
Front Side	10mm	132072/1720	20M QPSK 1RB#0	0.286	0.172	-0.13	20.44	21.50	0.365	Battery 1#	/
Back Side	10mm	132072/1720	20M QPSK 1RB#0	0.308	0.191	-0.15	20.44	21.50	0.393	Battery 1#	/
Left Side	10mm	132072/1720	20M QPSK 1RB#0	0.122	0.072	0.11	20.44	21.50	0.156	Battery 1#	/
Right Side	10mm	132072/1720	20M QPSK 1RB#0	0.156	0.087	-0.14	20.44	21.50	0.199	Battery 1#	/
Bottom Side	10mm	132072/1720	20M QPSK 1RB#0	0.563	0.328	-0.17	20.44	21.50	0.719	Battery 1#	/
Front Side	10mm	132072/1720	20M QPSK 50%RB#0	0.271	0.164	-0.19	20.34	21.50	0.354	Battery 1#	/
Back Side	10mm	132072/1720	20M QPSK 50%RB#0	0.347	0.206	-0.17	20.34	21.50	0.453	Battery 1#	/
Left Side	10mm	132072/1720	20M QPSK 50%RB#0	0.111	0.066	0.02	20.34	21.50	0.145	Battery 1#	/
Right Side	10mm	132072/1720	20M QPSK 50%RB#0	0.151	0.084	0.02	20.34	21.50	0.197	Battery 1#	/
Bottom Side	10mm	132072/1720	20M QPSK 50%RB#0	0.599	0.347	0.19	20.34	21.50	0.782	Battery 1#	Yes
Bottom Side	10mm	132072/1720	20M QPSK 50%RB#0	0.548	0.319	0.18	20.34	21.50	0.716	Battery 2#	/
Bottom Side	10mm	132322/1745	20M QPSK 50%RB#0	0.570	0.331	0.13	20.20	21.50	0.769	Battery 1#	/
Bottom Side	10mm	132572/1770	20M QPSK 50%RB#0	0.573	0.332	0.03	20.22	21.50	0.769	Battery 1#	/

Table 220: Hotspot SAR test results of LTE Band 66

Per KDB648474D04, when hotspot mode applies, Product Specific 10-g SAR is required only for the surfaces and edges with hotspot mode 1-g reported SAR > 1.2 W/kg; however, when power reduction applies to hotspot mode the measured SAR must be scaled to the maximum output power, including tolerance, allowed for phablet modes to compare with the 1.2 W/kg SAR test reduction threshold:

Test Position of Hotspot	Dist.	Test Channel /Freq.(MHz)	Test Mode	Measured SAR(W/kg)		Power Drift (dB)	Conducted Power (dBm)	Max Power Without Reduction	Scaled-up 1-g SAR (W/kg)	Product Specific 10-g SAR Exclusion
				1-g	10-g					
Second Antenna										
Front Side	10mm	132072/1720	20M QPSK 1RB#0	0.122	0.063	0.14	18.89	23.00	0.314	Yes
Back Side	10mm	132072/1720	20M QPSK 1RB#0	0.121	0.069	-0.04	18.89	23.00	0.312	Yes
Left Side	10mm	132072/1720	20M QPSK 1RB#0	0.030	0.018	0.07	18.89	23.00	0.078	Yes
Top Side	10mm	132072/1720	20M QPSK 1RB#0	0.309	0.164	0.16	18.89	23.00	0.796	Yes
Front Side	10mm	132572/1770	20M QPSK 50%RB#0	0.113	0.058	0.17	18.75	22.00	0.239	Yes
Back Side	10mm	132572/1770	20M QPSK 50%RB#0	0.124	0.068	0.07	18.75	22.00	0.262	Yes
Left Side	10mm	132572/1770	20M QPSK 50%RB#0	0.026	0.015	-0.15	18.75	22.00	0.055	Yes
Top Side	10mm	132572/1770	20M QPSK 50%RB#0	0.342	0.173	0.04	18.75	22.00	0.723	Yes
Top Side	10mm	132572/1770	20M QPSK 50%RB#0	0.314	0.166	0.14	18.75	22.00	0.664	Yes
Top Side	10mm	132072/1720	20M QPSK 50%RB#0	0.272	0.137	0.19	18.70	22.00	0.582	Yes
Top Side	10mm	132322/1745	20M QPSK 50%RB#0	0.299	0.149	0.17	18.63	22.00	0.650	Yes
Main Antenna										
Front Side	10mm	132072/1720	20M QPSK 1RB#0	0.286	0.172	-0.13	20.44	24.00	0.649	Yes
Back Side	10mm	132072/1720	20M QPSK 1RB#0	0.308	0.191	-0.15	20.44	24.00	0.699	Yes
Left Side	10mm	132072/1720	20M QPSK 1RB#0	0.122	0.072	0.11	20.44	24.00	0.277	Yes
Right Side	10mm	132072/1720	20M QPSK 1RB#0	0.156	0.087	-0.14	20.44	24.00	0.354	Yes
Bottom Side	10mm	132072/1720	20M QPSK 1RB#0	0.563	0.328	-0.17	20.44	24.00	1.278	No
Front Side	10mm	132072/1720	20M QPSK 50%RB#0	0.271	0.164	-0.19	20.34	23.00	0.500	Yes
Back Side	10mm	132072/1720	20M QPSK 50%RB#0	0.347	0.206	-0.17	20.34	23.00	0.640	Yes
Left Side	10mm	132072/1720	20M QPSK 50%RB#0	0.111	0.066	0.02	20.34	23.00	0.205	Yes
Right Side	10mm	132072/1720	20M QPSK 50%RB#0	0.151	0.084	0.02	20.34	23.00	0.279	Yes
Bottom Side	10mm	132072/1720	20M QPSK 50%RB#0	0.599	0.347	0.19	20.34	23.00	1.105	Yes
Bottom Side	10mm	132072/1720	20M QPSK 50%RB#0	0.548	0.319	0.18	20.34	23.00	1.011	Yes
Bottom Side	10mm	132322/1745	20M QPSK 50%RB#0	0.570	0.331	0.13	20.20	23.00	1.086	Yes
Bottom Side	10mm	132572/1770	20M QPSK 50%RB#0	0.573	0.332	0.03	20.22	23.00	1.087	Yes

Table 221: Product Specific 10-g SAR test reduction evaluation of LTE Band 66

Note: According to the table above , only Bottom side is required for Product Specific 10-g SAR test in this frequency band.



Product Specific 10-g SAR	Dist.	Test Channel /Freq.(MHz)	Test Mode	Measured SAR(W/kg)		Power Drift (dB)	Conducted Power (dBm)	Tune-up Power (dBm)	Reported 10-g SAR (W/kg)	Accessory Information	SAR Plot.
				1-g	10-g						
Main Antenna											
Bottom Side	0mm	132322/1745	20M QPSK 1RB#99	4.320	1.880	0.15	22.04	23.00	2.345	Battery 1#	/
Bottom Side	0mm	132072/1720	20M QPSK 1RB#99	4.170	1.780	0.17	21.97	23.00	2.256	Battery 1#	/
Bottom Side	0mm	132572/1770	20M QPSK 1RB#99	3.940	1.680	-0.15	21.95	23.00	2.139	Battery 1#	/
Bottom Side	0mm	132072/1720	20M QPSK 50%RB#0	4.360	1.880	0.16	22.01	23.00	2.361	Battery 1#	/
Bottom Side	0mm	132322/1745	20M QPSK 50%RB#0	4.530	1.910	0.03	21.86	23.00	2.483	Battery 1#	Yes
Bottom Side	0mm	132572/1770	20M QPSK 50%RB#25	3.990	1.680	0.18	21.95	23.00	2.139	Battery 1#	/
Bottom Side	0mm	132072/1720	20M QPSK 50%RB#0	4.030	1.750	-0.08	22.01	23.00	2.198	Battery 2#	/
Bottom Side	0mm	132322/1745	20M QPSK 100%RB#0	3.910	1.670	-0.11	21.88	23.00	2.161	Battery 1#	/
Additional SAR test at a conservative distance(triggering distance minus 1mm)											
Bottom Side	7mm	132572/1770	20M QPSK 1RB#99	1.330	0.735	0.11	22.98	24.00	0.930	Battery 1#	/
Bottom Side	7mm	132072/1720	20M QPSK 50%RB#0	1.040	0.576	0.17	21.96	23.00	0.732	Battery 1#	/

Table 222: Product Specific 10-g SAR test results of LTE Band 66

7.2.15 SAR measurement Results of WiFi 2.4G

Test Position of Head	Test Channel /Freq.(MHz)	Test Mode	Area Scan 1-g SAR (W/kg)	Measured SAR(W/kg)		Power Drift (dB)	Actual duty cycle	Scaled 1-g SAR (W/kg)	Conducted Power (dBm)	Tune-up Power (dBm)	Reported 1-g SAR (W/kg)	Accessory Information	SAR Plot.
				1-g	10-g								
Ant3(Core0)													
Left cheek	6/2437	802.11b	0.326	0.372	0.157	0.00	99%	0.376	13.46	14.50	0.477	Battery 1#	/
Left tilt	6/2437	802.11b	0.506	0.582	0.227	0.03	99%	0.588	13.46	14.50	0.747	Battery 1#	Yes
Right cheek	6/2437	802.11b	0.147	0.143	0.074	-0.11	99%	0.144	13.46	14.50	0.184	Battery 1#	/
Right tilt	6/2437	802.11b	0.186	0.208	0.102	0.15	99%	0.210	13.46	14.50	0.267	Battery 1#	/
Left tilt	6/2437	802.11b	0.598	0.570	0.226	0.05	99%	0.576	13.46	14.50	0.732	Battery 2#	/
Left tilt	1/2412	802.11b	0.356	0.341	0.140	0.02	99%	0.344	13.33	14.50	0.451	Battery 1#	/
Left tilt	11/2462	802.11b	0.394	0.407	0.158	-0.11	99%	0.411	13.19	14.50	0.556	Battery 1#	/
Ant4(Core1)													
Left cheek	6/2437	802.11b	0.006	0.001	0.000	-0.13	99%	0.001	12.83	14.50	0.001	Battery 1#	/
Left tilt	6/2437	802.11b	0.010	0.002	0.001	0.13	99%	0.002	12.83	14.50	0.003	Battery 1#	/
Right cheek	6/2437	802.11b	0.016	0.014	0.006	0.15	99%	0.014	12.83	14.50	0.021	Battery 1#	/
Right tilt	6/2437	802.11b	0.010	0.004	0.001	-0.12	99%	0.004	12.83	14.50	0.005	Battery 1#	/
Right cheek	6/2437	802.11b	0.014	0.009	0.003	0.17	99%	0.010	12.83	14.50	0.014	Battery 2#	/
Right cheek	1/2412	802.11b	0.022	0.017	0.007	-0.04	99%	0.017	12.68	14.50	0.027	Battery 1#	Yes
Right cheek	11/2462	802.11b	0.016	0.007	0.003	-0.13	99%	0.008	12.51	14.50	0.012	Battery 1#	/
Test at the best acoustic position													
Right cheek	1/2412	802.11b	0.020	0.016	0.007	0.14	99%	0.017	12.68	14.50	0.025	Battery 1#	/

Table 223: Head SAR test results of WiFi 2.4G SISO

Note: Per KDB248227D01, for Head SAR test of WiFi 2.4G SISO, SAR is measured for 2.4 GHz 802.11b DSSS using the initial test position procedure. The highest reported SAR for DSSS is adjusted by the ratio of OFDM 802.11g/n to DSSS specified maximum output power and the adjusted SAR is < 1.2 W/kg, so SAR for 802.11g/n is not required.

Test Position of Head	Test Channel /Freq.(MHz)	Test Mode	Area Scan 1-g SAR (W/kg)	Measured SAR(W/kg)		Power Drift (dB)	Actual duty cycle	Scaled 1-g SAR (W/kg)	Conducted Power (dBm)	Tune-up Power (dBm)	Reported 1-g SAR (W/kg)	Accessory Information	SAR Plot.
				1-g	10-g								
Test data of WiFi 2.4G MIMO with Ant 3(Core 0)													
Left cheek	6/2437	802.11n(40M)	0.327	0.346	0.156	-0.10	96%	0.360	12.67	14.50	0.549	Battery 1#	/
Left tilt	6/2437	802.11n(40M)	0.489	0.496	0.197	0.02	96%	0.517	12.67	14.50	0.787	Battery 1#	/
Right cheek	6/2437	802.11n(40M)	0.104	0.103	0.053	0.00	96%	0.107	12.67	14.50	0.164	Battery 1#	/
Right tilt	6/2437	802.11n(40M)	0.135	0.140	0.068	0.00	96%	0.146	12.67	14.50	0.222	Battery 1#	/
Left tilt	6/2437	802.11n(40M)	0.413	0.442	0.176	0.01	96%	0.460	12.67	14.50	0.702	Battery 2#	/
Left tilt	3/2422	802.11n(40M)	0.055	0.052	0.019	0.18	96%	0.054	5.10	7.00	0.084	Battery 1#	/
Left tilt	5/2432	802.11n(40M)	0.411	0.426	0.168	-0.05	96%	0.444	12.51	14.50	0.702	Battery 1#	/
Left tilt	9/2452	802.11n(40M)	0.056	0.053	0.020	0.18	96%	0.055	5.10	6.50	0.076	Battery 1#	/
Test at the best acoustic position													
Left tilt	6/2437	802.11n(40M)	0.465	0.427	0.177	0.01	96%	0.445	12.67	14.50	0.678	Battery 1#	/
Test data of WiFi 2.4G MIMO with Ant 4(Core 1)													
Left cheek	6/2437	802.11n(40M)	0.008	/	/	-0.13	96%	/	12.76	14.50	/	Battery 1#	/
Left tilt	6/2437	802.11n(40M)	0.009	/	/	0.15	96%	/	12.76	14.50	/	Battery 1#	/
Right cheek	6/2437	802.11n(40M)	0.016	0.012	0.005	-0.14	96%	0.012	12.76	14.50	0.018	Battery 1#	/
Right tilt	6/2437	802.11n(40M)	0.010	0.006	0.002	-0.13	96%	0.007	12.76	14.50	0.010	Battery 1#	/
Right cheek	6/2437	802.11n(40M)	0.016	0.012	0.004	0.16	96%	0.013	12.76	14.50	0.019	Battery 2#	/
Right cheek	3/2422	802.11n(40M)	0.001	0.001	0.000	0.10	96%	0.001	5.01	7.00	0.002	Battery 1#	/
Right cheek	5/2432	802.11n(40M)	0.018	0.012	0.005	0.05	96%	0.013	12.68	14.50	0.019	Battery 1#	/
Right cheek	9/2452	802.11n(40M)	0.001	0.001	0.000	0.10	96%	0.001	4.75	6.50	0.002	Battery 1#	/

Table 224: Head SAR test results of WiFi 2.4G MIMO

Note:

- 1) Per KDB248227D01, for Head SAR test of WiFi 2.4G CDD/MIMO, SAR is measured for 2.4 GHz OFDM 802.11n(40M) using the initial test position procedure. The highest reported SAR for OFDM 802.11n(40M) is adjusted by the ratio of OFDM 802.11g and OFDM 802.11n(20M) to OFDM 802.11n(40M) specified maximum output power and the adjusted SAR is < 1.2 W/kg, so SAR for 802.11g and 802.11n(20M) is not required.
- 2) As different maximum tune-up output power is specified across the different channels range, WIFI 2.4G CDD/MIMO SAR test is performed on 3C/5CH/6CH/9CH according to the max tune-up power to ensure compliance.

Test Position of Head	Dist.	Test Mode	WiFi 2.4G CDD/MIMO 1-g SAR (W/kg)		
			Ant 3(Core 0)	Ant 4(Core 1)	CDD/MIMO (Ant 3(Core 0) + Ant 4(Core 1))
Left cheek	/	802.11n(40M)	0.549	0.019	0.568
Left tilt	/	802.11n(40M)	0.787	0.019	0.806
Right cheek	/	802.11n(40M)	0.164	0.019	0.183
Right tilt	/	802.11n(40M)	0.222	0.010	0.232

Table 225: Head SAR test results of WiFi 2.4G CDD/MIMO calculation

Test Position of Body-Worn	Dist.	Test Channel /Freq.(MHz)	Test Mode	Area Scan 1-g SAR (W/kg)	Measured SAR(W/kg)		Power Drift (dB)	Actual duty cycle	Scaled 1-g SAR (W/kg)	Conducted Power (dBm)	Tune-up Power (dBm)	Reported 1-g SAR (W/kg)	Accessory Information	SAR Plot.
					1-g	10-g								
Ant3(Core0)														
Front Side	15mm	1/2412	802.11b	0.048	0.045	0.024	-0.09	99%	0.045	16.61	18.00	0.062	Battery 1#	/
Back Side	15mm	1/2412	802.11b	0.045	0.041	0.022	0.09	99%	0.041	16.61	18.00	0.056	Battery 1#	/
Front Side	15mm	1/2412	802.11b	0.056	0.054	0.029	-0.19	99%	0.054	16.61	18.00	0.075	Battery 2#	/
Front Side	15mm	6/2437	802.11b	0.083	0.080	0.044	0.07	99%	0.081	16.48	18.00	0.115	Battery 2#	Yes
Front Side	15mm	11/2462	802.11b	0.073	0.069	0.037	-0.18	99%	0.070	16.36	18.00	0.102	Battery 2#	/
Ant4(Core1)														
Front Side	15mm	1/2412	802.11b	0.002	/	/	0.00	99%	/	15.27	17.00	/	Battery 1#	/
Back Side	15mm	1/2412	802.11b	0.047	0.033	0.012	0.15	99%	0.033	15.27	17.00	0.049	Battery 1#	/
Back Side	15mm	1/2412	802.11b	0.044	0.042	0.016	-0.10	99%	0.042	15.27	17.00	0.063	Battery 2#	/
Back Side	15mm	6/2437	802.11b	0.037	0.031	0.011	0.03	99%	0.032	15.04	17.00	0.049	Battery 2#	/
Back Side	15mm	11/2462	802.11b	0.022	0.016	0.005	0.16	99%	0.017	15.01	17.00	0.026	Battery 2#	/

Table 226: Body Worn SAR test results of WiFi 2.4G SISO

Note: Per KDB248227D01, for Body SAR test of WiFi 2.4G SISO, SAR is measured for 2.4 GHz 802.11b DSSS using the initial test position procedure. The highest reported SAR for DSSS is adjusted by the ratio of OFDM 802.11g/n to DSSS specified maximum output power and the adjusted SAR is < 1.2 W/kg, so SAR for 802.11g/n is not required.

Test Position of Body-Worn	Dist.	Test Channel /Freq.(MHz)	Test Mode	Area Scan 1-g SAR (W/kg)	Measured SAR(W/kg)		Power Drift (dB)	Actual duty cycle	Scaled 1-g SAR (W/kg)	Conducted Power (dBm)	Tune-up Power (dBm)	Reported 1-g SAR (W/kg)	Accessory Information	SAR Plot.
					1-g	10-g								
Test data of WiFi 2.4G CDD with Ant 3(Core 0)														
Front Side	15mm	6/2437	802.11g	0.074	0.073	0.040	0.06	99%	0.074	16.34	18.00	0.108	Battery 1#	/
Back Side	15mm	6/2437	802.11g	0.072	0.065	0.036	0.04	99%	0.066	16.34	18.00	0.097	Battery 1#	/
Front Side	15mm	6/2437	802.11g	0.078	0.075	0.041	0.01	99%	0.076	16.34	18.00	0.111	Battery 2#	/
Front Side	15mm	3/2422	802.11g	0.056	0.052	0.029	-0.08	99%	0.052	16.23	18.00	0.079	Battery 2#	/
Front Side	15mm	9/2452	802.11g	0.063	0.059	0.032	0.09	99%	0.060	16.19	18.00	0.091	Battery 2#	/
Test data of WiFi 2.4G CDDwith Ant 4(Core 1)														
Front Side	15mm	6/2437	802.11g	<0.001	<0.001	<0.001	0.00	99%	<0.001	15.19	17.00	<0.001	Battery 1#	/
Back Side	15mm	6/2437	802.11g	0.052	0.046	0.017	0.07	99%	0.046	15.19	17.00	0.070	Battery 1#	/
Back Side	15mm	6/2437	802.11g	0.048	0.045	0.018	-0.06	99%	0.045	15.19	17.00	0.069	Battery 2#	/
Back Side	15mm	3/2422	802.11g	0.052	0.048	0.019	-0.07	99%	0.048	15.15	17.00	0.073	Battery 1#	Yes
Back Side	15mm	9/2452	802.11g	0.054	0.046	0.018	0.00	99%	0.046	15.01	17.00	0.073	Battery 1#	/

Table 227: Body Worn SAR test results of WiFi 2.4G CDD

Note:

- 1) Per KDB248227D01, for Head SAR test of WiFi 2.4G CDD/MIMO, SAR is measured for 2.4 GHz OFDM 802.11g using the initial test position procedure. The highest reported SAR for OFDM 802.11g is adjusted by the ratio of OFDM 802.11n(20M) and OFDM 802.11n(40M) to OFDM 802.11g specified maximum output power and the adjusted SAR is < 1.2 W/kg, so SAR for 802.11 n(20M) and 802.11n(40M) is not required.
- 2) As different maximum tune-up output power is specified across the different channels range, WIFI 2.4G CDD 11g SAR test is performed on 3CH/6CH/9CH according to the max tune-up power to ensure compliance.

Test Position of Body-Worn	Dist.	Test Mode	WiFi 2.4G CDD/MIMO 1-g SAR(W/kg)		
			Ant 3(Core 0)	Ant 4(Core 1)	CDD/MIMO (Ant 3(Core 0)+ Ant 4(Core 1))
Front Side	15mm	802.11g	0.111	0.073	0.184
Back Side	15mm	802.11g	0.097	0.073	0.170

Table 228: Body Worn SAR test results of WiFi 2.4G CDD/MIMO calculation

Test Position of Hotspot	Dist.	Test Channel /Freq.(MHz)	Test Mode	Area Scan 1-g SAR (W/kg)	Measured SAR(W/kg)		Power Drift (dB)	Actual duty cycle	Scaled 1-g SAR (W/kg)	Conducted Power (dBm)	Tune-up Power (dBm)	Reported 1-g SAR (W/kg)	Accessory Information	SAR Plot.
					1-g	10-g								
Ant3(Core0)														
Front Side	10mm	1/2412	802.11b	0.095	0.095	0.052	-0.11	99%	0.096	16.61	18.00	0.132	Battery 1#	/
Back Side	10mm	1/2412	802.11b	0.083	0.077	0.042	-0.09	99%	0.077	16.61	18.00	0.107	Battery 1#	/
Right Side	10mm	1/2412	802.11b	0.067	0.067	0.028	-0.12	99%	0.068	16.61	18.00	0.094	Battery 1#	/
Top Side	10mm	1/2412	802.11b	0.177	0.166	0.083	-0.06	99%	0.168	16.61	18.00	0.231	Battery 1#	/
Top Side	10mm	1/2412	802.11b	0.208	0.196	0.097	0.06	99%	0.198	16.61	18.00	0.273	Battery 2#	/
Top Side	10mm	6/2437	802.11b	0.273	0.258	0.131	-0.17	99%	0.261	16.48	18.00	0.370	Battery 2#	Yes
Top Side	10mm	11/2462	802.11b	0.196	0.188	0.096	-0.02	99%	0.190	16.36	18.00	0.277	Battery 2#	/
Ant4(Core1)														
Front Side	10mm	1/2412	802.11b	0.007	/	/	0.00	99%	/	15.27	17.00	/	Battery 1#	/
Back Side	10mm	1/2412	802.11b	0.122	0.106	0.042	0.07	99%	0.107	15.27	17.00	0.159	Battery 1#	/
Left Side	10mm	1/2412	802.11b	0.087	0.080	0.032	0.11	99%	0.081	15.27	17.00	0.120	Battery 1#	/
Top Side	10mm	1/2412	802.11b	0.008	/	/	0.11	99%	/	15.27	17.00	/	Battery 1#	/
Back Side	10mm	1/2412	802.11b	0.107	0.112	0.044	-0.06	99%	0.113	15.27	17.00	0.168	Battery 2#	Yes
Back Side	10mm	6/2437	802.11b	0.090	0.099	0.038	-0.07	99%	0.100	15.04	17.00	0.157	Battery 2#	/
Back Side	10mm	11/2462	802.11b	0.062	0.060	0.020	-0.07	99%	0.061	15.01	17.00	0.096	Battery 2#	/

Table 229: Hotspot SAR test results of WiFi 2.4G SISO

Note:

- 1) Per KDB248227D01, for Hotspot SAR test of WiFi 2.4G SISO, SAR is measured for 2.4 GHz 802.11b DSSS using the initial test position procedure. The highest reported SAR for DSSS is adjusted by the ratio of OFDM 802.11g/n to DSSS specified maximum output power and the adjusted SAR is < 1.2 W/kg, so SAR for 802.11g/n is not required.
- 2) Per KDB 648474 D04, Product Specific 10-g SAR test is not required for WiFi 2.4G SISO since hotspot mode 1-g reported SAR < 1.2 W/kg.
- 3) WiFi 2.4G CDD/MIMO does not support hotspot function.

Product Specific 10-g SAR	Dist.	Test Channel /Freq.(MHz)	Test Mode	Area Scan 10-g SAR (W/kg)	Measured SAR(W/kg)		Power Drift (dB)	Actual duty cycle	Scaled 10-g SAR (W/kg)	Conducted Power (dBm)	Tune-up Power (dBm)	Reported 10-g SAR (W/kg)	Accessory Information	SAR Plot.
					1-g	10-g								
Test data of WiFi 2.4G CDD with Ant 3(Core 0)														
Front Side	0mm	6/2437	802.11g	1.040	1.830	0.761	0.00	99%	0.769	16.34	18.00	1.127	Battery 1#	/
Back Side	0mm	6/2437	802.11g	0.563	0.990	0.453	0.00	99%	0.458	16.34	18.00	0.671	Battery 1#	/
Left Side	0mm	6/2437	802.11g	0.062	0.144	0.062	0.00	99%	0.062	16.34	18.00	0.091	Battery 1#	/
Right Side	0mm	6/2437	802.11g	0.324	0.970	0.324	0.01	99%	0.327	16.34	18.00	0.480	Battery 1#	/
Top Side	0mm	6/2437	802.11g	0.829	2.560	0.866	0.02	99%	0.875	16.34	18.00	1.282	Battery 1#	Yes
Top Side	0mm	6/2437	802.11g	0.707	2.110	0.725	-0.16	99%	0.732	16.34	18.00	1.073	Battery 2#	/
Top Side	0mm	3/2422	802.11g	0.754	1.870	0.631	-0.16	99%	0.637	16.23	18.00	0.958	Battery 1#	/
Top Side	0mm	9/2452	802.11g	0.615	1.820	0.618	0.04	99%	0.624	16.19	18.00	0.947	Battery 1#	/
Test data of WiFi 2.4G CDDwith Ant 4(Core 1)														
Front Side	0mm	6/2437	802.11g	0.031	0.064	0.031	0.00	99%	0.031	15.19	17.00	0.047	Battery 1#	/
Back Side	0mm	6/2437	802.11g	0.456	1.430	0.481	-0.14	99%	0.486	15.19	17.00	0.737	Battery 1#	/
Left Side	0mm	6/2437	802.11g	0.449	1.160	0.364	-0.08	99%	0.368	15.19	17.00	0.558	Battery 1#	/
Right Side	0mm	6/2437	802.11g	<0.001	<0.001	<0.001	0.00	99%	<0.001	15.19	17.00	<0.001	Battery 1#	/
Top Side	0mm	6/2437	802.11g	0.040	0.065	0.023	0.08	99%	0.023	15.19	17.00	0.035	Battery 1#	/
Back Side	0mm	6/2437	802.11g	0.277	0.950	0.308	0.00	99%	0.311	15.19	17.00	0.472	Battery 2#	/
Back Side	0mm	3/2422	802.11g	0.419	1.460	0.491	-0.01	99%	0.496	15.15	17.00	0.759	Battery 1#	/
Back Side	0mm	9/2452	802.11g	0.421	1.490	0.496	0.10	99%	0.501	15.01	17.00	0.792	Battery 1#	Yes

Table 230: Product Specific 10-g SAR of WiFi 2.4G CDD

Note:

- 1) Per KDB248227D01, for Product Specific 10-g SAR test of WiFi 2.4G CDD, SAR is measured for 2.4 GHz OFDM 802.11g using the initial test position procedure. The highest reported SAR for OFDM 802.11g is adjusted by the ratio of OFDM 802.11n(20M) and OFDM 802.11n(40M) to OFDM 802.11g specified maximum output power and the adjusted SAR is < 1.2 W/kg, so SAR for 802.11 n(20M) and 802.11n(40M) is not required.
- 2) As different maximum tune-up output power is specified across the different channels range, WIFI 2.4G CDD 11g SAR test is performed on 3CH/6CH/9CH according to the max tune-up power to ensure compliance.

Product Specific 10-g SAR	Dist.	Test Mode	WiFi 2.4G CDD/MIMO 10-g SAR (W/kg)		
			Ant 3(Core 0)	Ant 4(Core 1)	CDD/MIMO(Ant 3(Core 0) + Ant 4(Core 1))
Front Side	0mm	802.11g	1.127	0.047	1.174
Back Side	0mm	802.11g	0.671	0.792	1.463
Left Side	0mm	802.11g	0.091	0.558	0.649
Right Side	0mm	802.11g	0.480	0.792	1.272
Top Side	0mm	802.11g	1.282	0.035	1.317

Table 231: Product Specific 10-g SAR of WiFi 2.4G CDD/MIMO calculation

7.2.16 SAR measurement Results of WiFi 5G

Test Position of Head	Test Channel /Freq. (MHz)	Test Mode	Area Scan 1-g SAR (W/kg)	Measured SAR(W/kg)		Power Drift (dB)	Actual duty cycle	Scaled 1-g SAR (W/kg)	Conducted Power (dBm)	Tune-up Power (dBm)	Reported 1-g SAR (W/kg)	Accessory Information	SAR Plot.
				1-g	10-g								
Ant3(Core0)													
Test data of U-NII-2A band													
Left cheek	54/5270	802.11n(40M)	0.085	0.111	0.031	0.04	96%	0.116	9.62	11.00	0.159	Battery 1#	/
Left tilt	54/5270	802.11n(40M)	0.112	0.129	0.038	0.03	96%	0.134	9.62	11.00	0.185	Battery 1#	/
Right cheek	54/5270	802.11n(40M)	0.029	0.051	0.014	0.12	96%	0.053	9.62	11.00	0.073	Battery 1#	/
Right tilt	54/5270	802.11n(40M)	0.071	0.074	0.022	0.16	96%	0.077	9.62	11.00	0.105	Battery 1#	/
Left tilt	54/5270	802.11n(40M)	0.174	0.195	0.056	-0.19	96%	0.203	9.62	11.00	0.279	Battery 2#	/
Left tilt	62/5310	802.11n(40M)	0.104	0.117	0.032	-0.04	96%	0.122	7.78	9.00	0.161	Battery 2#	/
Test data of U-NII-2C band													
Left cheek	118/5590	802.11n(40M)	0.189	0.243	0.070	0.05	96%	0.253	10.12	11.00	0.310	Battery 1#	/
Left tilt	118/5590	802.11n(40M)	0.338	0.391	0.106	-0.12	96%	0.407	10.12	11.00	0.499	Battery 1#	Yes
Right cheek	118/5590	802.11n(40M)	0.074	/	/	0.17	96%	/	10.12	11.00	/	Battery 1#	/
Right tilt	118/5590	802.11n(40M)	0.127	/	/	0.10	96%	/	10.12	11.00	/	Battery 1#	/
Left tilt	118/5590	802.11n(40M)	0.285	0.378	0.111	-0.01	96%	0.394	10.12	11.00	0.482	Battery 2#	/
Left tilt	110/5550	802.11n(40M)	0.284	0.375	0.110	-0.01	96%	0.391	10.02	11.00	0.490	Battery 1#	/
Left tilt	134/5670	802.11n(40M)	0.192	0.253	0.075	0.05	96%	0.264	8.48	9.50	0.333	Battery 1#	/
Test data of U-NII-3 band													
Left cheek	155/5775	802.11ac(80M)	0.082	0.082	0.027	0.11	92%	0.089	9.01	11.00	0.141	Battery 1#	/
Left tilt	155/5775	802.11ac(80M)	0.142	0.194	0.057	0.08	92%	0.211	9.01	11.00	0.333	Battery 1#	/
Right cheek	155/5775	802.11ac(80M)	0.056	/	/	0.19	92%	/	9.01	11.00	/	Battery 1#	/
Right tilt	155/5775	802.11ac(80M)	0.070	0.065	0.021	0.16	92%	0.070	9.01	11.00	0.111	Battery 1#	/
Left tilt	155/5775	802.11ac(80M)	0.219	0.199	0.058	-0.08	92%	0.216	9.01	11.00	0.342	Battery 2#	/
Test at the best acoustic position													
Left tilt	118/5590	802.11n(40M)	0.258	0.261	0.080	0.15	96%	0.272	10.12	11.00	0.333	Battery 1#	/

Test Position of Head	Test Channel /Freq.(MHz)	Test Mode	Area Scan 1-g SAR (W/kg)	Measured SAR(W/kg)		Power Drift (dB)	Actual duty cycle	Scaled 1-g SAR (W/kg)	Conducted Power (dBm)	Tune-up Power (dBm)	Reported 1-g SAR (W/kg)	Accessory Information	SAR Plot.
				1-g	10-g								
Ant4(Core1)													
Test data of U-NII-2A band													
Left cheek	54/5270	802.11n(40M)	0.001	/	/	0.00	96%	/	9.72	11.00	/	Battery 1#	/
Left tilt	54/5270	802.11n(40M)	0.001	/	/	0.00	96%	/	9.72	11.00	/	Battery 1#	/
Right cheek	54/5270	802.11n(40M)	0.027	0.005	0.001	-0.08	96%	0.005	9.72	11.00	0.007	Battery 1#	/
Right tilt	54/5270	802.11n(40M)	0.022	0.011	0.002	0.15	96%	0.011	9.72	11.00	0.015	Battery 1#	/
Right tilt	54/5270	802.11n(40M)	0.019	0.006	0.002	0.16	96%	0.006	9.72	11.00	0.008	Battery 2#	/
Right tilt	62/5310	802.11n(40M)	0.000	<0.001	<0.001	0.00	96%	/	7.05	9.00	/	Battery 2#	/
Test data of U-NII-2C band													
Left cheek	118/5590	802.11n(40M)	<0.001	/	<0.001	0.00	96%	/	9.66	11.00	/	Battery 1#	/
Left tilt	118/5590	802.11n(40M)	<0.001	/	<0.001	0.00	96%	/	9.66	11.00	/	Battery 1#	/
Right cheek	118/5590	802.11n(40M)	0.024	0.010	0.004	0.00	96%	0.011	9.66	11.00	0.014	Battery 1#	/
Right tilt	118/5590	802.11n(40M)	0.023	0.012	0.002	0.00	96%	0.012	9.66	11.00	0.017	Battery 1#	/
Right tilt	118/5590	802.11n(40M)	0.014	0.011	0.002	0.00	96%	0.011	9.66	11.00	0.015	Battery 2#	/
Right tilt	110/5550	802.11n(40M)	0.025	0.018	0.003	0.00	96%	0.018	9.34	11.00	0.027	Battery 1#	Yes
Right tilt	134/5670	802.11n(40M)	<0.001	<0.001	<0.001	0.00	96%	<0.001	8.36	9.50	<0.001	Battery 1#	/
Test data of U-NII-3 band													
Left cheek	155/5775	802.11ac(80M)	0.004	/	/	0.00	92%	/	9.05	11.00	/	Battery 1#	/
Left tilt	155/5775	802.11ac(80M)	0.002	/	/	0.00	92%	/	9.05	11.00	/	Battery 1#	/
Right cheek	155/5775	802.11ac(80M)	0.022	0.015	0.003	0.00	92%	0.016	9.05	11.00	0.025	Battery 1#	/
Right tilt	155/5775	802.11ac(80M)	0.023	0.014	0.002	0.00	92%	0.016	9.05	11.00	0.024	Battery 1#	/
Right cheek	155/5775	802.11ac(80M)	0.009	0.013	0.002	0.00	92%	0.014	9.05	11.00	0.022	Battery 2#	/
Test at the best acoustic position													
Right tilt	110/5550	802.11n(40M)	0.017	0.012	0.003	0.00	96%	0.012	9.34	11.00	0.018	Battery 1#	/

Table 232: Head SAR test results of WiFi 5G SISO

Note:

- 1) Per KDB248227D01, for Head SAR test of WiFi 5G U-NII-2A, SAR is measured for 802.11n (40M) OFDM using the initial test position procedure. The highest reported SAR is adjusted by the ratio of other WiFi 5G modes to 802.11n (40M) specified maximum output power and the adjusted SAR is < 1.2 W/kg, so SAR for other WiFi 5G mode is not required.
- 2) Per KDB248227D01, for Head SAR test of WiFi 5G U-NII-2C, SAR is measured for 802.11n(40M) OFDM using the initial test position procedure. The highest reported SAR is adjusted by the ratio of 8 other WiFi 5G modes to 802.11n (40M)specified maximum output power and the adjusted SAR is < 1.2 W/kg, so SAR for other WiFi 5G mode is not required.
- 3) Per KDB248227D01, for Head SAR test of WiFi 5G U-NII-3, SAR is measured for 802.11ac (80M) OFDM using the initial test position procedure. The highest reported SAR is adjusted by the ratio of other WiFi 5G modes to 802.11ac (80M) specified maximum output power and the adjusted SAR is < 1.2 W/kg, so SAR for other WiFi 5G mode is not required.
- 4) When the same maximum output power is specified for both bands, begin SAR measurement in U-NII-2A band by applying the OFDM SAR requirements. As the highest reported SAR for a test configuration is \leq 1.2 W/kg, SAR is not required for U-NII-1 band for that configuration (802.11 mode and exposure condition).

Test Position of Head	Dist.	Test Mode	WiFi 1-g SAR (W/kg)		
			Ant 3(Core 0)	Ant 4(Core 1)	MIMO(Ant 3(Core 0)+Ant 4(Core 1))
CDD/MIMO					
U-NII-2A band					
Left cheek	/	802.11n(40M)	0.159	0.015	0.174
Left tilt	/	802.11n(40M)	0.279	0.015	0.294
Right cheek	/	802.11n(40M)	0.073	0.007	0.080
Right tilt	/	802.11n(40M)	0.105	0.015	0.120
U-NII-2C band					
Left cheek	/	802.11n(40M)	0.310	0.027	0.337
Left tilt	/	802.11n(40M)	0.499	0.027	0.526
Right cheek	/	802.11n(40M)	0.499	0.014	0.513
Right tilt	/	802.11n(40M)	0.499	0.027	0.526
U-NII-3 band					
Left cheek	/	802.11ac(80M)	0.015	0.025	0.040
Left tilt	/	802.11ac(80M)	0.015	0.025	0.040
Right cheek	/	802.11ac(80M)	0.007	0.025	0.032
Right tilt	/	802.11ac(80M)	0.015	0.024	0.039

Table 233: Head SAR test results of WiFi 5G CDD/MIMO



Test Position of Body-Worn	Dist.	Test Channel /Freq.(MHz)	Test Mode	Area Scan 1-g SAR (W/kg)	Measured SAR(W/kg)		Power Drift (dB)	Actual duty cycle	Scaled 1-g SAR (W/kg)	Conducted Power (dBm)	Tune-up Power (dBm)	Reported 1-g SAR (W/kg)	Accessory Information	SAR Plot.
					1-g	10-g								
Ant3(Core0)														
Test data of U-NII-2A band														
Front Side	15mm	60/5300	802.11a	0.001	<0.001	<0.001	0.00	99%	<0.001	14.71	16.00	<0.001	Battery 1#	/
Back Side	15mm	60/5300	802.11a	0.013	0.011	0.003	0.00	99%	0.011	14.71	16.00	0.015	Battery 1#	/
Back Side	15mm	60/5300	802.11a	0.034	0.020	0.007	0.00	99%	0.020	14.71	16.00	0.027	Battery 2#	/
Back Side	15mm	52/5260	802.11a	0.035	0.025	0.008	0.12	99%	0.025	14.44	16.00	0.036	Battery 2#	/
Back Side	15mm	56/5280	802.11a	0.028	0.020	0.006	0.13	99%	0.020	14.59	16.00	0.028	Battery 2#	/
Test data of U-NII-2C band														
Front Side	15mm	116/5580	802.11a	0.048	0.035	0.013	0.00	99%	0.035	14.57	16.00	0.049	Battery 1#	/
Back Side	15mm	116/5580	802.11a	0.047	0.036	0.013	0.00	99%	0.037	14.57	16.00	0.051	Battery 1#	/
Back Side	15mm	116/5580	802.11a	0.055	0.040	0.014	0.10	99%	0.041	14.57	16.00	0.057	Battery 2#	Yes
Back Side	15mm	104/5520	802.11a	0.040	0.027	0.009	0.000	99%	0.027	14.55	16.00	0.038	Battery 2#	/
Back Side	15mm	136/5680	802.11a	0.043	0.030	0.011	0.00	99%	0.030	14.56	16.00	0.042	Battery 2#	/
Test data of U-NII-3 band														
Front Side	15mm	157/5785	802.11a	0.013	/	/	0.00	99%	/	14.21	16.00	/	Battery 1#	/
Back Side	15mm	157/5785	802.11a	0.034	0.016	0.006	0.00	99%	0.016	14.21	16.00	0.024	Battery 1#	/
Back Side	15mm	157/5785	802.11a	0.037	0.017	0.006	0.00	99%	0.017	14.21	16.00	0.025	Battery 2#	/
Back Side	15mm	153/5765	802.11a	0.034	0.025	0.008	0.00	99%	0.026	14.15	16.00	0.039	Battery 2#	/
Back Side	15mm	161/5805	802.11a	0.016	0.015	0.004	0.00	99%	0.015	14.21	16.00	0.022	Battery 2#	/
Ant4(Core1)														
Test data of U-NII-2A band														
Front Side	15mm	60/5300	802.11a	<0.001	/	/	0.00	99%	/	14.46	15.50	/	Battery 1#	/
Back Side	15mm	60/5300	802.11a	0.035	0.034	0.011	0.00	99%	0.034	14.46	15.50	0.044	Battery 1#	Yes
Back Side	15mm	60/5300	802.11a	0.029	0.017	0.006	0.00	99%	0.017	14.46	15.50	0.021	Battery 2#	/
Back Side	15mm	52/5260	802.11a	0.033	0.032	0.011	0.00	99%	0.032	14.36	15.50	0.042	Battery 2#	/
Back Side	15mm	56/5280	802.11a	0.032	0.028	0.009	0.11	99%	0.028	14.45	15.50	0.036	Battery 2#	/
Test data of U-NII-2C band														
Front Side	15mm	136/5680	802.11a	<0.001	/	/	0.00	99%	/	13.67	15.50	/	Battery 1#	/
Back Side	15mm	136/5680	802.11a	0.021	0.011	0.004	0.00	99%	0.011	13.67	15.50	0.017	Battery 1#	/
Back Side	15mm	136/5680	802.11a	0.030	0.015	0.005	0.00	99%	0.015	13.67	15.50	0.024	Battery 2#	/
Back Side	15mm	104/5520	802.11a	0.010	0.004	0.001	0.000	99%	0.004	13.63	15.50	0.007	Battery 2#	/
Back Side	15mm	132/5660	802.11a	0.016	0.022	0.006	0.00	99%	0.022	13.66	15.50	0.033	Battery 2#	/
Test data of U-NII-3 band														
Front Side	15mm	149/5745	802.11a	<0.001	/	/	0.00	99%	/	13.73	15.50	/	Battery 1#	/
Back Side	15mm	149/5745	802.11a	0.014	0.011	0.004	0.00	99%	0.011	13.73	15.50	0.017	Battery 1#	/
Back Side	15mm	149/5745	802.11a	0.002	0.007	0.003	0.00	99%	0.007	13.73	15.50	0.011	Battery 2#	/
Back Side	15mm	157/5785	802.11a	0.001	0.008	0.001	0.00	99%	0.008	13.61	15.50	0.013	Battery 1#	/
Back Side	15mm	161/5805	802.11a	0.013	0.009	0.003	0.00	99%	0.009	13.66	15.50	0.014	Battery 1#	/

Table 234: Body Worn SAR test results of WiFi 5G SISO

Note:

1) Per KDB248227D01, for Body-Worn SAR test of WiFi 5G , SAR is measured for 5GHz 802.11a using the initial test position procedure. The highest reported SAR for 802.11a is adjusted by the ratio of other WiFi 5G modes to

802.11a specified maximum output power and the adjusted SAR is < 1.2 W/kg, so SAR for other WiFi 5G modes are not required.

2) Per KDB 648474 D04, Product Specific 10-g SAR test is not required for U-NII-1 and U-NII-3 since hotspot mode 1-g reported SAR < 1.2 W/kg.

3) The device do not support hotspot function at U-NII-2A & U-NII-2C band.

4) Per KDB 248227D01v02, simultaneous transmission provisions in KDB Publication 447498 should be used to determine simultaneous transmission SAR test exclusion for WiFi MIMO. If the sum of 1-g SAR single transmission SAR measurement is <1.6W/kg, no additional SAR measurements for MIMO are required. Alternatively, SAR for MIMO can be measured with all antennas transmitting simultaneously at the specified maximum output power of MIMO operation

Test Position of Body-Worn	Dist.	Test Mode	WiFi 5G CDD/MIMO 1-g SAR (W/kg)		
			Ant 3(Core 0)	Ant 4(Core 1)	CDD/MIMO(Ant 3(Core 0) +Ant 4(Core 1))
CDD/MIMO					
Test data of U-NII-2A band					
Front Side	15mm	802.11a	0.036	0.043	0.079
Back Side	15mm	802.11a	0.036	0.043	0.079
U-NII-2C band					
Front Side	15mm	802.11a	0.049	0.033	0.082
Back Side	15mm	802.11a	0.057	0.033	0.090
U-NII-3 band					
Front Side	15mm	802.11a	0.039	0.017	0.056
Back Side	15mm	802.11a	0.039	0.017	0.056

Table 235: Body Worn SAR test results of WiFi 5G CDD/MIMO



Test Position of Hotspot	Dist.	Test Channel /Freq.(MHz)	Test Mode	Area Scan 1-g SAR (W/kg)	Measured SAR(W/kg)		Power Drift (dB)	Actual duty cycle	Scaled 1-g SAR (W/kg)	Conducted Power (dBm)	Tune-up Power (dBm)	Reported 1-g SAR (W/kg)	Accessory Information	SAR Plot.
					1-g	10-g								
Ant3(Core0)														
Test data of U-NII-1 band														
Front Side	10mm	48/5240	802.11a	0.066	0.033	0.010	0.00	99%	0.033	14.28	16.00	0.049	Battery 1#	/
Back Side	10mm	48/5240	802.11a	0.052	0.034	0.011	0.00	99%	0.034	14.28	16.00	0.051	Battery 1#	/
Left Side	10mm	48/5240	802.11a	0.003	/	/	0.00	99%	/	14.28	16.00	/	Battery 1#	/
Right Side	10mm	48/5240	802.11a	0.036	/	/	0.06	99%	/	14.28	16.00	/	Battery 1#	/
Top Side	10mm	48/5240	802.11a	0.091	0.069	0.022	0.12	99%	0.070	14.28	16.00	0.104	Battery 1#	/
Top Side	10mm	48/5240	802.11a	0.086	0.070	0.022	0.09	99%	0.071	14.28	16.00	0.106	Battery 2#	/
Top Side	10mm	44/5220	802.11a	0.092	0.084	0.026	0.09	99%	0.085	14.08	16.00	0.132	Battery 2#	/
Top Side	10mm	40/5200	802.11a	0.078	0.067	0.021	0.01	99%	0.068	14.08	16.00	0.106	Battery 2#	/
Test data of U-NII-3 band														
Front Side	10mm	161/5805	802.11a	0.024	/	/	0.00	99%	/	14.21	16.00	/	Battery 1#	/
Back Side	10mm	161/5805	802.11a	0.050	/	/	0.00	99%	/	14.21	16.00	/	Battery 1#	/
Left Side	10mm	161/5805	802.11a	0.018	0.018	0.006	0.00	99%	0.019	14.21	16.00	0.028	Battery 1#	/
Right Side	10mm	161/5805	802.11a	0.028	0.028	0.008	0.00	99%	0.028	14.21	16.00	0.042	Battery 1#	/
Top Side	10mm	161/5805	802.11a	0.109	0.094	0.032	-0.05	99%	0.095	14.21	16.00	0.143	Battery 1#	/
Top Side	10mm	161/5805	802.11a	0.133	0.119	0.042	0.02	99%	0.120	14.21	16.00	0.182	Battery 2#	/
Top Side	10mm	157/5785	802.11a	0.133	0.133	0.046	0.02	99%	0.134	14.21	16.00	0.203	Battery 2#	/
Top Side	10mm	153/5765	802.11a	0.161	0.150	0.051	-0.09	99%	0.152	14.15	16.00	0.232	Battery 2#	Yes
Ant4(Core1)														
Test data of U-NII-1&U-NII-2A band														
Front Side	10mm	48/5240	802.11a	<0.001	/	<0.001	0.00	99%	/	14.23	15.50	/	Battery 1#	/
Back Side	10mm	48/5240	802.11a	0.082	0.092	0.026	0.00	99%	0.093	14.23	15.50	0.124	Battery 1#	Yes
Left Side	10mm	48/5240	802.11a	0.048	0.048	0.013	0.00	99%	0.048	14.23	15.50	0.065	Battery 1#	/
Right Side	10mm	48/5240	802.11a	<0.001	<0.001	<0.001	0.00	99%	<0.001	14.23	15.50	<0.001	Battery 1#	/
Top Side	10mm	48/5240	802.11a	<0.001	<0.001	<0.001	0.00	99%	<0.001	14.23	15.50	<0.001	Battery 1#	/
Back Side	10mm	48/5240	802.11a	0.092	0.075	0.021	0.00	99%	0.075	14.23	15.50	0.101	Battery 2#	/
Back Side	10mm	44/5220	802.11a	0.086	0.075	0.020	0.00	99%	0.076	14.13	15.50	0.104	Battery 1#	/
Back Side	10mm	40/5200	802.11a	0.079	0.067	0.018	0.00	99%	0.068	14.05	15.50	0.095	Battery 1#	/
Test data of U-NII-3 band														
Front Side	10mm	149/5745	802.11a	<0.001	<0.001	<0.001	0.00	99%	<0.001	13.73	15.50	<0.001	Battery 1#	/
Back Side	10mm	149/5745	802.11a	0.051	0.029	0.011	0.00	99%	0.029	13.73	15.50	0.043	Battery 1#	/
Left Side	10mm	149/5745	802.11a	0.028	0.013	0.004	-0.07	99%	0.014	13.73	15.50	0.020	Battery 1#	/
Right Side	10mm	149/5745	802.11a	<0.001	<0.001	<0.001	0.00	99%	<0.001	13.73	15.50	<0.001	Battery 1#	/
Top Side	10mm	149/5745	802.11a	<0.001	<0.001	<0.001	0.00	99%	<0.001	13.73	15.50	<0.001	Battery 1#	/
Back Side	10mm	149/5745	802.11a	0.064	0.045	0.014	0.00	99%	0.045	13.73	15.50	0.068	Battery 2#	/
Back Side	10mm	161/5805	802.11a	0.057	0.036	0.012	0.00	99%	0.036	13.66	15.50	0.055	Battery 2#	/
Back Side	10mm	157/5785	802.11a	0.056	0.039	0.013	0.00	99%	0.039	13.61	15.50	0.061	Battery 2#	/

Table 236: Hotspot SAR test results of WiFi 5G SISO

Note:

- 1) Per KDB248227D01, for Body-Worn SAR test of WiFi 5G , SAR is measured for 5GHz 802.11a using the initial test position procedure. The highest reported SAR for 802.11a is adjusted by the ratio of other WiFi 5G modes to 802.11a specified maximum output power and the adjusted SAR is < 1.2 W/kg, so SAR for other WiFi 5G modes are not required.
- 2) Per KDB 648474 D04, Product Specific 10-g SAR test is not required for U-NII-1 and U-NII-3 since hotspot mode 1-g reported SAR < 1.2 W/kg.
- 3) The device do not support hotspot function at U-NII-2A & U-NII-2C band.
- 4) Per KDB 248227D01v02, simultaneous transmission provisions in KDB Publication 447498 should be used to determine simultaneous transmission SAR test exclusion for WiFi MIMO. If the sum of 1-g SAR single transmission SAR measurement is <1.6W/kg, no additional SAR measurements for MIMO are required. Alternatively, SAR for MIMO can be measured with all antennas transmitting simultaneously at the specified maximum output power of MIMO operation

Test Position of Hotspot	Dist.	Test Mode	WiFi 1-g SAR (W/kg)		
			Ant 3(Core 0)	Ant 4(Core 1)	CDD/MIMO(Ant 3(Core 0) +Ant 4(Core 1))
CDD/MIMO					
U-NII-1 band					
Front Side	10mm	802.11a	0.049	0.124	0.173
Back Side	10mm	802.11a	0.051	0.124	0.175
Left Side	10mm	802.11a	0.132	0.065	0.197
Right Side	10mm	802.11a	0.132	0.124	0.256
Top Side	10mm	802.11a	0.132	0.124	0.256
U-NII-3 band					
Front Side	10mm	802.11a	0.232	0.068	0.300
Back Side	10mm	802.11a	0.232	0.068	0.300
Left Side	10mm	802.11a	0.028	0.020	0.048
Right Side	10mm	802.11a	0.042	0.068	0.110
Top Side	10mm	802.11a	0.232	0.068	0.300

Table 237: Hotspot SAR test results of WiFi 5G CDD/MIMO



Product Specific 10-g SAR	Dist.	Test Channel /Freq.(MHz)	Test Mode	Area Scan 10-g SAR (W/kg)	Measured SAR(W/kg)		Power Drift (dB)	Actual duty cycle	Scaled 10-g SAR (W/kg)	Conducted Power (dBm)	Tune-up Power (dBm)	Reported 10-g SAR (W/kg)	Accessory Information	SAR Plot.
					1-g	10-g								
Ant3(Core0) data in SISO Mode (1#869175040010811 ,2#869175040011470)														
Test data of U-NII-2A band														
Front Side	0mm	60/5300	802.11a	0.267	1.040	0.327	-0.06	99%	0.330	14.71	16.00	0.445	Battery 1#	/
Back Side	0mm	60/5300	802.11a	0.127	/	/	-0.12	99%	/	14.71	16.00	/	Battery 1#	/
Left Side	0mm	60/5300	802.11a	0.008	/	/	0.04	99%	/	14.71	16.00	/	Battery 1#	/
Right Side	0mm	60/5300	802.11a	0.081	/	/	-0.02	99%	/	14.71	16.00	/	Battery 1#	/
Top Side	0mm	60/5300	802.11a	0.520	2.970	0.742	-0.17	99%	0.749	14.71	16.00	1.009	Battery 1#	/
Top Side	0mm	60/5300	802.11a	0.592	3.320	0.825	0.06	99%	0.833	14.71	16.00	1.122	Battery 2#	/
Top Side	0mm	52/5260	802.11a	0.581	3.260	0.846	-0.14	99%	0.855	14.44	16.00	1.224	Battery 2#	/
Top Side	0mm	56/5280	802.11a	0.609	3.090	0.797	-0.08	99%	0.805	14.59	16.00	1.114	Battery 2#	/
Test data of U-NII-2C band														
Front Side	0mm	116/5580	802.11a	0.414	1.890	0.540	0.02	99%	0.545	14.57	16.00	0.758	Battery 1#	/
Back Side	0mm	116/5580	802.11a	0.119	/	/	0.07	99%	/	14.57	16.00	/	Battery 1#	/
Left Side	0mm	116/5580	802.11a	0.030	/	/	-0.04	99%	/	14.57	16.00	/	Battery 1#	/
Right Side	0mm	116/5580	802.11a	0.004	/	/	-0.04	99%	/	14.57	16.00	/	Battery 1#	/
Top Side	0mm	116/5580	802.11a	0.775	4.510	1.070	-0.17	99%	1.081	14.57	16.00	1.502	Battery 1#	/
Top Side	0mm	116/5580	802.11a	0.827	5.280	1.240	-0.19	99%	1.253	14.57	16.00	1.741	Battery 2#	Yes
Top Side	0mm	104/5520	802.11a	0.668	4.360	1.040	-0.17	99%	1.051	14.55	16.00	1.467	Battery 2#	/
Top Side	0mm	136/5680	802.11a	0.703	4.510	1.070	-0.18	99%	1.081	14.56	16.00	1.506	Battery 2#	/
Ant4(Core1) data in SISO Mode														
Test data of U-NII-2A band														
Front Side	0mm	60/5300	802.11a	0.033	0.105	0.047	-0.18	99%	0.048	14.46	15.50	0.061	Battery 1#	/
Back Side	0mm	60/5300	802.11a	0.389	2.120	0.534	-0.06	99%	0.539	14.46	15.50	0.685	Battery 1#	/
Left Side	0mm	60/5300	802.11a	0.150	/	/	-0.03	99%	/	14.46	15.50	/	Battery 1#	/
Right Side	0mm	60/5300	802.11a	0.003	/	/	-0.06	99%	/	14.46	15.50	/	Battery 1#	/
Top Side	0mm	60/5300	802.11a	0.033	/	/	0.10	99%	/	14.46	15.50	/	Battery 1#	/
Back Side	0mm	60/5300	802.11a	0.231	1.160	0.307	-0.01	99%	0.310	14.46	15.50	0.394	Battery 2#	/
Back Side	0mm	52/5260	802.11a	0.466	2.300	0.594	0.11	99%	0.600	14.36	15.50	0.780	Battery 1#	Yes
Back Side	0mm	56/5280	802.11a	0.506	2.220	0.569	-0.02	99%	0.575	14.45	15.50	0.732	Battery 1#	/
Test data of U-NII-2C band														
Front Side	0mm	136/5680	802.11a	0.019	0.075	0.036	-0.17	99%	0.037	13.67	15.50	0.056	Battery 1#	/
Back Side	0mm	136/5680	802.11a	0.313	2.180	0.488	0.15	99%	0.493	13.67	15.50	0.751	Battery 1#	/
Left Side	0mm	136/5680	802.11a	0.156	/	/	-0.14	99%	/	13.67	15.50	/	Battery 1#	/
Right Side	0mm	136/5680	802.11a	0.005	/	/	0.14	99%	/	13.67	15.50	/	Battery 1#	/
Top Side	0mm	136/5680	802.11a	0.021	/	/	0.08	99%	/	13.67	15.50	/	Battery 1#	/
Back Side	0mm	136/5680	802.11a	0.403	2.290	0.528	-0.12	99%	0.533	13.67	15.50	0.813	Battery 2#	/
Back Side	0mm	104/5520	802.11a	0.259	1.520	0.358	-0.01	99%	0.362	13.63	15.50	0.556	Battery 2#	/
Back Side	0mm	116/5580	802.11a	0.264	1.590	0.373	-0.03	99%	0.377	13.59	15.50	0.585	Battery 2#	/

Table 238: Product Specific 10-g SAR test results of WiFi 5G SISO

Note:

1) Per KDB248227D01, for Product Specific 10-g SAR test of WiFi 5G, SAR is measured for 5GHz 802.11a using the initial test position procedure. The highest reported SAR for 802.11a is adjusted by the ratio of other WiFi 5G modes to 802.11a specified maximum output power and the adjusted SAR is < 75% limit, so SAR for other WiFi 5G modes are not required.

2) Per KDB 248227D01v02, simultaneous transmission provisions in KDB Publication 447498 should be used to determine simultaneous transmission SAR test exclusion for WiFi MIMO. If the sum of 1-g SAR single transmission SAR measurement is <1.6W/kg, no additional SAR measurements for MIMO are required. Alternatively, SAR for MIMO can be measured with all antennas transmitting simultaneously at the specified maximum output power of MIMO operation

Product Specific 10-g SAR	Dist.	Test Mode	WiFi 10-g SAR (W/kg)		
			Ant 3(Core 0)	Ant 4(Core 1)	CDD/MIMO(Ant 3(Core 0) +Ant 4(Core 1))
CDD/MIMO					
Test data of U-NII-2A band					
Front Side	0mm	802.11a	0.445	0.061	0.506
Back Side	0mm	802.11a	1.224	0.780	2.004
Left Side	0mm	802.11a	1.224	0.780	2.004
Right Side	0mm	802.11a	1.224	0.780	2.004
Top Side	0mm	802.11a	1.224	0.780	2.004
Test data of U-NII-2C band					
Front Side	0mm	802.11a	0.758	0.056	0.814
Back Side	0mm	802.11a	1.741	0.813	2.554
Left Side	0mm	802.11a	1.741	0.813	2.554
Right Side	0mm	802.11a	1.741	0.813	2.554
Top Side	0mm	802.11a	1.741	0.813	2.554

Table 239: Product Specific 10-g SAR test results of WiFi 5G CDD/MIMO

7.2.17 SAR measurement Results of BT

Test Position of Head	Test Channel /Freq.(MHz)	Test Mode	Measured SAR(W/kg)		Power Drift (dB)	Actual duty cycle	Scaled 1-g SAR (W/kg)	Conducted Power (dBm)	Tune-up Power (dBm)	Reported 1-g SAR (W/kg)	Accessory Information	SAR Plot.
			1-g	10-g								
Normal Power Level B Test data												
Left cheek	39/2441	DH5	0.097	0.042	0.14	77%	0.126	9.58	11.00	0.175	Battery 1#	/
Left tilt	39/2441	DH5	0.128	0.048	-0.16	77%	0.166	9.58	11.00	0.231	Battery 1#	Yes
Right cheek	39/2441	DH5	0.036	0.018	-0.06	77%	0.047	9.58	11.00	0.065	Battery 2#	/
Right tilt	39/2441	DH5	0.038	0.020	0.00	77%	0.049	9.58	11.00	0.068	Battery 1#	/
Left tilt	39/2441	DH5	0.123	0.015	-0.08	77%	0.160	9.58	11.00	0.222	Battery 1#	/
Left tilt	11/2413	DH5	0.108	0.041	-0.05	77%	0.140	9.40	11.00	0.203	Battery 2#	/
Left tilt	68/2470	DH5	0.112	0.042	-0.10	77%	0.145	9.14	11.00	0.223	Battery 2#	/
Test at the best acoustic position												
Left tilt	39/2441	DH5	0.126	0.049	0.00	77%	0.164	9.58	11.00	0.227	Battery 1#	/

Table 240: Head SAR test results of BT

Test Position of Body-Worn	Dist.	Test Channel /Freq.(MHz)	Test Mode	Measured SAR(W/kg)		Power Drift (dB)	Actual duty cycle	Scaled 1-g SAR (W/kg)	Conducted Power (dBm)	Tune-up Power (dBm)	Reported 1-g SAR (W/kg)	Accessory Information	SAR Plot.
				1-g	10-g								
Normal Power Level B Test data													
Front Side	15mm	39/2441	DH5	0.003	0.001	0.00	77%	0.004	9.58	11.00	0.005	Battery 1#	/
Back Side	15mm	39/2441	DH5	0.003	0.001	0.00	77%	0.003	9.58	11.00	0.005	Battery 1#	/
Front Side	15mm	39/2441	DH5	0.003	0.001	0.00	77%	0.004	9.58	11.00	0.006	Battery 2#	/
Front Side	15mm	11/2413	DH5	0.002	0.001	0.00	77%	0.003	9.40	11.00	0.004	Battery 2#	/
Front Side	15mm	68/2470	DH5	0.003	0.001	0.00	77%	0.004	9.14	11.00	0.007	Battery 2#	/
High Power Level A Test data													
Front Side	15mm	13/2415	DH5	0.029	0.013	-0.06	77%	0.037	16.87	17.30	0.041	Battery 1#	/
Back Side	15mm	13/2415	DH5	0.026	0.013	0.00	77%	0.033	16.87	17.30	0.037	Battery 1#	/
Front Side	15mm	13/2415	DH5	0.028	0.013	0.00	77%	0.037	16.87	17.30	0.041	Battery 2#	/
Front Side	15mm	0/2402	DH5	0.030	0.014	-0.17	77%	0.039	15.86	17.30	0.055	Battery 1#	Yes
Front Side	15mm	26/2428	DH5	0.023	0.010	-0.14	77%	0.030	16.05	17.30	0.041	Battery 1#	/

Table 241: Body Worn SAR test results of BT



Test Position of Hotspot	Dist.	Test Channel /Freq.(MHz)	Test Mode	Measured SAR(W/kg)		Power Drift (dB)	Actual duty cycle	Scaled 1-g SAR (W/kg)	Conducted Power (dBm)	Tune-up Power (dBm)	Reported 1-g SAR (W/kg)	Accessory Information	SAR Plot.
				1-g	10-g								
Normal Power Level B Test data													
Front Side	10mm	39/2441	DH5	0.013	0.005	0.00	77%	0.016	9.58	11.00	0.023	Battery 1#	/
Back Side	10mm	39/2441	DH5	0.008	0.003	0.00	77%	0.010	9.58	11.00	0.014	Battery 1#	/
Right Side	10mm	39/2441	DH5	0.005	0.001	0.00	77%	0.006	9.58	11.00	0.009	Battery 1#	/
Top Side	10mm	39/2441	DH5	0.019	0.007	-0.05	77%	0.025	9.58	11.00	0.035	Battery 1#	/
Top Side	10mm	39/2441	DH5	0.019	0.007	0.14	77%	0.025	9.58	11.00	0.035	Battery 2#	/
Top Side	10mm	11/2413	DH5	0.014	0.005	-0.05	77%	0.019	9.40	11.00	0.027	Battery 2#	/
Top Side	10mm	68/2470	DH5	0.016	0.005	0.02	77%	0.021	9.14	11.00	0.031	Battery 2#	/
High Power Level A Test data													
Front Side	10mm	13/2415	DH5	0.057	0.030	0.00	77%	0.074	16.87	17.30	0.082	Battery 1#	/
Back Side	10mm	13/2415	DH5	0.053	0.028	0.00	77%	0.069	16.87	17.30	0.076	Battery 1#	/
Right Side	10mm	13/2415	DH5	0.040	0.011	-0.04	77%	0.052	16.87	17.30	0.057	Battery 1#	/
Top Side	10mm	13/2415	DH5	0.097	0.047	-0.14	77%	0.125	16.87	17.30	0.139	Battery 1#	/
Top Side	10mm	13/2415	DH5	0.096	0.046	-0.12	77%	0.124	16.87	17.30	0.137	Battery 2#	/
Top Side	10mm	0/2402	DH5	0.106	0.052	-0.11	77%	0.138	15.86	17.30	0.192	Battery 1#	Yes
Top Side	10mm	26/2428	DH5	0.074	0.038	-0.15	77%	0.096	16.05	17.30	0.128	Battery 1#	/

Table 242: Hotspot SAR test results of BT

Note: Per KDB 648474 D04, Product Specific 10-g SAR test is not required for this frequency band since hotspot mode 1-g reported SAR < 1.2 W/kg

7.3 Multiple Transmitter Evaluation

The detailed location of the Tx antennas inside the device refers to Appendix E.

The list information of following tables which is relevant for the decision if a simultaneous transmit evaluation is necessary according to FCC KDB 447498 D01 General RF Exposure Guidance.

Mode	Exposure Condition	Front Side	Back Side	Left Side	Right Side	Top Side	Bottom Side
Main Ant (Ant 1)	Hotspot/ Product specific 10g SAR	Yes	Yes	Yes	Yes	No	Yes
Second Ant (Ant 2)	Hotspot/ Product specific 10g SAR	Yes	Yes	Yes	No	Yes	No
WiFi 2.4G/5G Core 0/BT Ant (Ant 3)	Hotspot/ Product specific 10g SAR	Yes	Yes	No	Yes	Yes	No
WiFi 2.4G/5G Core 1 Ant (Ant 4)	Hotspot/ Product specific 10g SAR	Yes	Yes	Yes	No	Yes	No
WiFi 2.4G/5G CDD/MIMO	Hotspot/ Product specific 10g SAR	Yes	Yes	Yes	Yes	Yes	No

Table 243: Sides for Hotspot/Product specific 10g SAR testing

Note:

- 1) Per KDB 648474 D04, because the diagonal distance of this device is $\geq 160\text{mm}$, so it is a phablet .
- 2) Per KDB 941225 D06 and KDB 648474 D04, particular DUT edges were not required to be evaluated for Hotspot SAR if the antenna-to-edge distance is greater than 2.5cm;
- 3) WiFi 2.4G CDD/MIMO does not support hotspot function, therefore WiFi 2.4G CDD/MIMO were not evaluated for hotspot SAR.

7.3.1 Simultaneous Transmission Possibilities

The Simultaneous Transmission Possibilities of this device are as below:

NO.	Simultaneous TX Combination	Head	Body-worn	Hotspot	Product Specific 10-g (0mm)
1	GSM Voice(Ant1) + BT	Yes	Yes	N/A	Yes
2	GSM DATA(Ant 1) + BT	N/A	Yes	Yes	Yes
3	GSM Voice(Ant 2) + BT	Yes	Yes	N/A	Yes
4	GSM DATA (Ant 2)+ BT	N/A	Yes	Yes	Yes
5	GSM Voice(Ant 1) + Wi-Fi 2.4G (Ant 3)/ Wi-Fi 2.4G (Ant 4)/ Wi- Fi 2.4G MIMO	Yes	Yes	N/A	Yes
6	GSM DATA(Ant 1) + Wi-Fi 2.4G (Ant 3)/ Wi-Fi 2.4G (Ant 4)/ Wi-Fi 2.4G MIMO	N/A	Yes	Yes	Yes
7	GSM Voice(Ant 2) + Wi-Fi 2.4G (Ant 3)/ Wi-Fi 2.4G (Ant 4)/ Wi-Fi 2.4G MIMO	Yes	Yes	N/A	Yes
8	GSM DATA (Ant 2)+ Wi-Fi 2.4G (Ant 3)/ Wi-Fi 2.4G (Ant 4)/ Wi-Fi 2.4G MIMO	N/A	Yes	Yes	Yes
9	UMTS (Ant 1) + BT	Yes	Yes	Yes	Yes
10	UMTS (Ant 1) + BT	Yes	Yes	Yes	Yes
11	UMTS (Ant 1) + Wi-Fi 2.4G (Ant 3)/ Wi-Fi 2.4G (Ant 4)/ Wi-Fi 2.4G MIMO	Yes	Yes	Yes	Yes
12	UMTS (Ant 2) + Wi-Fi 2.4G (Ant 3)/ Wi-Fi 2.4G (Ant 4)/ Wi-Fi 2.4G MIMO	Yes	Yes	Yes	Yes
13	LTE (Ant 1) + Wi-Fi 2.4G (Ant 3)/ Wi-Fi 2.4G (Ant 4)/ Wi-Fi 2.4G MIMO	Yes	Yes	Yes	Yes
14	LTE(Ant 1) + BT	Yes	Yes	Yes	Yes
15	LTE (Ant 2) + Wi-Fi 2.4G (Ant 3)/ Wi-Fi 2.4G (Ant 4)/ Wi-Fi 2.4G MIMO	Yes	Yes	Yes	Yes
16	LTE (Ant 2) + BT	Yes	Yes	Yes	Yes
17	GSM Voice(Ant 1) + Wi-Fi 5G (Ant 3)/ Wi-Fi 5G (Ant 4)/ Wi-Fi 5G MIMO	Yes	Yes	N/A	Yes
18	GSM DATA(Ant 1) + Wi-Fi 5G (Ant 3)/ Wi-Fi 5G (Ant 4)/ Wi- Fi 5G MIMO	N/A	Yes	Yes	Yes
19	GSM Voice(Ant 2) + Wi-Fi 5G (Ant 3)/ Wi-Fi 5G (Ant 4)/ Wi-Fi 5G MIMO	Yes	Yes	N/A	Yes
20	GSM DATA(Ant 2) + Wi-Fi 5G (Ant 3)/ Wi-Fi 5G (Ant 4)/ Wi-Fi 5G MIMO	N/A	Yes	Yes	Yes
21	UMTS (Ant 1) + Wi-Fi 5G (Ant 3)/ Wi-Fi 5G (Ant 4)/ Wi-Fi 5G MIMO	Yes	Yes	Yes	Yes
22	UMTS (Ant 2) + Wi-Fi 5G (Ant 3)/ Wi-Fi 5G (Ant 4)/ Wi-Fi 5G MIMO	Yes	Yes	Yes	Yes
23	LTE (Ant 1) + Wi-Fi 5G (Ant 3)/ Wi-Fi 5G (Ant 4)/ Wi-Fi 5G MIMO	Yes	Yes	Yes	Yes
24	LTE (Ant 2) + Wi-Fi 5G (Ant 3)/ Wi-Fi 5G (Ant 4)/ Wi-Fi 5G MIMO	Yes	Yes	Yes	Yes

25	GSM Voice(Ant 1) + Wi-Fi 2.4G (Ant 4) + Wi-Fi 5G (Ant 3)	Yes	Yes	N/A	Yes
26	GSM DATA(Ant 1) + Wi-Fi 2.4G (Ant 4) + Wi-Fi 5G (Ant 3)	N/A	Yes	Yes	Yes
27	GSM Voice(Ant 2) + Wi-Fi 2.4G (Ant 4) + Wi-Fi 5G (Ant 3)	Yes	Yes	N/A	Yes
28	GSM DATA(Ant 2) + Wi-Fi 2.4G (Ant 4) + Wi-Fi 5G (Ant 3)	N/A	Yes	Yes	Yes
29	UMTS (Ant 1) + Wi-Fi 2.4G (Ant 4) + Wi-Fi 5G (Ant 3)	Yes	Yes	Yes	Yes
30	UMTS (Ant 2) + Wi-Fi 2.4G (Ant 4) + Wi-Fi 5G (Ant 3)	Yes	Yes	Yes	Yes
31	LTE (Ant 1) + Wi-Fi 2.4G (Ant 4) + Wi-Fi 5G (Ant 3)	Yes	Yes	Yes	Yes
32	LTE (Ant 2) + Wi-Fi 2.4G (Ant 4) + Wi-Fi 5G (Ant 3)	Yes	Yes	Yes	Yes
33	GSM Voice(Ant 1) + BT+ Wi-Fi 5G (Ant3/ Ant4/ MIMO)	Yes	Yes	N/A	Yes
34	GSM DATA(Ant 1) + BT+ Wi-Fi 5G (Ant3/ Ant4/ MIMO)	N/A	Yes	Yes	Yes
35	GSM Voice(Ant 2) + BT+ Wi-Fi 5G (Ant3/ Ant4/ MIMO)	Yes	Yes	N/A	Yes
36	GSM DATA (Ant 2)+ BT+ Wi-Fi 5G (Ant3/ Ant4/ MIMO)	N/A	Yes	Yes	Yes
37	UMTS (Ant 1) + BT+ Wi-Fi 5G (Ant3/ Ant4/ MIMO)	Yes	Yes	Yes	Yes
38	UMTS (Ant 2) + BT+ Wi-Fi 5G (Ant3/ Ant4/ MIMO)	Yes	Yes	Yes	Yes
39	LTE (Ant 1) + BT+ Wi-Fi 5G (Ant3/ Ant4/ MIMO)	Yes	Yes	Yes	Yes
40	LTE (Ant 2) + BT+ Wi-Fi 5G (Ant3/ Ant4/ MIMO)	Yes	Yes	Yes	Yes
41	GSM Voice(Ant 1) + BT+ Wi-Fi 2.4G (Ant4)	Yes	Yes	N/A	Yes
42	GSM DATA(Ant 1) + BT+ Wi-Fi 2.4G (Ant4)	N/A	Yes	Yes	Yes
43	GSM Voice(Ant 2) + BT+ Wi-Fi 2.4G (Ant4)	Yes	Yes	N/A	Yes
44	GSM DATA (Ant 2)+ BT+ Wi-Fi 2.4G (Ant4)	N/A	Yes	Yes	Yes
45	UMTS (Ant 1) + BT+ Wi-Fi 2.4G (Ant4)	Yes	Yes	Yes	Yes
46	UMTS (Ant 2) + BT+Wi-Fi 2.4G (Ant4)	Yes	Yes	Yes	Yes
47	LTE (Ant 1) + BT+ Wi-Fi 2.4G (Ant4)	Yes	Yes	Yes	Yes
48	LTE (Ant 2) + BT+ Wi-Fi 2.4G (Ant4)	Yes	Yes	Yes	Yes
49	GSM DATA(Ant 1) + Wi-Fi 2.4G (Ant 4) + Wi-Fi 5G (Ant 3)+ BT	Yes	Yes	N/A	Yes
50	GSM DATA(Ant 2) + Wi-Fi 2.4G (Ant 4) + Wi-Fi 5G (Ant 3)+BT	N/A	Yes	Yes	Yes
51	GSM Voice(Ant 1) + Wi-Fi 2.4G (Ant 4) + Wi-Fi 5G (Ant 3)+ BT	Yes	Yes	N/A	Yes
52	GSM Voice (Ant 2) + Wi-Fi 2.4G (Ant 4) + Wi-Fi 5G (Ant 3)+BT	N/A	Yes	Yes	Yes
53	UMTS (Ant 1) + Wi-Fi 2.4G (Ant 4) + Wi-Fi 5G (Ant 3)+BT	Yes	Yes	Yes	Yes
54	UMTS (Ant 2) + Wi-Fi 2.4G (Ant 4) + Wi-Fi 5G (Ant 3)+BT	Yes	Yes	Yes	Yes
55	LTE (Ant 1) + Wi-Fi 2.4G (Ant 4) + Wi-Fi 5G (Ant 3)+BT	Yes	Yes	Yes	Yes

56	LTE (Ant 2) + Wi-Fi 2.4G (Ant 4) + Wi-Fi 5G (Ant 3)+BT	Yes	Yes	Yes	Yes
----	--	-----	-----	-----	-----

Table 244: Simultaneous Transmission Possibilities with BT Power Level B

Note:

- 1) Wi-Fi 2.4G Ant.4(Core1) can transmit simultaneously with Bluetooth and Wi-Fi 2.4G Ant.3(Core0) can't transmit simultaneously with Bluetooth.
- 2) Wi-Fi 5G Ant.3(Core0) can transmit simultaneously with Bluetooth and Ant.4(Core1) also can transmit simultaneously with Bluetooth.
- 3) Wi-Fi 2.4G has two TX antennas. Wi-Fi 2.4G 802.11g/n support 2*2 CDD/MIMO function.
- 4) Wi-Fi 5G has two TX antennas. Wi-Fi 5G 802.11 a/n/ac support 2*2 CDD/MIMO function.
- 5) Wi-Fi 2.4G& Wi-Fi 5G can't work at same mode, but they can transmit simultaneously at different modes (Wi-Fi station/P-to-P) by using different Wi-Fi antennas. Only Wi-Fi 2.4G Ant.4(Core1) station mode and Wi-Fi 5G Ant.3(Core0) P-to-P mode or Wi-Fi 2.4G Ant.4(Core1) P-to-P mode and Wi-Fi 5G Ant.3(Core0) station mode can transmit simultaneously.
- 6) The device does not support DTM function.
- 7) * VoLTE or pre-installed VOIP applications are considered.
- 8) The Main Antenna (Ant1) and Second Antenna (Ant2) can't transmit simultaneously.
- 9) For Wi-Fi 5G, U-NII-2A (5250-5350 MHz) and U-NII-2C (5470-5725 MHz) bands does not support hotspot function.
- 10) The device supports Vo-WIFI function.
- 11) When 2.4G hotspot +BT off ,it works on Ant.3(Core0). When 2.4G hotspot +BT on, 2.4G hotspot works on Ant.4(Core1) and BT works on Ant.3(Core0).
- 12) WIFI 2.4G hotspot does not support CDD/MIMO mode.
- 13) Ant 3=WiFi Core 0/ BT; Ant 4 = WiFi Core 1.

The simultaneous transmission possibilities for BT at lower power level B and high power level A are different. The simultaneous transmission possibilities for BT high power level A is as below table:

NO.	Simultaneous TX Combination	Head	Body-worn	Hotspot	Product Specific 10-g (0mm)
1	GSM Voice(Ant 1) + BT	N/A	Yes	N/A	Yes
2	GSM DATA(Ant 1) + BT	N/A	Yes	Yes	Yes
3	GSM Voice(Ant 2) + BT	N/A	Yes	N/A	Yes
4	GSM DATA (Ant 2)+ BT	N/A	Yes	Yes	Yes
5	UMTS (Ant 1) + BT	N/A	Yes	Yes	Yes
6	UMTS (Ant 2) + BT	N/A	Yes	Yes	Yes
7	LTE(Ant 1) + BT	N/A	Yes	Yes	Yes
8	LTE (Ant 2) + BT	N/A	Yes	Yes	Yes
9	GSM Voice(Ant 1) + BT+ Wi-Fi 2.4G (Ant4)	N/A	Yes	N/A	Yes
10	GSM DATA(Ant 1) + BT+ Wi-Fi 2.4G (Ant4)	N/A	Yes	Yes	Yes
11	GSM Voice(Ant 2) + BT+ Wi-Fi 2.4G (Ant4)	N/A	Yes	N/A	Yes
12	GSM DATA (Ant 2)+ BT+ Wi-Fi 2.4G (Ant4)	N/A	Yes	Yes	Yes
13	UMTS (Ant 1) + BT+ Wi-Fi 2.4G (Ant4)	N/A	Yes	Yes	Yes
14	UMTS (Ant 2) + BT+ Wi-Fi 2.4G (Ant4)	N/A	Yes	Yes	Yes
15	LTE (Ant 1) + BT+ Wi-Fi 2.4G (Ant4)	N/A	Yes	Yes	Yes
16	LTE (Ant 2) + BT+ Wi-Fi 2.4G (Ant4)	N/A	Yes	Yes	Yes
17	GSM Voice(Ant 1) + BT+ Wi-Fi 5G (Ant4)	N/A	Yes	N/A	Yes
18	GSM DATA(Ant 1) + BT+ Wi-Fi 5G (Ant4)	N/A	Yes	Yes	Yes
19	GSM Voice(Ant 2) + BT+ Wi-Fi 5G (Ant4)	N/A	Yes	N/A	Yes
20	GSM DATA (Ant 2)+ BT+ Wi-Fi 5G (Ant4)	N/A	Yes	Yes	Yes
21	UMTS (Ant 1) + BT+ Wi-Fi 5G (Ant4)	N/A	Yes	Yes	Yes
22	UMTS (Ant 2) + BT+ Wi-Fi 5G (Ant4)	N/A	Yes	Yes	Yes
23	LTE (Ant 1) + BT+ Wi-Fi 5G (Ant4)	N/A	Yes	Yes	Yes
24	LTE (Ant 2) + BT+ Wi-Fi 5G (Ant4)	N/A	Yes	Yes	Yes

Table 245: Simultaneous Transmission Possibilities with BT Power Level A

- 1) When BT is in high power level A, BT and Wi-Fi 5G Ant.3(Core0)/WIFI 5G MIMO cannot transmit simultaneously because BT occupies Wifi 5G Ant.3(Core0) 's RF channel. They are time division multiplexing.
- 2) When WiFi 2.4G and 5G are both on at the same time, BT can only work at power B. BT High Power A will be limited by design.
- 3) Ant 3=WiFi Core 0/ BT; Ant 4 = WiFi Core 1.

7.3.2 SAR Summation Scenario

Test Position		Second antenna														Second antenna MaxSAR	
		GSM 850	GSM 1900	UMTS Band II	UMTS Band IV	UMTS Band V	LTE Band 2	LTE Band 4	LTE Band 5	LTE Band 7	LTE Band 12	LTE Band 17	LTE Band 26	LTE Band 38	LTE Band 41		LTE Band 66
Head	Left cheek	0.457	0.191	0.291	0.368	0.362	0.276	0.315	0.393	0.154	0.370	/	0.418	0.165	0.192	0.334	0.457
	Left tilt	0.416	0.262	0.413	0.535	0.344	0.446	0.453	0.315	0.189	0.370	/	0.455	0.223	0.238	0.430	0.535
	Right cheek	0.425	0.276	0.370	0.333	0.398	0.364	0.332	0.349	0.282	0.356	/	0.480	0.258	0.313	0.409	0.480
	Right tilt	0.388	0.556	0.543	0.585	0.421	0.577	0.381	0.316	0.403	0.461	/	0.471	0.497	0.590	0.568	0.590
Body Worn	Front side	0.305	0.030	0.100	0.188	0.298	0.092	0.195	0.324	0.057	0.221	/	0.282	0.076	0.100	0.180	0.324
	Back side	0.310	0.075	0.153	0.192	0.306	0.130	0.225	0.288	0.271	0.165	/	0.333	0.208	0.302	0.142	0.333
Hotspot	Front side	0.765	0.119	0.110	0.152	0.610	0.118	0.211	0.715	0.080	0.311	/	0.604	0.152	0.109	0.158	0.765
	Back side	0.796	0.100	0.138	0.171	0.717	0.126	0.212	0.544	0.293	0.401	/	0.734	0.477	0.425	0.165	0.796
	Left side	0.265	0.027	0.027	0.036	0.248	0.058	0.048	0.251	0.028	0.119	/	0.343	0.060	0.038	0.039	0.343
	Right side	/	/	/	/	/	/	/	/	/	/	/	/	/	/	/	/
	Top side	0.448	0.291	0.310	0.349	0.450	0.295	0.469	0.382	0.219	0.278	/	0.388	0.296	0.296	0.456	0.469
	Bottom side	/	/	/	/	/	/	/	/	/	/	/	/	/	/	/	/
Product Specific 10-g	Front side	/	/	/	/	/	/	/	/	/	/	/	/	/	/	/	/
	Back side	/	/	/	/	/	/	/	/	/	/	/	/	/	/	/	/
	Left side	/	/	/	/	/	/	/	/	/	/	/	/	/	/	/	/
	Right side	/	/	/	/	/	/	/	/	/	/	/	/	/	/	/	/
	Top side	/	/	/	/	/	/	/	/	/	/	/	/	/	/	/	/
	Bottom side	/	/	/	/	/	/	/	/	/	/	/	/	/	/	/	/

Table 246: Second antenna Max SAR

Test Position		Main antenna														Main antenna MaxSAR		
		GSM 850	GSM 1900	UMTS Band II	UMTS Band IV	UMTS Band V	LTE Band 2	LTE Band 4	LTE Band 5	LTE Band 7	LTE Band 12	LTE Band 17	LTE Band 26	LTE Band 38	LTE Band 41		LTE Band 66	
Head	Left cheek	0.105	0.078	0.182	0.372	0.148	0.179	0.268	0.145	0.180	0.072	/	0.136	0.112	0.104	0.221	0.372	
	Left tilt	0.065	0.048	0.091	0.134	0.101	0.112	0.121	0.108	0.125	0.050	/	0.089	0.083	0.089	0.089	0.134	
	Right cheek	0.149	0.098	0.223	0.296	0.224	0.275	0.271	0.207	0.267	0.093	/	0.187	0.157	0.190	0.245	0.296	
	Right tilt	0.047	0.039	0.095	0.143	0.084	0.101	0.117	0.085	0.071	0.039	/	0.074	0.049	0.051	0.103	0.143	
Body Worn	Front side	0.266	0.123	0.265	0.536	0.278	0.283	0.466	0.278	0.172	0.154	/	0.261	0.224	0.247	0.402	0.536	
	Back side	0.330	0.172	0.497	0.601	0.380	0.453	0.641	0.396	0.569	0.285	/	0.361	0.353	0.369	0.436	0.641	
Hotspot	Front side	0.372	0.267	0.318	0.465	0.446	0.218	0.420	0.472	0.176	0.188	/	0.401	0.257	0.310	0.365	0.472	
	Back side	0.584	0.301	0.228	0.439	0.652	0.232	0.458	0.585	0.199	0.370	/	0.599	0.378	0.424	0.453	0.652	
	Left side	0.328	0.062	0.072	0.101	0.370	0.069	0.106	0.327	0.059	0.225	/	0.308	0.045	0.059	0.156	0.370	
	Right side	0.162	0.115	0.120	0.190	0.197	0.113	0.183	0.177	0.090	0.112	/	0.182	0.061	0.071	0.199	0.199	
	Top side	/	/	/	/	/	/	/	/	/	/	/	/	/	/	/	/	/
	Bottom side	0.350	0.567	0.678	0.711	0.337	0.598	0.742	0.367	0.583	0.100	/	0.374	0.738	0.881	0.782	0.881	0.881
Product Specific 10-g	Front side	/	/	/	/	/	/	/	/	/	/	/	/	/	/	/	/	
	Back side	/	/	/	/	/	/	/	/	/	/	/	/	/	/	/	/	
	Left side	/	/	/	/	/	/	/	/	/	/	/	/	/	/	/	/	
	Right side	/	/	/	/	/	/	/	/	/	/	/	/	/	/	/	/	
	Top side	/	/	/	/	/	/	/	/	/	/	/	/	/	/	/	/	
	Bottom side	/	/	2.720	2.342	/	/	2.505	/	1.650	/	/	/	1.769	2.961	2.483	2.961	2.961

Table 247: Main antenna Max SAR

Test Position		Second antenna MaxSAR	WiFi 2.4G Ant3 (Core0)	WiFi 2.4G Ant4 (Core1)	WiFi 2.4G MIMO	WiFi 5G Ant3 (Core0)	WiFi 5G Ant4 (Core1)	WiFi 5G MIMO	BT Power Level B	Simultaneously Transmission SAR						
										1	2	3	4	5	6	7
Head	Left cheek	0.457	0.477	0.025	0.568	0.333	0.027	0.337	0.175	0.632	1.025	0.794	0.815	0.969	0.657	0.990
	Left tilt	0.535	0.747	0.025	0.806	0.499	0.027	0.526	0.231	0.766	1.341	1.061	1.059	1.292	0.791	1.290
	Right cheek	0.480	0.184	0.027	0.183	0.499	0.025	0.513	0.065	0.545	0.664	0.993	1.006	1.058	0.572	1.071
	Right tilt	0.590	0.267	0.025	0.232	0.499	0.027	0.526	0.068	0.658	0.857	1.116	1.114	1.184	0.683	1.182
Body Worn	Front side	0.324	0.115	0.063	0.184	0.049	0.044	0.082	0.005	0.329	0.508	0.406	0.436	0.411	0.392	0.441
	Back side	0.333	0.056	0.063	0.170	0.057	0.044	0.090	0.007	0.340	0.503	0.423	0.453	0.430	0.403	0.460
Hotspot	Front side	0.765	0.132	0.168	/	0.232	0.124	0.300	0.023	0.788	0.933	1.065	1.165	1.088	0.956	1.188
	Back side	0.796	0.107	0.168	/	0.232	0.124	0.300	0.014	0.810	0.964	1.096	1.196	1.110	0.978	1.210
	Left side	0.343	/	0.120	/	0.132	0.065	0.197	/	0.343	0.463	0.540	0.595	0.540	0.463	0.595
	Right side	/	0.094	/	/	0.132	0.124	0.256	0.009	0.009	0.094	0.256	0.132	0.265	0.009	0.141
	Top side	0.469	0.370	0.168	/	0.232	0.124	0.300	0.035	0.504	0.839	0.769	0.869	0.804	0.672	0.904
	Bottom side	/	/	/	/	/	/	/	/	/	/	/	/	/	/	/
Product Specific 10-g	Front side	/	/	/	1.174	0.758	0.061	0.814	/	/	1.174	0.814	0.758	0.814	/	0.758
	Back side	/	/	/	1.463	/	0.813	2.554	/	/	1.463	2.554	/	2.554	/	/
	Left side	/	/	/	0.649	/	/	2.554	/	/	0.649	2.554	/	2.554	/	/
	Right side	/	/	/	1.272	/	/	2.554	/	/	1.272	2.554	/	2.554	/	/
	Top side	/	/	/	1.317	1.741	/	2.554	/	/	1.317	2.554	1.741	2.554	/	1.741
	Bottom side	/	/	/	/	/	/	/	/	/	/	/	/	/	/	/

Table 248: SAR Simultaneous Tx Combination of Second antenna with WiFi/BT Scenario (BT: Power level B)

Test Position		Main antenna MaxSAR	WiFi 2.4G Ant3 (Core0)	WiFi 2.4G Ant4 (Core1)	WiFi 2.4G MIMO	WiFi 5G Ant3 (Core0)	WiFi 5G Ant4 (Core1)	WiFi 5G MIMO	BT Power Level B	Simultaneously Transmission SAR						
		1	2	3	4	5	6	7	8	1+8	1+max (2,3,4)	1+max (5,6,7)	1+3+5	1+max (5,6,7)+8	1+3+8	1+3+5+8
Head	Left cheek	0.372	0.477	0.025	0.568	0.333	0.027	0.337	0.175	0.547	0.940	0.709	0.730	0.884	0.572	0.905
	Left tilt	0.134	0.747	0.025	0.806	0.499	0.027	0.526	0.231	0.365	0.940	0.660	0.658	0.891	0.390	0.889
	Right cheek	0.296	0.184	0.027	0.183	0.499	0.025	0.513	0.065	0.361	0.480	0.809	0.822	0.874	0.388	0.887
	Right tilt	0.143	0.267	0.025	0.232	0.499	0.027	0.526	0.068	0.211	0.410	0.669	0.667	0.737	0.236	0.735
Body Worn	Front side	0.536	0.115	0.063	0.184	0.049	0.044	0.082	0.005	0.541	0.720	0.618	0.648	0.623	0.604	0.653
	Back side	0.641	0.056	0.063	0.170	0.057	0.044	0.090	0.007	0.648	0.811	0.731	0.761	0.738	0.711	0.768
Hotspot	Front side	0.472	0.132	0.168	/	0.232	0.124	0.300	0.023	0.495	0.640	0.772	0.872	0.795	0.663	0.895
	Back side	0.652	0.107	0.168	/	0.232	0.124	0.300	0.014	0.666	0.820	0.952	1.052	0.966	0.834	1.066
	Left side	0.370	/	0.120	/	0.132	0.065	0.197	/	0.370	0.490	0.567	0.622	0.567	0.490	0.622
	Right side	0.199	0.094	/	/	0.132	0.124	0.256	0.009	0.208	0.293	0.455	0.331	0.464	0.208	0.141
	Top side	0.000	0.370	0.168	/	0.232	0.124	0.300	0.035	0.035	0.370	0.300	0.400	0.335	0.203	0.435
	Bottom side	0.881	/	/	/	/	/	/	/	/	0.881	0.881	0.881	0.881	0.881	0.881
Product Specific 10-g	Front side	/	/	/	1.174	0.758	0.061	0.814	/	/	1.174	0.814	0.758	0.814	/	0.758
	Back side	/	/	/	1.463	/	0.813	2.554	/	/	1.463	2.554	/	2.554	/	/
	Left side	/	/	/	0.649	/	/	2.554	/	/	0.649	2.554	/	2.554	/	/
	Right side	/	/	/	1.272	/	/	2.554	/	/	1.272	2.554	/	2.554	/	/
	Top side	/	/	/	1.317	1.741	/	2.554	/	/	1.317	2.554	1.741	2.554	/	1.741
	Bottom side	2.961	/	/	/	/	/	/	/	/	2.961	2.961	2.961	2.961	2.961	2.961

Table 249: SAR Simultaneous Tx Combination of Main antenna with WiFi/BT Scenario (BT: Power level B)

Test Position		Second antenna MaxSAR	WiFi 2.4G Ant3 (Core0)	WiFi 2.4G Ant4 (Core1)	WiFi 2.4G MIMO	WiFi 5G Ant3 (Core0)	WiFi 5G Ant4 (Core1)	WiFi 5G MIMO	BT Power Level A	Simultaneously Transmission SAR		
		1	2	3	4	5	6	7	8	1+8	1+3+8	1+6+8
Body Worn	Front side	0.324	0.115	0.063	0.184	0.049	0.044	0.082	0.055	0.379	0.442	0.423
	Back side	0.333	0.056	0.063	0.170	0.057	0.044	0.090	0.041	0.374	0.437	0.418
Hotspot	Front side	0.765	0.132	0.168	/	0.232	0.124	0.300	0.082	0.847	1.015	0.971
	Back side	0.796	0.107	0.168	/	0.232	0.124	0.300	0.076	0.872	1.040	0.996
	Left side	0.343	/	0.120	/	0.132	0.065	0.197	/	0.343	0.463	0.408
	Right side	/	0.094	/	/	0.132	0.124	0.256	0.057	0.057	0.057	0.181
	Top side	0.469	0.370	0.168	/	0.232	0.124	0.300	0.192	0.661	0.829	0.785
	Bottom side	/	/	/	/	/	/	/	/	/	/	/
Product Specific 10-g	Front side	/	/	/	1.174	0.758	0.061	0.814	/	/	/	0.061
	Back side	/	/	/	1.463	/	0.813	2.554	/	/	/	0.813
	Left side	/	/	/	0.649	/	/	2.554	/	/	/	/
	Right side	/	/	/	1.272	/	/	2.554	/	/	/	/
	Top side	/	/	/	1.317	1.741	/	2.554	/	/	/	/
	Bottom side	/	/	/	/	/	/	/	/	/	/	/

Table 250: SAR Simultaneous Tx Combination of Second antenna with WiFi/BT Scenario (BT: Power level A)

Test Position		Main antenna MaxSAR	WiFi 2.4G Ant3 (Core0)	WiFi 2.4G Ant4 (Core1)	WiFi 2.4G MIMO	WiFi 5G Ant3 (Core0)	WiFi 5G Ant4 (Core1)	WiFi 5G MIMO	BT Power Level A	Simultaneously Transmission SAR		
		1	2	3	4	5	6	7	8	1+8	1+3+8	1+6+8
Body Worn	Front side	0.536	0.115	0.063	0.184	0.049	0.044	0.082	0.055	0.591	0.720	0.618
	Back side	0.641	0.056	0.063	0.170	0.057	0.044	0.090	0.041	0.682	0.811	0.731
Hotspot	Front side	0.472	0.132	0.168	/	0.232	0.124	0.300	0.082	0.554	0.640	0.772
	Back side	0.652	0.107	0.168	/	0.232	0.124	0.300	0.076	0.728	0.820	0.952
	Left side	0.370	/	0.120	/	0.132	0.065	0.197	/	0.370	0.490	0.567
	Right side	0.199	0.094	/	/	0.132	0.124	0.256	0.057	0.256	0.293	0.455
	Top side	/	0.370	0.168	/	0.232	0.124	0.300	0.192	0.192	0.370	0.300
	Bottom side	0.881	/	/	/	/	/	/	/	0.881	0.881	0.881
Product Specific 10-g	Front side	/	/	/	1.174	0.758	0.061	0.814	/	/	1.174	0.814
	Back side	/	/	/	1.463	/	0.813	2.554	/	/	1.463	2.554
	Left side	/	/	/	0.649	/	/	2.554	/	/	0.649	2.554
	Right side	/	/	/	1.272	/	/	2.554	/	/	1.272	2.554
	Top side	/	/	/	1.317	1.741	/	2.554	/	/	1.317	2.554
	Bottom side	2.961	/	/	/	/	/	/	/	2.961	2.961	2.961

Table 251: SAR Simultaneous Tx Combination of Main antenna with WiFi/BT Scenario (BT: Power level A)

The device also supports Tx wireless charging function. When the device is working on Tx wireless charging mode, other Tx antennas(2G/3G/4G/WIFI/BT) can still work. So this simultaneous transmission should also be considered.

Per KDB 447498D01, the following test exclusion conditions should be satisfied for all combinations of simultaneous transmission configurations:

The $[\Sigma \text{ of (the highest measured or estimated SAR for each standalone antenna configuration, adjusted for maximum tune-up tolerance)} / 1.6 \text{ W/kg}] + [\Sigma \text{ of MPE ratios}] \leq 1.0$.

Similarly For Product Specific 10-g SAR, the test exclusion conditions should be:

The $[\Sigma \text{ of (the highest measured or estimated SAR for each standalone antenna configuration, adjusted for maximum tune-up tolerance)} / 4.0 \text{ W/kg}] + [\Sigma \text{ of MPE ratios}] \leq 1.0$.

The RF exposure ratios for all combinations of simultaneous transmission configurations are calculated as below:

exposure condition	MAX Simultaneous Transmission SAR (W/kg)	SAR Limit (W/kg)	Max E-field (V/m)	MPE Limit (V/m)	RF exposure ratio (≤ 1.0)	Conclusion
Head	1.341	1.6	1.75	614	0.84	PASS
Body-worn	0.811	1.6	1.75	614	0.51	PASS
Hotspot	1.210	1.6	1.75	614	0.76	PASS
Product Specific 10-g SAR	2.961	4.0	1.75	614	0.74	PASS

Table 252: Simultaneous transmission RF exposure ratios for SAR & MPE(E-Field)

exposure condition	MAX Simultaneous Transmission SAR (W/kg)	SAR Limit (W/kg)	Max H-field (A/m)	MPE Limit (A/m)	RF exposure ratio (≤ 1.0)	Conclusion
Head	1.341	1.6	0.046	1.63	0.87	PASS
Body-worn	0.811	1.6	0.046	1.63	0.54	PASS
Hotspot	1.210	1.6	0.046	1.63	0.78	PASS
Product Specific 10-g SAR	2.961	4.0	0.046	1.63	0.77	PASS

Table 253: Simultaneous transmission RF exposure ratios for SAR & MPE(H-Field)

Note: Please refer to the Partial RF exposure test report of Wireless Charging for detailed E-field and H-field results.

7.3.3 Simultaneous Transmission Conclusion

The above numeral summed SAR results is sufficient to determine that simultaneous transmission cases will not exceed the SAR limit and therefore simultaneous transmission SAR with Volume Scans is not required per KDB 447498 D01.



Appendix A. System Check Plots

(Please See Appendix No.: SYBH(Z-SAR)20200307017001-2A, total: 42 pages)

Appendix B. SAR Measurement Plots

(Please See Appendix No.: SYBH(Z-SAR)20200307017001-2B, total: 111 pages)

Appendix C. Calibration Certificate

(Please See Appendix No.: SYBH(Z-SAR)20200307017001-2C, total: 301 pages)

Appendix D. Photo documentation

(Please See Appendix No.: SYBH(Z-SAR)20200307017001-2D, total: 10 pages)

Appendix E. Antenna Location

(Please See Appendix No.: SYBH(Z-SAR)20200307017001-2E, total: 2 page)

End