



FCC RF Test Report

**Product Name: T-Mobile myTouch Q;
HSPA/UMTS/GPRS/GSM/EDGE Mobile Phone with Bluetooth;
Ascend G312 Qwerty**

Model Number: HUAWEI U8730, U8730

**Report No: SYBH(Z-RF)001042012-2002
FCC ID: QISU8730**

Reliability Laboratory of Huawei Technologies Co., Ltd.

Huawei Base, Bantian, Longgang District, Shenzhen 518129, P.R. China

Tel: +86 755 28780808 Fax: +86 755 89652518

Notice

1. The laboratory has obtained the accreditation of China National Accreditation Service for Conformity Assessment (CNAS), and accreditation number: L0310.
2. The laboratory has been listed on the US Federal Communications Commission list of test facilities recognized to perform electromagnetic emissions measurements. The site recognition number is 97456.
3. The laboratory has been listed by industry Canada to perform electromagnetic emission measurement. The site recognition number is 6369A-2.
4. The test report is invalid if not marked with "exclusive stamp for the test report".
5. The test report is invalid if not marked with the stamps or the signatures of the persons responsible for performing, revising and approving the test report.
6. The test report is invalid if there is any evidence of erasure and/or falsification.
7. If there is any dissidence for the test report, please file objection to the test centre within 15 days from the date of receiving the test report.
8. Normally, the test report is only responsible for the samples that have undergone the test.
9. Context of the test report cannot be used partially or in full for publicity and/or promotional purposes without previous written approval of the laboratory.



Applicant: Huawei Technologies Co., Ltd.
Address: Huawei Base, Bantian, Longgang District, Shenzhen
518129, P.R. China
Date of Receipt Test Item: Mar.20, 2012
Start Date of Test: Mar.20, 2012
End Date of Test: Mar.31, 2012

Test Result: Pass

Approved By Senior Engineer Apr.01, 2012 Dai Linjun *Dai Linjun*
Date Name Signature

Reviewed By Apr.01, 2012 Cousy Xu *Cousy XU*
Date Name Signature

Operator Apr.01 2012 Huang Qiuliang *Huang Qiuliang*
Date Name Signature

Contents

1	<u>General Information</u>	5
1.1	APPLIED STANDARD.....	5
1.2	TEST LOCATION.....	5
1.3	TEST ENVIRONMENT CONDITION	5
2	<u>Test Summary</u>	6
3	<u>Product Description</u>	7
3.1	PRODUCTION INFORMATION	7
3.2	TEST DESCRIPTION.....	8
4	<u>General Test Conditions / Configurations</u>	9
4.1	RF CHANNELS UNDER TEST.....	9
4.2	TEST MODES.....	9
4.3	TEST ENVIRONMENTS	9
4.4	TEST SETUPS.....	10
4.5	TEST CONDITIONS	12
5	<u>Main Test Instruments</u>	14
6	<u>Test Results</u>	15
7	<u>Measurement Uncertainty</u>	16

1 General Information

1.1 Applied Standard

Applied Rules: 47 CFR FCC Part 2:2010, Subpart J
47 CFR FCC Part 24:2010, Subpart E
ANSI/TIA 603C: 2004

1.2 Test Location

Test Location 1: Reliability Laboratory of Huawei Technologies Co., Ltd.
Address: Huawei Base, Bantian, Longgang District, Shenzhen 518129, P.R.
China

1.3 Test Environment Condition

Ambient Temperature: 20 – 25 °C
Ambient Relative Humidity: 45 – 55 %
Atmospheric Pressure: 101 kPa



2 Test Summary

PCS Band			
Test Case	FCC Part No.	Requirements	Result
Transmitter Output Power	2.1046 & 24.232	Peak EIRP not exceed 2 W	Pass
Modulation Characteristics	2.1047	Digital modulation	Pass
Occupied Bandwidth	2.1049	(Not specified)	Pass
Band Edges Compliance	2.1051 & 24.238	Below -13 dBm/1%*EBW, in 1 MHz range	Pass
Spurious Emission at Antenna Terminals	2.1051 & 24.238	Below -13 dBm/1 kHz, 9 kHz to 150 kHz Below -13 dBm/10 kHz, 150 kHz to 30 MHz Below -13 dBm/1 MHz, 30 MHz to 10 th harmonics	Pass
Field Strength of Spurious Radiation	2.1053 & 24.238	Below -13 dBm/1 MHz	Pass
Frequency Stability	2.1055 & 24.235	Stay within the authorized frequency block	Pass

3 Product Description

3.1 Production Information

3.1.1 General Description

HUAWEI U8730, U8730 is subscriber equipment in the WCDMA/GSM system. The HSPA/UMTS frequency band is Band I, Band II, Band IV, and Band V, but Only the Band II test data is included in this report. The GSM/GPRS/EDGE frequency band includes GSM850 and GSM900 and DCS1800 and PCS1900, but only the PCS1900 bands test data is included in this report. The Mobile Phone implements such functions as RF signal receiving/transmitting, HSPA/UMTS and GSM/GPRS/EDGE protocol processing, voice, video MMS service, GPS, AGPS and WIFI etc. Externally it provides micro SD card interface, earphone port(to provide voice service) and USIM card interface. It also provides Bluetooth module to synchronize data between a PC and the phone, or to use the built-in modem of the phone to access the Internet with a PC, or to exchange data with other Bluetooth devices.

3.1.2 Board



Table 1 Board Information

T-Mobile myTouch Q; HSPA/UMTS/GPRS/GSM/EDGE Mobile Phone with Bluetooth; Ascend G 312 Qwerty;		
HUAWEI U8730, U8730		
Hardware Version	Software Version	Serial Number
HD1U873M	U8730 V100R001C85B820	E7F01A11A1500286

3.1.3 Sub-Assembly

AC/DCAadapter Model	HW-050100U2W
Manufacturer	Huawei Technologies Co., Ltd.
Input Voltage	~100-240V 50/60Hz 0.2A
Output Voltage	5V  1A
Rated Power	5W

3.1.4 Battery Technical Data

Name	Manufacture	Description
Rechargeable Li-ion	Huawei Technologies Co., Ltd.	Battery Model: HB5N1H Rated capacity: 1500mAh Nominal Voltage:  +3.7V Charging Voltage:  +4.2V

3.2 Test Description

3.2.1 Supported Frequency Range

Characteristics	Description
Downlink	1930 to 1990 MHz
Uplink	1850 to 1910MHz

3.2.2 Transmitter / Receiver Characteristics

Characteristics	Description
System Type	GSM UMTS
TX Output Power (per Antenna Port)	GSM system: 33dBm UMTS system: 24dBm
Channel Spacing(s) / Bandwidth(s)	GSM system: 200 kHz UMTS system: 5 MHz
Designation of Emissions	GSM system: 245KGXW (GMSK modulation), 248KG7W (8PSK modulation) UMTS system: 4M16F9W

3.2.3 Antenna Gain

Antenna Gain(dBi):	1.13
Antenna Gain(dBd):	-1.02

3.2.4 Power Supply

	Description
Power Supply Type	Directly Connected to DC /AC Power Supply
Input to Adapter (DC power)	DC Voltage Nominal: \approx +3.7V DC Voltage Range: \approx +3.6 V to +4.2V

4 General Test Conditions / Configurations

4.1 RF Channels under Test

Test Mode	TX / RX	RF Channel		
		Bottom (B)	Middle (M)	Top (T)
TM1/TM2	TX	Channel 512	Channel 661	Channel 810
		1850.2MHz	1880.0MHz	1909.8MHz
	RX	Channel 512	Channel 661	Channel 810
		1930.2 MHz	1960.0 MHz	1989.8 MHz
TM3/TM4/TM5	TX	Channel 9262	Channel9400	Channel9538
		1852.4MHz	1880.0MHz	1907.6MHz
	RX	Channel 9662	Channel 9800	Channel 9938
		1932.4 MHz	1960.0 MHz	1987.6 MHz

4.2 Test Modes

Test Mode	Test Modes Description
TM1	GSM/GPRS, GMSK modulation
TM2	EDGE, 8PSK modulation
TM3	WCDMA QPSK modulation
TM4	HSDPA QPSK modulation
TM5	HSUPA QPSK modulation

4.3 Test Environments

Environment Parameter	Selected Values During Tests	
Relative Humidity	Ambient	
Temperature	TN	Ambient
Voltage	VL	3.6V
	VN	3.7V
	VH	4.2V

NOTE: VL= lower extreme test voltages
VN= nominal voltage
VH= upper extreme test voltage
TN= nominal temperature

4.4 Test Setups

4.4.1 General Test Setup Configurations

Configuration	Description
Test Antenna Ports	Until otherwise declared, all TX tests are ONLY performed at the main Transmitter antenna port (e.g. TRXA, TXA and so on) of the EUT, and all RX tests are ONLY performed at the main Receiver antenna port (e.g. TRXA, RXA and so on) of the EUT.
Multiple RF Sources	Other than the tested RF source of the EUT, other RF source(s) are disabled or shutdown during measurements.

4.4.2 Test Setup 1

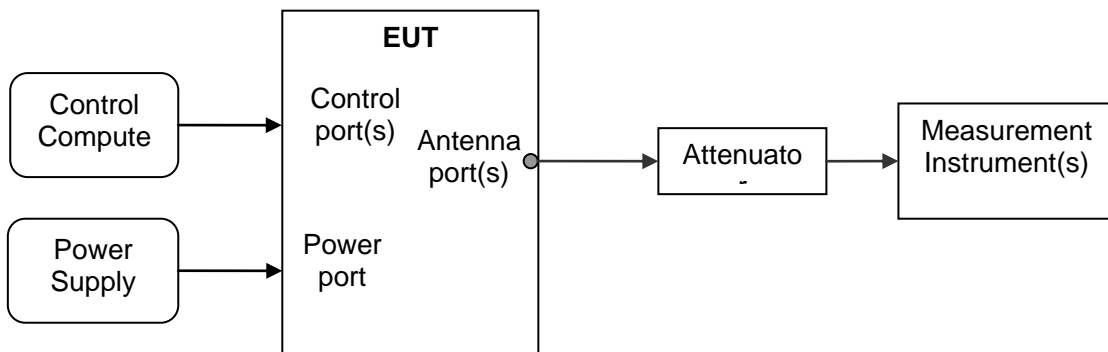

4.4.3 Test Setup 2

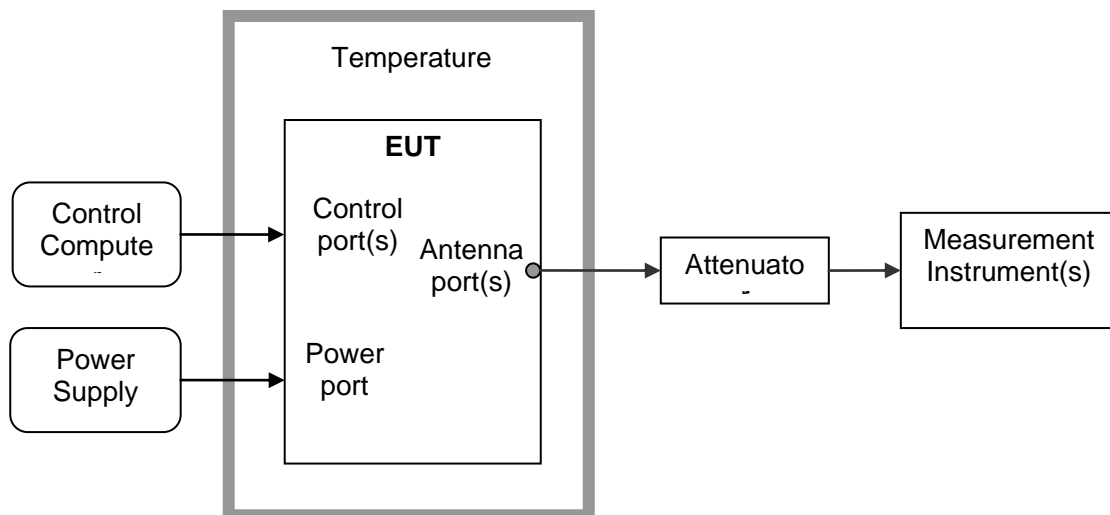

4.4.4 Test Setup 3

NOTE: Effective Isotropic radiated power (EIRP) refers to the radiation power output of the EUT, assuming all emissions are radiated from half-wave dipole antennas.

Step 1: Pre-test

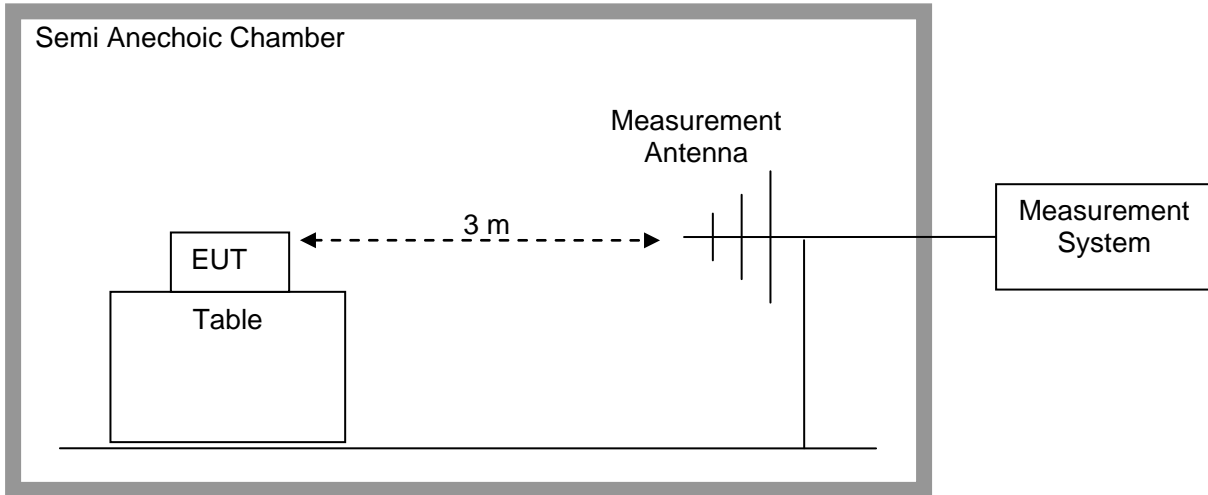

Step 2: Substitution method to verify the maximum EIRP

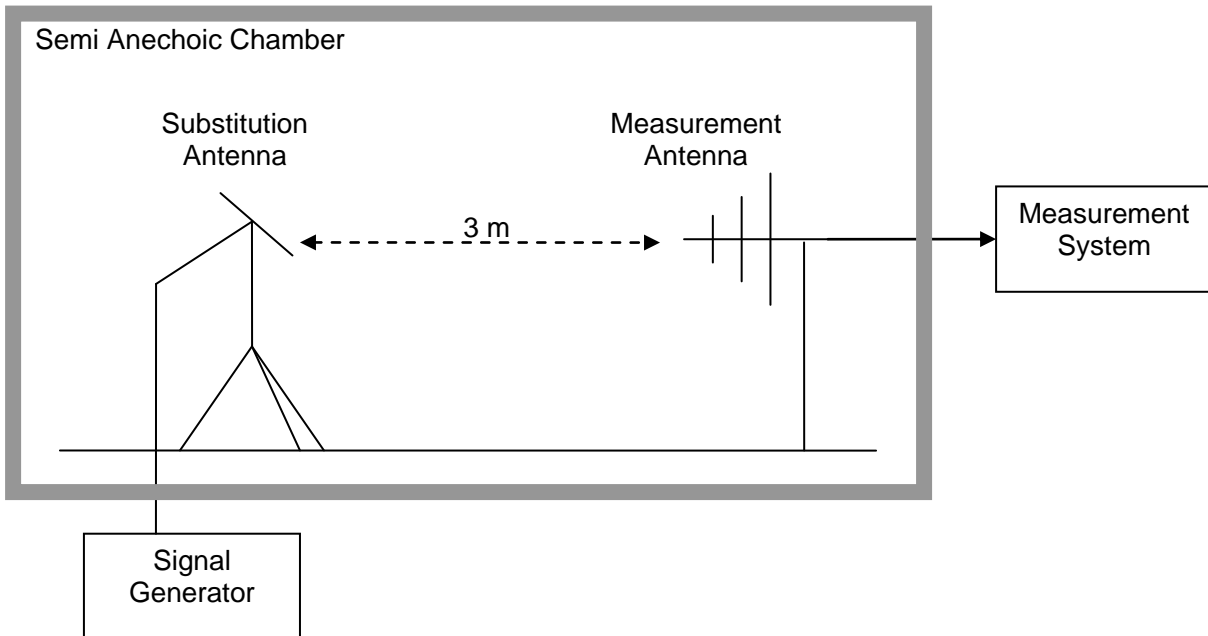

4.5 Test Conditions

Test Case	Test Conditions	
Transmitter Output Power	Test Configuration	Ambient Temperature & Rated Voltage
	Test Setup	Test Setup 1/ Setup 3
	Detector	RMS
	RF Channels (TX)	B, M, T
	Test Mode	TM1/TM2/TM3/TM4/TM5
Modulation Characteristics	Test Configuration	Ambient Temperature & Rated Voltage
	Test Setup	Test Setup 1
	RF Channels (TX)	M
	Test Mode	TM1/TM2/TM3
Occupied Bandwidth	Test Configuration	Ambient Temperature & Rated Voltage
	Test Setup	Test Setup 1
	Detector	PK
	RF Channels (TX)	B, M, T
	Test Mode	TM1/TM2/TM3
Band Edges Compliance	Test Configuration	Ambient Temperature & Rated Voltage
	Test Setup	Test Setup 1
	Detector	RMS
	RF Channels (TX)	B, T
	Test Mode	TM1/TM2/TM3
Spurious Emission at Antenna Terminals	Test Configuration	Ambient Temperature & Rated Voltage
	Test Setup	Test Setup 1
	Detector	PK
	RF Channels (TX)	B, M, T
	Test Mode	TM1/TM2/TM3
Field Strength of Spurious Radiation	Test Configuration	Ambient Temperature & Rated Voltage
	Test Setup	Test Setup 3
	Detector	PK
	RF Channels (TX)	M
	Test Mode	TM1/TM2/TM3/TM4/TM5
Frequency Stability	Test Configuration	(1) -30 °C to +50 °C with step 10 °C at Rated Voltage; (2) 85%, 100% and 115% of Rated Voltage at Ambient Temperature.
	Test Setup	Test Setup 2



Test Case	Test Conditions	
	RF Channels (TX)	M
	Test Mode	TM1/TM2/TM3

5 Main Test Instruments

Table 2 Main Test Equipments

Equipment Description	Manufacturer	Model	Serial Number	Calibrated until
Power supply	KEITHLEY	2303	1288003	Sep.27,2012
Universal Radio Communication Tester	R&S	CMU200	117341	Jan.12.2013
Universal Radio Communication Tester	Agilent	E5515C	MY50260239	Aug.31,2012
Spectrum Analyzer	Agilent	E4440A	MY49420179	Apr.20,2012
Signal Analyzer	R&S	FSQ31	200021	Sep.27,2012
Temperature Chamber	WEISS	WKL64	24600294	Feb.13,2013
Signal generator	Agilent	E8257D	MY49281095	Jul.9.2012
Test receiver	R&S	ESU26	100150	May.29.2012
Tunable Dipole	Schwarzbeck	D69250-UHAP/D69250-VHAP	919/1009	Jan.29.2013
Tunable Dipole	Schwarzbeck	D69250-UHAP/D69250-VHAP	979/917	Jan.29.2013
Horn Antenna	R & S	HF906	100683	May.15, 2012
Horn Antenna	R & S	HF906	100684	Jul.01, 2012
Broadband Antenna	Schwarzbeck	VULB 9163	9163-357	May.15, 2012
Broadband Antenna	Schwarzbeck	VULB 9163	9163-356	May.15, 2012

6 Test Results

No.	Test Item	Test Result
1	Transmitter Output Power	Appendix A
2	Modulation Characteristics	Appendix B
3	Occupied Bandwidth	Appendix C
4	Band Edges Compliance	Appendix D
5	Spurious Emission at Antenna Terminals	Appendix E
6	Field Strength of Spurious Radiation	Appendix F
7	Frequency Stability	Appendix G
8	Photos of Radiated Spurious Emissions	Appendix H

NOTE: The Appendix H only photos of Field Strength of Spurious Radiation, no test data.



7 Measurement Uncertainty

For a 95% confidence level (k=2), the measurement expanded uncertainties for defined systems, in accordance with the recommendations of ISO 17025 as following:

Test Item		Extended Uncertainty
Transmitter Output Power	Power (dBm)	U =0.39 dB
Occupied Bandwidth	Magnitude (%)	U=0.2%
Band Edge Compliance	Disturbance Power (dBm)	U=2.0 dB
Conducted Spurious Emissions	Disturbance Power (dBm)	U=2.0 dB
Field Strength of Spurious Radiation	ERP (dBm)	U=4.6 dB (30 MHz – 1GHz) U=3.0 dB (above 1 GHz)
Frequency Stability	Frequency Accuracy (ppm)	U=0.21 ppm

-----The END-----



Appendix A

Transmitter Output Power According to FCC Part 2.1046 & Part24.232



Conducted Power of Transmitter

Table 1 Measurement Results

		RF Output Power (Conducted)					
TEST CONDITIONS		Channel512(B) 1850.2MHz		Channel661(M) 1880.0MHz		Channel810(T) 1909.8MHz	
		dBm		dBm		dBm	
T_{nom} / V_{nom}		Measured	Limit	Measured	Limit	Measured	Limit
TM1		30.13	33	29.81	33	30.3	33
TM2		25.85	33	25.81	33	25.78	33
TEST CONDITIONS		Channel9262(B) 1852.4MHz		Channel9400(M) 1880.0MHz		Channel9538(T) 1907.6MHz	
		dBm		dBm		dBm	
T_{nom} / V_{nom}		Measured	Limit	Measured	Limit	Measured	Limit
TM3		22.40	33	22.46	33	22.14	33
TM4	Case1	22.79	33	22.59	33	22.26	33
	Case2	21.73	33	21.27	33	21.86	33
	Case3	20.91	33	20.62	33	20.57	33
	Case4	20.86	33	20.62	33	20.63	33
TM5	Case1	21.91	33	22.26	33	21.86	33
	Case2	20.73	33	20.61	33	20.66	33
	Case3	21.30	33	21.13	33	20.71	33
	Case4	21.40	33	21.34	33	20.92	33
	Case5	21.77	33	22.14	33	21.53	33



Peak-to-Average Ratio

Table 2 Measurement Results

TEST CONDITIONS	Channel512(B) 1850.2MHz		Channel661(M) 1880.0MHz		Channel810(T) 1909.8MHz		
	dBm		dBm		dBm		
T_{nom} / V_{nom}	Measured	Limit	Measured	Limit	Measured	Limit	
TM1	9.78	13.0	10.00	13.0	9.63	13.0	
TM2	12.52	13.0	12.92	13.0	12.67	13.0	
TEST CONDITIONS	Channel9262(B) 1852.4MHz		Channel9400(M) 1880.0MHz		Channel9538(T) 1907.6MHz		
	dBm		dBm		dBm		
T_{nom} / V_{nom}	Measured	Limit	Measured	Limit	Measured	Limit	
TM3	3.15	13.0	3.37	13.0	3.08	13.0	
TM4	Case1	2.71	13.0	2.76	13.0	2.89	13.0
	Case2	2.75	13.0	2.77	13.0	2.61	13.0
	Case3	2.58	13.0	2.50	13.0	2.49	13.0
	Case4	2.61	13.0	2.69	13.0	2.66	13.0
TM5	Case1	2.73	13.0	2.68	13.0	2.62	13.0
	Case2	2.98	13.0	2.94	13.0	2.87	13.0
	Case3	2.88	13.0	2.72	13.0	2.69	13.0
	Case4	2.58	13.0	2.51	13.0	2.59	13.0
	Case5	2.45	13.0	2.49	13.0	2.59	13.0



Test Plot of Peak-to-Average Ratio

Note: All relevant operation modes have been tested, and the worst case Plot is included in this report.

TM1

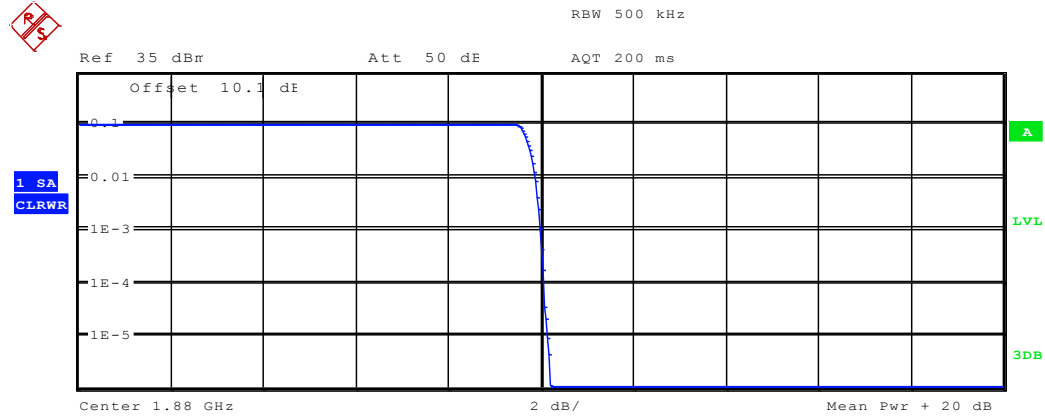

Complementary Cumulative Distribution Function
NOF samples: 100000, Usable BW: 424kHz

Trace 1	
Mean	-0.38 dBm
Peak	9.83 dBm
Crest	10.21 dB
10 %	9.52 dB
1 %	9.90 dB
.1 %	10.00 dB
.01 %	10.10 dB

Date: 31.MAR.2012 16:05:49



TM2

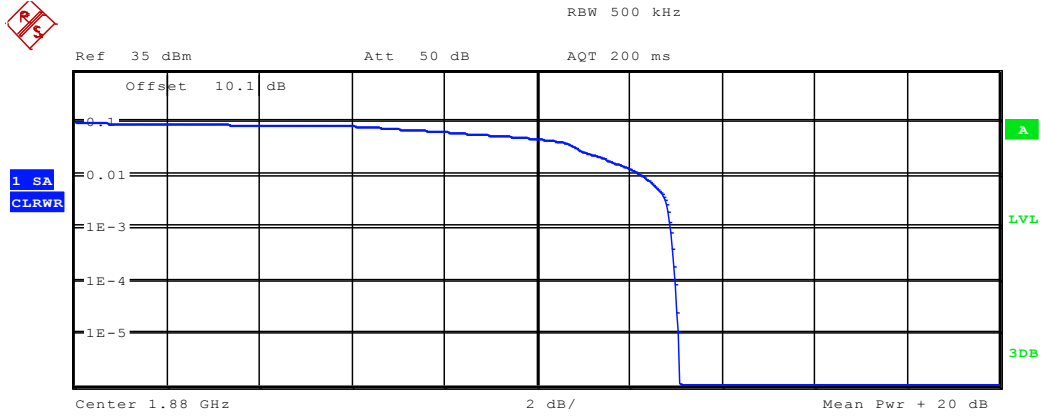

Complementary Cumulative Distribution Function
NOF samples: 100000, Usable BW: 424kHz

	Trace 1
Mean	-0.50 dBm
Peak	12.58 dBm
Crest	13.08 dB
10 %	1.86 dB
1 %	12.28 dB
.1 %	12.92 dB
.01 %	13.01 dB

Date: 31.MAR.2012 16:04:17



TM3/TM4/TM5

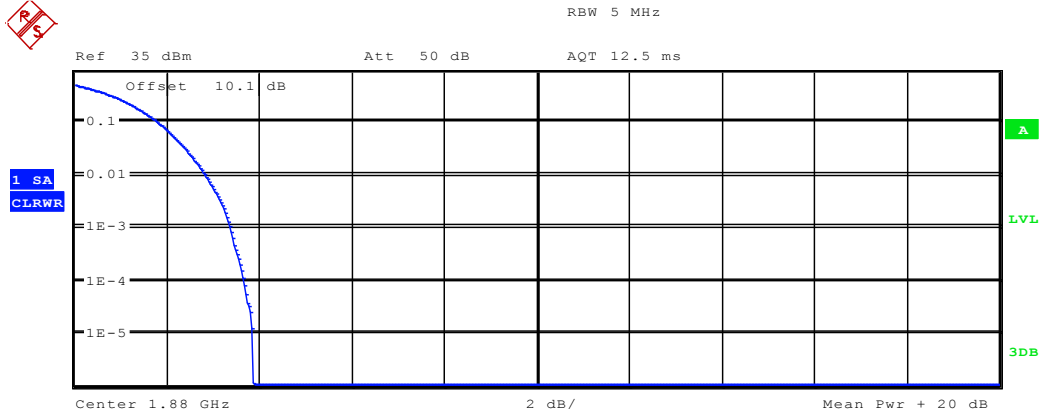

Complementary Cumulative Distribution Function
 NOF samples: 100000, Usable BW: 7.1MHz

	Trace 1
Mean	22.05 dBm
Peak	25.91 dBm
Crest	3.87 dB
10 %	1.79 dB
1 %	2.82 dB
.1 %	3.37 dB
.01 %	3.65 dB

Date: 31.MAR.2012 16:15:53



Effective Isotropic Radiated Power of Transmitter (EIRP)

Table 3 Substitution Results

Test Mode	Freq. [MHz]	Meas. Level [dBm]	Substitution Antenna Type	SGP [dBm]	Substitution Gain [dBi]	Cable Loss [dB]	Substitution Level (EIRP) [dBm]	FCC limit [dBm]	Result
TM1	1850.2	31.26	Horn Ant.	27.83	4.5	1	31.33	33	Pass
TM1	1880.0	30.94	Horn Ant.	27.71	4.5	1	31.21	33	Pass
TM1	1909.8	31.43	Horn Ant.	27.72	4.8	1	31.52	33	Pass
TM2	1850.2	26.98	Horn Ant.	23.56	4.5	1	27.06	33	Pass
TM2	1880.0	26.94	Horn Ant.	23.52	4.5	1	27.02	33	Pass
TM2	1909.8	26.91	Horn Ant.	23.19	4.8	1	26.99	33	Pass
TM3	1852.4	23.53	Horn Ant.	20.11	4.5	1	23.61	33	Pass
TM3	1880.0	23.59	Horn Ant.	20.2	4.5	1	23.70	33	Pass
TM3	1907.6	23.27	Horn Ant.	19.59	4.8	1	23.39	33	Pass

Note: a, For getting the EIRP (Efficient Isotropic Radiated Power) in substitution method, the following formula should take to calculate it,

$$\text{EIRP [dBm]} = \text{SGP [dBm]} - \text{Cable Loss [dB]} + \text{Gain [dBi]}$$

b, SGP=Signal Generator Level

-----The END-----



Appendix B

Modulation Characteristics

According to FCC Part 2.1047 & Part24 Subpart E



TM1:GPRS/GSM Channel 661

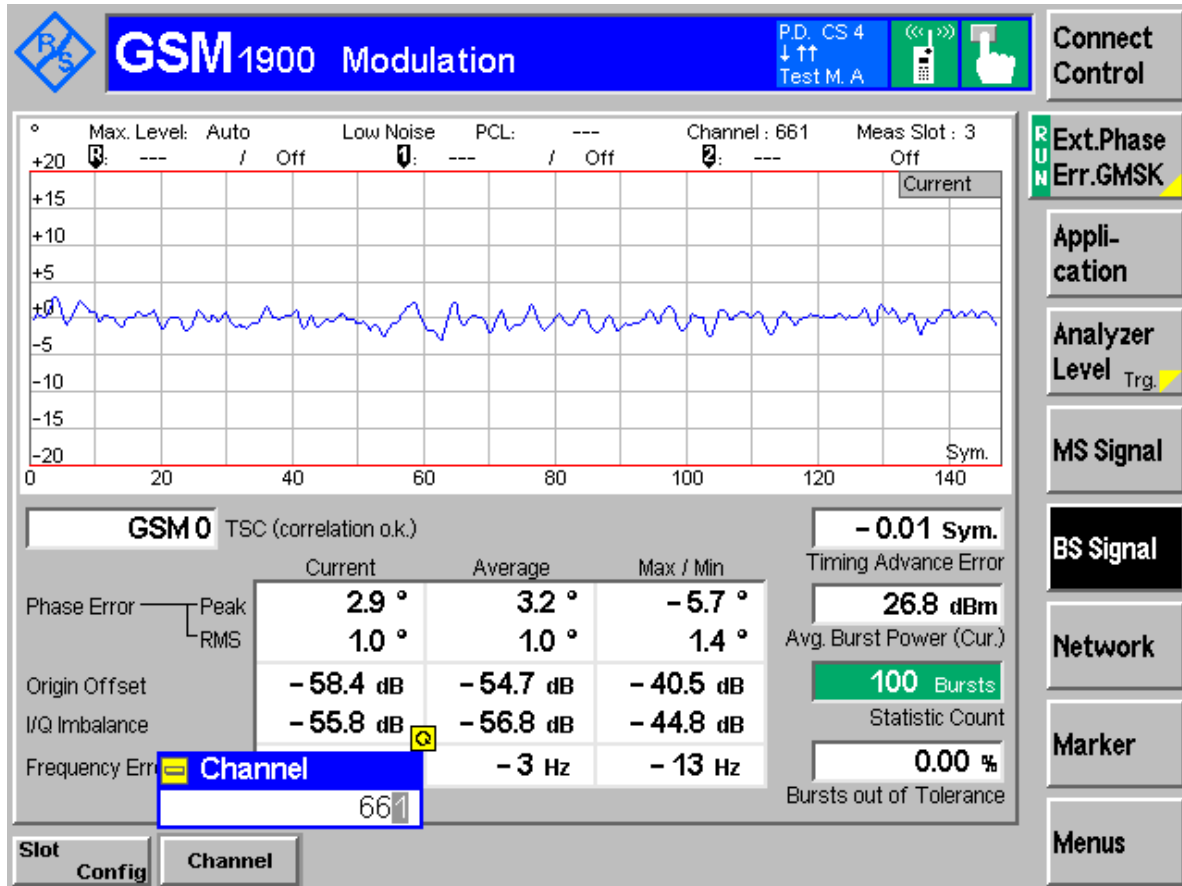



TM2:EDGE Channel 661

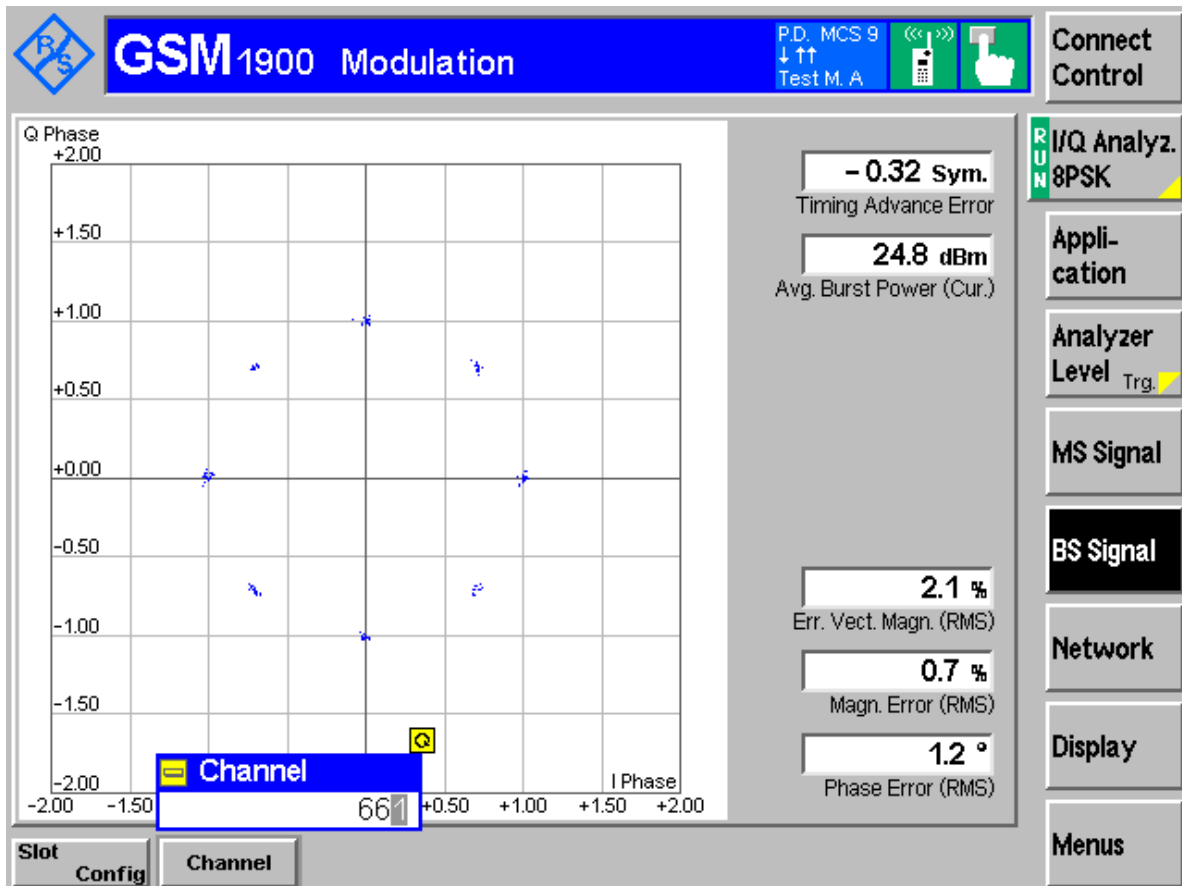



TM3: WCDMA Channel 9400

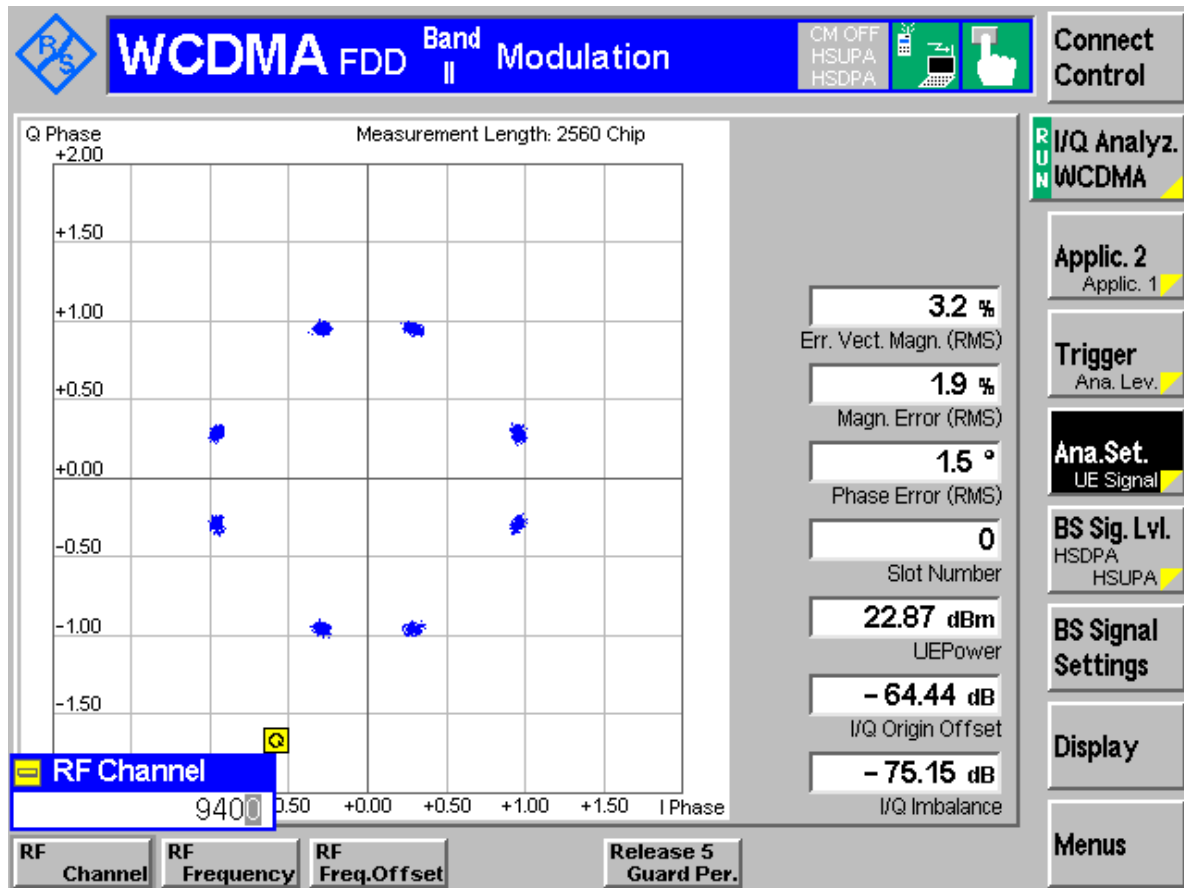

-----The END-----

--



Appendix C

Occupied Bandwidth

According to FCC Part 2.1049 & Part24 Subpart E



Result Table

Table 1 Measurement Results

Test Mode	RF Channel	Occupied Bandwidth [kHz]	Verdict
TM1	512	244.6	Pass
	661	243.6	Pass
	810	243.5	Pass
TM2	512	241.9	Pass
	661	247.5	Pass
	810	239.1	Pass
Test Mode	RF Channel	Occupied Bandwidth [MHz]	Verdict
TM3	9262	4.120	Pass
	9400	4.136	Pass
	9538	4.151	Pass



TM1:GPRS/GSM Channel 512

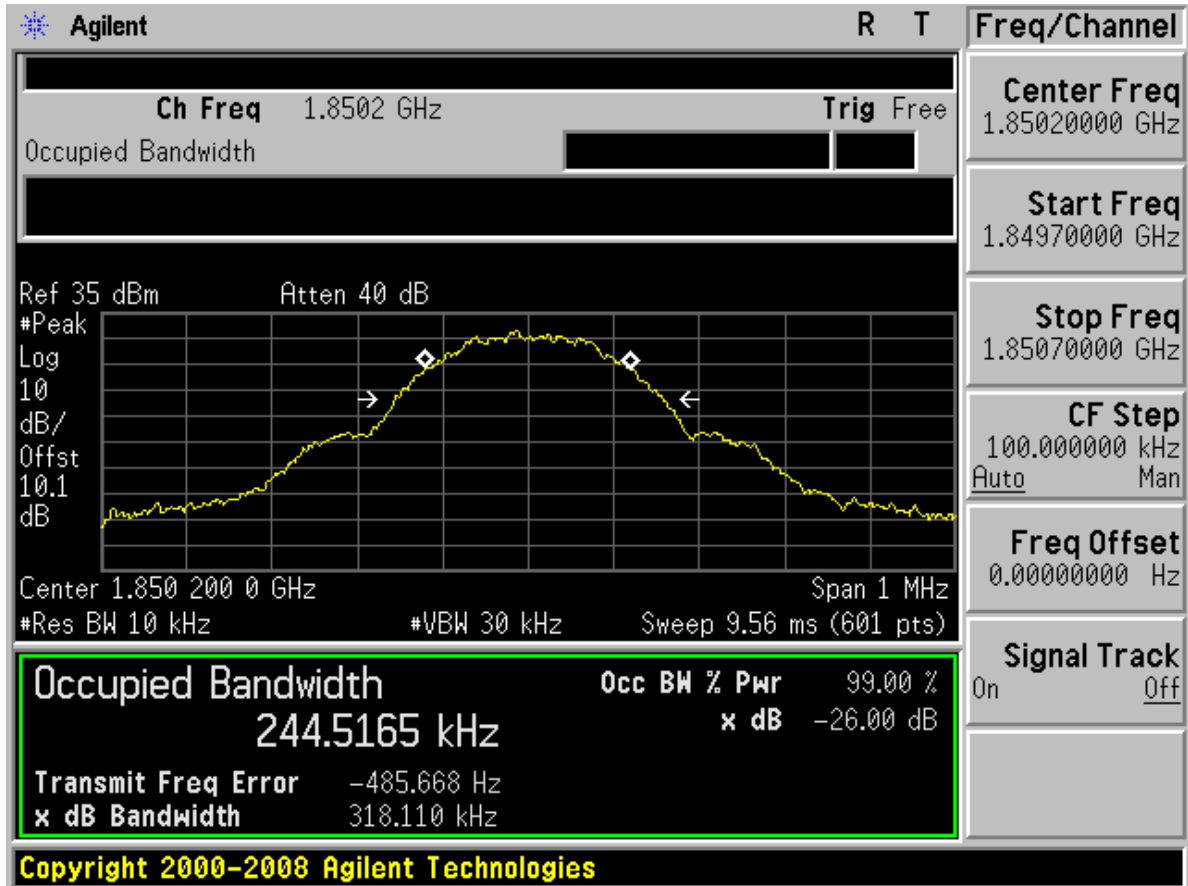



TM2:EDGE Channel 512

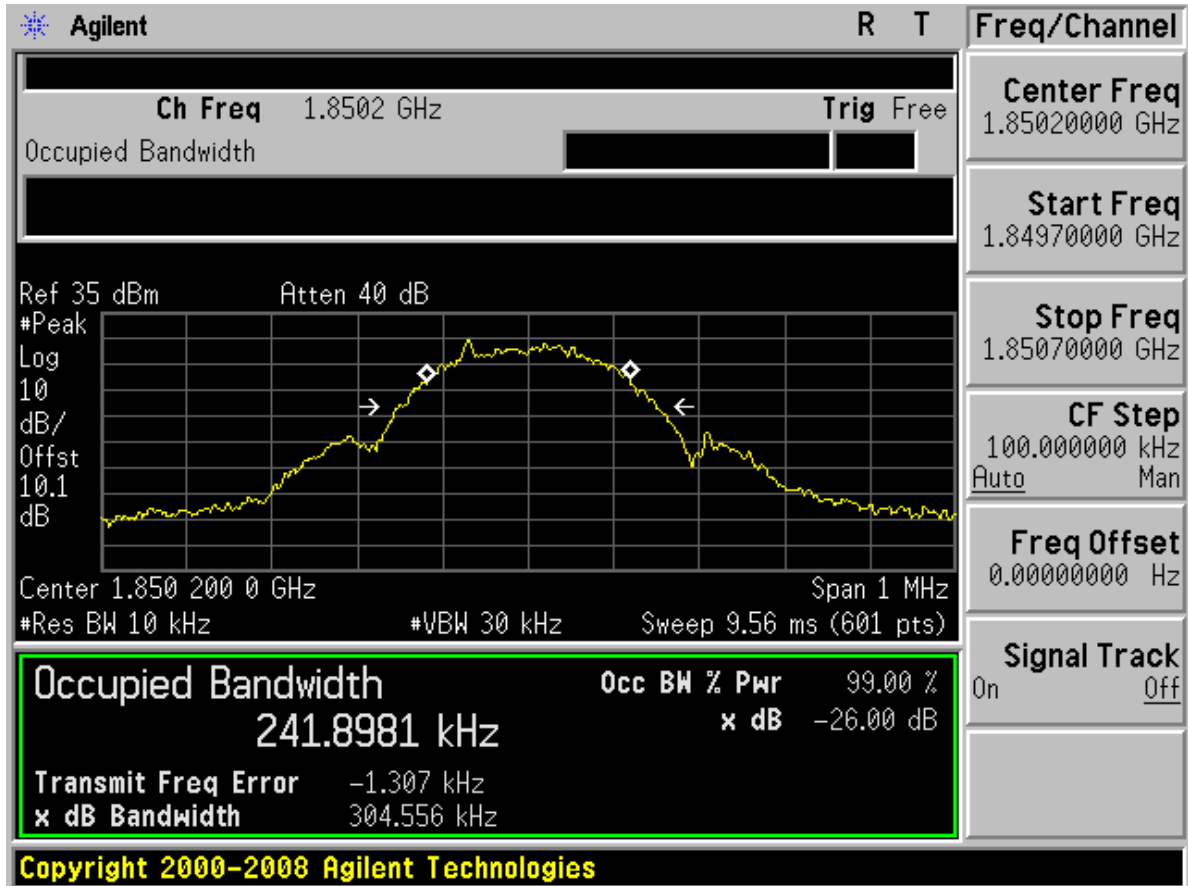



TM3: WCDMA Channel 9262

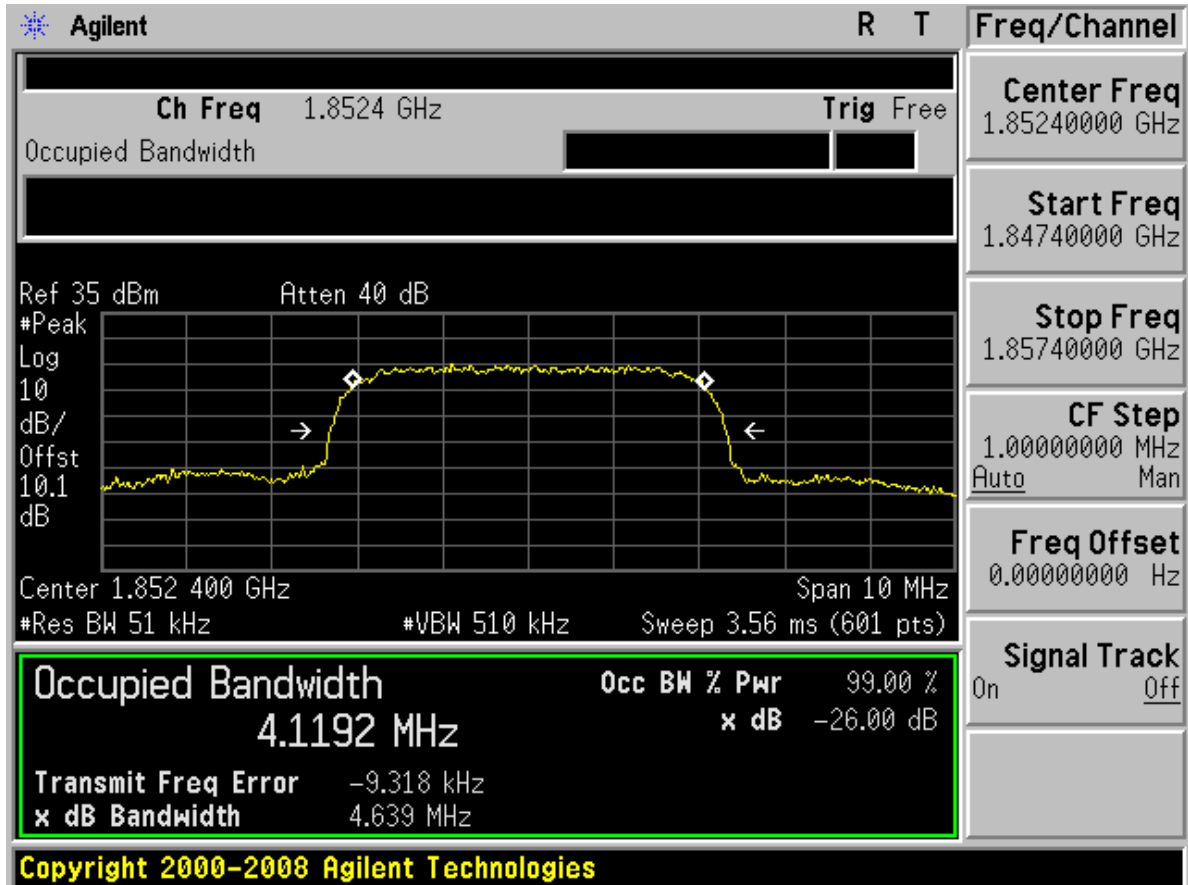



TM1:GPRS/GSM Channel 661





TM2:EDGE Channel 661





TM3: WCDMA Channel 9400

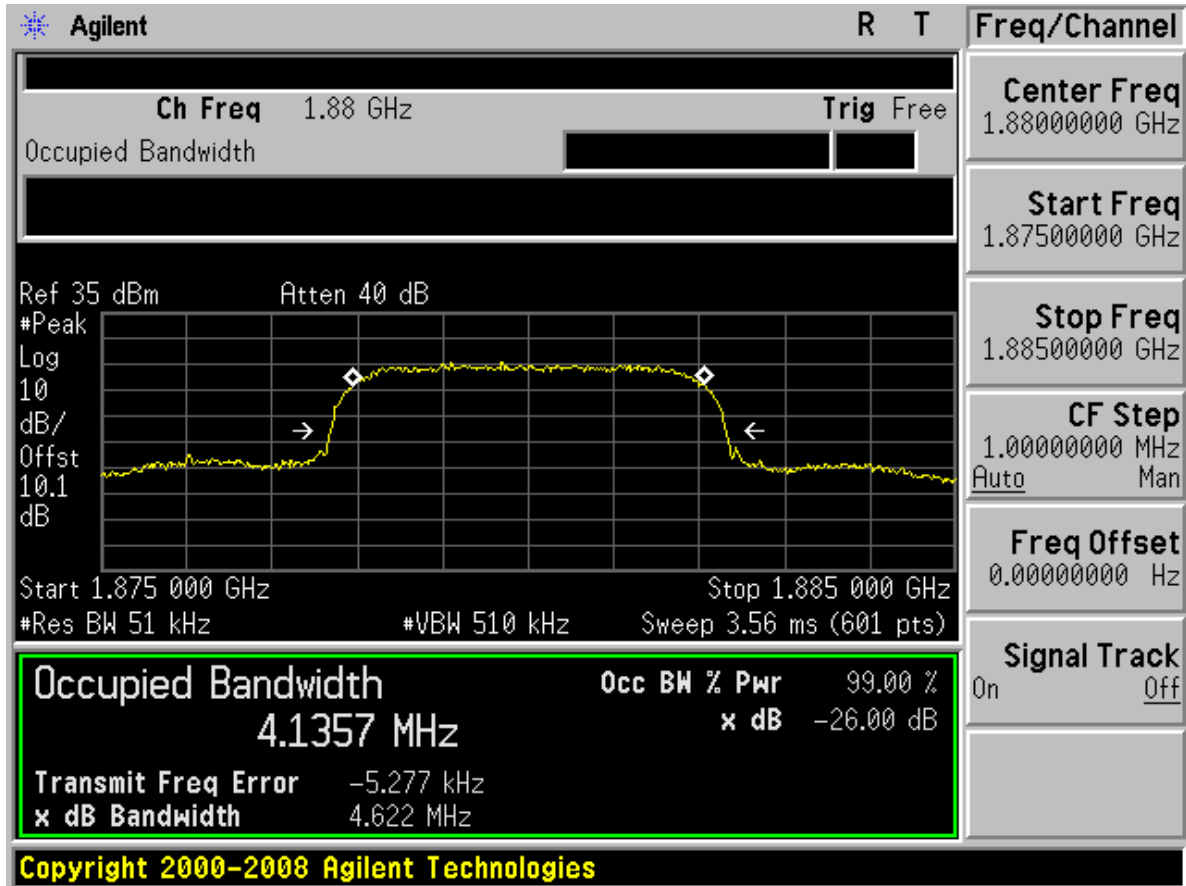



TM1:GPRS/GSM Channel 810

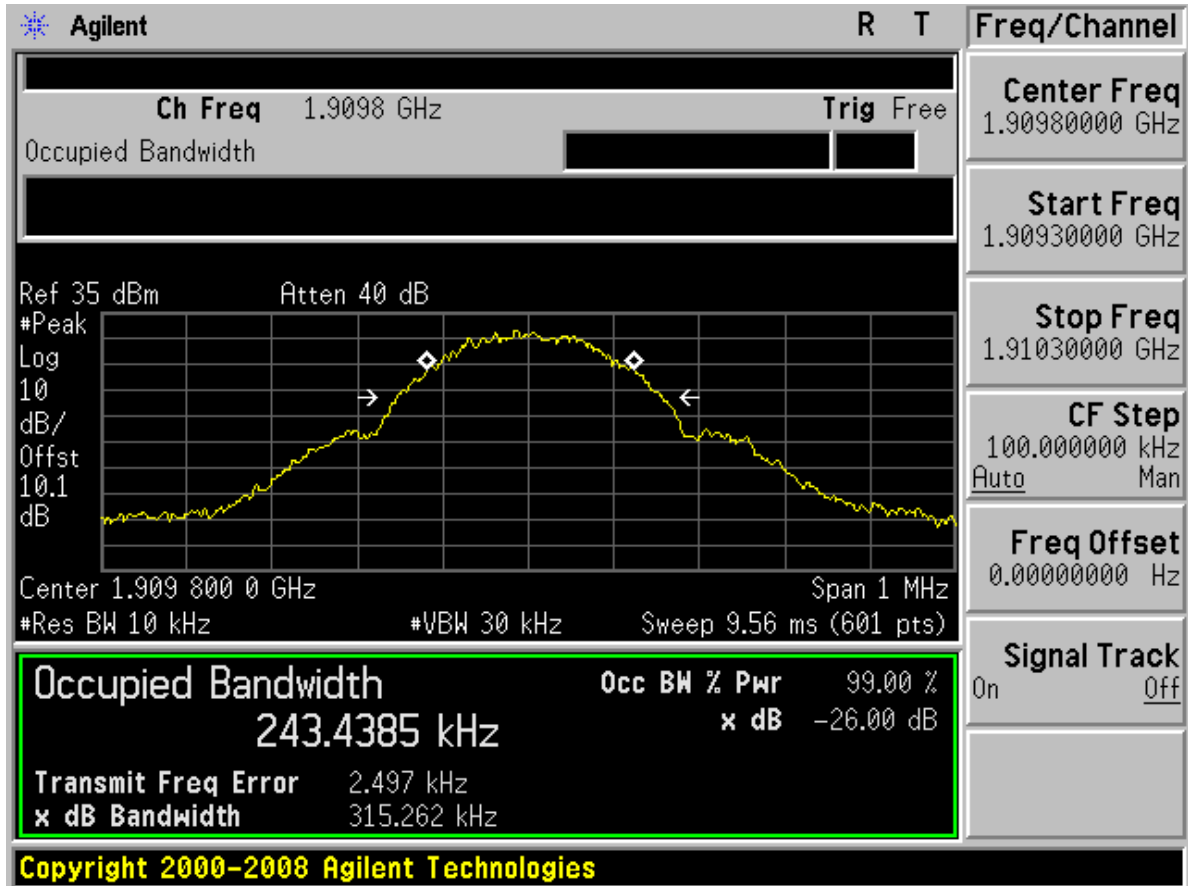



TM2:EDGE Channel 810

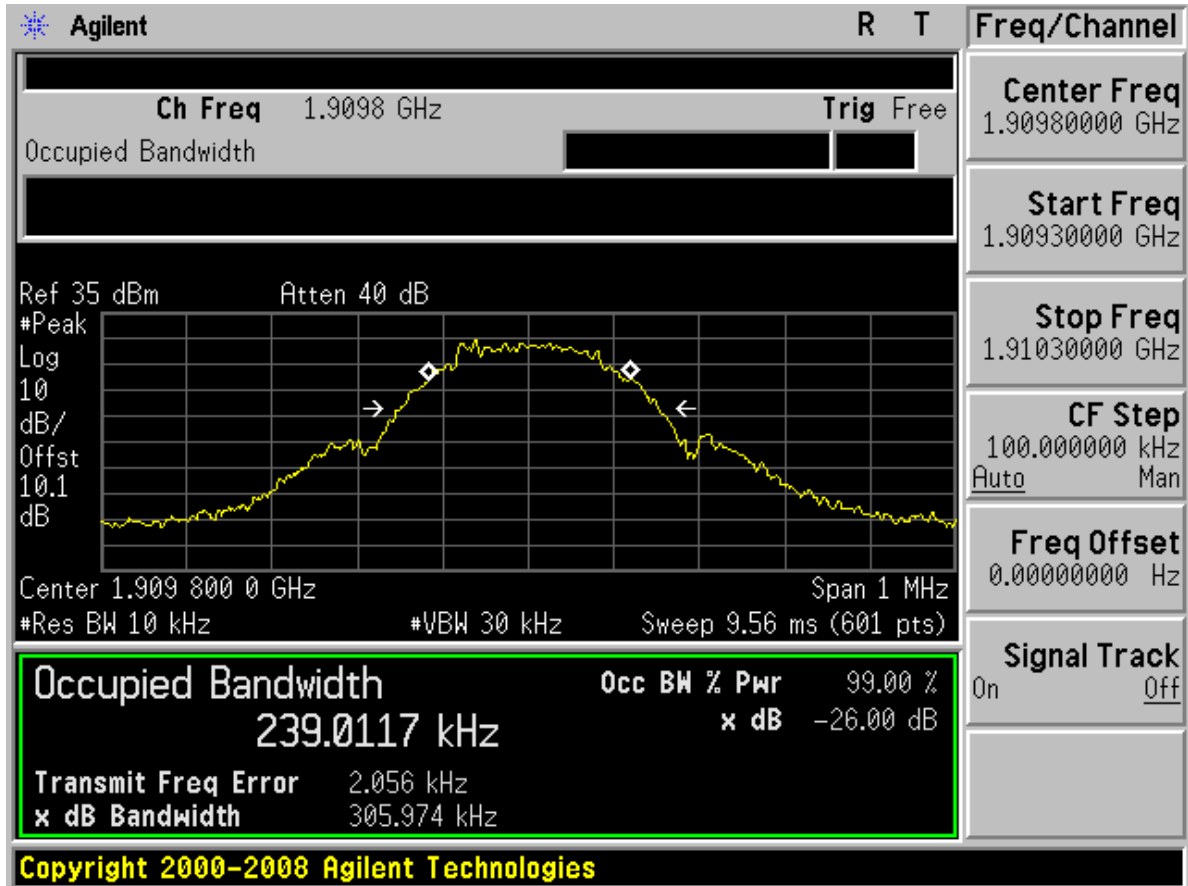



TM3: WCDMA Channel 9538

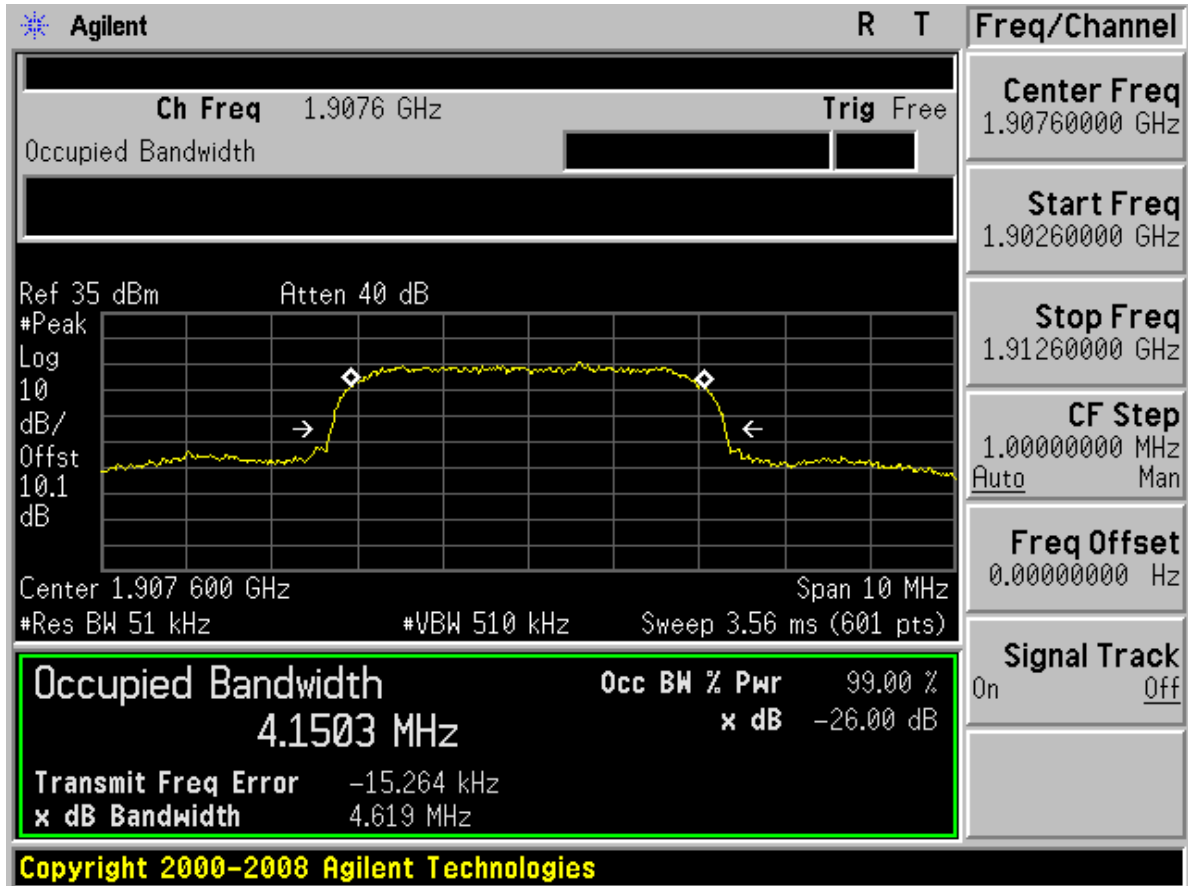

-----The END-----



Appendix D

Band Edges Compliance

According to FCC Part 2.1051 & Part24 Subpart E



TM1:GPRS/GSM

Left Edge Channel 512

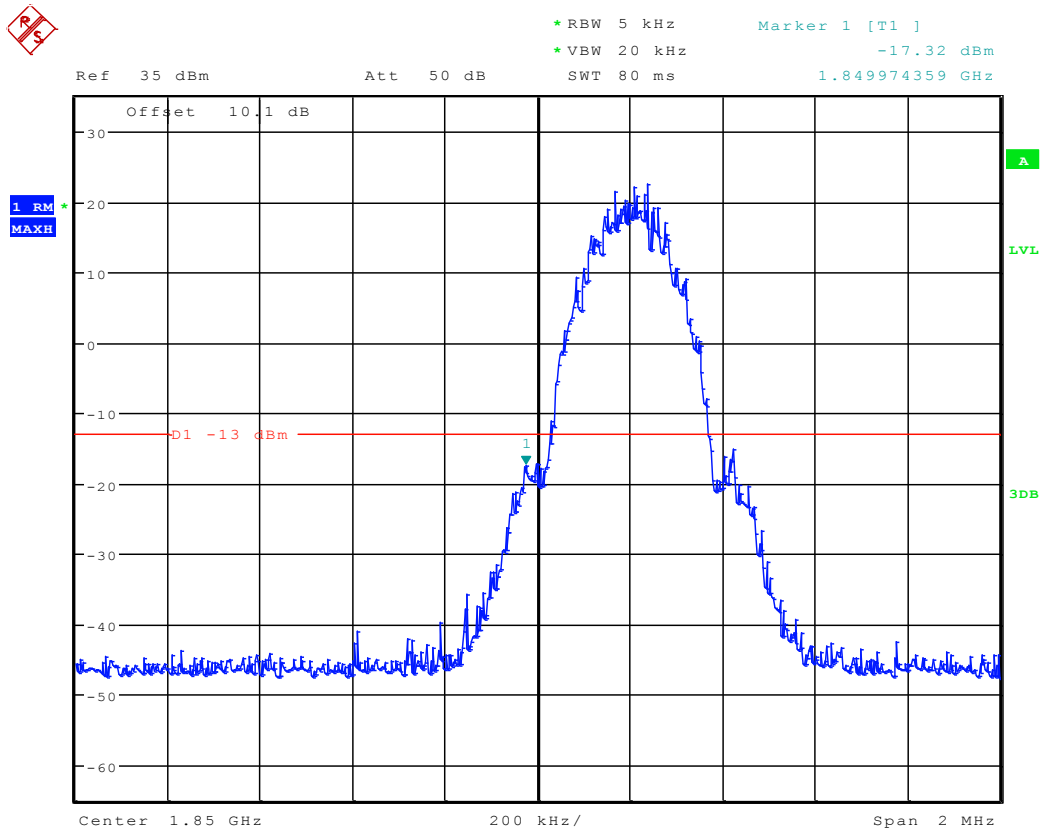

Date: 31.MAR.2012 15:56:46



Right Edge Channel 810

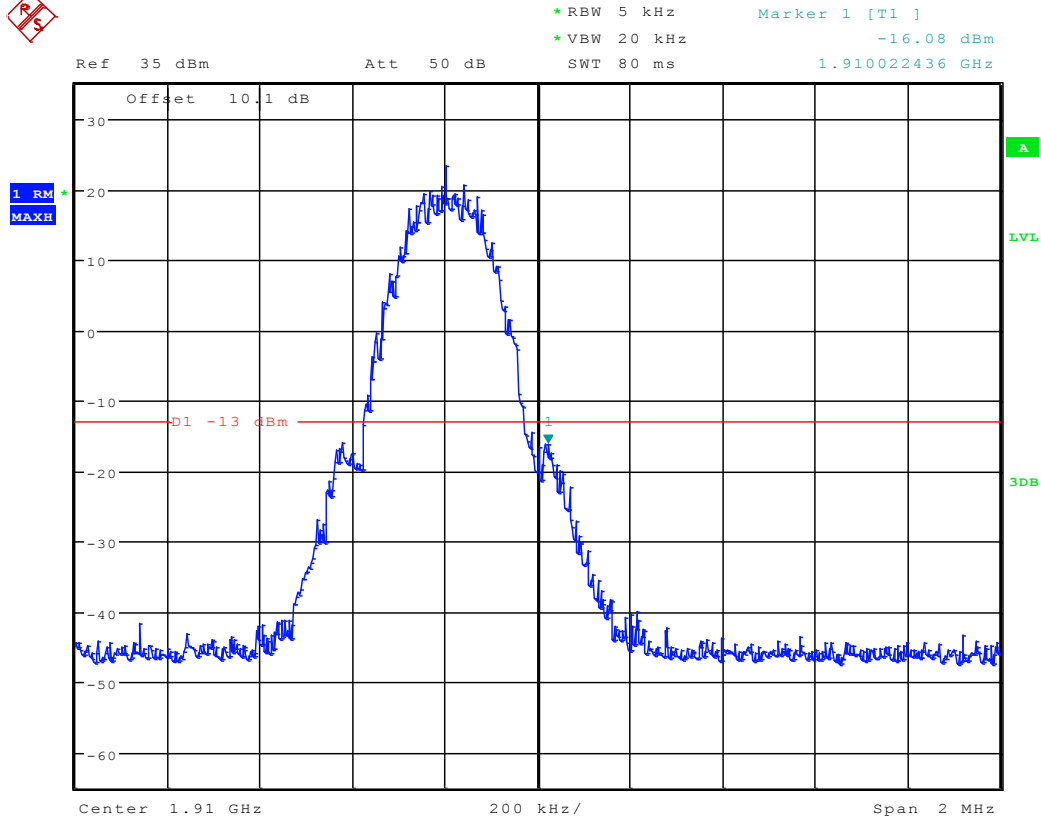

Date: 31.MAR.2012 15:57:40



TM2:EDGE

Left Edge

Channel 512



Ref 35 dBm Att 50 dB RBW 5 kHz Marker 1 [T1]
* VBW 20 kHz -21.17 dBm
SWT 80 ms 1.849977564 GHz

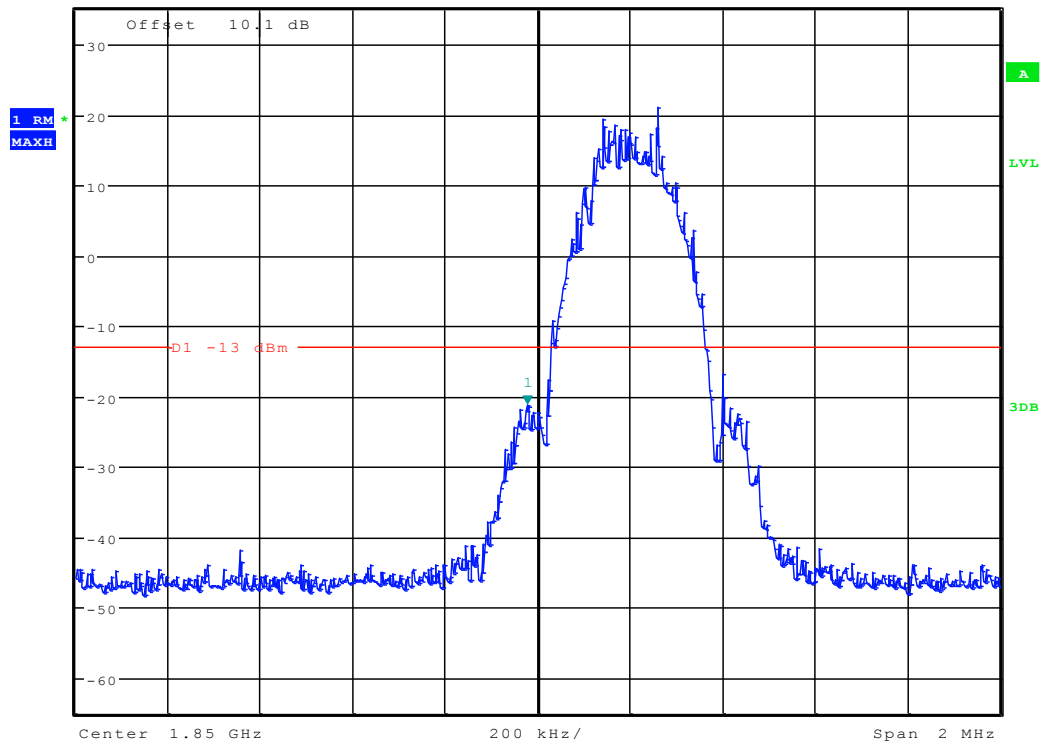

Date: 31.MAR.2012 16:00:14



TM3: WCDMA

Left Edge

Channel 9262

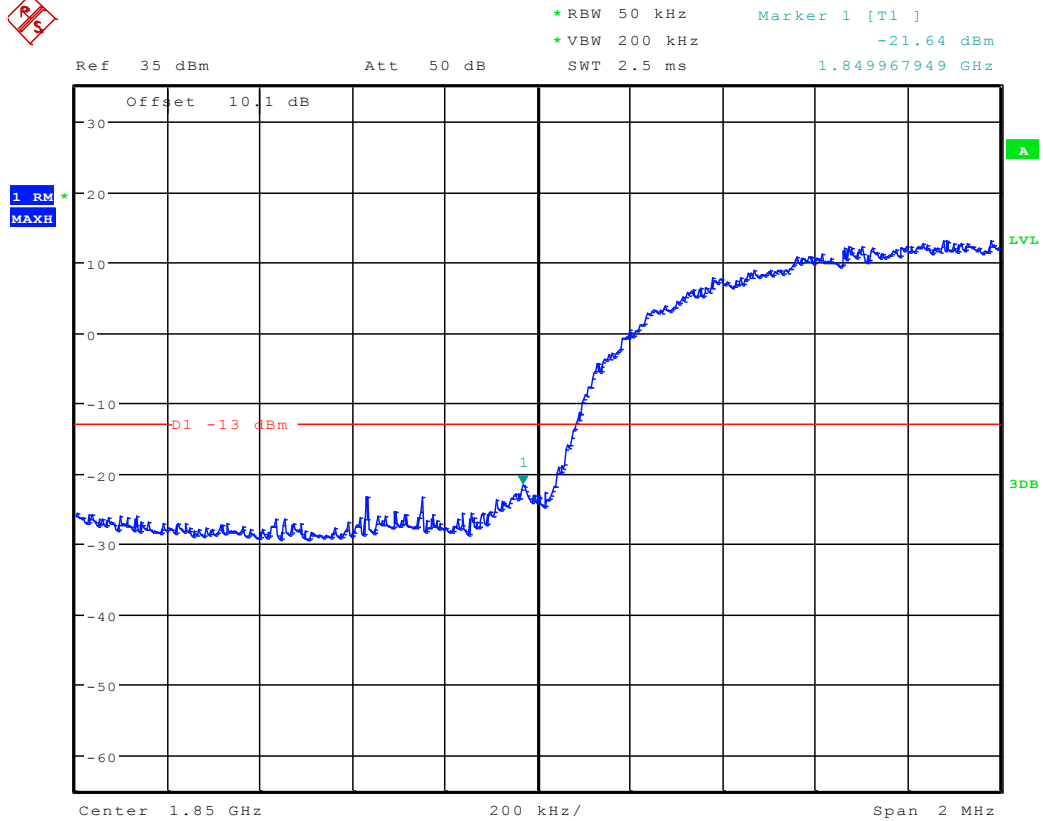

Date: 31.MAR.2012 16:18:32



Right Edge Channel 9538

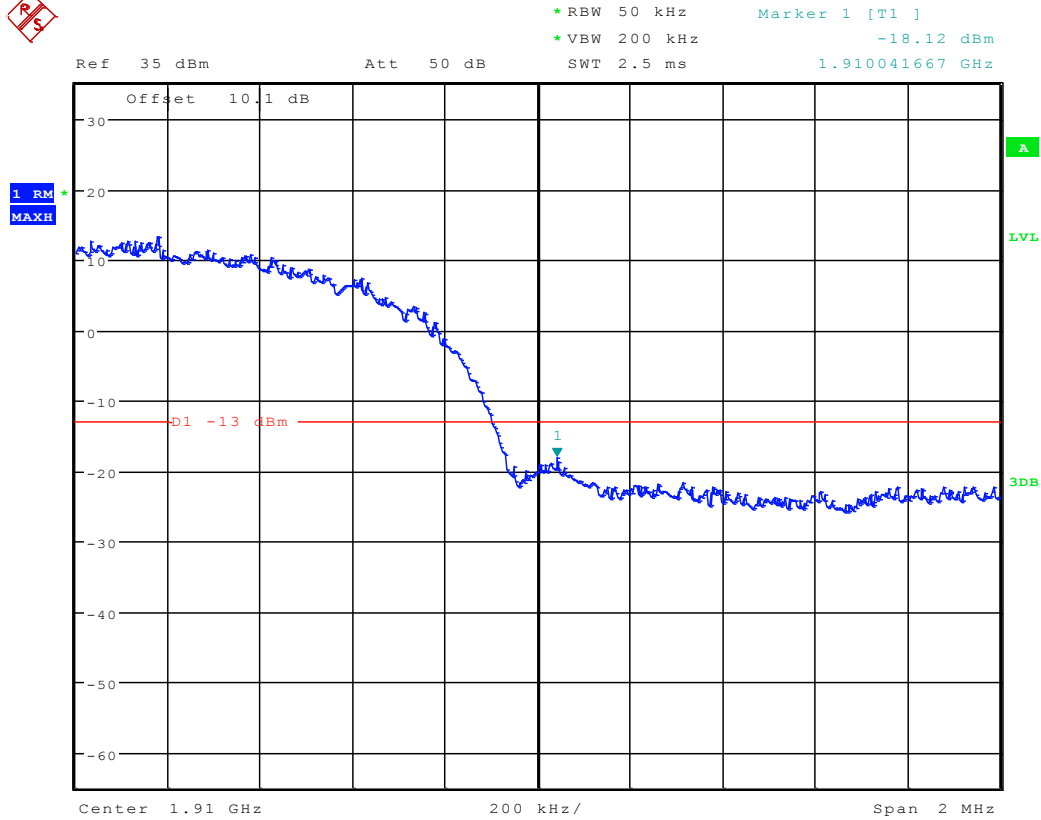

Date: 31.MAR.2012 16:19:07

-----The END-----



Appendix E

Spurious Emission at Antenna Terminal

According to FCC Part 2.1051 & Part24 Subpart E



TM1:GPRS/GSM Channel 512

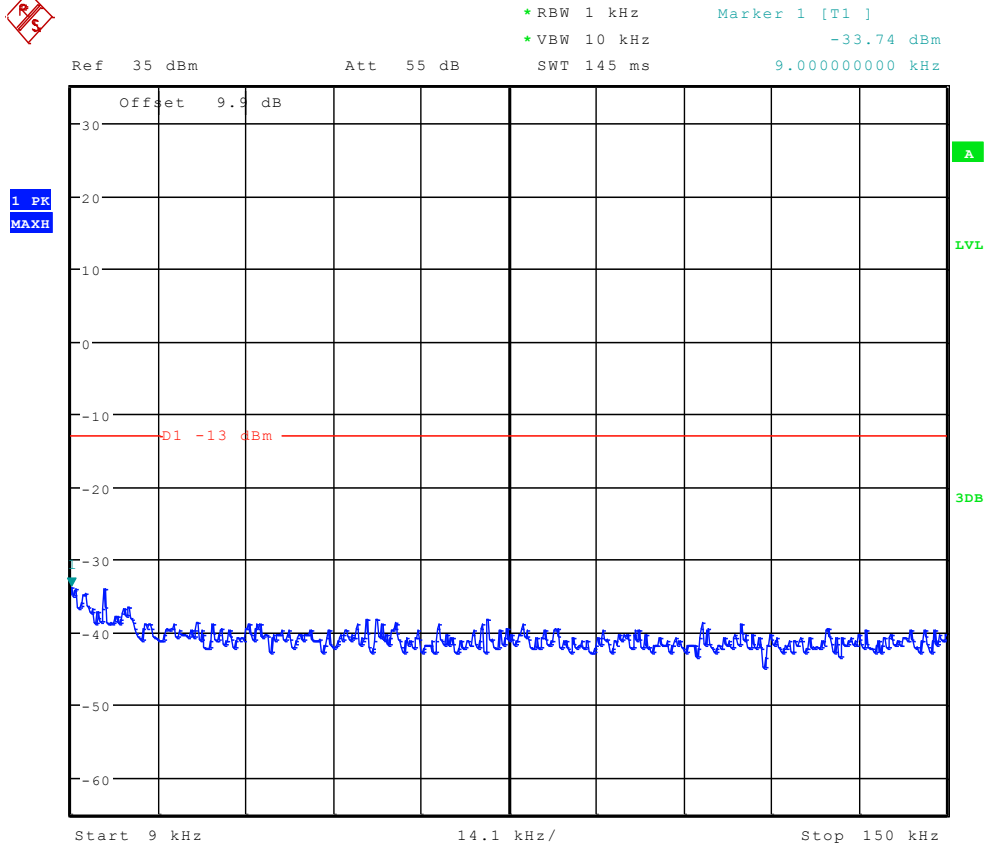

Date: 26.MAR.2012 11:12:52



Ref 35 dBm Att 55 dB SWT 300 ms 197.836538462 kHz
*RBW 10 kHz Marker 1 [T1]
*VBW 30 kHz -27.41 dBm

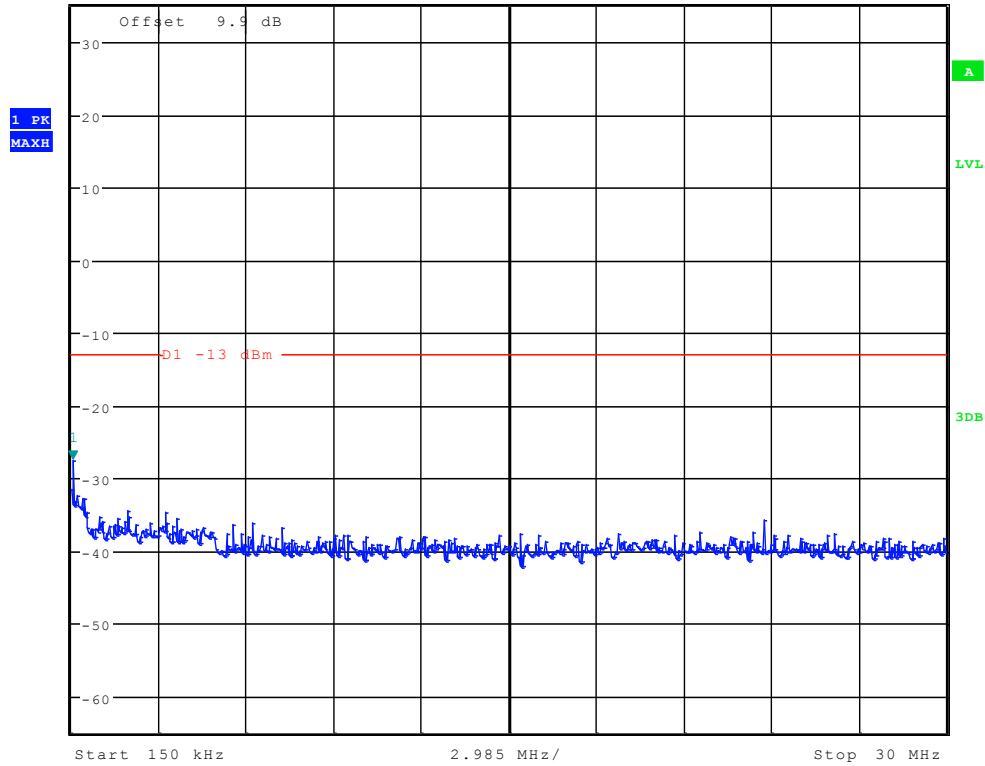

Date: 26.MAR.2012 11:13:36



Ref 35 dBm Att 50 dB SWT 115 ms
*RBW 1 MHz Marker 1 [T1] 29.81 dBm
*VBW 3 MHz
1.822179487 GHz

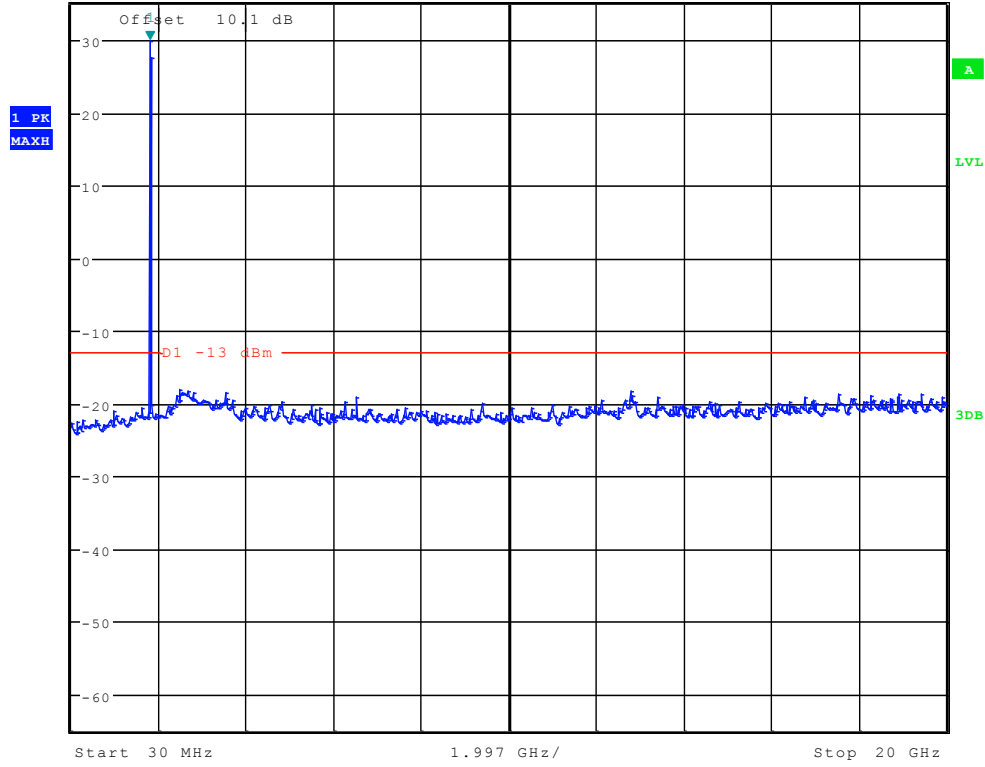

Date: 26.MAR.2012 11:14:20



Channel 661

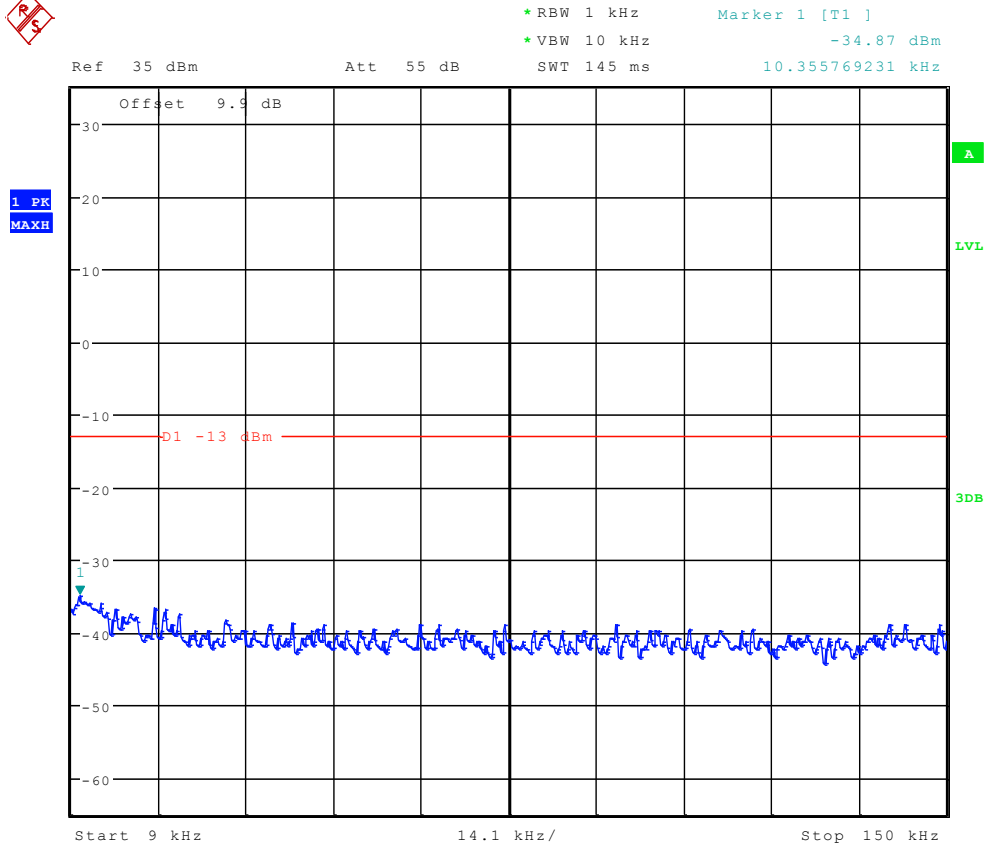

Date: 26.MAR.2012 11:13:07



Ref 35 dBm Att 55 dB SWT 300 ms 197.836538462 kHz
*RBW 10 kHz Marker 1 [T1]
*VBW 30 kHz -29.43 dBm

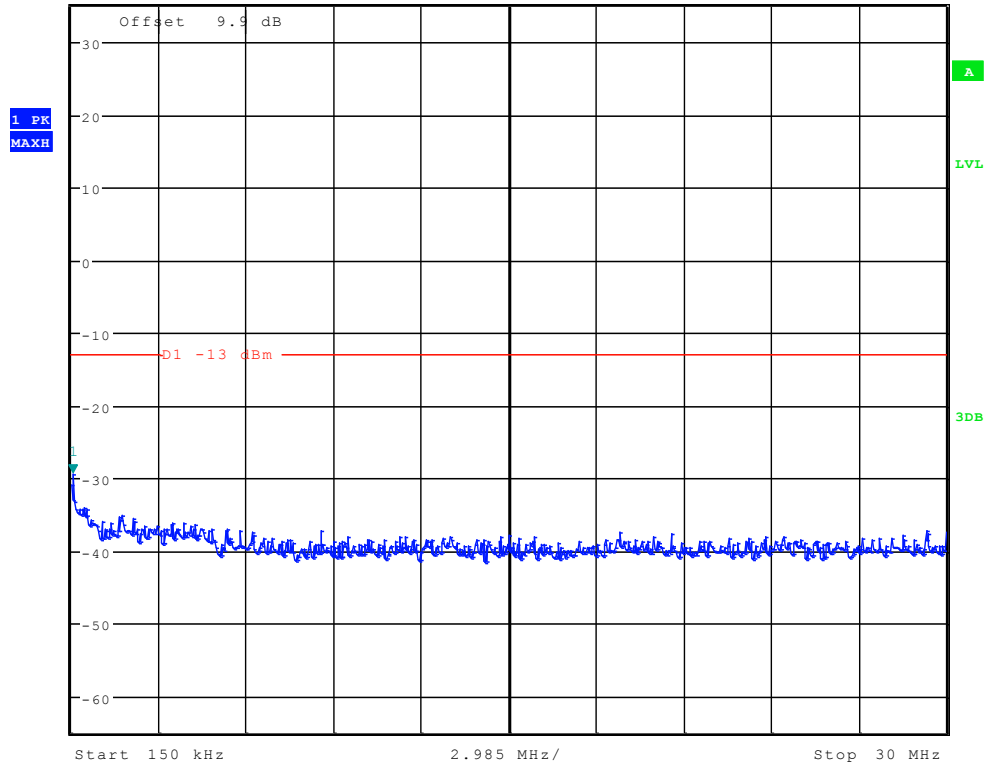

Date: 26.MAR.2012 11:13:51



Ref 35 dBm Att 50 dB SWT 115 ms
*RBW 1 MHz Marker 1 [T1] 29.39 dBm
*VBW 3 MHz 1.854182692 GHz

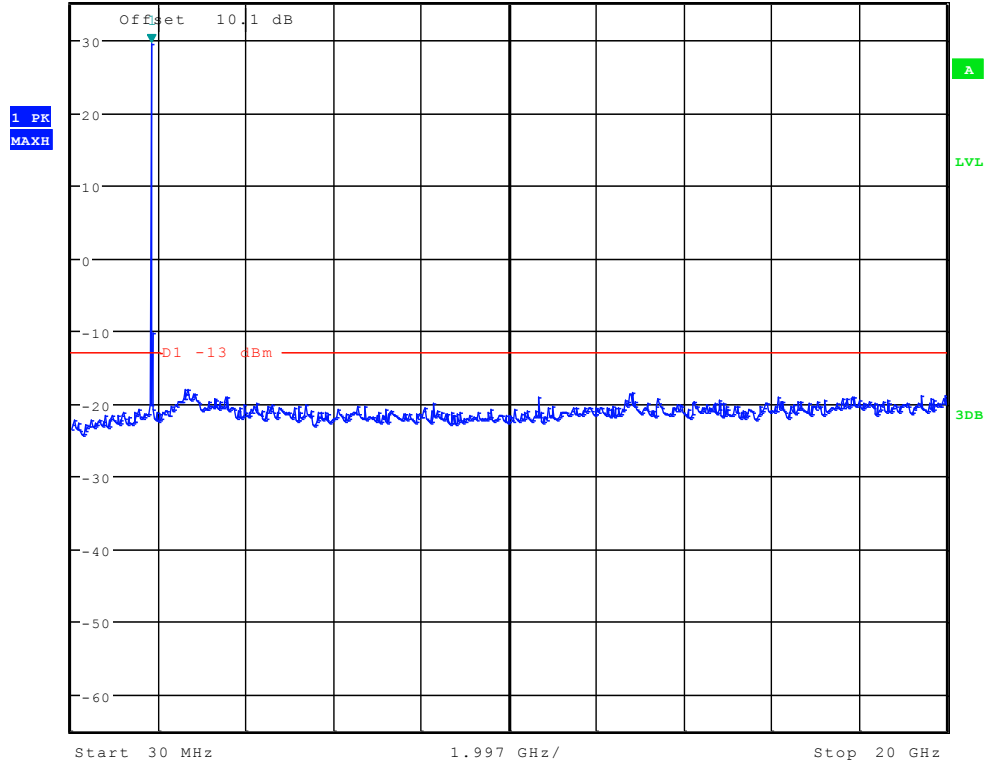

Date: 26.MAR.2012 11:14:34



Channel 810

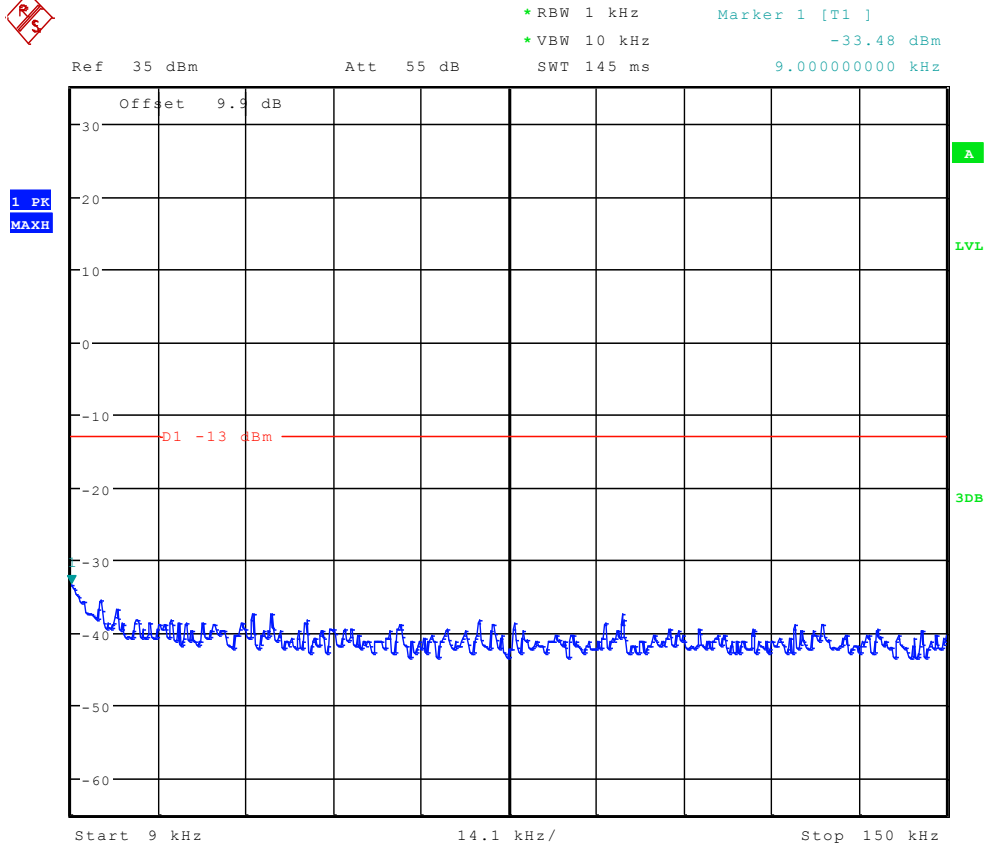

Date: 26.MAR.2012 11:13:22



Ref 35 dBm Att 55 dB SWT 300 ms 197.836538462 kHz
*RBW 10 kHz Marker 1 [T1]
*VBW 30 kHz -30.04 dBm

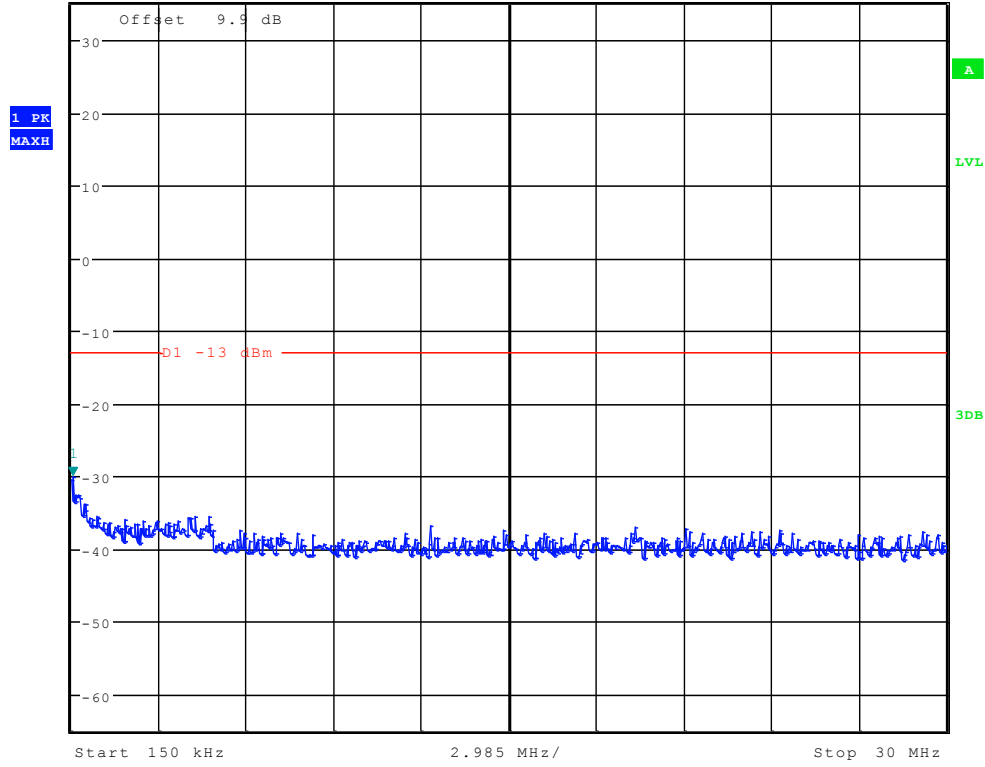

Date: 26.MAR.2012 11:14:05



Ref 35 dBm Att 50 dB SWT 115 ms Marker 1 [T1]
*RBW 1 MHz 30.05 dBm
*VBW 3 MHz
1.886185897 GHz

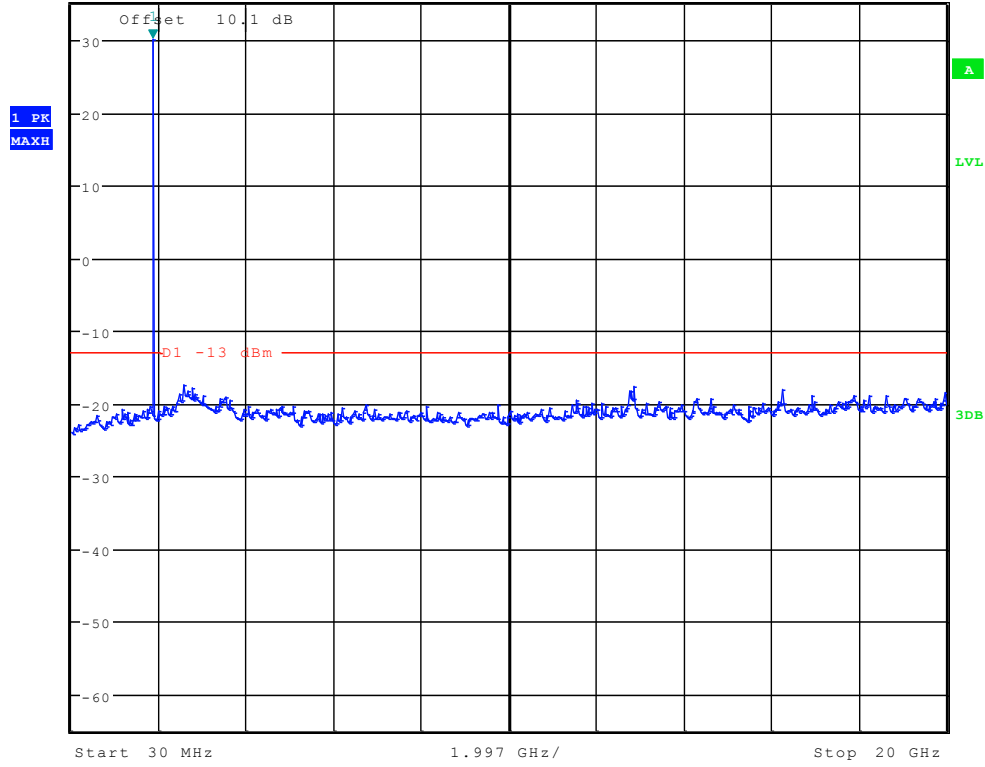

Date: 26.MAR.2012 11:14:49



TM2:EDGE Channel 512

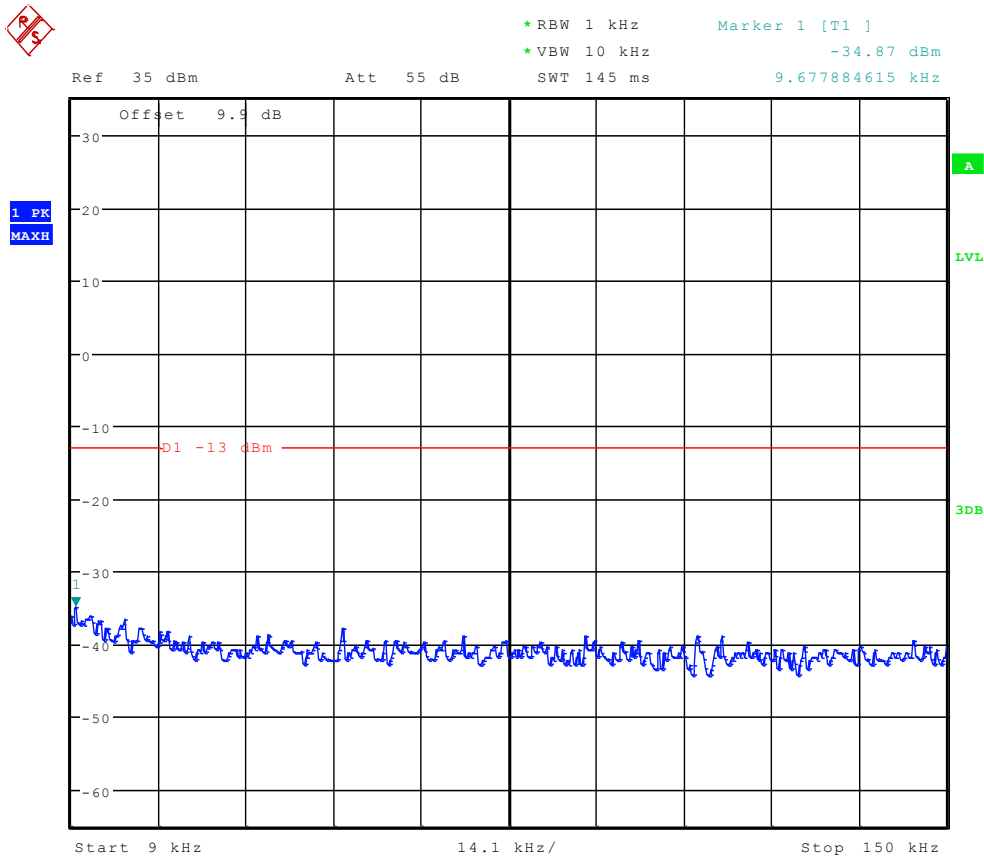

Date: 26.MAR.2012 11:20:15



Ref 35 dBm Att 55 dB SWT 300 ms 150.00000000 kHz
 *RBW 10 kHz Marker 1 [T1] -29.87 dBm
 *VBW 30 kHz

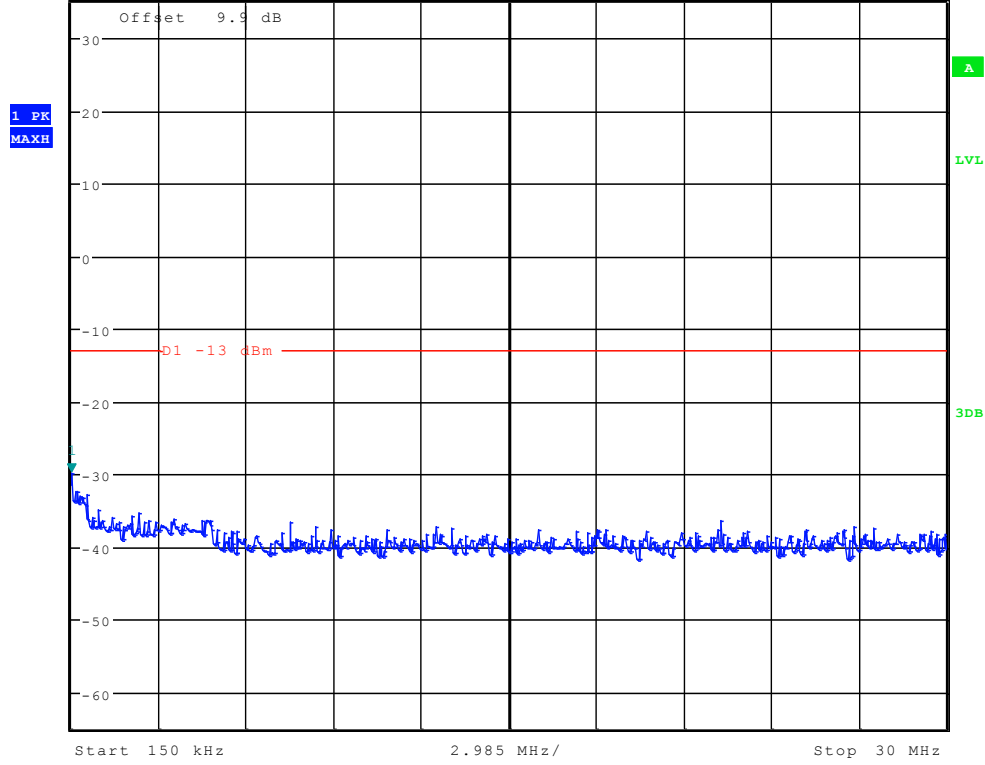

Date: 26.MAR.2012 11:20:58



Ref 35 dBm Att 50 dB SWT 115 ms Marker 1 [T1]
*RBW 1 MHz 22.56 dBm
*VBW 3 MHz 1.822179487 GHz

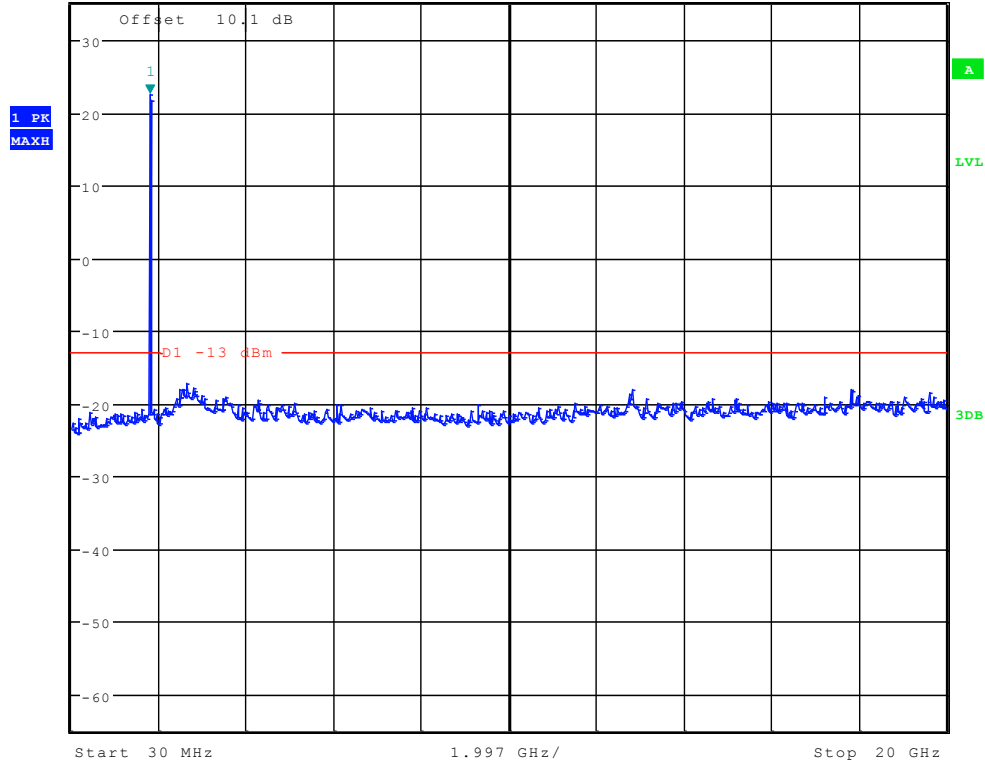

Date: 26.MAR.2012 11:21:42



Channel 661

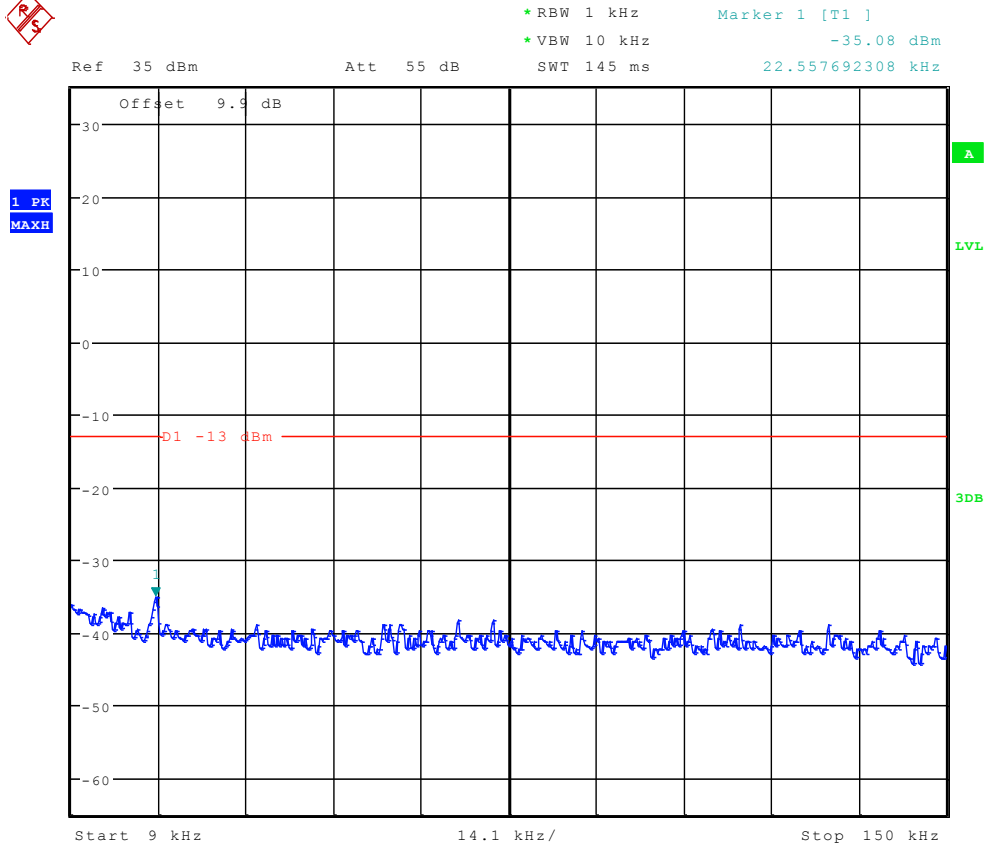

Date: 26.MAR.2012 11:20:29



Ref 35 dBm Att 55 dB SWT 300 ms 150.00000000 kHz
*RBW 10 kHz Marker 1 [T1]
*VBW 30 kHz -29.64 dBm

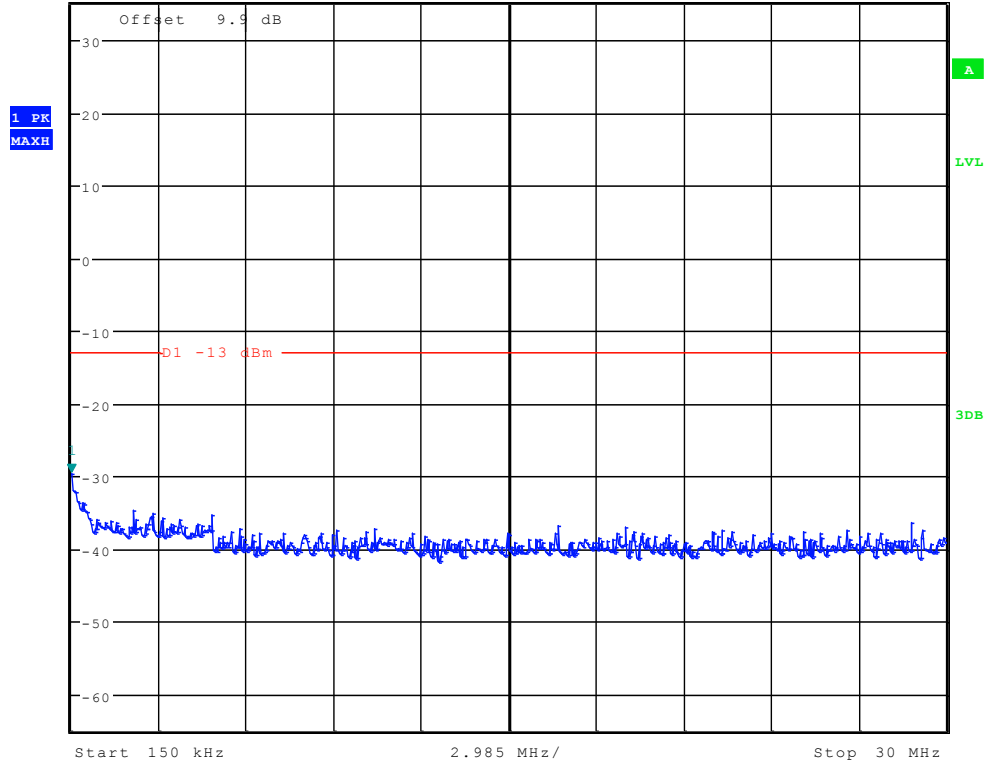

Date: 26.MAR.2012 11:21:13



Ref 35 dBm Att 50 dB SWT 115 ms
*RBW 1 MHz Marker 1 [T1] 28.47 dBm
*VBW 3 MHz 1.854182692 GHz

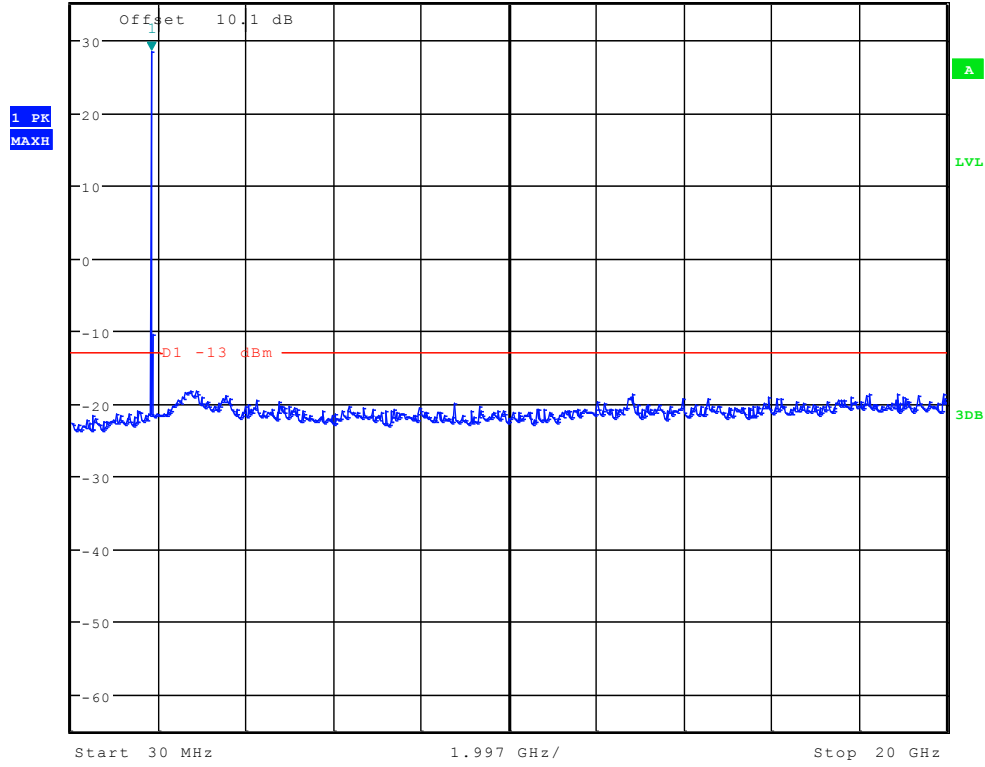

Date: 26.MAR.2012 11:21:56



Channel 810

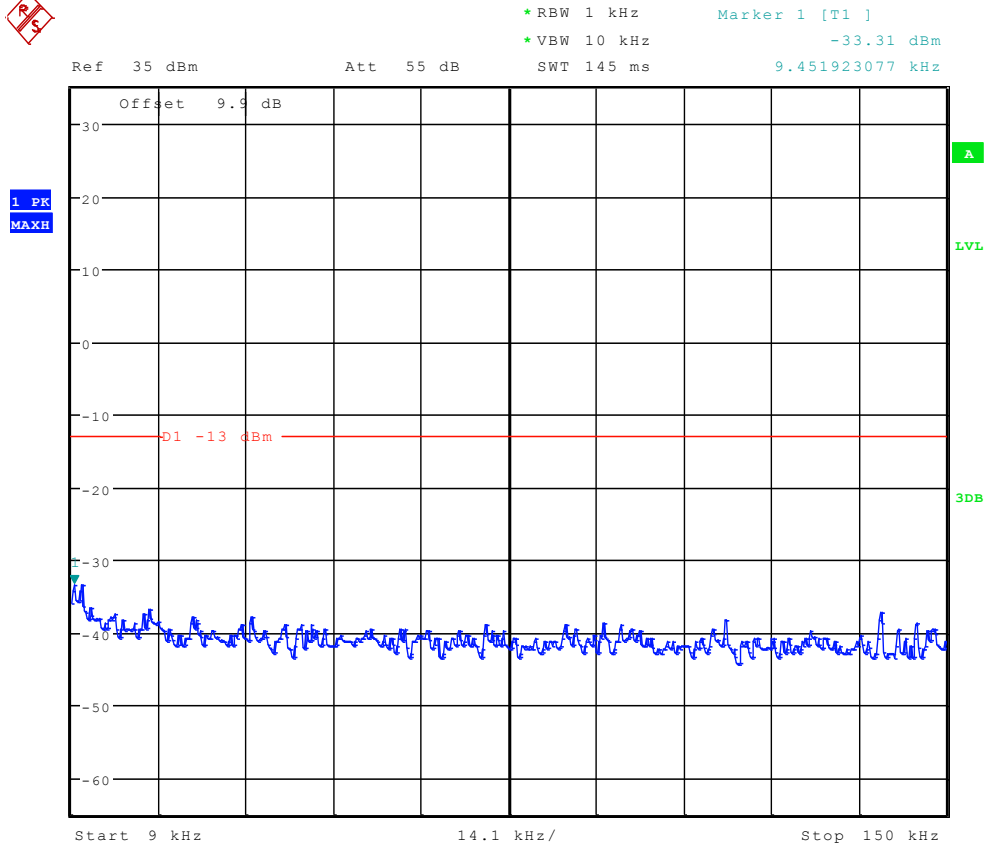

Date: 26.MAR.2012 11:20:43



Ref 35 dBm Att 55 dB SWT 300 ms 197.836538462 kHz
*RBW 10 kHz Marker 1 [T1]
*VBW 30 kHz -28.13 dBm

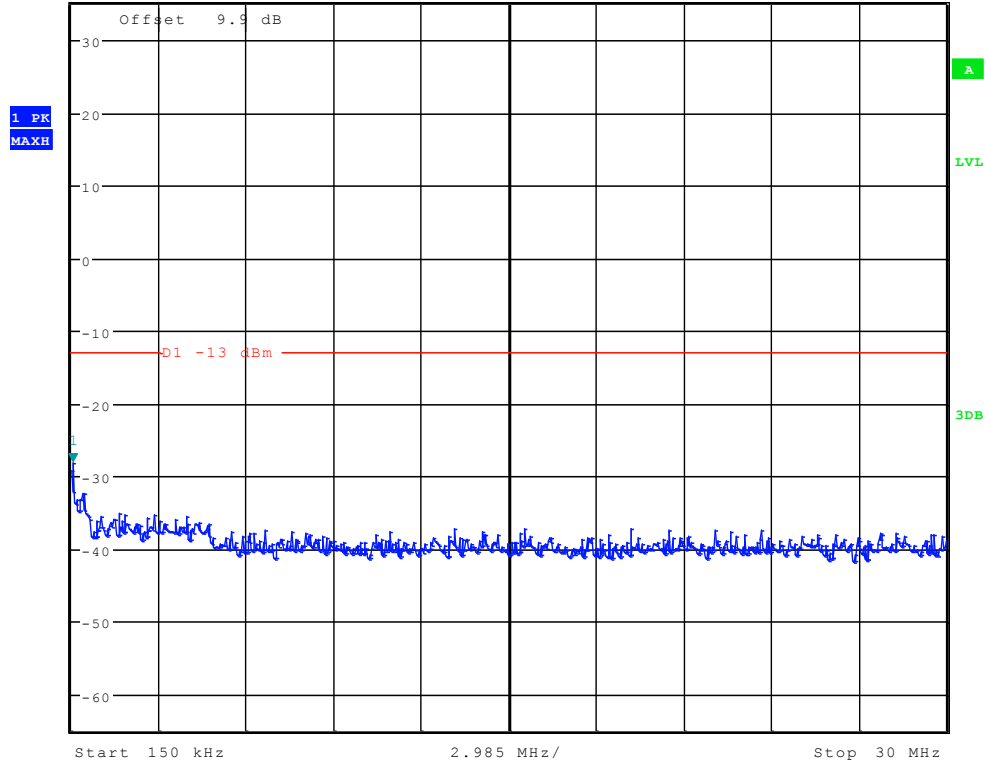

Date: 26.MAR.2012 11:21:27



Ref 35 dBm Att 50 dB SWT 115 ms
*RBW 1 MHz Marker 1 [T1] 22.85 dBm
*VBW 3 MHz
1.886185897 GHz

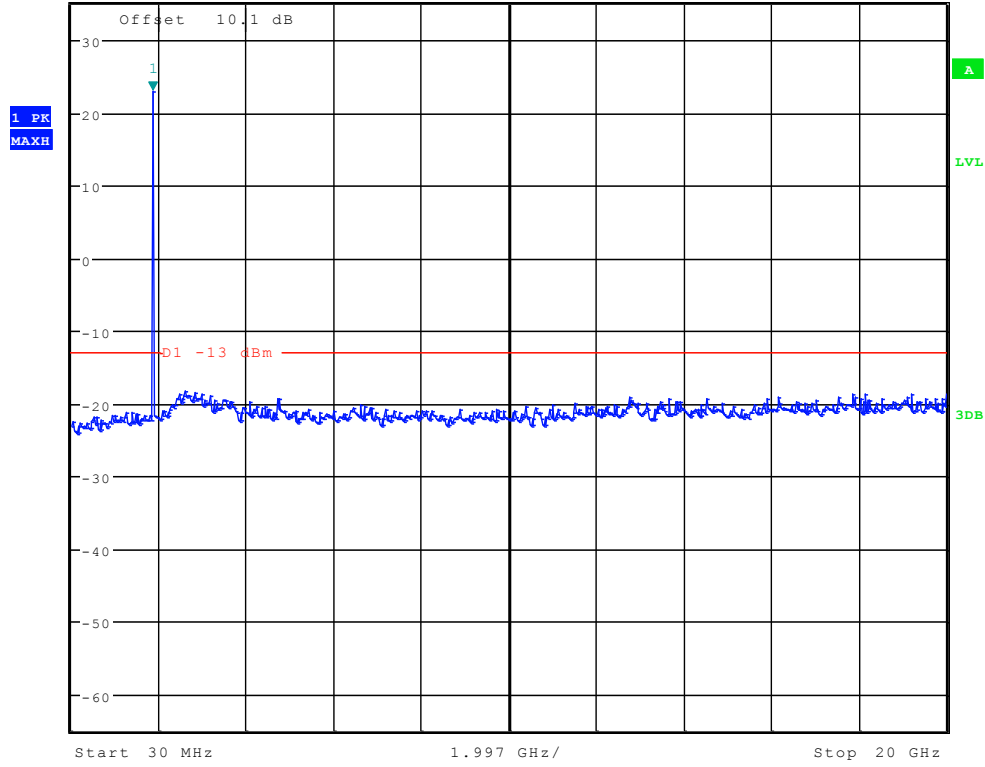

Date: 26.MAR.2012 11:22:11



TM3: WCDMA Channel 9262

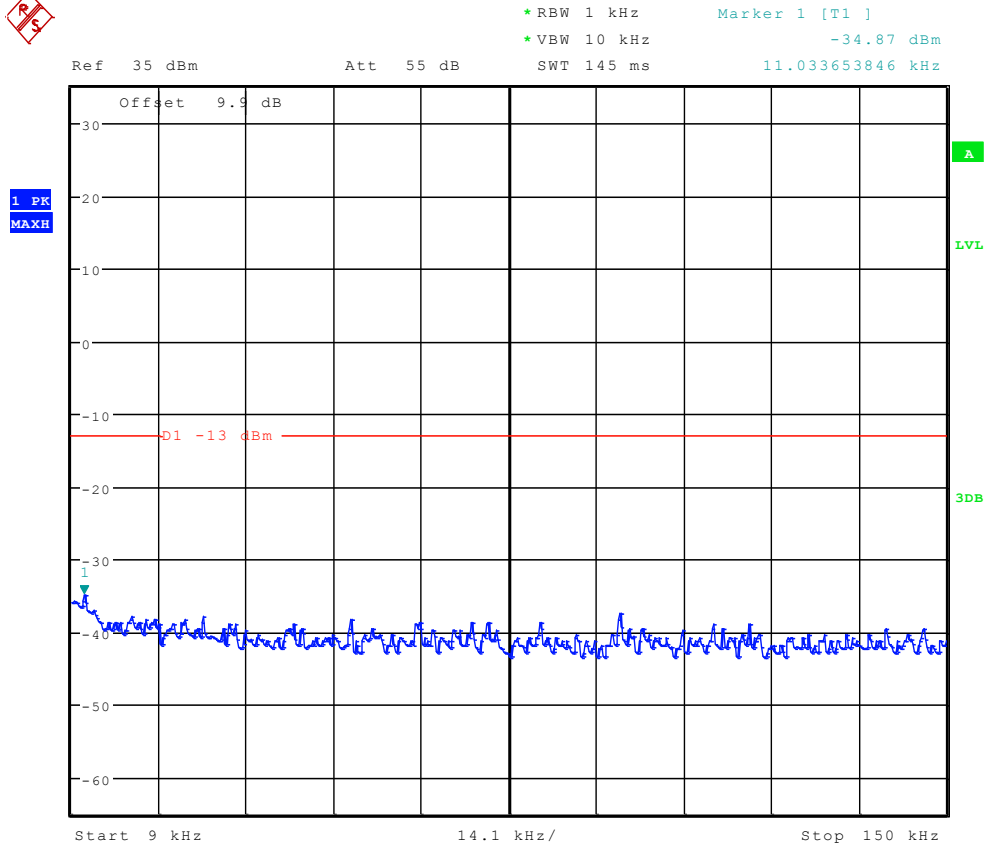

Date: 26.MAR.2012 11:32:57



Ref 35 dBm Att 55 dB SWT 300 ms 150.00000000 kHz
*RBW 10 kHz Marker 1 [T1]
*VBW 30 kHz -27.85 dBm

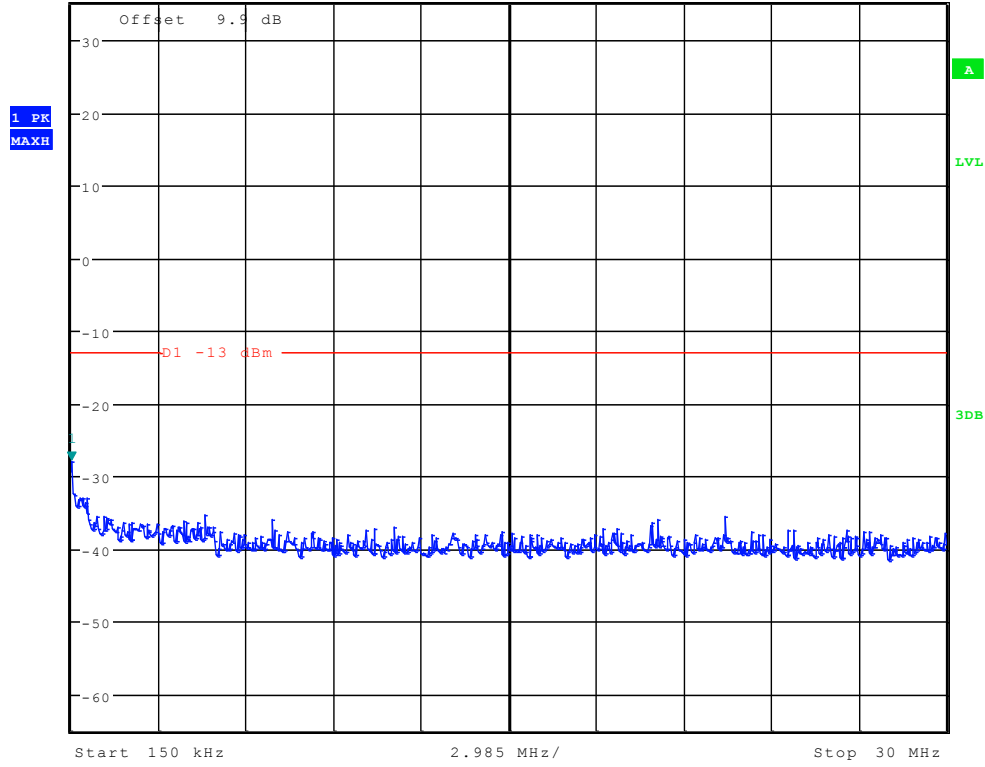

Date: 26.MAR.2012 11:33:41



Ref 35 dBm Att 50 dB SWT 115 ms
*RBW 1 MHz Marker 1 [T1] 22.57 dBm
*VBW 3 MHz 1.854182692 GHz

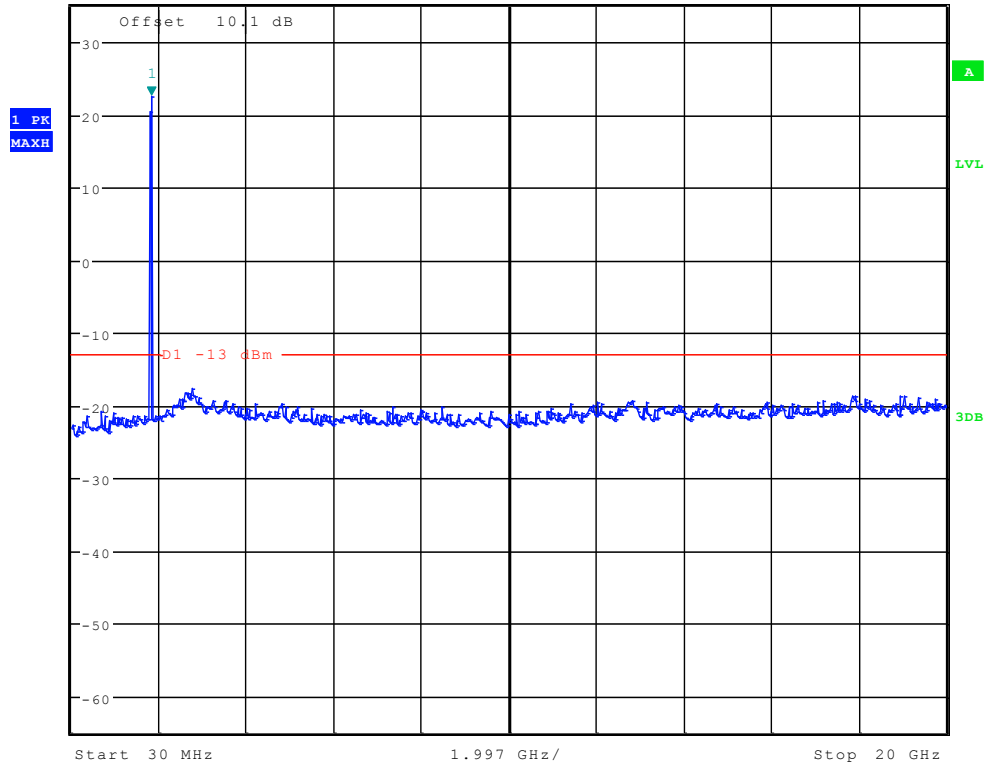

Date: 26.MAR.2012 11:34:24



Channel 9400

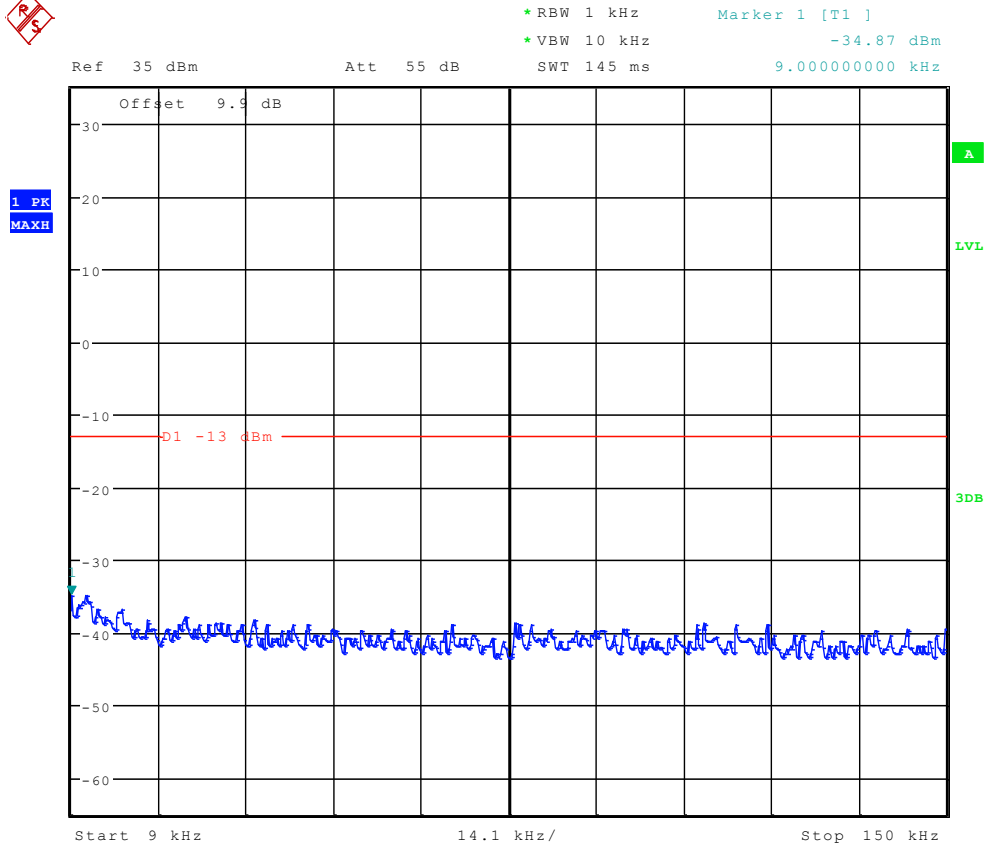

Date: 26.MAR.2012 11:33:11



Ref 35 dBm Att 55 dB SWT 300 ms 150.00000000 kHz
*RBW 10 kHz Marker 1 [T1]
*VBW 30 kHz -29.32 dBm

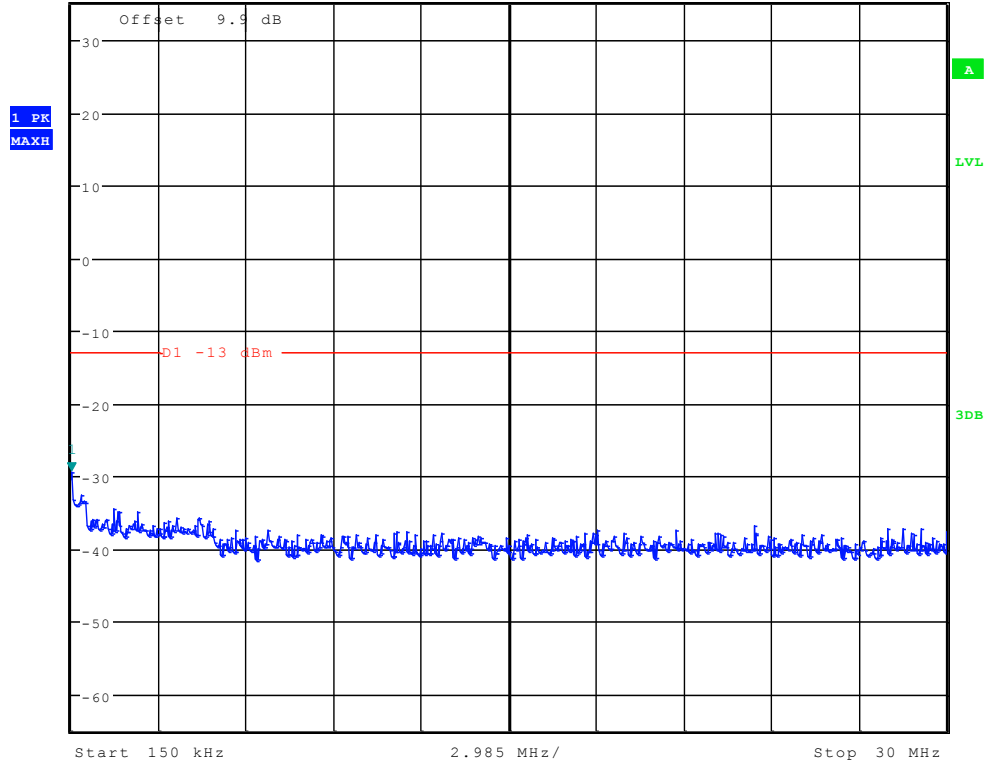

Date: 26.MAR.2012 11:33:55



Ref 35 dBm Att 50 dB SWT 115 ms
*RBW 1 MHz Marker 1 [T1] 22.45 dBm
*VBW 3 MHz 1.854182692 GHz

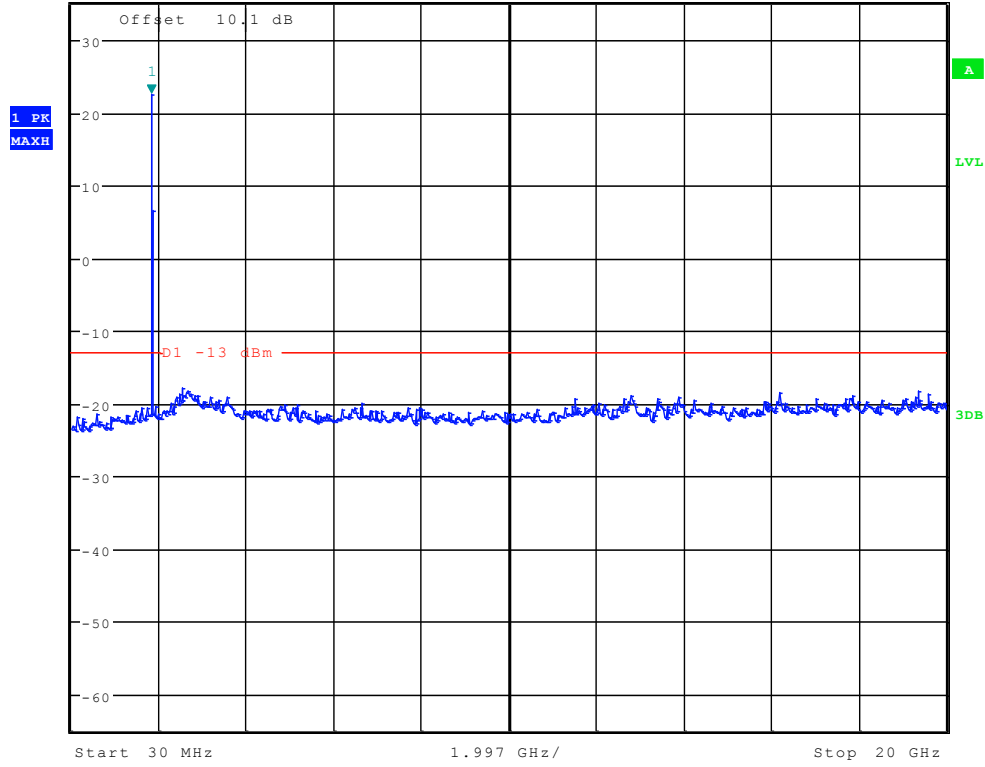

Date: 26.MAR.2012 11:34:39



Channel 9538

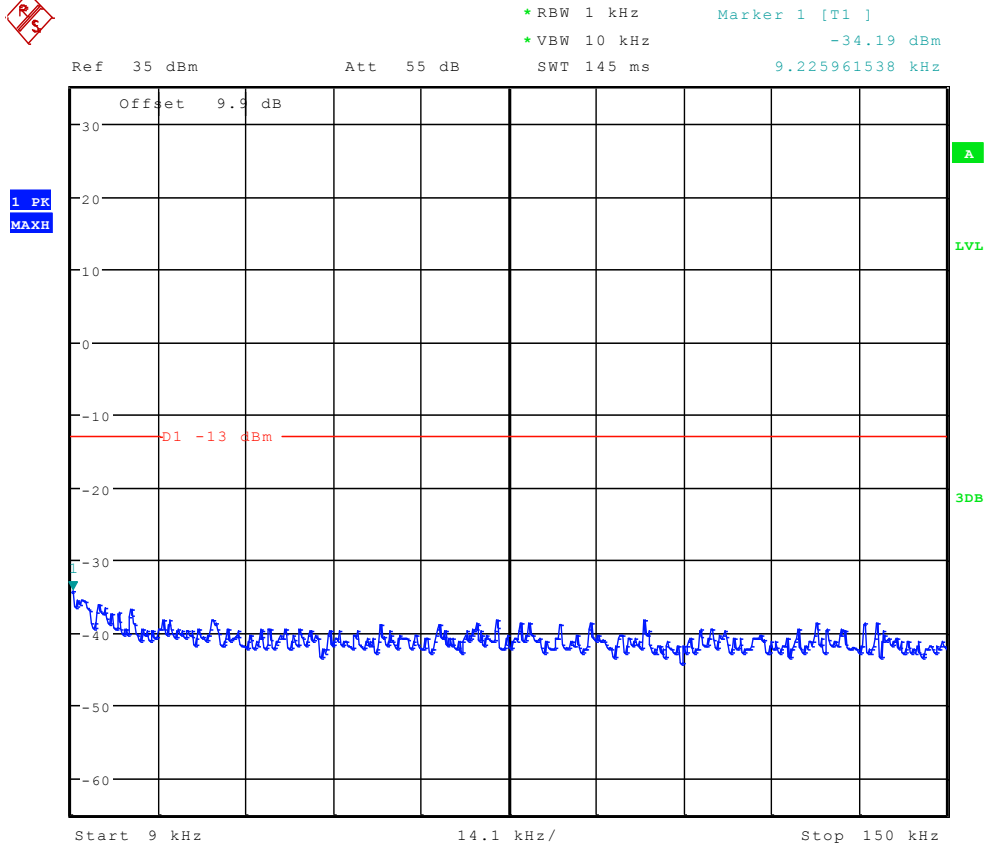

Date: 26.MAR.2012 11:33:26



Ref 35 dBm Att 55 dB SWT 300 ms 197.836538462 kHz
*RBW 10 kHz Marker 1 [T1]
*VBW 30 kHz -30.28 dBm

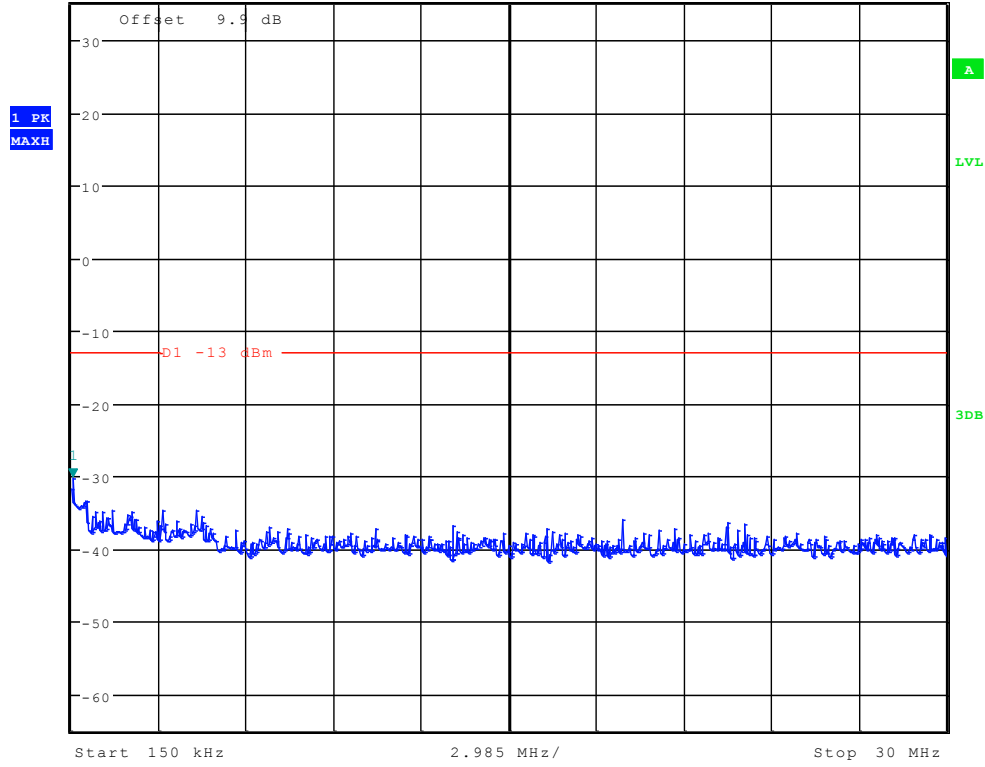

Date: 26.MAR.2012 11:34:09



Ref 35 dBm Att 50 dB SWT 115 ms
 *RBW 1 MHz Marker 1 [T1] 22.63 dBm
 *VBW 3 MHz 1.886185897 GHz

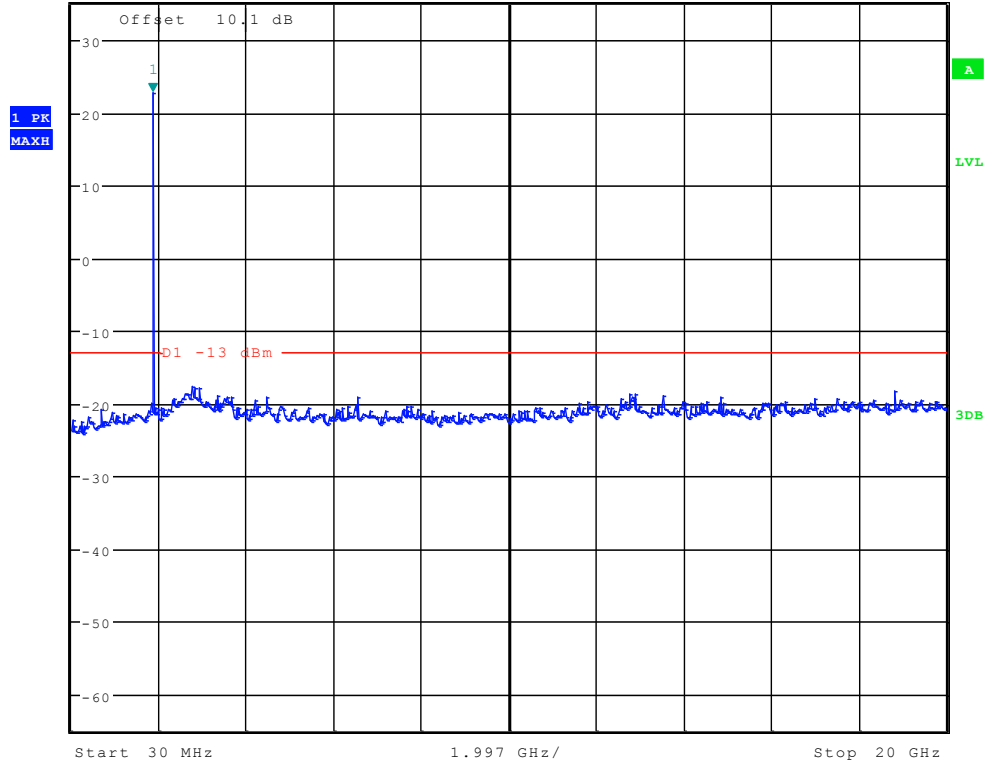

Date: 26.MAR.2012 11:34:53

-----The END-----

--



Appendix F

Field Strength of Spurious Emissions

According to FCC Part 2.1053 & Part24.238



GSM 1900

Traffic Mode (9kHz-30MHz)

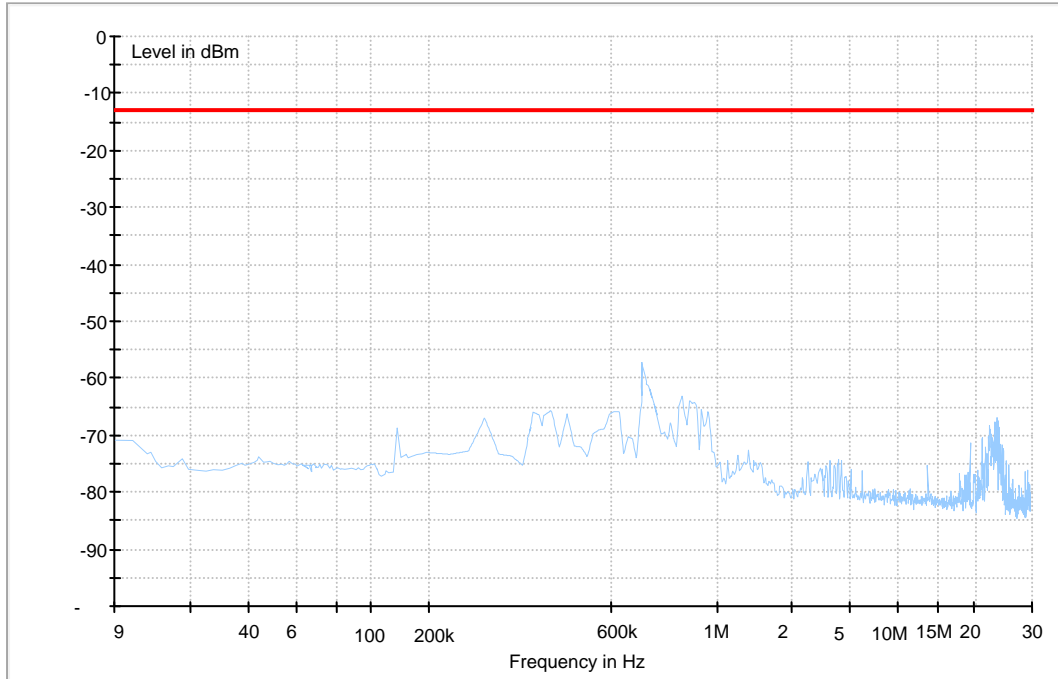



Traffic Mode (30MHz-3GHz)

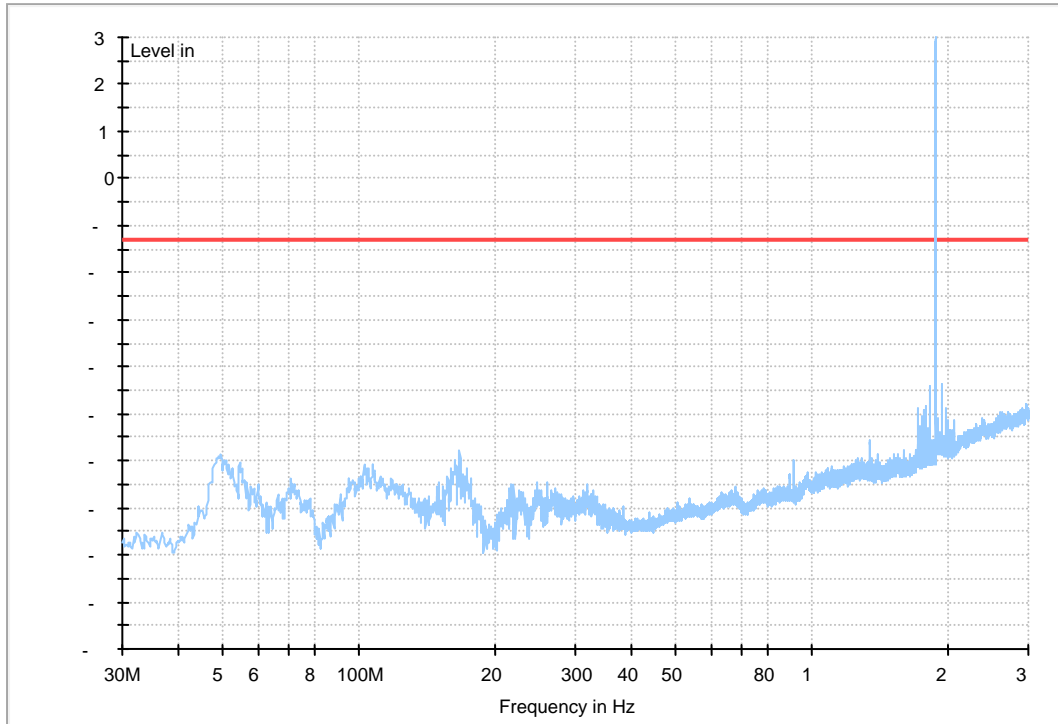



Traffic Mode (3GHz-18GHz)

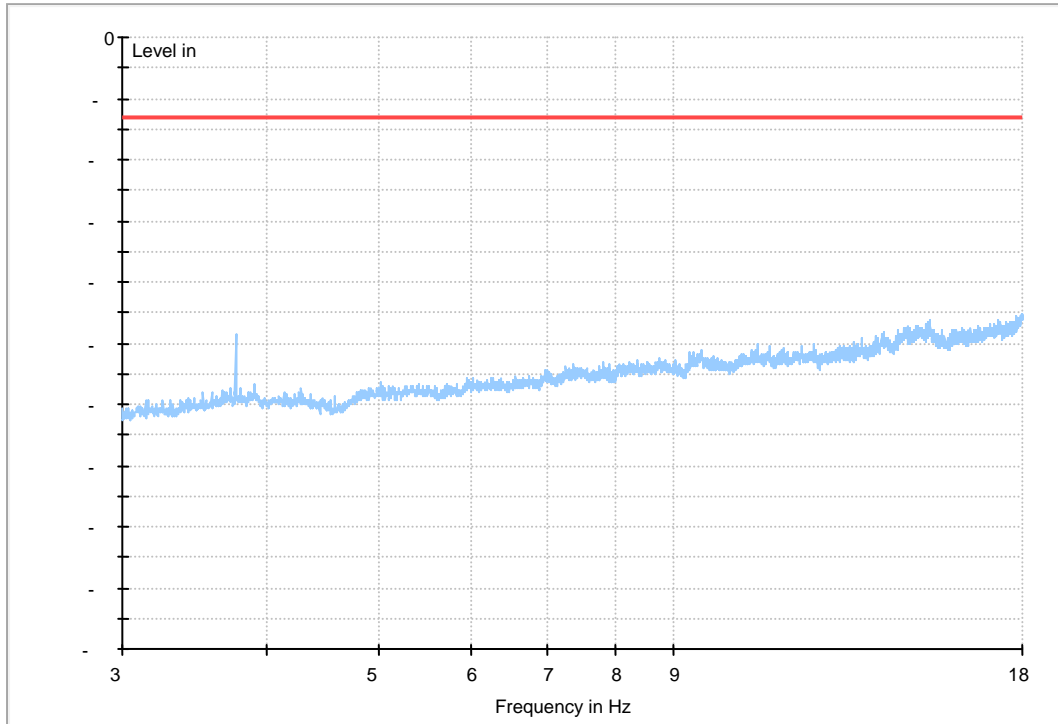



Traffic Mode (18GHz-26.5GHz)

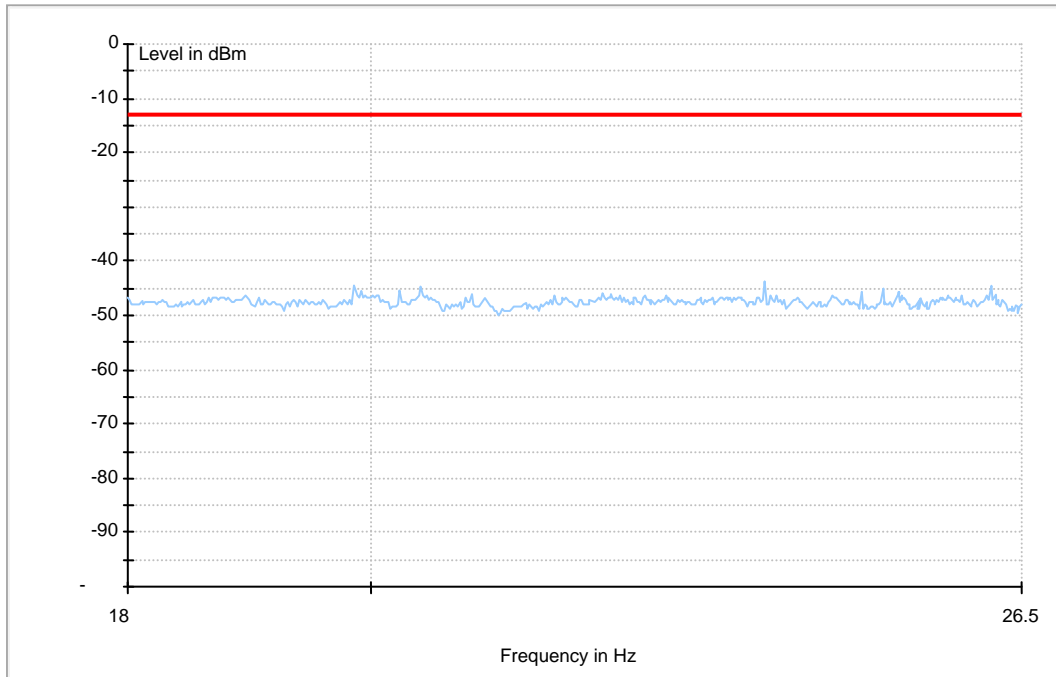



GPRS1900

Traffic Mode (9kHz-30MHz)

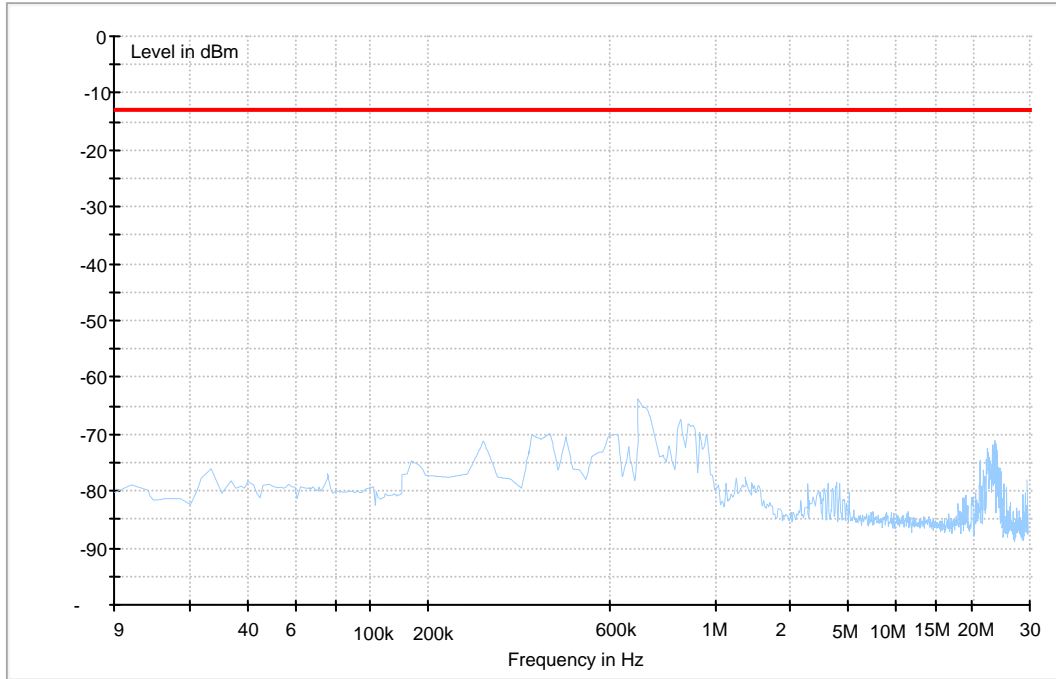



Traffic Mode (30MHz-3GHz)

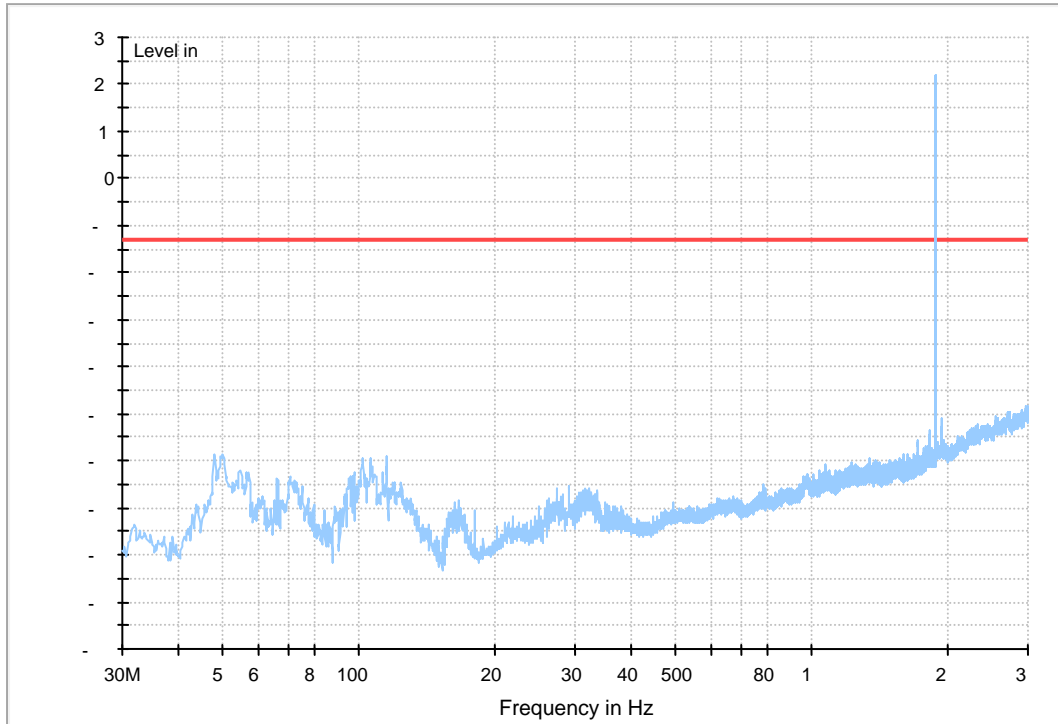



Traffic Mode (3GHz-18GHz)

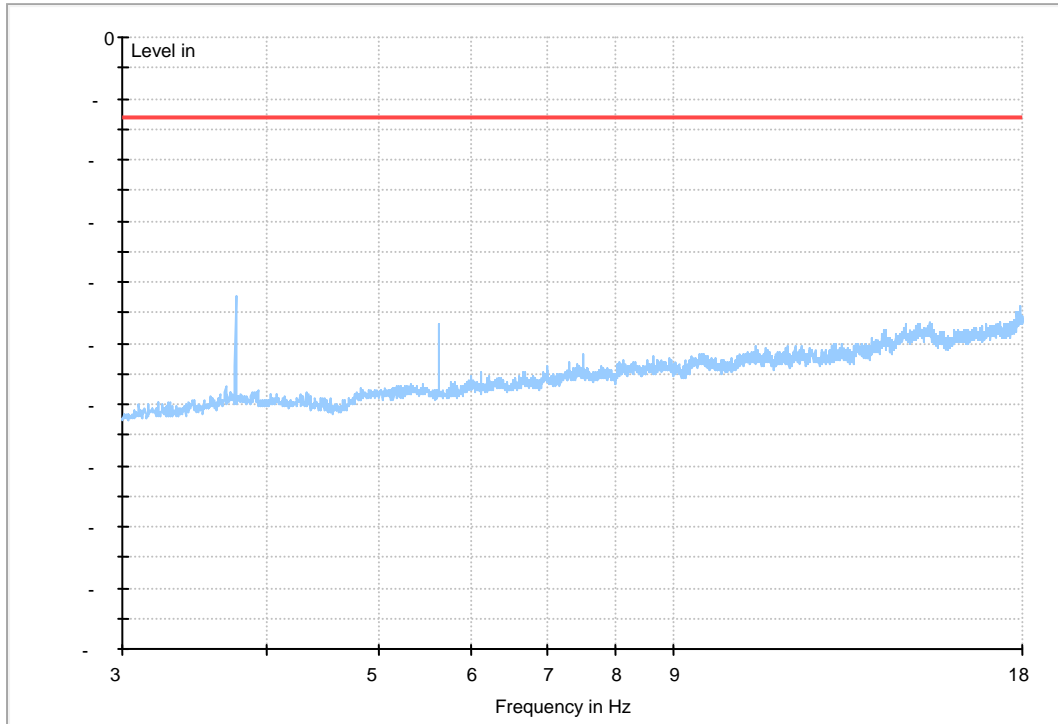



Traffic Mode (18GHz-26.5GHz)

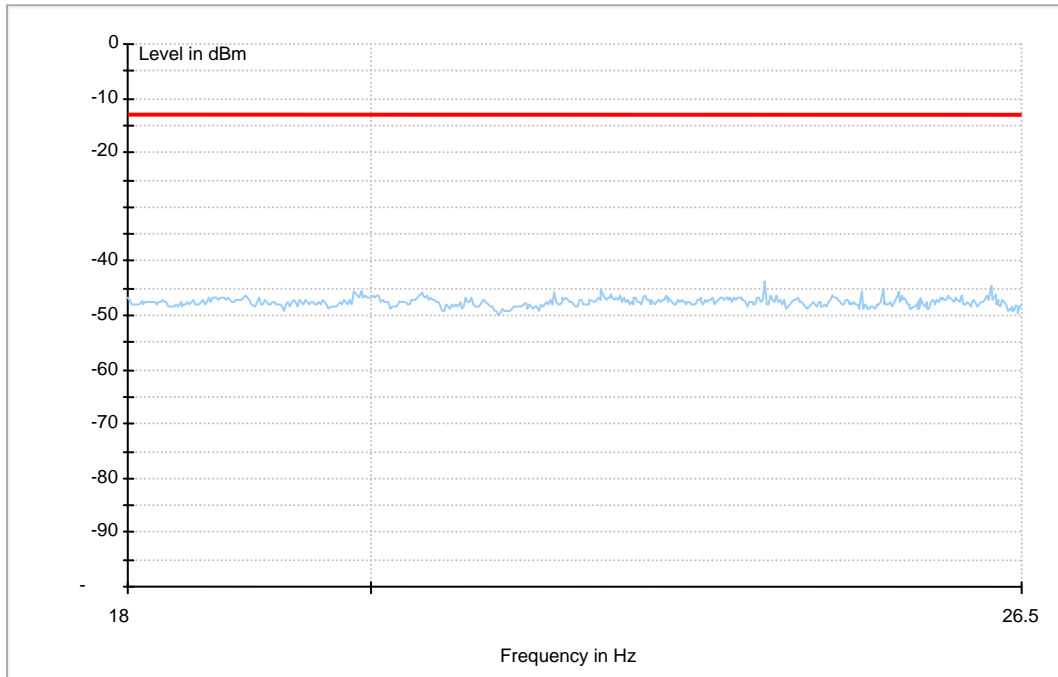



EDGE 1900

Traffic Mode (9kHz-30MHz)

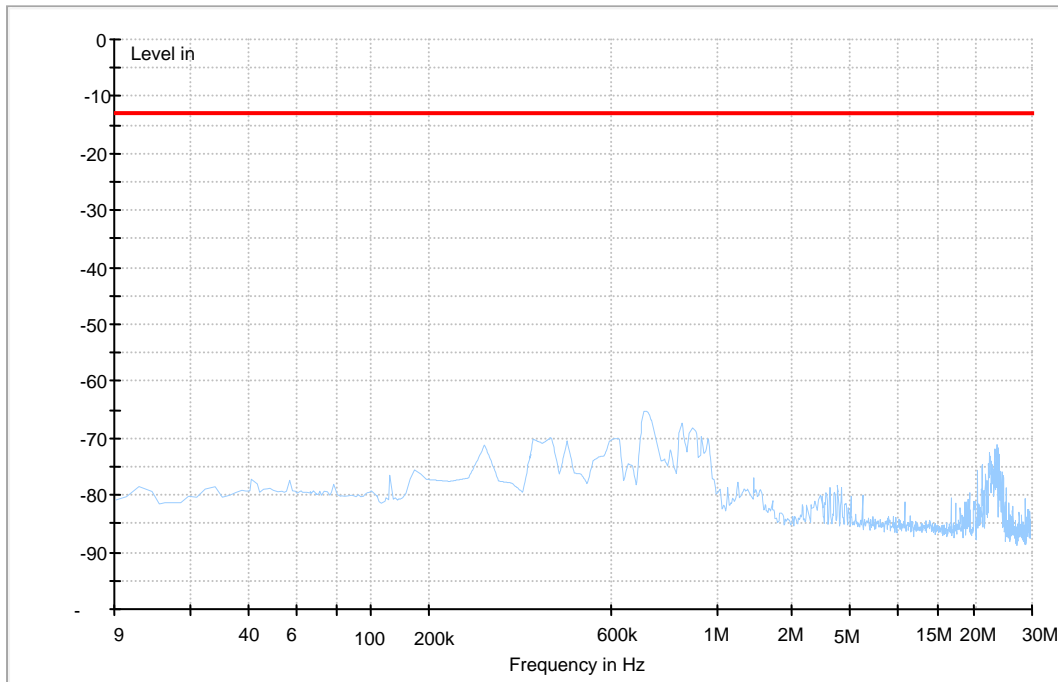



Traffic Mode (30MHz-3GHz)

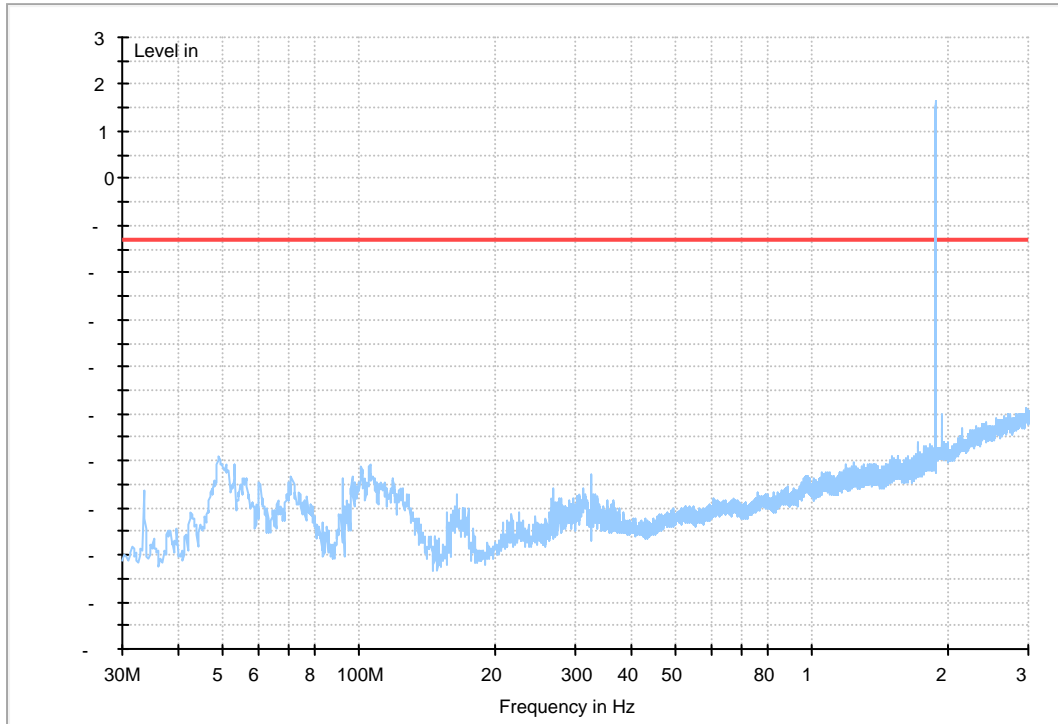



Traffic Mode (3GHz-18GHz)

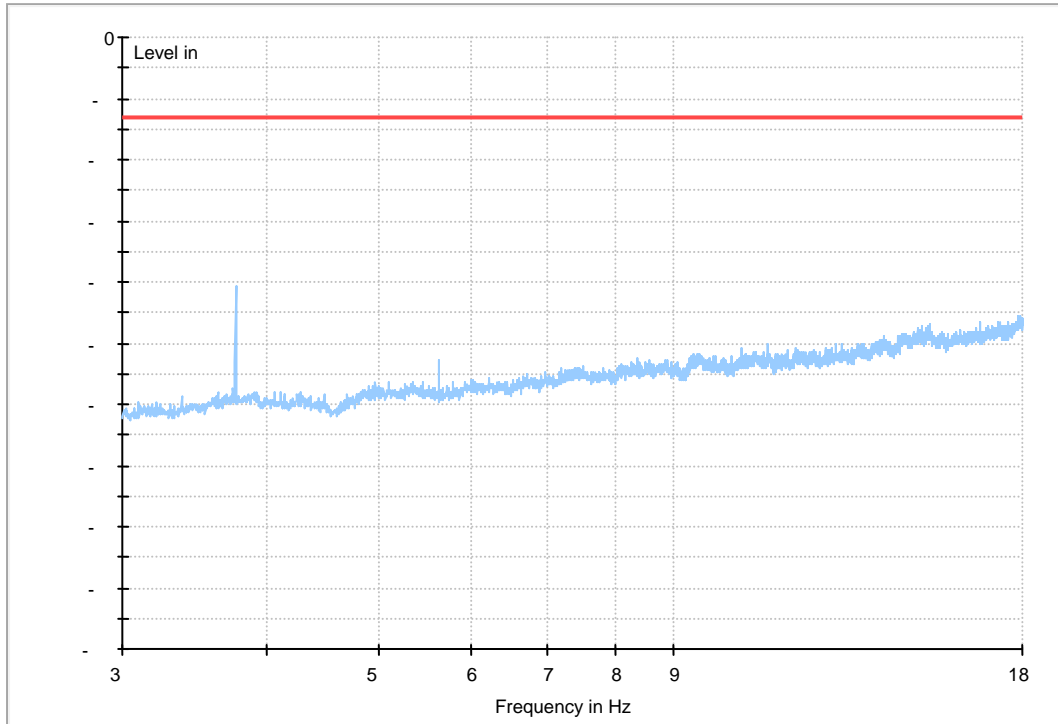



Traffic Mode (18GHz-26.5GHz)

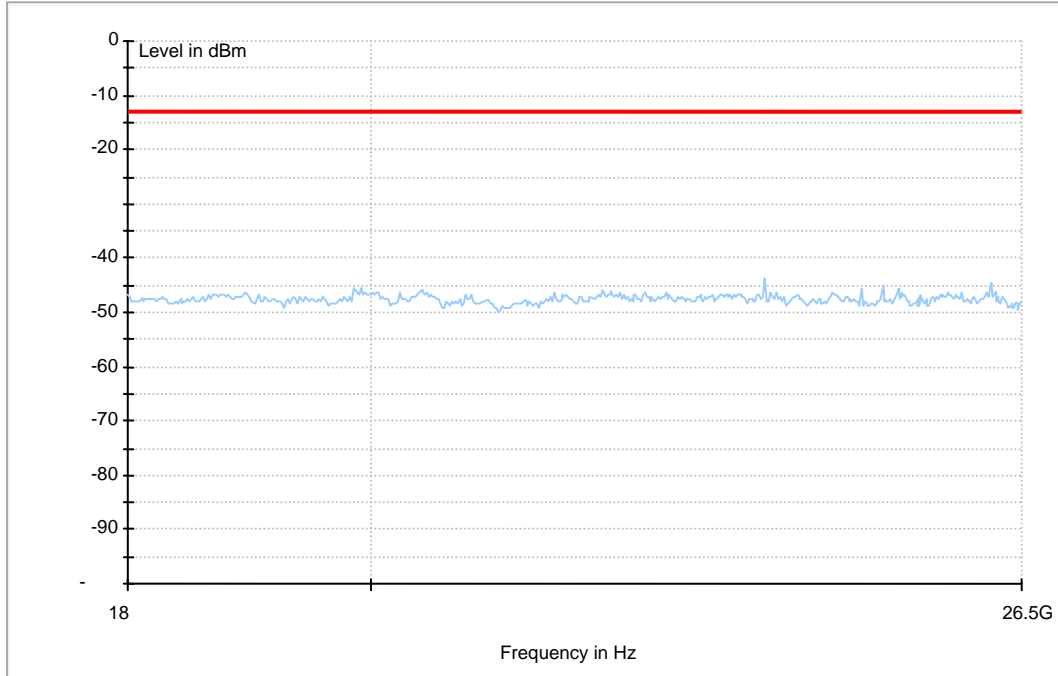



WCDMA1900

Traffic Mode (9kHz-30MHz)

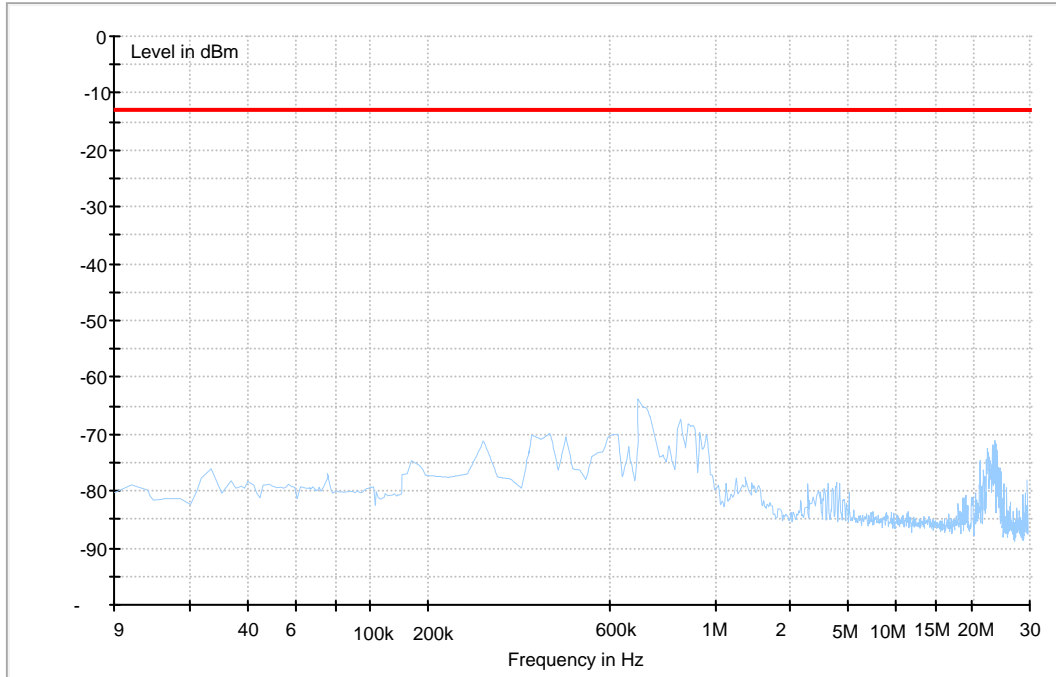



Traffic Mode (30MHz-3GHz)

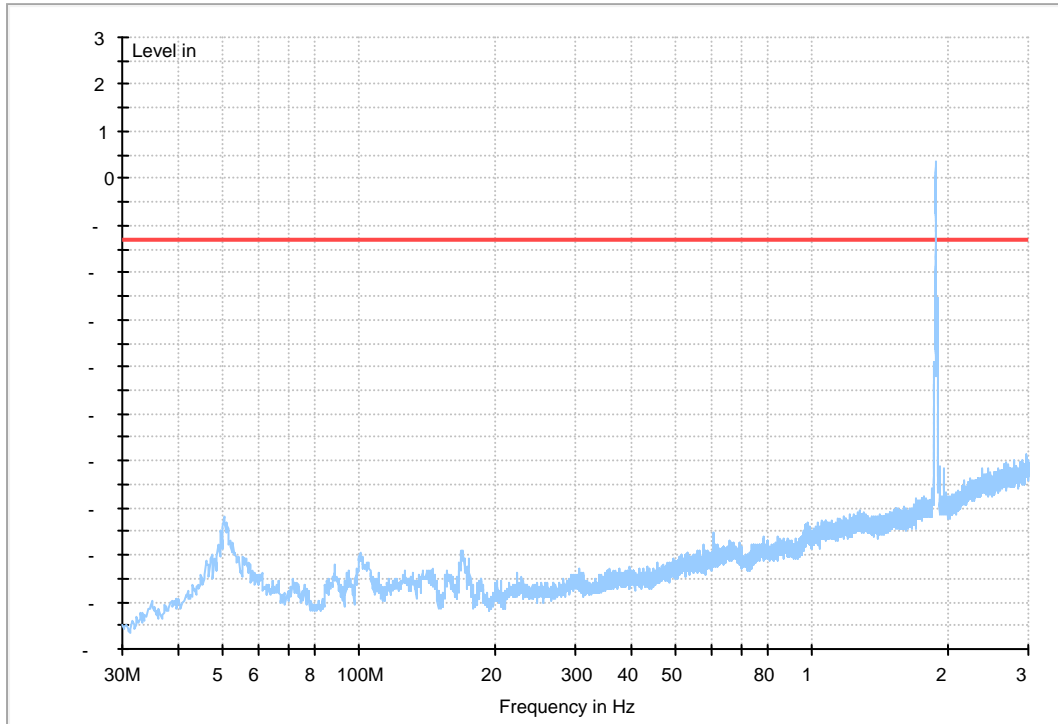



Traffic Mode (3GHz-18GHz)

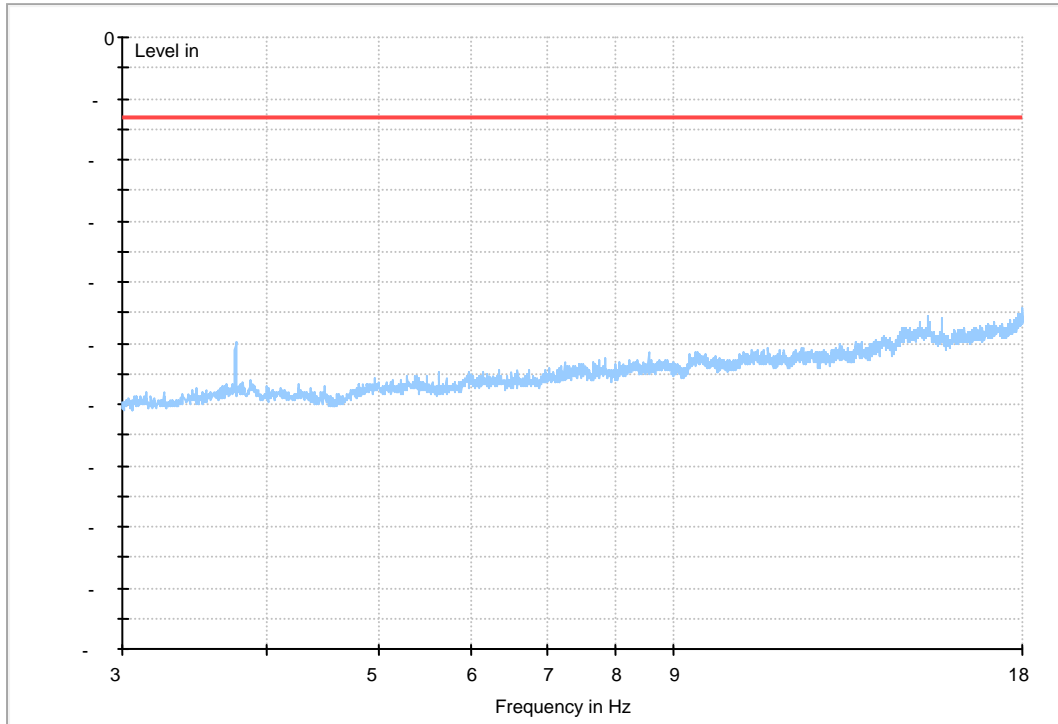



Traffic Mode (18GHz-26.5GHz)

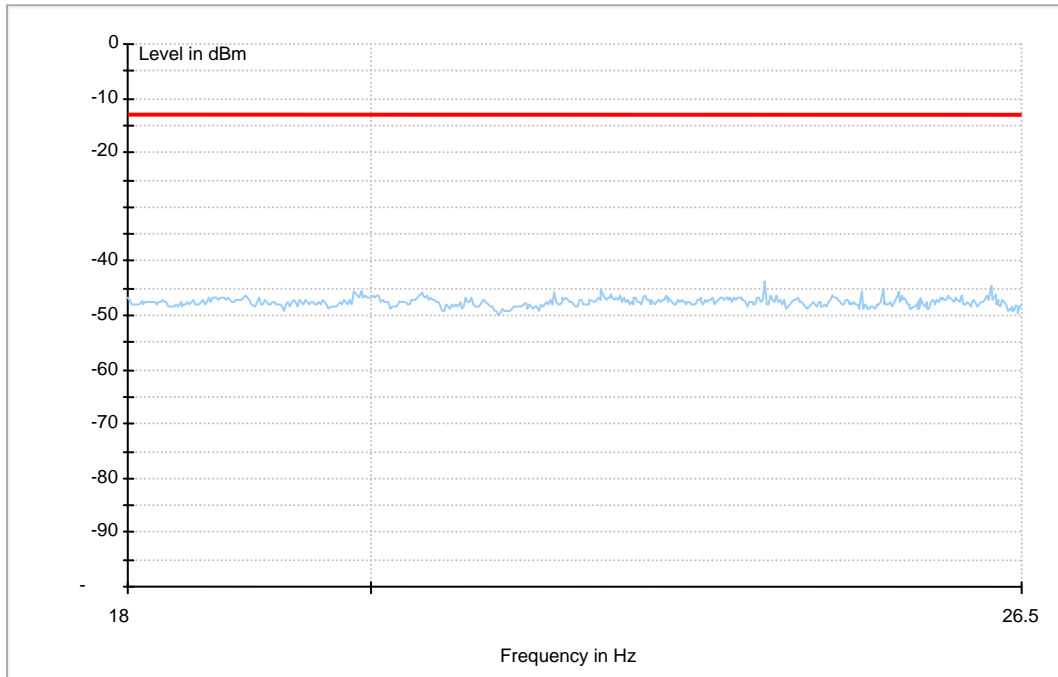



HSDPA 1900

Traffic Mode (9kHz-30MHz)

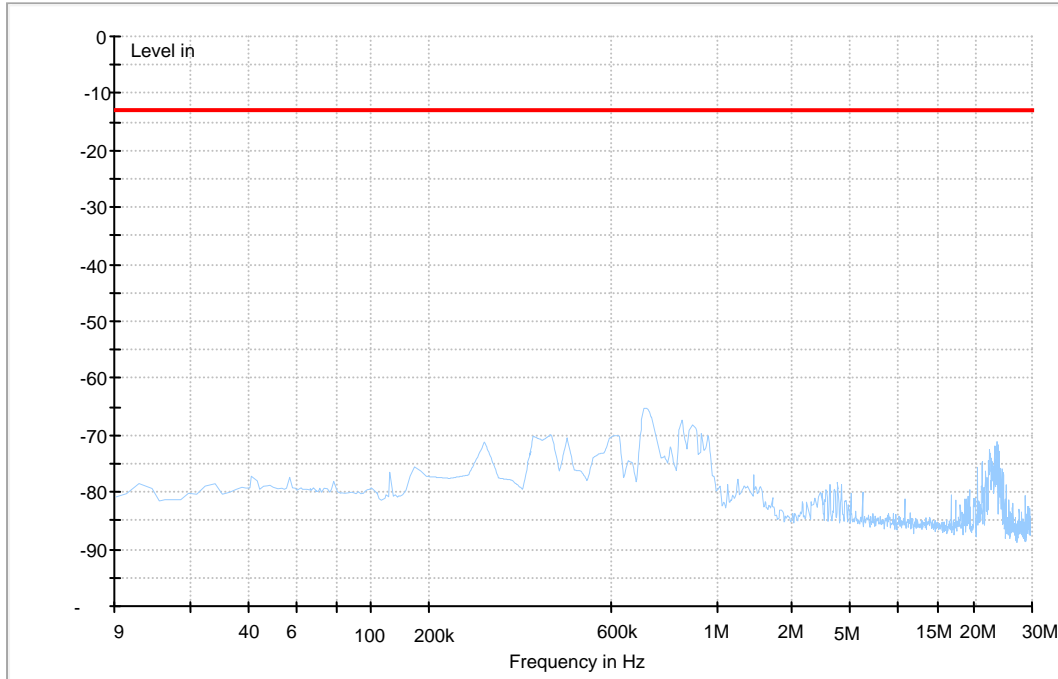



Traffic Mode (30MHz-3GHz)

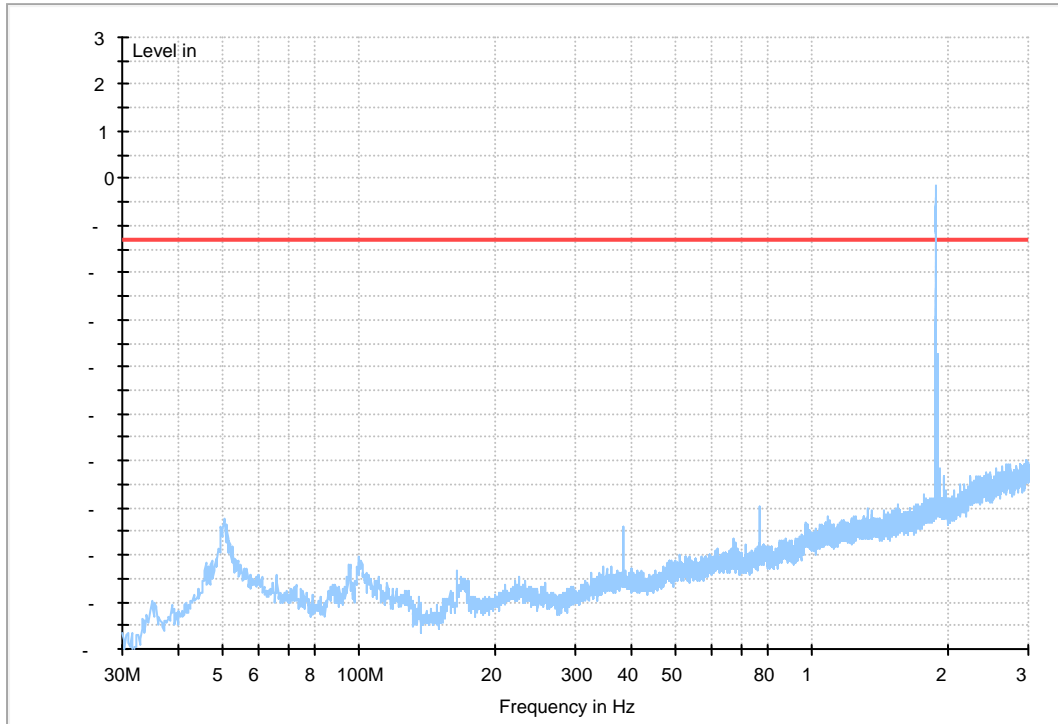



Traffic Mode (3GHz-18GHz)

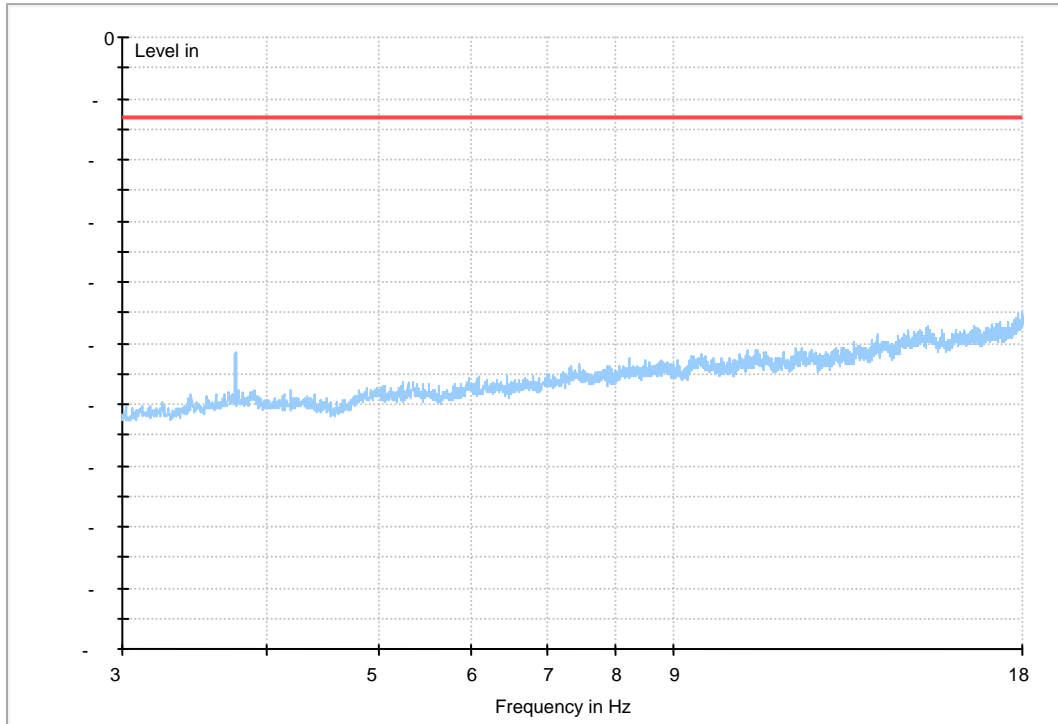



Traffic Mode (18GHz-26.5GHz)

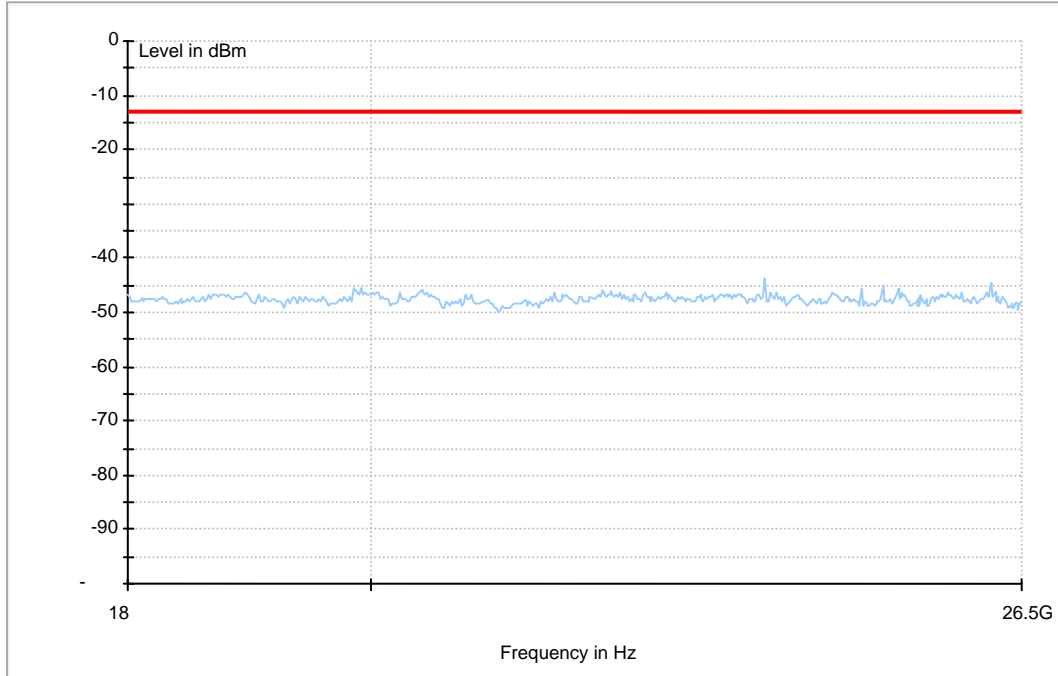



HSUPA 1900

Traffic Mode (9kHz-30MHz)

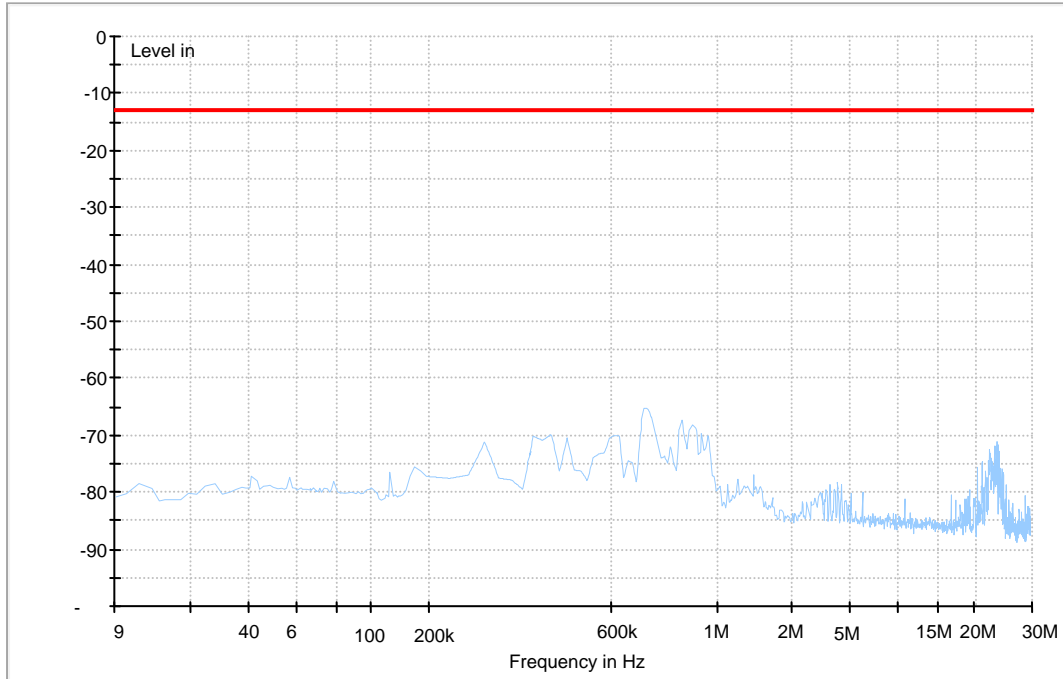



Traffic Mode (30MHz-3GHz)

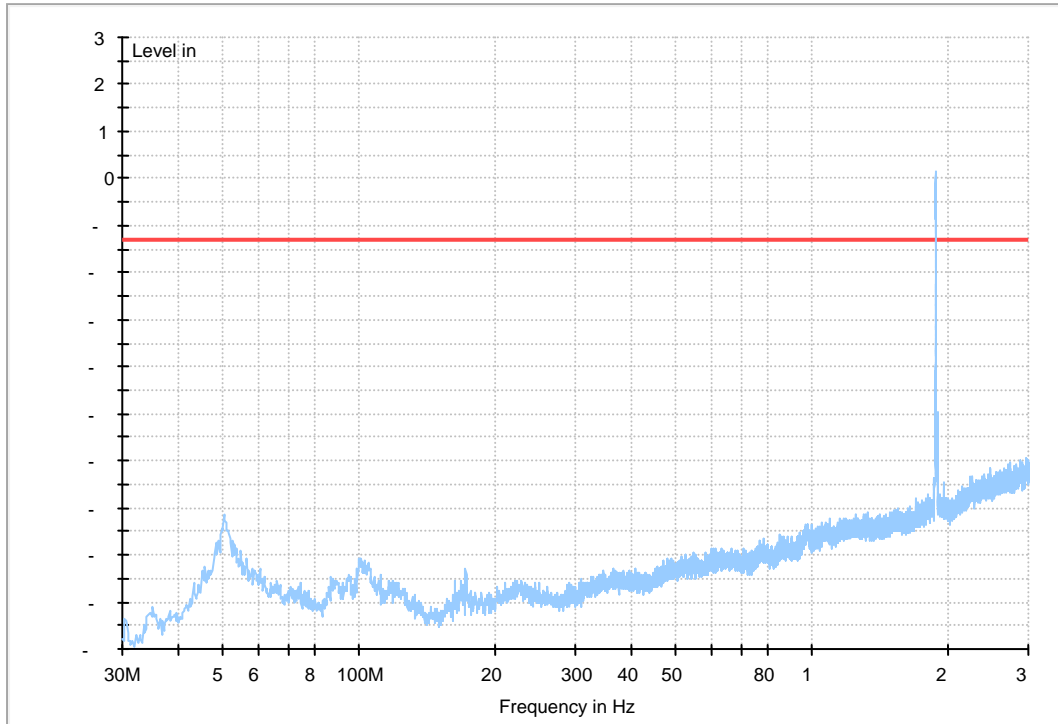



Traffic Mode (3GHz-18GHz)

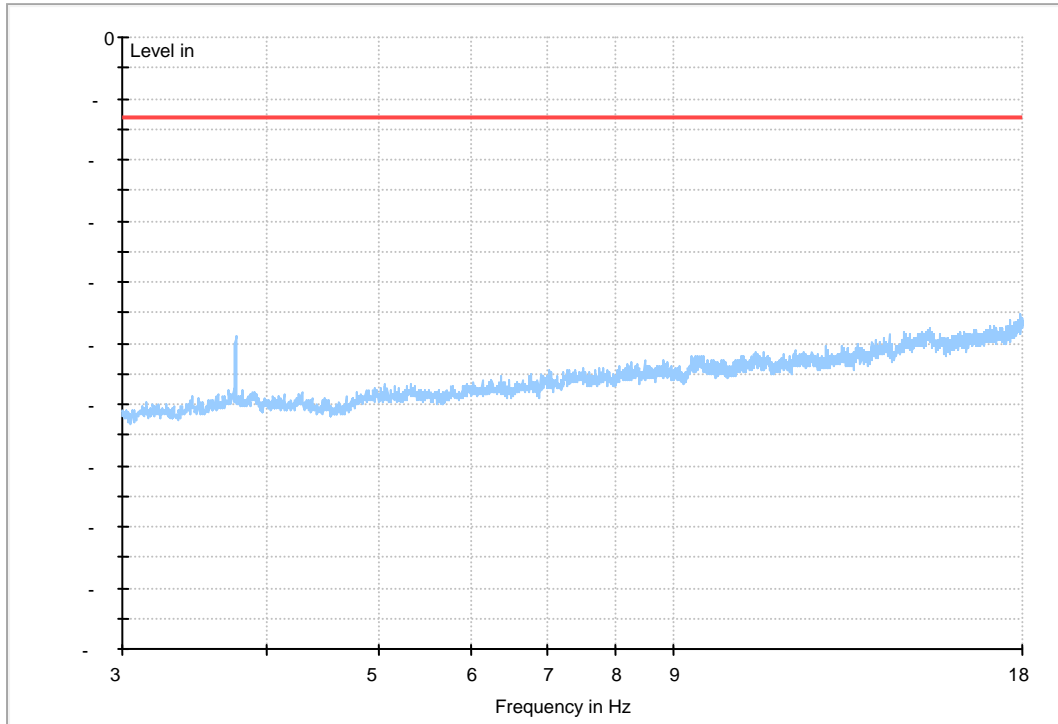



Traffic Mode (18GHz-26.5GHz)

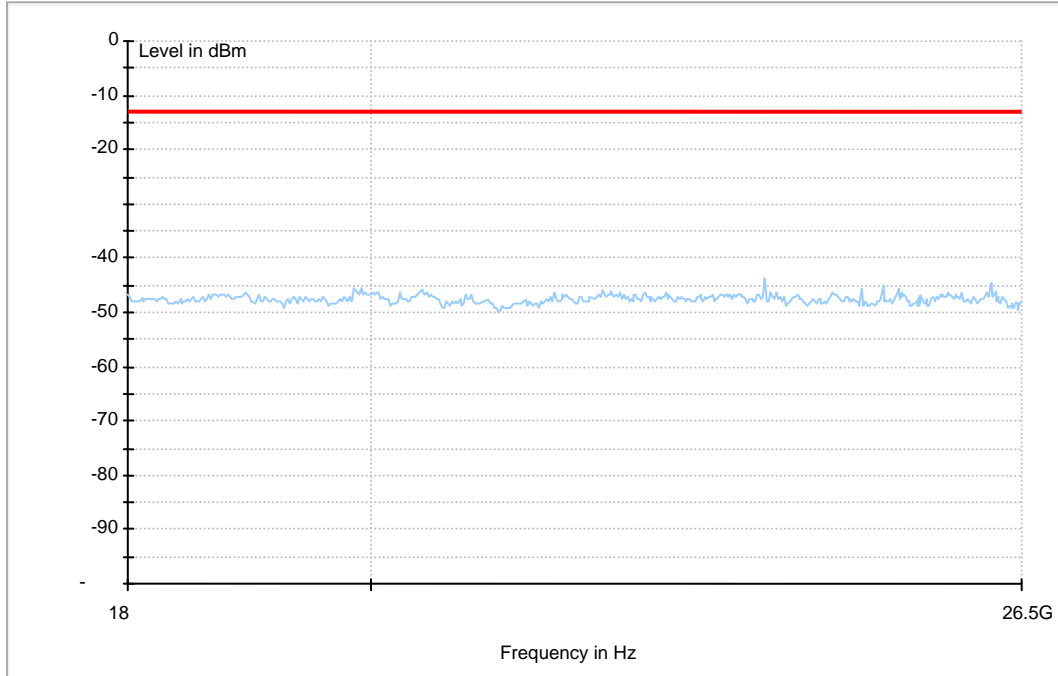

-----The END-----



Appendix G

Frequency Stability

According to FCC Part 2.1055& Part 24.235



Frequency Error vs. Temperature:

Test Mode	RF Ch.	Volt.	Temp.	Freq. Error [Hz]	Freq. vs. rated [ppm]	Freq. vs. 20 °C [ppm]	Limit [ppm]	Verdict
TM 1	M	100%	-30 °C	15	0.0080	---	±2.5	Pass
			-20 °C	12	0.0064	---	±2.5	Pass
			-10 °C	11	0.0059	---	±2.5	Pass
			0 °C	13	0.0069	---	±2.5	Pass
			10 °C	-15	-0.0080	---	±2.5	Pass
			20 °C	-13	-0.0069	---	±2.5	Pass
			30 °C	-12	-0.0064	---	±2.5	Pass
			40 °C	7	0.0037	---	±2.5	Pass
			50 °C	-16	-0.0085	---	±2.5	Pass
TM 2	M	100%	-30 °C	17	0.0090	---	±2.5	Pass
			-20 °C	12	0.0064	---	±2.5	Pass
			-10 °C	15	0.0080	---	±2.5	Pass
			0 °C	-13	-0.0069	---	±2.5	Pass
			10 °C	13	0.0069	---	±2.5	Pass
			20 °C	-17	-0.0090	---	±2.5	Pass
			30 °C	-15	-0.0080	---	±2.5	Pass
			40 °C	14	0.0074	---	±2.5	Pass
			50 °C	-15	-0.0080	---	±2.5	Pass
TM 3	M	100%	-30 °C	15	0.0080	---	±2.5	Pass
			-20 °C	-18	-0.0096	---	±2.5	Pass
			-10 °C	-15	-0.0080	---	±2.5	Pass
			0 °C	13	0.0069	---	±2.5	Pass
			10 °C	11	0.0059	---	±2.5	Pass
			20 °C	-17	-0.0090	---	±2.5	Pass
			30 °C	-14	-0.0074	---	±2.5	Pass
			40 °C	13	0.0069	---	±2.5	Pass
			50 °C	10	0.0053	---	±2.5	Pass



Frequency Error vs. Voltage:

Test Mode	RF Ch.	Temp.	Volt.	Freq. Error [Hz]	Freq. vs. rated [ppm]	Freq. vs. 20 °C [ppm]	Limit [ppm]	Verdict
TM 1	M	20 °C	VL	17	0.0090	---	±2.5	Pass
			VN	-16	-0.0085	---	±2.5	Pass
			VH	17	0.0090	---	±2.5	Pass
TM 2	M	20 °C	VL	10	0.0053	---	±2.5	Pass
			VN	-9	-0.0048	---	±2.5	Pass
			VH	-15	-0.0080	---	±2.5	Pass
TM 3	M	20 °C	VL	12	0.0064	---	±2.5	Pass
			VN	-16	-0.0085	---	±2.5	Pass
			VH	10	0.0053	---	±2.5	Pass

-----The END-----

--