



FCC Test Report - EDR

**Product Name: T-Mobile myTouch Q;
HSPA/UMTS/GPRS/GSM/EDGE Mobile Phone with Bluetooth;
Ascend G312 Qwerty**

Model Number: HUAWEI U8730, U8730

**Report No: SYBH(Z-RF)001042012-2005
FCC ID: QISU8730**

Reliability Laboratory of Huawei Technologies Co., Ltd.

Huawei Base, Bantian, Longgang District, Shenzhen 518129, P.R. China

Tel: +86 755 28780808 Fax: +86 755 89652518



Notice

1. The laboratory has obtained the accreditation of China National Accreditation Service for Conformity Assessment (CNAS), and accreditation number: L0310.
2. The laboratory has been listed on the US Federal Communications Commission list of test facilities recognized to perform electromagnetic emissions measurements. The site recognition number is 97456.
3. The laboratory has been listed by industry Canada to perform electromagnetic emission measurement. The site recognition number is 6369A-2.
4. The test report is invalid if not marked with "exclusive stamp for the test report".
5. The test report is invalid if not marked with the stamps or the signatures of the persons responsible for performing, revising and approving the test report.
6. The test report is invalid if there is any evidence of erasure and/or falsification.
7. If there is any dissidence for the test report, please file objection to the test centre within 15 days from the date of receiving the test report.
8. Normally, the test report is only responsible for the samples that have undergone the test.
9. Context of the test report cannot be used partially or in full for publicity and/or promotional purposes without previous written approval of the laboratory.



REGULATION	FCC CFR47 Part 2 :2010: Subpart J;
	FCC CFR47 Part 15 :2010: Subpart C;
	ANSI C63.10: 2009
	ANSI C63.4: 2003
START OF TEST	Mar.20, 2012
END OF TEST	Mar.31, 2012
Final Judgement:	Pass

Approved By Senior Engineer

Apr.01, 2012
Date

Dai Linjun
Name

Dai Linjun
Signature

Reviewed By

Apr.01, 2012
Date

Cousy Xu
Name

Cousy XU
Signature

Operator

Apr.01, 2012
Date

Huang Qiuliang
Name

Huang Qiuliang
Signature



Contents

1	<u>Summary</u>	5
2	<u>Product Description</u>	6
2.1	PRODUCTION INFORMATION	6
2.2	MODIFICATION INFORMATION.....	6
3	<u>Test Site Description</u>	7
3.1	TESTING PERIOD	7
3.2	GENERAL SET UP DESCRIPTION	7
4	<u>Product Description</u>	8
4.1	TECHNICAL CHARACTERISTICS	8
4.2	EUT IDENTIFICATION LIST	10
5	<u>Main Test Instruments</u>	11
6	<u>Transmitter Measurements</u>	12
6.1	BANDWIDTH MEASUREMENT	12
6.2	CARRIER FREQUENCY SEPARATION MEASUREMENT	14
6.3	NUMBER OF HOPPING CHANNEL.....	16
6.4	TIME OF OCCUPANCY	18
6.5	PEAK OUTPUT POWER	20
6.6	BAND EDGE SPURIOUS EMISSION	22
6.7	CONDUCTED RF SPURIOUS	24
6.8	RADIATED SPURIOUS EMISSION & SPURIOUS IN RESTRICTED BAND	26
6.9	CONDUCTED EMISSION AT POWER PORT	29
7	<u>System Measurement Uncertainty</u>	31
8	<u>Appendices List</u>	32



1 Summary

The table below summarizes the measurements and results for the EUT. Detailed results and descriptions are shown in the following pages.

Table 1 Summary of results

FCC Measurement Specification	Description	Result
15.247 (a) (1)	Bandwidth measurement	PASS
15.247 (a) (1)	Carrier frequency separation measurement	PASS
15.247 (a) (1) III	Number of hopping channel	PASS
15.247 (a) (1) III	Time of occupancy	PASS
15.247 (b) (1)	Peak output power	PASS
15.247 (d)	Band edge compliance measurement	PASS
15.247 (d)	Conducted RF spurious	PASS
15.247 (d) / 15.205 & 15.209	Radiated spurious emission & Radiated restricted band measurement	PASS
15.207	Conducted emission test for power port	PASS



2 Product Description

2.1 Production Information

2.1.1 General Description

HUAWEI U8730, U8730 is subscriber equipment in the WCDMA/GSM system. The HSPA/UMTS frequency band is Band I, Band II, Band IV, and Band V. The GSM/GPRS/EDGE frequency band includes GSM850 and GSM900 and DCS1800 and PCS1900. The Mobile Phone implements such functions as RF signal receiving/transmitting, HSPA/UMTS and GSM/GPRS/EDGE protocol processing, voice, video MMS service, GPS, AGPS and WIFI etc. Externally it provides micro SD card interface, earphone port(to provide voice service) and USIM card interface. It also provides Bluetooth module to synchronize data between a PC and the phone, or to use the built-in modem of the phone to access the Internet with a PC, or to exchange data with other Bluetooth devices. But only the Bluetooth test data is included in this report.

Note: Only the Bluetooth test data is included in this report.

2.1.2 Support function and Service

The EUT support the Bluetooth's function and service as follows:

Table 2 Service and Test mode List

Service Name	Characteristic	Corresponding Test Mode	Note
Data and Voice	Modulation: $\pi/4$ -DQPSK	TM1	/
Data and Voice	Modulation: 8DPSK	TM2	/

2.2 Modification Information

For original equipment, following table is not application.

Table 3 Modification Information

Model Number	Board/Module	Original Version	New Version	Modify Information
Not applicable!				



3 Test Site Description

The test site of:

***Huawei Technologies Co. Ltd.
P.O. Box 518129
Huawei base, bantian,
Longgang District, Shenzhen, China***

3.1 Testing Period

The test have been performed during the period of

Mar.20, 2012 – Mar.31, 2012

3.2 General Set up Description

The Bluetooth hopping frequency system of EUT can Support 2.4GHz Band. For compliance with FCC regulation 47CFR part15 subpart C, we set the EUT as following test mode to do all compliance tests.

Bluetooth MODE:

TM1: π /4-DQPSK Modulation

TM2: 8DPSK Modulation



4 Product Description

4.1 Technical Characteristics

4.1.1 Frequency Range

Table 4 Frequency Range

Uplink band:	2400 to 2483.5 MHz	
Downlink band:	2400 to 2483.5 MHz	
Hop frequency support:	<input checked="" type="checkbox"/> YES	<input type="checkbox"/> NO

4.1.2 Channel Spacing / Separation

Table 5 Channel Spacing / Separation

Channel spacing:	1 MHz
Channel separation:	1 MHz

4.1.3 Antenna Information

Table 6 Antenna Information

Type:	Integrated / Internal
Maximum Gain(dBi):	2.22(from 2400MHz to 2500MHz)



4.1.4 Environmental Requirements

Table 7 Environmental Requirements

Minimum temperature:	- 10 °C
Maximum temperature:	+ 55 °C
Relative Humidity:	5%-95%

4.1.5 Power Source

Table 8 Power Source

AC voltage nominal:	~120V
AC voltage range	~100V-240V
AC current maximal:	1A

4.1.6 Tune-up Procedure

According to CFR (FCC) part 2, subpart 2, section 2.1033(c) (9).

Please reference the document Tune-up Procedure in TCF.



4.2 EUT Identification List

4.2.1 Board Information



Table 9 Board Information

T-Mobile myTouch Q;HSPA/UMTS/GPRS/GSM/EDGE Mobile Phone with Bluetooth;Ascend G312 Qwerty;		
HUAWEI U8730, U8730		
Hardware Version	Software Version	Serial Number
HD1U873M	U8730 V100R001C85B820	E7F01A11A1500137

4.2.2 Sub-Assembly

AC/DCAdapter Model	HW-050100U2W
Manufacturer	Huawei Technologies Co., Ltd.
Input Voltage	~100-240V 50/60Hz 0.2A
Output Voltage	5V  1A
Rated Power	5W

4.2.3 Battery Technical Data

Name	Manufacture	Description
Rechargeable Li-ion	Huawei Technologies Co., Ltd.	Battery Model: HB5N1H Rated capacity: 1500mAh Nominal Voltage:  +3.7V Charging Voltage:  +4.2V

4.2.4 FCC Identification

Grantee Code: QIS
 Product Code: U8730
 FCC Identification: QISU8730



5 Main Test Instruments

Table 10 Main Test Equipments

Equipment Description	Manufacturer	Model	Serial Number	Calibrated until
Power supply	KEITHLEY	2303	1288003	Sep.27,2012
Wireless Communication Test set	Agilent	N4010A	MY49081592	Nov.26.2012
Spectrum Analyzer	Agilent	E4440A	MY49420179	Apr.20,2012
Signal Analyzer	R&S	FSQ31	200021	Sep.27,2012
Temperature Chamber	WEISS	WKL64	24600294	Feb.13,2013
Signal generator	Agilent	E8257D	MY49281095	Jul.09.2012
Test receiver	R&S	ESU26	100150	May.29.2012
Tunable Dipole	Schwarzbeck	D69250-UHAP/D69250-VHAP	919/1009	Jan.29.2013
Tunable Dipole	Schwarzbeck	D69250-UHAP/D69250-VHAP	979/917	Jan.29.2013
Horn Antenna	R & S	HF906	100683	May.15, 2012
Horn Antenna	R & S	HF906	100684	Jul.01, 2012
Broadband Antenna	Schwarzbeck	VULB 9163	9163-357	May.15, 2012
Broadband Antenna	Schwarzbeck	VULB 9163	9163-356	May.15, 2012



6 Transmitter Measurements

6.1 Bandwidth measurement

6.1.1 Test Conditions

Table 11 Test Conditions

Preconditioning:	0.5 hour
Measured at:	Antenna connector
Ambient temperature:	25 °C
Relative humidity:	55%
Test Configurations:	TM1/TM2 at channel No.0, 40, 78

6.1.2 Test Specifications and Limits

6.1.2.1 Specification

CFR 47 (FCC) part 15.247 (a) (1) and DA 00-705

6.1.2.2 Supporting Standards

Table 12 Supporting Standards:

ANSI C63.10-2009	American National Standard for Testing Unlicensed Wireless Devices
------------------	--

6.1.2.3 Limits

Not Applicable.

6.1.3 Test Method and Setup

- (a) Connect test port of EUT to universal communication tester.
- (b) Set the EUT to transmit maximum output power at 2.4GHz and switch off frequency hopping function, then set the measured frequency number and test the bandwidth with universal communication tester.

Test setup

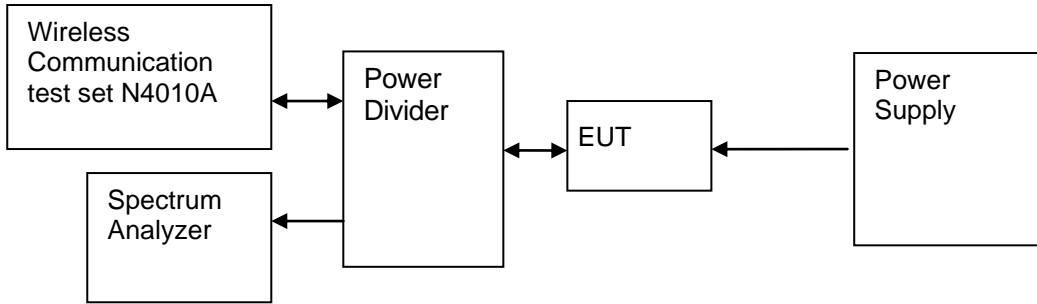

Figure 1. Test Set-up

6.1.4 Measurement Results

Table 13 Measurement Results TM1 (Modulation: $\pi/4$ -DQPSK)

Channel Position	Channel Number	Frequency [GHz]	Bandwidth Type	Measured Bandwidth [MHz]	Result
B	0	2.402	20dB	1.335	Pass
			99%	1.189	Pass
M	40	2.442	20dB	1.335	Pass
			99%	1.192	Pass
T	78	2.480	20dB	1.336	Pass
			99%	1.189	Pass

Table 14 Measurement Results TM2 (Modulation: 8DPSK)

Channel Position	Channel Number	Frequency [GHz]	Bandwidth Type	Measured Bandwidth [MHz]	Result
B	0	2.402	20dB	1.324	Pass
			99%	1.195	Pass
M	40	2.442	20dB	1.310	Pass
			99%	1.193	Pass
T	78	2.480	20dB	1.311	Pass
			99%	1.194	Pass

6.1.5 Conclusion

The equipment **PASSED** the requirement of this clause.
 For the measurement results refer to appendix A.

6.2 Carrier frequency separation measurement

6.2.1 Test Conditions

Table 15 Test Conditions

Preconditioning:	0.5 hour
Measured at:	Antenna connector
Ambient temperature:	25 °C
Relative humidity:	55%
Test Configurations:	TM1/TM2 at channel No.39, 40, 41

6.2.2 Test Specifications and Limits

6.2.2.1 Specification

CFR 47 (FCC) part 15.247 (a) (1) and DA 00-705

6.2.2.2 Supporting Standards

Table 16 Supporting Standards:

ANSI C63.10-2009	American National Standard for Testing Unlicensed Wireless Devices
------------------	--

6.2.2.3 Limits

Frequency hopping systems shall have hopping channel carrier frequencies separated by a minimum of 25 kHz or the 20 dB bandwidth of the hopping channel, whichever is greater. Alternatively, frequency hopping systems operating in the 2400-2483.5 MHz band may have hopping channel carrier frequencies that are separated by 25 kHz or two-thirds of the 20 dB bandwidth of the hopping channel, whichever is greater.

Table 17 Limits TM1 (Modulation: $\pi/4$ -DQPSK)

Regulation:	≥ 0.025 or $2/3$ of the 20 dB bandwidth
Limit:	$\geq 2/3 \times 1.336\text{M} = 0.891$ MHz

Table 18 Limits TM2 (Modulation: 8DPSK)

Regulation:	≥ 0.025 or $2/3$ of the 20 dB bandwidth
Limit:	$\geq 2/3 \times 1.324\text{M} = 0.883$ MHz

6.2.3 Test Method and Setup

- (a) Connect test port of EUT to spectrum analyzer and universal communication tester.
- (b) Set the EUT to transmit maximum output power at 2.4GHz and switch off frequency hopping function, then set the measured frequency number to two adjacent channels separately and test the carrier frequency separation with spectrum analyzer.

Test setup

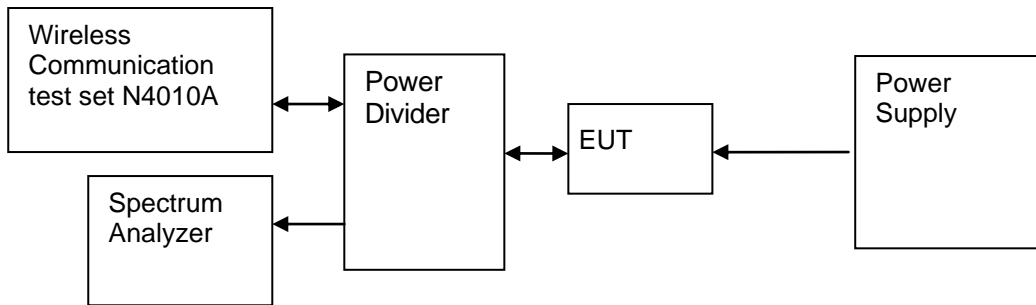

Figure 2. Test Set-up

6.2.4 Measurement Results

Table 19 Measurement Results TM1 (Modulation: $\pi/4$ -DQPSK)

Channel No.	Frequency [GHz]	Channel No.	Frequency [GHz]	Measured frequency separation [MHz]	Limit [MHz]	Result
40	2.442	39	2.441	1.02	≥ 0.891	Pass
40	2.442	41	2.443	1.02	≥ 0.891	Pass

Table 20 Measurement Results TM2 (Modulation: 8DPSK)

Channel No.	Frequency [GHz]	Channel No.	Frequency [GHz]	Measured frequency separation [MHz]	Limit [MHz]	Result
40	2.442	39	2.441	0.9	≥ 0.883	Pass
40	2.442	41	2.443	0.98	≥ 0.883	Pass

6.2.5 Conclusion

The equipment **PASSED** the requirement of this clause.
 For the measurement results refer to appendix B.

6.3 Number of hopping channel

6.3.1 Test Conditions

Table 21 Test Conditions

Preconditioning:	0.5 hour
Measured at:	Antenna connector
Ambient temperature:	25 °C
Relative humidity:	55%
Test Configurations:	TM1/TM2 at hopping frequency state

6.3.2 Test Specifications and Limits

6.3.2.1 Specification

CFR 47 (FCC) part 15.247 (a) (1) iii and DA 00-705

6.3.2.2 Supporting Standards

Table 22 Supporting Standards:

ANSI C63.10-2009	American National Standard for Testing Unlicensed Wireless Devices
------------------	--

6.3.2.3 Limits

Number of hopping channel should be compliance with the requirements in part15.247 (a) (1) iii.

Table 23 Limits

Limits	≥ 15 hopping frequency channel
--------	-------------------------------------

6.3.3 Test Method and Setup

- Connect test port of EUT to spectrum analyzer and universal communication tester.
- Set the EUT to transmit maximum output power at 2.4GHz and switch on frequency hopping function, then set enough count time (larger than 5000 times) to get all the hopping frequency channel displayed on the screen of spectrum analyzer.
- Count the quantity of peaks to get the number of hopping channels.

Test setup

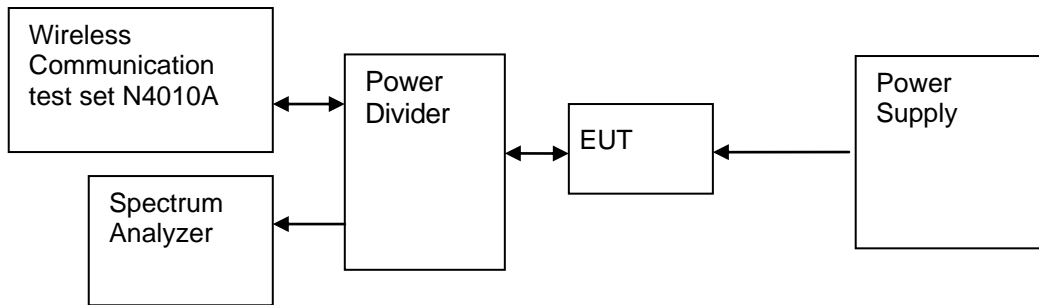

Figure 3. Test Set-up

6.3.4 Measurement Results

Table 24 Measurement Results TM1 (Modulation: $\pi/4$ -DQPSK)

Measured frequency range [MHz]	Channel No. range	Measured Channel No.	Limit	Result
2400 to 2483.5	0-78	79	≥ 15	Pass

Table 25 Measurement Results TM2 (Modulation: 8-DPSK)

Measured frequency range [MHz]	Channel No. range	Measured Channel No.	Limit	Result
2400 to 2483.5	0-78	79	≥ 15	Pass

6.3.5 Conclusion

The equipment **PASSED** the requirement of this clause.
 For the measurement results refer to appendix C.

6.4 Time of occupancy

6.4.1 Test Conditions

Table 26 Test Conditions

Preconditioning:	0.5 hour
Measured at:	Antenna connector
Ambient temperature:	25°C
Relative humidity:	55%
Test Configurations:	TM1/TM2 at hopping frequency state

6.4.2 Test Specifications and Limits

6.4.2.1 Specification

CFR 47 (FCC) part 15.247 (a) (1) iii and DA 00-705

6.4.2.2 Supporting Standards

Table 27 Supporting Standards:

ANSI C63.10-2009	American National Standard for Testing Unlicensed Wireless Devices
------------------	--

6.4.2.3 Limits

The average time of occupancy on any channel shall not be greater than 0.4 seconds within a period of 0.4 seconds multiplied by the number of hopping channels employed. Frequency hopping systems may avoid or suppress transmissions on a particular hopping frequency provided that a minimum of 15 channels are used.

Table 28 Limits

Limits for time of occupancy	≤ 0.4s
------------------------------	--------

6.4.3 Test Method and Setup

- (a) Connect test port of EUT to spectrum analyzer and universal communication tester.
- (b) Set the EUT to transmit maximum output power at 2.4GHz and switch on frequency hopping function.
- (c) Set the span of spectrum analyzer to 0 Hz, and set the resolution bandwidth to 1 MHz and the video bandwidth to 1 MHz, then get the time domain measured diagram. and set sweep time to 2 times of one burst occupancy time, and measure the time of occupancy of one burst.
- (d) Set the resolution bandwidth to 1 MHz and the video bandwidth to 3 MHz, and set the sweep time to a period (0.4 seconds multiplied by the number of hopping channels employed), and count the number of the bursts.
- (e) Calculate the time of occupancy in a period with time occupancy of a burst and quantity of bursts.

Test setup

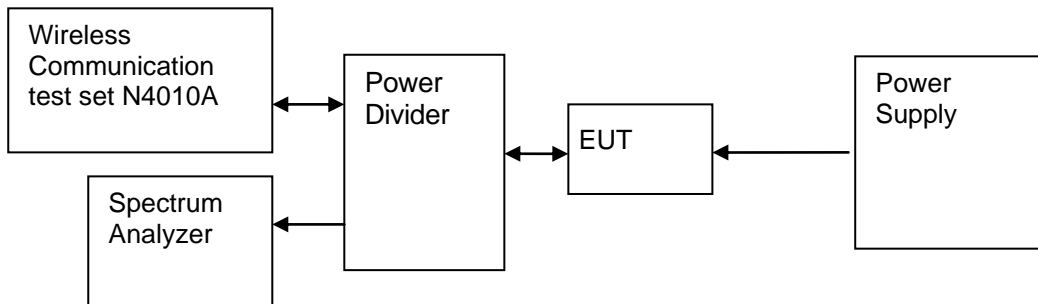

Figure 4. Test Set-up

6.4.4 Measurement Results

Table 29 Measurement Results TM1 (Modulation: $\pi/4$ -DQPSK)

Time of Single Slot [ms]	Numbers of slots in a period	Time of occupied in a period [s]	Limit [s]	Result
2.9	106.7	0.30943	≤ 0.4	Pass

Table 30 Measurement Results TM2 (Modulation: 8DPSK)

Time of Single Slot [ms]	Numbers of slots in a period	Time of occupied in a period [s]	Limit [s]	Result
2.9	106.7	0.30943	≤ 0.4	Pass

Note: The result is measured at 2-DH5\3-DH5 mode in $\pi/4$ -DQPSK\8DPSK modulation, which has longest time in one transmission burst.

6.4.5 Conclusion

The equipment **PASSED** the requirement of this clause.
For the measurement results refer to appendix D.

6.5 Peak output power

6.5.1 Test Conditions

Table 31 Test Conditions

Preconditioning:	0.5 hour
Measured at:	Antenna connector
Ambient temperature:	25 °C
Relative humidity:	55%
Test Configurations:	TM1/TM2 at channel No.0, 40, 78

6.5.2 Test Specifications and Limits

6.5.2.1 Specification

CFR 47 (FCC) part 15.247 (b) (1) and DA 00-705

6.5.2.2 Supporting Standards

Table 32 Supporting Standards:

ANSI C63.10-2009	American National Standard for Testing Unlicensed Wireless Devices
------------------	--

6.5.2.3 Limits

Compliance with part 15.247 (b) (1), for frequency hopping systems operating in the 2400-2483.5 MHz band employing at least 75 non-overlapping hopping channels, and all frequency hopping systems in the 5725-5850 MHz band: 1 watt. For all other frequency hopping systems in the 2400-2483.5 MHz band: 0.125 watt.

Table 33 Limits

2.4GHz and 5.8GHz hopping frequency system	1 Watt (=30 dBm)
--	------------------

6.5.3 Test Method and Setup

- (a) Connect test port of EUT to universal communication tester.
- (b) Set the EUT to transmit maximum output power at 2.4GHz and switch off frequency hopping function.
- (c) Then set the EUT to transmit at high, middle and low frequency and measure the conducted output power separately.

Test setup

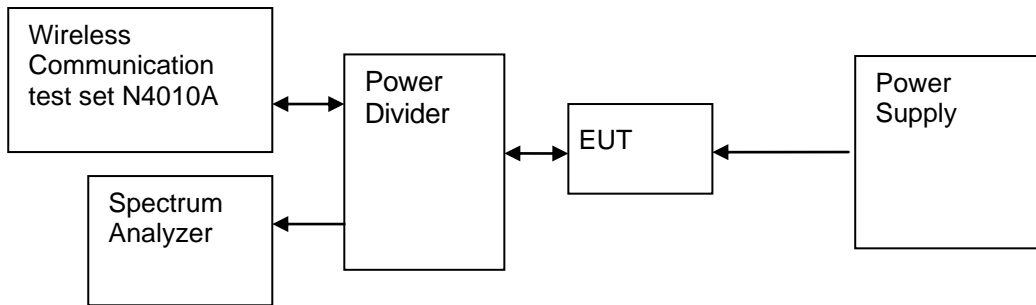

Figure 5. Test Set-up

6.5.4 Measurement Results

Table 34 Measurement Results TM1 (Modulation: $\pi/4$ -DQPSK)

Channel	Channel No.	Center Freq.[MHz]	Meas. Level (Cond.) [dBm]	Limit [dBm]	Result
B	0	2402	9.76	< 30	Pass
M	40	2442	11.11	< 30	Pass
T	78	2480	10.79	< 30	Pass

Table 35 Measurement Results TM2 (Modulation: 8DPSK)

Channel	Channel No.	Center Freq.[MHz]	Meas. Level (Cond.) [dBm]	Limit [dBm]	Result
B	0	2402	9.77	< 30	Pass
M	40	2442	11.11	< 30	Pass
T	78	2480	10.78	< 30	Pass

6.5.5 Conclusion

The equipment **PASSED** the requirement of this clause.
 For the measurement results refer to appendix E.

6.6 Band edge spurious emission

6.6.1 Test Conditions

Table 36 Test Conditions

Preconditioning:	0.5 hour
Measured at:	Antenna connector
Ambient temperature:	25°C
Relative humidity:	55%
Test Configurations:	TM1/TM2 at channel No. 0, 78 and frequency hopping state

6.6.2 Test Specifications and Limits

6.6.2.1 Specification

CFR 47 (FCC) part 15.247 (d) and DA 00-705

6.6.2.2 Supporting Standards

Table 37 Supporting Standards:

ANSI C63.10-2009	American National Standard for Testing Unlicensed Wireless Devices
------------------	--

6.6.2.3 Limits

Compliance with part 15.247 (d), in any 100 kHz bandwidth outside the frequency band in which the spread spectrum or digitally modulated intentional radiator is operating, the radio frequency power that is produced by the intentional radiator shall be at least 20 dB below that in the 100 kHz bandwidth within the band that contains the highest level of the desired power, based on either an RF conducted or a radiated measurement, provided the transmitter demonstrates compliance with the peak conducted power limits. If the transmitter complies with the conducted power limits based on the use of RMS averaging over a time interval, as permitted under paragraph (b)(3) of this section, the attenuation required under this paragraph shall be 30 dB instead of 20 dB. Attenuation below the general limits specified in Section 15.209(a) is not required.

Table 38 Limits

Band edge spurious:	20 dBc/100kHz
---------------------	---------------

6.6.3 Test Method and Setup

- (a) Connect test port of EUT to spectrum analyzer and universal communication tester
- (b) Set the EUT to transmit maximum output power at 2.4GHz and switch off frequency hopping function.
- (c) Then set the EUT to transmit at high, low frequency and measure the conducted band edge spurious separately.
- (d) Switch on the frequency hopping function, and repeat above measurement.

Test setup

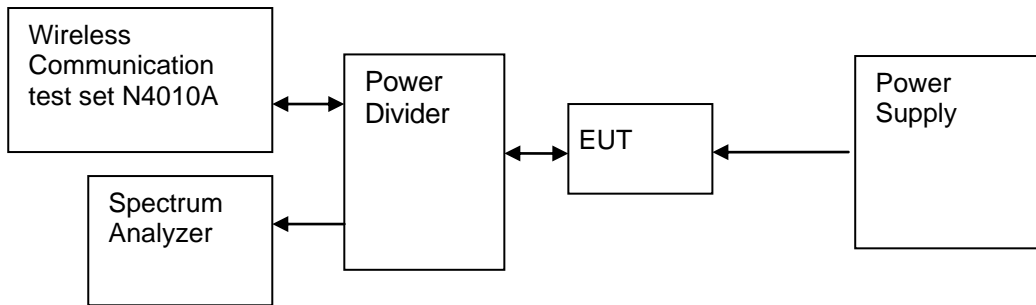

Figure 6. Test Set-up

6.6.4 Measurement Results

Table 39 Measurement Results for Band Edge immediately outside the 2.4GHz Band
TM1 (Modulation: $\pi/4$ -DQPSK)

	Channel No.	Carrier Frequency [MHz]	Carrier Power [dBm]	Frequency Hopping	Max. Spurious Level [dBm]	Limit [dBm]	Result
Low Edge	0	2402	8.89	Off	-49.15	-11.1	Pass
	-	-	8.86	On	-51.37	-11.1	Pass
High Edge	78	2480	8.88	Off	-53.87	-11.1	Pass
	-	-	8.64	On	-53.73	-11.4	Pass

Table 40 Measurement Results for Band Edge immediately outside the 2.4GHz Band
TM2 (Modulation: 8DPSK)

	Channel No.	Carrier Frequency [MHz]	Carrier Power [dBm]	Frequency Hopping	Max. Spurious Level [dBm]	Limit [dBm]	Result
Low Edge	0	2402	8.87	Off	-49.38	-11.1	Pass
	-	-	8.39	On	-47.46	-11.6	Pass
High Edge	78	2480	8.90	Off	-53.96	-11.1	Pass
	-	-	8.83	On	-54.18	-11.2	Pass

6.6.5 Conclusion

The equipment **PASSED** the requirement of this clause.
For the measurement results refer to appendix F.

6.7 Conducted RF spurious

6.7.1 Test Conditions

Table 41 Test Conditions

Preconditioning:	0.5 hour
Measured at:	Antenna connector
Ambient temperature:	25 °C
Relative humidity:	55%
Test Configurations:	TM1/TM2 at channel No.0, 40, 78

6.7.2 Test Specifications and Limits

6.7.2.1 Specification

CFR 47 (FCC) part 15.247 (d) and DA 00-705

6.7.2.2 Supporting Standards

Table 42 Supporting Standards:

ANSI C63.10-2009	American National Standard for Testing Unlicensed Wireless Devices
------------------	--

6.7.2.3 Limits

Compliance with part 15.247 (d), in any 100 kHz bandwidth outside the frequency band in which the spread spectrum or digitally modulated intentional radiator is operating, the radio frequency power that is produced by the intentional radiator shall be at least 20 dB below that in the 100 kHz bandwidth within the band that contains the highest level of the desired power, based on either an RF conducted or a radiated measurement, provided the transmitter demonstrates compliance with the peak conducted power limits. If the transmitter complies with the conducted power limits based on the use of RMS averaging over a time interval, as permitted under paragraph (b)(3) of this section, the attenuation required under this paragraph shall be 30 dB instead of 20 dB. Attenuation below the general limits specified in Section 15.209(a) is not required.

Table 43 Limits

Band edge spurious:	20 dBc/100kHz
---------------------	---------------

6.7.3 Test Method and Setup

- (a) Connect test port of EUT to spectrum analyzer and universal communication tester
- (b) Set the EUT to transmit maximum output power at 2.4GHz and switch off frequency hopping function.
- (c) Then set the EUT to transmit at high, middle and low frequency and measure the conducted band edge spurious separately.
- (d) Switch on the frequency hopping function, and repeat above measurement.

Test setup

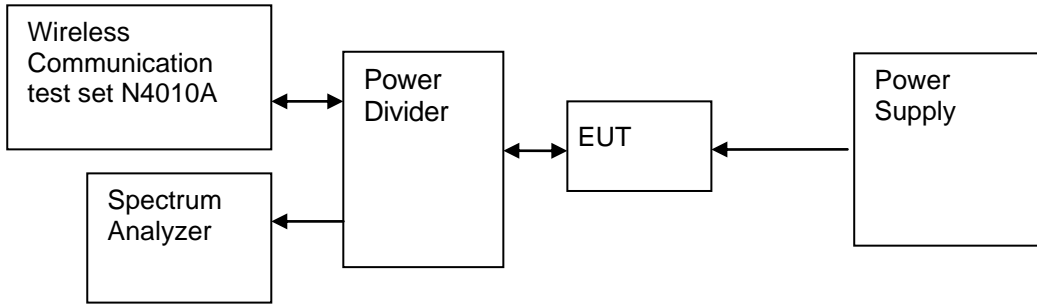

Figure 7. Test Set-up

6.7.4 Measurement Results

Table 44 Measurement Results TM1 (Modulation: $\pi/4$ -DQPSK)

Test Frequency Range	Channel No.	Carrier Frequency [MHz]	Carrier Power [dBm]	Frequency Hopping	Max. Spurious Level [dBm]	Limit [dBm]	Result
9kHz-25GHz	0	2402	5.33	Off	-40.81	-14.7	Pass
9kHz-25GHz	40	2442	7.22	Off	-44.74	-12.8	Pass
9kHz-25GHz	78	2480	5.12	Off	-47.16	-14.9	Pass

Table 45 Measurement Results TM2 (Modulation: 8DPSK)

Test Frequency Range	Channel No.	Carrier Frequency [MHz]	Carrier Power [dBm]	Frequency Hopping	Max. Spurious Level [dBm]	Limit [dBm]	Result
9kHz-25GHz	0	2402	4.44	Off	-40.64	-15.6	Pass
9kHz-25GHz	40	2442	6.12	Off	-44.82	-13.9	Pass
9kHz-25GHz	78	2480	5.45	Off	-46.50	-14.6	Pass

6.7.5 Conclusion

The equipment **PASSED** the requirement of this clause.
For the measurement results refer to appendix G.

6.8 Radiated spurious emission & spurious in restricted band

6.8.1 Test Conditions

Table 46 Test Conditions

Preconditioning:	0.5 hour
Measured at:	Enclosure
Ambient temperature:	25 °C
Relative humidity:	55 %
Test Configurations:	TM1/TM2 at channel No.0, 40, 78

6.8.2 Test Specifications and Limits

6.8.2.1 Specification

CFR 47 (FCC) part 15.247 (d), 15.205 & 15.209 and DA 00-705

6.8.2.2 Supporting Standards

Table 47 Supporting Standards:

ANSI C63.10-2009	American National Standard for Testing Unlicensed Wireless Devices
ANSI C63.4: 2003	Methods of Measurement of Radio-Noise Emissions from Low Voltage Electrical and Electronic Equipment in the Range of 9 kHz to 40 GHz

6.8.2.3 Limits

According to part 15.247 (d) / 15.205 & 15.209, all spurious emission in the frequency range from 30MHz to 10th harmonics of carrier frequency should be meet the requirement of following table.

Table 48 Limits

Frequency (MHz)	Field Strength (μV/m)	Field Strength (dBμV/m)	Measurement Distance (meters)	Detector
30 - 88	100	40	3	QP
88 - 216	150	43.5	3	QP
216 - 960	200	46	3	QP
960 -1000	500	54	3	QP
Above 1000	500	54	3	AV
Above 1000	500	74	3	PK

In addition, radiated emissions which fall in the restricted bands, as defined in Section 15.205(a), also should comply with the radiated emission limits specified in Section 15.209(a) (see above table).

6.8.3 Test Method and Setup

The test site semi-anechoic chamber has met the requirement of NSA tolerance 4dB according to the standards: ANSI C63.4 (2003). The EUT was set-up on insulator 80cm above the Ground Plane. The

set-up and test methods were according to ANSI C63.4:2003. The Radiated Disturbance measurements were made using a Rohde and Schwarz Test Receiver and control software.

A preliminary scan and a final scan of the emissions were made by using test script of software; the emissions were measured using a Quasi-Peak Detector below 1GHz, Peak Detector and AV detector above 1GHz. The maximal emission value was acquired by adjusting the antenna height, polarisation and turntable azimuth in accordance with the software setup. Normally, the height range of antenna was 1m to 4m, the azimuth range of turntable was 0° to 360°, The receive antenna has two polarizations V and H.

A portable or small unlicensed wireless device shall be placed on a non-metallic test fixture or other nonmetallic support during testing. The supporting fixture shall permit orientation of the EUT in each of three orthogonal (x, y, z axes) axis positions such that emissions from the EUT are maximized.

The EUT was communicated with the BTS simulator through Air interface. The EUT transmits maximum output power at 2.4GHz and switch off frequency hopping function.

Measurement bandwidth: 30 MHz - 1000 MHz: 120 kHz

Measurement bandwidth: 1000 MHz - 10th Carrier Frequency: 1 MHz

Test set up

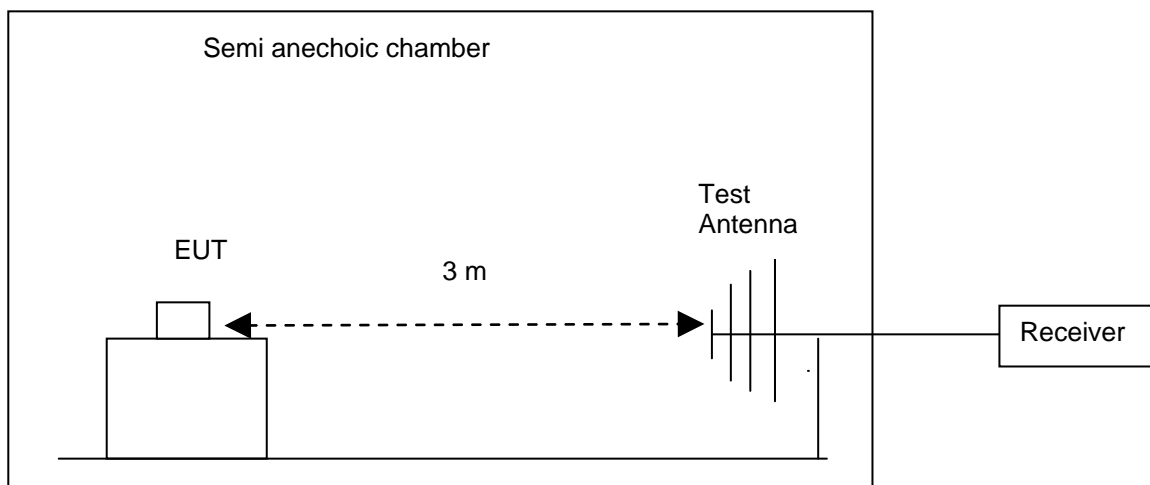

Figure 8. Test Set up

6.8.4 Measurement Results

Note 1: The following measurement results exceed the limit line is the carrier frequency.

Note 2: This test was carried out in all the test modes, here only the worst test result was shown.

Test Frequency Range	Channel No.	Carrier Frequency [MHz]	Measured	Result
30MHz-26.5GHz	0	2402	Refer to Appendix H	Pass
30MHz-26.5GHz	40	2442	Refer to Appendix H	Pass
30MHz-26.5GHz	78	2480	Refer to Appendix H	Pass

6.8.5 Conclusion

The equipment **PASSED** the requirement of this clause.



For the measurement results refer to appendix H.

6.9 Conducted Emission at Power Port

6.9.1 Test Conditions

Table 49 Test Conditions

Preconditioning:	0.5 hour
Measured at:	Power port
Ambient temperature:	25°C
Relative humidity:	55 %
Test Configurations:	TM1/TM2 at channel No. 40

6.9.2 Test Specifications and Limits

6.9.2.1 Specification

CFR 47 (FCC) part 15.207 and DA 00-705

6.9.2.2 Supporting Standards

Table 50 Supporting Standards:

ANSI C63.4: 2003	Methods of Measurement of Radio-Noise Emissions from Low Voltage Electrical and Electronic Equipment in the Range of 9 kHz to 40 GHz
------------------	--

6.9.2.3 Limits

Compliance with part15.207, conducted emission must meet the requirement of following table.

Table 51 Limits

Frequency of Emission (MHz)	Conducted Limit (dB μ V)	
	Quasi-peak	Average
0.15-0.5	66 to 56 *	56 to 46 *
0.5-5	56	46
5-30	60	50

Note: * Decreases with the logarithm of the frequency.

6.9.3 Test Method and Setup

The Table-top EUT was placed upon a non-metallic table 0.8 m above the horizontal metal reference ground plane. EUT was connected to LISN and LISN was connected to reference Ground Plane. EUT was 80cm from LISN. The set-up and test methods were according to ANSI C63.4: 2003.

Conducted Disturbance at AC Port measurements were undertaken on the L and N Lines. The emissions were measured using a Quasi-Peak Detector and Average Detector.

The EUT was communicated with the BTS simulator through Air interface, the BTS simulator controls the EUT to transmitter the maximum power which defined in specification of product. The EUT operated on the typical channel.

Measurement bandwidth (RBW) for 150kHz to 30 MHz: 9 kHz;

Test Set-up

The EUT was setup in the screened chamber and operated under nominal conditions.

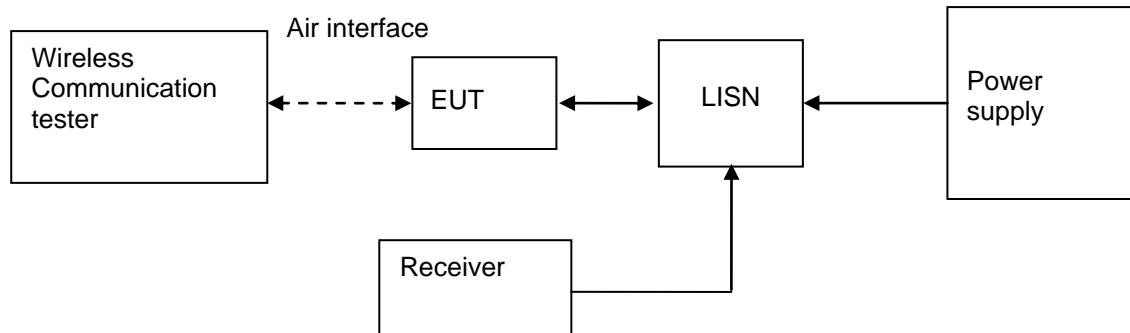

Figure 9. Test Set-up

6.9.4 Measurement Results

Table 52 MEASUREMENT RESULT:QP DECTER

Frequency MHz	Level dB μ V	Transd dB	Limit dB μ V	Margin dB	Line	PE
0.184000	37.90	10.1	64	26.1	L1	FLO
0.624000	44.30	10.1	56	11.7	N	FLO
1.936000	43.90	10.1	56	12.1	N	FLO
3.062000	45.10	10.2	56	10.9	N	FLO
5.354000	36.60	10.2	60	23.4	N	FLO
17.106000	44.50	10.3	60	15.5	N	FLO

Table 53 MEASUREMENT RESULT:AV DECTER

Frequency MHz	Level dB μ V	Transd dB	Limit dB μ V	Margin dB	Line	PE
0.326000	26.50	10.0	50	23.5	N	FLO
0.626000	30.90	10.1	46	15.1	N	FLO
1.680000	32.90	10.1	46	13.1	N	FLO
3.206000	34.30	10.2	46	11.7	N	FLO
11.966000	28.50	10.3	50	21.5	N	FLO
15.904000	35.90	10.3	50	14.1	N	FLO

6.9.5 Conclusion

The equipment **PASSED** the requirement of this clause.
For the measurement results refer to appendix I.



7 System Measurement Uncertainty

For a 95% confidence level, the measurement expanded uncertainties for defined systems, in accordance with the recommendations of ISO 17025 as following:

Table 54 System Measurement Uncertainty

Items		Extended Uncertainty
20dB bandwidth measurement	Magnitude (%)	U=0.2%; k=2
Carrier frequency separation measurement	Magnitude (%)	U=0.2%; k=2
Time of occupancy	Magnitude (%)	U=0.2%; k=2
Peak output power	Power(dBm)	U=0.39dB; k=2
Band edge compliance measurement	Disturbance Power(dBm)	U=2.0dB; k=2
Conducted RF spurious	Disturbance Power(dBm)	U=2.0dB; k=2
Radiated spurious emission & Radiated restricted band measurement	Field strength (dB μ V/m)	U=2.2dB; k=2 U=5dB; k=2
Conducted emission test for power port	Disturbance Voltage(dB μ V)	U=4dB; k=2



8 Appendices List

Appendix A	Measurement Results Bandwidth measurement
Appendix B	Measurement Results Carrier frequency separation measurement
Appendix C	Measurement Results Number of hopping channel
Appendix D	Measurement Results Time of occupancy
Appendix E	Measurement Results Peak output power
Appendix F	Measurement Results Band edge compliance measurement
Appendix G	Measurement Results Conducted RF spurious
Appendix H	Measurement Results Radiated spurious emission
Appendix I	Measurement Results Conducted emission test for power port
Appendix J	Photos of Test Setup

----- End of Report -----



Appendix A

Bandwidth measurement

According to FCC Part 15.247 (a) (1)



Modulation: $\pi/4$ -DQPSK Channel 0 (2402MHz)

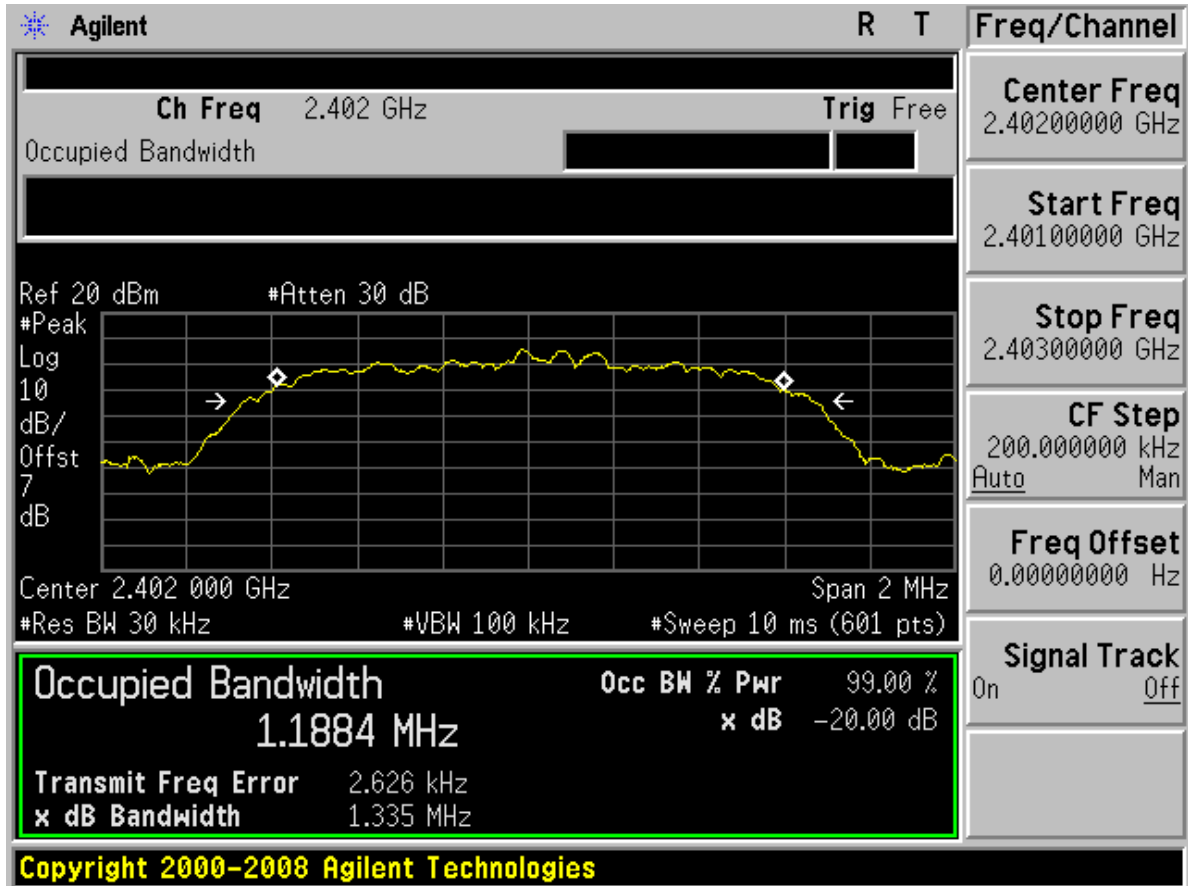



Channel 40 (2442MHz)

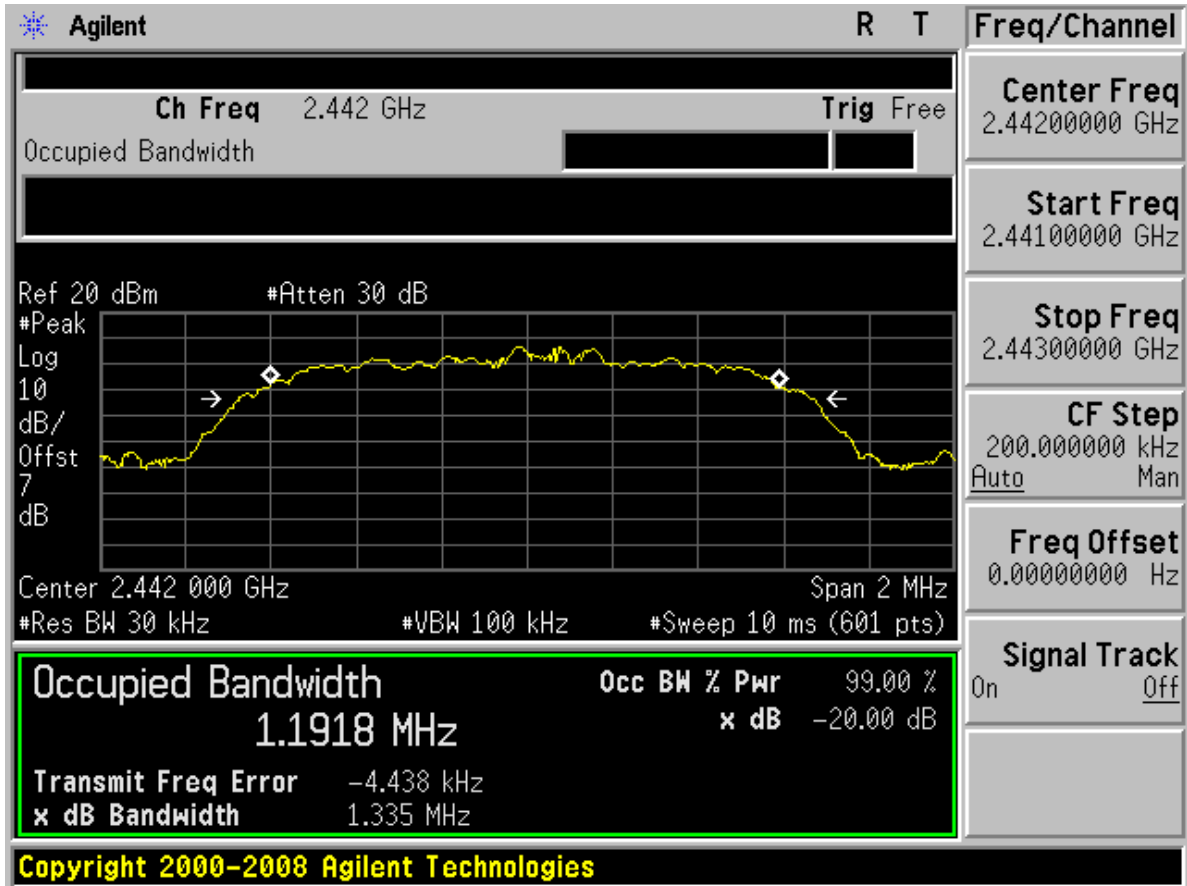



Channel 78 (2480MHz)

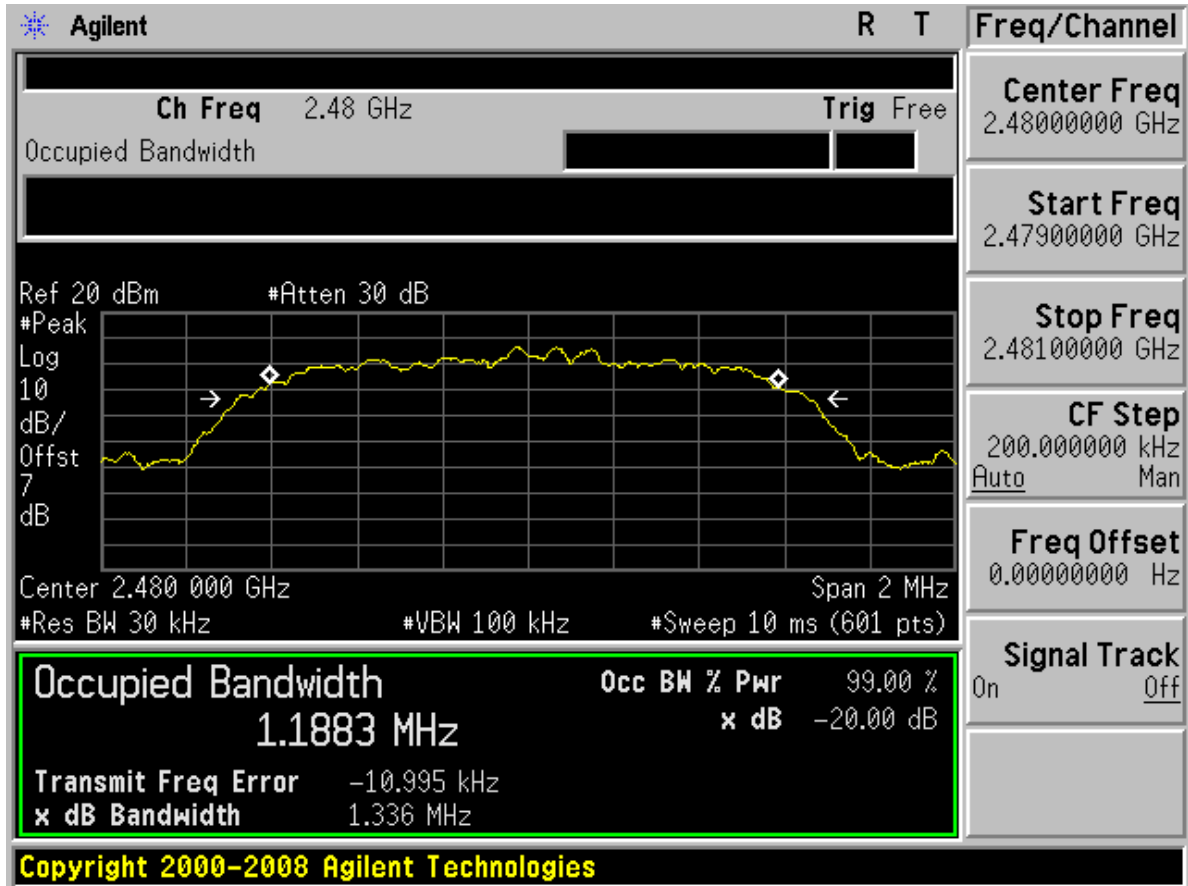



Modulation:8DPSK Channel 0 (2402MHz)

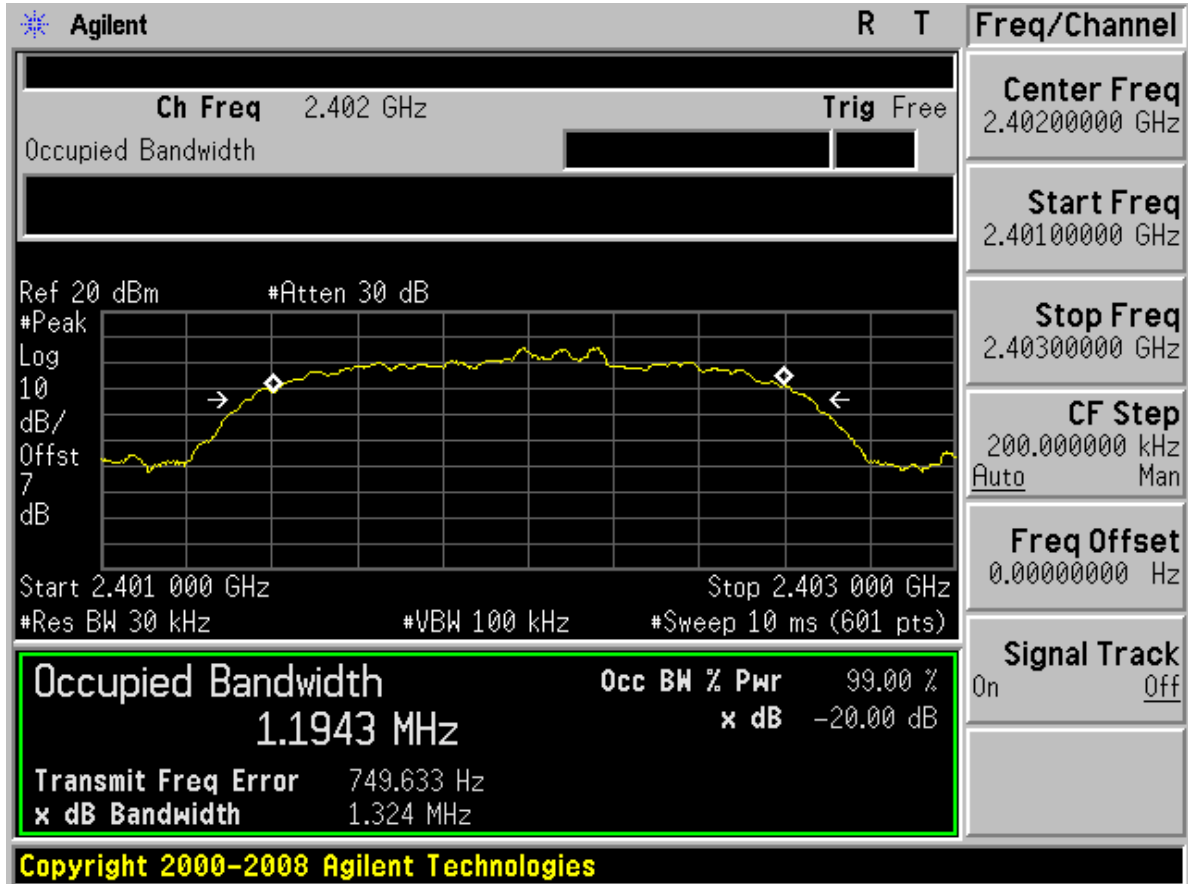



Channel 40 (2442MHz)

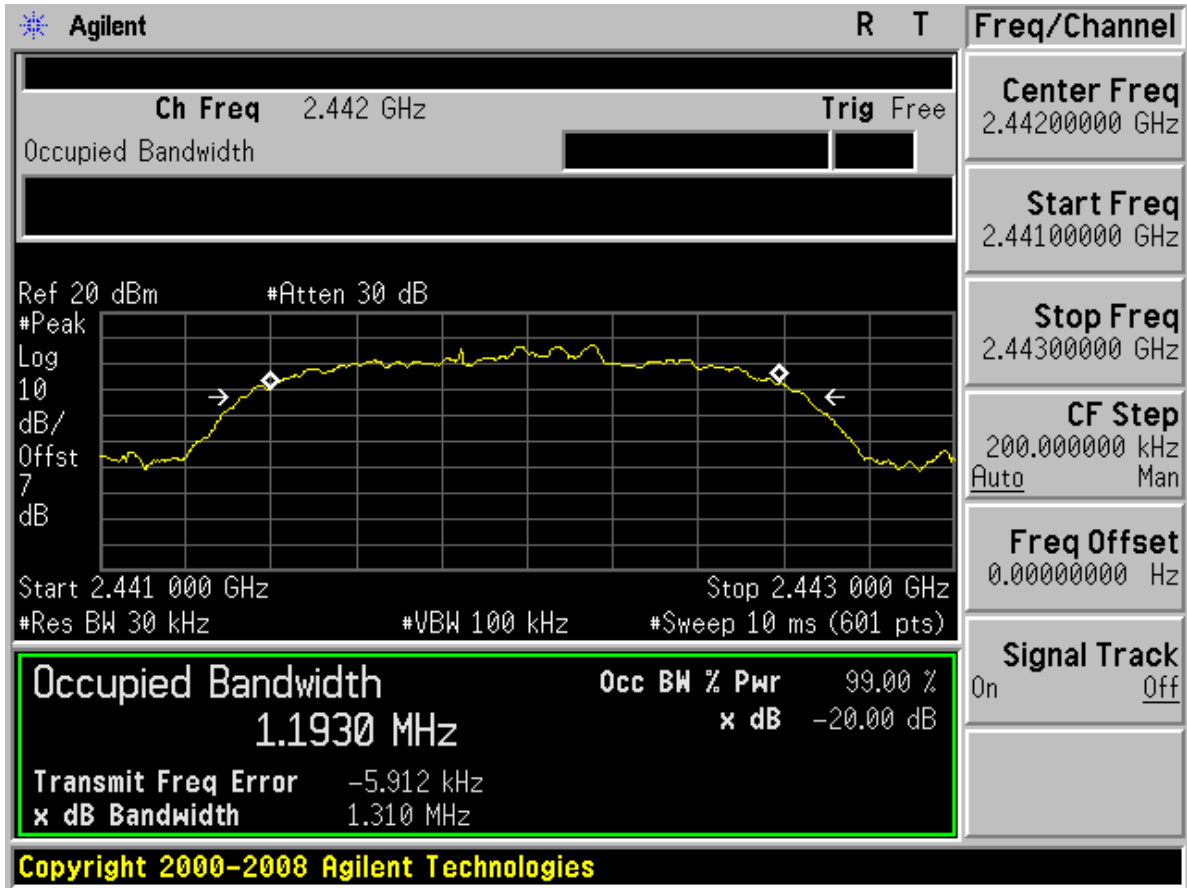



Channel 78 (2480MHz)

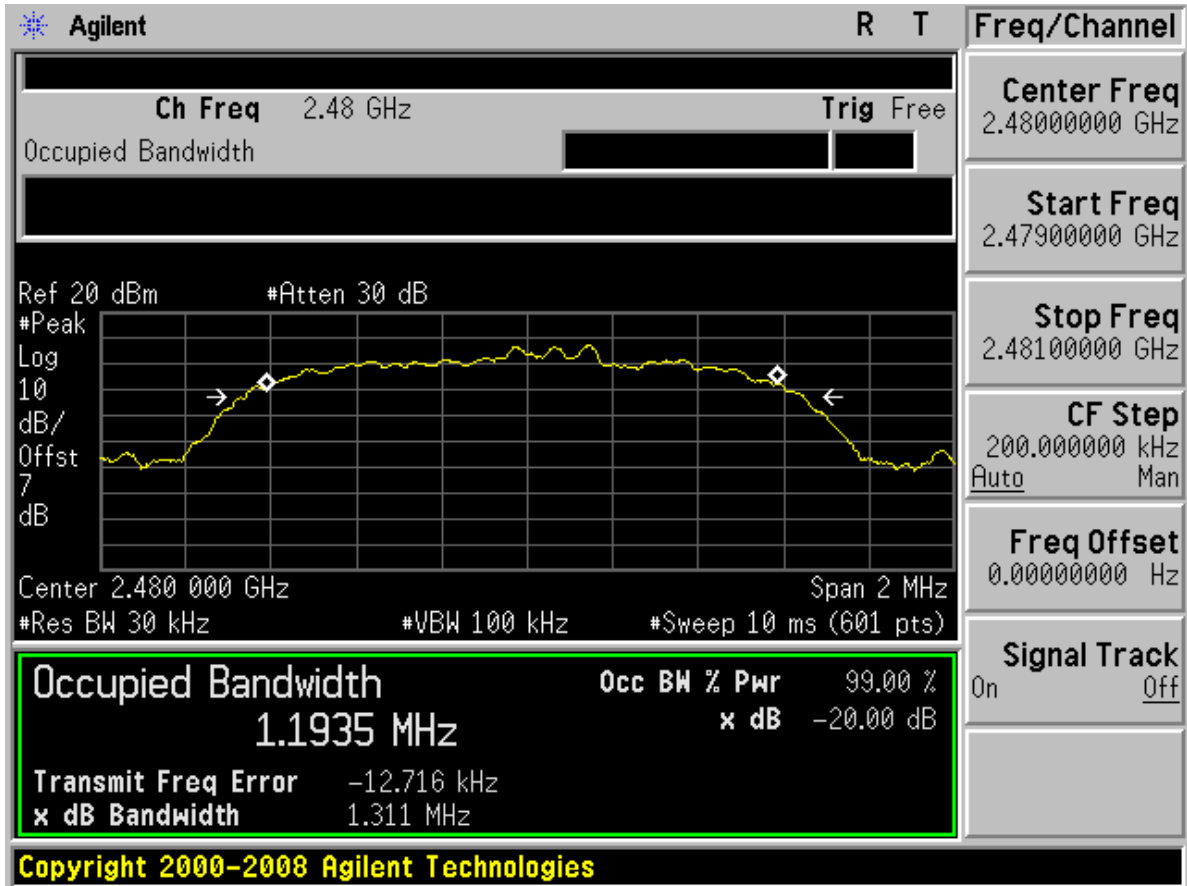

----- End of Report -----



Appendix B

Carrier frequency separation measurement

According to FCC Part 15.247 (a) (1)



Modulation: $\pi/4$ -DQPSK Centred at Channel 40

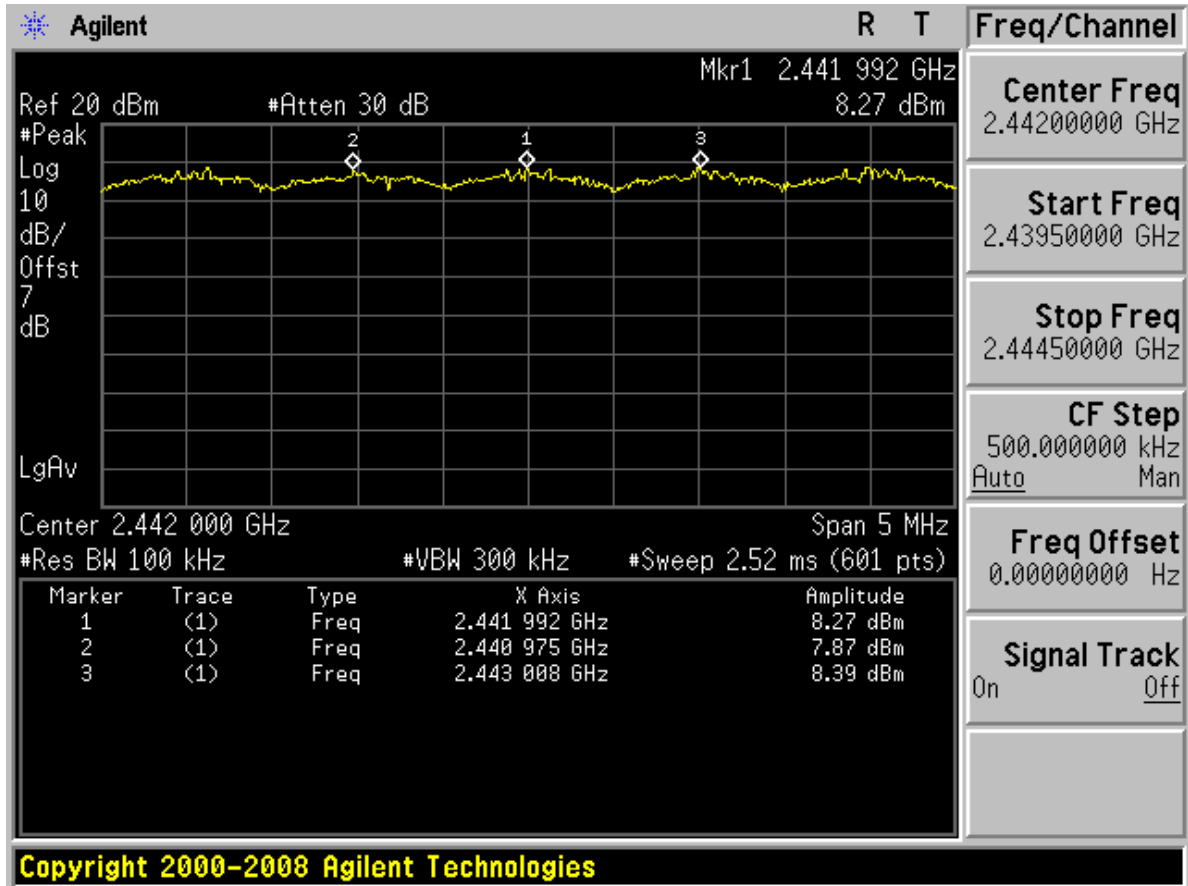



Modulation:8DPSK Centred at Channel 40

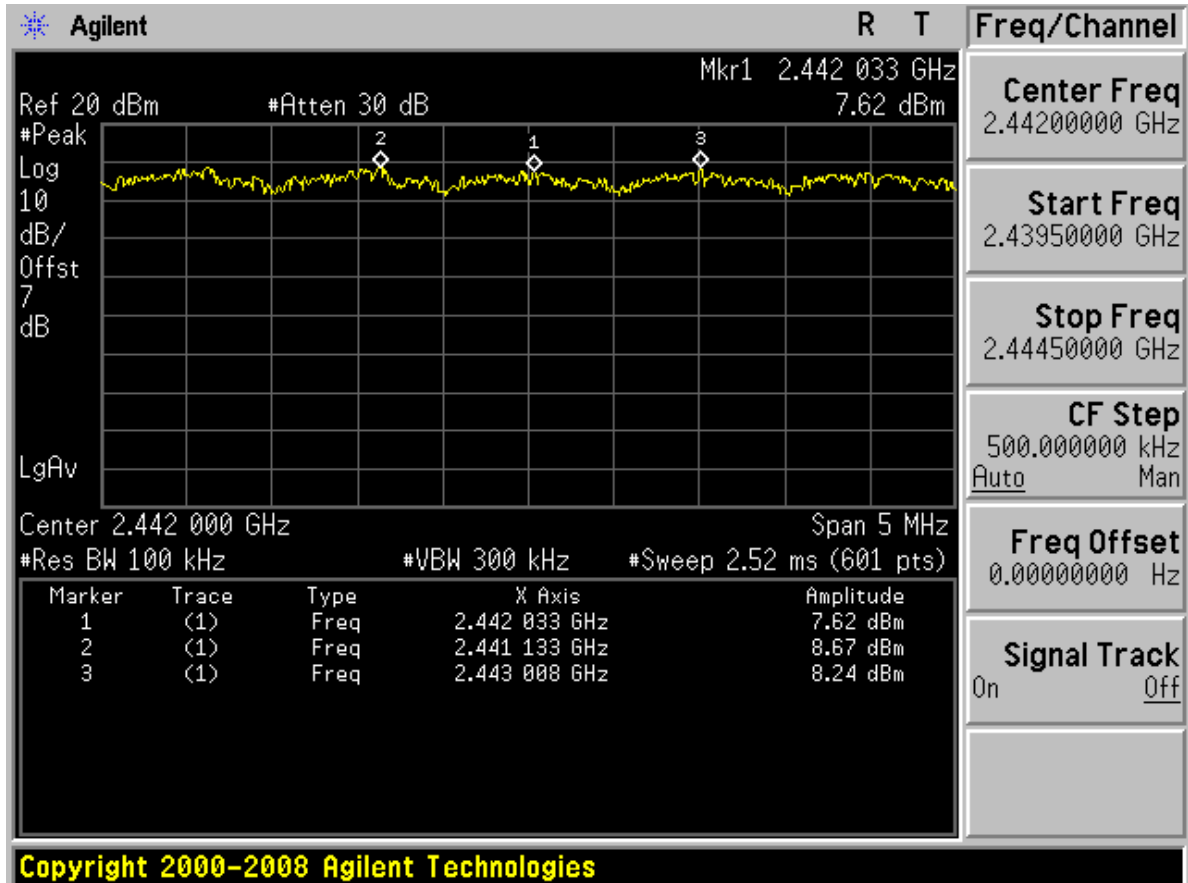

----- End of Report -----



Appendix C

Number of hopping channel

According to FCC Part 15.247 (a) (1) iii



Modulation: $\pi/4$ -DQPSK

Total hopping channels = 79

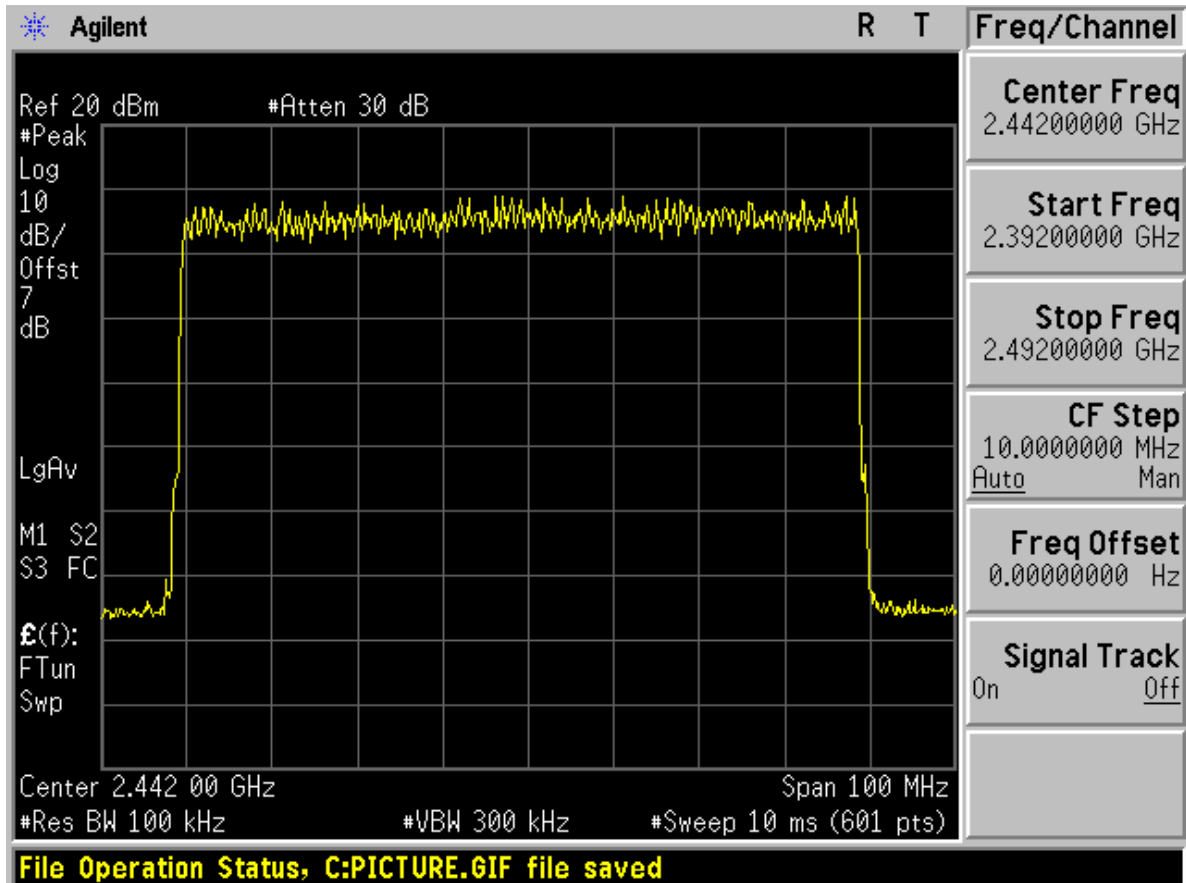



Modulation:8DPSK

Total hopping channels = 79

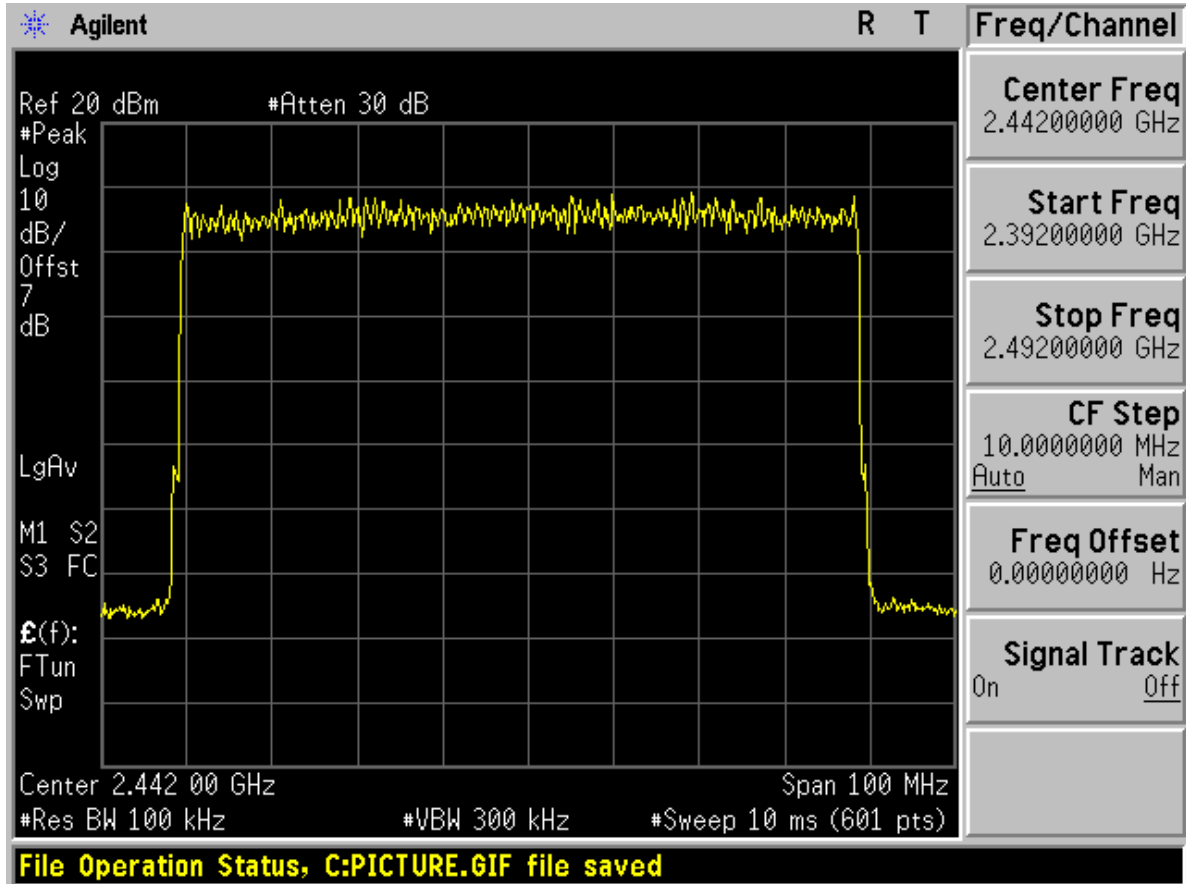

----- End of Report -----



Appendix D

Time of occupancy

According to FCC Part 15.247 (a) (1) iii



Modulation: $\pi/4$ -DQPSK A burst (One time slot)

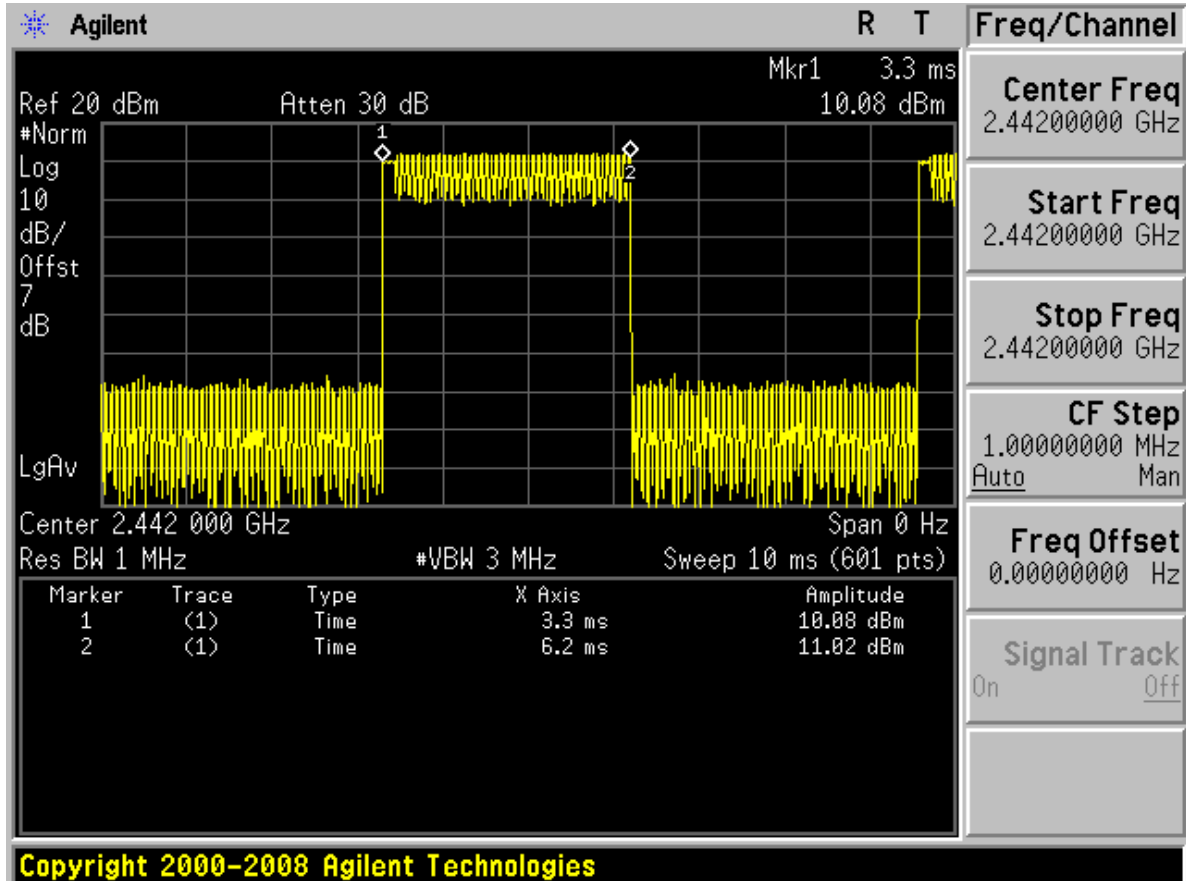



A period (Less than 106.7 burst)

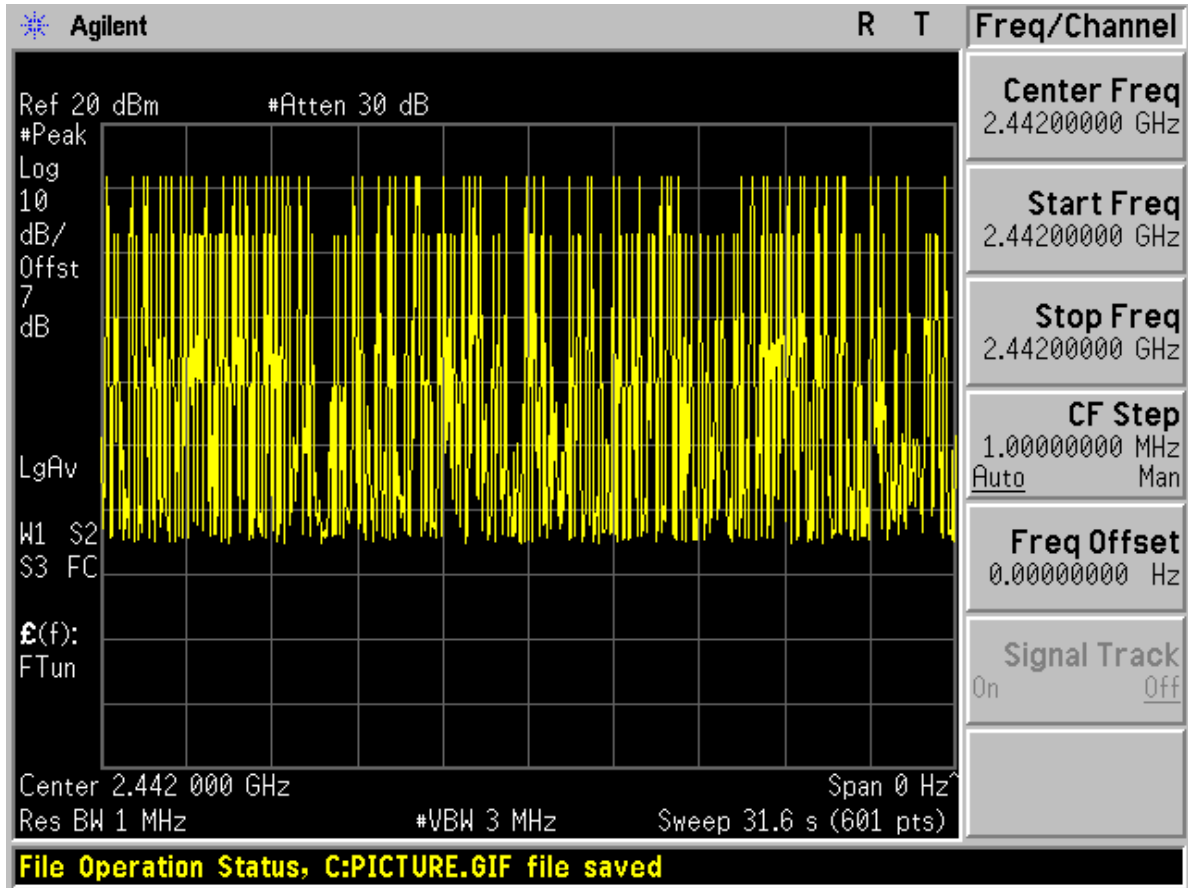



Modulation:8DPSK A burst (One time slot)

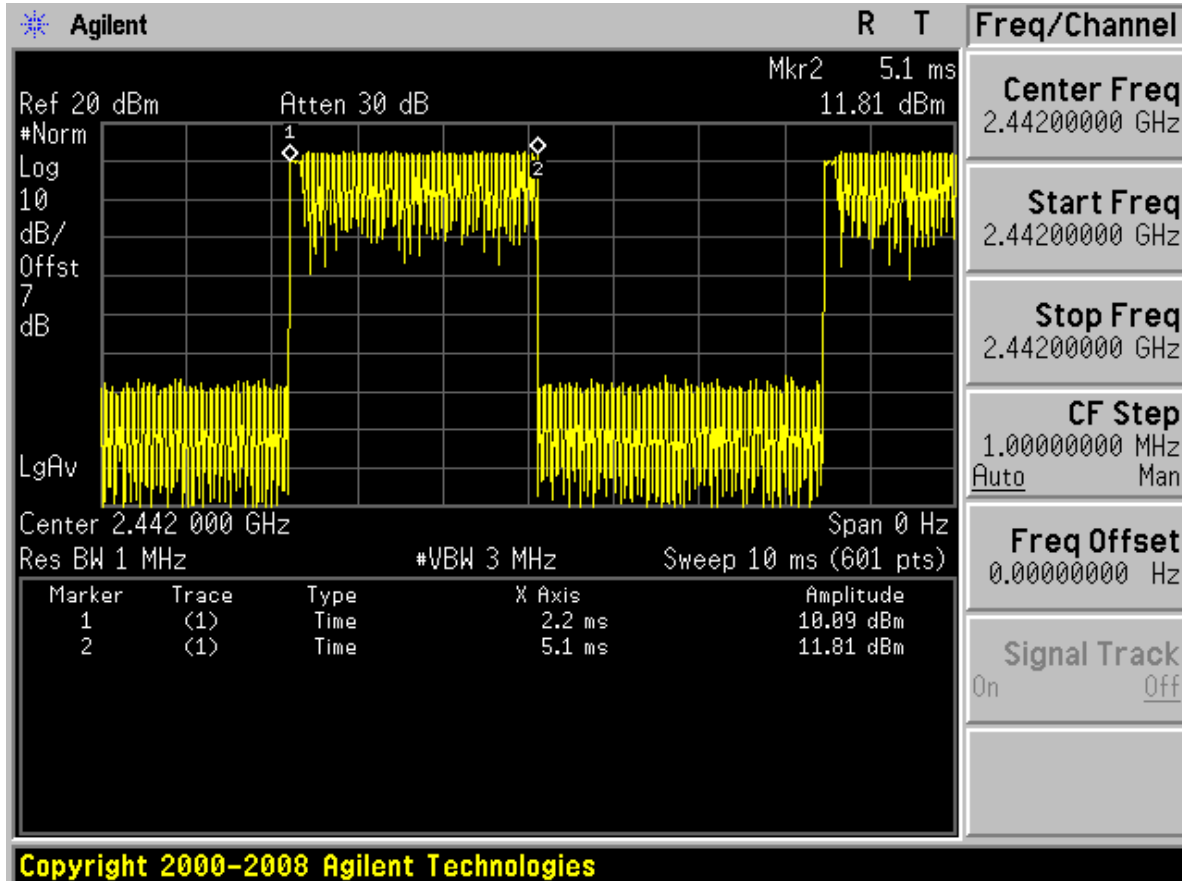



A period (Less than 106.7 burst)

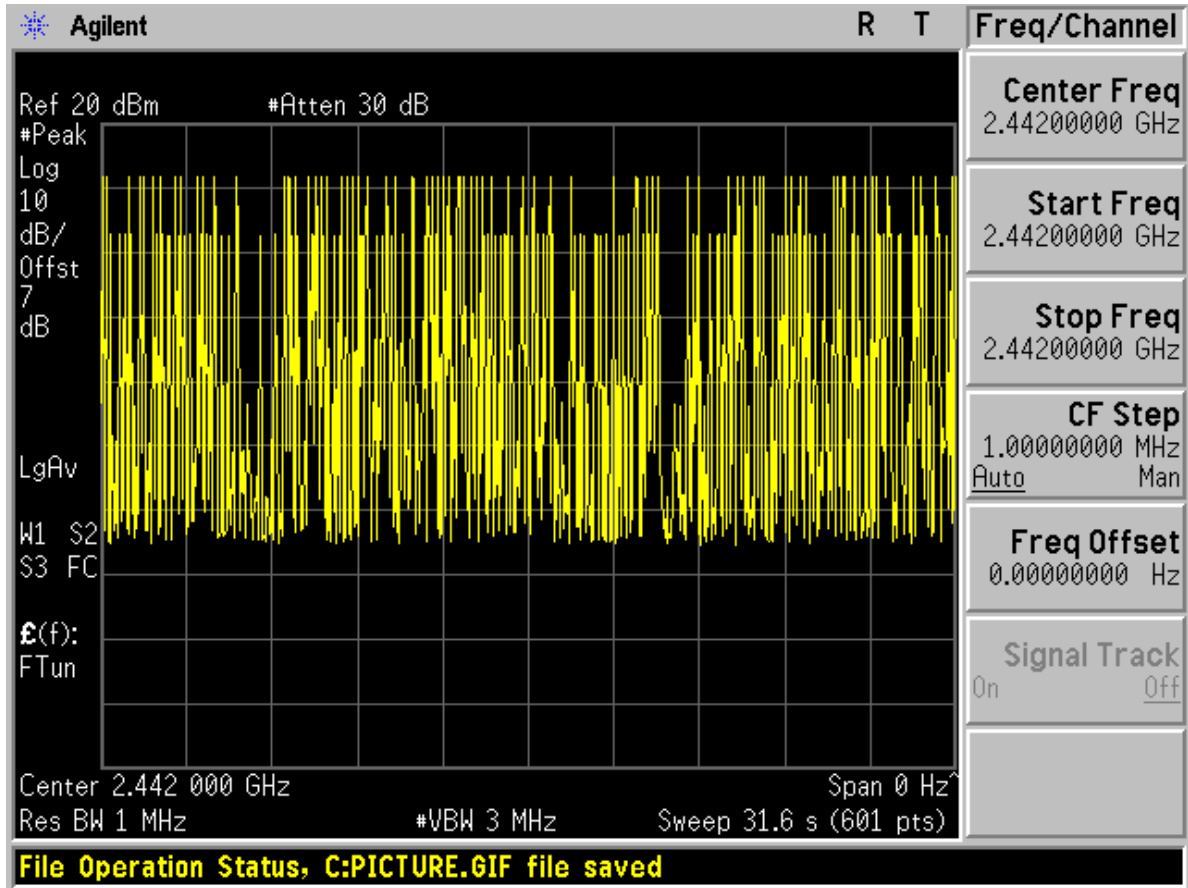

----- End of Report -----



Appendix E

Peak output power

According to FCC Part 15.247 (b) (1)



Modulation: $\pi/4$ -DQPSK Channel 0 (2402MHz)

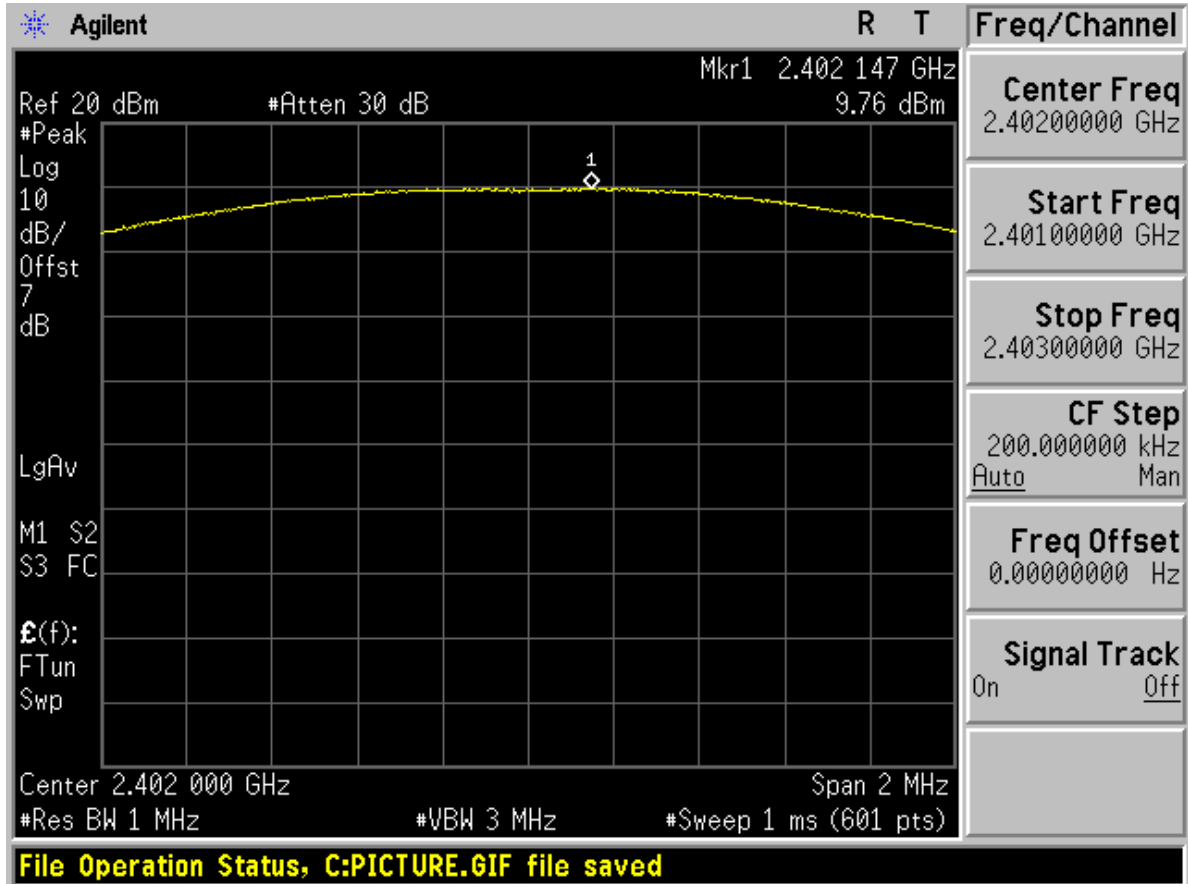



Channel 40 (2442MHz)

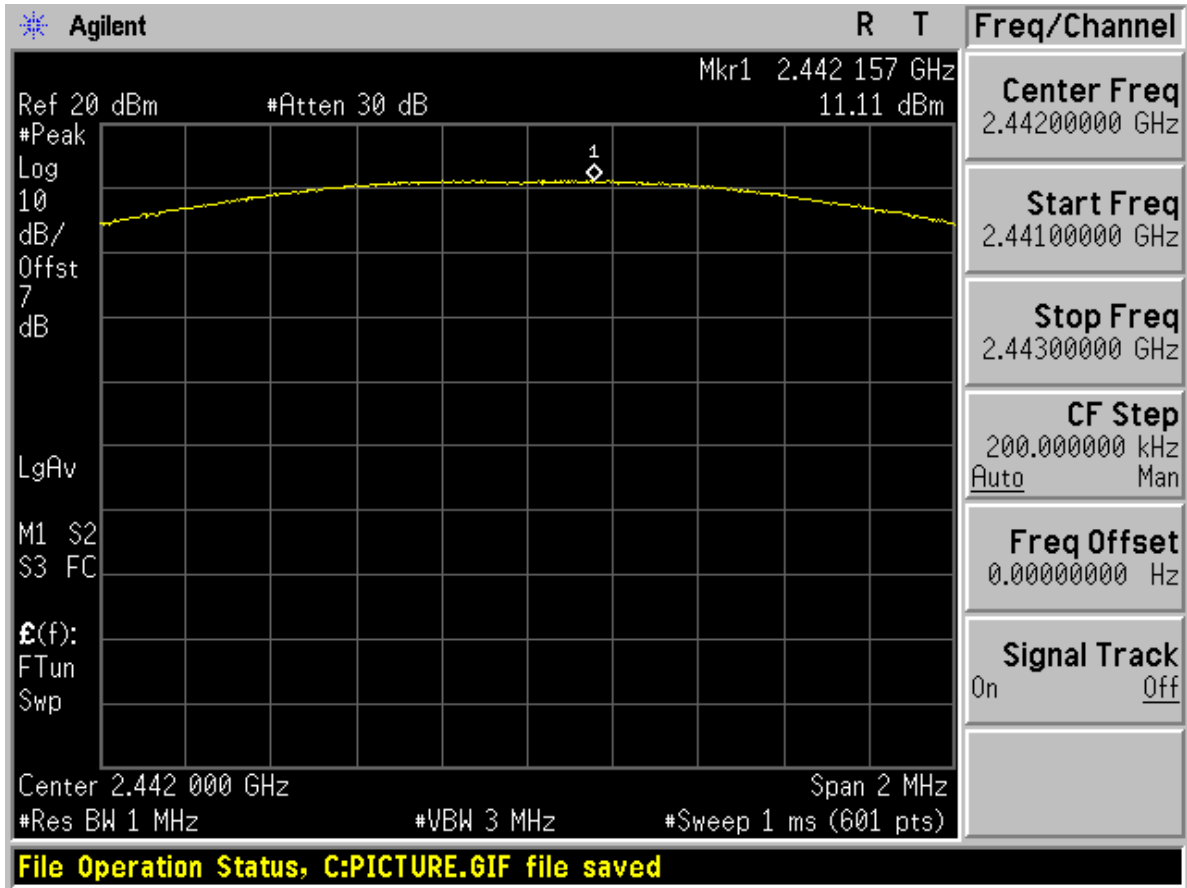



Channel 78 (2480MHz)

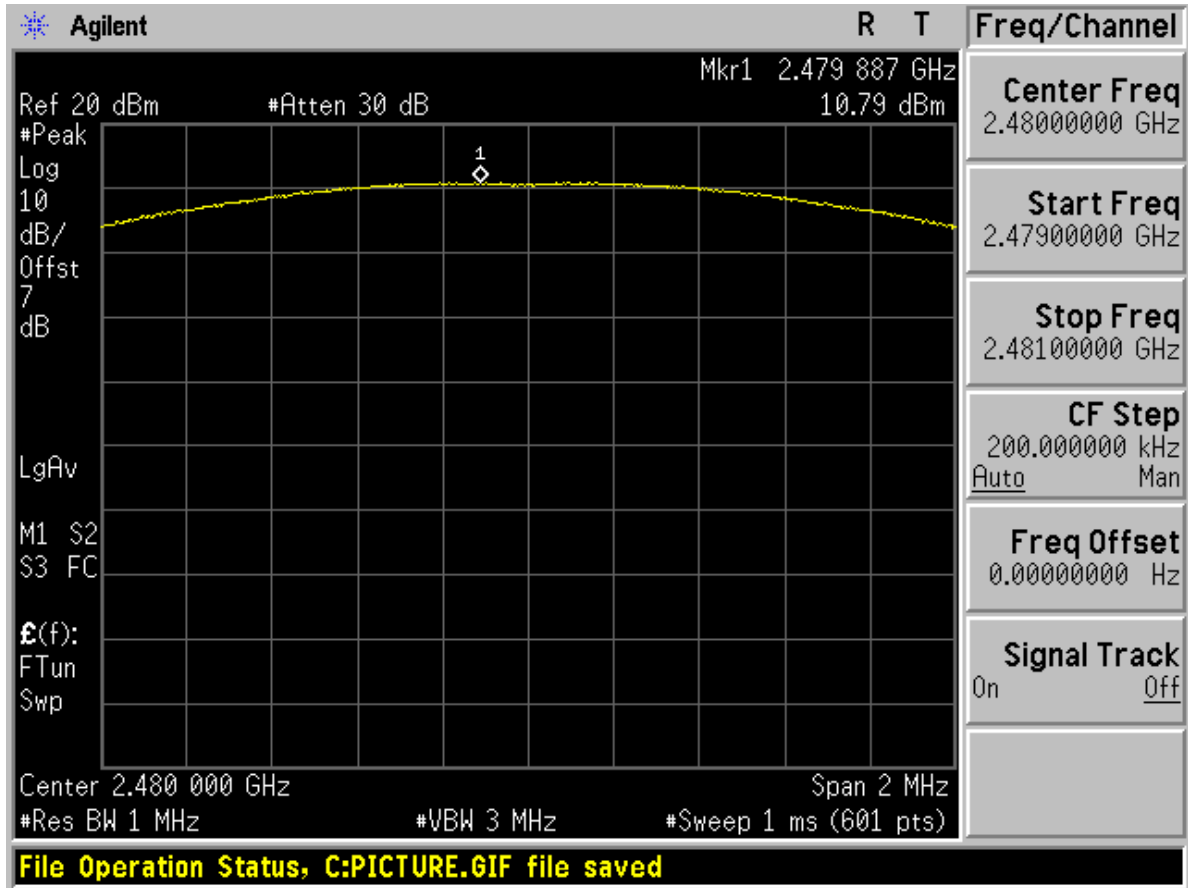



Modulation:8DPSK Channel 0 (2402MHz)

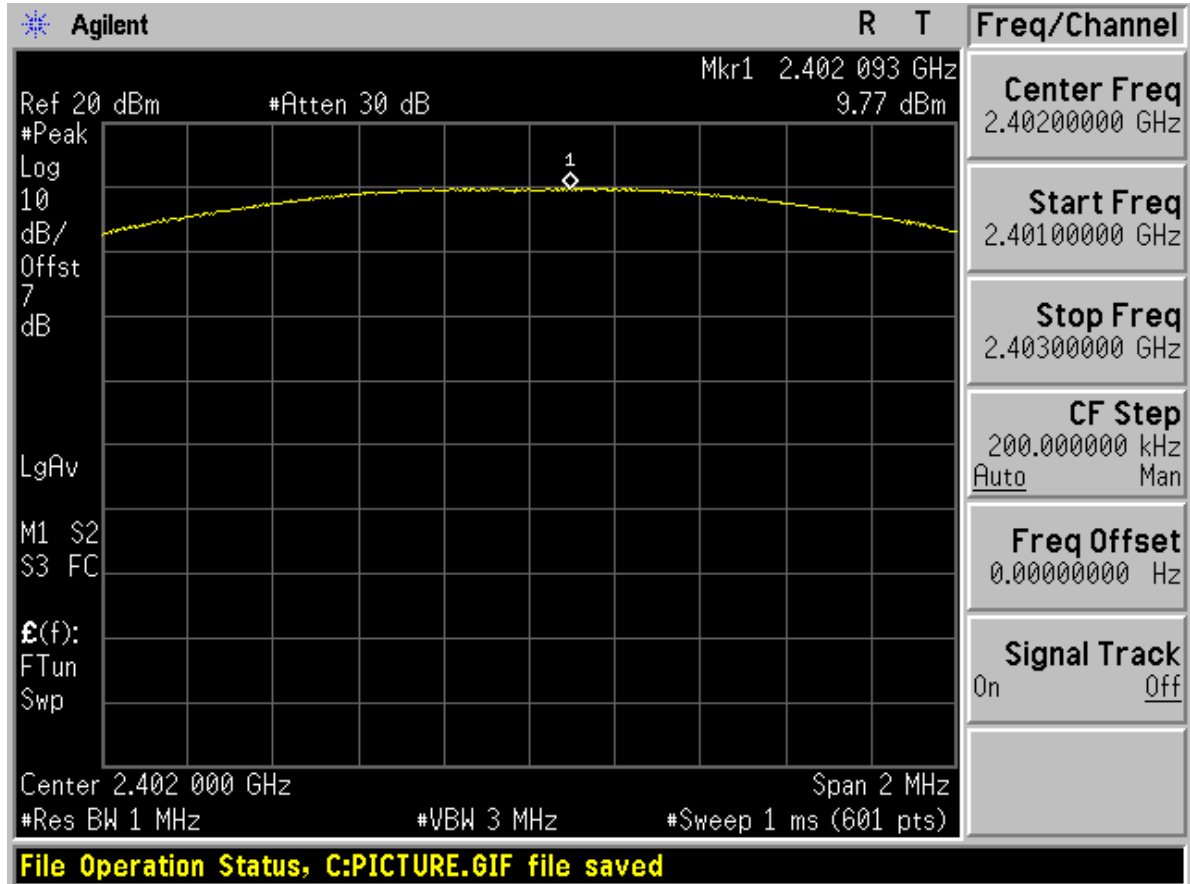



Channel 40 (2442MHz)

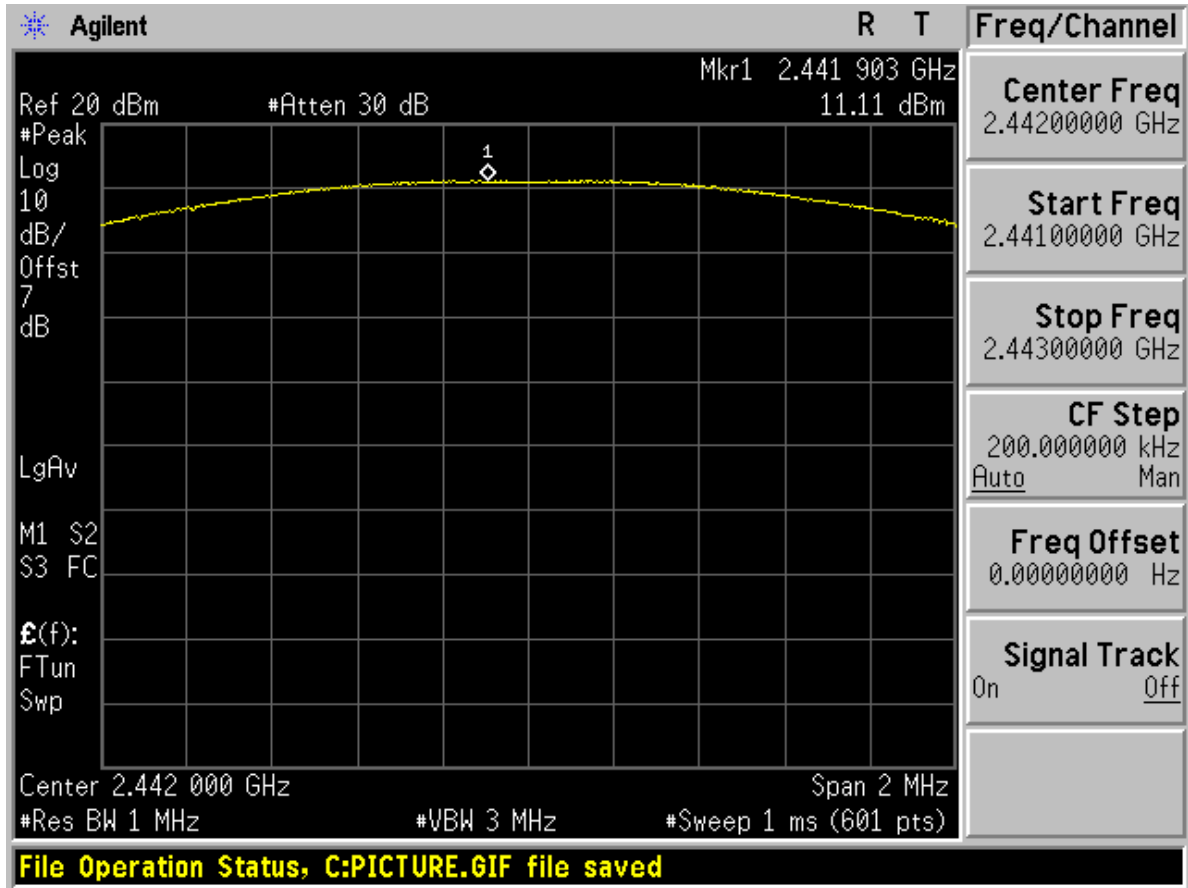



Channel 78 (2480MHz)

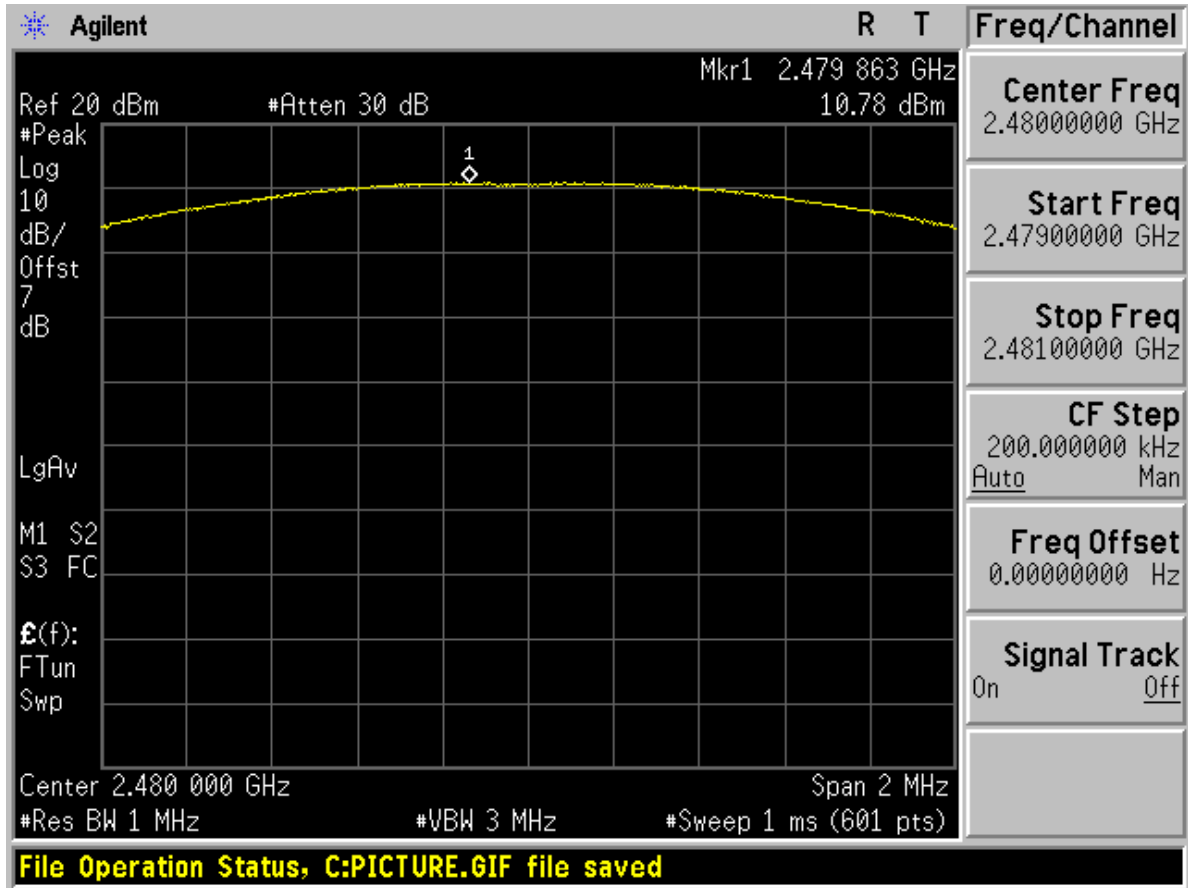

----- End of Report -----



Appendix F

Band edge spurious emission

According to FCC Part 15.247 (d)



Modulation: $\pi/4$ -DQPSK Low edge (Channel 0, no hopping)

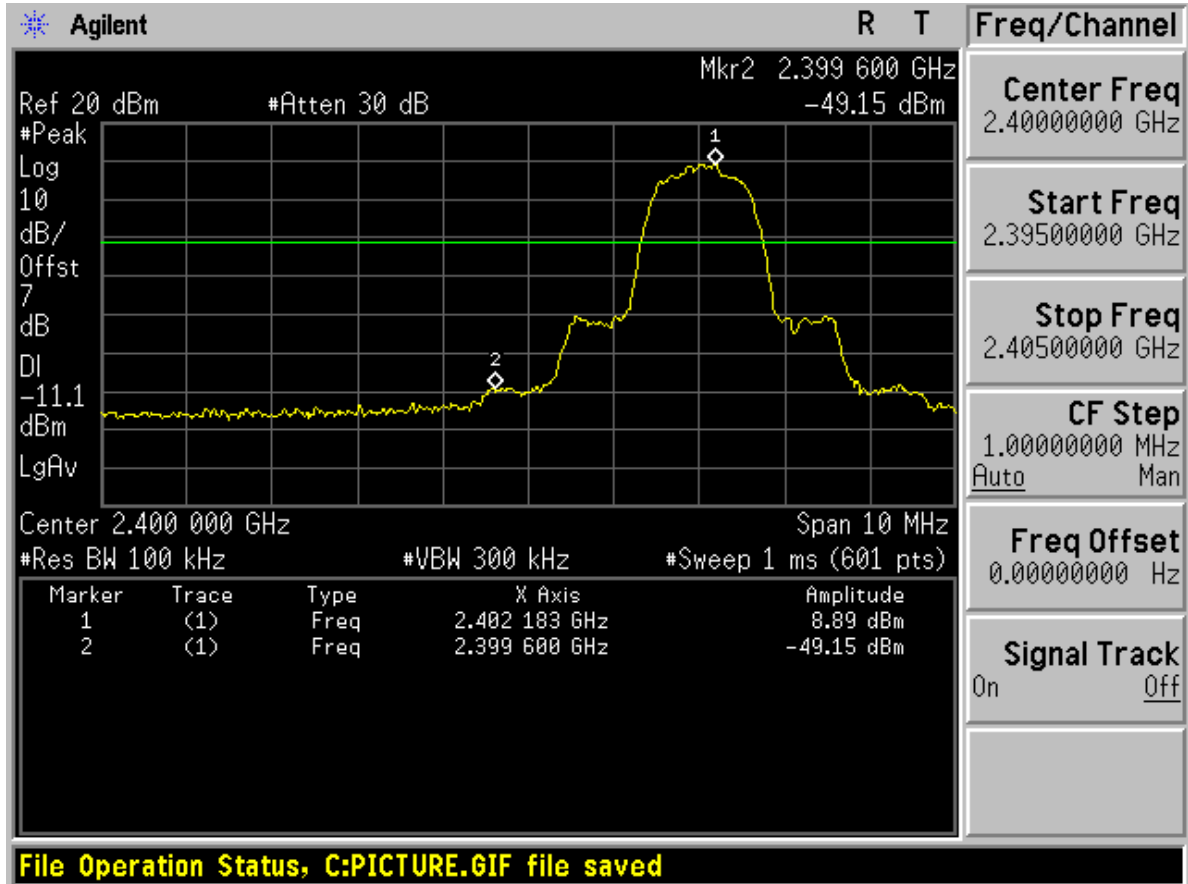



Low edge (with hopping)

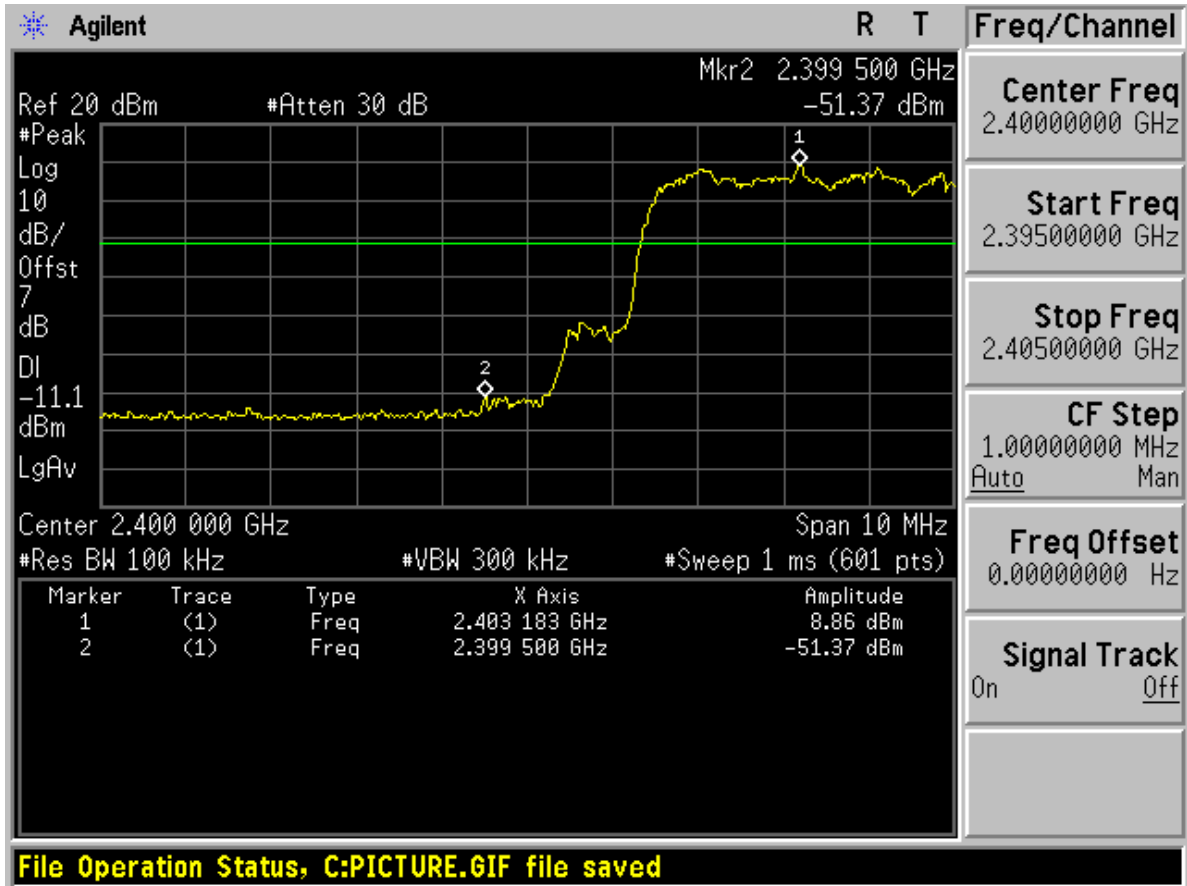



High edge (Channel 78, no hopping)

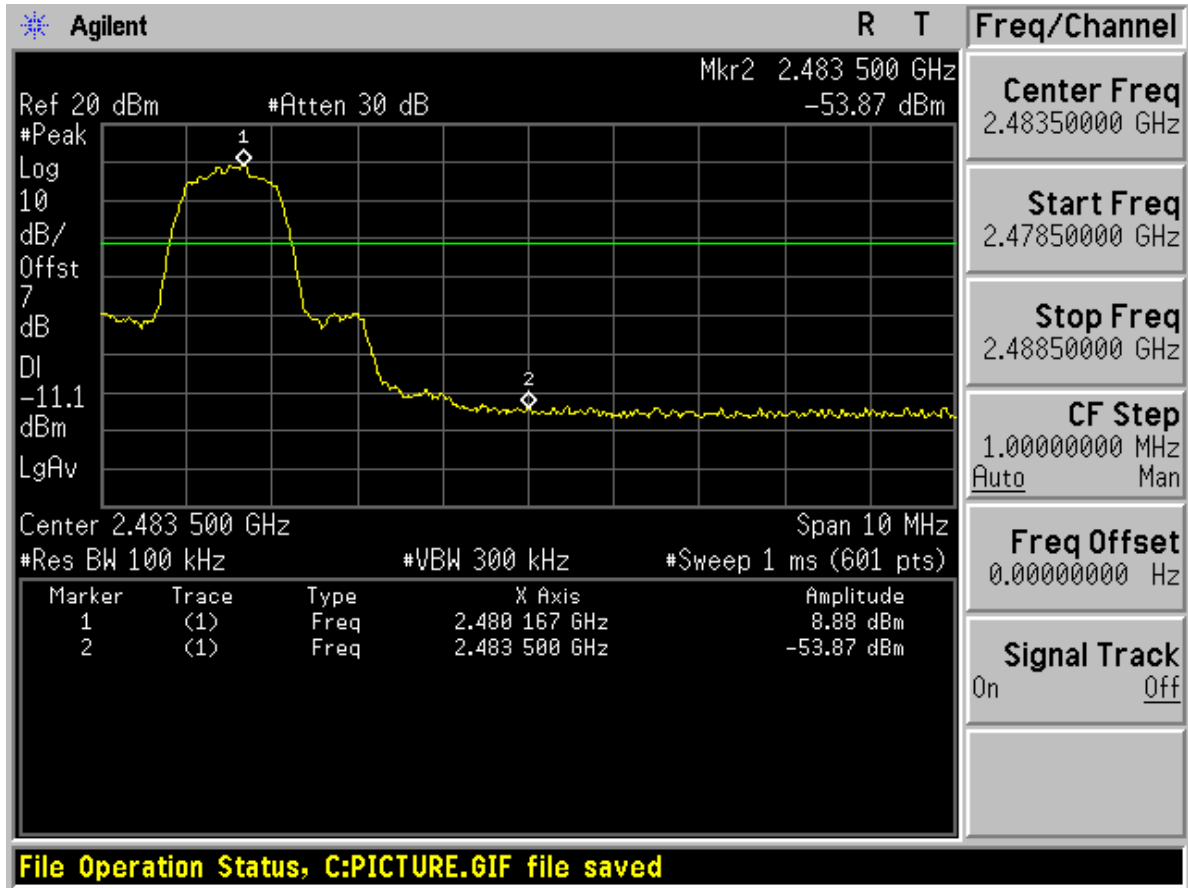



High edge (with hopping)

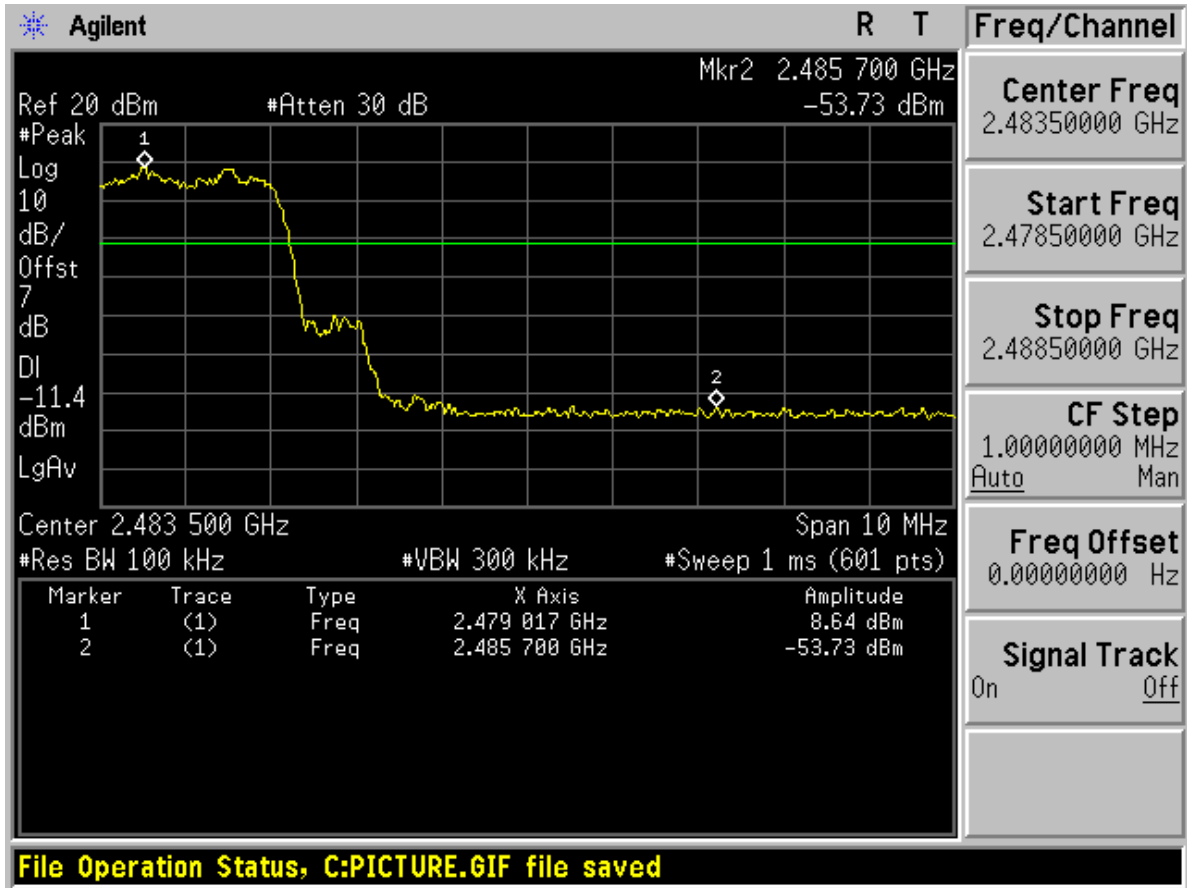



Modulation:8DPSK Low edge (Channel 0, no hopping)

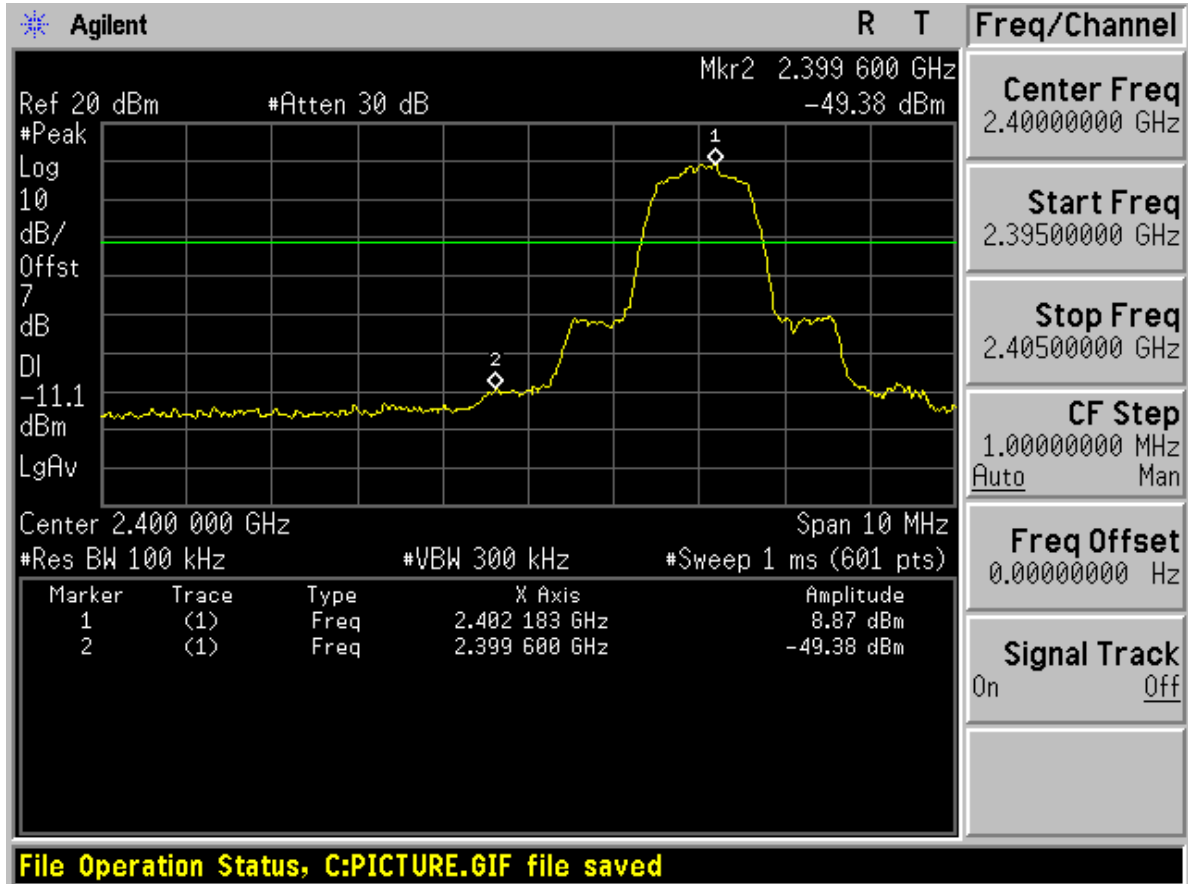



Low edge (with hopping)

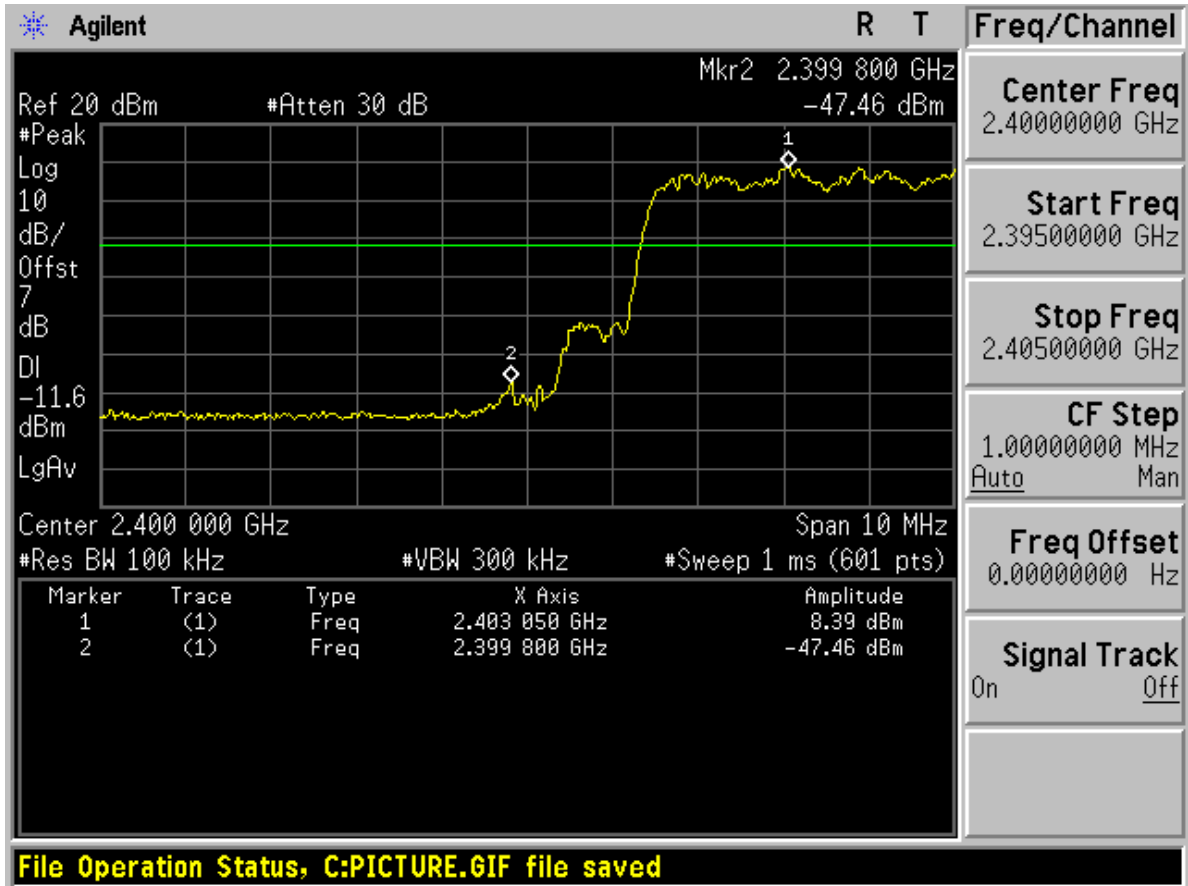



High edge (Channel 78, no hopping)

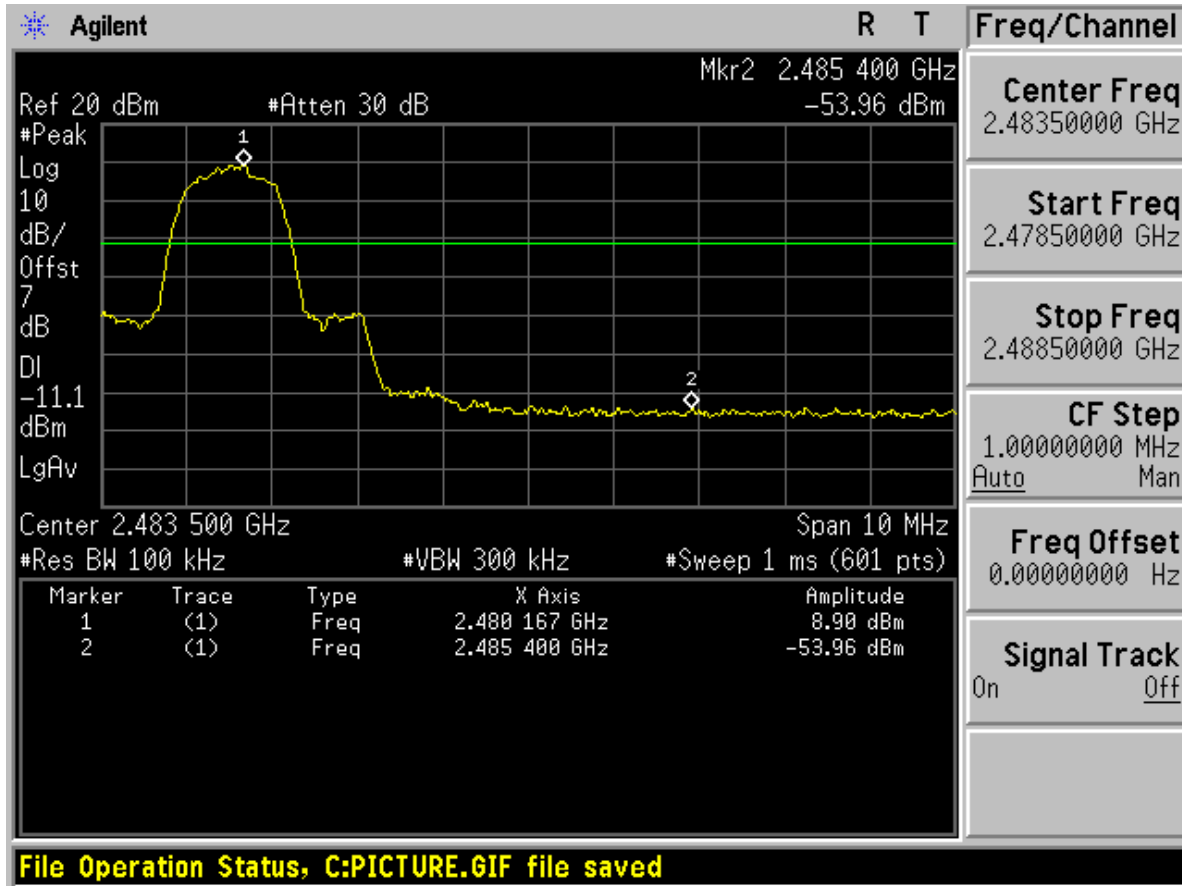



High edge (with hopping)

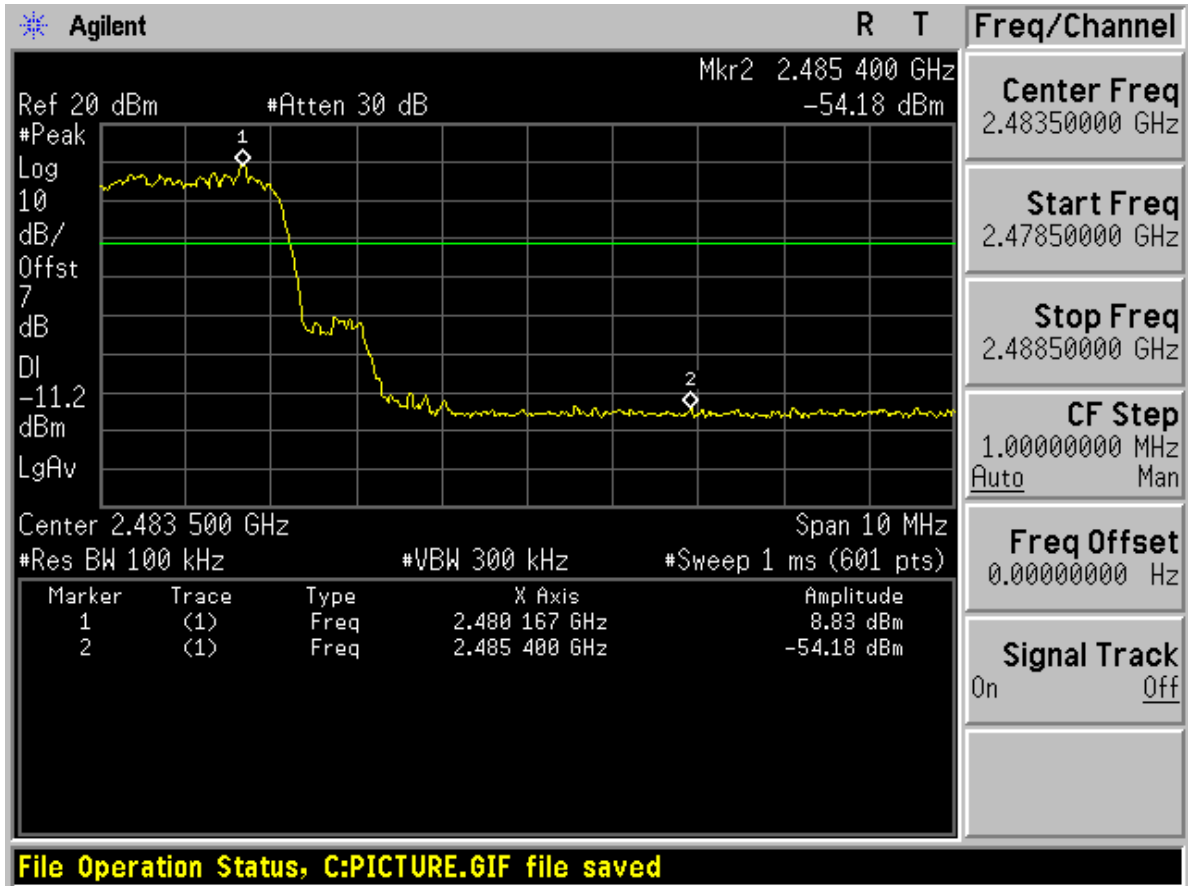

----- End of Report -----



Appendix G

Conducted RF spurious

According to FCC Part 15.247 (d)



Modulation: $\pi/4$ -DQPSK Channel 0

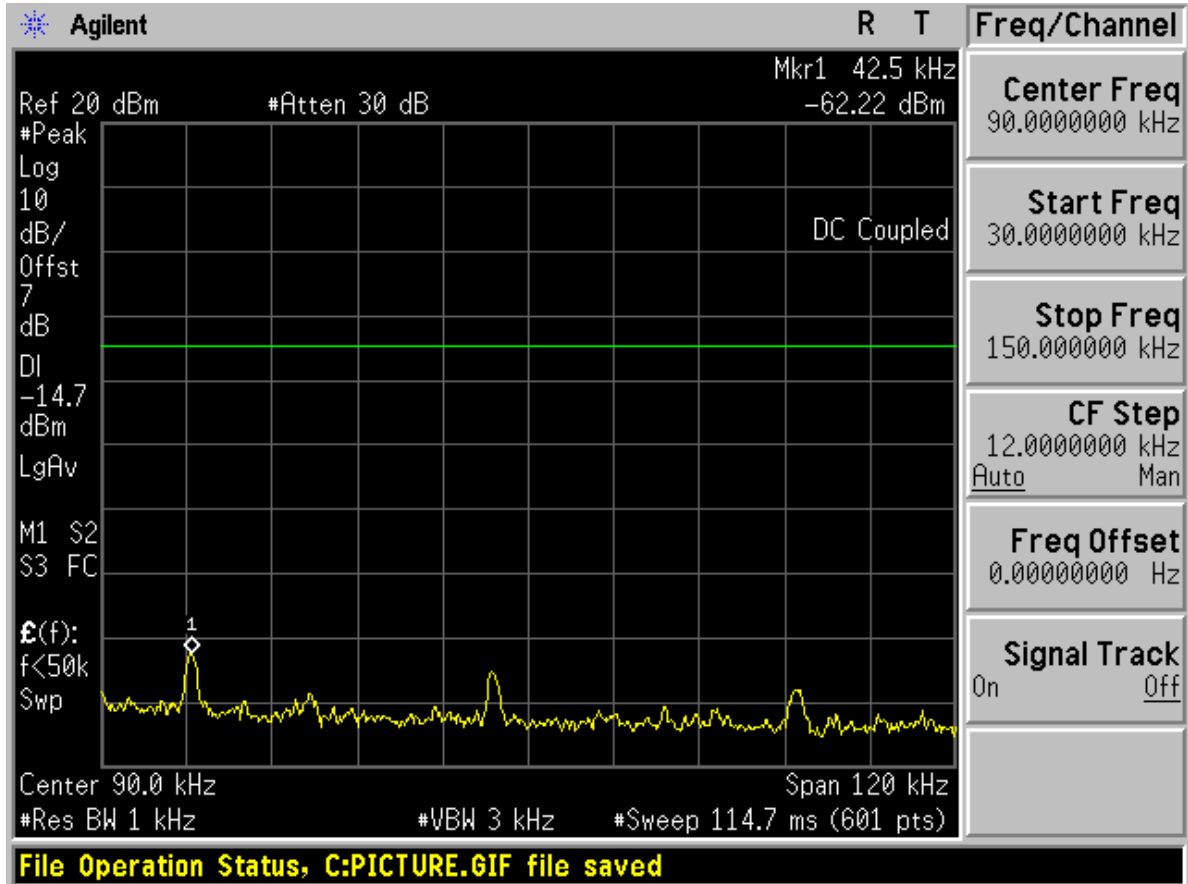

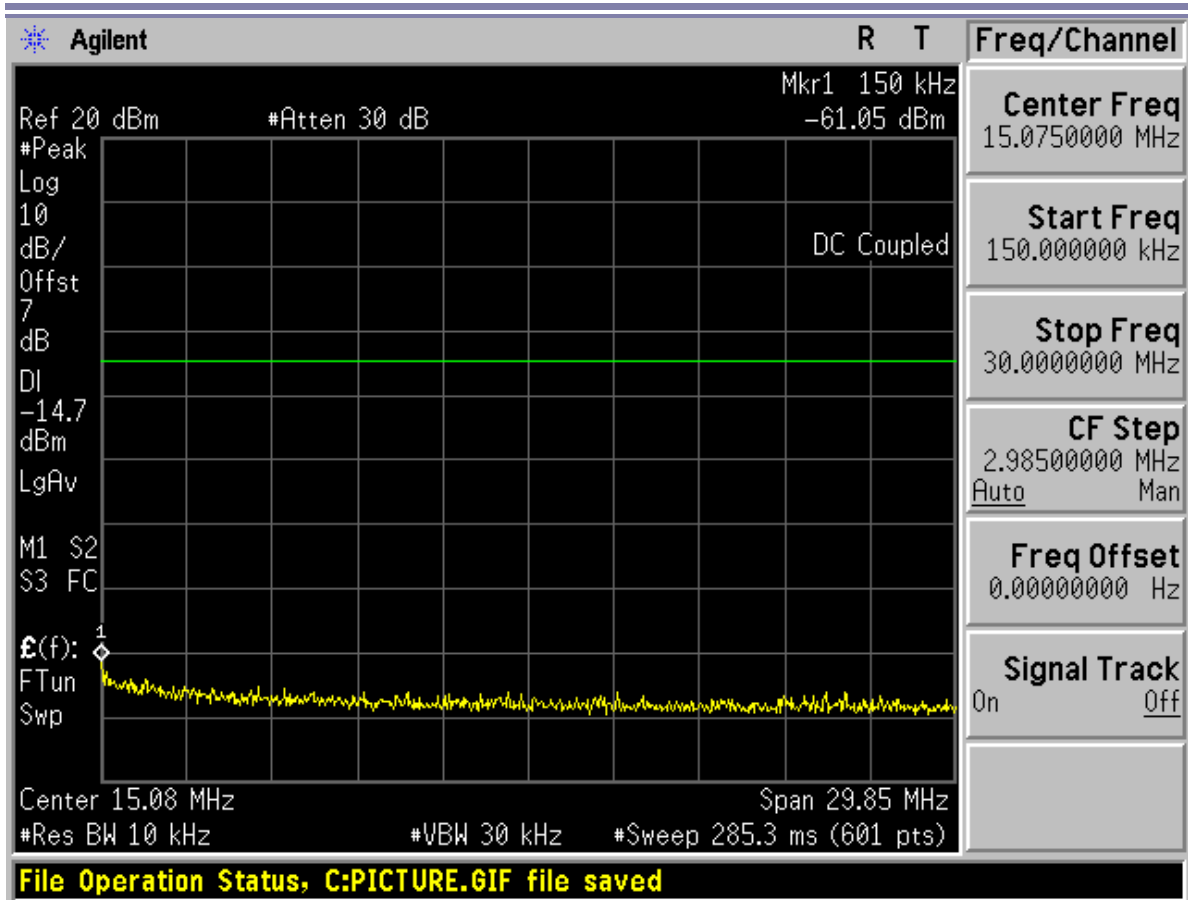

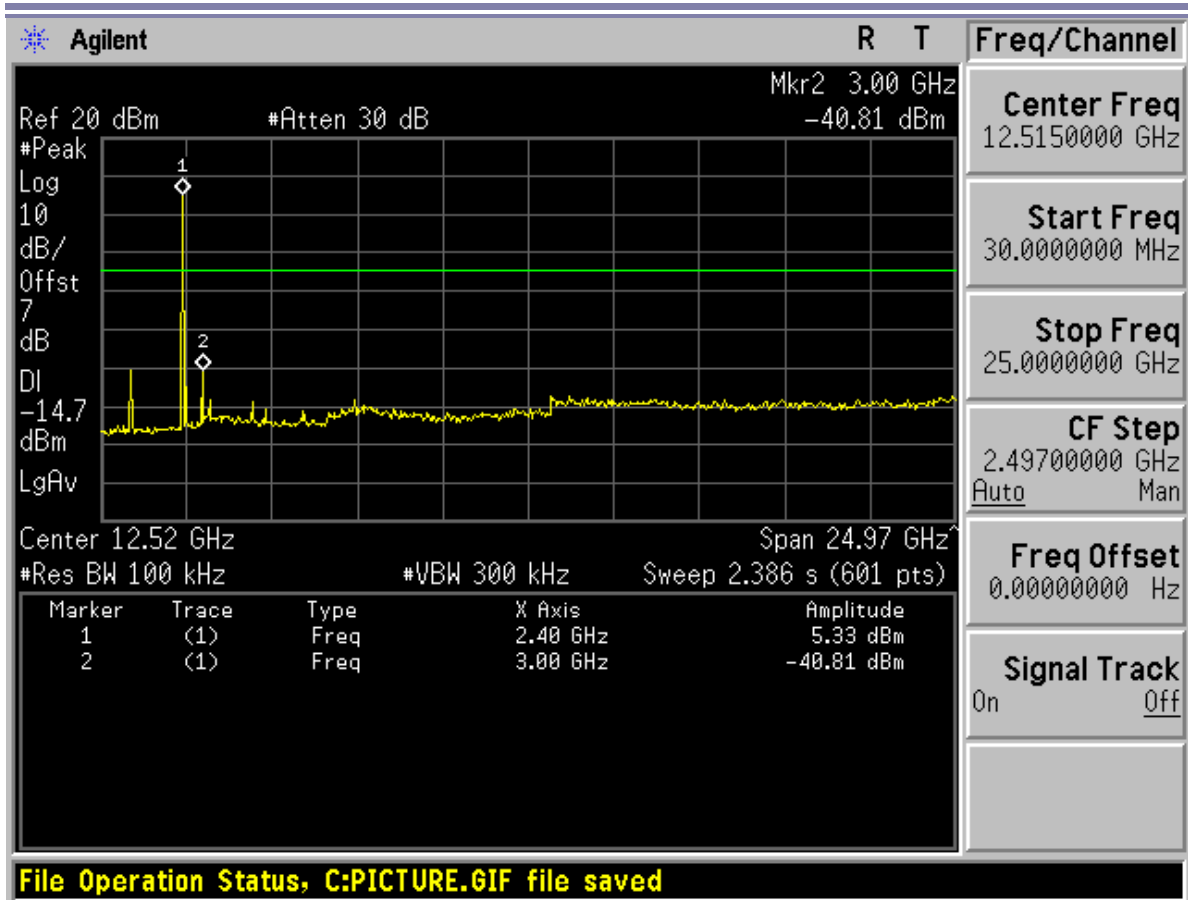



Channel 40

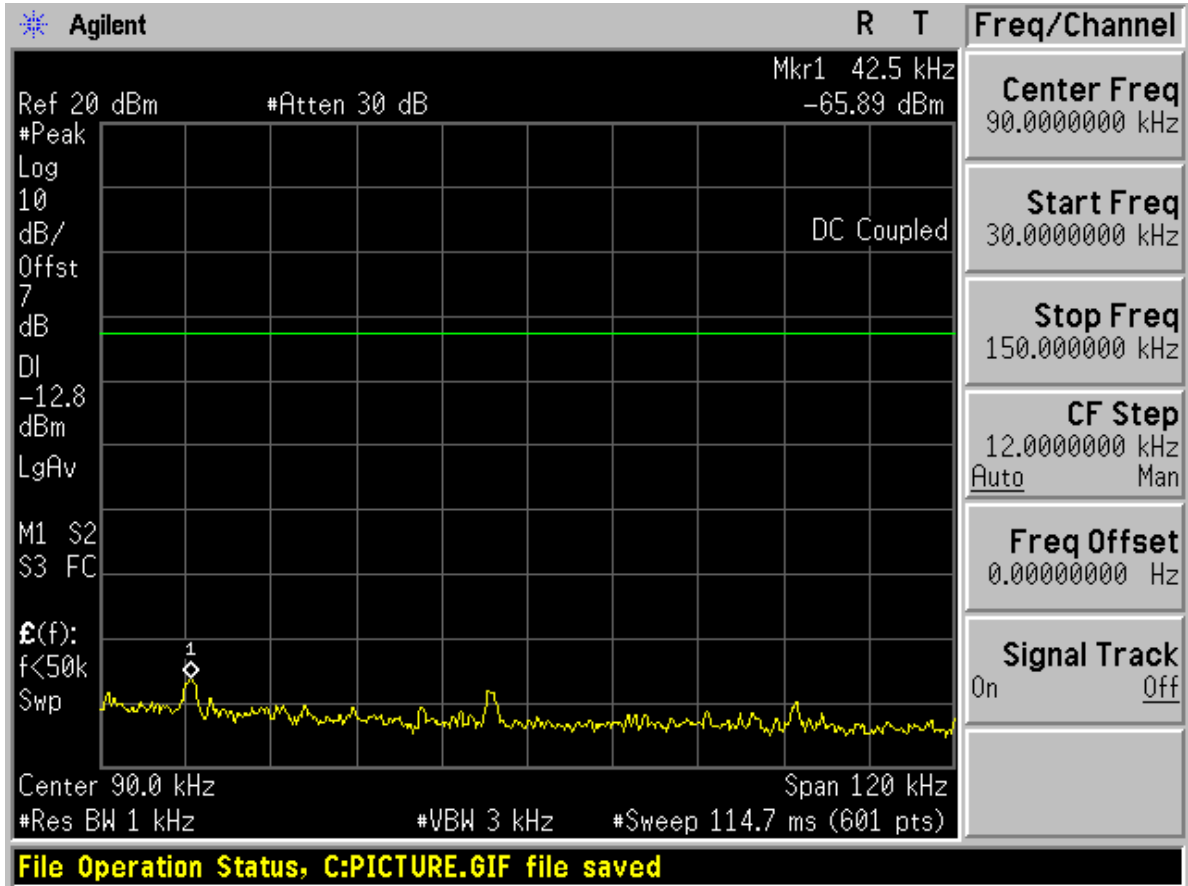

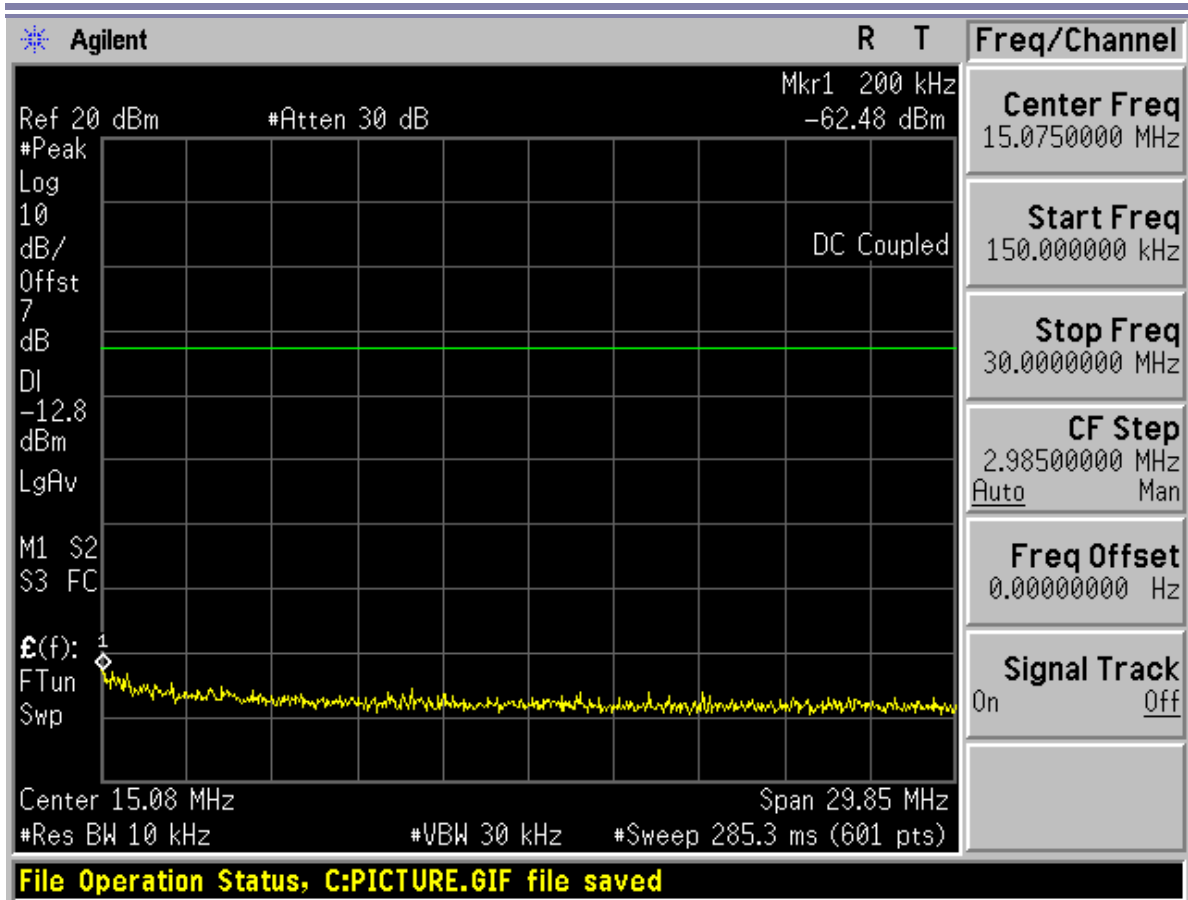

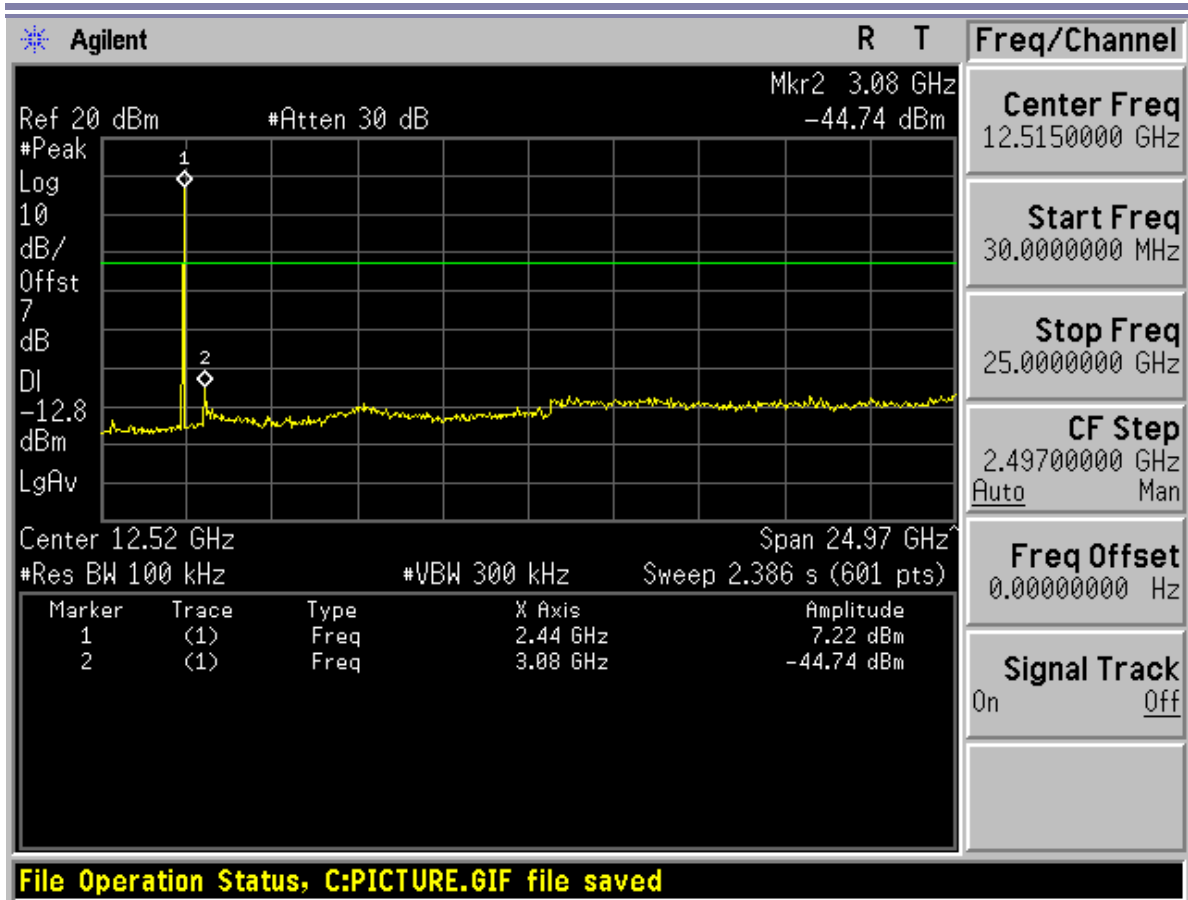



Channel 78

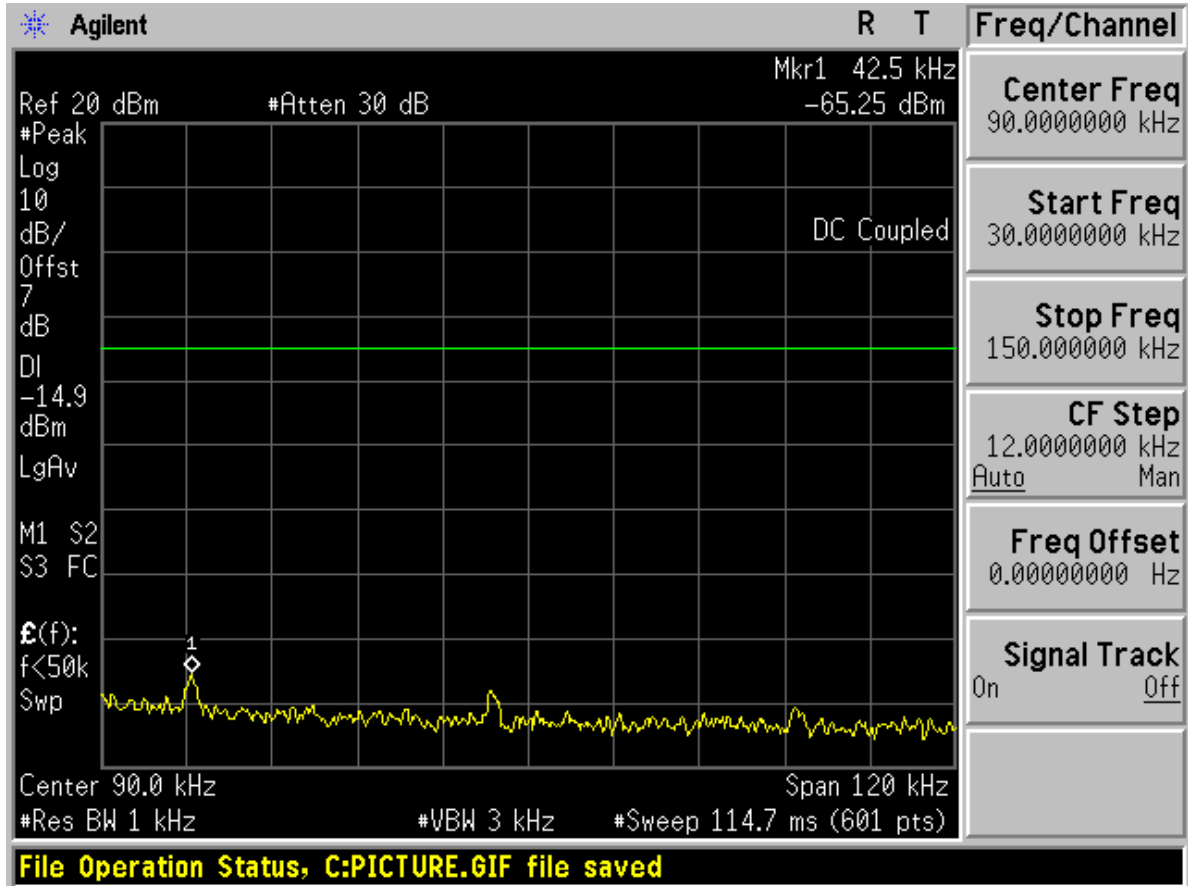

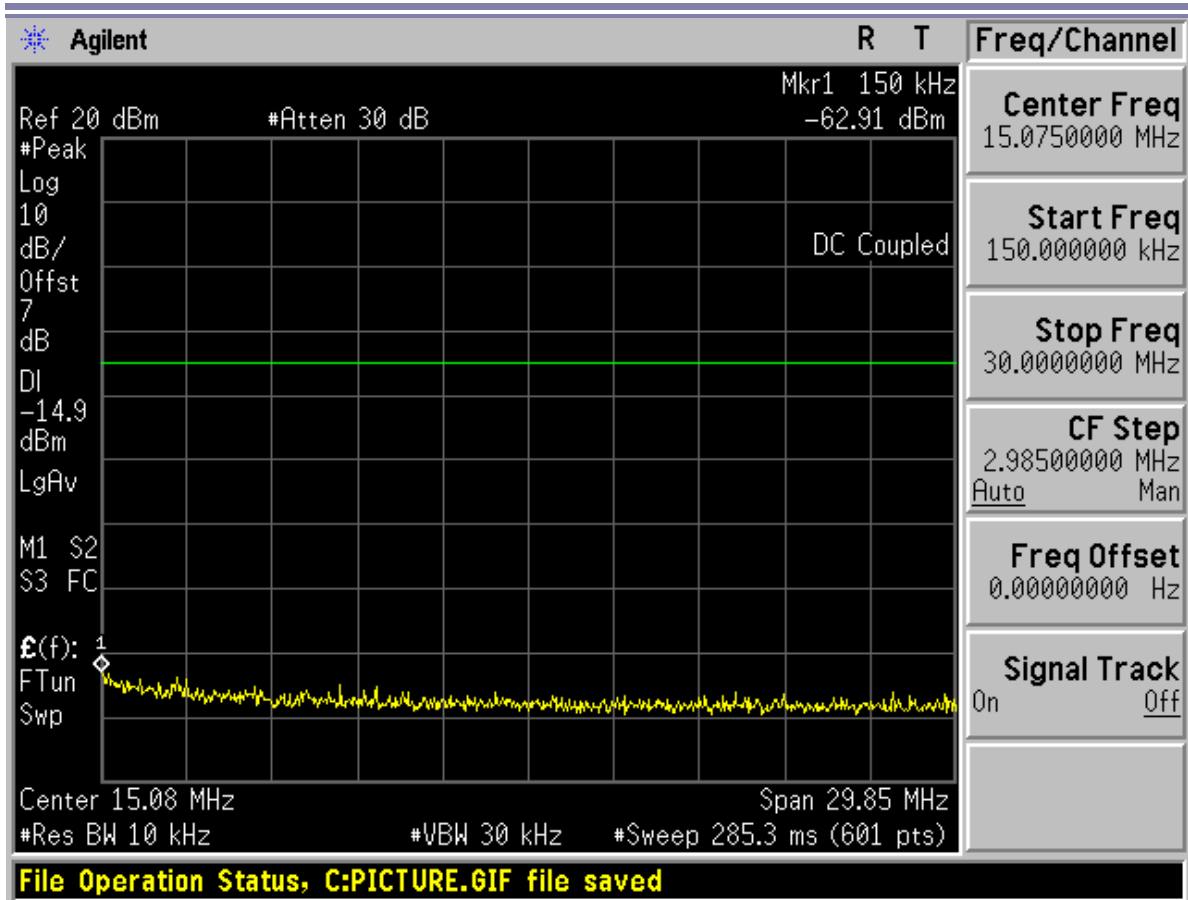

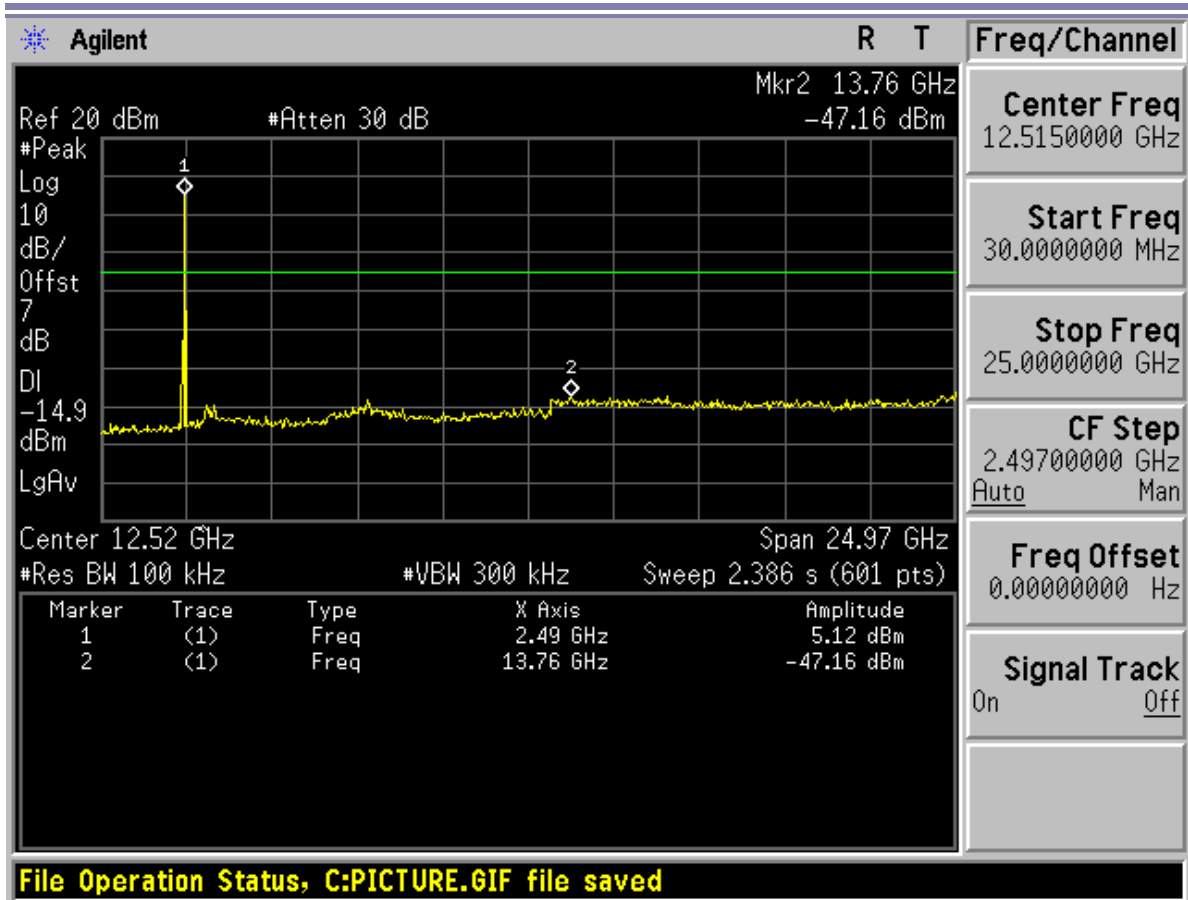



Modulation:8DPSK Channel 0

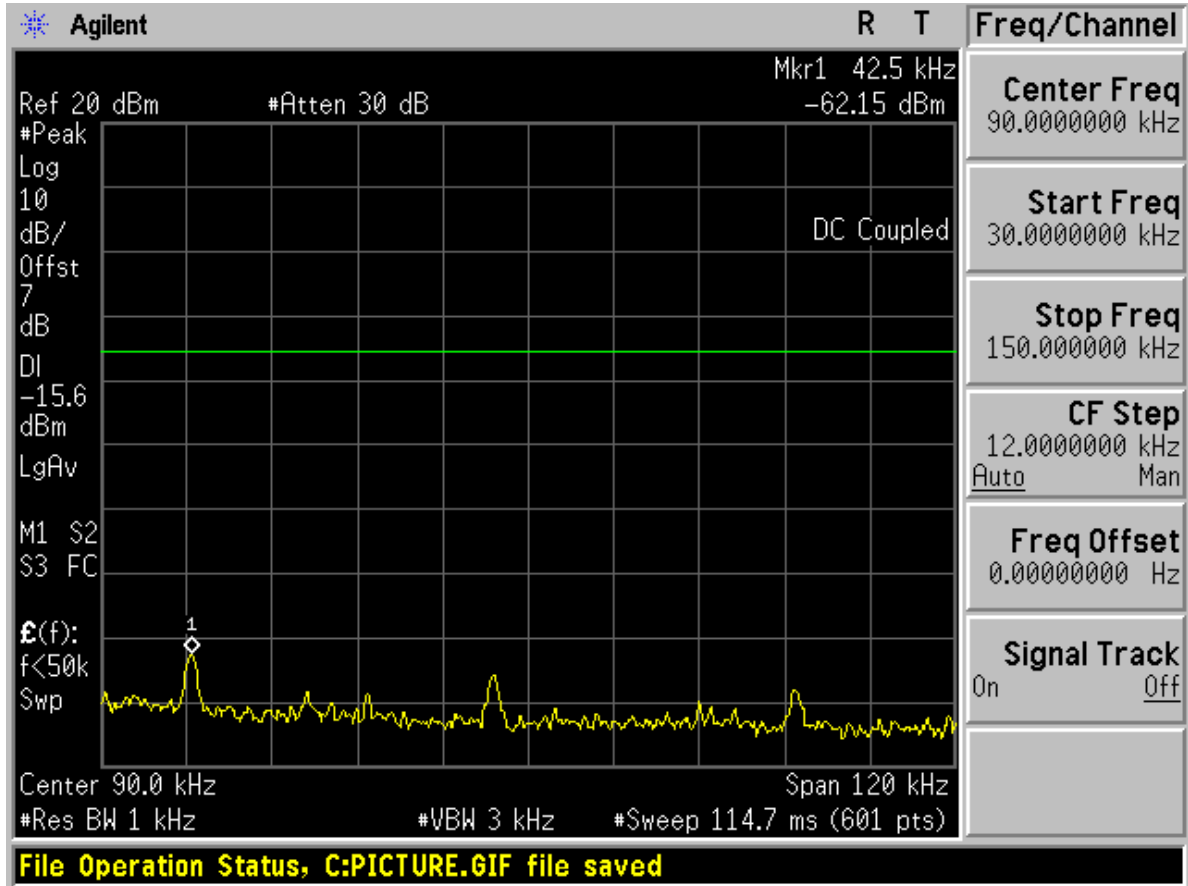

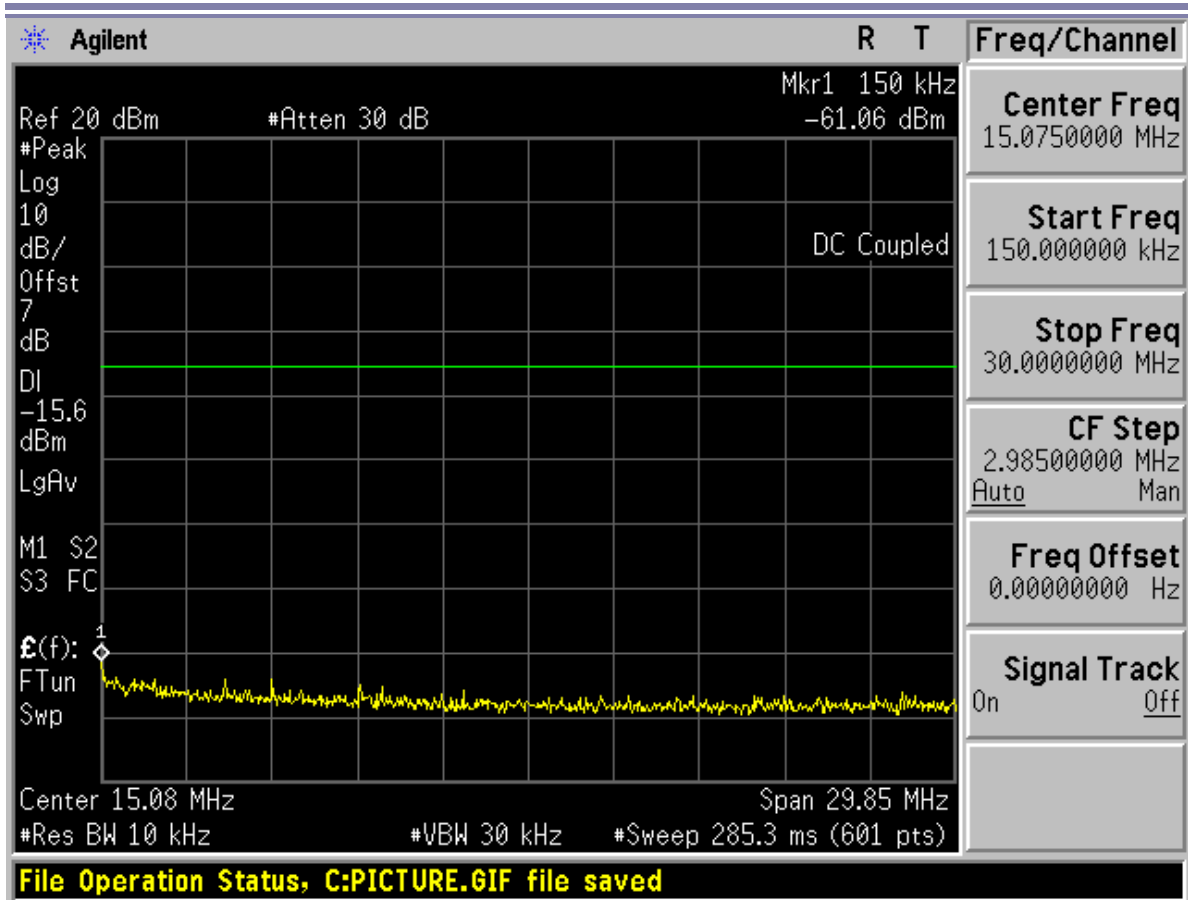

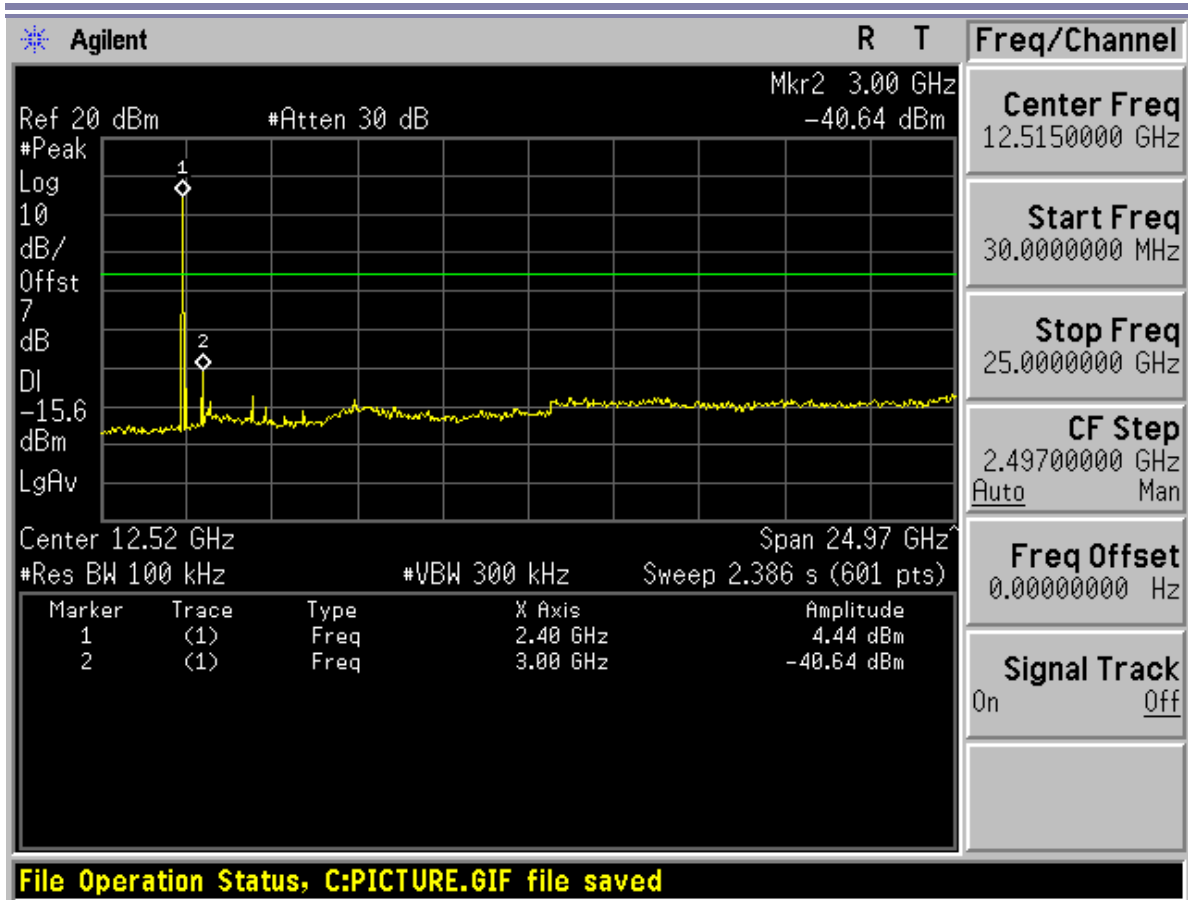



Channel 40

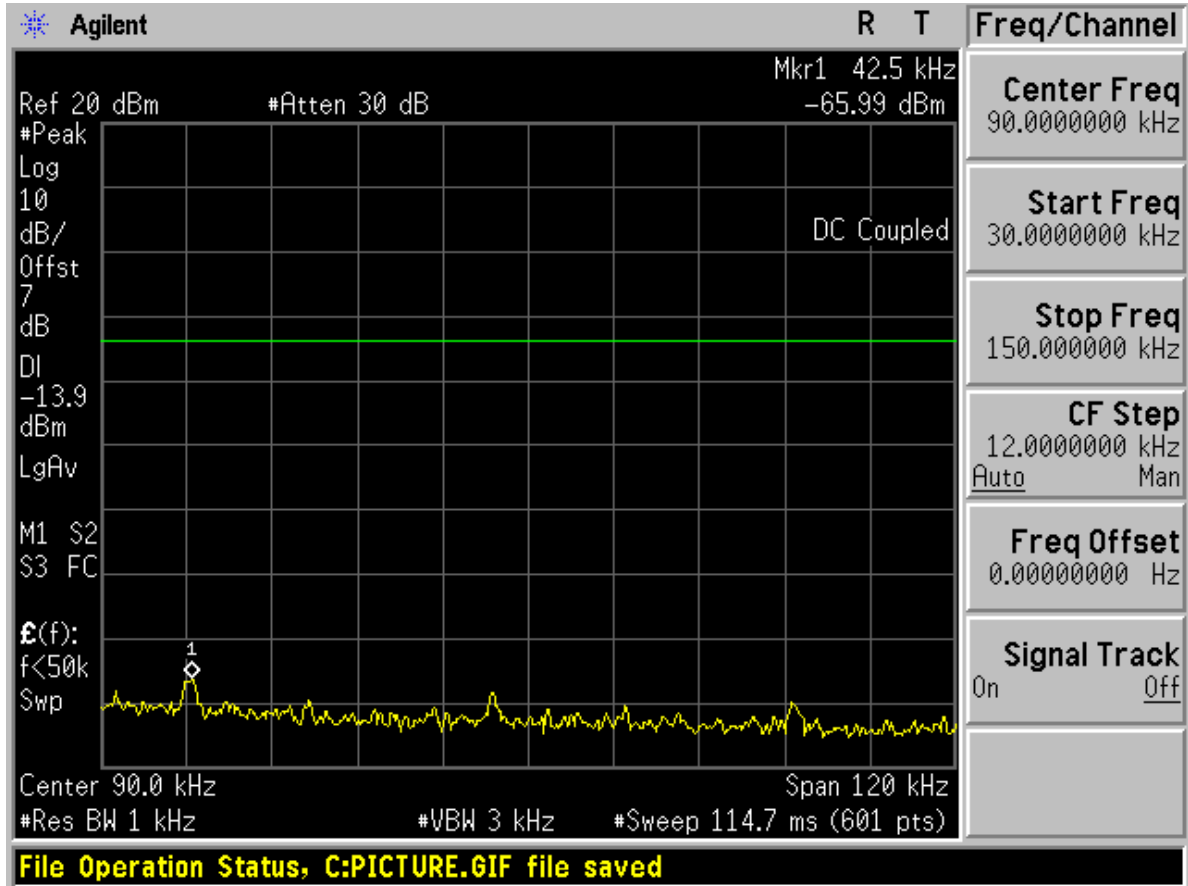

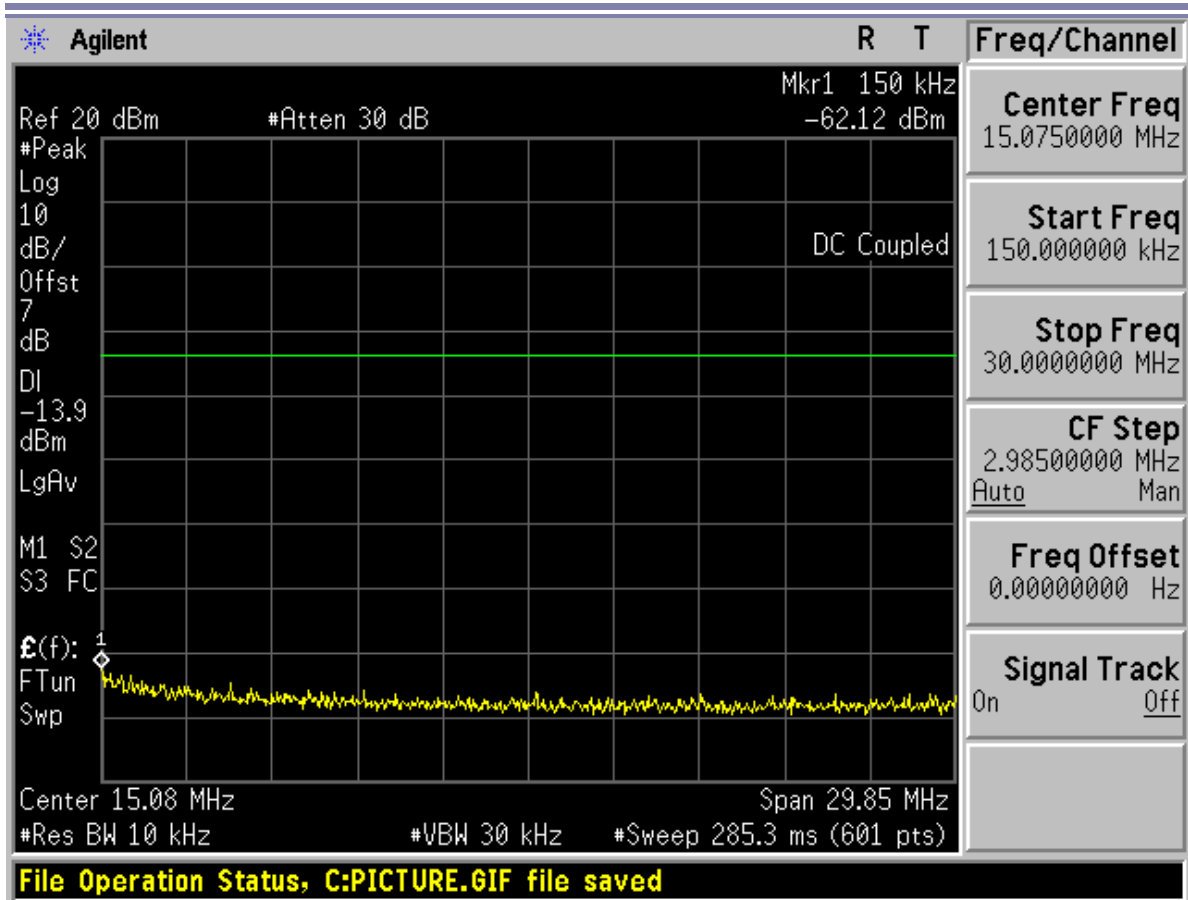

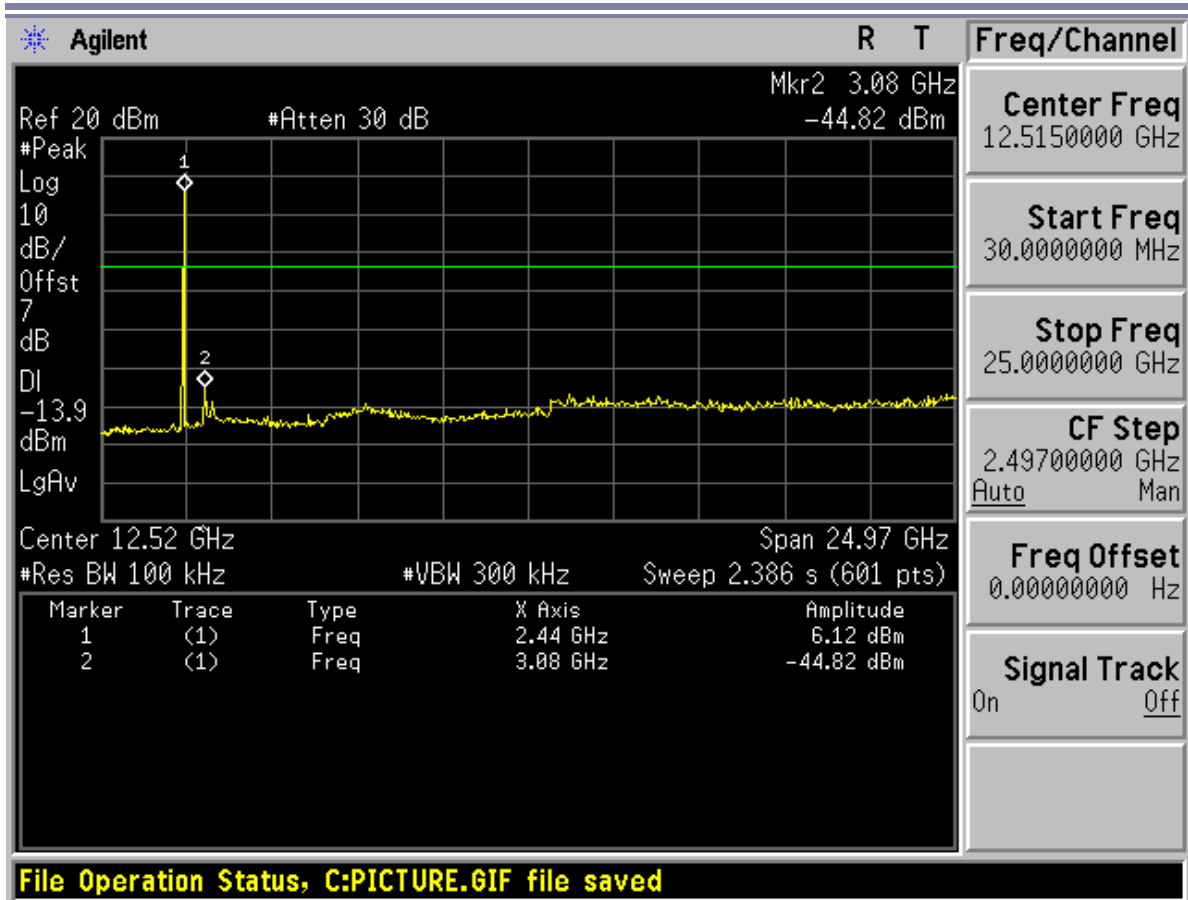



Channel 78

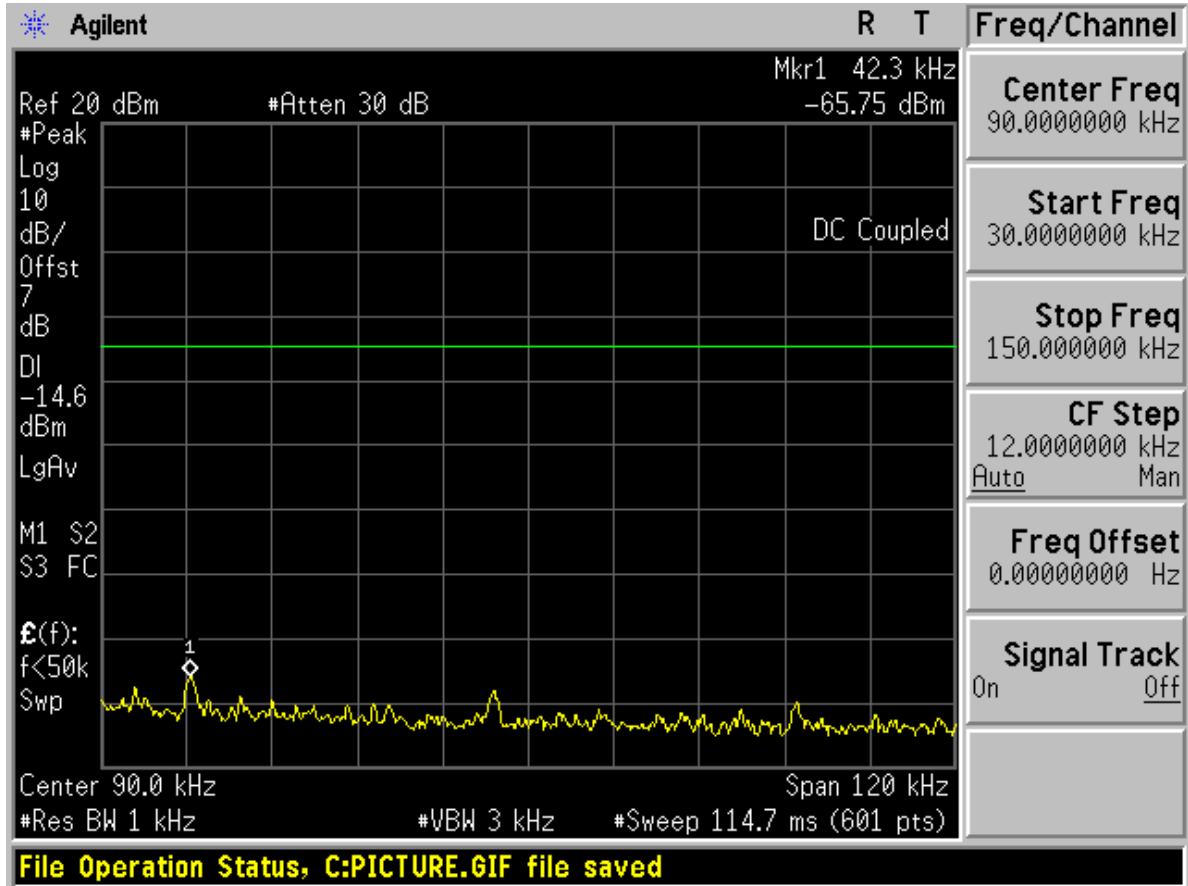

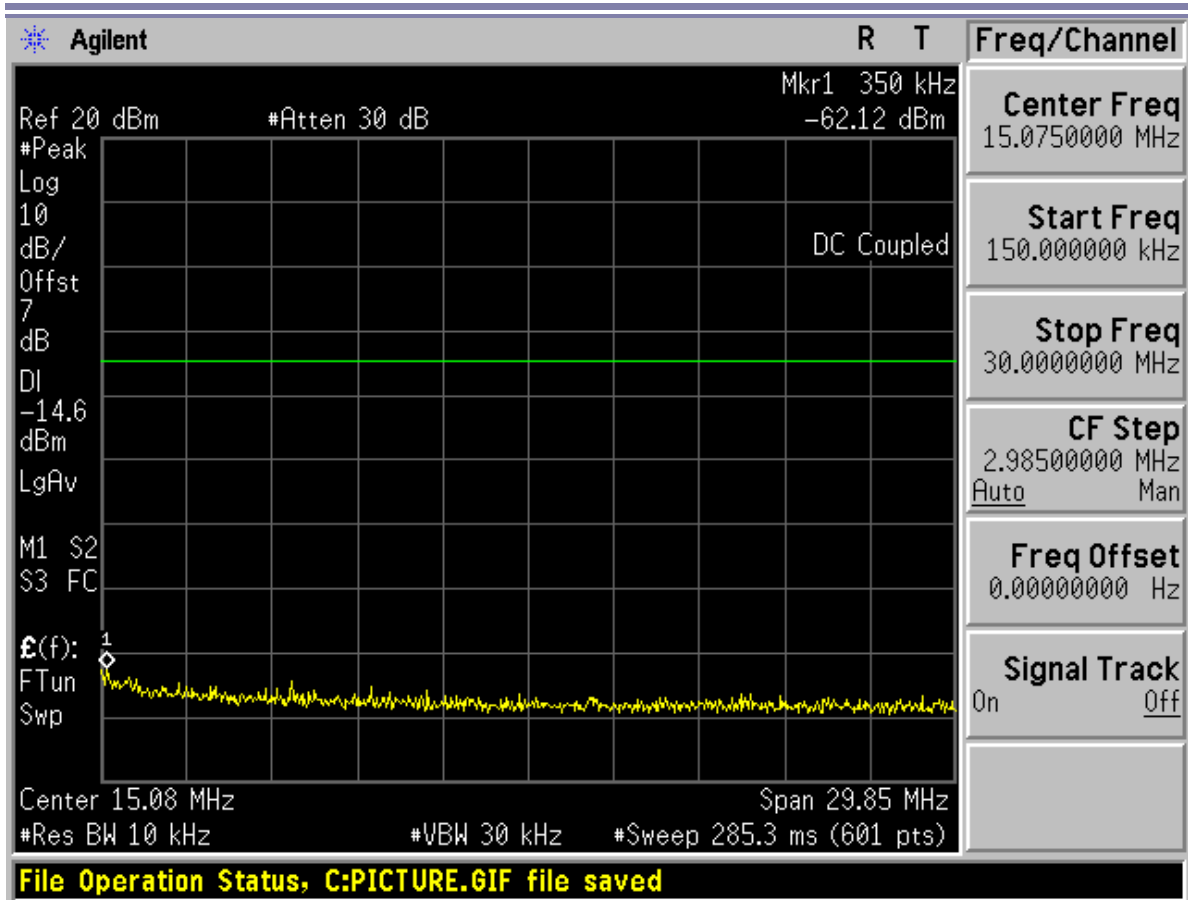

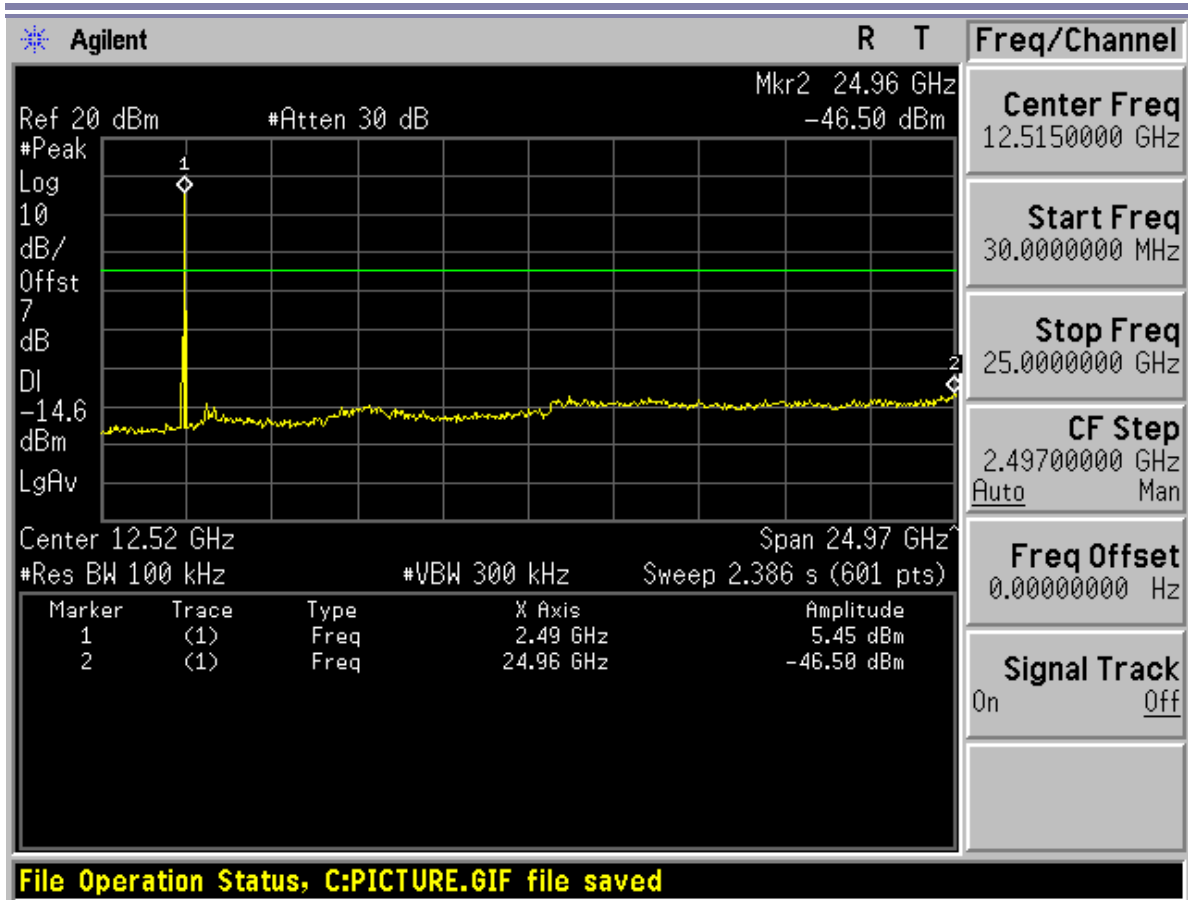

----- End of Report -----



Appendix H

Radiated spurious emission

According to FCC Part 15.247 (d) & 15.205 & 15.209



Part 1: Testing Range of “30 MHz to 1 GHz”

Note 1: The test results and plot for testing range of “30 MHz to 1 GHz” showed as below is **the WORST case for all Test Modes and Channels**. This range will not be presented for each Test Mode and each Channel.

Note 2: **The emissions in this range are mainly from the Platform Device (Notepad PC and its ancillary components).**

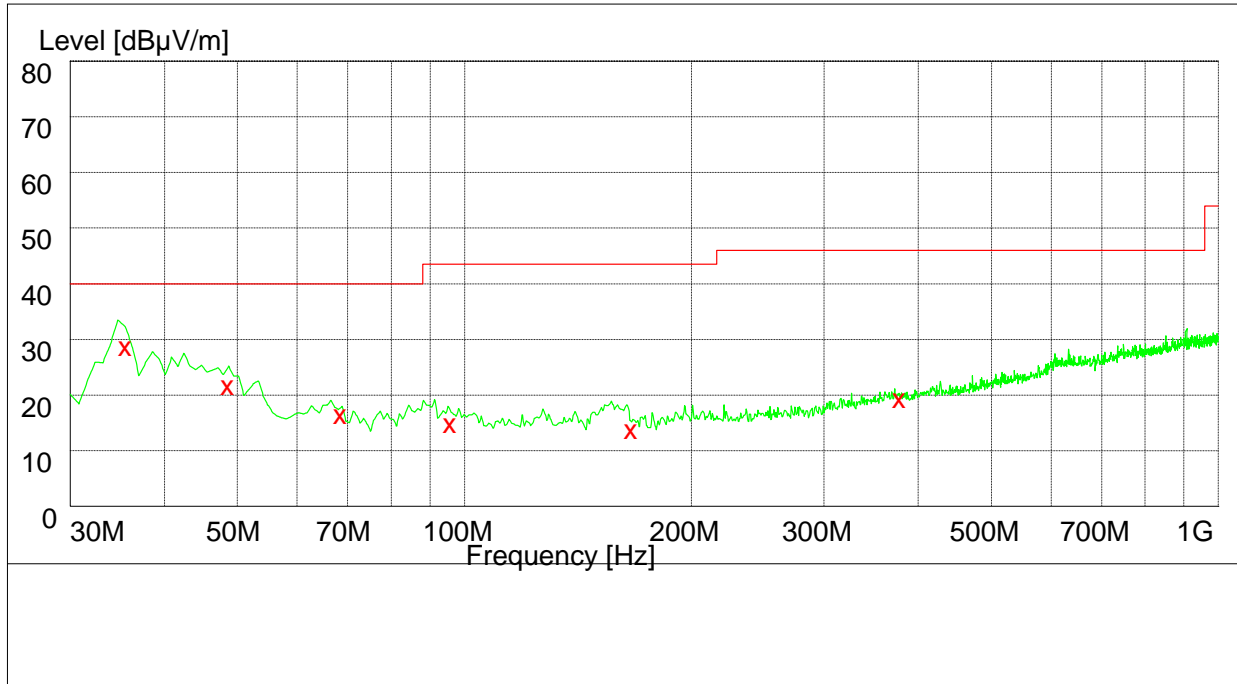

Frequency MHz	Level dBµV/m	Transd dB	Limit dBµV/m	Margin dB	Height cm	Azimuth deg	Plarization
35.520000	29.50	15.0	40.0	10.5	120.0	120.00	VERTICAL
48.540000	22.40	15.0	40.0	17.6	130.0	141.00	VERTICAL
68.500000	17.20	11.1	40.0	22.8	100.0	138.00	VERTICAL
95.820000	15.60	13.0	43.5	27.9	115.0	137.00	VERTICAL
166.680000	14.40	10.4	43.5	29.1	143.0	197.00	HORIZONTAL
378.120000	20.10	16.9	46.0	25.9	142.0	148.00	HORIZONTAL



Part 2: Testing Range of “18 GHz to 26.5 GHz”

Note: No peak found in pre- test.



Part 3: Testing Range of “2.3GHz to 2.5GHz”

- Note 1: The testing range of “1 GHz to 3 GHz” is for checking radiated emissions located in restricted bands near the EUT operating bands.
- Note 2: Two limits are required in the testing range above 1 GHz, that is Peak limit (74 dB μ V/m) and Average Limit (54 dB μ V/m).
- Note 3: The peak spike exceeds the limit line is EUT’s operating frequency.

1 Test Mode:

1.1 Channel 00

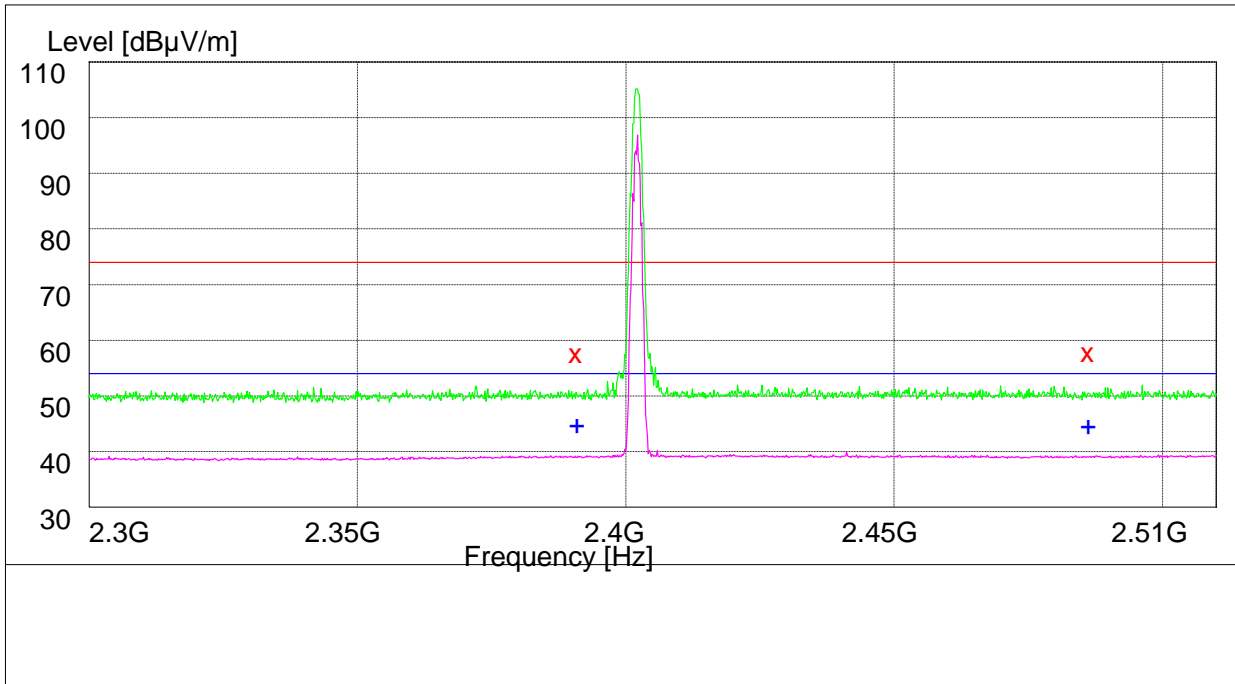

Note: The peak exceeds the limit line is carrier frequency.

MEASUREMENT RESULT: PK Detector

Frequency MHz	Level dB μ V/m	Transd dB	Limit dB μ V/m	Margin dB	Height cm	Azimuth deg	Polarization
2390.000000	58.80	33.5	74.0	15.2	102.0	108.00	VERTICAL
2483.500000	59.40	33.8	74.0	14.6	107.0	132.00	VERTICAL

MEASUREMENT RESULT: AVDetector

Frequency MHz	Level dB μ V/m	Transd dB	Limit dB μ V/m	Margin dB	Height cm	Azimuth deg	Polarization
2390.000000	46.50	33.5	54.0	7.5	120.0	161.00	HORIZONTAL
2483.500000	46.30	33.8	54.0	7.7	115.0	206.00	HORIZONTAL

1.2 Channel 78

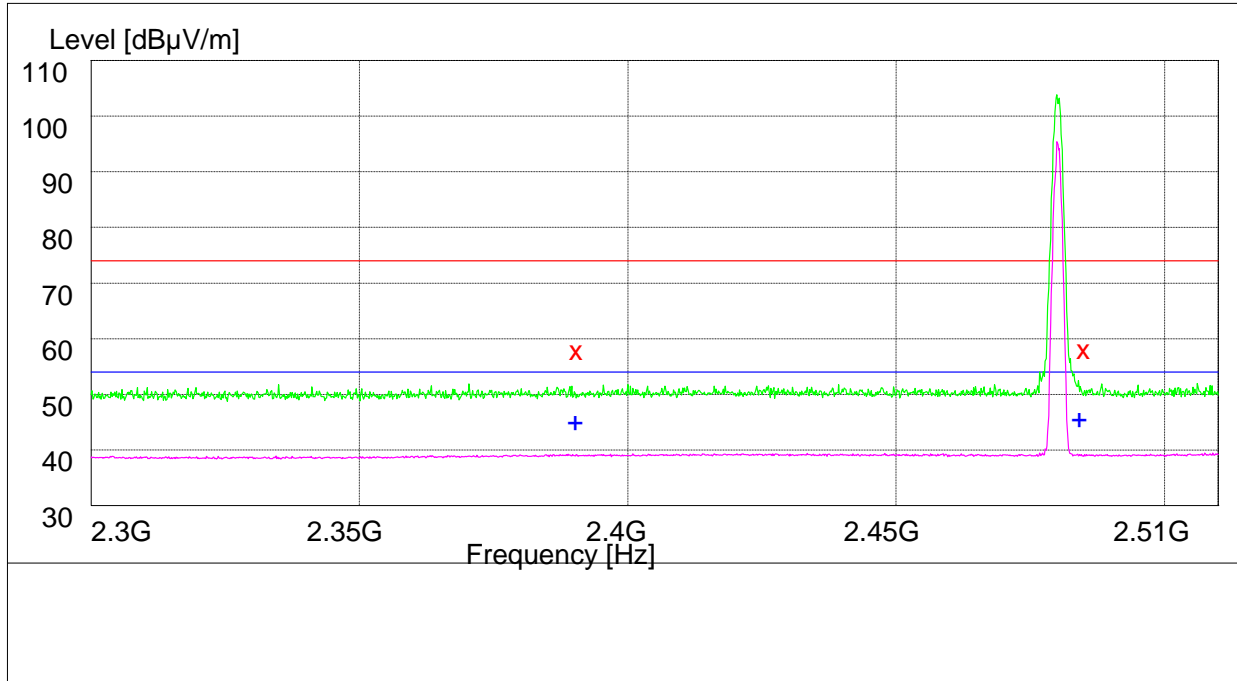

Note: The peak exceeds the limit line is carrier frequency.

MEASUREMENT RESULT: PK Detector

Frequency MHz	Level dBµV/m	Transd dB	Limit dBµV/m	Margin dB	Height cm	Azimuth deg	Polarization
2390.000000	59.20	33.5	74.0	14.8	145.0	154.00	VERTICAL
2483.500000	59.10	33.8	74.0	14.9	100.0	143.00	HORIZONTAL

MEASUREMENT RESULT: AVDetector

Frequency MHz	Level dBµV/m	Transd dB	Limit dBµV/m	Margin dB	Height cm	Azimuth deg	Polarization
2390.000000	46.40	33.5	54.0	7.6	120.0	132.00	VERTICAL
2483.500000	46.50	33.8	54.0	7.5	129.0	210.00	VERTICAL



1.3

Part 4: Testing Range of “1 GHz to 18 GHz”

- Note 1: The test results and plot for testing range of “1 GHz to 18 GHz” showed as below is **the WORST case for all Test Modes and Channels**. This range will not be presented for each Test Mode and each Channel.
- Note 2: The testing range of “1 GHz to 18 GHz” is for checking radiated emissions located in restricted bands faraway from the EUT operating bands.
- Note 3: Two limits are required in the testing range above 1 GHz, that is Peak limit (74 dB μ V/m) and Average Limit (54 dB μ V/m).

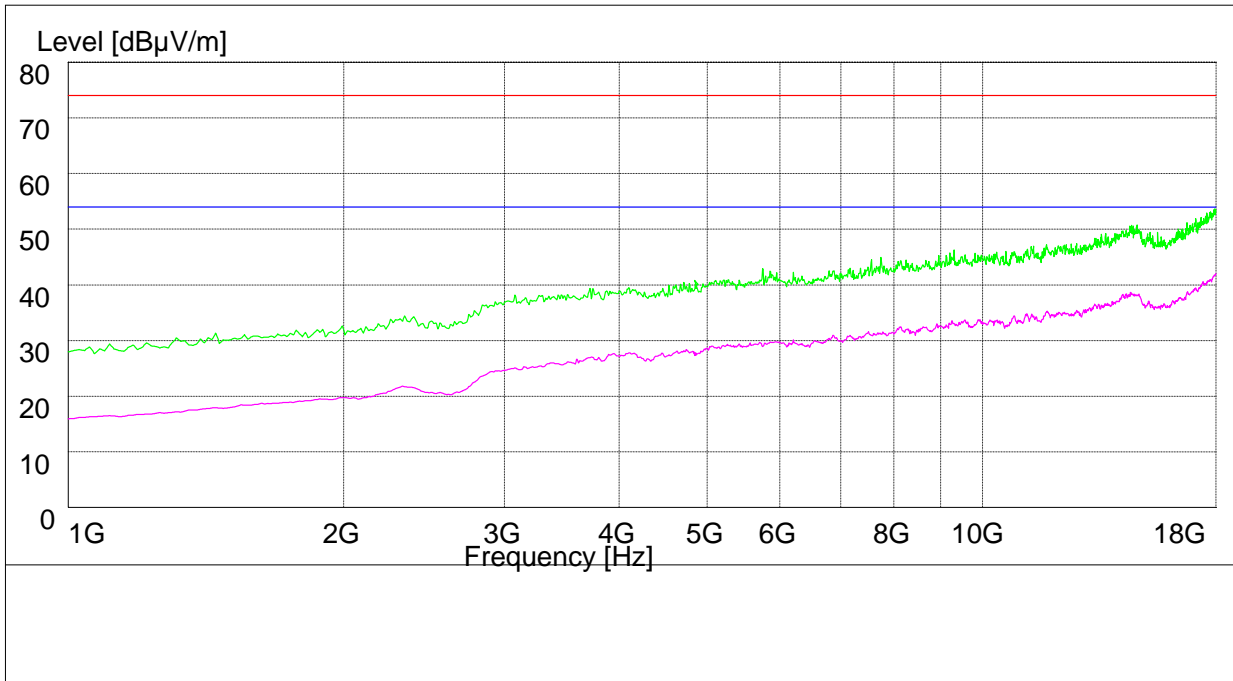

----- End of Report -----



Appendix I

Conducted Emission at Power Port

According to FCC Part 15.207



Channel 40

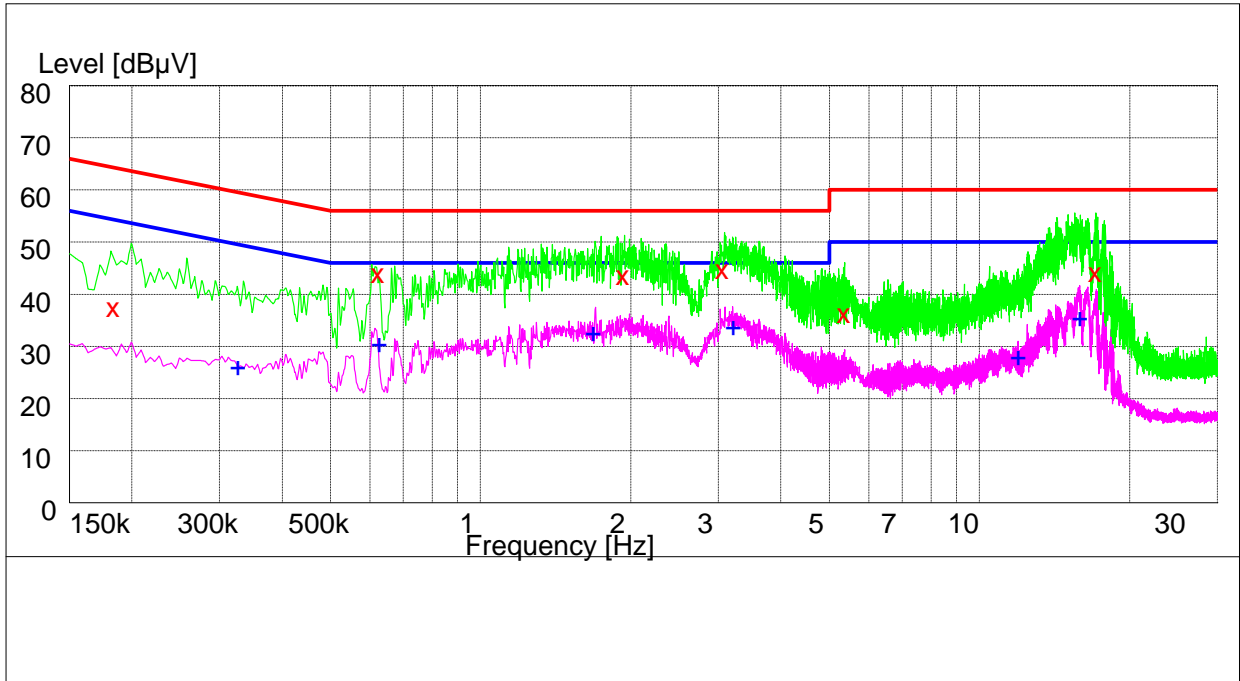

MEASUREMENT RESULT: QP Detector

Frequency MHz	Level dBµV	Transd dB	Limit dBµV	Margin dB	Line	PE
0.184000	37.90	10.1	64	26.1	L1	FLO
0.624000	44.30	10.1	56	11.7	N	FLO
1.936000	43.90	10.1	56	12.1	N	FLO
3.062000	45.10	10.2	56	10.9	N	FLO
5.354000	36.60	10.2	60	23.4	N	FLO
17.106000	44.50	10.3	60	15.5	N	FLO

MEASUREMENT RESULT: AV Detector

Frequency MHz	Level dBµV	Transd dB	Limit dBµV	Margin dB	Line	PE
0.326000	26.50	10.0	50	23.5	N	FLO
0.626000	30.90	10.1	46	15.1	N	FLO
1.680000	32.90	10.1	46	13.1	N	FLO
3.206000	34.30	10.2	46	11.7	N	FLO
11.966000	28.50	10.3	50	21.5	N	FLO
15.904000	35.90	10.3	50	14.1	N	FLO

----- End of Report -----