



# EMC Test Report

**Product Name: Smart Band**

**Product Model: TER-B19**

**Report Number: SYBH(Z-EMC)20180728013001-2**

**FCC ID: QISTER-B19**

**IC ID: 6369A-TERB19**

**Reliability Laboratory of Huawei Technologies Co., Ltd.**

**(Global Compliance and Testing Center of Huawei Technologies Co., Ltd)**

Administration Building, Headquarters of Huawei Technologies Co., Ltd., Bantian, Longgang District,  
Shenzhen, 518129, P.R.C

Tel: +86 755 28780808 Fax: +86 755 89652518

## Notice

1. The laboratory has passed the accreditation by China National Accreditation Service for Conformity Assessment (CNAS). The accreditation number is L0310.
2. The laboratory has passed the accreditation by The American Association for Laboratory Accreditation (A2LA). The accreditation number is 2174.01
3. The laboratory has been listed by Industry Canada to perform electromagnetic emission measurements. The recognition numbers of test site are 6369A-1.
4. The laboratory (Reliability Lab of Huawei Technologies Co., Ltd) is also named “Global Compliance and Testing Center of Huawei Technologies Co., Ltd” , the both names have coexisted since 2009.
5. The laboratory has been recognized by the US Federal Communications Commission (FCC) to perform compliance testing subject to the Commission's Certification rules. The Designation Number is CN1173, and the Test Firm Registration Number is 294140.
6. The test report is invalid if not marked with the signatures of the persons responsible for preparing and approving the test report.
7. The test report is invalid if there is any evidence of erasure and/or falsification.
8. If there is any dissidence for the test report, please file objection to the test centre within 15 days from the date of receiving the test report.
9. Normally, the test report is only responsible for the samples that have undergone the test.
10. Content of the test report, in part or in full, cannot be used for publicity and/or promotional purposes without prior written approval from the laboratory.



**Applicant:** Huawei Technologies Co., Ltd.  
**Address:** Administration Building, Headquarters of Huawei Technologies Co., Ltd., Bantian, Longgang District, Shenzhen, 518129, P.R.C

**Date of Receipt Test Item:** 2018-8-16  
**Start Date of Test:** 2018-8-17  
**End Date of Test:** 2018-8-24

**Test Result:** Pass

<b>Approved By (Lab Manager)</b>	<u>2018-8-27</u>	<u>Roger Zhang</u>	<u>He Hao</u>
	<b>Date</b>	<b>Name</b>	<b>Signature</b>
<b>Operator (Test Engineer)</b>	<u>2018-8-27</u>	<u>Hu haizhou</u>	<u>Hu Haizhou</u>
	<b>Date</b>	<b>Name</b>	<b>Signature</b>



---

---

**Modification Record**

No.	Last Report No.	Modification Description
1	V1.0	First report





## TABLE OF CONTENT

1	General Information .....	6
1.1	EUT Description .....	6
1.2	Test Site Information .....	6
1.3	Applied Standards .....	6
2	Summary of Results.....	7
3	System Configuration during EMC Test.....	8
3.1	Test Mode .....	8
3.2	Test System Configuration.....	8
3.3	Associated Equipment Used during Test.....	8
4	Electromagnetic Interference (EMI).....	9
4.1	Radiated Disturbance 30MHz to 18GHz .....	9
4.2	Conducted Disturbance 0.15 MHz to 30MHz.....	11
5	Main Test Instruments.....	12
6	System Measurement Uncertainty .....	12
7	Test Data and Graph.....	13
7.1	Radiated Disturbance.....	13
7.2	Conducted Disturbance.....	15

## 1 General Information

### 1.1 EUT Description

EUT Description	
Product Name	Smart Band
Model Number	TER-B19
Input voltage	5V
TX Frequency	Bluetooth: 2400MHz – 2483.5MHz
RX Frequency	Bluetooth: 2400MHz – 2483.5MHz GPS: 1575.42MHz
S/N	B89436ABA286
HW Version	971R1
SW Version	1.0.0.3
EUT Accessory	
Charge dock	Manufacturer:Huawei Technologies Co.,Ltd. Model: AF33-1 5V/1A
USB Cable	Manufacturer:Huawei Technologies Co.,Ltd. 5V1A
Li-polymer Battery	Battery Model: HB351329ECW Rated capacity: 100 mAh Nominal Voltage:  +3.82V Charging Voltage:  +4.40V Discharging Voltage:  +3.00V Manufacturer: Tianjin lishen battery joint-stock.,LTD. Harbin Coslight Power Co., Ltd.

Remark: The above EUT's information is declared by manufacturer. Please refer to the specifications or user's manual for more detailed information.

### 1.2 Test Site Information

Test Site 1:	RELIABILITY LABORATORY OF HUAWEI TECHNOLOGIES CO., LTD.
Test Site Location:	Administration Building, Headquarters of Huawei Technologies Co., Ltd., Bantian, Longgang District, Shenzhen, 518129, P.R.C

### 1.3 Applied Standards

APPLIED STANDARD

47 CFR FCC Part 15, Subpart B  
ICES-003 Issue 6

## 2 Summary of Results

Summary of Results				
Test Items	Test Mode	Performance Class & Required Performance Criteria	Result	Site
<u>Radiated Emissions</u> Enclosure Port	Mode1	CLASS B	Pass	Site1
<u>Conducted Emissions</u> <input type="checkbox"/> DC Power Port <input checked="" type="checkbox"/> AC Power Port <input type="checkbox"/> Telecommunication Ports	Mode1	CLASS B	Pass	Site1
Note: 1, Measurement taken is within the uncertainty of test system. 2, <input checked="" type="checkbox"/> The item has been tested; <input type="checkbox"/> The item has not been tested.				

During the measurement, the environmental conditions complied with the range listed as below.

Item	Required
Ambient temperature	15°C ~ 35°C
Relative humidity	25% ~ 75%
Atmospheric pressure	86kPa ~ 106kPa

### 3 System Configuration during EMC Test

#### 3.1 Test Mode

The EUT was configured, installed, arranged and operated in a manner consistent with typical application. The following mode(s) were applied during the compliance test.

Test Mode	
Mode 1:	Charging+Normal operation+GPS ON+BT link

Remark:

- 1) If there is one kind of accessories with different models, each one should be applied throughout the compliance test respectively, however, only the worst case will be recorded in this report.
- 2) If EUT has more than one typical operation, only the worst test mode will be recorded in this report.

#### 3.2 Test System Configuration

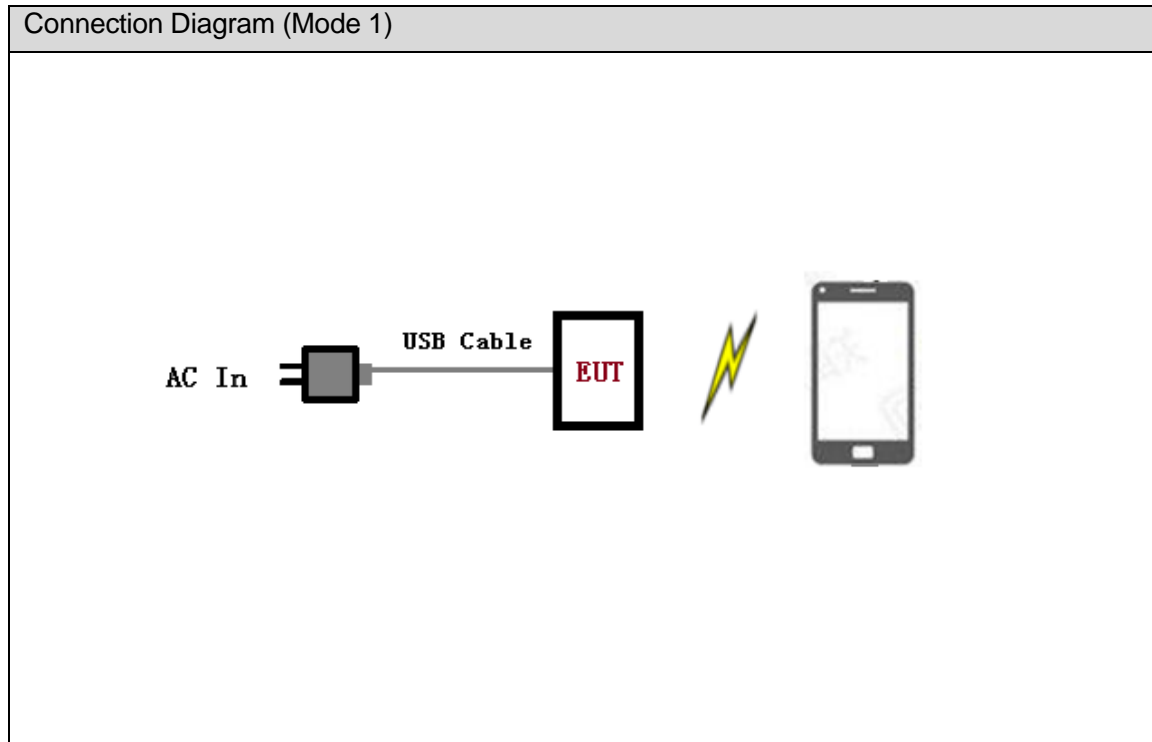

#### 3.3 Associated Equipment Used during Test

Name	Model	Manufacturer	S/N	Calibrated Deadline
Mobile phone	Honor 9	HuaWei	WMNDU17A27000145	/



## 4 Electromagnetic Interference (EMI)

### 4.1 Radiated Disturbance 30MHz to 18GHz

#### 4.1.1 Test Procedure

The test site semi-anechoic chamber has met the requirement of NSA tolerance 4dB according to the standards: ANSI C63.4-2014. The test distance was 3m. The set-up and test methods were according to ANSI C63.4-2014.

A preliminary scan and a final scan of the emissions were made from 30 MHz to 18 GHz by using test script of software; The emissions were measured using Quasi-Peak Detector (30MHz~1GHz) and AV/PK detector (above 1GHz). The maximal emission value was acquired by adjusting the antenna height, polarisation and turntable azimuth in accordance with the software setup. Normally, the height range of antenna was 1m to 4m. The azimuth range of turntable was 0° to 360°. The receiving antenna has two polarizations V and H.

Measurement bandwidth (RBW) for 30MHz to 1000 MHz: 120 kHz;

Measurement bandwidth (RBW) for 1000MHz to 18000 MHz: 1MHz;

EUT was configured in idle mode and the test performed at worst emission state.

#### 4.1.2 Test setup

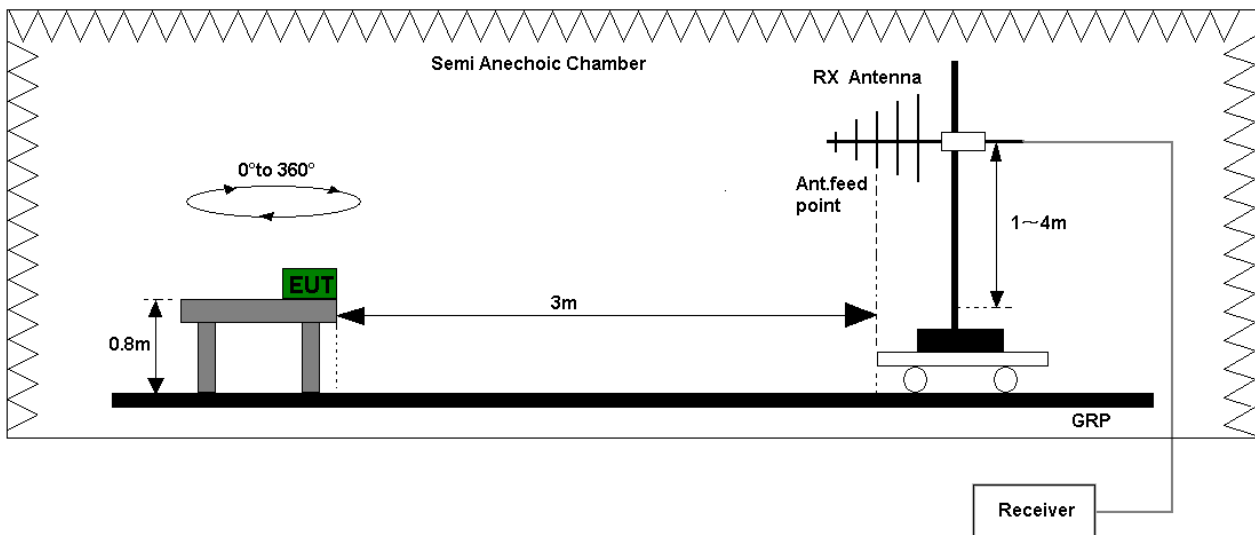

Figure 1. Test set-up of radiated disturbance(30MHz-1GHz)

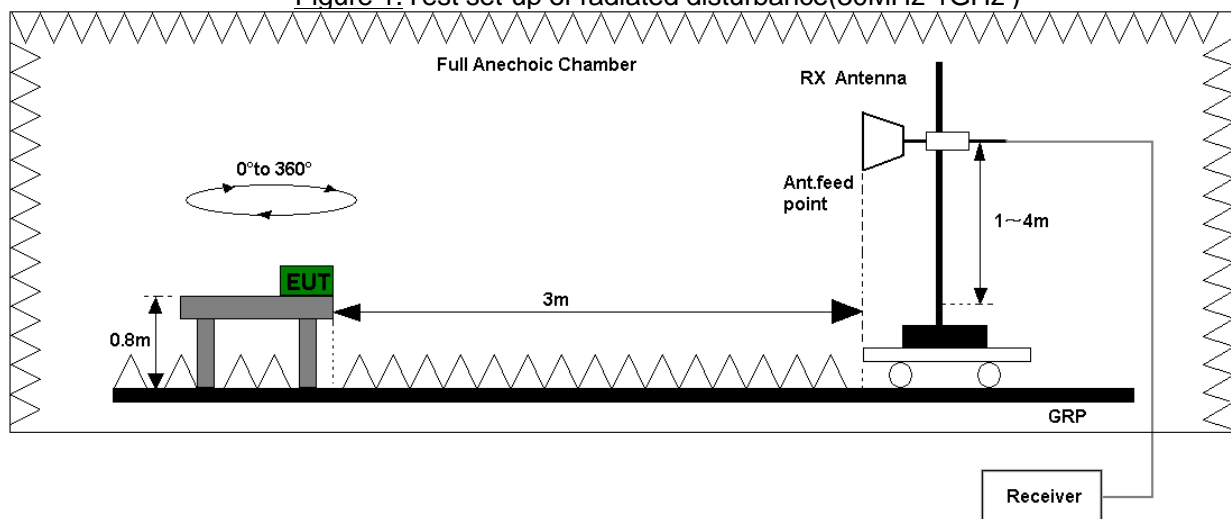

Figure 2. Test set-up of radiated disturbance(above 1GHz)



### 4.1.3 Test Results

The EUT has met the requirements for Radiated Emission of enclosure port.  
Refer to the section 7.1 of this report for test data.

Test Limits (Class B)				
Frequency of Emission (MHz)	Radiated Limit			
	Unit( $\mu$ V/m)		Unit(dB $\mu$ V/m)	
30-88	100		40	
88-216	150		43.5	
216-960	200		46	
Above 960	500		54	
Above 1000	AV	PK	AV	PK
	500	5000	54	74

## 4.2 Conducted Disturbance 0.15 MHz to 30MHz

### 4.2.1 Test Procedure

The Table-top EUT was placed upon a non-metallic table 0.8 m above the horizontal metal reference ground plane. EUT was connected to LISN and LISN was connected to reference Ground Plane. EUT was 80cm away from LISN. The set-up and test methods were according to ANSI C63.4-2014. Conducted Disturbance at AC Port measurements were undertaken on the L and N Lines. The emissions were measured using a Quasi-Peak Detector and Average Detector. EUT was communicated with the simulator through Air interface, the simulator controls the EUT to transmitter the maximum power which defined in specification of product. The EUT operated on the typical channel.

Measurement bandwidth (RBW) for 150 kHz to 30 MHz: 9 kHz;

The EUT was set in the shielded chamber and operated under nominal conditions.

### 4.2.2 Test Setup

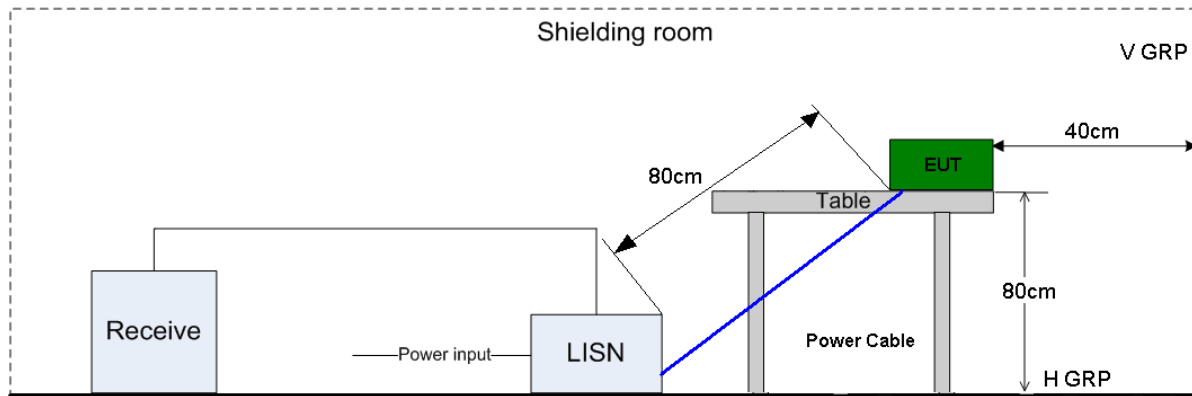

Figure 3. Test Set-up of conducted disturbance

### 4.2.3 Test Results

The EUT has met requirements for Conducted disturbance of power lines. Refer to the section 7.2 of this report for test data.

Test Limit of AC Power Port		
Frequency range	150kHz ~ 30MHz	
Frequency	Voltage limits	
	QP (dB $\mu$ V)	AV (dB $\mu$ V)
0.15MHz~0.5MHz	66-56	56-46
0.5MHz-5MHz	56	46
5MHz~30MHz	60	50

## 5 Main Test Instruments

Main Test Equipments						
Test item	Test Instrument	Model	S/N	Manufacturer	Calibrated Deadline	Cal interval
RE	EMI Test receiver	ESU26	100150	R&S	Jan. 20, 2019	12
	Broadband Antenna	VULB 9163	9163-491	SCHWARZ BECK	Mar. 28, 2019	24
	Horn Antenna	HF906	100683	R&S	Mar. 28, 2019	24
CE	EMI Test receiver	ESU26	101163	R&S	Feb. 20, 2019	12
	Artificial Mains Network	ENV216	100382	R&S	May. 15, 2019	12
Software Information						
Test Item	Software Name	Manufacturer		Version		
RE	EMC32	R&S		V9.25.0		
CE	EMC32	R&S		V9.25.0		

## 6 System Measurement Uncertainty

For a 95% confidence level, the measurement expanded uncertainties for defined systems, in accordance with the recommendations of ISO 17025 were:

System Measurement Uncertainty		
Items	Extended Uncertainty	
RE(30MHz-1GHz)	Field strength (dB $\mu$ V/m)	U=5.52 dB; k=2
RE(1GHz-18GHz)	Field strength (dB $\mu$ V/m)	U=4.94 dB; k=2
CE	Disturbance Voltage (dB $\mu$ V)	U=2.3 dB; k=2

## 7 Test Data and Graph

### 7.1 Radiated Disturbance

#### 7.1.1 30MHz~1GHz

Test Mode1:

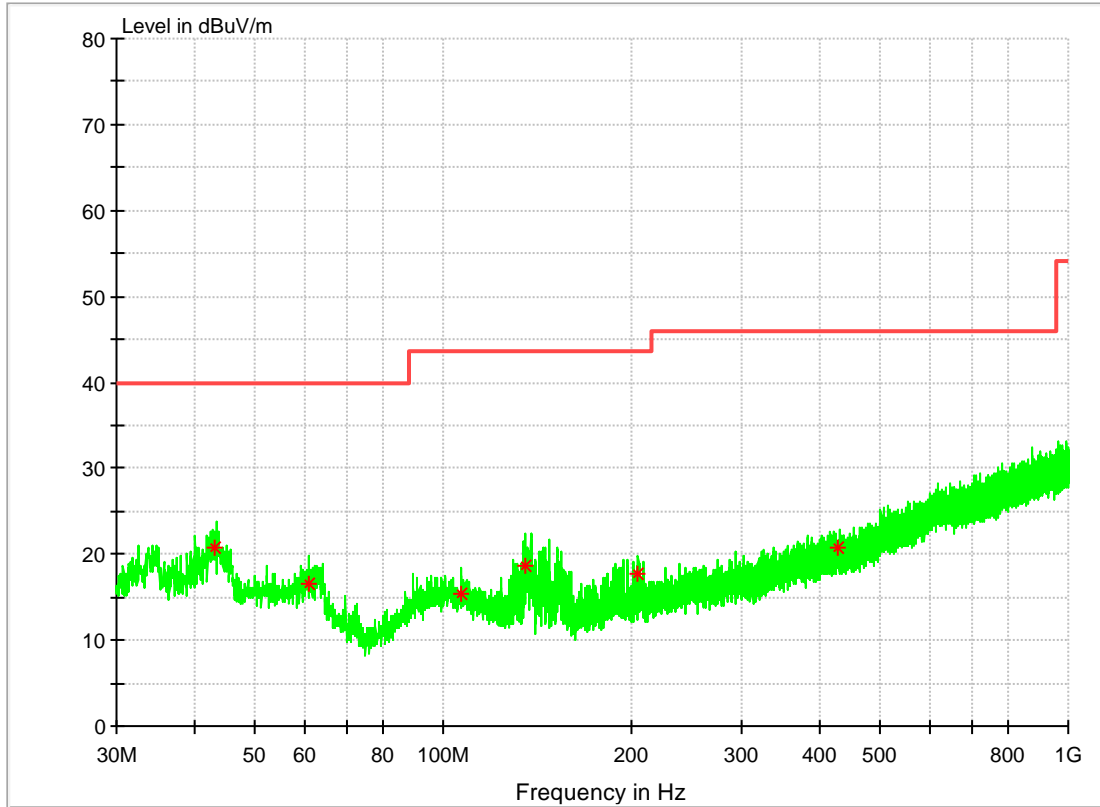

#### MEASUREMENT RESULT: QP Detector

Frequency MHz	Level dB $\mu$ V/m	Transd dB	Limit dB $\mu$ V/m	Margin dB	Height cm	Azimuth deg	Polarisation
43.143500	20.83	14.5	40.00	19.17	100.0	131.0	V
60.894500	16.61	13.4	40.00	23.39	100.0	44.0	V
106.921000	15.33	14.0	43.50	28.17	100.0	319.0	V
135.342000	18.66	10.2	43.50	24.84	100.0	295.0	V
205.133500	17.70	12.7	43.50	25.80	100.0	44.0	V
428.233500	20.83	18.4	46.00	25.17	100.0	153.0	H

Note:

Level = Reading level by receiver + Transd (Antenna factor + cable loss – preamplifier gain)  
 The reading level is calculated by software which is not shown in the sheet.

### 7.1.2 1GHz~18GHz

#### Test Mode1:

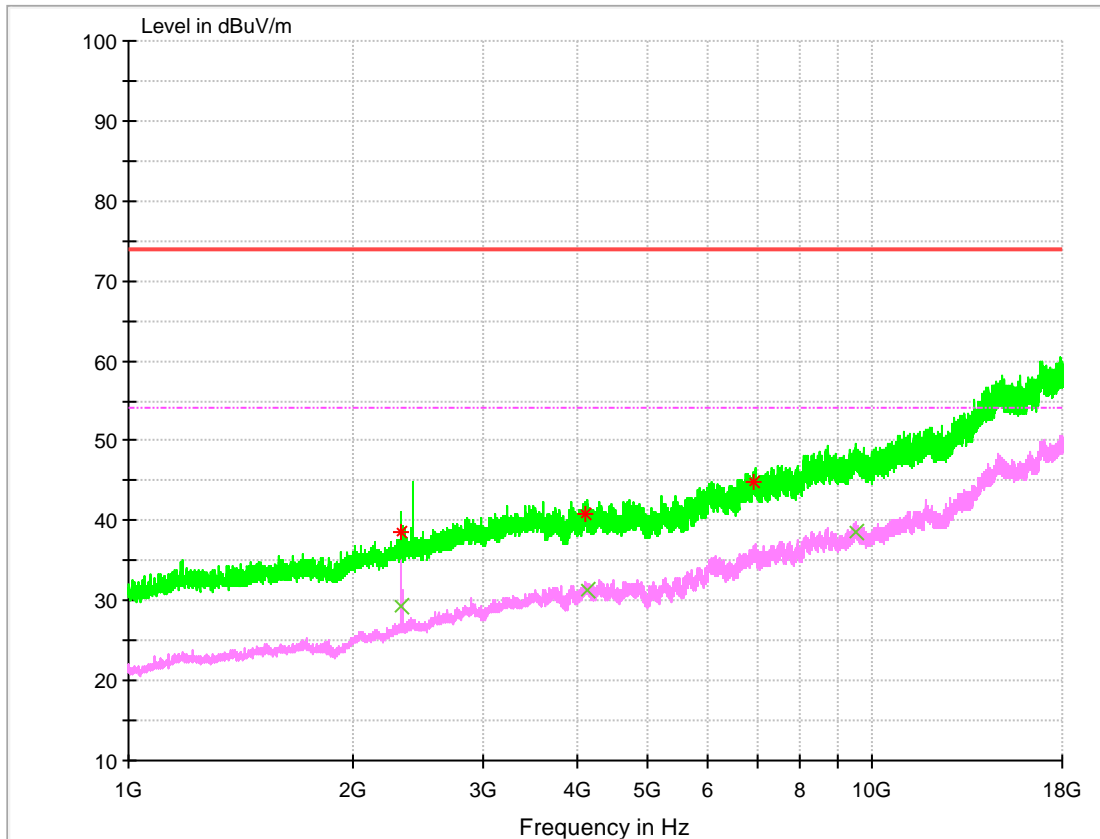

#### MEASUREMENT RESULT: PK Detector

Frequency MHz	Level dB $\mu$ V/m	Transd dB	Limit dB $\mu$ V/m	Margin dB	Height cm	Azimuth deg	Polarisation
2325.433333	38.66	-7.8	74.0	35.34	100.0	31.0	V
4103.633333	40.96	-1.8	74.0	33.04	100.0	3.0	V
6937.533333	44.93	4.4	74.0	29.07	100.0	304.0	H

#### MEASUREMENT RESULT: AV Detector

Frequency MHz	Level dB $\mu$ V/m	Transd dB	Limit dB $\mu$ V/m	Margin dB	Height cm	Azimuth deg	Polarisation
2329.966667	29.35	5.5	54.0	24.65	119.0	293.0	V
4140.466667	31.23	17.4	54.0	22.77	100.0	225.0	H
9486.966667	38.50	21.5	54.0	15.50	153.0	147.0	H

Note:

Level = Reading level by receiver + Transd (Antenna factor + cable loss – preamplifier gain)  
 The reading level is calculated by software which is not shown in the sheet.

## 7.2 Conducted Disturbance

### 7.2.1 AC Port Test Data

Test Mode1:

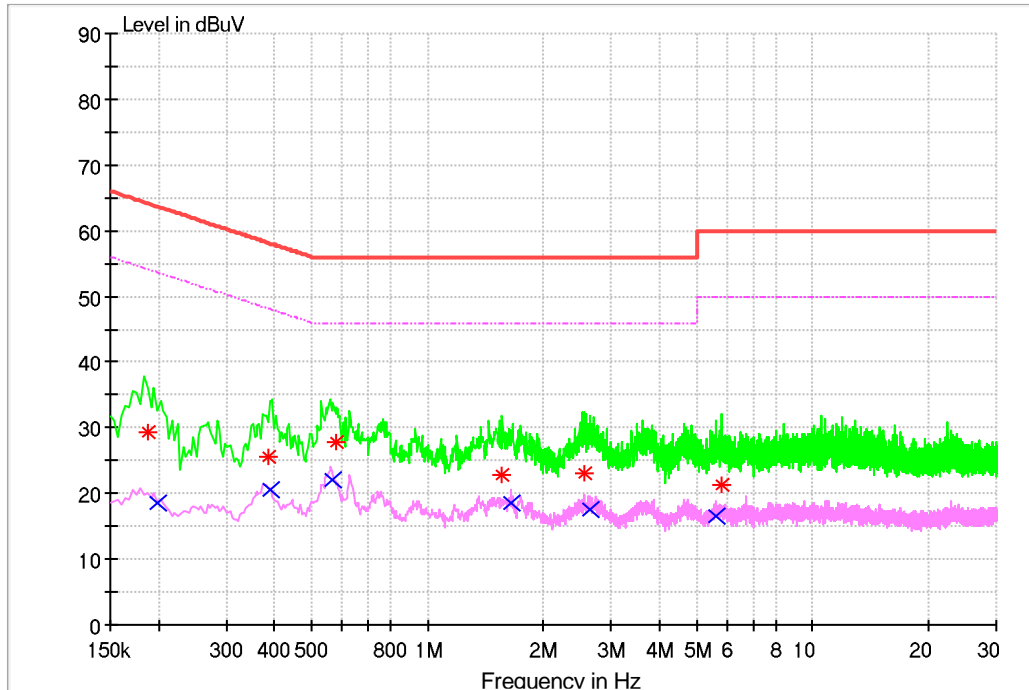

MEASUREMENT RESULT: QP Detector

Frequency MHz	Level dB $\mu$ V	Line	Transd dB	Margin dB	Limit dB $\mu$ V	PE
0.187165	29.37	L1	9.7	34.79	64.16	FLO
0.385108	25.48	N	9.7	32.69	58.17	FLO
0.577780	27.83	N	9.7	28.17	56.00	FLO
1.561718	22.91	N	9.7	33.09	56.00	FLO
2.556251	23.01	L1	9.8	32.99	56.00	FLO
5.792123	21.26	L1	9.8	38.74	60.00	FLO

MEASUREMENT RESULT: AV Detector

Frequency MHz	Level dB $\mu$ V	Line	Transd dB	Margin dB	Limit dB $\mu$ V	PE
0.199067	18.47	L1	9.7	35.18	53.65	FLO
0.389142	20.45	N	9.7	27.63	48.08	FLO
0.568754	21.95	N	9.7	24.05	46.00	FLO
1.651694	18.52	N	9.7	27.48	46.00	FLO
2.646318	17.48	L1	9.8	28.52	46.00	FLO
5.618551	16.56	N	9.8	33.44	50.00	FLO

Note:

Level= Reading level+ Transd (cable loss + correction factor)

The reading level is calculated by software which is not shown in the sheet.

-----END-----