



RF TEST REPORT

Applicant Huawei Technologies Co., Ltd.
FCC ID QISSTK-LX1
Product Smart Phone
Model STK-LX1
Report No. R1903H0032-R7V2
Issue Date March 29, 2019

TA Technology (Shanghai) Co., Ltd. tested the above equipment in accordance with the requirements in **FCC CFR47 Part 15C (2018)**. The test results show that the equipment tested is capable of demonstrating compliance with the requirements as documented in this report.

Performed by: Peng Tao

Approved by: Kai Xu

TA Technology (Shanghai) Co., Ltd.

No.145, Jintang Rd, Tangzhen Industry Park, Pudong Shanghai, China

TEL: +86-021-50791141/2/3

FAX: +86-021-50791141/2/3-8000



TABLE OF CONTENT

- 1. Test Laboratory 4
 - 1.1. Notes of the test report..... 4
 - 1.2. Test facility 4
 - 1.3. Testing Location..... 5
- 2. General Description of Equipment under Test..... 6
- 3. Applied Standards 8
- 4. Test Configuration 9
- 5. Test Case Results 10
 - 5.1. 20dB Bandwidth 10
 - 5.2. Frequency Stability..... 12
 - 5.3. Radiates Emission 17
 - 5.4. Conducted Emission 24
- 6. Main Test Instruments 28



Summary of measurement results

Number	Summary of measurements of results	Clause in FCC rules	Verdict
1	20 dB bandwidth	2.1049	PASS
2	Frequency Stability Tolerance	15.225(e)	PASS
3	Radiated Emissions	15.225 (a) (b) (c) (d) and 15.209	PASS
4	Conducted Emissions	15.207	PASS
Date of Testing: March 8, 2019~ March 29, 2019			



1. Test Laboratory

1.1. Notes of the test report

This report shall not be reproduced in full or partial, without the written approval of **TA technology (shanghai) co., Ltd.** The results documented in this report apply only to the tested sample, under the conditions and modes of operation as described herein .Measurement Uncertainties were not taken into account and are published for informational purposes only. This report is written to support regulatory compliance of the applicable standards stated above. This report must not be used by the client to claim product certification, approval, or endorsement by any government agencies.

1.2. Test facility

CNAS (accreditation number: L2264)

TA Technology (Shanghai) Co., Ltd. has obtained the accreditation of China National Accreditation Service for Conformity Assessment (CNAS).

FCC (Designation number: CN1179, Test Firm Registration Number: 446626)

TA Technology (Shanghai) Co., Ltd. has been listed on the US Federal Communications Commission list of test facilities recognized to perform electromagnetic emissions measurements.

IC (recognition number is 8510A)

TA Technology (Shanghai) Co., Ltd. has been listed by industry Canada to perform electromagnetic emission measurement.

VCCI (recognition number is C-4595, T-2154, R-4113, G-10766)

TA Technology (Shanghai) Co., Ltd. has been listed by industry Japan to perform electromagnetic emission measurement.

A2LA (Certificate Number: 3857.01)

TA Technology (Shanghai) Co., Ltd. has been listed by American Association for Laboratory Accreditation to perform electromagnetic emission measurement.



1.3. Testing Location



Company: TA Technology (Shanghai) Co., Ltd.
Address: No.145, Jintang Rd, Tangzhen Industry Park, Pudong
City: Shanghai
Post code: 201201
Country: P. R. China
Contact: Xu Kai
Telephone: +86-021-50791141/2/3
Fax: +86-021-50791141/2/3-8000
Website: <http://www.ta-shanghai.com>
E-mail: xukai@ta-shanghai.com

2. General Description of Equipment under Test







Client Information

Applicant	Huawei Technologies Co., Ltd.
Applicant address	Administration Building, Headquarters of Huawei Technologies Co., Ltd., Bantian, Longgang District, Shenzhen, 518129, P.R.China.
Manufacturer	Huawei Technologies Co., Ltd.
Manufacturer address	Administration Building, Headquarters of Huawei Technologies Co., Ltd., Bantian, Longgang District, Shenzhen, 518129, P.R.China.

General information

EUT Description			
Model:	STK-LX1		
IMEI:	IMEI 1:860815040043101 IMEI 2:860815040048027		
Hardware Version:	HL1STKM		
Software Version:	STK-LX1 9.0.1.18		
Power Supply:	Battery/AC adapter		
Antenna Type:	Internal Antenna		
Antenna Connector	A permanently attached antenna (meet with the standard FCC Part 15.203 requirement)		
Test Mode:	NFC-A	NFC-B	NFC-F
Modulation Type:	ASK	ASK, BPSK	ASK
Operating Frequency Range(s)	13.56MHz		
EUT Accessory			
Adapter 1	Manufacturer: Huawei Technologies Co., Ltd. Model: HW-050200U01 Input Voltage: 100-240V ~50/60Hz 0.5A Output Voltage: 5V  2A		
Adapter 2	Manufacturer: Huawei Technologies Co., Ltd. Model: HW-050200E01 Input Voltage: 100-240V ~50/60Hz 0.5A Output Voltage: 5V  2A		
Adapter 3	Manufacturer: Huawei Technologies Co., Ltd. Model: HW-050200B01 Input Voltage: 100-240V ~50/60Hz 0.5A Output Voltage: 5V  2A		
Adapter 4	Manufacturer: Huawei Technologies Co., Ltd. Model: HW-050200A01 Input Voltage: 100-240V ~50/60Hz 0.5A		



	Output Voltage: 5V  2A
Adapter 5	Manufacturer: Huawei Technologies Co., Ltd. Model: HW-050200U02 Input Voltage: 100-240V ~50/60Hz 0.5A Output Voltage: 5V  2A
Adapter 6	Manufacturer: Huawei Technologies Co., Ltd. Model: HW-050200E02 Input Voltage: 100-240V ~50/60Hz 0.5A Output Voltage: 5V  2A
Adapter 7	Manufacturer: Huawei Technologies Co., Ltd. Model: HW-050200A02 Input Voltage: 100-240V ~50/60Hz 0.5A Output Voltage: 5V  2A
Adapter 8	Manufacturer: Huawei Technologies Co., Ltd. Model: HW-050200B02 Input Voltage: 100-240V ~50/60Hz 0.5A Output Voltage: 5V  2A
Battery	Manufacturer: Huawei Technologies Co., Ltd. Model: HB446486ECW Rated capacity: 3900mAh Nominal Voltage:  +3.82V Charging Voltage:  +4.40V
Earphone 1	Manufacturer: Boluo County Quancheng Electronic Co.,Ltd Model: 1293-3283-3.5MM-322
Earphone 2	Manufacturer: Jiangxi Lianchuang Hongsheng Electronic Co.,LTD Model: MEND1532B528A02
USB cable 1	Manufacturer: NingBo Broad Telecommunication Co.,Ltd. Model: WA0020
USB cable 2	Manufacturer: LUXSHARE Precision Industry Co., Ltd. Model: L99UC131-CS-H
USB cable 3	Manufacturer: HONGFUJIN PRECISION INDUSTRIAL (SHENZHEN).LTD Model: CUDU01B-HC295-EH
USB cable 4	Manufacturer: Freeport Resources Enterprises (Jiangxi) Co.,Ltd Model: 18-93C2CHO-001HF
USB cable 5	Manufacturer: Dongguan Mingji Electronics Technology Group Co.,Ltd Model: 203-1572-0
<p>Note: The information of the EUT is declared by the manufacturer.</p> <p>2. There is more than one Adapter /USB cable/ Earphone, each one should be applied throughout the compliance test respectively, and however, only the worst case (Adapter 1/USB cable 2/ Earphone 2) will be recorded in this report.</p>	



3. Applied Standards

According to the specifications of the manufacturer, it must comply with the requirements of the following standards:

Test standards

- **FCC CFR47 Part 2 (2018)**
- **FCC CFR47 Part 15C (2018)**
- **ANSI C63.10 (2013)**



4. Test Configuration

Test Mode

The EUT was programmed to be in continuously transmitting mode and the transmit duty cycle is not less than 98%.

The EUT has been associated with peripherals and configuration operated in a manner tended to maximize its emission characteristics in a typical application.

5. Test Case Results

5.1. 20dB Bandwidth

Ambient condition

Temperature	Relative humidity	Pressure
23°C ~25°C	45%~50%	101.5kPa

Method of Measurement

The EUT was connected to the spectrum analyzer through an external attenuator (20dB) and a known loss cable. RBW is set to 10 kHz; VBW is set to 3 times thw RBW on spectrum analyzer.

Test Setup

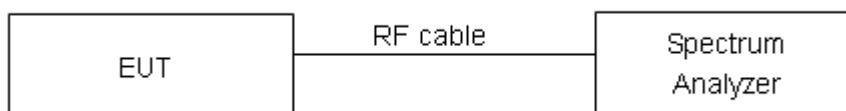

Limits

No specific occupied bandwidth requirements in part 2.1049.

Measurement Uncertainty

The assessed measurement uncertainty to ensure 95% confidence level for the normal distribution is with the coverage factor $k = 2$, $U = 936$ Hz.

Test Results:**NFC-A**

Carrier frequency (MHz)	99% Bandwidth (kHz)	20dB Bandwidth (kHz)	Conclusion
13.56MHz	24.484	28.50	PASS

NFC-B

Carrier frequency (MHz)	99% Bandwidth (kHz)	20dB Bandwidth (kHz)	Conclusion
13.56MHz	24.413	28.63	PASS

NFC-F

Carrier frequency (MHz)	99% Bandwidth (kHz)	20dB Bandwidth (kHz)	Conclusion
13.56MHz	24.466	28.58	PASS

5.2. Frequency Stability

Ambient condition

Temperature	Relative humidity
21°C ~25°C	40%~60%

Method of Measurement

1. Frequency Stability (Temperature Variation)

The temperature inside the climate chamber is varied from 0°C to +35°C in 10°C step size,

(1) With all power removed, the temperature was decreased to 0°C and permitted to stabilize for three hours.

(2) Measure the carrier frequency with the test equipment in a “call mode”. These measurements should be made within 1 minute of powering up the mobile station, to prevent significant self warming.

(3) Repeat the above measurements at 10°C increments from 0°C to +35°C. Allow at least 1.5 hours at each temperature, un-powered, before making measurements.

2. Frequency Stability (Voltage Variation)

The frequency stability shall be measured with variation of primary supply voltage as follows:

(1) Vary primary supply voltage from 85 to 115 percent of the nominal value for other than hand carried battery equipment.

(2) For hand carried, battery powered equipment, reduce primary supply voltage to the battery-operating end point which shall be specified by the manufacturer.

This transceiver is specified to operate with an input voltage of between 3.6V and 4.4 V, with a nominal voltage of 3.82V.

Test setup

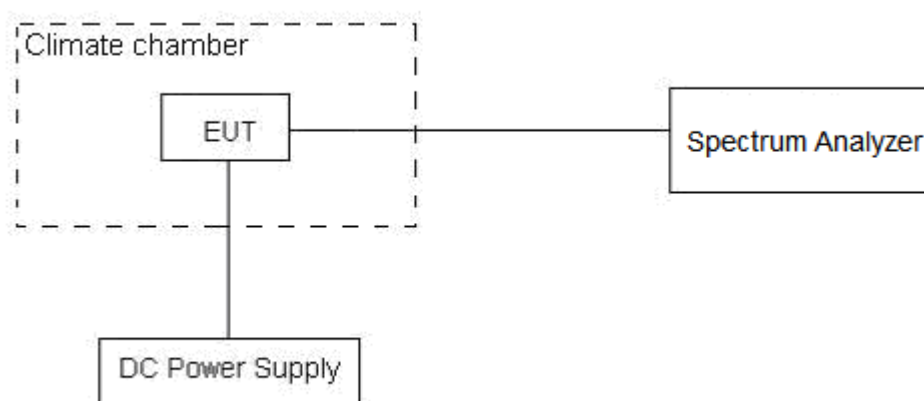

**Limits**

Rule Part 15.225 (e) The frequency tolerance of the carrier signal shall be maintained within $\pm 0.01\%$ of the operating frequency over a temperature variation of -20 degrees to $+ 50$ degrees C at normal supply voltage, and for a variation in the primary supply voltage from 85% to 115% of the rated supply voltage at a temperature of 20 degrees C. For battery operated equipment, the equipment tests shall be performed using a new battery.

Measurement Uncertainty

The assessed measurement uncertainty to ensure 99.75% confidence level for the normal distribution is with the coverage factor $k = 3$, $U = 0.01\text{ppm}$.



Test Result

NFC-A

Test status	Frequency				Tolerance (MHz)			
	13.56MHz							
	1min	2min	5min	10min	1min	2min	5min	10min
0°C/3.8 V	13.560336	13.560344	13.560351	13.560350	0.000336	0.000344	0.000351	0.000350
10°C/3.8 V	13.560344	13.560349	13.560341	13.560341	0.000344	0.000349	0.000341	0.000341
20°C/3.8 V	13.560339	13.560344	13.560334	13.560340	0.000339	0.000344	0.000334	0.000340
30°C/3.8 V	13.560351	13.560335	13.560343	13.560346	0.000351	0.000335	0.000343	0.000346
35°C/3.8 V	13.560352	13.560336	13.560343	13.560349	0.000352	0.000336	0.000343	0.000349
20°C/3.62 V	13.560339	13.560343	13.560351	13.560340	0.000339	0.000343	0.000351	0.000340
20°C/4.4 V	13.560341	13.560340	13.560345	13.560337	0.000341	0.000340	0.000345	0.000337

Test status	Tolerance (%)				Limit (%)	Conclusion
	1min	2min	5min	10min		
0°C/3.8 V	0.002479	0.002591	0.002477	0.002563	0.01	PASS
10°C/3.8 V	0.002456	0.002598	0.002511	0.002582	0.01	PASS
20°C/3.8 V	0.002475	0.002538	0.002590	0.002583	0.01	PASS
30°C/3.8 V	0.002537	0.002576	0.002514	0.002518	0.01	PASS
35°C/3.8 V	0.002499	0.002536	0.002462	0.002504	0.01	PASS
20°C/3.62 V	0.002585	0.002473	0.002532	0.002554	0.01	PASS
20°C/4.4 V	0.002594	0.002474	0.002529	0.002572	0.01	PASS



NFC-B

Test status	Frequency				Tolerance (MHz)			
	13.56MHz				1min	2min	5min	10min
	1min	2min	5min	10min				
0°C/3.8 V	13.560415	13.560409	13.560416	13.560407	0.000415	0.000409	0.000416	0.000407
10°C/3.8 V	13.560414	13.560405	13.560409	13.560414	0.000414	0.000405	0.000409	0.000414
20°C/3.8 V	13.560403	13.560402	13.560416	13.560404	0.000403	0.000402	0.000416	0.000404
30°C/3.8 V	13.560412	13.560411	13.560409	13.560416	0.000412	0.000411	0.000409	0.000416
35°C/3.8 V	13.560418	13.560415	13.560414	13.560418	0.000418	0.000415	0.000414	0.000418
20°C/3.62 V	13.560404	13.560415	13.560411	13.560412	0.000404	0.000415	0.000411	0.000412
20°C/4.4 V	13.560404	13.560413	13.560419	13.560406	0.000404	0.000413	0.000419	0.000406

Test status	Tolerance (%)				Limit(%)	Conclusion
	1min	2min	5min	10min		
0°C/3.8 V	0.003058	0.003019	0.003070	0.002998	0.01	PASS
10°C/3.8 V	0.003053	0.002990	0.003016	0.003053	0.01	PASS
20°C/3.8 V	0.002973	0.002966	0.003071	0.002978	0.01	PASS
30°C/3.8 V	0.003036	0.003032	0.003019	0.003065	0.01	PASS
35°C/3.8 V	0.003084	0.003061	0.003053	0.003083	0.01	PASS
20°C/3.62 V	0.002983	0.003064	0.003028	0.003035	0.01	PASS
20°C/4.4 V	0.002978	0.003043	0.003091	0.002995	0.01	PASS



NFC-F

Test status	Frequency				Tolerance (MHz)			
	13.56MHz							
	1min	2min	5min	10min	1min	2min	5min	10min
0°C/3.8 V	13.559793	13.559806	13.559811	13.559806	-0.000207	-0.000194	-0.000189	-0.000194
10°C/3.8 V	13.559793	13.559802	13.559793	13.559802	-0.000207	-0.000198	-0.000207	-0.000198
20°C/3.8 V	13.559811	13.559803	13.559801	13.559811	-0.000189	-0.000197	-0.000199	-0.000189
30°C/3.8 V	13.559804	13.559813	13.559807	13.559802	-0.000196	-0.000187	-0.000193	-0.000198
35°C/3.8 V	13.559800	13.559806	13.559803	13.559813	-0.000200	-0.000194	-0.000197	-0.000187
20°C/3.62 V	13.559798	13.559807	13.559807	13.559804	-0.000202	-0.000193	-0.000193	-0.000196
20°C/4.4 V	13.559808	13.559800	13.559808	13.559803	-0.000192	-0.000200	-0.000192	-0.000197

Test status	Tolerance (%)				Limit(%)	Conclusion
	1min	2min	5min	10min		
0°C/3.8 V	-0.001525	-0.001430	-0.001396	-0.001431	0.01	PASS
10°C/3.8 V	-0.001525	-0.001463	-0.001525	-0.001464	0.01	PASS
20°C/3.8 V	-0.001392	-0.001456	-0.001469	-0.001390	0.01	PASS
30°C/3.8 V	-0.001446	-0.001380	-0.001427	-0.001461	0.01	PASS
35°C/3.8 V	-0.001474	-0.001430	-0.001454	-0.001382	0.01	PASS
20°C/3.62 V	-0.001488	-0.001420	-0.001425	-0.001448	0.01	PASS
20°C/4.4 V	-0.001418	-0.001474	-0.001417	-0.001453	0.01	PASS

5.3. Radiates Emission

Ambient condition

Temperature	Relative humidity	Pressure
23°C ~25°C	45%~50%	102.5kPa

Method of Measurement

The test set-up was made in accordance to the general provisions of ANSI C63.10-2013. The Equipment Under Test (EUT) was set up on a non-conductive table in the semi-anechoic chamber. The test was performed at the distance of 3 m between the EUT and the receiving antenna. The radiated emissions measurements were made in a typical installation configuration.

Sweep the whole frequency band through the range from 9 kHz to the 10th harmonic of the carrier, and the emissions less than 20 dB below the permissible value are reported.

During the test, below 30MHz, the center of the loop shall be 1 meters; above 30MHz, the height of receive antenna shall be moved from 1 to 4 meters, and the antenna shall be performed under horizontal and vertical polarization. The turntable shall be rotated from 0 to 360 degrees for detecting the maximum of radiated spurious signal level. The measurements shall be repeated with orthogonal polarization of the test antenna. The data of cable loss and antenna factor has been calibrated in full testing frequency range before the testing.

Set the spectrum analyzer in the following:

Out-of-band

Below 30MHz

RBW=9KHz, VBW=30KHz, detector=peak;

Above 30MHz,

RBW=100KHz, VBW=300KHz, Detector=peak

In-band

RBW=9KHz, VBW=30KHz, detector=peak;

The field strength of spurious emission was measured in the following position: EUT stand-up position (Z axis), lie-down position (X, Y axis). The worst emission was found in lie-down position (X axis) and the loop antenna is vertical, the other antennas are vertical and horizontal.

Test setup

9kHz~~~ 30MHz

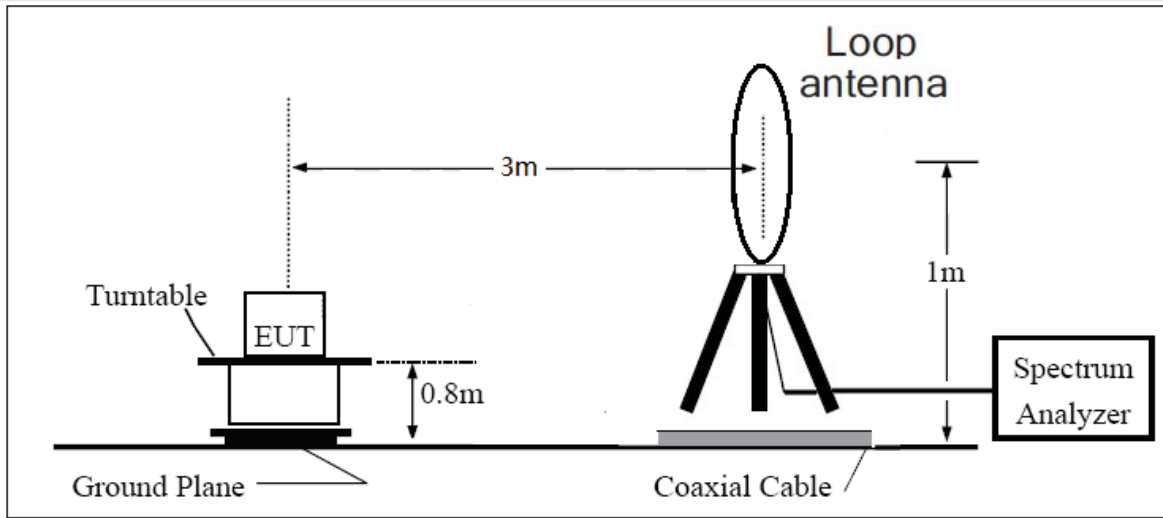

30MHz~~~ 1GHz

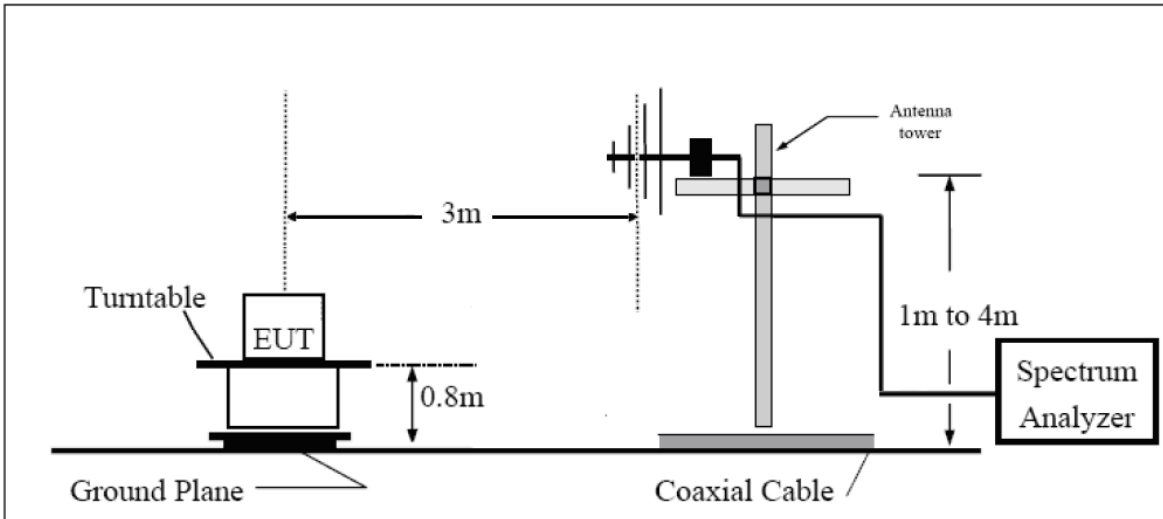

Above 1GHz

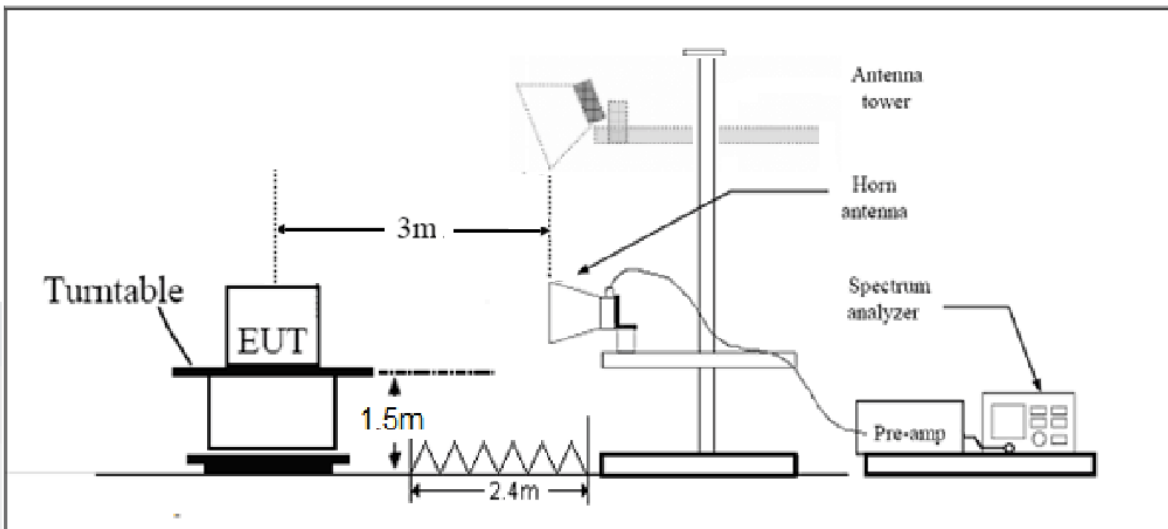

Note: Area side:2.4mX3.6m

Limits

Clause 15.225(a) the field strength of any emissions within the band 13.553-13.567 MHz shall not exceed 15,848 microvolts/meter at 30 meters.

Clause 15.225(b) within the bands 13.410-13.553 MHz and 13.567-13.710 MHz, the field strength of any emissions shall not exceed 334 microvolts/meter at 30 meters.

Clause 15.225(c) within the bands 13.110-13.410 MHz and 13.710-14.010 MHz the field strength of any emissions shall not exceed 106 microvolts/meter at 30 meters.

Clause 15.225(d) The field strength of any emissions appearing outside of the 13.110-14.010 MHz band shall not exceed the general radiated emission limits in §15.209.

§15.209 (a) Except as provided elsewhere in this subpart, the emissions from an intentional radiator shall not exceed the field strength levels specified in the following table:

Frequency of emission (MHz)	Field strength(uV/m)	Field strength(dBuV/m) @3m
0.009–0.490	2400/F(kHz)	128.519dBuV/m -93.8dBuV/m
0.490–1.705	24000/F(kHz)	73.8dBuV/m -62.969dBuV/m
1.705–30.0	30	69.5 dBuV/m
30-88	100	40
88-216	150	43.5
216-960	200	46
Above960	500	54

When using other measurement distance, according to the standard C63.10, If that point is closer to the EUT than $\lambda/2\pi$ and the limit distance is greater than $\lambda/2\pi$, the data was extrapolated to the specified measurement distance of 30m using extrapolation factor as specified in §6.4.4.2. Extrapolation Factor = $40\log(30/3)$

**Except as provided in paragraph (g), fundamental emissions from intentional radiators operating under this section shall not be located in the frequency bands 54-72 MHz, 76-88 MHz, 174-216 MHz or 470-806 MHz. However, operation within these frequency bands is permitted under other sections of this part, e.g., §§15.231 and 15.241.

§15.209 (b) In the emission table above, the tighter limit applies at the band edges.

§15.209 (d) The emission limits shown in the above table are based on measurements employing a CISPR quasi-peak detector except for the frequency bands 9-90 kHz, 110-490 kHz and above 1000 MHz. Radiated emission limits in these three bands are based on measurements employing an average detector.

Measurement Uncertainty

The assessed measurement uncertainty to ensure 95% confidence level for the normal distribution is with the coverage factor $k = 1.96$.

Frequency	Uncertainty
9KHz-30MHz	3.55 dB
30MHz-200MHz	4.02 dB
200MHz-1GHz	3.28 dB
Above 1GHz	3.70 dB

Test result

NFC-A was selected as the worst condition. The test data of the worst-case condition was recorded in this report.

In-band

FCC RE Part15C 13.56M

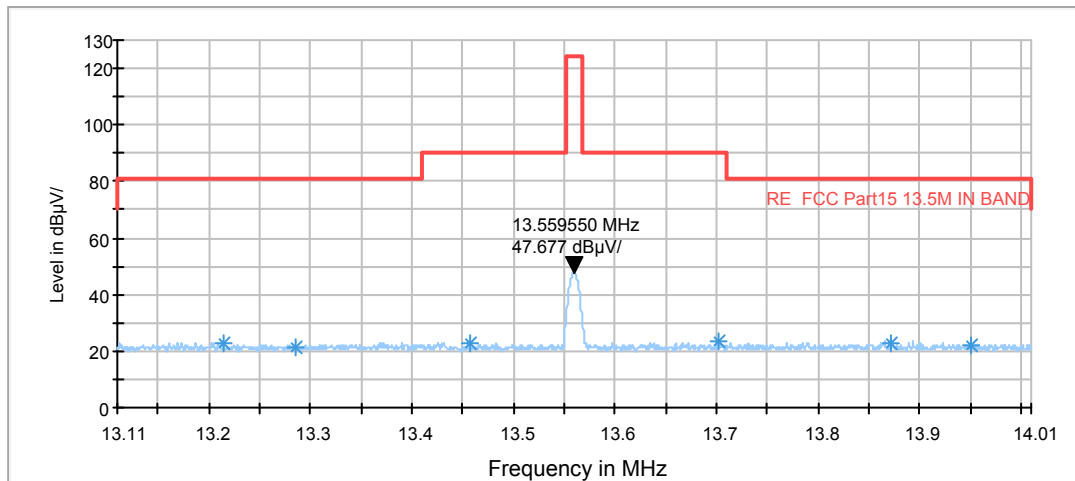

Radiates Emission from 13.11MHz to 14.01MHz

Note: This graph displays the maximum values of horizontal and vertical by software



Out-of-band

The following graphs display the maximum values of horizontal and vertical by software.
For above 1GHz, Blue trace uses the peak detection, Green trace uses the average detection.

FCC RE 9K-90KHz AV

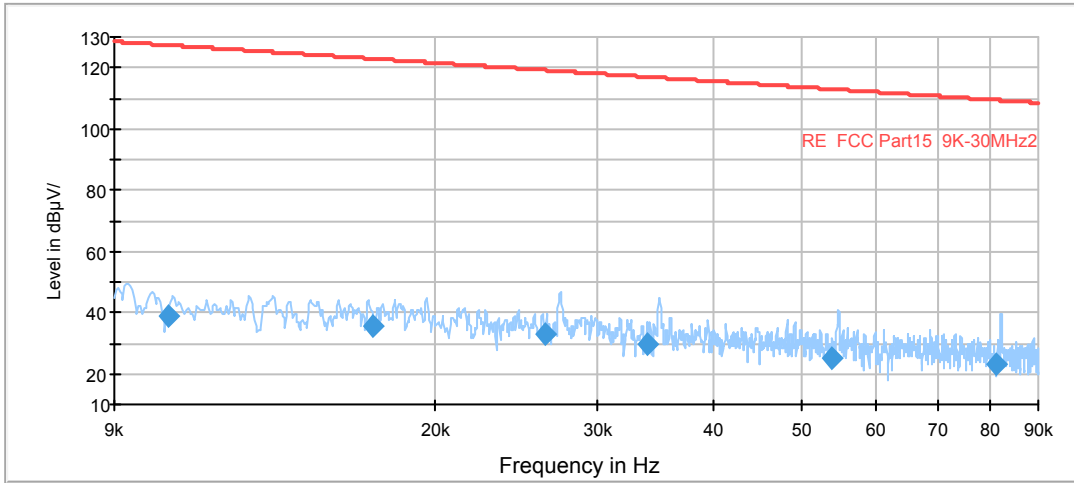

Radiates Emission from 9kHz to 90kHz

FCC RE 90K-110KHz QP

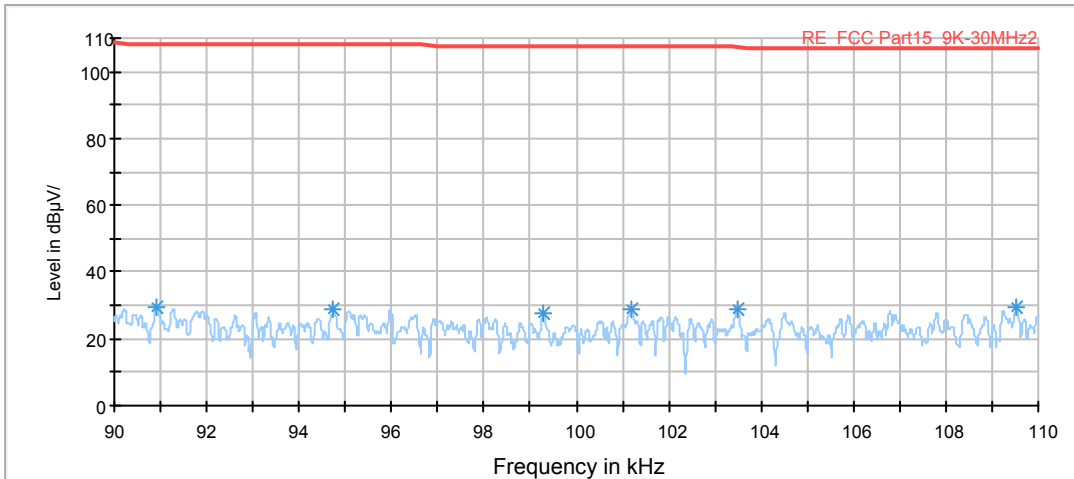

Radiates Emission from 90kHz to 110kHz

FCC RE 110K-490KHz AV

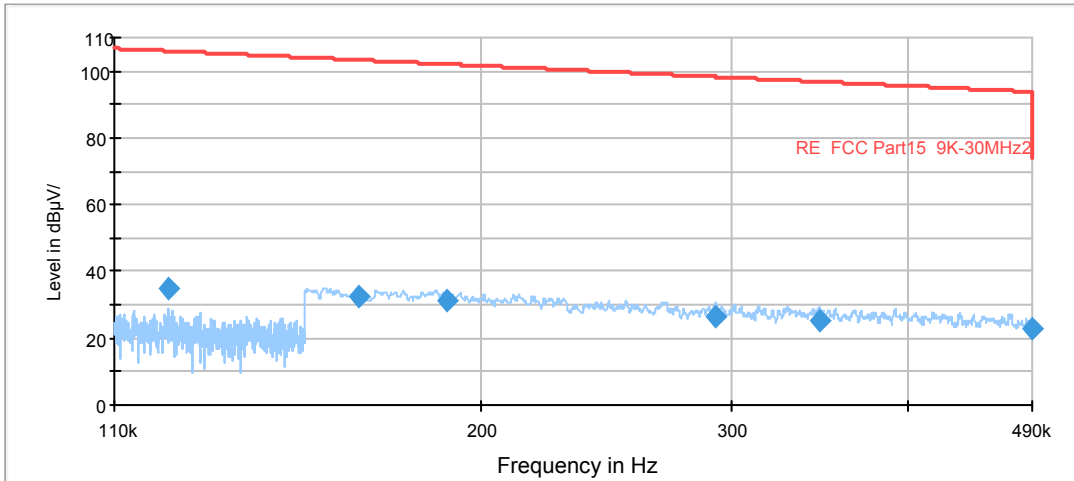

Radiates Emission from 110kHz to 490kHz

FCC RE 490K-30MHz QP

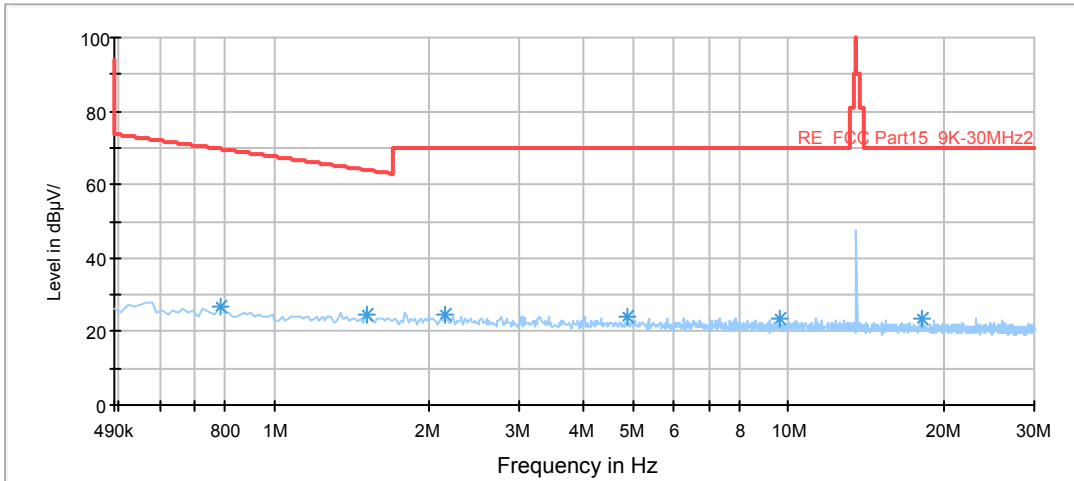

Radiates Emission from 490kHz to 30MHz

RE 0.03-1GHz QP Class B

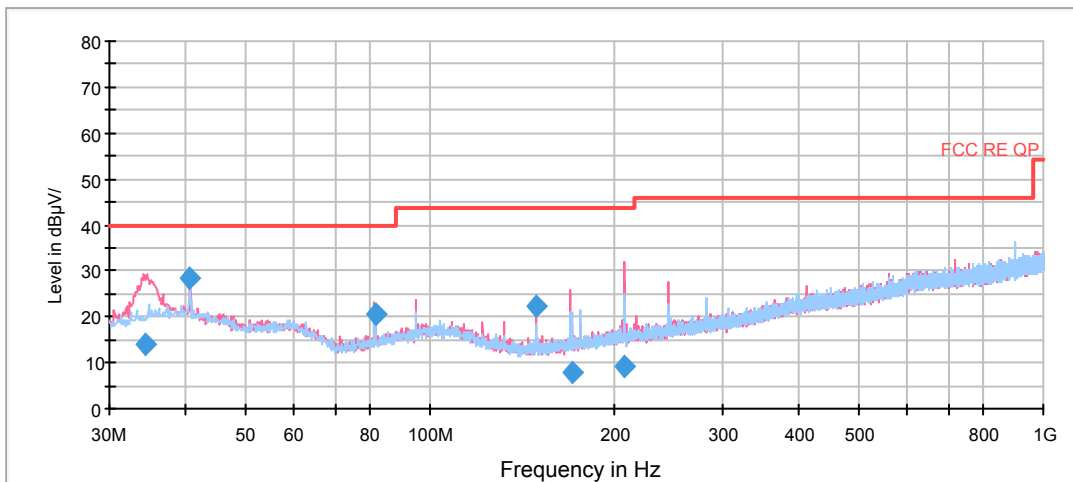

Radiates Emission from 30MHz to 1GHz

Note: This graph displays the maximum values of horizontal and vertical by software

Frequency (MHz)	Quasi-Peak (dBuV/m)	Height (cm)	Polarization	Azimuth (deg)	Reading value (dBuV/m)	Correct Factor (dB)	Margin (dB)	Limit (dBuV/m)
34.326250	14.2	100.0	V	26.0	-2.0	16.2	25.8	40.0
40.670000	28.5	100.0	V	273.0	11.6	16.9	11.5	40.0
81.368750	20.4	125.0	V	156.0	9.6	10.8	19.6	40.0
149.148750	22.3	100.0	V	244.0	12.8	9.5	21.2	43.5
170.037500	7.8	100.0	V	240.0	-2.6	10.4	35.7	43.5
207.226250	9.2	100.0	V	300.0	-2.8	12.0	34.3	43.5

5.4. Conducted Emission

Ambient condition

Temperature	Relative humidity	Pressure
23°C ~25°C	45%~50%	101.5kPa

Methods of Measurement

The EUT is placed on a non-metallic table of 80cm height above the horizontal metal reference ground plane. During the test, the EUT was operating in its typical mode. The test method is according to ANSI C63.10-2013. Connect the AC power line of the EUT to the L.I.S.N. Use EMI receiver to detect the average and Quasi-peak value. RBW is set to 9 kHz, VBW is set to 30kHz. The measurement result should include both L line and N line. The test is in transmitting mode.

Test Setup

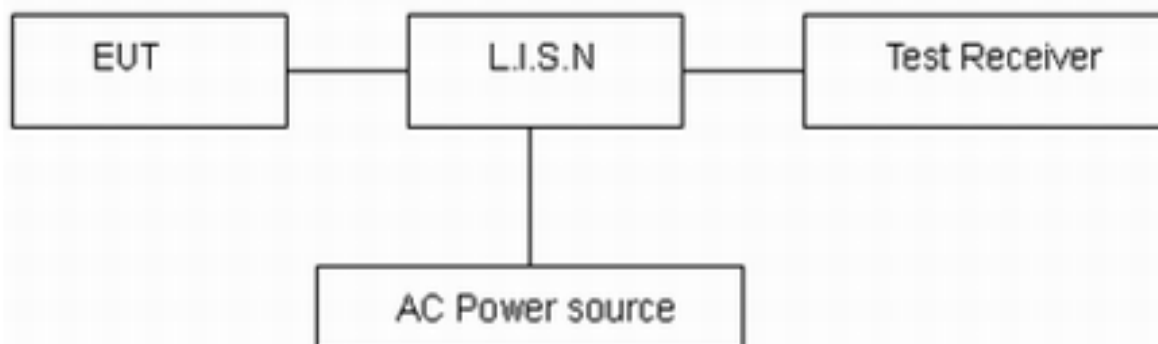

Note: AC Power source is used to change the voltage 110V/60Hz.

Limits

§15.207 (a) Except as shown in paragraphs (b) and (c) of this section, for an intentional radiator that is designed to be connected to the public utility (AC) power line, the radio frequency voltage that is conducted back onto the AC power line on any frequency or frequencies, within the band 150 kHz to 30 MHz, shall not exceed the limits in the following table, as measured using a 50 μH/50 ohms line impedance stabilization network (LISN). Compliance with the provisions of this paragraph shall be based on the measurement of the radio frequency voltage between each power line and ground at the power terminal. The lower limit applies at the boundary between the frequency ranges.

Frequency (MHz)	Conducted Limits(dBμV)	
	Quasi-peak	Average
0.15 - 0.5	66 to 56 *	56 to 46*
0.5 - 5	56	46



5 - 30	60	50
*: Decreases with the logarithm of the frequency.		

Measurement Uncertainty

The assessed measurement uncertainty to ensure 95% confidence level for the normal distribution is with the coverage factor $k = 1.96$, $U = 2.69$ dB.

Test Results:

Following plots, Blue trace uses the peak detection and Green trace uses the average detection.

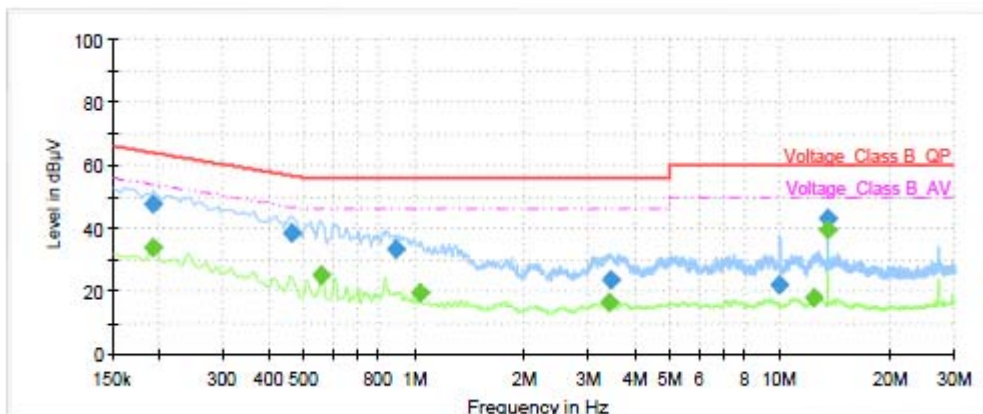

Frequency (MHz)	QuasiPeak (dBµV)	Average (dBµV)	Limit (dBµV)	Margin (dB)	Meas. Time (ms)	Bandwidth (kHz)	Line	Filter	Corr. (dB)
0.19	---	33.68	53.92	20.24	1000.0	9.000	L1	ON	19.18
0.19	47.91	---	63.92	16.01	1000.0	9.000	L1	ON	19.18
0.46	38.39	---	56.64	18.25	1000.0	9.000	L1	ON	19.23
0.56	---	24.88	46.00	21.12	1000.0	9.000	L1	ON	19.25
0.89	33.15	---	56.00	22.85	1000.0	9.000	L1	ON	19.24
1.04	---	19.28	46.00	26.72	1000.0	9.000	L1	ON	19.24
3.42	---	16.53	46.00	29.47	1000.0	9.000	L1	ON	19.05
3.46	23.77	---	56.00	32.23	1000.0	9.000	L1	ON	19.05
10.00	22.17	---	60.00	37.83	1000.0	9.000	L1	ON	19.40
12.37	---	17.81	50.00	32.19	1000.0	9.000	L1	ON	19.42
13.56	---	39.56	50.00	10.44	1000.0	9.000	L1	ON	19.48
13.56	43.02	---	60.00	16.98	1000.0	9.000	L1	ON	19.48

L line Conducted Emission from 150 KHz to 30 MHz

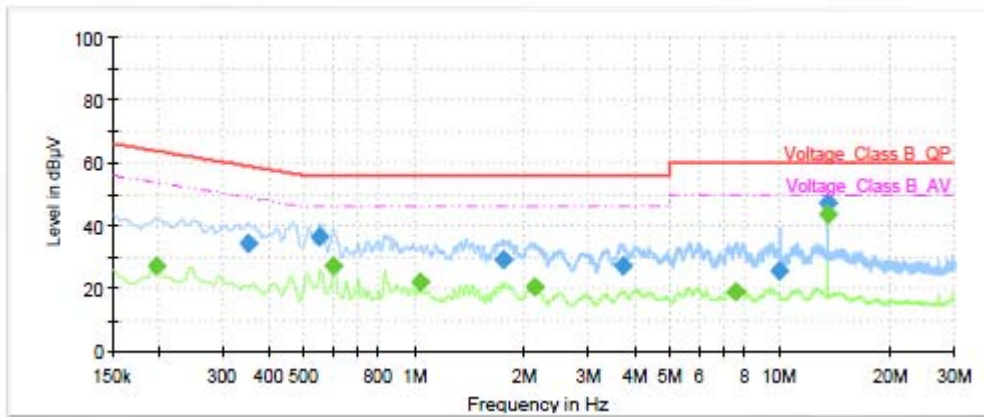

Frequency (MHz)	QuasiPeak (dBµV)	Average (dBµV)	Limit (dBµV)	Margin (dB)	Meas. Time (ms)	Bandwidth (kHz)	Line	Filter	Corr. (dB)
0.20	---	27.09	53.73	26.64	1000.0	9.000	N	ON	19.18
0.35	34.18	---	58.96	24.78	1000.0	9.000	N	ON	19.17
0.55	36.32	---	56.00	19.68	1000.0	9.000	N	ON	19.25
0.60	---	27.42	46.00	18.58	1000.0	9.000	N	ON	19.27
1.04	---	22.05	46.00	23.95	1000.0	9.000	N	ON	19.24
1.75	29.35	---	56.00	26.66	1000.0	9.000	N	ON	19.16
2.14	---	20.33	46.00	25.67	1000.0	9.000	N	ON	19.07
3.71	26.93	---	56.00	29.07	1000.0	9.000	N	ON	19.06
7.55	---	18.85	50.00	31.15	1000.0	9.000	N	ON	19.21
10.00	25.55	---	60.00	34.45	1000.0	9.000	N	ON	19.42
13.56	---	43.35	50.00	6.65	1000.0	9.000	N	ON	19.45
13.56	47.09	---	60.00	12.91	1000.0	9.000	N	ON	19.45

N line Conducted Emission from 150 KHz to 30 MHz



6. Main Test Instruments

Name	Manufacturer	Type	Serial Number	Calibration Date	Expiration Time
Spectrum Analyzer	R&S	FSV30	100815	2018-12-16	2019-12-15
EMI Test Receiver	R&S	ESCI	100948	2018-05-20	2019-05-19
Loop Antenna	SCHWARZBECK	FMZB1519	1519-047	2017-09-26	2019-09-25
TRILOG Broadband Antenna	Schwarzbeck	VULB 9163	9163-201	2017-11-18	2019-11-17
EMI Test Receiver	R&S	ESR	101667	2018-05-20	2019-05-19
LISN	R&S	ENV216	101171	2016-12-16	2019-12-15
Spectrum Analyzer	Agilent	N9020A	MY52330084	2018-05-20	2019-05-19
TEMPERATURE CHAMBER	WEISS	VT4002	582261194500 10	2018-12-16	2019-12-15
RF Cable	Agilent	SMA 15cm	0001	/	/
Software	R&S	EMC32	9.26.0	/	/

*****END OF REPORT *****