



RF TEST REPORT

Applicant Huawei Technologies Co., Ltd.
FCC ID QISSTK-LX1
Product Smart Phone
Model STK-LX1
Report No. R1903H0032-R8
Issue Date March 27, 2019

TA Technology (Shanghai) Co., Ltd. tested the above equipment in accordance with the requirements in **FCC CFR47 Part 15C (2018)**. The test results show that the equipment tested is capable of demonstrating compliance with the requirements as documented in this report.

Performed by: Peng Tao

Approved by: Kai Xu

TA Technology (Shanghai) Co., Ltd.

No.145, Jintang Rd, Tangzhen Industry Park, Pudong Shanghai, China

TEL: +86-021-50791141/2/3

FAX: +86-021-50791141/2/3-8000



TABLE OF CONTENT

- 1. Test Laboratory 4
 - 1.1. Notes of the test report..... 4
 - 1.2. Test facility 4
 - 1.3. Testing Location..... 5
- 2. General Description of Equipment under Test..... 6
- 3. Applied Standards 9
- 4. Test Configuration 10
- 5. Test Case Results 11
 - 5.1. Unwanted Emission 11
 - 5.2. Conducted Emission 27
- 6. Main Test Instruments..... 30



Summary of measurement results

Number	Summary of measurements of results	Clause in FCC rules	Verdict
1	Unwanted Emissions	15.247(d),15.205,15.209	PASS
2	Conducted Emissions	15.207	PASS
Date of Testing: March 8, 2019~ March 27, 2019			

1. Test Laboratory

1.1. Notes of the test report

This report shall not be reproduced in full or partial, without the written approval of **TA technology (shanghai) co., Ltd.** The results documented in this report apply only to the tested sample, under the conditions and modes of operation as described herein .Measurement Uncertainties were not taken into account and are published for informational purposes only. This report is written to support regulatory compliance of the applicable standards stated above.

1.2. Test facility

CNAS (accreditation number: L2264)

TA Technology (Shanghai) Co., Ltd. has obtained the accreditation of China National Accreditation Service for Conformity Assessment (CNAS).

FCC (Designation number: CN1179, Test Firm Registration Number: 446626)

TA Technology (Shanghai) Co., Ltd. has been listed on the US Federal Communications Commission list of test facilities recognized to perform electromagnetic emissions measurements.

IC (recognition number is 8510A)

TA Technology (Shanghai) Co., Ltd. has been listed by industry Canada to perform electromagnetic emission measurement.

VCCI (recognition number is C-4595, T-2154, R-4113, G-10766)

TA Technology (Shanghai) Co., Ltd. has been listed by industry Japan to perform electromagnetic emission measurement.

A2LA (Certificate Number: 3857.01)

TA Technology (Shanghai) Co., Ltd. has been listed by American Association for Laboratory Accreditation to perform electromagnetic emission measurement.



1.3. Testing Location



Company: TA Technology (Shanghai) Co., Ltd.
Address: No.145, Jintang Rd, Tangzhen Industry Park, Pudong
City: Shanghai
Post code: 201201
Country: P. R. China
Contact: Xu Kai
Telephone: +86-021-50791141/2/3
Fax: +86-021-50791141/2/3-8000
Website: <http://www.ta-shanghai.com>
E-mail: xukai@ta-shanghai.com

2. General Description of Equipment under Test









Client Information

Applicant	Huawei Technologies Co., Ltd.
Applicant address	Administration Building, Headquarters of Huawei Technologies Co., Ltd., Bantian, Longgang District, Shenzhen, 518129, P.R.China.
Manufacturer	Huawei Technologies Co., Ltd.
Manufacturer address	Administration Building, Headquarters of Huawei Technologies Co., Ltd., Bantian, Longgang District, Shenzhen, 518129, P.R.China.

General information

EUT Description	
Model	STK-LX1
IMEI	IMEI 1:860815040043101 IMEI 2:860815040048027
Hardware Version	HL1STKM
Software Version	STK-LX1 9.0.1.18
Power Supply	Battery/AC adapter
Antenna Type	Internal Antenna
Antenna Connector	A permanently attached antenna (meet with the standard FCC Part 15.203 requirement)
Antenna Gain	-2.5dBi
additional beamforming gain	NA
Test Mode	Bluetooth V4.2 LE
Modulation Type	BLE :GFSK
Operating Frequency Range(s)	BLE: 2402 ~2480 MHz
EUT Accessory	
Adapter 1	Manufacturer: Huawei Technologies Co., Ltd. Model: HW-050200U01 Input Voltage: 100-240V ~50/60Hz 0.5A Output Voltage: 5V  2A
Adapter 2	Manufacturer: Huawei Technologies Co., Ltd. Model: HW-050200E01 Input Voltage: 100-240V ~50/60Hz 0.5A Output Voltage: 5V  2A
Adapter 3	Manufacturer: Huawei Technologies Co., Ltd. Model: HW-050200B01



	Input Voltage: 100-240V ~50/60Hz 0.5A Output Voltage: 5V  2A
Adapter 4	Manufacturer: Huawei Technologies Co., Ltd. Model: HW-050200A01 Input Voltage: 100-240V ~50/60Hz 0.5A Output Voltage: 5V  2A
Adapter 5	Manufacturer: Huawei Technologies Co., Ltd. Model: HW-050200U02 Input Voltage: 100-240V ~50/60Hz 0.5A Output Voltage: 5V  2A
Adapter 6	Manufacturer: Huawei Technologies Co., Ltd. Model: HW-050200E02 Input Voltage: 100-240V ~50/60Hz 0.5A Output Voltage: 5V  2A
Adapter 7	Manufacturer: Huawei Technologies Co., Ltd. Model: HW-050200A02 Input Voltage: 100-240V ~50/60Hz 0.5A Output Voltage: 5V  2A
Adapter 8	Manufacturer: Huawei Technologies Co., Ltd. Model: HW-050200B02 Input Voltage: 100-240V ~50/60Hz 0.5A Output Voltage: 5V  2A
Battery	Manufacturer: Huawei Technologies Co., Ltd. Model: HB446486ECW Rated capacity: 3900mAh Nominal Voltage:  +3.82V Charging Voltage:  +4.40V
Earphone 1	Manufacturer: Boluo County Quancheng Electronic Co.,ltd Model: 1293-3283-3.5MM-322
Earphone 2	Manufacturer: Jiangxi Lianchuang Hongsheng Electronic Co.,LTD Model: MEND1532B528A02
USB cable 1	Manufacturer: NingBo Broad Telecommunication Co.,Ltd. Model: WA0020
USB cable 2	Manufacturer: LUXSHARE Precision Industry Co., Ltd. Model: L99UC131-CS-H
USB cable 3	Manufacturer: HONGFUJIN PRECISION INDUSTRIAL (SHENZHEN).LTD Model: CUDU01B-HC295-EH
USB cable 4	Manufacturer: Freeport Resources Enterprises (Jiangxi) Co.,Ltd Model: 18-93C2CHO-001HF
USB cable 5	Manufacturer: Dongguan Mingji Electronics Technology Group Co.,Ltd



	Model: 203-1572-0
--	-------------------

Note: The information of the EUT is declared by the manufacturer.

2. There is more than one Adapter /USB cable /Earphone, each one should be applied throughout the compliance test respectively, and however, only the worst case (Adapter 1/USB cable 2/ Earphone 2) will be recorded in this report.

3. Applied Standards

According to the specifications of the manufacturer, it must comply with the requirements of the following standards:

Test standards

- **FCC CFR47 Part 15C (2018) Radio Frequency Devices**
- **ANSI C63.10 (2013)**
- **KDB 558074 D01 15.247 Meas Guidance v05r01**

4. Test Configuration

Test Mode

The EUT has been associated with peripherals and configuration operated in a manner tended to maximize its emission characteristics in a typical application.

The radiated emission was measured in the following position: EUT stand-up position (Z axis), lie-down position (X, Y axis). The worst emission was found in lie-down position (X axis) and the loop antenna is vertical, the others are vertical and horizontal. and the worst case was recorded.

In order to find the worst case condition, Pre-tests are needed at the presence of different data rate. Preliminary tests have been done on all the configuration for confirming worst case. Data rate below means worst-case rate of each test item.

Worst-case data rates are shown as following table.

Band	Data Rate
Bluetooth(Low Energy)	1Mbps

5. Test Case Results

5.1. Unwanted Emission

Ambient condition

Temperature	Relative humidity	Pressure
23°C ~25°C	45%~50%	102.5kPa

Method of Measurement

The test set-up was made in accordance to the general provisions of ANSI C63.10-2013.

The Equipment Under Test (EUT) was set up on a non-conductive table in the semi-anechoic chamber. The test was performed at the distance of 3 m between the EUT and the receiving antenna.

The turntable shall be rotated from 0 to 360 degrees for detecting the maximum of radiated spurious signal level. The measurements shall be repeated with orthogonal polarization of the test antenna. The data of cable loss and antenna factor has been calibrated in full testing frequency range before the testing. Sweep the Restricted Band and the emissions less than 20 dB below the permissible value are reported.

The radiated emissions measurements were made in a typical installation configuration.

Sweep the whole frequency band through the range from 9 kHz to the 10th harmonic of the carrier, and the emissions less than 20 dB below the permissible value are reported.

This method refer to ANSI C63.10-2013.

The procedure for peak unwanted emissions measurements above 1000 MHz is as follows:

I) Peak emission levels are measured by setting the instrument as follows:

- 1) RBW = 1 MHz.
- 2) VBW \geq [3 \times RBW]
- 3) Detector = peak.
- 4) Sweep time = auto.
- 5) Trace mode = max hold.
- 6) Allow sweeps to continue until the trace stabilizes. Note that if the transmission is not continuous, then the time required for the trace to stabilize will increase by a factor of approximately 1 / D, where D is the duty cycle.

II) Average emission levels are measured by setting the instrument as follows:

- a) RBW = 1 MHz.
- b) VBW \geq [3 \times RBW].
- c) Detector = RMS (power averaging), if [span / (# of points in sweep)] \leq RBW / 2. Satisfying this condition can require increasing the number of points in the sweep or reducing the span. If the



condition is not satisfied, then the detector mode shall be set to peak.

d) Averaging type = power (i.e., rms) (As an alternative, the detector and averaging type may be set for linear voltage averaging. Some instruments require linear display mode to use linear voltage averaging. Log or dB averaging shall not be used.)

e) Sweep time = auto.

f) Perform a trace average of at least 100 traces if the transmission is continuous. If the transmission is not continuous, then the number of traces shall be increased by a factor of $1 / D$, where D is the duty cycle. For example, with 50% duty cycle, at least 200 traces shall be averaged. (If a specific emission is demonstrated to be continuous—i.e., 100% duty cycle—then rather than turning ON and OFF with the transmit cycle, at least 100 traces shall be averaged.)

g) If tests are performed with the EUT transmitting at a duty cycle less than 98%, then a correction factor shall be added to the measurement results prior to comparing with the emission limit, to compute the emission level that would have been measured had the test been performed at 100% duty cycle. The correction factor is computed as follows:

1) If power averaging (rms) mode was used in the preceding step e), then the correction factor is $[10 \log (1 / D)]$, where D is the duty cycle. For example, if the transmit duty cycle was 50%, then 3 dB shall be added to the measured emission levels.

2) If linear voltage averaging mode was used in the preceding step e), then the correction factor is $[20 \log (1 / D)]$, where D is the duty cycle. For example, if the transmit duty cycle was 50%, then 6 dB shall be added to the measured emission levels.

3) If a specific emission is demonstrated to be continuous (100% duty cycle) rather than turning ON and OFF with the transmit cycle, then no duty cycle correction is required for that emission.

The test is in transmitting mode.

Test setup

9KHz ~ 30MHz

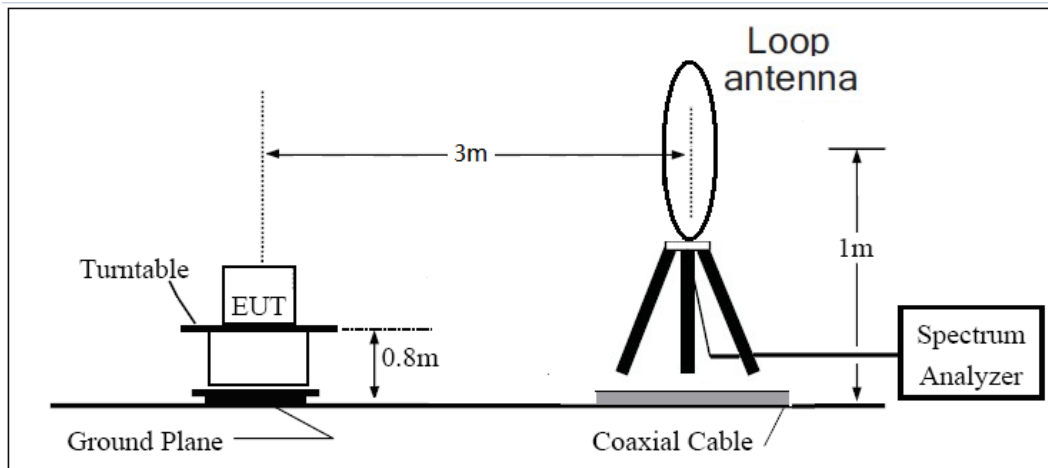

30MHz ~ 1GHz

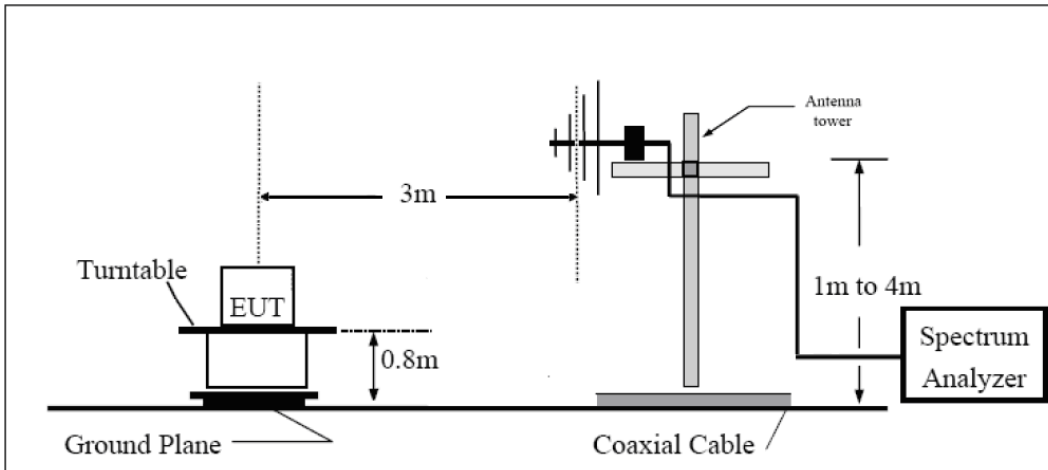

Above 1GHz

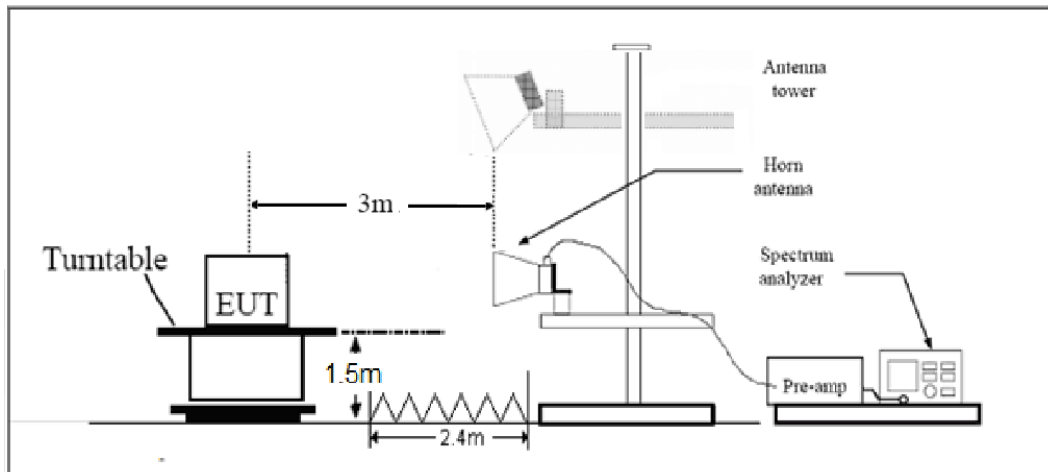

Note: Area side:2.4mX3.6m

**Limits**

Rule Part 15.247(d) specifies that "In addition, radiated emissions which fall in the restricted bands, as defined in § 15.205(a), must also comply with the radiated emission limits specified in § 15.209(a) (see § 15.205(c))."

Limit in restricted band

Frequency of emission (MHz)	Field strength(uV/m)	Field strength(dBuV/m)
0.009–0.490	2400/F(kHz)	/
0.490–1.705	24000/F(kHz)	/
1.705–30.0	30	/
30-88	100	40
88-216	150	43.5
216-960	200	46
Above960	500	54

§15.35(b)

There is also a limit on the radio frequency emissions, as measured using instrumentation with a peak detector function, corresponding to 20 dB above the maximum permitted average limit.

Peak Limit=74 dBuV/m

Average Limit=54 dBuV/m

Spurious Radiated Emissions are permitted in any of the frequency bands listed below:

MHz	MHz	MHz	GHz
0.090 - 0.110	16.42 - 16.423	399.9 - 410	4.5 - 5.15
¹ 0.495 - 0.505	16.69475 - 16.69525	608 - 614	5.35 - 5.46
2.1735 - 2.1905	16.80425 - 16.80475	960 - 1240	7.25 - 7.75
4.125 - 4.128	25.5 - 25.67	1300 - 1427	8.025 - 8.5
4.17725 - 4.17775	37.5 - 38.25	1435 - 1626.5	9.0 - 9.2
4.20725 - 4.20775	73 - 74.6	1645.5 - 1646.5	9.3 - 9.5
6.215 - 6.218	74.8 - 75.2	1660 - 1710	10.6 - 12.7
6.26775 - 6.26825	108 - 121.94	1718.8 - 1722.2	13.25 - 13.4
6.31175 - 6.31225	123 - 138	2200 - 2300	14.47 - 14.5
8.291 - 8.294	149.9 - 150.05	2310 - 2390	15.35 - 16.2
8.362 - 8.366	156.52475 - 156.52525	2483.5 - 2500	17.7 - 21.4
8.37625 - 8.38675	156.7 - 156.9	2690 - 2900	22.01 - 23.12
8.41425 - 8.41475	162.0125 - 167.17	3260 - 3267	23.6 - 24.0
12.29 - 12.293	167.72 - 173.2	3332 - 3339	31.2 - 31.8
12.51975 - 12.52025	240 - 285	3345.8 - 3358	36.43 - 36.5
12.57675 - 12.57725	322 - 335.4	3600 - 4400	(²)
13.36 - 13.41			

**Measurement Uncertainty**

The assessed measurement uncertainty to ensure 95% confidence level for the normal distribution is with the coverage factor $k = 1.96$.

Frequency	Uncertainty
9KHz-30MHz	3.55 dB
30MHz-200MHz	4.02 dB
200MHz-1GHz	3.28 dB
1-18GHz	3.70 dB
18-26.5GHz	5.78 dB



Test Results:

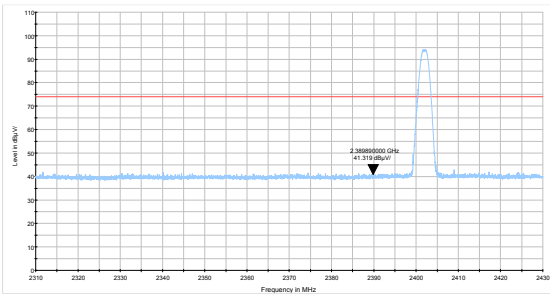

BLE Channel 0 Peak

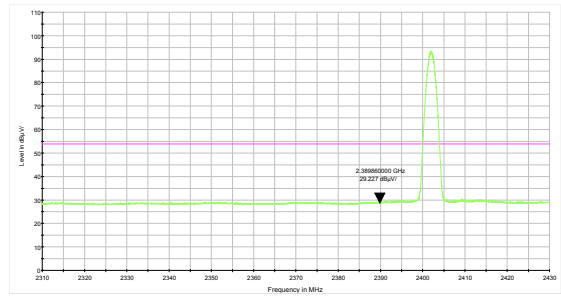

BLE Channel 0 Average

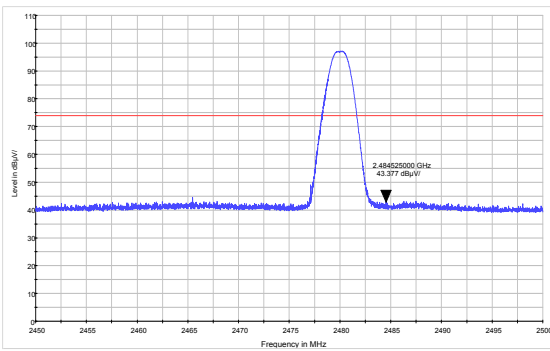

BLE Channel 39 Peak

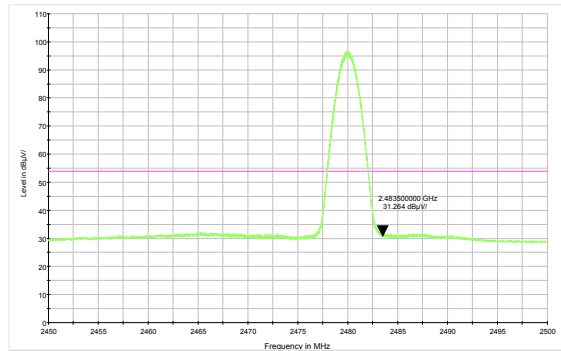

BLE Channel 39 Average



Result of RE

Test result

Sweep the whole frequency band through the range from 9kHz to the 10th harmonic of the carrier,

The following graphs display the maximum values of horizontal and vertical by software.
For above 1GHz, Blue trace uses the peak detection, Green trace uses the average detection.

During the test, the Radiates Emission from 9kHz to 1GHz was performed in all modes with all channels, **BLE-Channel 19** are selected as the worst condition. The test data of the worst-case condition was recorded in this report.

Continuous TX mode:

FCC RE 9K-90KHz AV

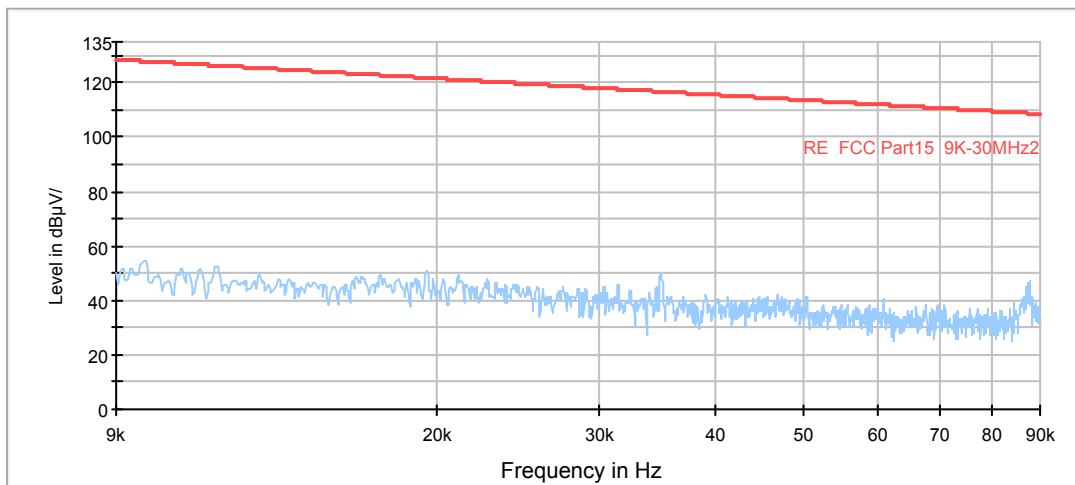

Radiates Emission from 9KHz to 90KHz

FCC RE 90K-110KHz QP

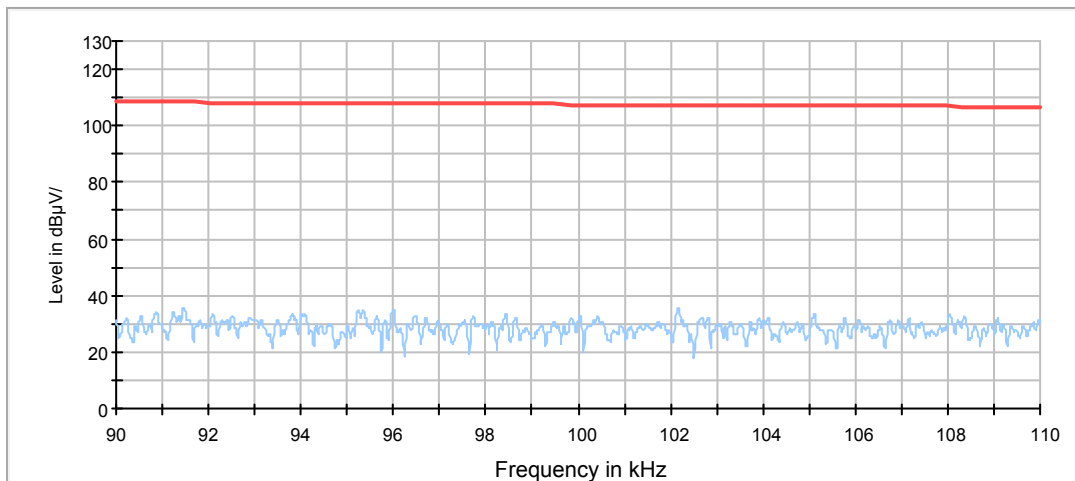

Radiates Emission from 90KHz to 110KHz

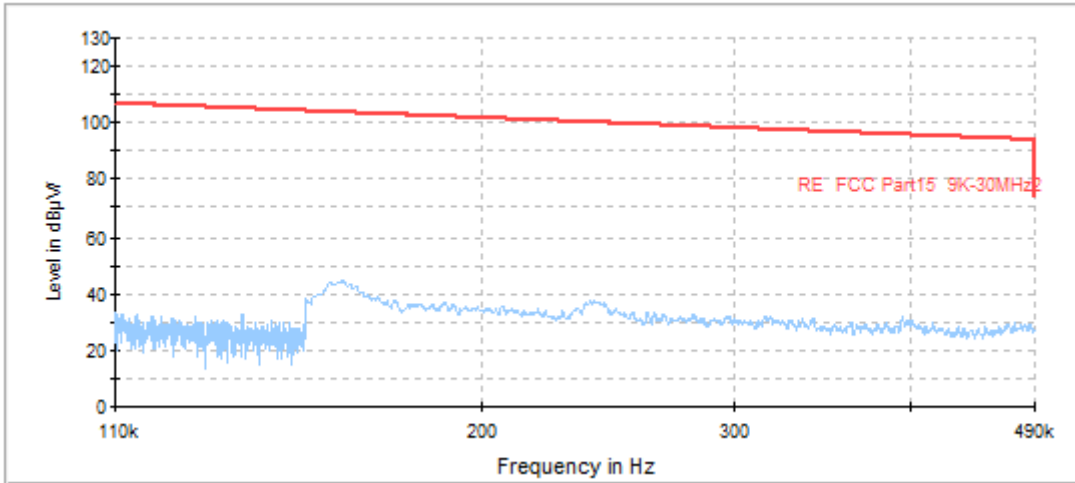

Radiates Emission from 110KHz to 490KHz

FCC RE 490K-30MHz QP

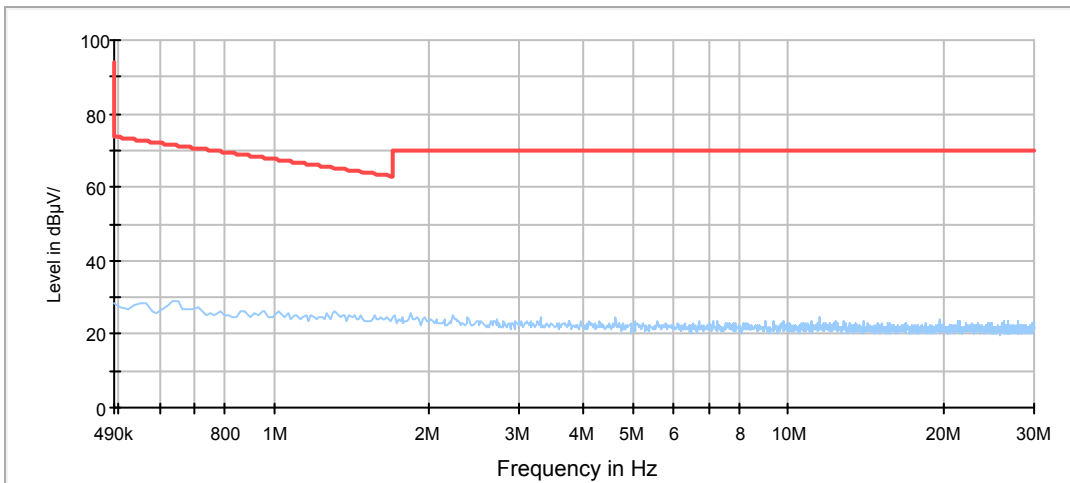

Radiates Emission from 490KHz to 30MHz

RE 0.03-1GHz QP Class B

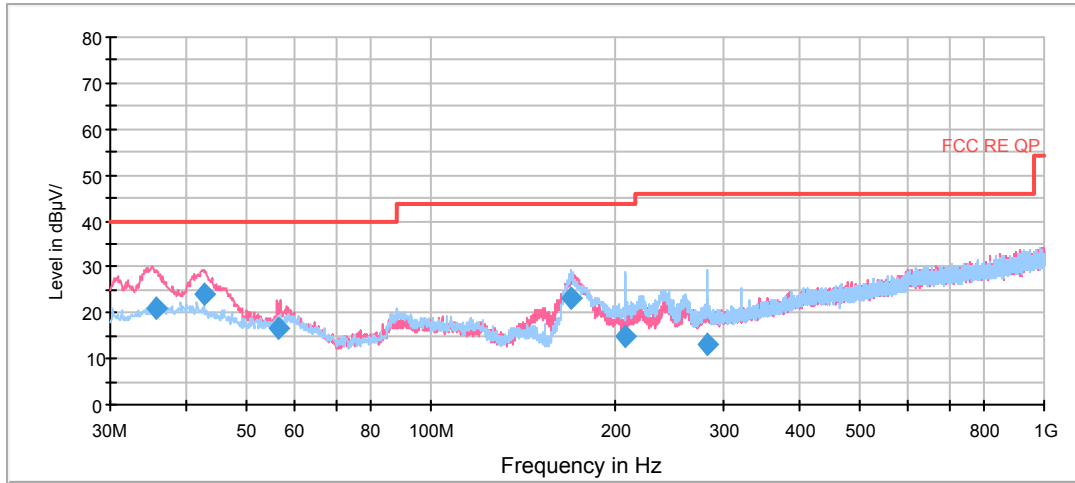

Radiates Emission from 30MHz to 1GHz

Frequency (MHz)	Quasi-Peak (dBuV/m)	Height (cm)	Polarization	Azimuth (deg)	Correct Factor (dB)	Margin (dB)	Limit (dBuV/m)
35.652500	21.0	100.0	V	0.0	16.7	19.0	40.0
42.568750	23.9	100.0	V	0.0	16.3	16.1	40.0
56.350000	16.6	114.0	V	175.0	13.9	23.4	40.0
169.561250	23.0	203.0	H	106.0	10.5	20.5	43.5
207.106250	14.7	100.0	H	273.0	12.0	28.8	43.5
282.731250	13.3	100.0	H	303.0	14.7	32.7	46.0

Remark: 1. Correction Factor = Antenna factor+ Insertion loss(cable loss+amplifier gain)

2. Margin = Limit – Quasi-Peak

BLE-Channel 0

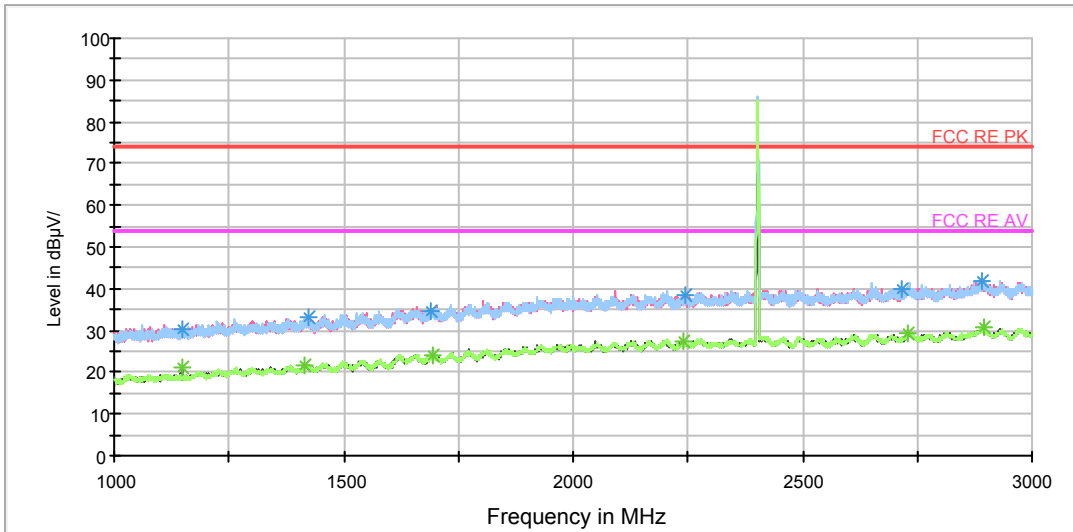

Note: The signal beyond the limit is carrier.

Radiates Emission from 1GHz to 3GHz

RE 3-18GHz PK+AV 15C

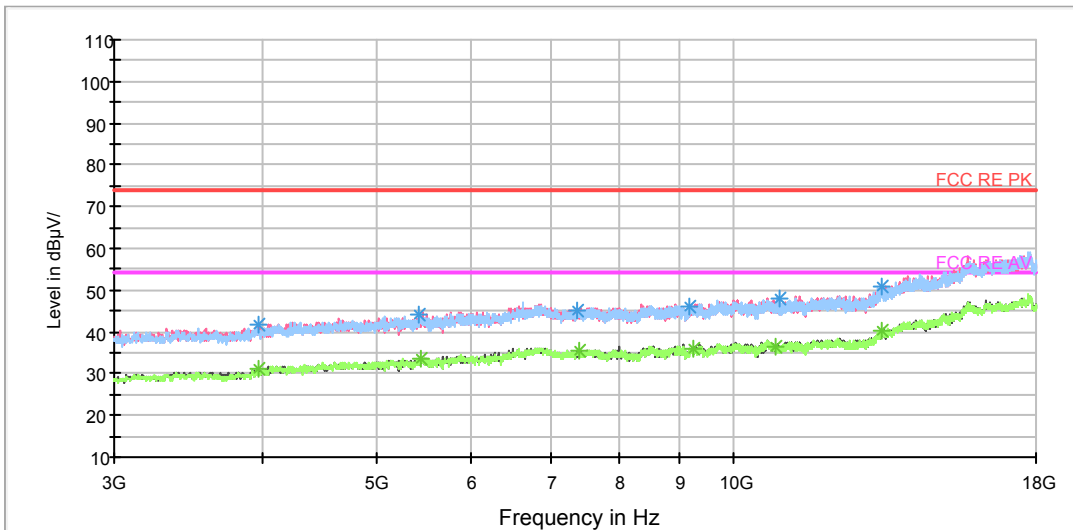

Radiates Emission from 3GHz to 18GHz



Frequency (MHz)	Peak (dBuV/m)	Height (cm)	Polarization	Azimuth (deg)	Correct Factor (dB)	Margin (dB)	Limit (dBuV/m)
1149.000000	30.4	200.0	V	119.0	-9.7	43.6	74
1421.750000	33.0	200.0	H	324.0	-8.0	41.0	74
1690.000000	34.7	200.0	V	20.0	-5.9	39.3	74
2242.750000	38.3	100.0	H	177.0	-3.6	35.7	74
2714.000000	39.9	200.0	V	20.0	-1.8	34.1	74
2892.750000	41.9	200.0	H	48.0	-0.1	32.1	74

Remark: 1. Correction Factor = Antenna factor+ Insertion loss (cable loss + amplifier gain)

Frequency (MHz)	Average (dBuV/m)	Height (cm)	Polarization	Azimuth (deg)	Correct Factor (dB)	Margin (dB)	Limit (dBuV/m)
1148.000000	21.2	200.0	V	0.0	-9.7	32.8	54
1416.000000	21.8	100.0	V	345.0	-8.1	32.2	54
1692.250000	24.0	200.0	V	149.0	-5.8	30.0	54
2238.000000	27.2	200.0	H	153.0	-3.6	26.8	54
2729.500000	29.3	100.0	V	20.0	-1.6	24.7	54
2896.250000	30.7	100.0	H	23.0	-0.2	23.3	54

Remark: 1. Correction Factor = Antenna factor+ Insertion loss (cable loss + amplifier gain)

BLE-Channel 19

RE 1G-3GHz PK+AV

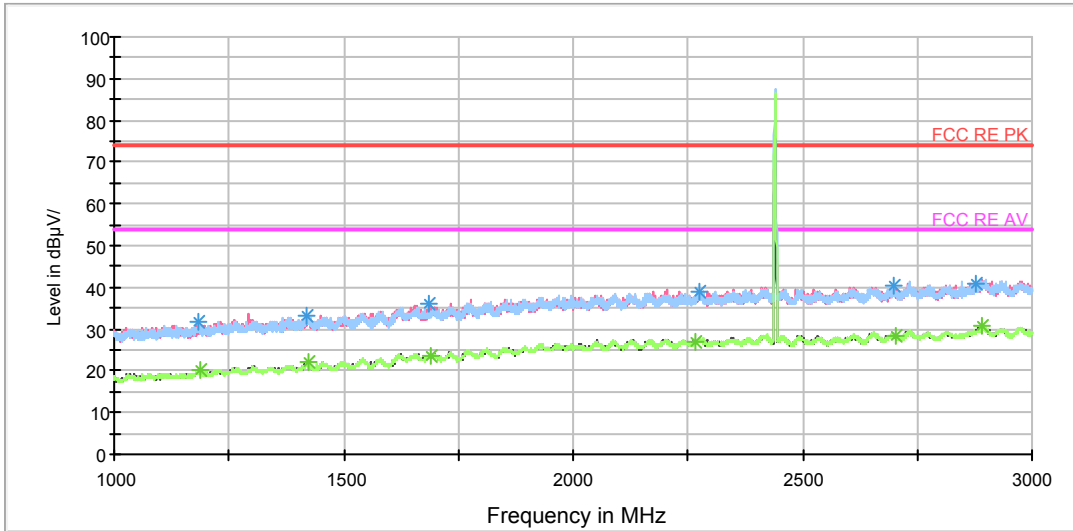

Note: The signal beyond the limit is carrier.
Radiates Emission from 1GHz to 3GHz

RE 3-18GHz PK+AV 15C

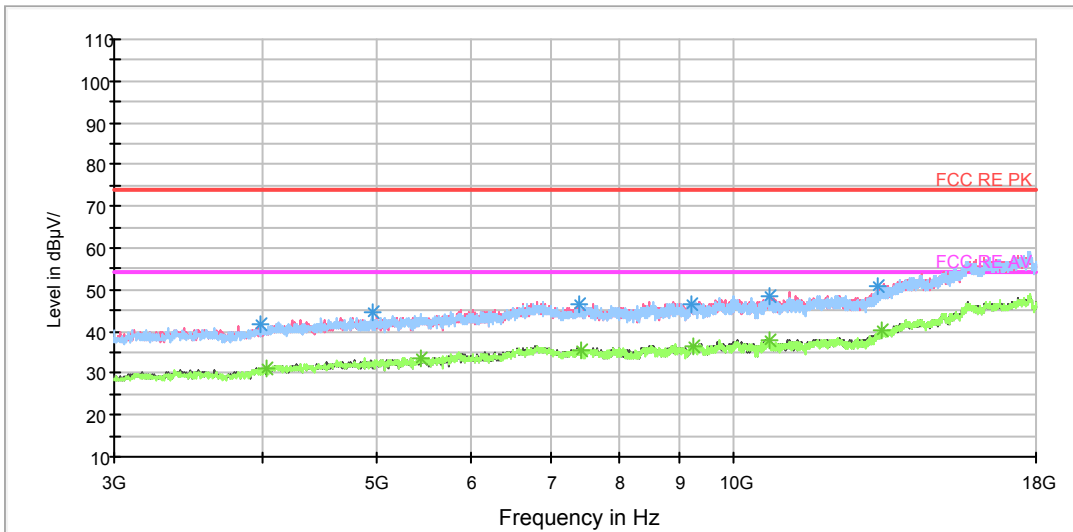

Radiates Emission from 3GHz to 18GHz



Frequency (MHz)	Peak (dBuV/m)	Height (cm)	Polarization	Azimuth (deg)	Correct Factor (dB)	Margin (dB)	Limit (dBuV/m)
1185.250000	31.7	100.0	H	45.0	-9.3	42.3	74
1420.250000	33.2	100.0	V	332.0	-8.0	40.8	74
1685.750000	35.9	200.0	V	194.0	-5.9	38.1	74
2276.750000	38.8	100.0	V	228.0	-2.6	35.2	74
2696.750000	40.3	200.0	H	300.0	-2.0	33.7	74
2877.750000	40.9	200.0	V	148.0	0.0	33.1	74

Remark: 1. Correction Factor = Antenna factor+ Insertion loss (cable loss + amplifier gain)

Frequency (MHz)	Average (dBuV/m)	Height (cm)	Polarization	Azimuth (deg)	Correct Factor (dB)	Margin (dB)	Limit (dBuV/m)
1186.750000	20.2	100.0	V	312.0	-9.3	33.8	54
1421.500000	22.0	100.0	V	41.0	-8.0	32.0	54
1688.250000	23.6	200.0	V	39.0	-5.9	30.4	54
2267.250000	27.1	100.0	V	269.0	-2.9	26.9	54
2702.250000	28.5	100.0	V	13.0	-2.0	25.5	54
2892.750000	30.8	100.0	H	92.0	-0.1	23.2	54

Remark: 1. Correction Factor = Antenna factor+ Insertion loss (cable loss + amplifier gain)

BLE-Channel 39

RE 1G-3GHz PK+AV

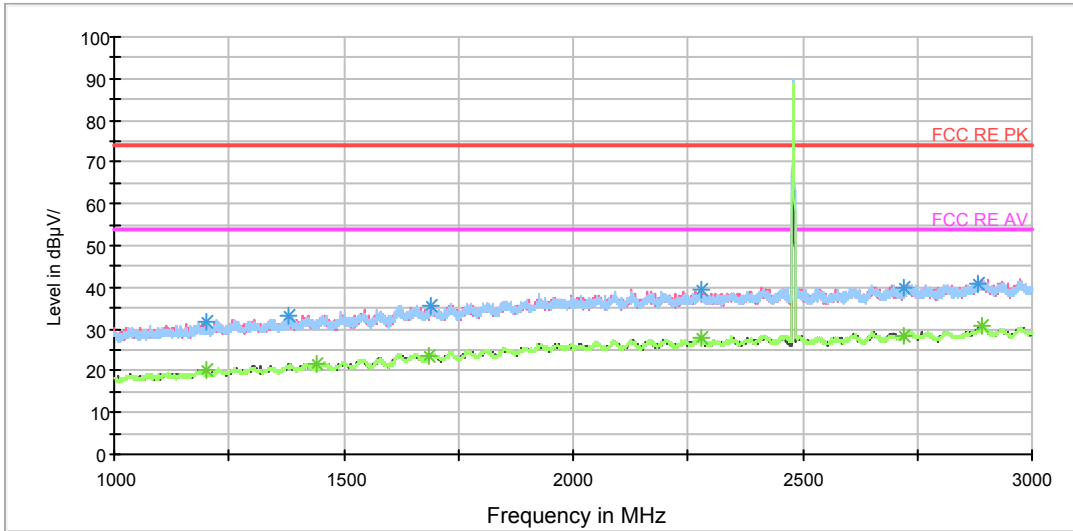

Note: The signal beyond the limit is carrier.
Radiates Emission from 1GHz to 3GHz

RE 3-18GHz PK+AV 15C

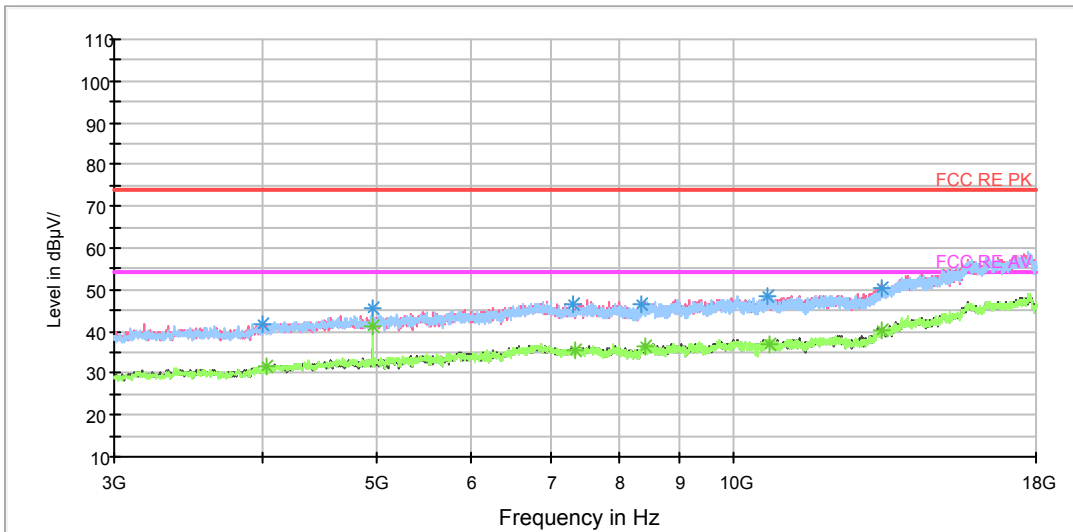

Radiates Emission from 3GHz to 18GHz



Frequency (MHz)	Peak (dBuV/m)	Height (cm)	Polarization	Azimuth (deg)	Correct Factor (dB)	Margin (dB)	Limit (dBuV/m)
1199.500000	31.5	100.0	H	239.0	-9.5	42.5	74
1382.000000	33.3	100.0	V	350.0	-8.1	40.7	74
1689.250000	35.8	100.0	V	209.0	-5.9	38.2	74
2277.500000	39.5	100.0	V	255.0	-2.6	34.5	74
2722.250000	39.9	200.0	H	285.0	-1.7	34.1	74
2880.750000	41.0	200.0	V	24.0	0.0	33.0	74

Remark: 1. Correction Factor = Antenna factor+ Insertion loss (cable loss + amplifier gain)

Frequency (MHz)	Average (dBuV/m)	Height (cm)	Polarization	Azimuth (deg)	Correct Factor (dB)	Margin (dB)	Limit (dBuV/m)
1200.250000	20.2	100.0	H	182.0	-9.5	33.8	54
1440.000000	21.8	200.0	H	249.0	-8.0	32.2	54
1683.500000	23.6	200.0	H	105.0	-5.9	30.4	54
2281.500000	27.7	100.0	V	0.0	-2.6	26.3	54
2719.000000	28.4	100.0	V	297.0	-1.7	25.6	54
2891.000000	30.6	200.0	H	300.0	-0.1	23.4	54

Remark: 1. Correction Factor = Antenna factor+ Insertion loss (cable loss + amplifier gain)



During the test, the Radiates Emission from 18GHz to 26.5GHz was performed in all modes with all channels, **BLE-Channel 19** are selected as the worst condition. The test data of the worst-case condition was recorded in this report.

RE 18-26.5GHz PK+AV

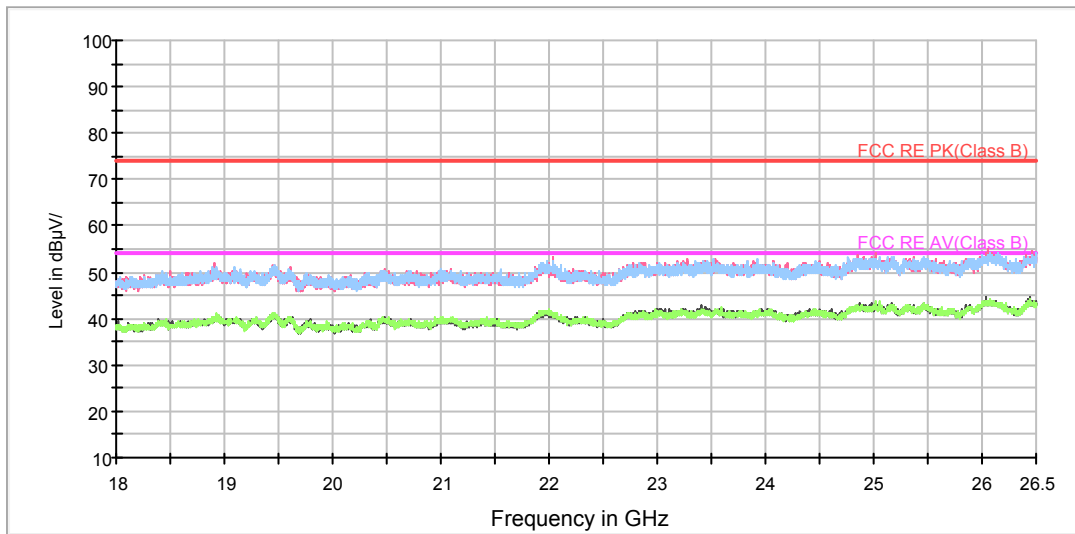

Radiates Emission from 18GHz to 26.5GHz

5.2. Conducted Emission

Ambient condition

Temperature	Relative humidity	Pressure
23°C ~25°C	45%~50%	101.5kPa

Methods of Measurement

The EUT is placed on a non-metallic table of 80cm height above the horizontal metal reference ground plane. During the test, the EUT was operating in its typical mode. The test method is according to ANSI C63.10-2013. Connect the AC power line of the EUT to the L.I.S.N. Use EMI receiver to detect the average and Quasi-peak value. RBW is set to 9 kHz, VBW is set to 30kHz. The measurement result should include both L line and N line.

The test is in transmitting mode.

Test Setup

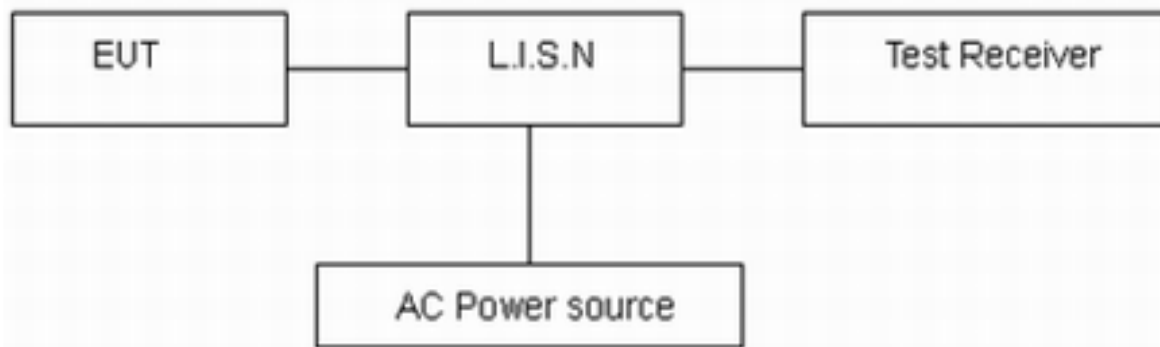

Note: AC Power source is used to change the voltage 110V/60Hz.

Limits

Frequency (MHz)	Conducted Limits(dBμV)	
	Quasi-peak	Average
0.15 - 0.5	66 to 56 *	56 to 46*
0.5 - 5	56	46
5 - 30	60	50

*: Decreases with the logarithm of the frequency.

Measurement Uncertainty

The assessed measurement uncertainty to ensure 95% confidence level for the normal distribution is with the coverage factor $k = 1.96$, $U = 2.69$ dB.

Test Results:

Following plots, Blue trace uses the peak detection and Green trace uses the average detection. During the test, the Conducted Emission was performed in all channels, **BLE-Channel 19** are selected as the worst condition. The test data of the worst-case condition was recorded in this report.

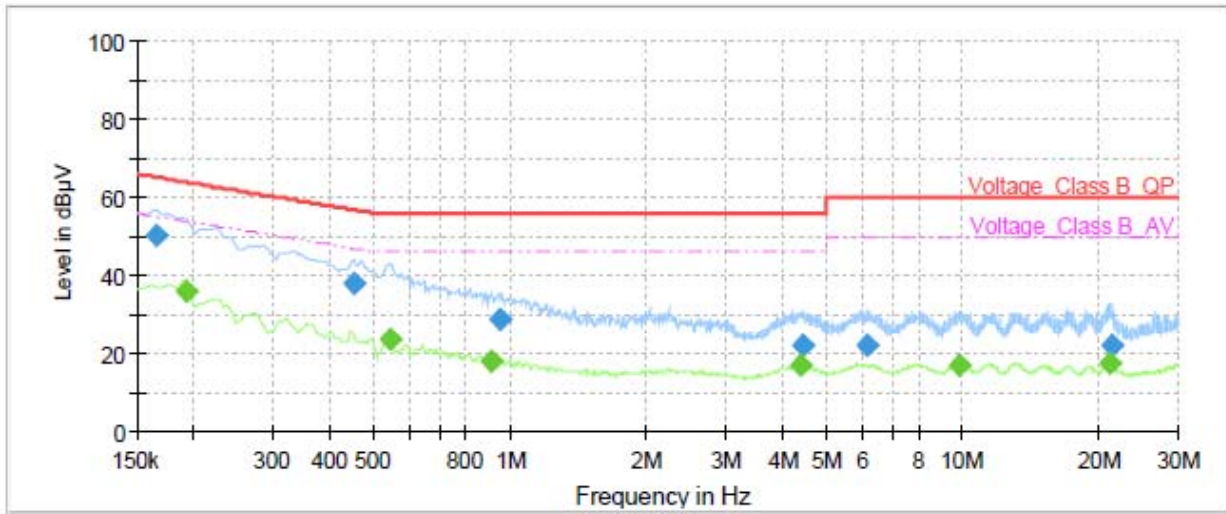

Frequency (MHz)	QuasiPeak (dBµV)	Average (dBµV)	Limit (dBµV)	Margin (dB)	Meas. Time (ms)	Bandwidth (kHz)	Line	Filter	Corr. (dB)
0.17	50.02	---	65.17	15.15	1000.0	9.000	L1	ON	19.14
0.19	---	35.67	53.92	18.25	1000.0	9.000	L1	ON	19.18
0.45	38.05	---	56.81	18.76	1000.0	9.000	L1	ON	19.23
0.54	---	23.73	46.00	22.27	1000.0	9.000	L1	ON	19.25
0.91	---	17.93	46.00	28.07	1000.0	9.000	L1	ON	19.24
0.95	28.52	---	56.00	27.48	1000.0	9.000	L1	ON	19.24
4.39	---	16.81	46.00	29.19	1000.0	9.000	L1	ON	19.10
4.43	22.03	---	56.00	33.97	1000.0	9.000	L1	ON	19.10
6.13	21.94	---	60.00	38.06	1000.0	9.000	L1	ON	19.12
9.89	---	17.12	50.00	32.88	1000.0	9.000	L1	ON	19.38
21.11	---	17.18	50.00	32.82	1000.0	9.000	L1	ON	19.66
21.40	21.82	---	60.00	38.18	1000.0	9.000	L1	ON	19.60

L line Conducted Emission from 150 KHz to 30 MHz

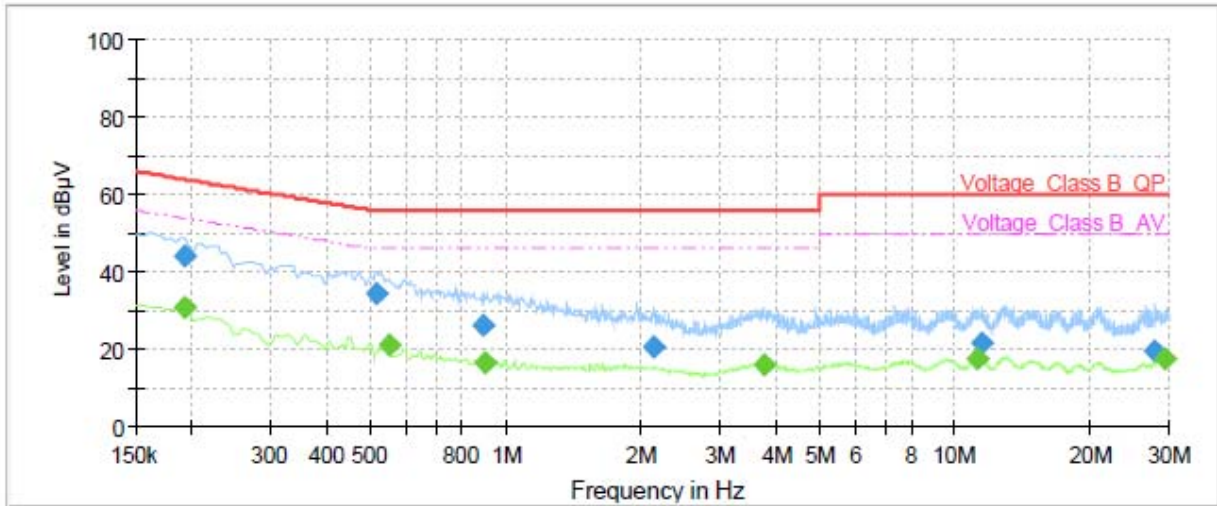

Frequency (MHz)	QuasiPeak (dBµV)	Average (dBµV)	Limit (dBµV)	Margin (dB)	Meas. Time (ms)	Bandwidth (kHz)	Line	Filter	Corr. (dB)
0.19	---	30.58	53.92	23.34	1000.0	9.000	N	ON	19.18
0.19	43.89	---	63.92	20.03	1000.0	9.000	N	ON	19.18
0.52	34.27	---	56.00	21.73	1000.0	9.000	N	ON	19.24
0.55	---	20.93	46.00	25.07	1000.0	9.000	N	ON	19.25
0.89	26.07	---	56.00	29.93	1000.0	9.000	N	ON	19.24
0.90	---	16.43	46.00	29.57	1000.0	9.000	N	ON	19.24
2.13	20.55	---	56.00	35.45	1000.0	9.000	N	ON	19.07
3.75	---	15.96	46.00	30.04	1000.0	9.000	N	ON	19.06
11.22	---	17.22	50.00	32.78	1000.0	9.000	N	ON	19.35
11.45	21.62	---	60.00	38.38	1000.0	9.000	N	ON	19.37
27.94	19.55	---	60.00	40.45	1000.0	9.000	N	ON	19.73
29.27	---	17.63	50.00	32.37	1000.0	9.000	N	ON	19.69

N line Conducted Emission from 150 KHz to 30 MHz



6. Main Test Instruments

Name	Manufacturer	Type	Serial Number	Calibration Date	Expiration Date
Spectrum Analyzer	R&S	FSV30	100815	2018-12-16	2019-12-15
EMI Test Receiver	R&S	ESCI	100948	2018-05-20	2019-05-19
Loop Antenna	SCHWARZBECK	FMZB1519	1519-047	2017-09-26	2019-09-25
TRILOG Broadband Antenna	Schwarzbeck	VULB 9163	9163-201	2017-11-18	2019-11-17
Double Ridged Waveguide Horn Antenna	R&S	HF907	100126	2018-07-07	2020-07-06
Standard Gain Horn	ETS-Lindgren	3160-09	00102643	2018-06-20	2020-06-19
EMI Test Receiver	R&S	ESR	101667	2018-05-20	2019-05-19
LISN	R&S	ENV216	101171	2016-12-16	2019-12-15
Software	R&S	EMC32	9.26.0	/	/

*****END OF REPORT *****