



RF TEST REPORT

Applicant Huawei Technologies Co., Ltd.
FCC ID QISSTK-LX1
Product Smart Phone
Model STK-LX1
Report No. R1903H0032-R5V1
Issue Date March 27, 2019

TA Technology (Shanghai) Co., Ltd. tested the above equipment in accordance with the requirements in **FCC CFR47 Part 15C (2018)**. The test results show that the equipment tested is capable of demonstrating compliance with the requirements as documented in this report.

Performed by: Peng Tao

Approved by: Kai Xu

TA Technology (Shanghai) Co., Ltd.

No.145, Jintang Rd, Tangzhen Industry Park, Pudong Shanghai, China

TEL: +86-021-50791141/2/3

FAX: +86-021-50791141/2/3-8000

Table of Contents

1	Test Laboratory	4
1.1	Notes of the Test Report	4
1.2	Test facility	4
1.3	Testing Location	5
2	General Description of Equipment under Test	6
3	Applied Standards	9
4	Information about the FHSS characteristics	10
4.1	Frequency Hopping System Requirement	10
4.2	Pseudorandom Frequency Hopping Sequence	11
4.3	Equal Hopping Frequency Use	12
4.4	System Receiver Input Bandwidth	12
4.5	Test Configuration	13
5	Test Case Results	14
5.1	Unwanted Emission	14
5.2	Conducted Emission	35
6	Main Test Instruments	38

Summary of Measurement Results

Number	Summary of measurements of results	Clause in FCC rules	Verdict
1	Unwanted Emissions	15.247(d),15.205,15.209	PASS
2	Conducted Emissions	15.207	PASS
Date of Testing: March 8, 2019~ March 23, 2019			

1 Test Laboratory

1.1 Notes of the Test Report

This report shall not be reproduced in full or partial, without the written approval of **TA technology (shanghai) co., Ltd.** The results documented in this report apply only to the tested sample, under the conditions and modes of operation as described herein .Measurement Uncertainties were not taken into account and are published for informational purposes only. This report is written to support regulatory compliance of the applicable standards stated above.

1.2 Test facility

CNAS (accreditation number: L2264)

TA Technology (Shanghai) Co., Ltd. has obtained the accreditation of China National Accreditation Service for Conformity Assessment (CNAS).

FCC (Designation number: CN1179, Test Firm Registration Number: 446626)

TA Technology (Shanghai) Co., Ltd. has been listed on the US Federal Communications Commission list of test facilities recognized to perform electromagnetic emissions measurements.

IC (recognition number is 8510A)

TA Technology (Shanghai) Co., Ltd. has been listed by industry Canada to perform electromagnetic emission measurement.

VCCI (recognition number is C-4595, T-2154, R-4113, G-10766)

TA Technology (Shanghai) Co., Ltd. has been listed by industry Japan to perform electromagnetic emission measurement.

A2LA (Certificate Number: 3857.01)

TA Technology (Shanghai) Co., Ltd. has been listed by American Association for Laboratory Accreditation to perform electromagnetic emission measurement.

1.3 Testing Location

Company: TA Technology (Shanghai) Co., Ltd.
Address: No.145, Jintang Rd, Tangzhen Industry Park, Pudong Shanghai, China
City: Shanghai
Post code: 201201
Country: P. R. China
Contact: Xu Kai
Telephone: +86-021-50791141/2/3
Fax: +86-021-50791141/2/3-8000
Website: <http://www.ta-shanghai.com>
E-mail: xukai@ta-shanghai.com









2 General Description of Equipment under Test

Client Information

Applicant	Huawei Technologies Co., Ltd.
Applicant address	Administration Building, Headquarters of Huawei Technologies Co., Ltd., Bantian, Longgang District, Shenzhen, 518129, P.R.China.
Manufacturer	Huawei Technologies Co., Ltd.
Manufacturer address	Administration Building, Headquarters of Huawei Technologies Co., Ltd., Bantian, Longgang District, Shenzhen, 518129, P.R.China.

General information

EUT Description			
Model	STK-LX1		
IMEI	IMEI 1:860815040043101 IMEI 2:860815040048027		
Hardware Version	HL1STKM		
Software Version	STK-LX1 9.0.1.18		
Power Supply	Battery/AC adapter		
Antenna Type	Internal Antenna		
Antenna Connector	A permanently attached antenna (meet with the standard FCC Part 15.203 requirement)		
Antenna Gain	-2.5 dBi		
Test Mode(s)	Basic Rate	Enhanced Data Rate(EDR)	
Modulation Type	Frequency Hopping Spread Spectrum (FHSS)		
	GFSK	$\pi/4$ DQPSK	8DPSK
Packet Type (Maximum Payload)	DH5	2DH5	3DH5
Operating Frequency Range(s)	2402-2480 MHz		
EUT Accessory			
Adapter 1	Manufacturer: Huawei Technologies Co., Ltd. Model: HW-050200U01 Input Voltage: 100-240V ~50/60Hz 0.5A Output Voltage: 5V === 2A		
Adapter 2	Manufacturer: Huawei Technologies Co., Ltd. Model: HW-050200E01 Input Voltage: 100-240V ~50/60Hz 0.5A Output Voltage: 5V === 2A		

Adapter 3	<p>Manufacturer: Huawei Technologies Co., Ltd. Model: HW-050200B01 Input Voltage: 100-240V ~50/60Hz 0.5A Output Voltage: 5V  2A</p>
Adapter 4	<p>Manufacturer: Huawei Technologies Co., Ltd. Model: HW-050200A01 Input Voltage: 100-240V ~50/60Hz 0.5A Output Voltage: 5V  2A</p>
Adapter 5	<p>Manufacturer: Huawei Technologies Co., Ltd. Model: HW-050200U02 Input Voltage: 100-240V ~50/60Hz 0.5A Output Voltage: 5V  2A</p>
Adapter 6	<p>Manufacturer: Huawei Technologies Co., Ltd. Model: HW-050200E02 Input Voltage: 100-240V ~50/60Hz 0.5A Output Voltage: 5V  2A</p>
Adapter 7	<p>Manufacturer: Huawei Technologies Co., Ltd. Model: HW-050200A02 Input Voltage: 100-240V ~50/60Hz 0.5A Output Voltage: 5V  2A</p>
Adapter 8	<p>Manufacturer: Huawei Technologies Co., Ltd. Model: HW-050200B02 Input Voltage: 100-240V ~50/60Hz 0.5A Output Voltage: 5V  2A</p>
Battery	<p>Manufacturer: Huawei Technologies Co., Ltd. Model: HB446486ECW Rated capacity: 3900mAh Nominal Voltage:  +3.82V Charging Voltage:  +4.40V</p>
Earphone 1	<p>Manufacturer: Boluo County Quancheng Electronic Co.,Ltd Model: 1293-3283-3.5MM-322</p>
Earphone 2	<p>Manufacturer: Jiangxi Lianchuang Hongsheng Electronic Co.,LTD Model: MEND1532B528A02</p>
USB cable 1	<p>Manufacturer: NingBo Broad Telecommunication Co.,Ltd. Model: WA0020</p>



USB cable 2	Manufacturer: LUXSHARE Precision Industry Co., Ltd. Model: L99UC131-CS-H
USB cable 3	Manufacturer: HONGFUJIN PRECISION INDUSTRIAL (SHENZHEN).LTD Model: CUDU01B-HC295-EH
USB cable 4	Manufacturer: Freeport Resources Enterprises (Jiangxi) Co.,Ltd Model: 18-93C2CHO-001HF
USB cable 5	Manufacturer: Dongguan Mingji Electronics Technology Group Co.,Ltd Model: 203-1572-0
<p>Note: 1. The information of the EUT is declared by the manufacturer.</p> <p>2. There is more than one Adapter /USB cable /Earphone, each one should be applied throughout the compliance test respectively, and however, only the worst case (Adapter 1/USB cable 2/ Earphone 2) will be recorded in this report.</p>	

3 Applied Standards

According to the specifications of the manufacturer, it must comply with the requirements of the following standards:

Test standards

- **FCC CFR47 Part 15C (2018) Radio Frequency Devices**
- **ANSI C63.10 (2013)**
- **KDB 558074 D01 15.247 Meas Guidance v05r01**

4 Information about the FHSS characteristics

4.1 Frequency Hopping System Requirement

Standard requirement:

(g) Frequency hopping spread spectrum systems are not required to employ all available hopping channels during each transmission. However, the system, consisting of both the transmitter and the receiver, must be designed to comply with all of the regulations in this section should the transmitter be presented with a continuous data (or information) stream. In addition, a system employing short transmission bursts must comply with the definition of a frequency hopping system and must distribute its transmissions over the minimum number of hopping channels specified in this section.

(h) The incorporation of intelligence within a frequency hopping spread spectrum system that permits the system to recognize other users within the spectrum band so that it individually and independently chooses and adapts its hopsets to avoid hopping on occupied channels is permitted. The coordination of frequency hopping systems in any other manner for the express purpose of avoiding the simultaneous occupancy of individual hopping frequencies by multiple transmitters is not permitted.

Compliance for section 15.247(g):

According to Bluetooth Core Specification, the Bluetooth system transmits the packets with the pseudorandom hopping frequency with a continuous data and short burst transmission from the Bluetooth system is also transmitted under the frequency hopping system with the pseudorandom hopping frequency system.

Compliance for section 15.247(h):

According to Bluetooth Core Specification, the Bluetooth system incorporates with an adaptive system to detect other user within the spectrum band so that it individually and independently to avoid hopping on the occupied channels.

According to Bluetooth Core Specification, the Bluetooth system is designed not have the ability to coordinate with other FHSS System in an effort to avoid the simultaneous occupancy of individual hopping frequencies by multiple transmitter.

4.2 Pseudorandom Frequency Hopping Sequence

Frequency Hopping Systems. A spread spectrum system in which the carrier is modulated with the coded information in a conventional manner causing a conventional spreading of the RF energy about the frequency carrier. The frequency of the carrier is not fixed but changes at fixed intervals under the direction of a coded sequence. The wide RF bandwidth needed by such a system is not required by spreading of the RF energy about the carrier but rather to accommodate the range of frequencies to which the carrier frequency can hop. The test of a frequency hopping system is that the near term distribution of hops appears random, the long term distribution appears evenly distributed over the hop set, and sequential hops are randomly distributed in both direction and magnitude of change in the hop set.

Adaptive Frequency Hopping (AFH) was introduced in the Bluetooth specification to provide an effective way for a Bluetooth radio to counteract normal interference. AFH identifies "bad" channels, where either other wireless devices are interfering with the Bluetooth signal or the Bluetooth signal is interfering with another device. The AFH-enabled Bluetooth device will then communicate with other devices within its pioneer to share details of any identified bad channels. The devices will then switch to alternative available "good" channels, away from the areas of interference, thus having no impact on the bandwidth used.

The selection scheme chooses a segment of 32 hop frequencies spanning about 64 MHz and visits these hops in a pseudo-random order. Next, a different 32-hop segment is chosen, etc. In the page, master page response, slave page response, page scan, inquiry, inquiry response and inquiry scan hopping sequences, the same 32-hop segment is used all the time (the segment is selected by the address; different devices will have different paging segments).

When the basic channel hopping sequence is selected, the output constitutes a pseudo-random sequence that slides through the 79 hops. The principle is depicted in the figure below.

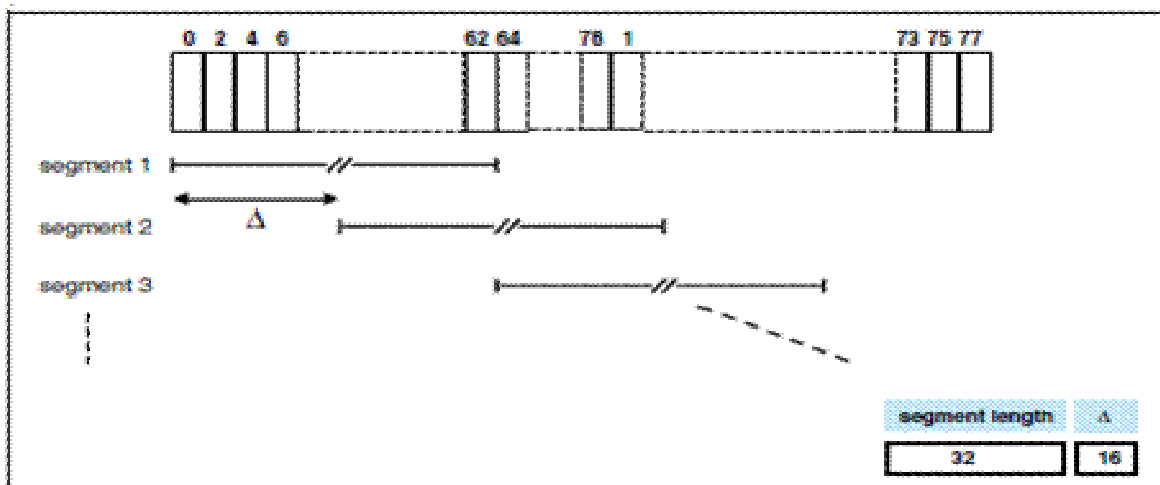

Hop selection scheme in CONNECTION state.

Pseudorandom Frequency Hopping Sequence Table as below:

Channel: 08, 24, 40, 56, 40, 56, 72, 09, 01, 09, 33, 41, 33, 41, 65, 73, 53, 69, 06, 22, 04, 20, 36, 52, 38, 46, 70, 78, 68, 76, 21, 29, 10, 26, 42, 58, 44, 60, 76, 13, 03, 11, 35, 43, 37, 45, 69, 77, 55, 71, 08, 24, 08, 24, 40, 56, 40, 48, 72, 01, 72, 01, 25, 33, 12, 28, 44, 60, 42, 58, 74, 11, 05, 13, 37, 45, etc.

Each frequency used equally on the average by each transmitter.



The system receiver have input bandwidths that match the hopping channel bandwidths of their corresponding transmitters and shift frequencies in synchronization with the transmitted signals.

4.3 Equal Hopping Frequency Use

All Bluetooth units participating in the Pico net are time and hop-synchronized to the channel. Each new transmission event begins on the next channel in the hopping sequence after the final channel used in the previous transmission event.

4.4 System Receiver Input Bandwidth

Each channel bandwidth is 1MHz. The system receivers have input bandwidths that match the hopping channel bandwidths of their corresponding transmitters and shift frequencies in synchronization with the transmitted signals.



4.5 Test Configuration

The EUT has been associated with peripherals and configuration operated in a manner tended to maximize its emission characteristics in a typical application.

The radiated emission was measured in the following position: EUT stand-up position (Z axis), lie-down position (X, Y axis). The worst emission was found in lie-down position (X axis) and the worst case was recorded.

Test Cases	Test Modes
Unwanted Emission	DH5/3DH5
Conducted Emission	DH5/3DH5

5 Test Case Results

5.1 Unwanted Emission

Ambient condition

Temperature	Relative humidity	Pressure
23°C ~25°C	45%~50%	101.5kPa

Method of Measurement

The test set-up was made in accordance to the general provisions of ANSI C63.10-2013. The Equipment Under Test (EUT) was set up on a non-conductive table in the semi-anechoic chamber. The test was performed at the distance of 3 m between the EUT and the receiving antenna. The radiated emissions measurements were made in a typical installation configuration.

Sweep the whole frequency band through the range from 9 kHz to the 10th harmonic of the carrier, and the emissions less than 20 dB below the permissible value are reported.

During the test, below 30MHz, the center of the loop shall be 1 meters; above 30MHz, the height of receive antenna shall be moved from 1 to 4 meters, and the antenna shall be performed under horizontal and vertical polarization. The turntable shall be rotated from 0 to 360 degrees for detecting the maximum of radiated spurious signal level. The measurements shall be repeated with orthogonal polarization of the test antenna. The data of cable loss and antenna factor has been calibrated in full testing frequency range before the testing.

Set the spectrum analyzer in the following:

Below 1GHz (detector: Peak and Quasi-Peak)

RBW=100kHz / VBW=300kHz / Sweep=AUTO

Above 1GHz(detector: Peak):

(a) PEAK: RBW=1MHz VBW=3MHz/ Sweep=AUTO

(b) AVERAGE: RBW=1MHz / VBW=10Hz / Sweep=AUTO

The dwell time per channel of the hopping signal is less than 100 ms, then the reading obtained with the 10 Hz VBW may be further adjusted by a “duty cycle correction factor”, derived from $20\log(\text{dwell time}/100 \text{ ms})$, in an effort to demonstrate compliance with the 15.209 limit.

If the emission is pulsed, modify the unit for continuous operation; use the settings shown above, then correct the reading by subtracting the peak- average correction factor, derived form the appropriate duty cycle calculation.

This setting method can refer to **KDB 558074 D01**.

The radiated emission was measured in the following position: EUT stand-up position (Z axis), lie-down position (X, Y axis). The worst emission was found in lie-down position (X axis) and the worst case was recorded. Then this mode was measured in the following mode: EUT with cradle and EUT without cradle. The worst emission was found in EUT with cradle mode and the worst case was recorded.

The test is in transmitting mode.

Test setup

9KHz ~ 30MHz

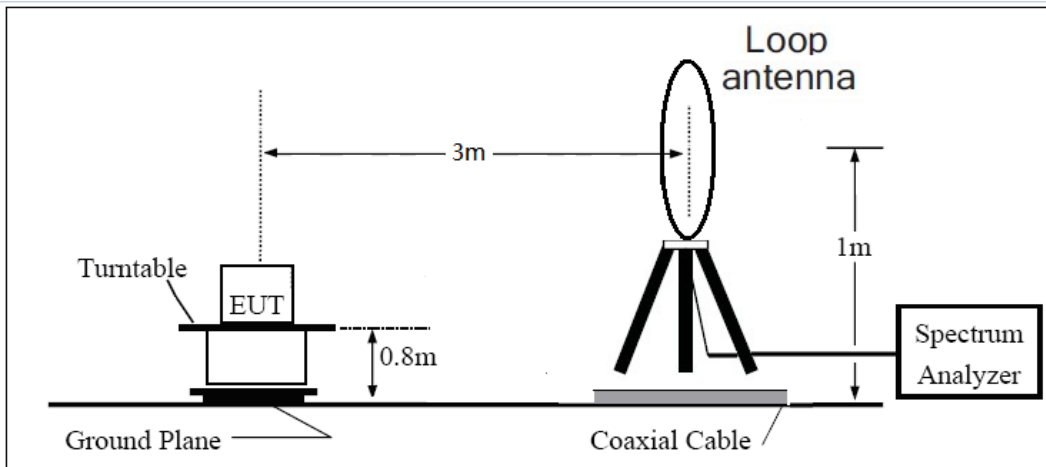

30MHz ~ 1GHz

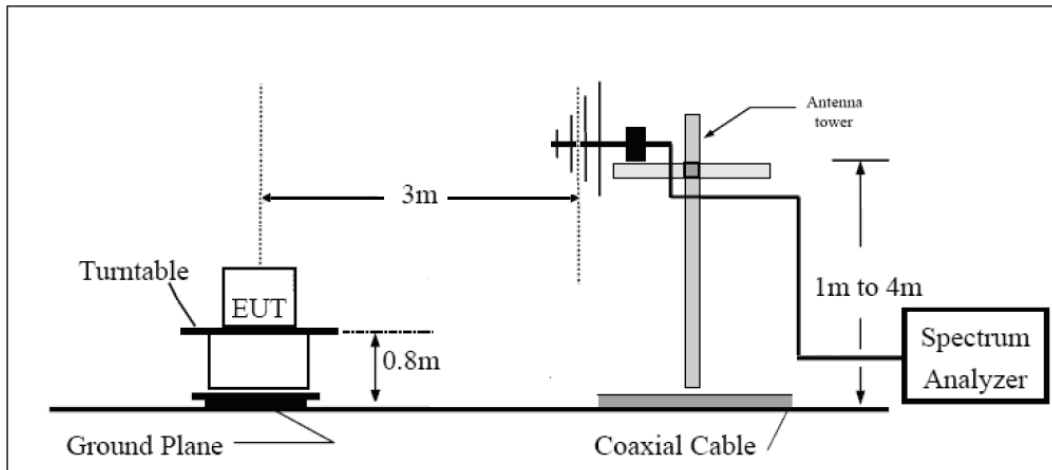

Above 1GHz

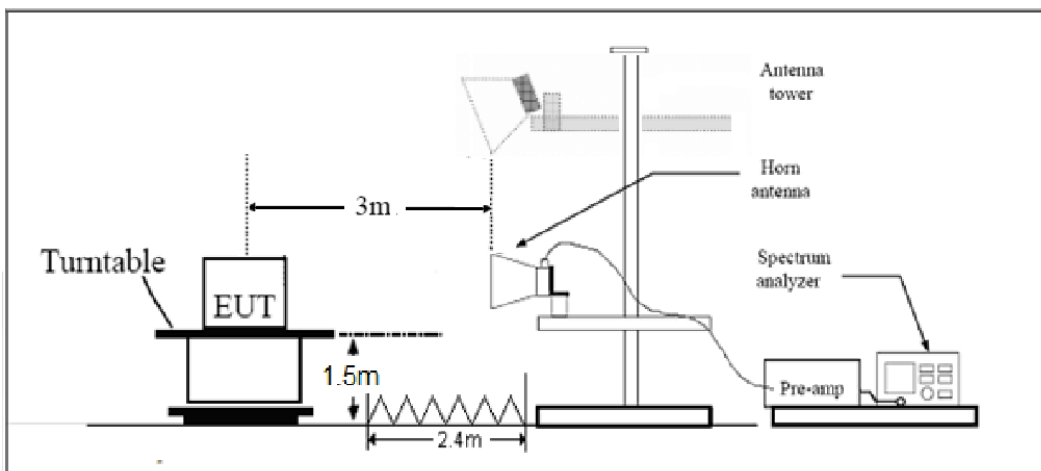

Limits

Rule Part 15.247(d) specifies that “In addition, radiated emissions which fall in the restricted bands, as defined in § 15.205(a), must also comply with the radiated emission limits specified in § 15.209(a) (see § 15.205(c)).”

Limit in restricted band

Frequency of emission (MHz)	Field strength(uV/m)	Field strength(dBuV/m)
0.009–0.490	2400/F(kHz)	/
0.490–1.705	24000/F(kHz)	/
1.705–30.0	30	/
30-88	100	40
88-216	150	43.5
216-960	200	46
Above960	500	54

§15.35(b)

There is also a limit on the radio frequency emissions, as measured using instrumentation with a peak detector function, corresponding to 20 dB above the maximum permitted average limit.

Peak Limit=74dBuV/m

Average Limit=54dBuV/m

Spurious Radiated Emissions are permitted in any of the frequency bands listed below:

MHz	MHz	MHz	GHz
0.090 - 0.110	16.42 - 16.423	399.9 - 410	4.5 - 5.15
¹ 0.495 - 0.505	16.69475 - 16.69525	608 - 614	5.35 - 5.46
2.1735 - 2.1905	16.80425 - 16.80475	960 - 1240	7.25 - 7.75
4.125 - 4.128	25.5 - 25.67	1300 - 1427	8.025 - 8.5
4.17725 - 4.17775	37.5 - 38.25	1435 - 1626.5	9.0 - 9.2
4.20725 - 4.20775	73 - 74.6	1645.5 - 1646.5	9.3 - 9.5
6.215 - 6.218	74.8 - 75.2	1660 - 1710	10.6 - 12.7
6.26775 - 6.26825	108 - 121.94	1718.8 - 1722.2	13.25 - 13.4
6.31175 - 6.31225	123 - 138	2200 - 2300	14.47 - 14.5
8.291 - 8.294	149.9 - 150.05	2310 - 2390	15.35 - 16.2
8.362 - 8.366	156.52475 - 156.52525	2483.5 - 2500	17.7 - 21.4
8.37625 - 8.38675	156.7 - 156.9	2690 - 2900	22.01 - 23.12
8.41425 - 8.41475	162.0125 - 167.17	3260 - 3267	23.6 - 24.0
12.29 - 12.293	167.72 - 173.2	3332 - 3339	31.2 - 31.8
12.51975 - 12.52025	240 - 285	3345.8 - 3358	36.43 - 36.5
12.57675 - 12.57725	322 - 335.4	3600 - 4400	(²)
13.36 - 13.41			

**Measurement Uncertainty**

The assessed measurement uncertainty to ensure 95% confidence level for the normal distribution is with the coverage factor $k = 1.96$.

Frequency	Uncertainty
9KHz-30MHz	3.55 dB
30MHz-200MHz	4.02 dB
200MHz-1GHz	3.28 dB
1-18GHz	3.70 dB
18-26.5GHz	5.78 dB



Test Results:

The signal beyond the limit is carrier.

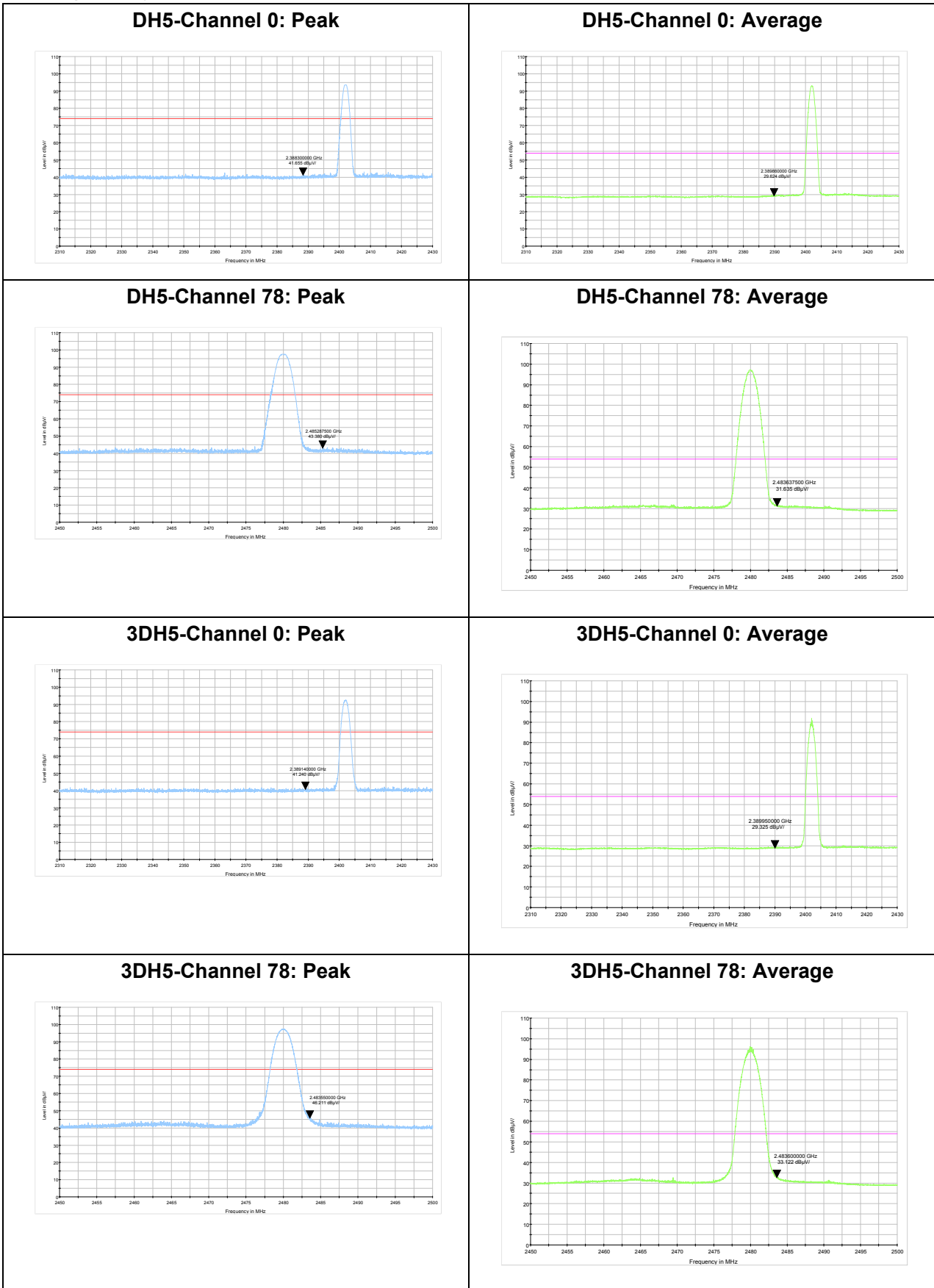

Result of RE

Test result

Sweep the whole frequency band through the range from 9kHz to the 10th harmonic of the carrier,

The following graphs display the maximum values of horizontal and vertical by software.
For above 1GHz, Blue trace uses the peak detection, Green trace uses the average detection.

During the test, the Radiates Emission from 30MHz to 1GHz was performed in all modes with all channels, BT **GFSK Channel 78** are selected as the worst condition. The test data of the worst-case condition was recorded in this report.

Continuous TX mode:

FCC RE 9K-90KHz AV

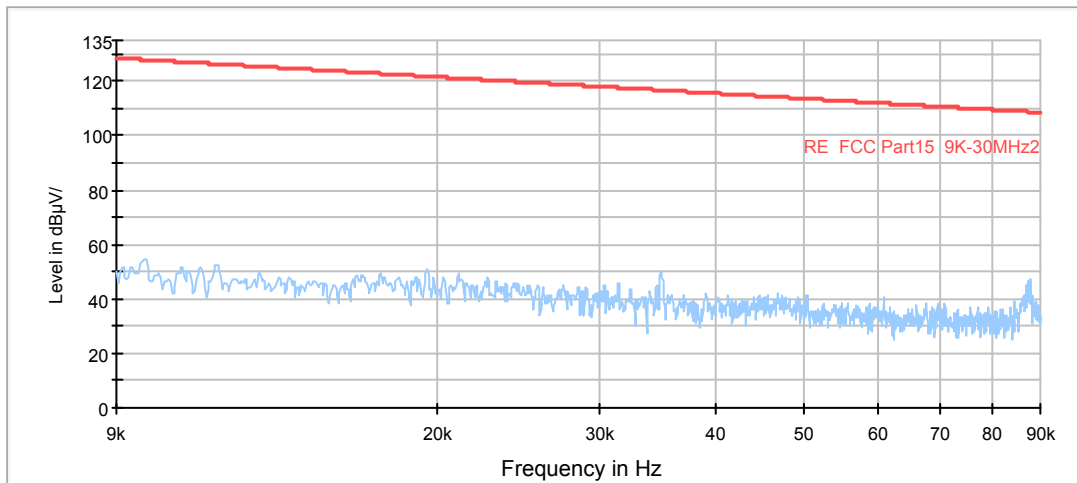

Radiates Emission from 9KHz to 90KHz

FCC RE 90K-110KHz QP

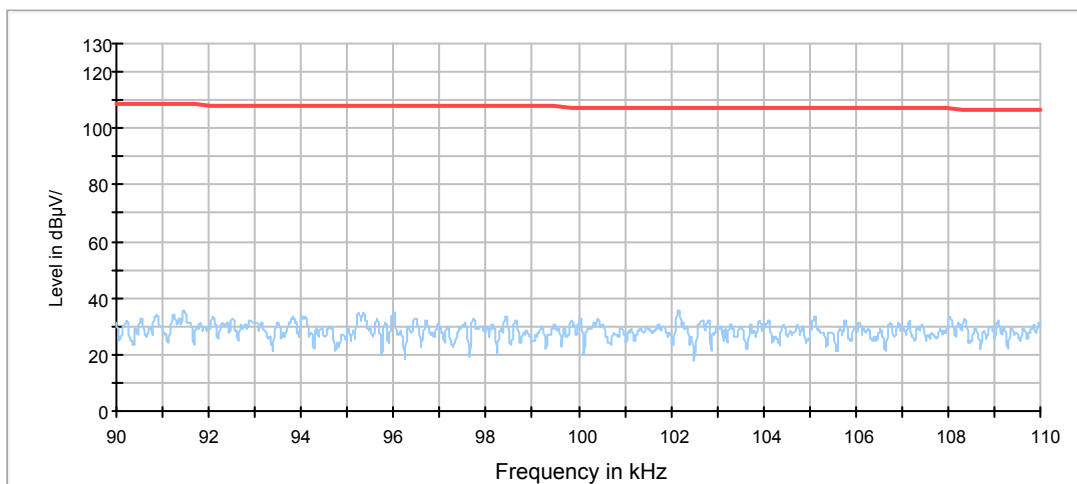

Radiates Emission from 90KHz to 110KHz

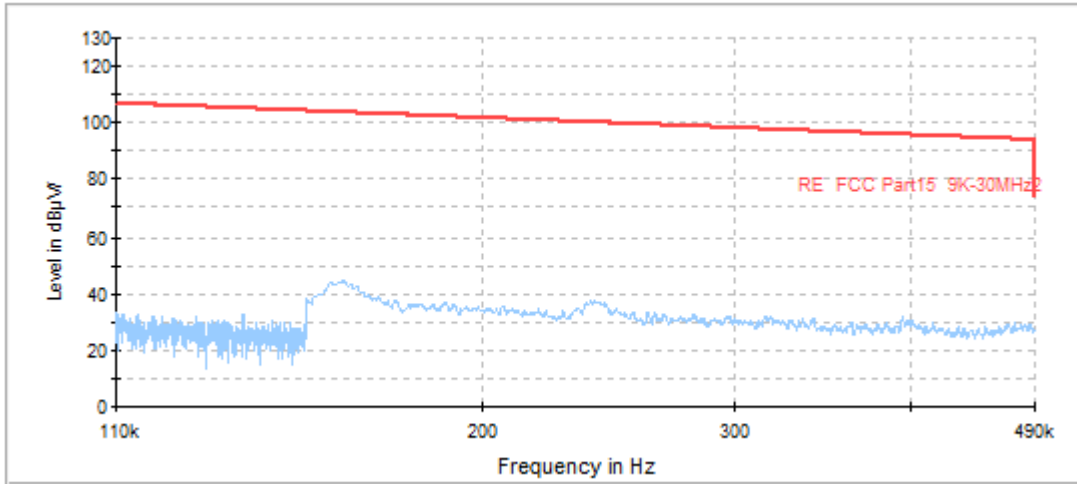

Radiates Emission from 110KHz to 490KHz

FCC RE 490K-30MHz QP

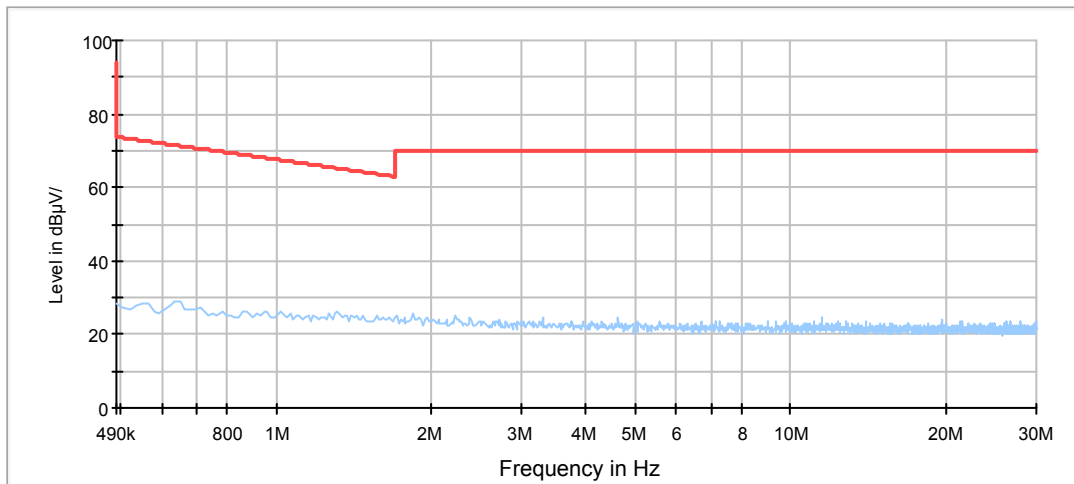

Radiates Emission from 490KHz to 30MHz

RE 0.03-1GHz QP Class B

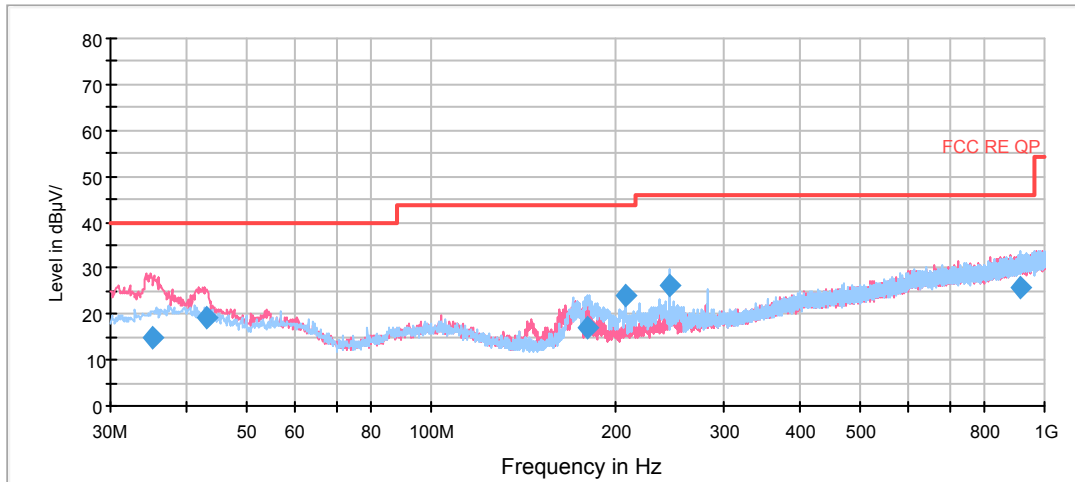

Radiates Emission from 30MHz to 1GHz

Frequency (MHz)	Quasi-Peak (dBuV/m)	Height (cm)	Polarization	Azimuth (deg)	Correct Factor (dB)	Margin (dB)	Limit (dBuV/m)
35.131250	15.0	100.0	V	357.0	16.6	25.0	40.0
42.971250	19.1	100.0	V	144.0	16.2	20.9	40.0
179.182500	17.0	100.0	H	60.0	11.0	26.5	43.5
207.192500	24.0	100.0	H	113.0	12.0	19.5	43.5
245.416250	26.4	100.0	H	242.0	13.5	19.6	46.0
915.405000	25.9	200.0	H	0.0	26.8	20.1	46.0

Remark: 1. Correction Factor = Antenna factor+ Insertion loss(cable loss+amplifier gain)

2. Margin = Limit – Quasi-Peak

DH5-Channel 0

FCC RE 1G-3GHz PK+AV Class B

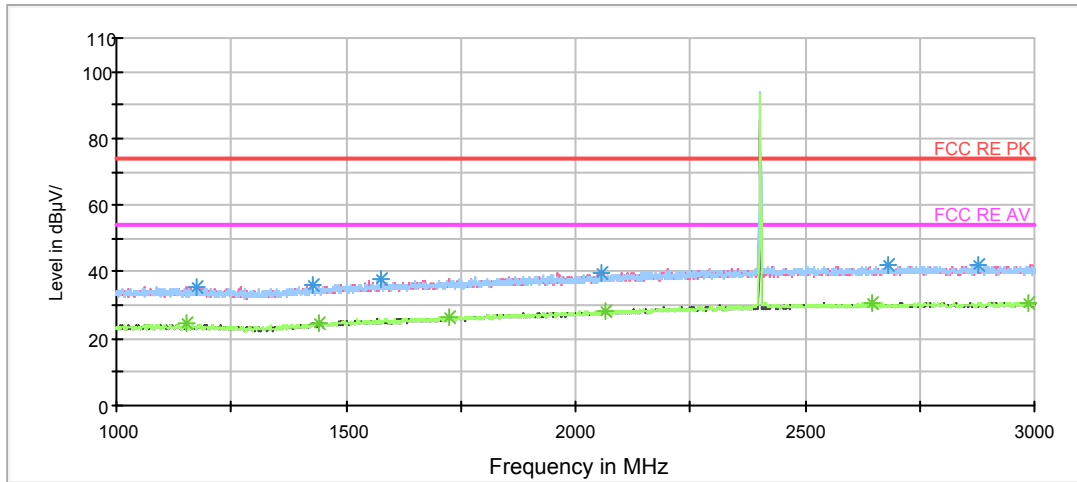

Note: The signal beyond the limit is carrier.
Radiates Emission from 1GHz to 3GHz

FCC RE 1G-18GHz PK+AV Class B

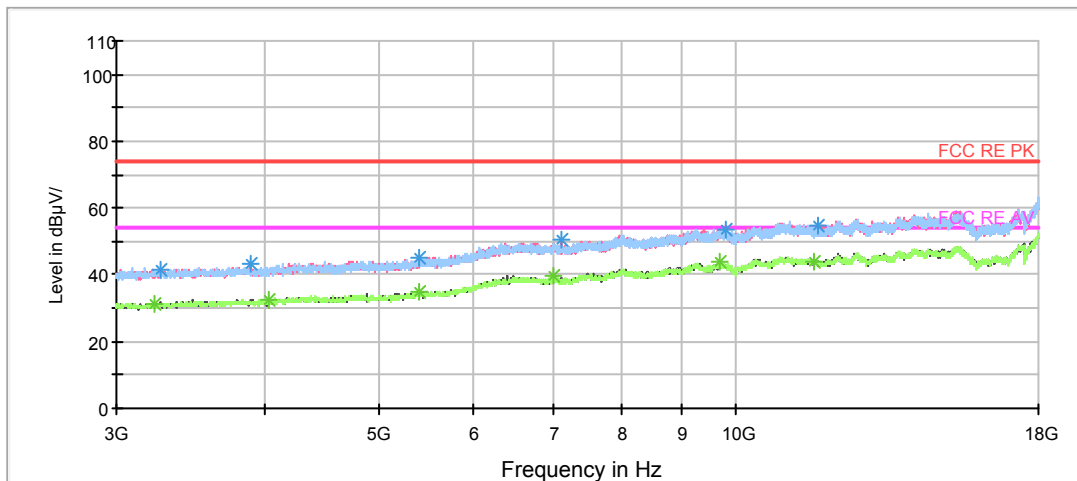

Radiates Emission from 3GHz to 18GHz

Frequency (MHz)	Peak (dBuV/m)	Height (cm)	Polarization	Azimuth (deg)	Correct Factor (dB)	Margin (dB)	Limit (dBuV/m)
1175.000000	35.4	200.0	V	154.0	-11.0	38.6	74
1427.500000	35.8	200.0	V	53.0	-9.9	38.2	74
1576.000000	37.7	100.0	V	275.0	-9.1	36.3	74
2055.000000	39.9	200.0	H	335.0	-6.5	34.1	74
2682.000000	42.2	100.0	H	34.0	-4.0	31.8	74
2878.500000	42.1	100.0	V	262.0	-3.6	31.9	74

Remark: 1. Correction Factor = Antenna factor+ Insertion loss (cable loss + amplifier gain)

Frequency (MHz)	Average (dBuV/m)	Height (cm)	Polarization	Azimuth (deg)	Correct Factor (dB)	Margin (dB)	Limit (dBuV/m)
1151.000000	24.4	100.0	H	23.0	-11.1	29.6	54
1439.500000	24.5	100.0	V	356.0	-9.8	29.5	54
1725.500000	26.4	100.0	V	300.0	-8.2	27.6	54
2066.000000	28.4	100.0	V	0.0	-6.4	25.6	54
2646.000000	30.5	100.0	V	262.0	-4.0	23.5	54
2988.000000	30.9	200.0	H	153.0	-3.6	23.1	54

Remark: 1. Correction Factor = Antenna factor+ Insertion loss (cable loss + amplifier gain)

DH5-Channel 39

FCC RE 1G-3GHz PK+AV Class B

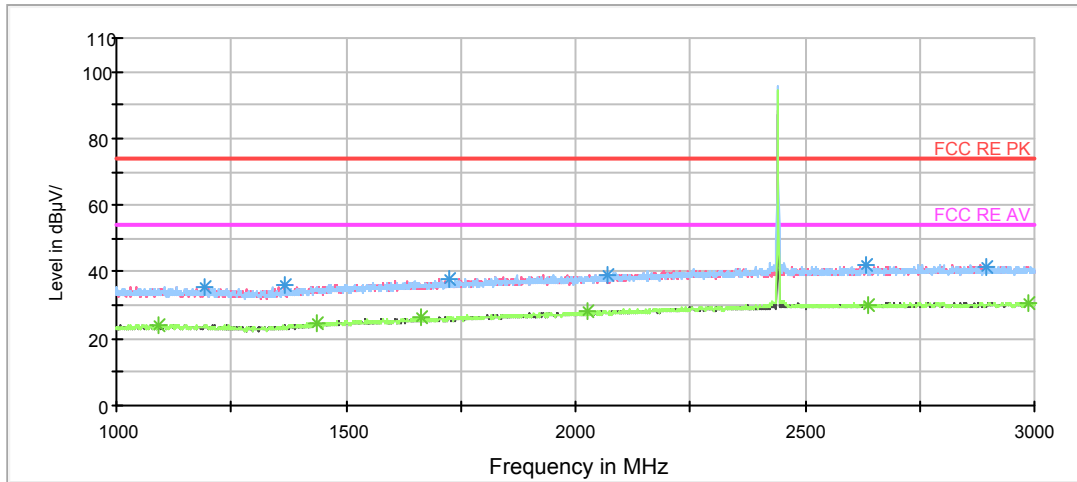

Note: The signal beyond the limit is carrier.
Radiates Emission from 1GHz to 3GHz

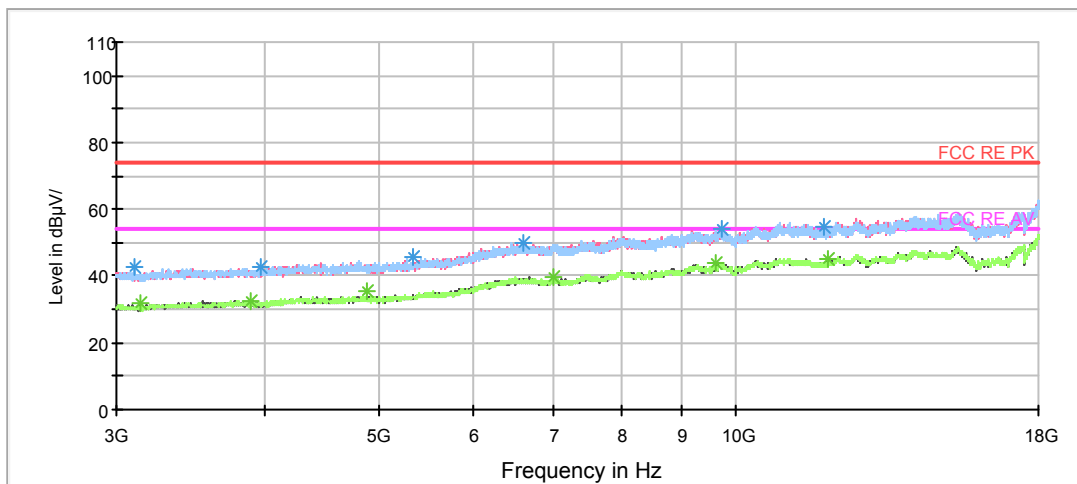

Radiates Emission from 3GHz to 18GHz

Frequency (MHz)	Peak (dBuV/m)	Height (cm)	Polarization	Azimuth (deg)	Correct Factor (dB)	Margin (dB)	Limit (dBuV/m)
1193.000000	35.6	100.0	V	127.0	-10.9	38.4	74
1365.000000	35.9	100.0	V	240.0	-10.2	38.1	74
1727.000000	37.7	200.0	V	142.0	-8.2	36.3	74
2068.500000	39.2	100.0	V	289.0	-6.4	34.8	74
2632.500000	42.1	100.0	V	240.0	-4.0	31.9	74
2894.500000	41.6	100.0	H	119.0	-3.6	32.4	74

Remark: 1. Correction Factor = Antenna factor+ Insertion loss (cable loss + amplifier gain)

Frequency (MHz)	Average (dBuV/m)	Height (cm)	Polarization	Azimuth (deg)	Correct Factor (dB)	Margin (dB)	Limit (dBuV/m)
1091.500000	24.3	100.0	V	0.0	-11.2	29.7	54
1438.500000	24.7	100.0	H	69.0	-9.8	29.3	54
1665.000000	26.4	100.0	H	170.0	-8.5	27.6	54
2024.500000	28.3	100.0	V	302.0	-6.7	25.7	54
2638.500000	30.2	200.0	V	167.0	-4.0	23.8	54
2986.500000	30.9	200.0	H	338.0	-3.6	23.1	54

Remark: 1. Correction Factor = Antenna factor+ Insertion loss (cable loss + amplifier gain)

DH5-Channel 78

FCC RE 1G-3GHz PK+AV Class B

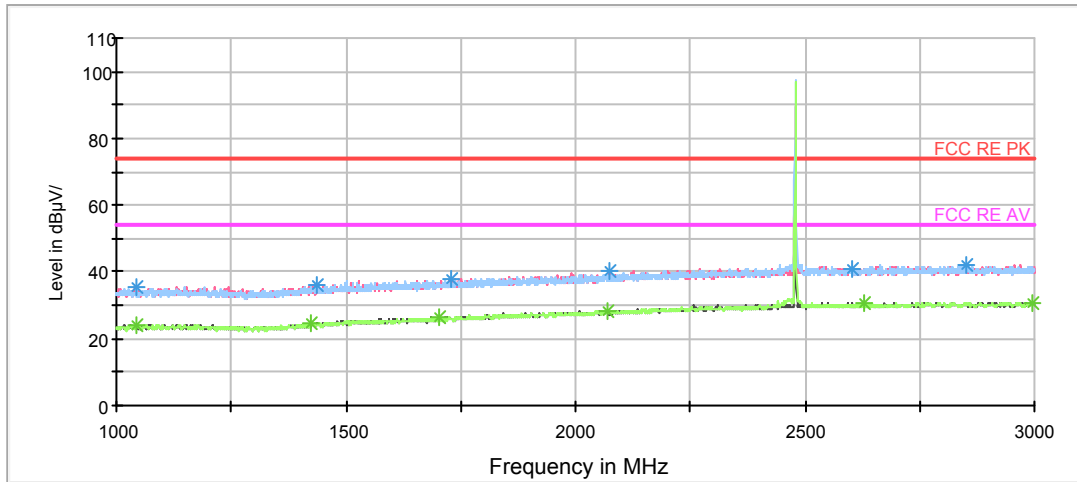

Note: The signal beyond the limit is carrier.
Radiates Emission from 1GHz to 3GHz

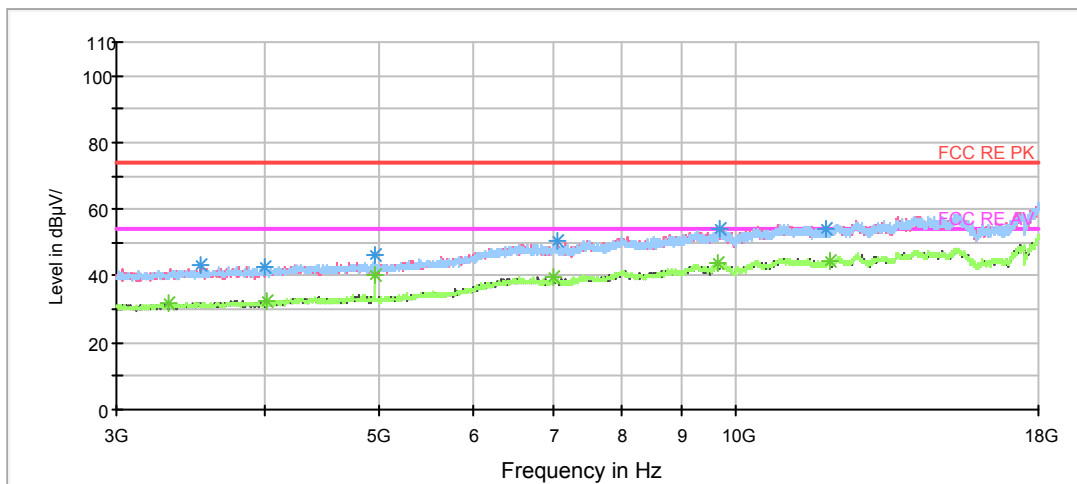

Radiates Emission from 3GHz to 18GHz

Frequency (MHz)	Peak (dBuV/m)	Height (cm)	Polarization	Azimuth (deg)	Correct Factor (dB)	Margin (dB)	Limit (dBuV/m)
1044.500000	35.4	200.0	H	341.0	-11.5	38.6	74
1435.500000	36.3	200.0	V	241.0	-9.8	37.7	74
1731.000000	37.8	100.0	V	290.0	-8.1	36.2	74
2075.500000	40.1	100.0	V	359.0	-6.4	33.9	74
2603.000000	40.9	200.0	H	321.0	-4.1	33.1	74
2850.500000	42.3	200.0	H	258.0	-3.7	31.7	74

Remark: 1. Correction Factor = Antenna factor+ Insertion loss (cable loss + amplifier gain)

Frequency (MHz)	Average (dBuV/m)	Height (cm)	Polarization	Azimuth (deg)	Correct Factor (dB)	Margin (dB)	Limit (dBuV/m)
1044.000000	24.3	100.0	V	265.0	-11.5	29.7	54
1424.000000	24.5	200.0	V	152.0	-9.9	29.5	54
1703.500000	26.4	200.0	H	321.0	-8.3	27.6	54
2068.000000	28.4	100.0	H	9.0	-6.4	25.6	54
2629.000000	30.5	200.0	V	3.0	-4.1	23.5	54
2996.500000	30.8	200.0	H	308.0	-3.5	23.2	54

Remark: 1. Correction Factor = Antenna factor+ Insertion loss (cable loss + amplifier gain)

3DH5-Channel 0

FCC RE 1G-3GHz PK+AV Class B

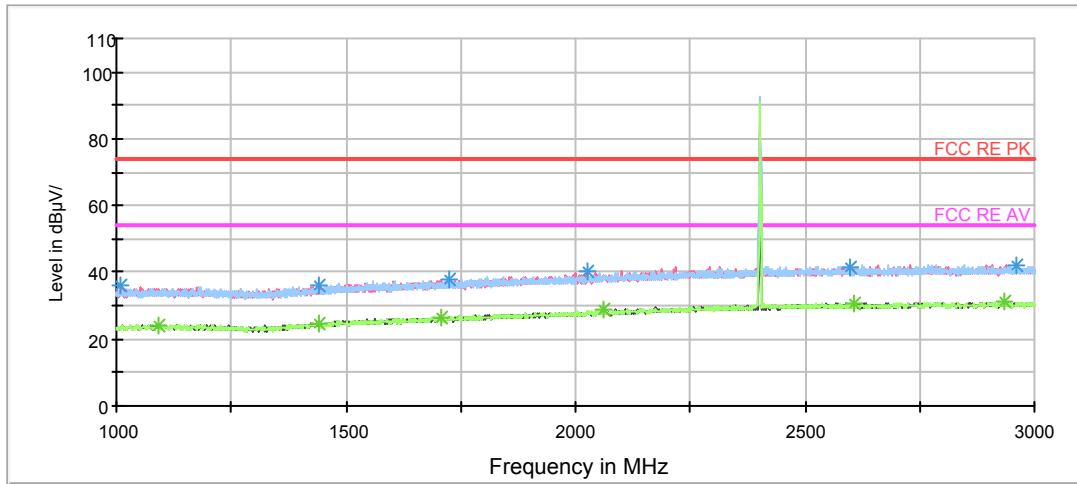

Note: The signal beyond the limit is carrier.
Radiates Emission from 1GHz to 3GHz

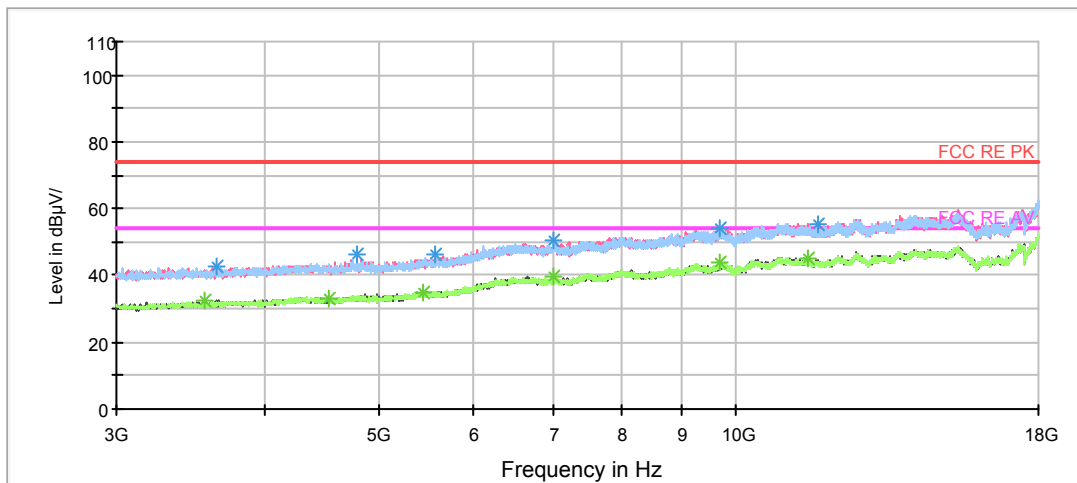

Radiates Emission from 3GHz to 18GHz

Frequency (MHz)	Peak (dBuV/m)	Height (cm)	Polarization	Azimuth (deg)	Correct Factor (dB)	Margin (dB)	Limit (dBuV/m)
1010.500000	35.9	100.0	V	246.0	-11.8	38.1	74
1440.500000	35.9	100.0	H	29.0	-9.8	38.1	74
1726.000000	37.8	100.0	H	3.0	-8.2	36.2	74
2027.000000	40.0	100.0	V	196.0	-6.7	34.0	74
2597.500000	41.3	100.0	V	348.0	-4.1	32.7	74
2960.500000	42.3	200.0	H	208.0	-3.6	31.7	74

Remark: 1. Correction Factor = Antenna factor+ Insertion loss (cable loss + amplifier gain)

Frequency (MHz)	Average (dBuV/m)	Height (cm)	Polarization	Azimuth (deg)	Correct Factor (dB)	Margin (dB)	Limit (dBuV/m)
1090.500000	24.1	200.0	H	258.0	-11.2	29.9	54
1440.000000	24.8	200.0	H	183.0	-9.8	29.2	54
1707.500000	26.4	200.0	H	0.0	-8.3	27.6	54
2061.500000	28.7	100.0	V	356.0	-6.4	25.3	54
2609.000000	30.5	100.0	V	358.0	-4.1	23.5	54
2935.500000	31.0	100.0	H	13.0	-3.6	23.0	54

Remark: 1. Correction Factor = Antenna factor+ Insertion loss (cable loss + amplifier gain)

FCC RE 1G-3GHz PK+AV Class B

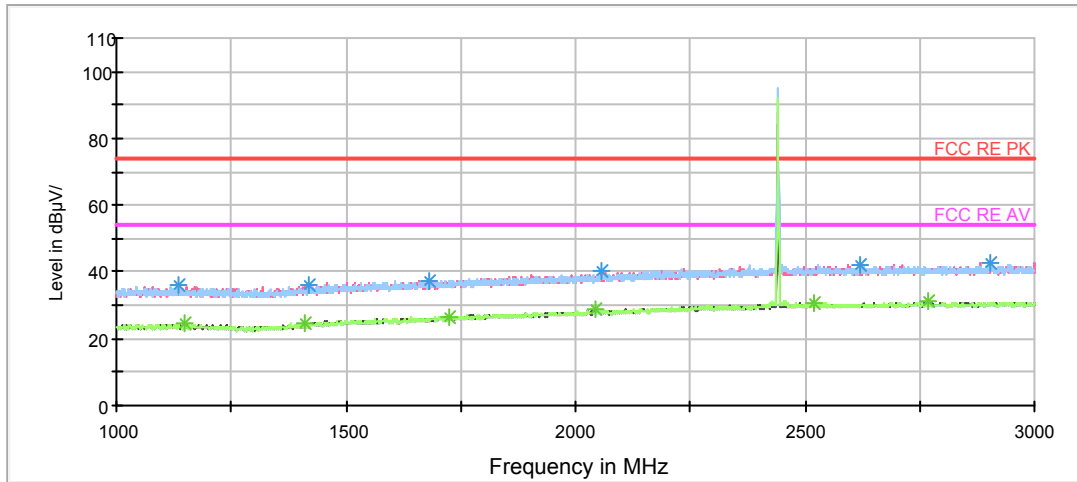

Note: The signal beyond the limit is carrier.
Radiates Emission from 1GHz to 3GHz

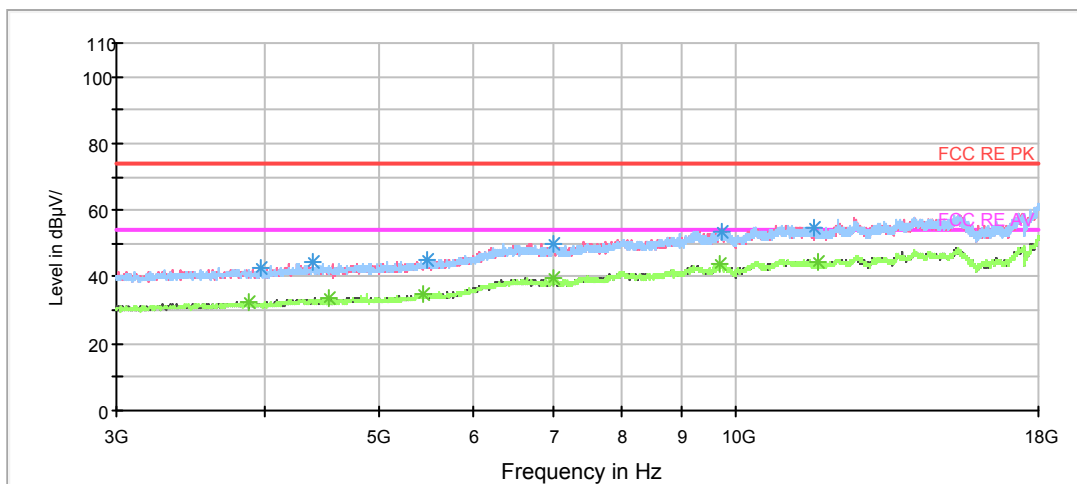

Radiates Emission from 3GHz to 18GHz

Frequency (MHz)	Peak (dBuV/m)	Height (cm)	Polarization	Azimuth (deg)	Correct Factor (dB)	Margin (dB)	Limit (dBuV/m)
1135.000000	35.8	200.0	H	236.0	-11.1	38.2	74
1417.500000	36.1	200.0	H	285.0	-9.9	37.9	74
1682.500000	37.5	100.0	H	14.0	-8.4	36.5	74
2057.500000	40.0	100.0	V	352.0	-6.5	34.0	74
2621.000000	41.9	200.0	V	268.0	-4.1	32.1	74
2902.500000	42.6	100.0	V	0.0	-3.6	31.4	74

Remark: 1. Correction Factor = Antenna factor+ Insertion loss (cable loss + amplifier gain)

Frequency (MHz)	Average (dBuV/m)	Height (cm)	Polarization	Azimuth (deg)	Correct Factor (dB)	Margin (dB)	Limit (dBuV/m)
1147.500000	24.4	200.0	V	12.0	-11.1	29.6	54
1411.000000	24.8	100.0	H	14.0	-10.0	29.2	54
1726.000000	26.7	200.0	H	285.0	-8.2	27.3	54
2045.500000	28.6	100.0	V	355.0	-6.6	25.4	54
2520.000000	30.5	100.0	V	330.0	-4.3	23.5	54
2770.000000	31.3	200.0	H	161.0	-3.8	22.7	54

Remark: 1. Correction Factor = Antenna factor+ Insertion loss (cable loss + amplifier gain)

FCC RE 1G-3GHz PK+AV Class B

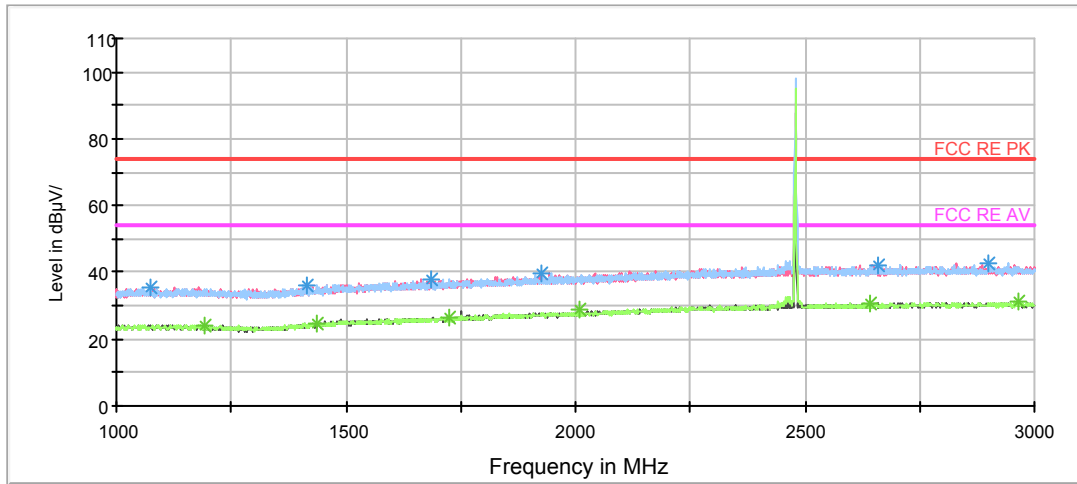

Note: The signal beyond the limit is carrier.
Radiates Emission from 1GHz to 3GHz

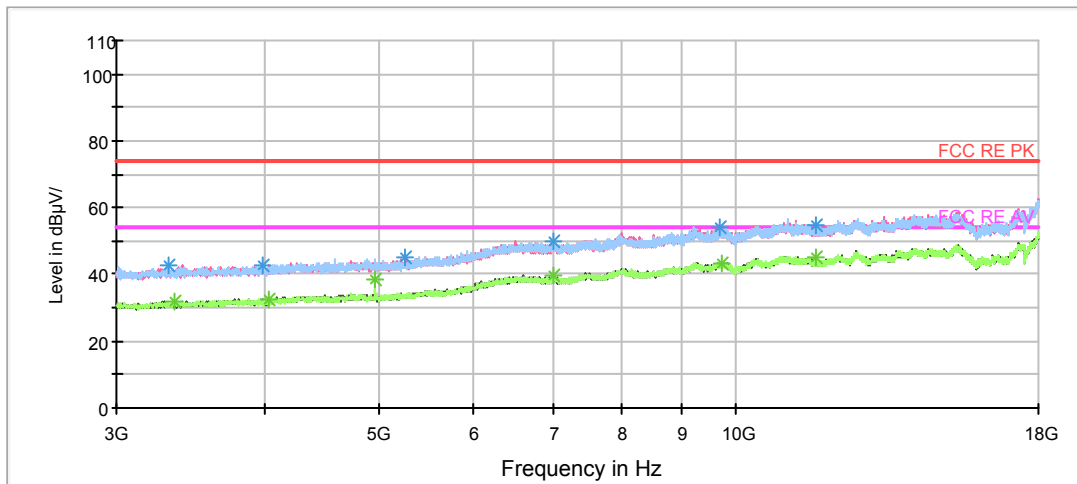

Radiates Emission from 3GHz to 18GHz

Frequency (MHz)	Peak (dBuV/m)	Height (cm)	Polarization	Azimuth (deg)	Correct Factor (dB)	Margin (dB)	Limit (dBuV/m)
1074.000000	35.5	100.0	H	165.0	-11.3	38.5	74
1414.000000	36.2	100.0	V	0.0	-10.0	37.8	74
1684.000000	37.9	100.0	H	335.0	-8.4	36.1	74
1925.000000	39.8	200.0	V	0.0	-7.2	34.2	74
2661.500000	42.2	200.0	V	0.0	-4.0	31.8	74
2898.000000	42.7	100.0	H	6.0	-3.6	31.3	74

Remark: 1. Correction Factor = Antenna factor+ Insertion loss (cable loss + amplifier gain)

Frequency (MHz)	Average (dBuV/m)	Height (cm)	Polarization	Azimuth (deg)	Correct Factor (dB)	Margin (dB)	Limit (dBuV/m)
1193.000000	24.3	200.0	H	292.0	-10.9	29.7	54
1438.500000	24.7	100.0	V	127.0	-9.8	29.3	54
1727.000000	26.6	100.0	H	47.0	-8.2	27.4	54
2007.500000	28.6	200.0	H	143.0	-6.8	25.4	54
2643.500000	30.6	100.0	V	354.0	-4.0	23.4	54
2965.500000	31.0	100.0	V	299.0	-3.6	23.0	54

Remark: 1. Correction Factor = Antenna factor+ Insertion loss (cable loss + amplifier gain)



During the test, the Radiates Emission from 18GHz to 26.5GHz was performed in all modes with all channels, DH5-Channel 78 are selected as the worst condition. The test data of the worst-case condition was recorded in this report.

RE 18-26.5GHz PK+AV

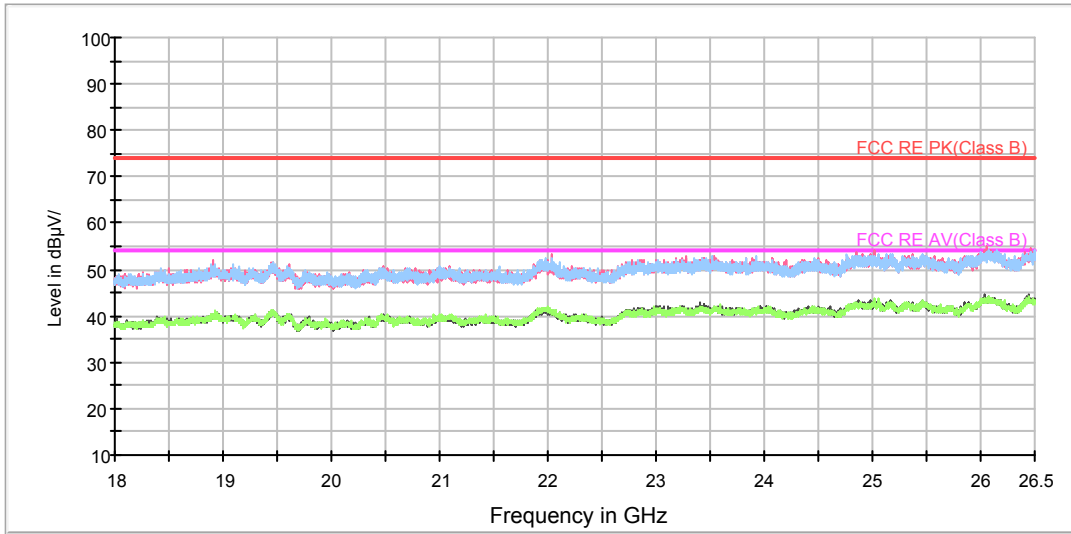

Radiates Emission from 18GHz to 26.5GHz

5.2 Conducted Emission

Ambient condition

Temperature	Relative humidity	Pressure
23°C ~25°C	45%~50%	101.5kPa

Methods of Measurement

The EUT is placed on a non-metallic table of 80cm height above the horizontal metal reference ground plane. During the test, the EUT was operating in its typical mode. The test method is according to ANSI C63.10-2013. Connect the AC power line of the EUT to the L.I.S.N. Use EMI receiver to detect the average and Quasi-peak value. RBW is set to 9 kHz, VBW is set to 30kHz. The measurement result should include both L line and N line.

The test is in transmitting mode.

Test Setup

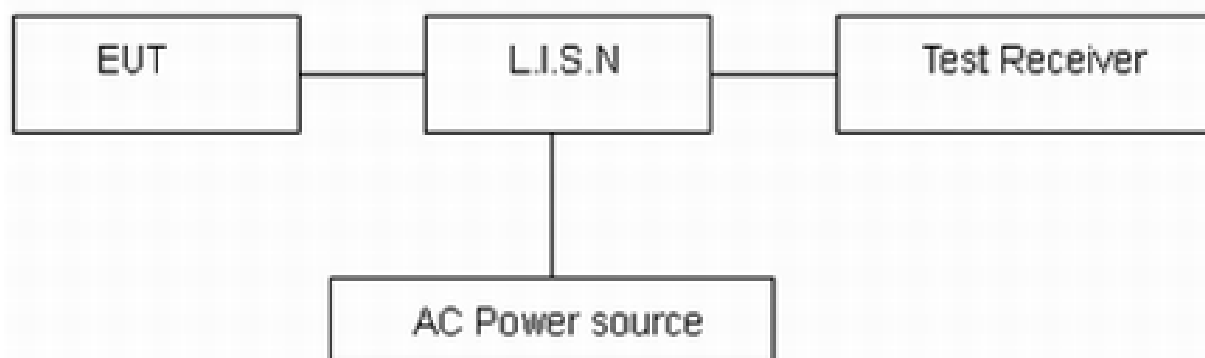

Note: AC Power source is used to 120V/60Hz.

Limits

Frequency (MHz)	Conducted Limits(dBμV)	
	Quasi-peak	Average
0.15 - 0.5	66 to 56 *	56 to 46 *
0.5 - 5	56	46
5 - 30	60	50

*: Decreases with the logarithm of the frequency.

Measurement Uncertainty

The assessed measurement uncertainty to ensure 95% confidence level for the normal distribution is with the coverage factor $k = 1.96$, $U=2.69$ dB.

Test Results:

Following plots, Blue trace uses the peak detection, Green trace uses the average detection. During the test, the Conducted Emission was performed in all modes with all channels, BT **DH5 channel78**, are selected as the worst condition. The test data of the worst-case condition was recorded in this report.

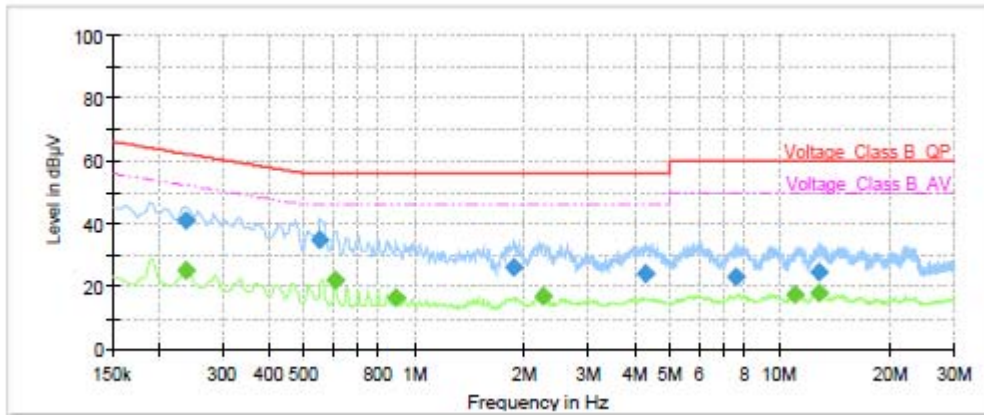

Frequency (MHz)	QuasiPeak (dBµV)	Average (dBµV)	Limit (dBµV)	Margin (dB)	Meas. Time (ms)	Bandwidth (kHz)	Line	Filter	Corr. (dB)
0.24	---	24.90	52.17	27.27	1000.0	9.000	L1	ON	19.12
0.24	40.83	---	62.17	21.34	1000.0	9.000	L1	ON	19.12
0.55	34.98	---	56.00	21.02	1000.0	9.000	L1	ON	19.25
0.61	---	21.95	46.00	24.05	1000.0	9.000	L1	ON	19.27
0.89	---	16.20	46.00	29.80	1000.0	9.000	L1	ON	19.24
1.88	26.00	---	56.00	30.00	1000.0	9.000	L1	ON	19.17
2.25	---	16.92	46.00	29.08	1000.0	9.000	L1	ON	19.06
4.28	24.15	---	56.00	31.85	1000.0	9.000	L1	ON	19.10
7.58	22.83	---	60.00	37.17	1000.0	9.000	L1	ON	19.21
11.01	---	17.26	50.00	32.74	1000.0	9.000	L1	ON	19.36
12.73	24.87	---	60.00	35.13	1000.0	9.000	L1	ON	19.48
12.75	---	17.94	50.00	32.06	1000.0	9.000	L1	ON	19.48

L line

Conducted Emission from 150 KHz to 30 MHz

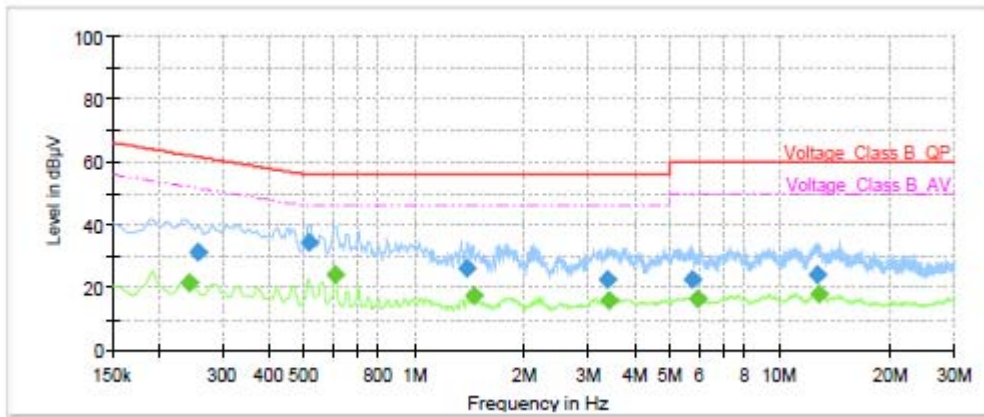

Frequency (MHz)	QuasiPeak (dBµV)	Average (dBµV)	Limit (dBµV)	Margin (dB)	Meas. Time (ms)	Bandwidth (kHz)	Line	Filter	Corr. (dB)
0.24	---	21.72	52.02	30.30	1000.0	9.000	N	ON	19.11
0.26	31.51	---	61.57	30.06	1000.0	9.000	N	ON	19.13
0.52	34.59	---	56.00	21.41	1000.0	9.000	N	ON	19.24
0.61	---	24.20	46.00	21.80	1000.0	9.000	N	ON	19.27
1.39	26.19	---	56.00	29.81	1000.0	9.000	N	ON	19.18
1.45	---	17.42	46.00	28.58	1000.0	9.000	N	ON	19.18
3.37	22.46	---	56.00	33.54	1000.0	9.000	N	ON	19.06
3.41	---	16.12	46.00	29.88	1000.0	9.000	N	ON	19.05
5.75	22.44	---	60.00	37.56	1000.0	9.000	N	ON	19.11
5.97	---	16.16	50.00	33.84	1000.0	9.000	N	ON	19.10
12.67	24.08	---	60.00	35.92	1000.0	9.000	N	ON	19.45
12.77	---	18.01	50.00	31.99	1000.0	9.000	N	ON	19.46

N line

Conducted Emission from 150 KHz to 30 MHz

6 Main Test Instruments

Name	Manufacturer	Type	Serial Number	Calibration Date	Expiration Date
BT Base Station Simulator	R&S	CBT	100271	2018-05-20	2019-05-19
Signal Analyzer	R&S	FSV30	100815	2018-12-16	2019-12-15
EMI Test Receiver	R&S	ESCI	100948	2018-05-20	2019-05-19
Loop Antenna	Schwarzbeck	FMZB1519	1519-047	2017-09-26	2019-09-25
TRILOG Broadband Antenna	Schwarzbeck	VULB 9163	9163-201	2017-11-18	2019-11-17
Double Ridged Waveguide Horn Antenna	R&S	HF907	100126	2018-07-07	2020-07-06
Standard Gain Horn	ETS-Lindgren	3160-09	00102643	2018-06-20	2020-06-19
EMI Test Receiver	R&S	ESR	101667	2018-05-20	2019-05-19
LISN	R&S	ENV216	101171	2016-12-16	2019-12-15
Software	R&S	EMC32	9.26.0	/	/

*****END OF REPORT *****