



FCC RF Test Report

Product Name: Smart Phone

Model Number: STK-LX1

Report No.: SYBH(Z-RF)20190214006001-2001

FCC ID: QISSTK-LX1

Authorized	APPROVED (Lab Manager)	PREPARED (Test Engineer)
BY	He Hao	Zhou Bing bo
DATE	2019-03-19	2019-03-19

Reliability Laboratory of Huawei Technologies Co., Ltd.

(Global Compliance and Testing Center of Huawei Technologies Co., Ltd)

No.2, New City Avenue, Songshan Lake Sci. & Tech. Industry Park, Dongguan, 523808, P.R.C
Telephone: +86 769 23830808 Fax: +86 769 23837628

※ ※ Notice ※ ※

1. The laboratory has passed the accreditation by The American Association for Laboratory Accreditation (A2LA). The accreditation number is 2174.01
2. The laboratory has been recognized by the US Federal Communications Commission (FCC) to perform compliance testing subject to the Commission's Certification rules. The Designation Number is CN1173, and the Test Firm Registration Number is 294140.
3. The laboratory has been recognized by the Innovation, Science and Economic Development Canada (ISED) to test to Canadian radio equipment requirements. The CAB identifier is CN0003, and the ISED# is 21741.
4. The laboratory (Reliability Lab of Huawei Technologies Co., Ltd) is also named “Global Compliance and Testing Center of Huawei Technologies Co., Ltd”, the both names have coexisted since 2009.
5. The test report is invalid if not marked with the signatures of the persons responsible for preparing and approving the test report.
6. The test report is invalid if there is any evidence of erasure and/or falsification.
7. The test report is only valid for the test samples.
8. Content of the test report, in part or in full, cannot be used for publicity and/or promotional purposes without prior written approval from the laboratory.
9. If any question about this report, please contact the laboratory (PublicGCTC@huawei.com).

MODIFICATION RECORD

No.	Report No	Modification Description
1	SYBH(Z-RF)2019021 4006001-2001	First release.

DECLARATION

Type	Description
Multiple Models Applications	<input checked="" type="checkbox"/> The present report applies to single model.
	<input type="checkbox"/> The present report applies to several models. The practical measurements are performed with the model.
	Note:The present report only presents the worst test case of all modes, see relevant test results for detailed.

1 Table of contents

1	Table of contents	4
2	General Information	5
2.1	Test standard/s	5
2.2	Test Environment.....	5
2.3	Test Laboratories.....	5
2.4	Applicant and Manufacturer	5
2.5	Application details.....	5
3	Test Summary.....	6
3.1	Cellular Band (824-849 MHz paired with 869-894 MHz).....	6
3.2	PCS Band (1850-1910 MHz paired with 1930-1990 MHz).....	7
3.3	BRS&EBS Band (2500-2570 MHz paired with 2620-2690 MHz).....	8
4	Description of the Equipment under Test (EUT)	10
4.1	General Description	10
4.2	EUT Identity	10
4.3	Technical Specification.....	12
5	General Test Conditions / Configurations.....	13
5.1	Test Modes	13
5.2	Test Frequency	14
5.3	DESCRIPTION OF TESTS	16
5.4	Test Setups.....	19
5.5	Test Conditions	21
6	Main Test Instruments.....	23
6.1	Current Test Project/Report	23
7	Measurement Uncertainty	25
8	Appendixes	26

2 General Information

2.1 Test standard/s

Applied Rules :	47 CFR FCC Part 02 47 CFR FCC Part 22 47 CFR FCC Part 24 47 CFR FCC Part 27
Test Method :	FCC KDB 971168 D01 Power Meas License Digital Systems v03r01 ANSI C63.26

2.2 Test Environment

Temperature :	TN	15 to 30	°C during room temperature tests
Ambient Relative Humidity:	40 to 55 %		
Atmospheric Pressure:	Not applicable		
Power supply :	VL	3.6	V
	VN	3.82	V DC by Battery
	VH	4.4	V

NOTE: 1) VN= nominal voltage, VL= low extreme test voltage, VH= High extreme test voltage;

TN= normal temperature, TL= low extreme test temperature, TH= High extreme test temperature.

2.3 Test Laboratories

Test Location 1:	RELIABILITY LABORATORY OF HUAWEI TECHNOLOGIES CO., LTD.
Address of Test Location 1:	No.2, New City Avenue, Songshan Lake Sci. & Tech. Industry Park, Dongguan, 523808, P.R.C

2.4 Applicant and Manufacturer

Company Name :	HUAWEI TECHNOLOGIES CO., LTD
Address :	Administration Building, Headquarters of Huawei Technologies Co., Ltd., Bantian, Longgang District, Shenzhen, 518129, P.R.C

2.5 Application details

Date of Receipt Sample:	2019-02-27
Start of test:	2019-02-28
End of test:	2019-03-19

3 Test Summary

3.1 Cellular Band (824-849 MHz paired with 869-894 MHz)

Test Item	FCC Rule No.	Requirements	Test Result	Verdict (Note1)	Testing location
Effective (Isotropic) Radiated Power Output Data	§2.1046, §22.913	FCC: ERP \leq 7 W.	Appendix A	Pass	Test Location 1
Peak-Average Ratio	---	Limit \leq 13 dB	Appendix B	Pass	Test Location 1
Modulation Characteristics	§2.1047	Digital modulation	Appendix C	Pass	Test Location 1
Bandwidth	§2.1049	OBW: No limit. EBW: No limit.	Appendix D	Pass	Test Location 1
Band Edges Compliance	§2.1051, §22.917	FCC: \leq -13 dBm/1%*EBW, in 1 MHz bands immediately outside and adjacent to the frequency block. Note 1): EBW is -26 dBc EBW.	Appendix E	Pass	Test Location 1
Spurious Emission at Antenna Terminals	§2.1051, §22.917	FCC: \leq -13 dBm/RefBW, from max(lowest internal frequency, 9 kHz) to min(10 * highest fundamental frequency, 40 GHz), after 1 MHz bands immediately outside and adjacent to the frequency block. (RefBW: \geq 100 kHz for frequency below 1 GHz, and =1 MHz above 1 GHz)	Appendix F	Pass	Test Location 1
Frequency Stability	§2.1055, §22.355	\leq \pm 2.5ppm	Appendix G	Pass	Test Location 1
NOTE: For the verdict, the "N/A" denotes "not applicable", the "N/T" denotes "not tested".					

3.2 PCS Band (1850-1910 MHz paired with 1930-1990 MHz)

Test Item	FCC Rule No.	Requirements	Test Result	Verdict (Note1)	Testing location
Effective (Isotropic) Radiated Power Output Data	§2.1046, §24.232	EIRP \leq 2 W	Appendix A	Pass	Test Location 1
Peak-Average Ratio	§2.1046, §24.232	Limit \leq 13 dB	Appendix B	Pass	Test Location 1
Modulation Characteristics	§2.1047	Digital modulation	Appendix C	Pass	Test Location 1
Bandwidth	§2.1049	OBW: No limit. EBW: No limit.	Appendix D	Pass	Test Location 1
Band Edges Compliance	§2.1051, §24.238	FCC: \leq -13 dBm/1%*EBW, in 1 MHz bands immediately outside and adjacent to the frequency block. Note 1): EBW is -26 dBc EBW.	Appendix E	Pass	Test Location 1
Spurious Emission at Antenna Terminals	§2.1051, §24.238	FCC: \leq -13 dBm/1 MHz, from max(lowest internal frequency, 9 kHz) to min(10 * highest fundamental frequency, 40 GHz) but outside authorized operating frequency blocks. operating frequency blocks.	Appendix F	Pass	Test Location 1
Frequency Stability	§2.1055, §24.235	FCC: Within authorized bands of operation/frequency block.	Appendix G	Pass	Test Location 1
NOTE: For the verdict, the "N/A" denotes "not applicable", the "N/T" denotes "not tested".					

3.3 BRS&EBS Band (2500-2570 MHz paired with 2620-2690 MHz)

Test Item	FCC Rule No.	Requirements	Test Result	Verdict (Note1)	Testing location
Effective (Isotropic) Radiated Power Output Data	§2.1046, §27.50(h)	EIRP ≤ 2W	Appendix A	Pass	Test Location 1
Peak-Average Ratio	§27.50(a)	Limit ≤ 13 dB	Appendix B	Pass	Test Location 1
Modulation Characteristics	§2.1047	Digital modulation	Appendix C	Pass	Test Location 1
Bandwidth	§2.1049	OBW: No limit. EBW: No limit.	Appendix D	Pass	Test Location 1
Band Edges Compliance	§2.1051, §27.53(m4)	<p>FCC:</p> <p>AND</p> <p>AND, if 2495-2496 MHz is immediately outside and adjacent to the frequency block</p> <p>Note 1): EBW is -26 dBc EBW.</p>	Appendix E	Pass	Test Location 1

Test Item	FCC Rule No.	Requirements	Test Result	Verdict (Note1)	Testing location
Spurious Emission at Antenna Terminals	§2.1051, §27.53(m)	<p>FCC:</p> <p>AND</p> <p>Fa = max(lowest internal frequency, 9 kHz) Fb = min(10 * highest fundamental frequency, 40 GHz)</p> <p>Note 1): EBW is -26 dBc EBW. Note 2): MeasFrom: max(lowest internal frequency, 9 kHz). Note 3): MeasTo: min(10 * highest fundamental frequency, 40 GHz).</p>	Appendix F	Pass	Test Location 1
Frequency Stability	§2.1055, §27.54	Within authorized bands of operation/frequency block.	Appendix G	Pass	Test Location 1
NOTE: For the verdict, the "N/A" denotes "not applicable", the "N/T" denotes "not tested".					

4 Description of the Equipment under Test (EUT)

4.1 General Description

STK-LX1 is subscriber equipment in the GSM/WCDMA/LTE system. The GSM frequency band includes GSM850 and GSM900 and DCS1800 and PCS1900. The UMTS frequency band is B1 and B2 and B5 and B8. The LTE frequency band is B1 and B3 and B7 and B8 and B2. The Mobile Phone implements such functions as RF signal receiving/transmitting, LTE/HSPA/UMTS and GSM/GPRS/EDGE protocol processing, voice, video MMS service, GPS, AGPS and WIFI etc. Externally it provides one micro SD card interface, earphone port and different versions of the software, the phone may support single SIM card or double SIM card. It also provides Bluetooth module to synchronize data between a PC and the phone, or to use the built-in modem of the phone to access the Internet with a PC, or to exchange data with other Bluetooth devices.

NOTE1: Only GSM850/1900, UMTS Band II/V, LTE Band 7 test data included in this report.











4.2 EUT Identity

NOTE: Unless otherwise noted in the report, the functional boards installed in the units shall be selected from the below list, but not means all the functional boards listed below shall be installed in one unit.

4.2.1 Board

Board		
Description	Software Version	Hardware Version
Main Board	STK-LX1 9.0.1.18	HL1STKM

4.2.2 Sub-Assembly

Sub-Assembly			
Sub-Assembly Name	Model	Manufacturer	Description
Adapter	HW-050200U01	Huawei Technologies Co.,Ltd.	Input Voltage:100V-240V~50/60Hz, 0.5A Output Voltage: 5V  2A
Adapter	HW-050200E01	Huawei Technologies Co.,Ltd.	Input Voltage:100V-240V~50/60Hz, 0.5A Output Voltage: 5V  2A
Adapter	HW-050200B01	Huawei Technologies Co.,Ltd.	Input Voltage:100V-240V~50/60Hz, 0.5A Output Voltage: 5V  2A
Adapter	HW-050200A01	Huawei Technologies Co.,Ltd.	Input Voltage:100V-240V~50/60Hz, 0.5A Output Voltage: 5V  2A
Adapter	HW-050200U02	Huawei Technologies Co.,Ltd.	Input Voltage:100V-240V~50/60Hz, 0.5A Output Voltage: 5V  2A
Adapter	HW-050200E02	Huawei Technologies Co.,Ltd.	Input Voltage:100V-240V~50/60Hz, 0.5A Output Voltage: 5V  2A
Adapter	HW-050200A02	Huawei Technologies Co.,Ltd.	Input Voltage:100V-240V~50/60Hz, 0.5A Output Voltage: 5V  2A
Adapter	HW-050200B02	Huawei Technologies Co.,Ltd.	Input Voltage:100V-240V~50/60Hz, 0.5A Output Voltage: 5V  2A
Li-ion Polymer Battery	HB446486ECW	Huawei Technologies Co.,Ltd.	Rated capacity: 3900mAh Nominal Voltage:  +3.82V Charging Voltage: :  +4.4V

4.3 Technical Specification

NOTE: For the detailed technical descriptions, see the applicant/manufacturer's specifications or user manual.

4.3.1 General

Characteristics	Description	
Radio System Type	<input checked="" type="checkbox"/> GSM <input checked="" type="checkbox"/> UMTS <input checked="" type="checkbox"/> LTE	
Supported Frequency Range	GSM850/ WCDMA850	Transmission (TX): 824 to 849 MHz
		Receiving (RX): 869 to 894 MHz
	GSM1900/ WCDMA1900	Transmission (TX): 1850 to 1910 MHz
		Receiving (RX): 1930 to 1990 MHz
LTE BAND7	Transmission (TX): 2500 to 2570 MHz	
	Receiving (RX): 2620 to 2690 MHz	
Antenna	Description	Isotropic Antenna
	Type	<input checked="" type="checkbox"/> Integral <input type="checkbox"/> External <input type="checkbox"/> Dedicated
	TX and RX Antenna Ports(one band)	TX & RX port: 1 TX-only port: 0 RX-only port: 1
	Smart Antenna(for uplink)	<input type="checkbox"/> MIMO <input checked="" type="checkbox"/> Non MIMO
	Gain	GSM850: -4.6 dBi (per antenna port, max) PCS1900: -1.0 dBi (per antenna port, max) WCDMA 850: -4.6 dBi (per antenna port, max) WCDMA 1900: -1.0 dBi (per antenna port, max) LTE Band 7: -0.1 dBi (per antenna port, max)
	Remark	When the EUT is put into service, the practical maximum antenna gain should NOT exceed the value as described above.
Target TX Output Power	GSM850: 32.7dBm GSM1900 30 dBm UMTS850 24dBm UMTS1900: 23.5dBm LTE BAND7: 23.2dBm	
Supported Channel Bandwidth	GSM system:	<input checked="" type="checkbox"/> 200 kHz
	UMTS system:	<input checked="" type="checkbox"/> 5 MHz
	LTE band 7	<input checked="" type="checkbox"/> 5MHz, <input checked="" type="checkbox"/> 10MHz, <input checked="" type="checkbox"/> 15MHz, <input checked="" type="checkbox"/> 20MHz
Type of Modulation for uplink	GSM	<input checked="" type="checkbox"/> GMSK

Characteristics	Description	
		<input checked="" type="checkbox"/> 8PSK
	WCDMA	<input checked="" type="checkbox"/> QPSK <input type="checkbox"/> 16QAM(only for HSPA+) <input type="checkbox"/> 64QAM
	LTE	<input checked="" type="checkbox"/> QPSK <input checked="" type="checkbox"/> 16QAM <input type="checkbox"/> 64QAM
Designation of Emissions (Note: the necessary bandwidth of which is the worst value from the measured occupied bandwidths for each type of channel bandwidth configuration.)	GSM850:	245KGXW, 257KG7W
	GSM1900:	248KGXW, 253KG7W
	UMTS850:	4M17F9W
	UMTS1900:	4M19F9W
	LTE BAND7:	4M51G7D (5 MHz QPSK modulation), 4M51W7D (5 MHz 16QAM modulation) 9M00G7D (10 MHz QPSK modulation), 9M01W7D (10 MHz 16QAM modulation) 13M5G7D (15 MHz QPSK modulation), 13M5W7D (15 MHz 16QAM modulation) 18M0G7D (20 MHz QPSK modulation), 18M0W7D (20 MHz 16QAM modulation)
Power Supply	Type	<input type="checkbox"/> External DC mains, <input checked="" type="checkbox"/> Battery, <input type="checkbox"/> AC/DC Adapter, <input type="checkbox"/> Powered over Ethernet (PoE). <input type="checkbox"/> Other

5 General Test Conditions / Configurations

5.1 Test Modes

NOTE1: The test mode(s) are selected according to relevant radio technology specifications.

NOTE2: The modulation for WCDMA, HSUPA, HSDPA, is the same, which is QPSK, and the WCDMA is the worst, so we test the WCDMA only.

Test Mode	Test Modes Description
GSM/TM1	GSM system, GSM/GPRS, GMSK modulation
GSM/TM2	GSM system, EDGE, 8PSK modulation
UMTS/TM1	WCDMA system, QPSK modulation
LTE/TM1	LTE system, QPSK modulation
LTE/TM2	LTE system, 16QAM modulation

5.2 Test Frequency

Test Mode	TX / RX	RF Channel		
		Low (L)	Middle (M)	High (H)
GSM850	TX	Channel 128	Channel 190	Channel 251
		824.2MHz	836.6MHz	848.8MHz
	RX	Channel 128	Channel 190	Channel 251
		869.2MHz	881.6MHz	893.8MHz
WCDMA850	TX	Channel 4132	Channel 4182	Channel 4233
		826.4MHz	836.4MHz	846.6MHz
	RX	Channel 4357	Channel 4407	Channel 4458
		871.4MHz	881.4MHz	891.6MHz
Test Mode	TX / RX	RF Channel		
		Low (L)	Middle (M)	High (H)
GSM1900	TX	Channel 512	Channel 661	Channel 810
		1850.2MHz	1880.0MHz	1909.8MHz
	RX	Channel 512	Channel 661	Channel 810
		1930.2 MHz	1960.0 MHz	1989.8 MHz
WCDMA1900	TX	Channel 9262	Channel9400	Channel9538
		1852.4MHz	1880.0MHz	1907.6MHz
	RX	Channel 9662	Channel 9800	Channel 9938
		1932.4 MHz	1960.0 MHz	1987.6 MHz

Test Mode	TX / RX	RF Channel		
		Low (B)	Middle (M)	High (T)

Test Mode	TX / RX	RF Channel		
		Low (B)	Middle (M)	High (T)
LTE Band 7	TX (5M)	Channel 20775	Channel 21100	Channel 21425
		2502.5 MHz	2535 MHz	2567.5 MHz
	TX (10M)	Channel 20800	Channel 21100	Channel 21400
		2505 MHz	2535 MHz	2565 MHz
	TX (15M)	Channel 20825	Channel 21100	Channel 21375
		2507.5 MHz	2535 MHz	2562.5 MHz
	TX (20M)	Channel 20850	Channel 21100	Channel 21350
		2510 MHz	2535 MHz	2560 MHz
	RX (5M)	Channel 2775	Channel 3100	Channel 3425
		2622.5 MHz	2655 MHz	2687.5 MHz
	RX (10M)	Channel 2800	Channel 3100	Channel 3400
		2625 MHz	2655 MHz	2685 MHz
	RX (15M)	Channel 2825	Channel 3100	Channel 3375
		2627.5 MHz	2655 MHz	2682.5 MHz
	RX (20M)	Channel 2850	Channel 3100	Channel 3350
		2630 MHz	2655 MHz	2680 MHz

5.3 DESCRIPTION OF TESTS

5.3.1 Peak-Average Ratio

A peak to average ratio measurement is performed at the conducted port of the EUT. The spectrum analyzers Complementary Cumulative Distribution Function (CCDF) measurement profile is used to determine the largest deviation between the average and the peak power of the EUT in a given bandwidth.

Test Procedures Used

KDB 971168 D01 v03-Section 5.7.2

Test Settings

- 1、 The signal analyzer's CCDF measurement profile enabled
- 2、 Frequency= carrier center frequency
- 3、 Measurement BW > EBW of signal
- 4、 for continuous transmissions, set to 1ms
- 5、 Record the maximum PAPR level associated with a probability of 0.1%.

Note: Reference test setup 1

5.3.2 Occupied Bandwidth

The occupied bandwidth, that is the frequency bandwidth such that, below its lower and above its upper frequency limits, the mean powers radiated are each equal to 0.5 percent of the total mean power radiated by a given emission shall be measured. The span of the analyzer shall be set to capture all products of the modulation process, including the emission skirts. The resolution bandwidth shall be set to as close to 1 percent of the selected span as is possible without being below 1 percent. The video bandwidth shall be set to 3 times the resolution bandwidth. Video averaging is not permitted. Where practical, a sampling detector shall be used since a peak or, peak hold, may produce a wider bandwidth than actual. The trace data points are recovered and are directly summed in linear terms. The recovered amplitude data points, beginning at the lowest frequency, are placed in a running sum until 0.5 percent of the total is reached and that frequency recorded. The process is repeated for the highest frequency data points. This frequency is recorded. The span between the two recorded frequencies is the occupied bandwidth.

Test Procedures Used

KDB 971168 D01 v03-Section 4.3

Test Settings

- 1、 SET RBW=1-5% of OBW
- 2、 SET VBW \geq 3*RBW
- 3、 Detector: Peak
- 4、 Trace mode= max hold.
- 5、 Sweep= auto couple
- 6、 Steps 1-5 were repeated after it is stable

Note: Reference test setup 1.

5.3.3 Band Edge Compliance

The test complies with the requirements in clause 2 of the present report according to test procedures in KDB 971168 D01 v03-Section 6 with corresponding test settings.

Note: Reference test setup 1.

5.3.4 Spurious and Harmonic Emissions at Antenna Terminal

The test complies with the requirements in clause 2 of the present report according to test procedures in KDB 971168 D01 v03-Section 6 with corresponding test settings.

Note: Reference test setup 1.

5.3.5 Frequency Stability / Temperature Variation

Frequency stability testing is performed in accordance with the guidelines of ANSI/TIA-603-E-2016. The frequency stability of the transmitter is measured by:

- a.) **Temperature:** The temperature is varied from -30°C to +50°C in 10°C increments using an environmental chamber.
- b.) **Primary Supply Voltage:** The primary supply voltage is varied from 85% to 115% of the nominal value for non hand-carried battery and AC powered equipment. For hand-carried, battery-powered equipment, primary supply voltage is reduced to the battery operating end point which shall be specified by the manufacturer.

Specification – The frequency stability shall be sufficient to ensure that the fundamental emission stays within the authorized frequency block. The frequency stability of the transmitter shall be maintained within $\pm 0.00025\%$ (± 2.5 ppm) of the center frequency.

Time Period and Procedure:

1. The carrier frequency of the transmitter is measured at room temperature (20°C to provide a reference).
2. The equipment is turned on in a “standby” condition for fifteen minutes before applying power to the transmitter. Measurement of the carrier frequency of the transmitter is made within one minute after applying power to the transmitter.
3. Frequency measurements are made at 10°C intervals ranging from -30°C to +50°C. A period of at least one half-hour is provided to allow stabilization of the equipment at each temperature level.

Test Procedures Used

ANSI/TIA-603-E-2016

Note: Reference test setup 2.

5.4 Test Setups

5.4.1 General Test Setup Configurations

Configuration	Description
Test Antenna Port	Until declared, all Transmitter tests are performed at TRX port of the EUT
Multiple RF Source	Other RF sources or functions of the EUT are disabled during testing for RF source.
Sensors and Antenna	Sensors and Antenna optimization function should be disabled during testing by software method to get the stable maximum power and avoid the influence of uncertain conditions

5.4.2 Test Setup 1

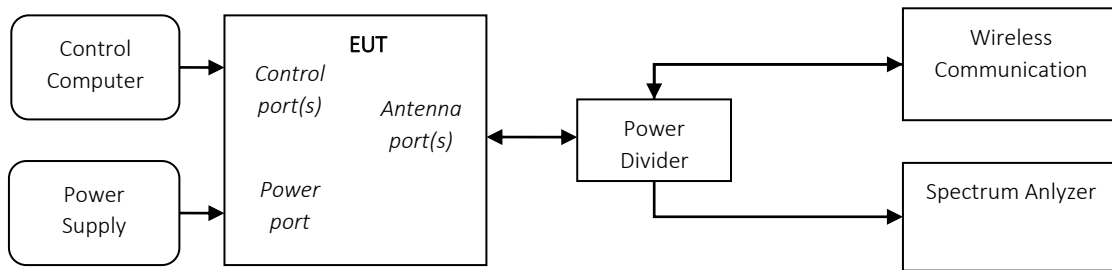

5.4.3 Test Setup 2

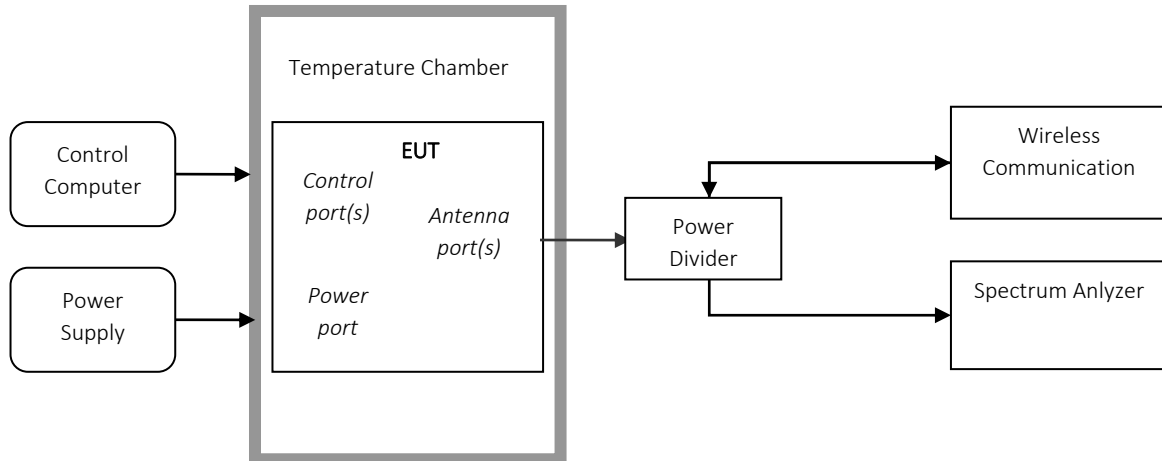

5.5 Test Conditions

Test Case		Test Conditions	
Transmit Output Power Data	Average Power, Total	Test Env.	Ambient Climate & Rated Voltage
		Test Setup	Test Setup 1
		RF Channels (TX)	L, M, H (L= low channel, M= middle channel, H= high channel)
		Test Mode	GSM/TM1,GSM/TM2,UMTS/TM1,LTE/TM1,LTE/TM2
	Average Power, Spectral Density (if required)	Test Env.	Ambient Climate & Rated Voltage
		Test Setup	Test Setup 1
		RF Channels (TX)	L, M, H (L= low channel, M= middle channel, H= high channel)
		Test Mode	GSM/TM1,GSM/TM2,UMTS/TM1,LTE/TM1,LTE/TM2
Peak-to-Average Ratio (if required)		Test Env.	Ambient Climate & Rated Voltage
		Test Setup	Test Setup 1
		RF Channels (TX)	L, M, H (L= low channel, M= middle channel, H= high channel)
		Test Mode	GSM/TM1,GSM/TM2,UMTS/TM1,LTE/TM1,LTE/TM2
Modulation Characteristics		Test Env.	Ambient Climate & Rated Voltage
		Test Setup	Test Setup 1
		RF Channels (TX)	M (L= low channel, M= middle channel, H= high channel)
		Test Mode	GSM/TM1,GSM/TM2,UMTS/TM1,LTE/TM1,LTE/TM2
Bandwidth	Occupied Bandwidth	Test Env.	Ambient Climate & Rated Voltage
		Test Setup	Test Setup 1
		RF Channels (TX)	L, M, H (L= low channel, M= middle channel, H= high channel)
		Test Mode	GSM/TM1,GSM/TM2,UMTS/TM1,LTE/TM1,LTE/TM2
	Emission Bandwidth (if required)	Test Env.	Ambient Climate & Rated Voltage
		Test Setup	Test Setup 1
		RF Channels (TX)	L, M, H (L= low channel, M= middle channel, H= high channel)
		Test Mode	GSM/TM1,GSM/TM2,UMTS/TM1,LTE/TM1,LTE/TM2
Band Edges Compliance		Test Env.	Ambient Climate & Rated Voltage
		Test Setup	Test Setup 1
		RF Channels (TX)	L, H (L= low channel, M= middle channel, H= high channel)
		Test Mode	GSM/TM1,GSM/TM2,UMTS/TM1,LTE/TM1,LTE/TM2
Spurious Emission at Antenna Terminals		Test Env.	Ambient Climate & Rated Voltage
		Test Setup	Test Setup 1
		RF Channels (TX)	L, M, H (L= low channel, M= middle channel, H= high channel)

Test Case	Test Conditions	
	Test Mode	GSM/TM1,GSM/TM2,UMTS/TM1,LTE/TM1,LTE/TM2
Frequency Stability	Test Env.	(1) -30 °C to +50 °C with step 10 °C at Rated Voltage; (2) VL, VN and VH of Rated Voltage at Ambient Climate.
	Test Setup	Test Setup 2
	RF Channels (TX)	L, M, H (L= low channel, M= middle channel, H= high channel)
	Test Mode	GSM/TM1,GSM/TM2,UMTS/TM1,LTE/TM1,LTE/TM2

6 Main Test Instruments

6.1 Current Test Project/Report

<input checked="" type="checkbox"/> Main Test Equipment(GSM/WCDMA/LTE test system)						
Marked	Equipment Name	Manufacturer	Model	Serial Number	Cal Date	Cal-Due
<input type="checkbox"/>	DC Power Supply	KEITHLEY	2303	1342889	2018/10/24	2019/10/24
<input type="checkbox"/>	DC Power Supply	KEITHLEY	2303	000500E	2018/05/21	2019/05/21
<input type="checkbox"/>	DC Power Supply	KEITHLEY	2303	1288003	2018/12/20	2019/12/20
<input checked="" type="checkbox"/>	DC Power Supply	KEITHLEY	2303	000381E	2018/05/21	2019/05/21
<input type="checkbox"/>	DC Power Supply	KEITHLEY	2303	000510E	2018/05/21	2019/05/21
<input checked="" type="checkbox"/>	Temperature Chamber	WEISS	WKL64	56246002940010	2018/10/24	2019/10/24
<input type="checkbox"/>	Universal Radio Communication Tester	R&S	CMW500	159302	2018/07/23	2019/07/23
<input checked="" type="checkbox"/>	Universal Radio Communication Tester	R&S	CMW500	126854	2018/07/23	2019/07/23
<input type="checkbox"/>	Universal Radio Communication Tester	R&S	CMW500	164698	2018/06/17	2019/06/17
<input checked="" type="checkbox"/>	Universal Radio Communication Tester	R&S	CMU200	110932	2018/4/27	2019/4/27
<input type="checkbox"/>	Universal Radio Communication Tester	R&S	CMU200	123299	2018/12/18	2019/12/18
<input type="checkbox"/>	Universal Radio Communication Tester	R&S	CMU200	117341	2018/12/18	2019/12/18
<input type="checkbox"/>	Signal Analyzer	R&S	FSQ31	200021	2018/7/23	2019/7/23
<input type="checkbox"/>	Signal Analyzer	R&S	FSU26	201069	2018/11/02	2019/11/02
<input type="checkbox"/>	Spectrum Analyzer	Agilent	N9030A	MY51380032	2018/07/23	2019/07/23
<input checked="" type="checkbox"/>	Spectrum Analyzer	Agilent	N9030A	MY49431698	2018/07/23	2019/07/23
<input type="checkbox"/>	Spectrum Analyzer	Keysight	N9040B	MY57212529	2018/06/28	2019/06/28
<input type="checkbox"/>	Signal generator	Agilent	E8257D	MY51500314	2018/04/27	2019/04/27
<input checked="" type="checkbox"/>	Signal generator	Agilent	E8257D	MY49281095	2018/07/23	2019/07/23
<input checked="" type="checkbox"/>	Vector Signal Generator	R&S	SMU200A	104162	2018/07/23	2019/07/23
<input type="checkbox"/>	Vector Signal Generator	R&S	SMW200A	103447	2018/05/31	2019/05/31

<input checked="" type="checkbox"/> Main Test Equipment (RSE test system)						
Marked	Equipment Name	Manufacturer	Model	Serial Number	Cal Date	Cal-Due
<input checked="" type="checkbox"/>	Universal Radio Communication Tester	R&S	CMU200	117385	2018/05/08	2019/05/07
<input checked="" type="checkbox"/>	Universal Radio Communication Tester	R&S	MT8821C	6261760791	2018/04/02	2019/04/01

<input checked="" type="checkbox"/>	Spectrum analyzer	R&S	FSU3	200474	2019/01/15	2020/01/14
<input checked="" type="checkbox"/>	Spectrum analyzer	R&S	FSU43	100144	2019/01/15	2020/01/14
<input type="checkbox"/>	Trilog Broadband Antenna (30M~3GHz)	SCHWARZBECK	VULB 9163	9163-490	2017/03/29	2019/03/28
<input checked="" type="checkbox"/>	Trilog Broadband Antenna (30M~3GHz)	SCHWARZBECK	VULB 9163	9163-521	2018/04/09	2020/04/08
<input checked="" type="checkbox"/>	Double-Ridged Waveguide Horn Antenna (1G~18GHz)	R&S	HF907	100304	2017/05/27	2019/05/26
<input checked="" type="checkbox"/>	double ridged horn antenna (0.8G-18GHz)	R&S	HF907	100391	2017/7/20	2019/7/19
<input checked="" type="checkbox"/>	Pyramidal Horn Antenna(18GHz-26.5GHz)	ETS-Lindgren	3160-09	5140299	2017/07/20	2019/07/19
<input type="checkbox"/>	Pyramidal Horn Antenna(18GHz-26.5GHz)	ETS-Lindgren	3160-09	00206665	2018/4/21	2020/4/20
<input type="checkbox"/>	Pyramidal Horn Antenna(26.5GHz-40GHz)	ETS-Lindgren	3160-10	00205695	2018/04/20	2020/04/19
<input checked="" type="checkbox"/>	Pyramidal Horn Antenna(26.5GHz-40GHz)	ETS-Lindgren	3160-10	LM5947	2017/07/20	2019/07/19
<input checked="" type="checkbox"/>	Measurement Software	R&S	EMC32 V8.40.0	/	/	/

7 Measurement Uncertainty

For a 95% confidence level ($k = 2$), the measurement expanded uncertainties for defined systems, in accordance with the recommendations of ISO 17025 as following:

Test Item		Extended Uncertainty
Transmit Output Power Conducted	Power [dBm]	U = 0.64 dB
RF Power Density, Conducted	Power [dBm]	U = 0.64 dB
Bandwidth	Magnitude [kHz]	200kHz: U=9.06kHz 1.4MHz: U=9.48kHz 3MHz: U= 10.86kHz 5MHz: U=13.84kHz 10MHz: U=22.32kHz 15MHz: U=31.9kHz 20MHz: U=41.78kHz
Band Edge Compliance	Disturbance Power [dBm]	U = 0.9 dB
Spurious Emissions, Conducted	Disturbance Power [dBm]	20MHz~3.6GHz: U=0.88dB 3.6GHz~8.4GHz: U=1.08dB 8.4GHz~13.6GHz: U=1.24dB 13.6GHz~22GHz: U=1.34dB 22GHz~26.5GHz: U=1.36dB
Field Strength of Spurious Radiation	ERP/EIRP [dBm]	For 3 m Chamber: U = 5.94 dB (30 MHz to 3GHz) U = 5.54 dB (3GHz to 18GHz) U = 4.94 dB (18GHz to 26.5GHz)
Frequency Stability	Frequency Accuracy [Hz]	800MHz: U=24.08Hz 900MHz: U=24.54Hz 1900MHz: U=34.7Hz 2100MHz: U=36.96Hz 2300MHz: U=39.24Hz 2500MHz: U=41.58Hz 2600MHz: U=42.74Hz

8 Appendixes

Appendix No.	Description
SYBH(Z-RF)20190214006001-2001-A	Appendix_for_GSM
SYBH(Z-RF)20190214006001-2001-B	Appendix_for_WCDMA
SYBH(Z-RF)20190214006001-2001-C	Appendix_for_LTE_Band_7

Appendix	Description
Appendix A	Effective (Isotropic) Radiated Power Output Data
Appendix B	Peak-Average Ratio
Appendix C	Modulation Characteristics
Appendix D	Bandwidth
Appendix E	Band Edges Compliance
Appendix F	Spurious Emission at Antenna Terminals
Appendix G	Field Strength of Spurious Radiation
Appendix H	Frequency Stability

END