



中国认可
国际互认
检测
TESTING
CNAS L0310



FCC RF Test Report

Product Name: Smart Phone

Model Number: SNE-LX1

Report No.: SYBH(Z-RF)20180619018002-2005

FCC ID: QISSNE-LX1

Reliability Laboratory of Huawei Technologies Co., Ltd.

(Global Compliance and Testing Center of Huawei Technologies Co., Ltd)

Administration Building, Headquarters of Huawei Technologies Co., Ltd., Bantian, Longgang District,
Shenzhen, 518129, P.R.C

Tel: +86 755 28780808

Fax: +86 755 89652518



Notice

1. The laboratory has passed the accreditation by China National Accreditation Service for Conformity Assessment (CNAS). The accreditation number is L0310.
2. The laboratory has passed the accreditation by The American Association for Laboratory Accreditation (A2LA). The accreditation number is 2174.01.
3. The laboratory has been recognized by the US Federal Communications Commission (FCC) to perform compliance testing subject to the Commission's Certification rules. The Designation Number is CN1173, and the Test Firm Registration Number is 294140.
4. The laboratory has been listed by Industry Canada to perform electromagnetic emission measurements. The recognition numbers of test site are 6369A-1.
5. The laboratory (Reliability Lab of Huawei Technologies Co., Ltd) is also named "Global Compliance and Testing Center of Huawei Technologies Co., Ltd", the both names have coexisted since 2009.
6. The test report is invalid if not marked with the signatures of the persons responsible for preparing and approving the test report.
7. The test report is invalid if there is any evidence of erasure and/or falsification.
8. The test report is only valid for the test samples.
9. Content of the test report, in part or in full, cannot be used for publicity and/or promotional purposes without prior written approval from the laboratory.



Applicant: Huawei Technologies Co., Ltd.
Address: Administration Building, Headquarters of Huawei Technologies Co., Ltd.,
Bantian, Longgang District, Shenzhen, 518129, P.R.C

Date of Receipt Sample: 2018-07-13
Start Date of Test: 2018-07-16
End Date of Test: 2018-07-27

Test Result: Pass

Approved by Senior Engineer:	2018-07-30	He Hao	<i>He Hao</i>
	Date	Name	Signature

Prepared by:	2018-07-28	ZhouLingbo	<i>ZhouLingbo</i>
	Date	Name	Signature



CONTENT

1 General Information..... 5

 1.1 Applied Standard..... 5

 1.2 Test Location..... 5

 1.3 Test Environment Condition..... 5

2 Test Summary 6

 2.1 Measurement Technical Requirements..... 6

3 Description of the Equipment under Test (EUT) 8

 3.1 General Description 8

 3.2 EUT Identity 8

 3.3 Technical Description 10

4 General Test Conditions / Configurations 12

 4.1 Test Modes 12

 4.2 EUT Configurations..... 12

 4.3 Test Environments 13

 4.4 Test Setups 14

 4.5 Test Conditions 15

5 Main Test Instruments 16

6 Measurement Uncertainty..... 17

7 Appendixes..... 18



1 General Information

1.1 **Applied Standard**

Applied Rules: 47 CFR FCC Part 2, Subpart J
 47 CFR FCC Part 15, Subpart C
 47 CFR FCC Part 15, Subpart E

Test Method: KDB 789033 D02 General UNII Test Procedures New Rules v02
 FCC KDB 558074 D01 DTS Meas Guidance v04
 ANSI C63.10-2013, American National Standard for Testing Unlicensed Wireless Devices

1.2 **Test Location**

Test Location 1: Reliability Laboratory of Huawei Technologies Co., Ltd.
Address1: Administration Building, Headquarters of Huawei Technologies Co., Ltd., Bantian, Longgang
 District, Shenzhen, 518129, P.R.C

1.3 **Test Environment Condition**

Temperature: 15 to 30 °C (Ambient)
Relative Humidity: 20 to 85 % (Ambient)
Atmospheric Pressure: Not applicable



2 Test Summary

2.1 Measurement Technical Requirements

2.1.1 U-NII (5150-5250, 5250-5350, 5470-5725 MHz, 5725-5850)

Test Item	Band	FCC Rule No.	Requirements	Test Result	Verdict
Emission Bandwidth	5150-5250	15.403(i) 15.407(a)(1)	No limit.	Appendix A	Pass
	5250-5350	15.403(i) 15.407(a)(2)			
	5470-5725	15.403(i) 15.407(a)(2)			
	5725-5850	15.403(i) 15.407(e)	≥ 500 kHz.		
Occupied Bandwidth	5150-5250	KDB 789033 D02 § B	No limit.	Appendix B	Pass
	5250-5350				
	5470-5725				
	5725-5850				
Duty Cycle	5150-5850	--	No limit.	Appendix C	
Maximum Output Power	5150-5250	15.407(a)(1) 15.407(a)(4)	FCC: conducted < 250mW (avg during transmission)	Appendix D	Pass
	5250-5350	15.407(a)(2) 15.407(a)(4)	FCC:conducted <MIN{250mW,11dBm+10*Ig(EBW)} (avg during transmission)		
	5470-5725	15.407(a)(2) 15.407(a)(4)	FCC: conducted <MIN{250mW,11dBm+10*Ig(EBW)} (avg during transmission)		
	5725-5850	15.407(a)(3)	conducted < 1W (avg during transmission)		
maximum	5150-5250	15.407(a)(1)	FCC	Appendix E	



Test Item	Band	FCC Rule No.	Requirements	Test Result	Verdict
Power Spectral Density		15.407(a)(4)	conducted <11dBm/MHz (avg during transmission)		
	5250-5350	15.407(a)(2) 15.407(a)(4)	conducted <11dBm/MHz (avg during transmission)		
	5470-5725	15.407(a)(2) 15.407(a)(4)	conducted <11dBm/MHz (avg during transmission)		
	5725-5850	15.407(a)(3) 15.407(a)(4)	conducted <30dBm/500KHz (avg during transmission)		
Frequency Stability	5150-5250 5250-5350 5470-5725 5725-5850	15.407(g)	FCC Part 15.407(g)	Appendix F	Pass



3 Description of the Equipment under Test (EUT)

3.1 General Description

SNE-LX1 is subscriber equipment in the GSM/WCDMA/LTE system. The GSM frequency band includes GSM850 and GSM900 and DCS1800 and PCS1900. The UMTS frequency band is B1 and B2 and B4 and B5 and B8. The LTE frequency band is B1 and B3 and B7 and B8 and B20. The Mobile Phone implements such functions as RF signal receiving/transmitting, LTE/HSPA/UMTS and GSM/GPRS/EDGE protocol processing, voice, video MMS service, GPS, AGPS, NFC and WIFI etc. Externally it provides one micro SD card interface (it can also used as SIM card interface), earphone port (to provide voice service) and one SIM card interface. It also provides Bluetooth module to synchronize data between a PC and the phone, or to use the built-in modem of the phone to access the Internet with a PC, or to exchange data with other Bluetooth devices. SNE-LX1 may support single SIM or double SIM. Model SNE-LX1 is a smart phone with dual SIM or single SIM. The difference of them is only for SIM CARD. SNE-LX1 single SIM is deleted one SIM by software. So SNE-LX1 single SIM share the same report and the certification with SNE-LX1 dual SIM.

Note: Only 5G WIFI test data included in this report.



















3.2 EUT Identity

NOTE: Unless otherwise noted in the report, the functional boards installed in the units shall be selected from the below list, but not means all the functional boards listed below shall be installed in one unit.

3.2.1 Board

Board		
Description	Hardware Version	Software Version
Main Board	HL2SNEL21M	SNE-LX1 8.2.0.110(C900)

**3.2.2 Sub-Assembly**

Sub-Assembly			
Sub-Assembly Name	Model	Manufacturer	Description
Adapter	HW-059200BHQ	Huawei Technologies Co.,Ltd	Input voltage: 100-240V ~50/60Hz 0.5A Output voltage: 5V  2A OR 9V  2A
Adapter	HW-059200AHQ	Huawei Technologies Co.,Ltd	Input voltage: 100-240V ~50/60Hz 0.5A Output voltage: 5V  2A OR 9V  2A
Adapter	HW-059200UHQ	Huawei Technologies Co.,Ltd	Input voltage: 100-240V ~50/60Hz 0.5A Output voltage: 5V  2A OR 9V  2A
Adapter	HW-059200EHQ	Huawei Technologies Co.,Ltd	Input voltage: 100-240V ~50/60Hz 0.5A Output voltage: 5V  2A OR 9V  2A
Adapter	HW-090200BH0	Huawei Technologies Co.,Ltd	Input voltage: 100-240V ~50/60Hz 0.5A Output voltage: 5V  2A OR 9V  2A
Adapter	HW-090200AH0	Huawei Technologies Co.,Ltd	Input voltage: 100-240V ~50/60Hz 0.5A Output voltage: 5V  2A OR 9V  2A
Adapter	HW-090200UH0	Huawei Technologies Co.,Ltd	Input voltage: 100-240V ~50/60Hz 0.5A Output voltage: 5V  2A OR 9V  2A
Adapter	HW-090200EH0	Huawei Technologies Co.,Ltd	Input voltage: 100-240V ~50/60Hz 0.5A Output voltage: 5V  2A OR 9V  2A
Rechargeable Li-ion	HB386589ECW	Huawei Technologies Co.,Ltd	Rated capacity: 3650mAh Nominal Voltage:  +3.82V Charging Voltage:  +4.40V



3.3 Technical Description

Characteristics	Description	
IEEE 802.11 WLAN Mode Supported	<input checked="" type="checkbox"/> 802.11a (20 MHz channel bandwidth), <input checked="" type="checkbox"/> 802.11n (20 MHz channel bandwidth), <input checked="" type="checkbox"/> 802.11n (40 MHz channel bandwidth), <input checked="" type="checkbox"/> 802.11ac (20 MHz channel bandwidth), <input checked="" type="checkbox"/> 802.11ac (40 MHz channel bandwidth), <input checked="" type="checkbox"/> 802.11ac (80 MHz channel bandwidth),	
TX/RX Operating Range	All	$f_c = 5000 \text{ MHz} + N * 5 \text{ MHz}$, where: - f_c = "Operating Frequency" in MHz, - N = "Channel Number".
	5150-5250 MHz (U-NII)	$N = 36$ to 48 with step of 4 for the 20 MHz channel bandwidth. $N = 38$ to 46 with step of 8 for the 40 MHz channel bandwidth. $N = 42$ for the 80 MHz channel bandwidth.
	5250-5350 MHz (U-NII)	$N = 52$ to 64 with step of 4 for the 20 MHz channel bandwidth. $N = 54$ to 62 with step of 8 for the 40 MHz channel bandwidth. $N = 58$ for the 80 MHz channel bandwidth.
	5470-5725 MHz (U-NII)	$N = 100$ to 140 with step of 4 for the 20 MHz channel bandwidth. $N = 102$ to 134 with step of 8 for the 40 MHz channel bandwidth. $N = 106$ to 122 with step of 16 for the 80 MHz channel bandwidth.
	5725-5850MHz(U-NII)	$N = 149$ to 165 with step of 4 for the 20 MHz channel bandwidth. $N = 151$ to 159 with step of 8 for the 40 MHz channel bandwidth. $N = 155$ for the 80 MHz channel bandwidth.
Modulation Type	BPSK/QPSK/16QAM/64QAM (OFDM).	
Emission Designator	U-NII(5150-5250 , 5250-5350, 5470-5725)	20M1G7D (for 802.11a mod), 20M6G7D (for 802.11n 20 MHz mode), 40M1G7D (for 802.11n 40 MHz mode), 20M5G7D (for 802.11ac 20 MHz mode) 39M7G7D (for 802.11ac 40 MHz mode) 81M2G7D (for 802.11ac 80 MHz mode)
	U-NII(5725-5850)	16M4G7D (for 802.11a mod), 17M6G7D (for 802.11n 20 MHz mode), 35M7G7D (for 802.11n 40 MHz mode), 17M6G7D (for 802.11ac 20 MHz mode) 35M7G7D (for 802.11ac 40 MHz mode) 75M3G7D (for 802.11ac 80 MHz mode)
TPC	<input checked="" type="checkbox"/> Supported, <input type="checkbox"/> Not Supported	
Antenna	Description	Isotropic Antenna
	Type	<input type="checkbox"/> External, <input checked="" type="checkbox"/> Integrated
	Ports	<input checked="" type="checkbox"/> Ant 1, <input type="checkbox"/> Ant 2, <input type="checkbox"/> Ant 3, <input type="checkbox"/> Ant 4
	Smart System	<input checked="" type="checkbox"/> SISO (for 802.11a/n/ac), <input type="checkbox"/> MIMO (for 802.11n/ac), <input type="checkbox"/> Diversity (for 802.11a) : Tx & Rx
	Gain	-1.3 dBi (per antenna port, max.)



Characteristics	Description		
	Remark	When the EUT is put into service, the practical maximum antenna gain should NOT exceed the value as described above.	
Power Supply	Type	<input checked="" type="checkbox"/> AC/DC Adapter	<input type="checkbox"/> PoE: <input type="checkbox"/> Other:



4 General Test Conditions / Configurations

4.1 Test Modes

NOTE: Worst cases for each IEEE 802.11 mode are selected to perform tests.

Test Mode	Test Modes Description
11A	IEEE 802.11a with data rate of 6 Mbps using SISO mode.
11N20	IEEE 802.11n with data rate of MCS0 and bandwidth of 20 MHz using SISO mode.
11N40	IEEE 802.11n with data rate of MCS0 and bandwidth of 40 MHz using SISO mode.
11AC20	IEEE 802.11ac with data rate of MCS0 and bandwidth of 20 MHz using SISO mode.
11AC40	IEEE 802.11ac with data rate of MCS0 and bandwidth of 40 MHz using SISO mode.
11AC80	IEEE 802.11ac with data rate of MCS0 and bandwidth of 80 MHz using SISO mode.

4.2 EUT Configurations

4.2.1 General Configurations

Configuration	Description
Test Antenna Ports	Until otherwise specified, <ul style="list-style-type: none"> All TX tests are performed at all TX antenna ports of the EUT, and All RX tests are performed at all RX antenna ports of the EUT.
Multiple RF Sources	Other than the tested RF source of the EUT, other RF source(s) are disabled or shutdown during measurements.

4.2.2 Customized Configurations

4.2.2.1 U-NII

Test Mode	Antenna Port	Power Conf.,	Duty cycle [%]
11A	Ant 1	14	97.8
11N20	Ant 1	13	97.6
11N40	Ant 1	12	96.3
11AC20	Ant 1	13	99.1
11AC40	Ant 1	12	98.1
11AC80	Ant 1	12	96.0



4.3 Test Environments

Environment Parameter	Selected Values During Tests	
Relative Humidity	Ambient	
Temperature	TN	Ambient
Voltage	VL	3.6V
	VN	3.8V
	VH	4.4V

NOTE: VL= lower extreme test voltage
VN= nominal voltage
VH= upper extreme test voltage
TN= normal temperature

4.4 Test Setups

4.4.1 Test Setup 1

The WLAN component's antenna ports(s) of the EUT are connected to the measurement instrument per an appropriate attenuator. The EUT is controlled by PC/software to emit the specified signals for the purpose of measurements.

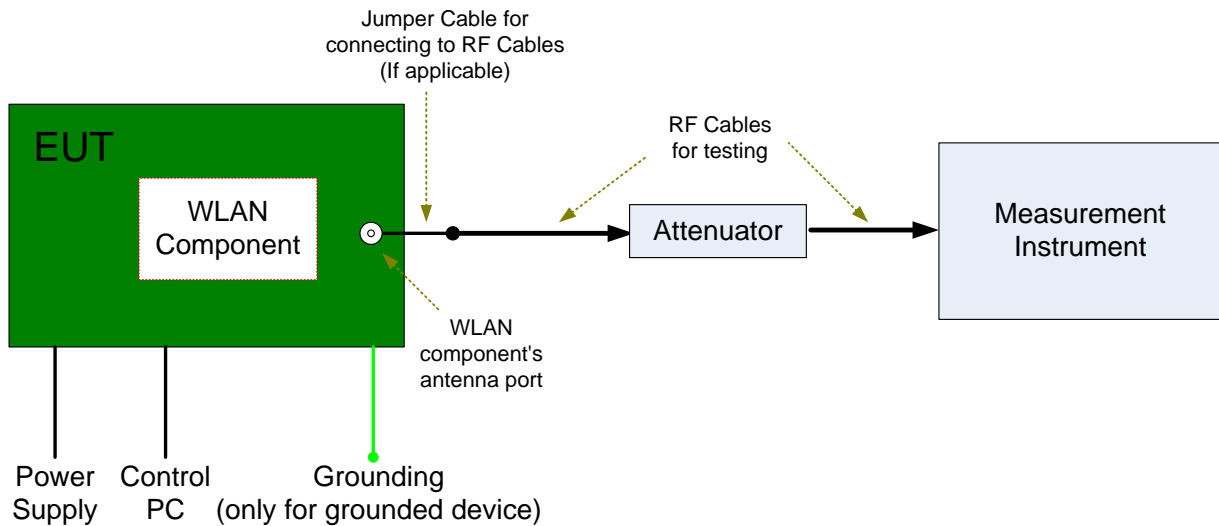



4.5 Test Conditions

4.5.1 U-NII

Test Case	Test Conditions	
	Configuration	Description
Emission Bandwidth (EBW)	Meas. Method	FCC KDB 789033 D02 §C).
	Test Env.	NTNV
	Test Setup	Test Setup 1
	EUT Conf.	All EUT conf. with Tx modes.
Occupied Bandwidth (OBW)	Meas. Method	FCC KDB 789033 D02 §D).
	Test Env.	NTNV
	Test Setup	Test Setup 1
	EUT Conf.	All EUT conf. with Tx modes.
Maximum Conducted Output Power	Meas. Method	FCC KDB 789033 D02 §E)2)b) Method SA-1 and d) Method SA-2.
	Test Env.	NTNV
	Test Setup	Test Setup 1
	EUT Conf.	All EUT conf. with Tx modes.
Maximum Power Spectral Density	Meas. Method	FCC KDB 789033 D02 §F).
	Test Env.	NTNV
	Test Setup	Test Setup 1
	EUT Conf.	All EUT conf. with Tx modes.
Frequency Stability	Meas. Method	15.407(g) Frequency Stability
	Test Env.	(1)VL, VN and VH of Rated Voltage at Ambient Climate. (2) -5 °C,5°C,15°C,25°C,35°C,45°C,50°C
	Test Setup	Test Setup 1
	EUT Conf.	Ch.36,Ch.165



5 Main Test Instruments

NOTE: Unless otherwise specified, the calibration intervals for test instruments were Annual (per year). The other intervals, if applicable, are marked with (##y), which denotes ## years calibration interval.

Test Address 1:

Main Test Equipments					
Equipment Name	Manufacturer	Model	Serial Number	Cal Date	Cal- Due
Power supply	KEITHLEY	2303	1342889	2017/10/24	2018/10/23
Signal Analyzer	R&S	FSQ31	200021	2017/7/31	2018/7/30
Signal generator	Agilent	E8257D	MY49281095	2017/7/31	2018/7/30
Temperature Chamber	WEISS	WKL64	56246002940010	2017/12/13	2018/12/12



6 Measurement Uncertainty

For a 95% confidence level ($k = 2$), the measurement expanded uncertainties for defined systems, in accordance with the recommendations of ISO 17025 as following:

Test Item		Extended Uncertainty
Transmit Output Power Data	Power [dBm]	U = 0.58 dB
RF Power Density, Conducted	Power [dBm]	U = 0.64 dB
Bandwidth	Magnitude [kHz]	20MHz: U=41.78kHz 40MHz: U=82.12kHz 80MHz: U=163.5kHz
Frequency Stability	Frequency Accuracy [Hz]	U=82.24Hz
Duty Cycle	Duty Cycle [%]	U=±2.06 %



7 Appendixes

Appendix No.	Description
SYBH(Z-RF)20180619018002-2005-A	Appendix for 5 WLAN

END