

Fig.11-1 Z-Scan at power reference point (LTE Band 2)

LTE Band 2 Body Rear Low with QPSK_20MHz_1RB_Mid

Date/Time: 7/2/2017

Electronics: DAE4 Sn786

Medium: 1900 Body

Medium parameters used: $f = 1860$ MHz; $\sigma = 1.521$ S/m; $\epsilon_r = 53.065$; $\rho = 1000$ kg/m³

Ambient Temperature: 22.0°C Liquid Temperature: 21.5°C

Communication System: UID 0, LTE_FDD (0) Frequency: 1860 MHz Duty Cycle: 1:1

Probe: EX3DV4 - SN3633 ConvF(7.55, 7.55, 7.55);

Front side Low 1RB_Mid /Area Scan (111x61x1): Interpolated grid: dx=1.500 mm, dy=1.500 mm

Maximum value of SAR (interpolated) = 0.441 W/kg

Front side Low 1RB_Mid /Zoom Scan (5x5x7)/Cube 0: Measurement grid: dx=8mm, dy=8mm, dz=5mm

Reference Value = 9.031 V/m; Power Drift = -0.01 dB

Peak SAR (extrapolated) = 0.597 W/kg

SAR(1 g) = 0.372 W/kg; SAR(10 g) = 0.231 W/kg

Maximum value of SAR (measured) = 0.406 W/kg

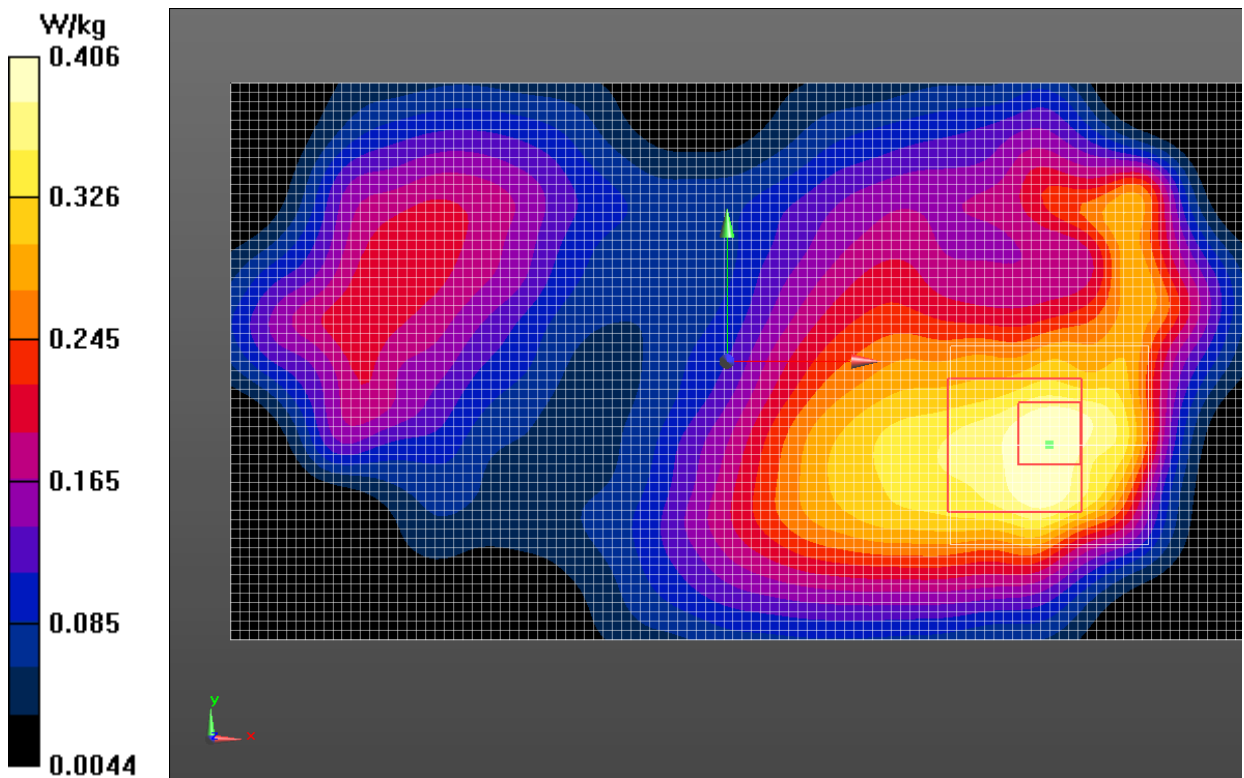

Fig.12 LTE Band 2

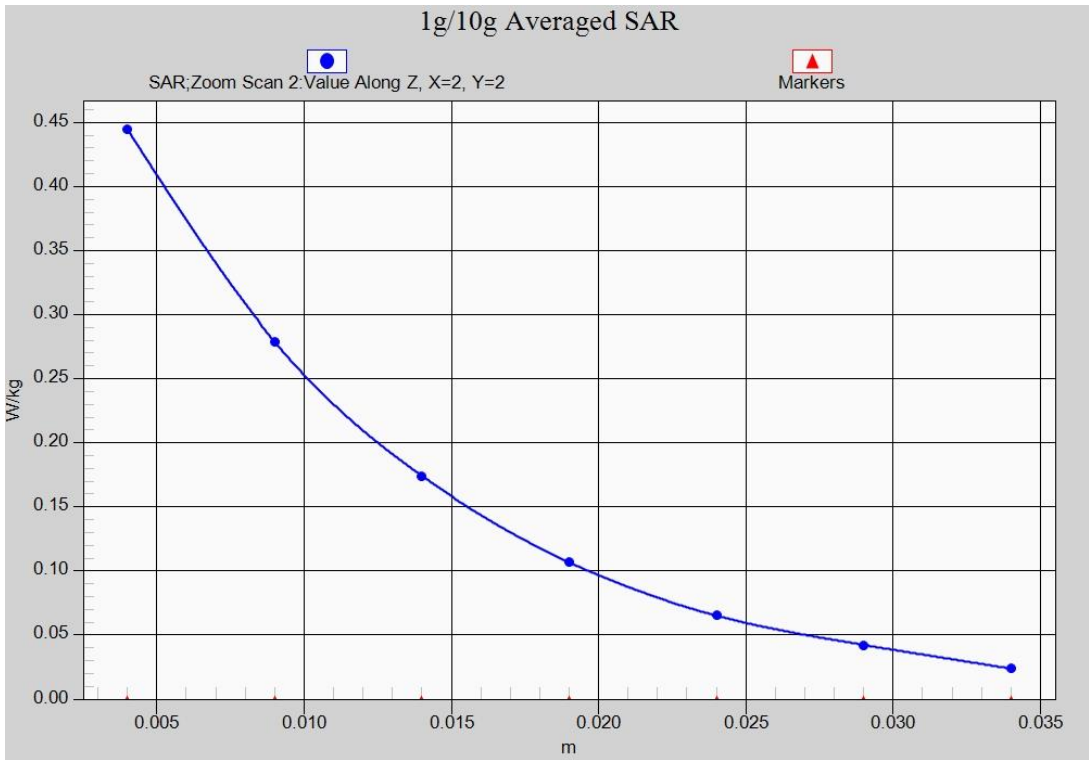

Fig.12-1 Z-Scan at power reference point (LTE Band 2)

LTE Band 4 Left Cheek High with QPSK_20MHz_1RB_Low

Date/Time: 6/30/2017

Electronics: DAE4 Sn786

Medium: 1800Head

Medium parameters used (interpolated): $f = 1745$ MHz; $\sigma = 1.338$ S/m; $\epsilon_r = 39.566$; $\rho = 1000$ kg/m³

Ambient Temperature: 22.0°C Liquid Temperature: 21.5°C

Communication System: UID 0, LTE_FDD (0) Frequency: 1745 MHz Duty Cycle: 1:1

Probe: EX3DV4 - SN3633 ConvF(8.08, 8.08, 8.08);

Left Cheek High 1RB_Low/Area Scan (61x101x1): Interpolated grid: dx=1.500 mm, dy=1.500 mm

Maximum value of SAR (interpolated) = 0.144 W/kg

Left Cheek High 1RB_Low/Zoom Scan (5x5x7)/Cube 0: Measurement grid: dx=8mm, dy=8mm, dz=5mm

Reference Value = 3.354 V/m; Power Drift = -0.04 dB

Peak SAR (extrapolated) = 0.204 W/kg

SAR(1 g) = 0.142 W/kg; SAR(10 g) = 0.094 W/kg

Maximum value of SAR (measured) = 0.153 W/kg

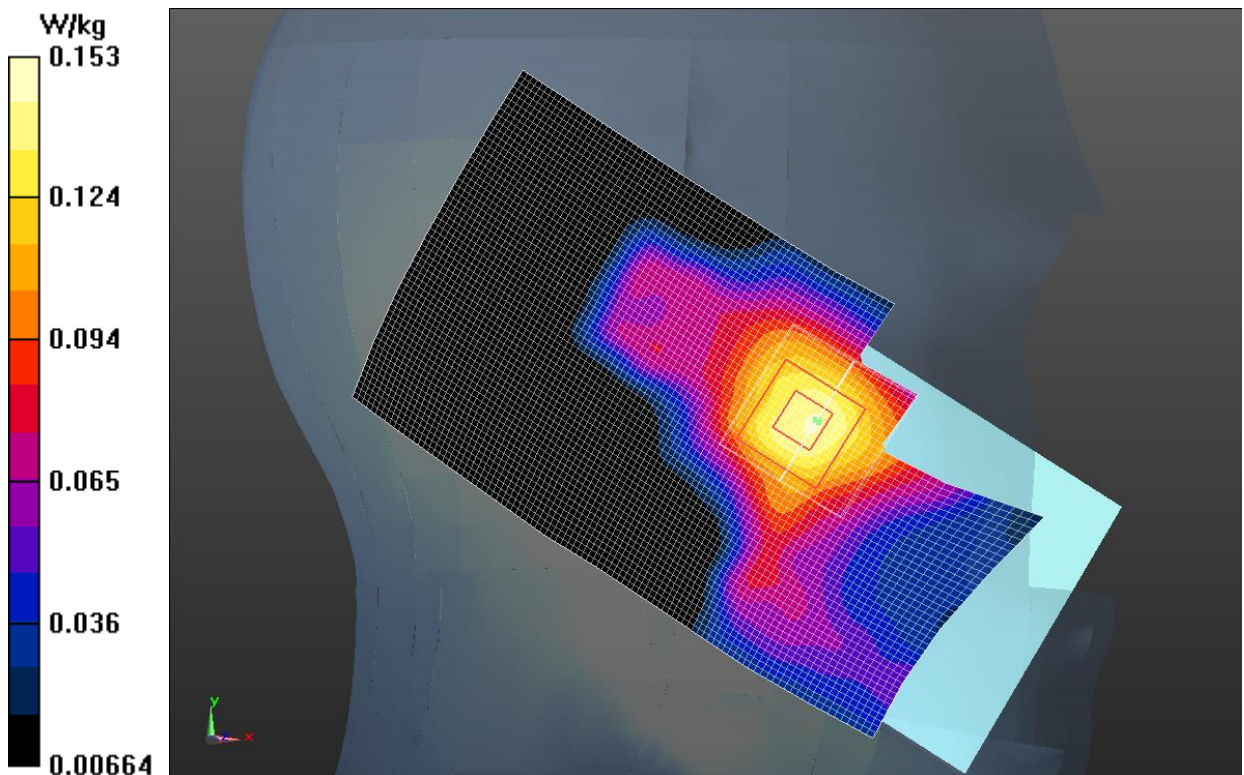

Fig.13 LTE Band 4

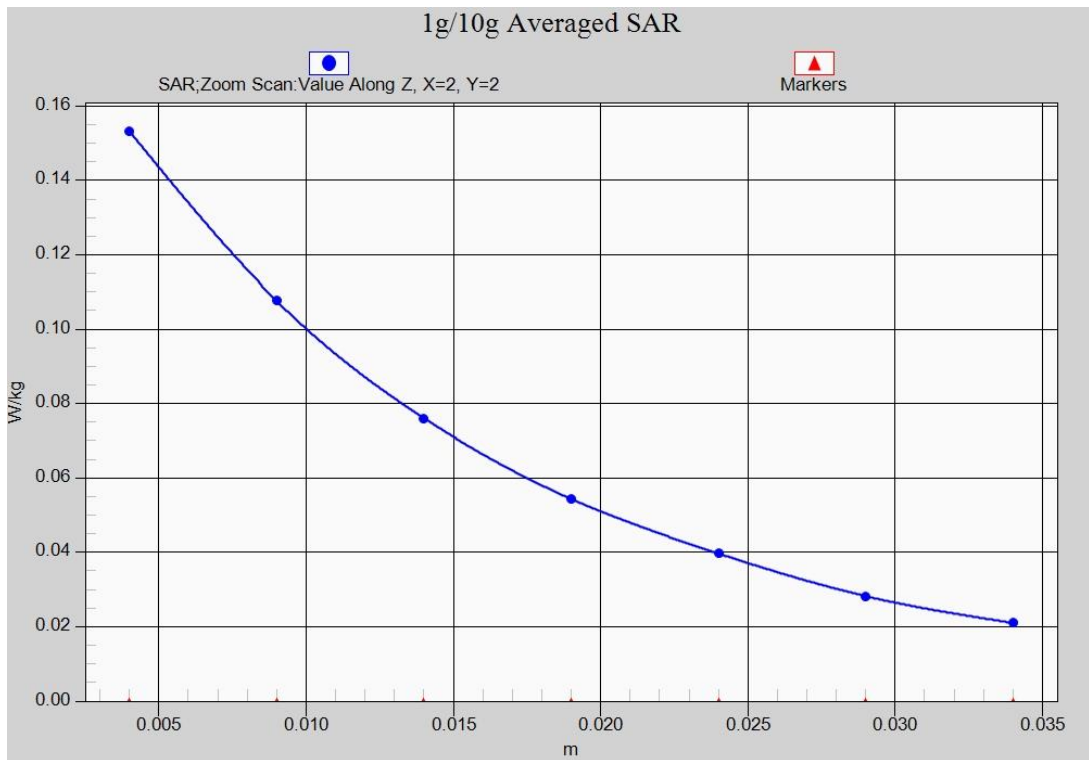

Fig.13-1 Z-Scan at power reference point (LTE Band 4)

LTE Band 4 Body Rear High with QPSK_20MHz_1RB_Low

Date/Time: 6/30/2017

Electronics: DAE4 Sn786

Medium: Body 1800 MHz

Medium parameters used (interpolated): $f = 1745$ MHz; $\sigma = 1.463$ S/m; $\epsilon_r = 53.314$; $\rho = 1000$ kg/m³

Ambient Temperature: 22.0°C Liquid Temperature: 21.5°C

Communication System: UID 0, LTE_FDD (0) Frequency: 1745 MHz Duty Cycle: 1:1

Probe: EX3DV4 - SN3633 ConvF(7.9, 7.9, 7.9);

Bottom side High 1RB_Low /Area Scan (51x61x1): Interpolated grid: dx=1.500 mm, dy=1.500 mm

Maximum value of SAR (interpolated) = 0.807 W/kg

Bottom side High 1RB_Low /Zoom Scan (7x7x7)/Cube 0: Measurement grid: dx=5mm, dy=5mm, dz=5mm

Reference Value = 13.20 V/m; Power Drift = 0.04 dB

Peak SAR (extrapolated) = 1.26 W/kg

SAR(1 g) = 0.740 W/kg; SAR(10 g) = 0.395 W/kg

Maximum value of SAR (measured) = 0.837 W/kg

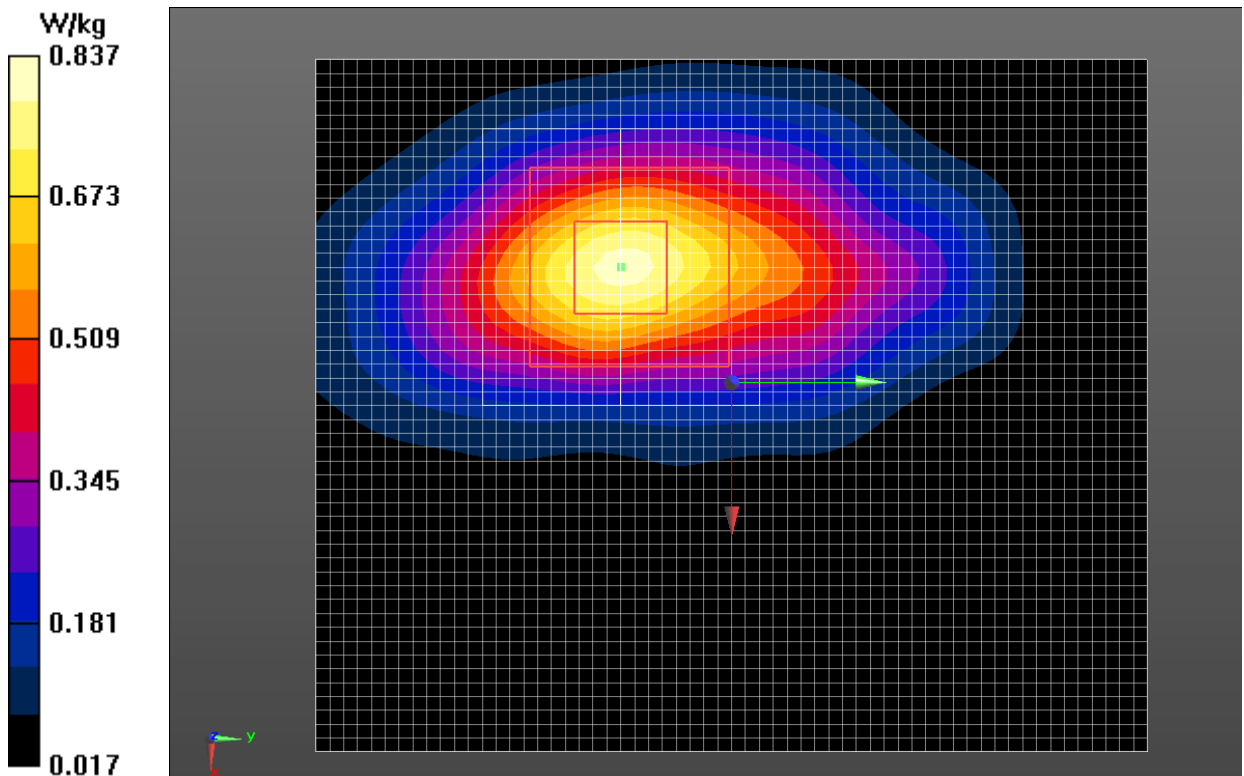

Fig.14 LTE Band 4

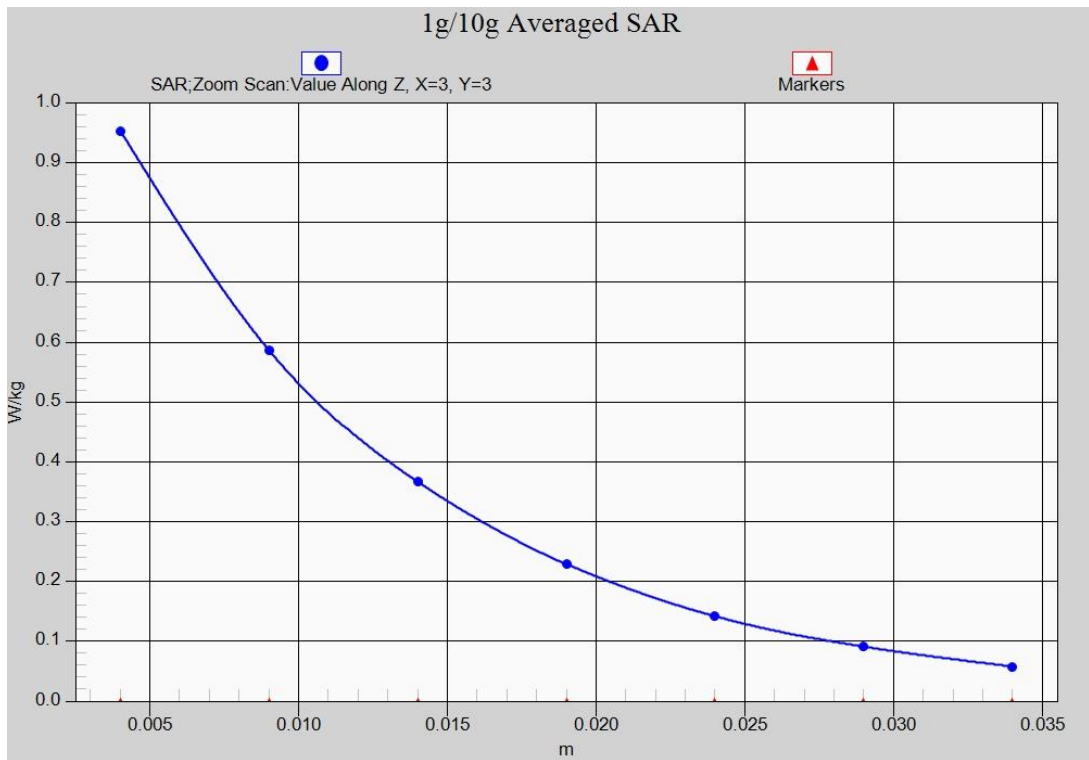

Fig.14-1 Z-Scan at power reference point (LTE Band 4)

LTE Band 5 Left Cheek High with QPSK_10MHz_1RB_Mid

Date/Time: 6/27/2017

Electronics: DAE4 Sn786

Medium: Head 900

Medium parameters used: $f = 844$ MHz; $\sigma = 0.918$ S/m; $\epsilon_r = 40.874$; $\rho = 1000$ kg/m³

Ambient Temperature: 22.0°C Liquid Temperature: 21.5°C

Communication System: UID 0, LTE_FDD (0) Frequency: 844 MHz Duty Cycle: 1:1

Probe: EX3DV4 - SN3633 ConvF(8.88, 8.88, 8.88);

Left Cheek High1RB_Middle/Area Scan (61x101x1): Interpolated grid: dx=1.500 mm, dy=1.500 mm

Maximum value of SAR (interpolated) = 0.188 W/kg

Left Cheek High1RB_Middle/Zoom Scan (5x5x7)/Cube 0: Measurement grid: dx=8mm, dy=8mm, dz=5mm

Reference Value = 4.436 V/m; Power Drift = -0.07 dB

Peak SAR (extrapolated) = 0.231 W/kg

SAR(1 g) = 0.185 W/kg; SAR(10 g) = 0.140 W/kg

Maximum value of SAR (measured) = 0.194 W/kg

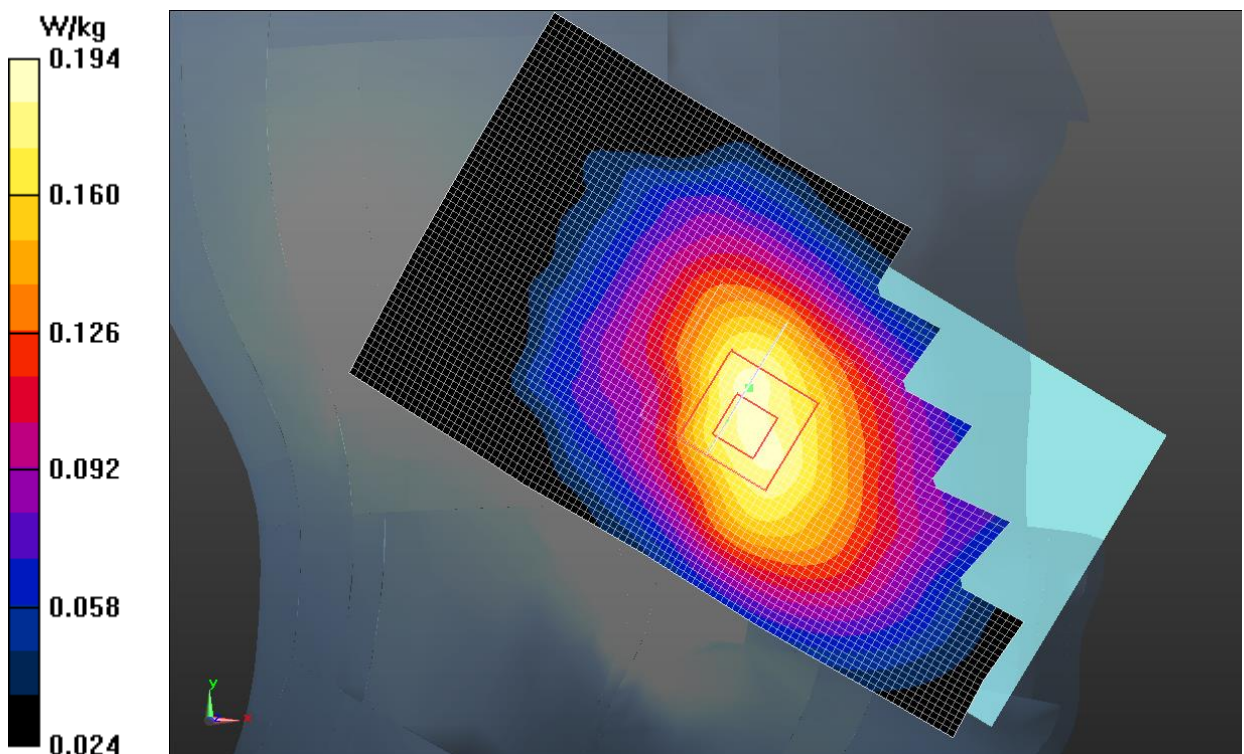

Fig.15 LTE Band 5

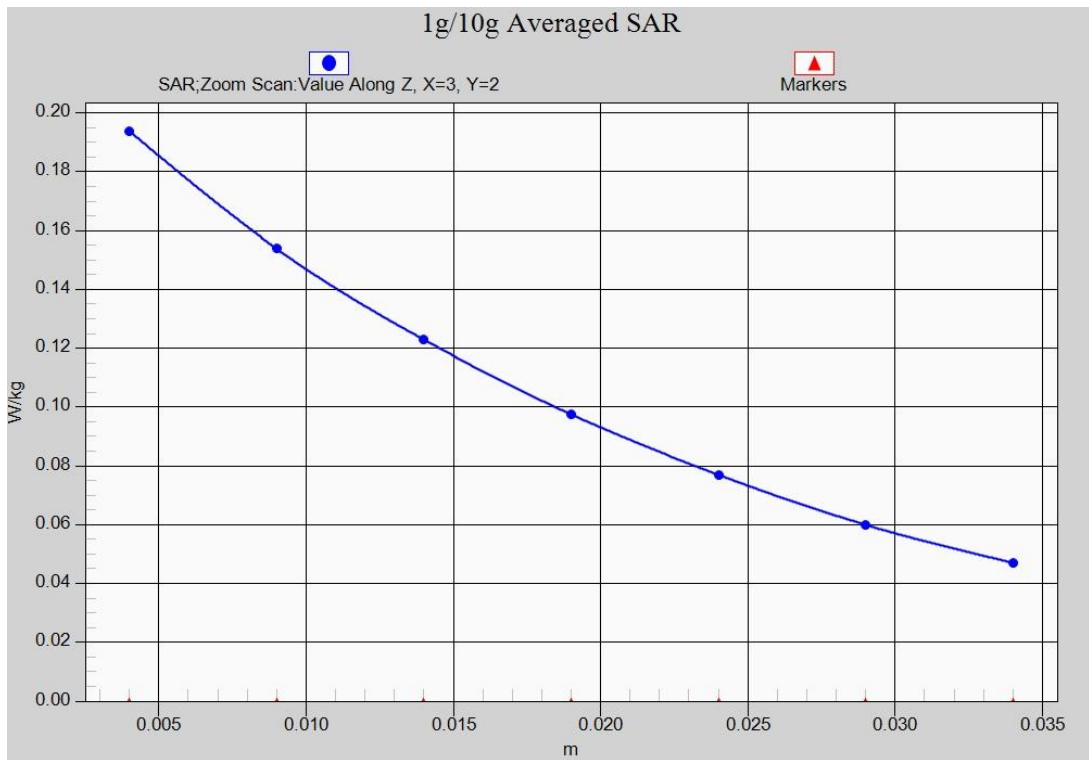

Fig.15-1 Z-Scan at power reference point (LTE Band 5)

LTE Band 5 Body Rear High with QPSK_10MHz_1RB_Mid

Date/Time: 6/27/2017

Electronics: DAE4 Sn786

Medium: Body 900 MHz

Medium parameters used: $f = 844$ MHz; $\sigma = 0.997$ S/m; $\epsilon_r = 52.605$; $\rho = 1000$ kg/m³

Ambient Temperature: 22.0°C Liquid Temperature: 21.5°C

Communication System: UID 0, LTE_FDD (0) Frequency: 844 MHz Duty Cycle: 1:1

Probe: EX3DV4 - SN3633 ConvF(9.24, 9.24, 9.24);

Rear Side High_1RB_Mid/Area Scan (61x101x1): Interpolated grid: dx=1.500 mm, dy=1.500 mm

Maximum value of SAR (interpolated) = 0.118 W/kg

Rear Side High_1RB_Mid/Zoom Scan (5x5x7)/Cube 0: Measurement grid: dx=8mm, dy=8mm, dz=5mm

Reference Value = 9.258 V/m; Power Drift = 0.18 dB

Peak SAR (extrapolated) = 0.143 W/kg

SAR(1 g) = 0.109 W/kg; SAR(10 g) = 0.080 W/kg

Maximum value of SAR (measured) = 0.116 W/kg

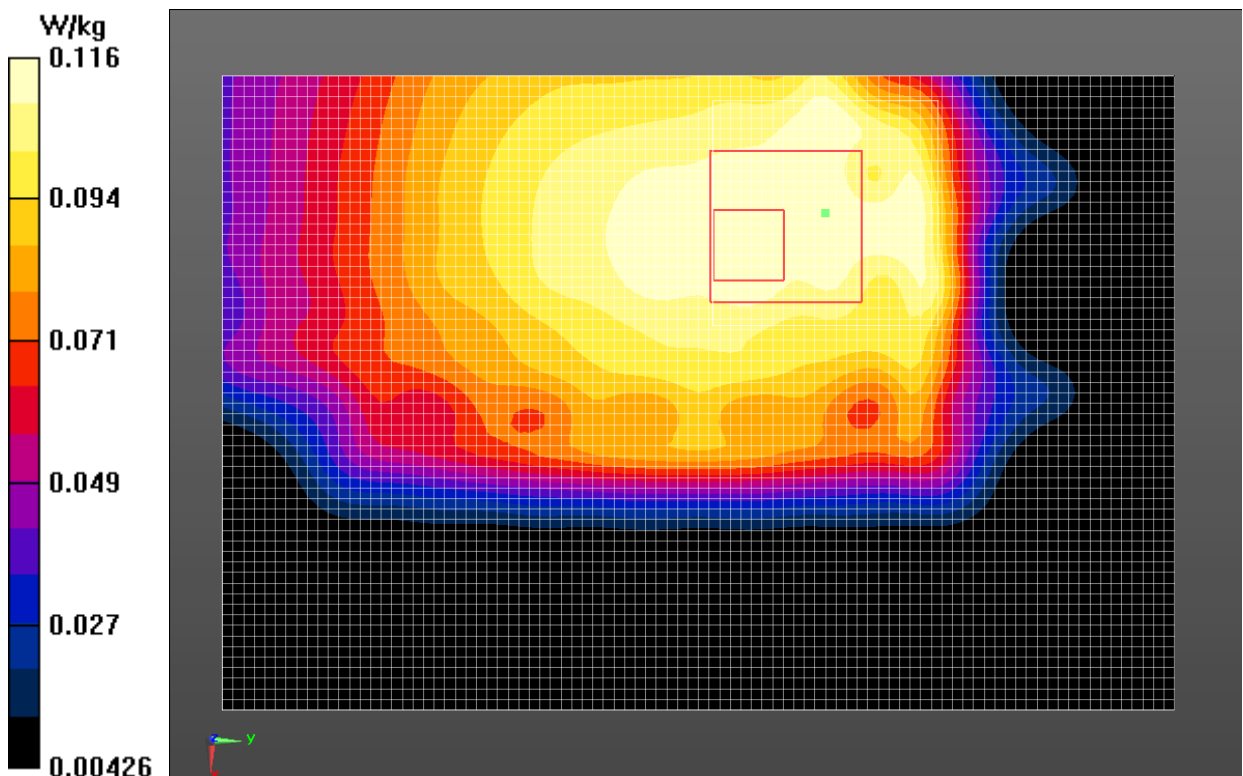

Fig.16 LTE Band 5

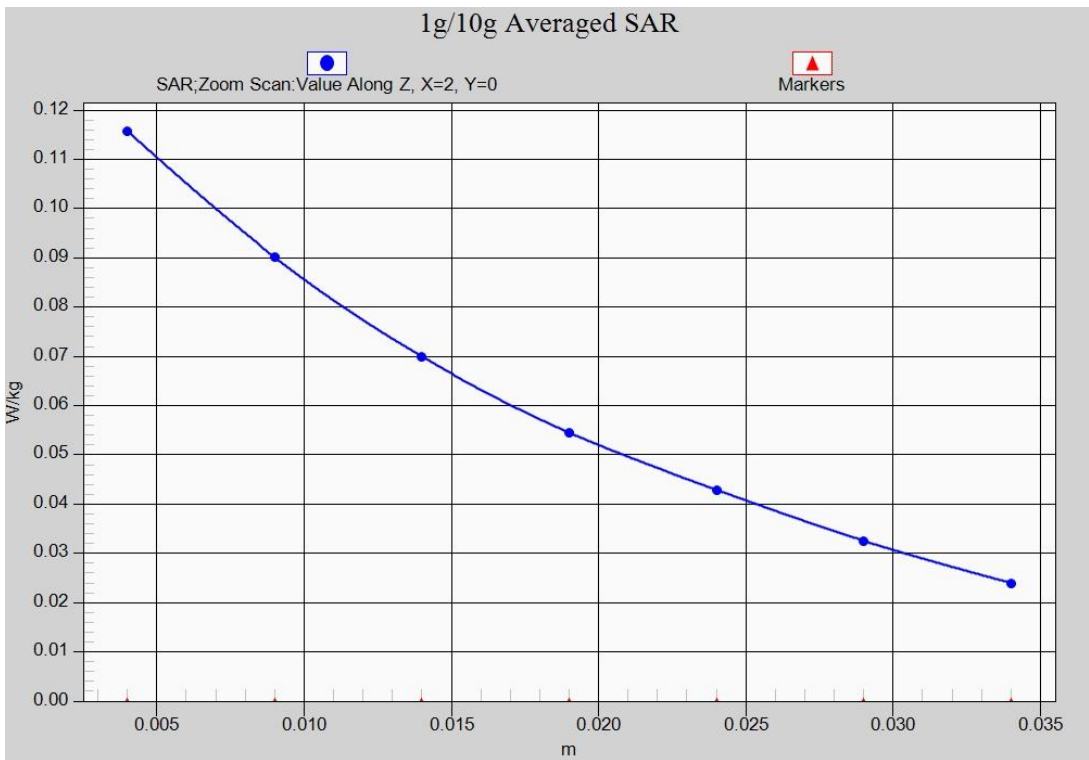

Fig.16-1 Z-Scan at power reference point (LTE Band 5)

LTE Band 7 Left Cheek High with QPSK_20MHz_1RB_High

Date/Time: 7/8/2017

Electronics: DAE4 Sn786

Medium: 2550Head

Medium parameters used: $f = 2560$ MHz; $\sigma = 1.963$ S/m; $\epsilon_r = 38.335$; $\rho = 1000$ kg/m³

Ambient Temperature: 22.0°C Liquid Temperature: 21.5°C

Communication System: UID 0, LTE_FDD (0) Frequency: 2560 MHz Duty Cycle: 1:1

Probe: EX3DV4 - SN3633 ConvF(7.27, 7.27, 7.27);

Left Cheek High1RB_High/Area Scan (61x101x1): Interpolated grid: dx=1.500 mm, dy=1.500 mm

Maximum value of SAR (interpolated) = 0.725 W/kg

Left Cheek High1RB_High/Zoom Scan (5x5x7)/Cube 0: Measurement grid: dx=8mm, dy=8mm, dz=5mm

Reference Value = 5.715 V/m; Power Drift = 0.09 dB

Peak SAR (extrapolated) = 1.02 W/kg

SAR(1 g) = 0.545 W/kg; SAR(10 g) = 0.284 W/kg

Maximum value of SAR (measured) = 0.597 W/kg

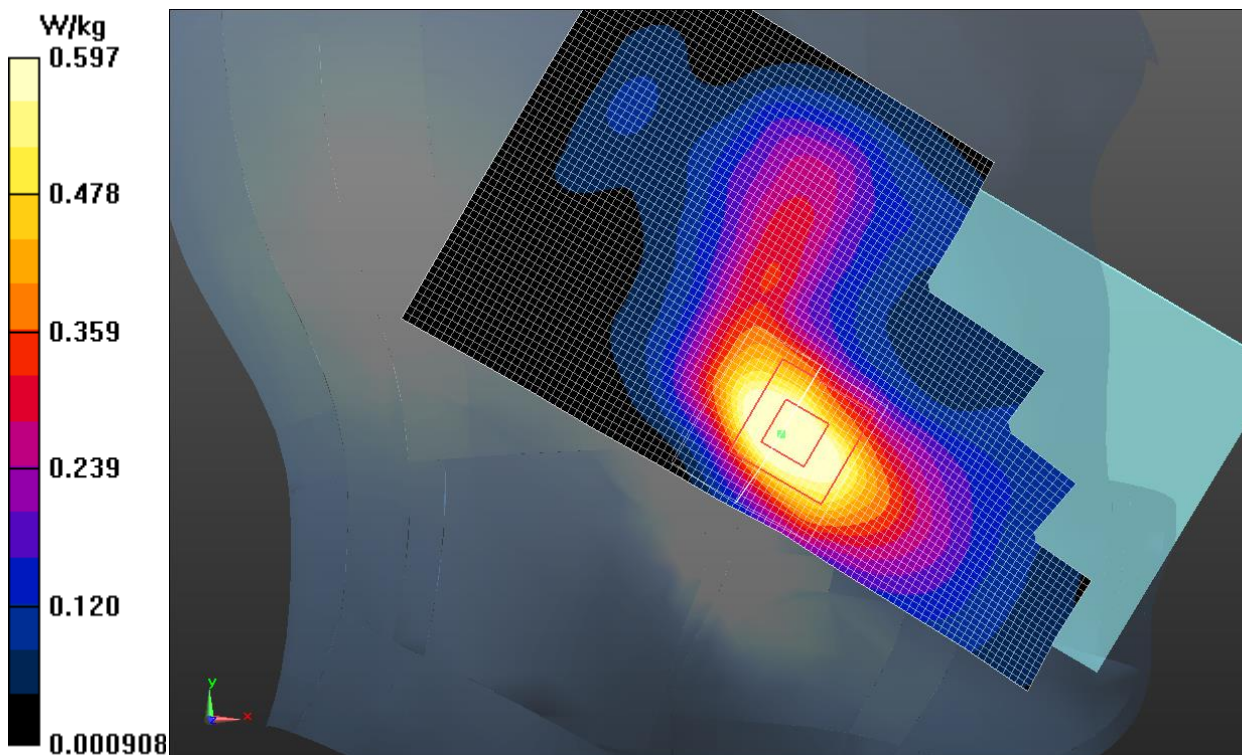

Fig.17 LTE Band 2

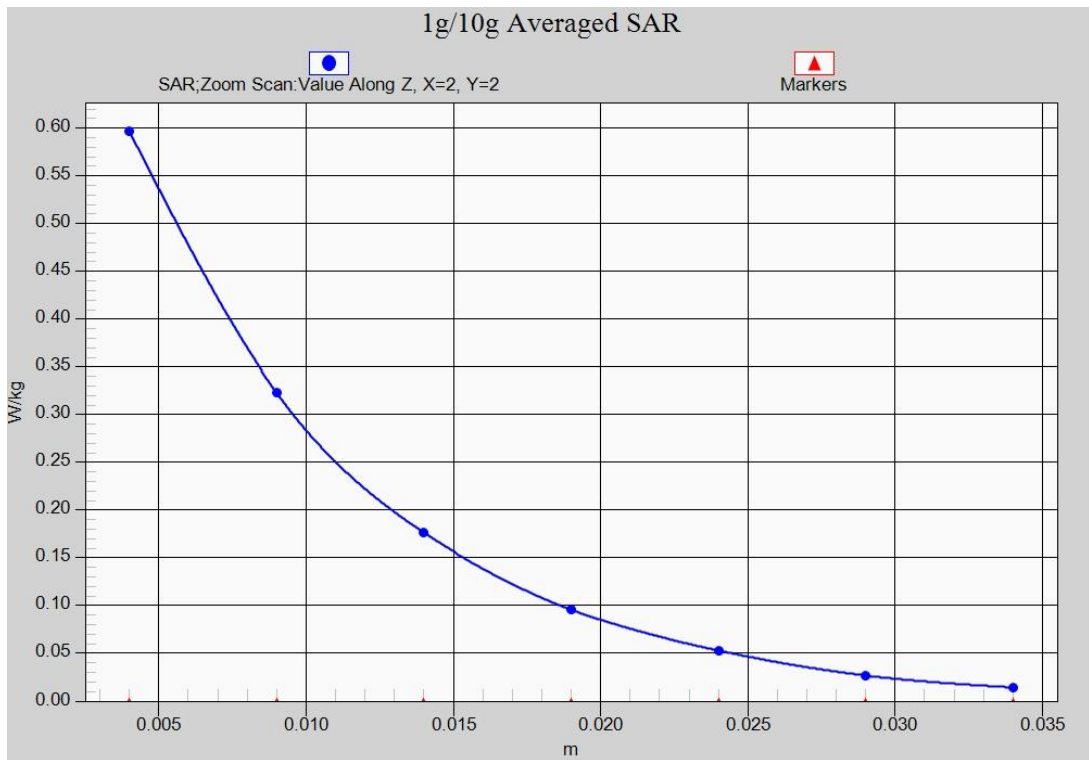

Fig.17-1 Z-Scan at power reference point (LTE Band 7)

LTE Band 7 Body Rear High with QPSK_20MHz_1RB_High

Date/Time: 7/8/2017

Electronics: DAE4 Sn786

Medium: 2550Body MHz

Medium parameters used: $f = 2560$ MHz; $\sigma = 2.076$ S/m; $\epsilon_r = 50.315$; $\rho = 1000$ kg/m³

Ambient Temperature: 22.0°C Liquid Temperature: 21.5°C

Communication System: UID 0, LTE_FDD (0) Frequency: 2560 MHz Duty Cycle: 1:1

Probe: EX3DV4 - SN3633 ConvF(7.24, 7.24, 7.24);

Rear side High 1RB_High/Area Scan (111x61x1): Interpolated grid: dx=1.500 mm, dy=1.500 mm

Maximum value of SAR (interpolated) = 1.06 W/kg

Rear side High 1RB_High/Zoom Scan (5x5x7)/Cube 0: Measurement grid: dx=8mm, dy=8mm, dz=5mm

Reference Value = 6.717 V/m; Power Drift = 0.06 dB

Peak SAR (extrapolated) = 1.48 W/kg

SAR(1 g) = 0.815 W/kg; SAR(10 g) = 0.432 W/kg

Maximum value of SAR (measured) = 0.881 W/kg

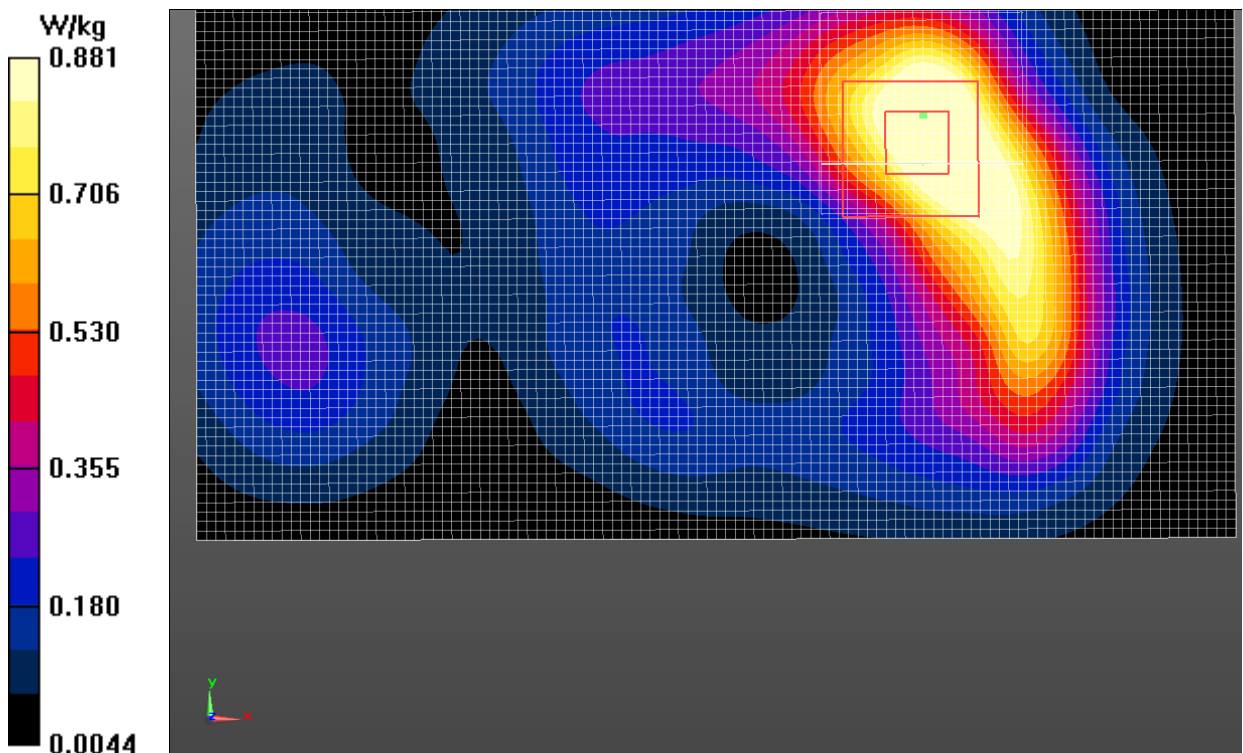

Fig.18 LTE Band 7

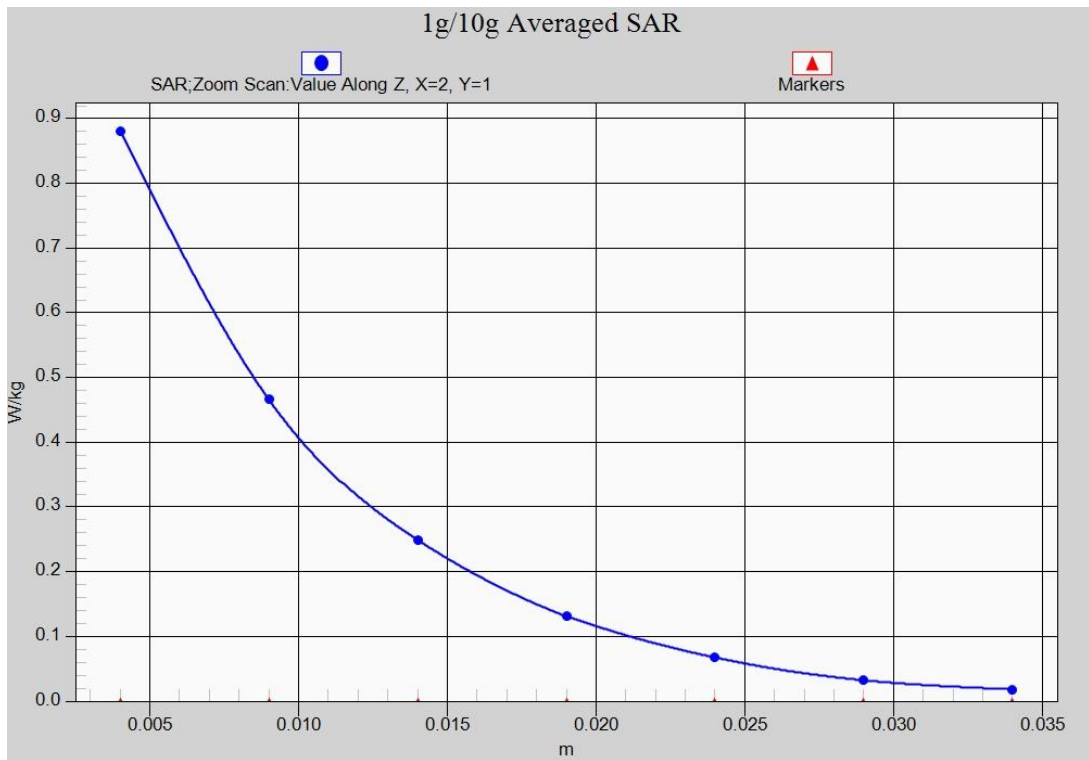

Fig.18-1 Z-Scan at power reference point (LTE Band 7)

Wi-Fi 2.4G 802.11b Right Cheek Channel 11

Date/Time: 7/4/2017

Electronics: DAE4 Sn786

Medium: 2450 Head

Medium parameters used: $f = 2462$ MHz; $\sigma = 1.834$ S/m; $\epsilon_r = 38.473$ $\rho = 1000$ kg/m³

Ambient Temperature: 22.0°C Liquid Temperature: 21.5°C

Communication System: UID 0, WLAN 2.4G CE Frequency: 2462 MHz Duty Cycle: 1:1

Probe: EX3DV4 - SN3633 ConvF(7.40, 7.40, 7.40);

Right Cheek/Area Scan (61x111x1): Interpolated grid: dx=1.500 mm, dy=1.500 mm

Maximum value of SAR (interpolated) = 0.818 W/kg

Right Cheek/Zoom Scan (5x5x7)/Cube 0: Measurement grid: dx=8mm, dy=8mm, dz=5mm

Reference Value = 13.83 V/m; Power Drift = -0.10 dB

Peak SAR (extrapolated) = 1.65 W/kg

SAR(1 g) = 0.639 W/kg; SAR(10 g) = 0.294 W/kg

Maximum value of SAR (measured) = 0.716 W/kg

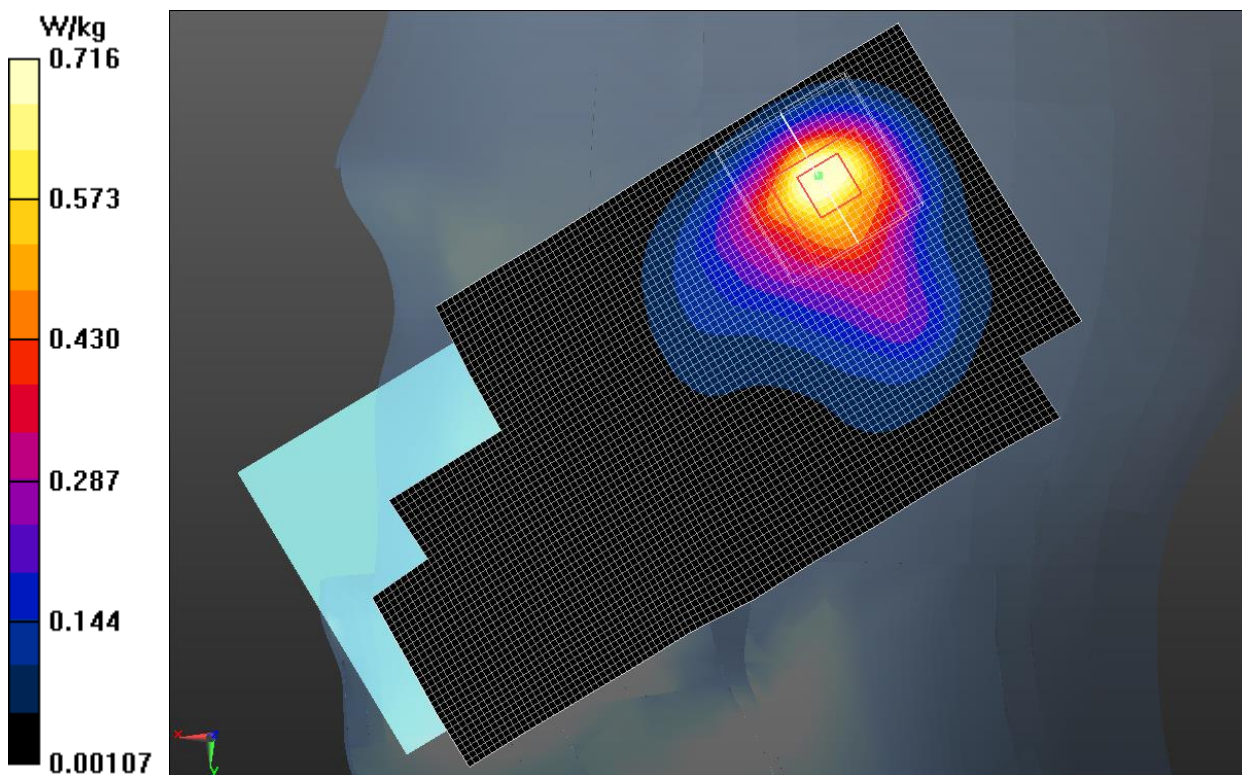

Fig.19 Wi-Fi 2.4G

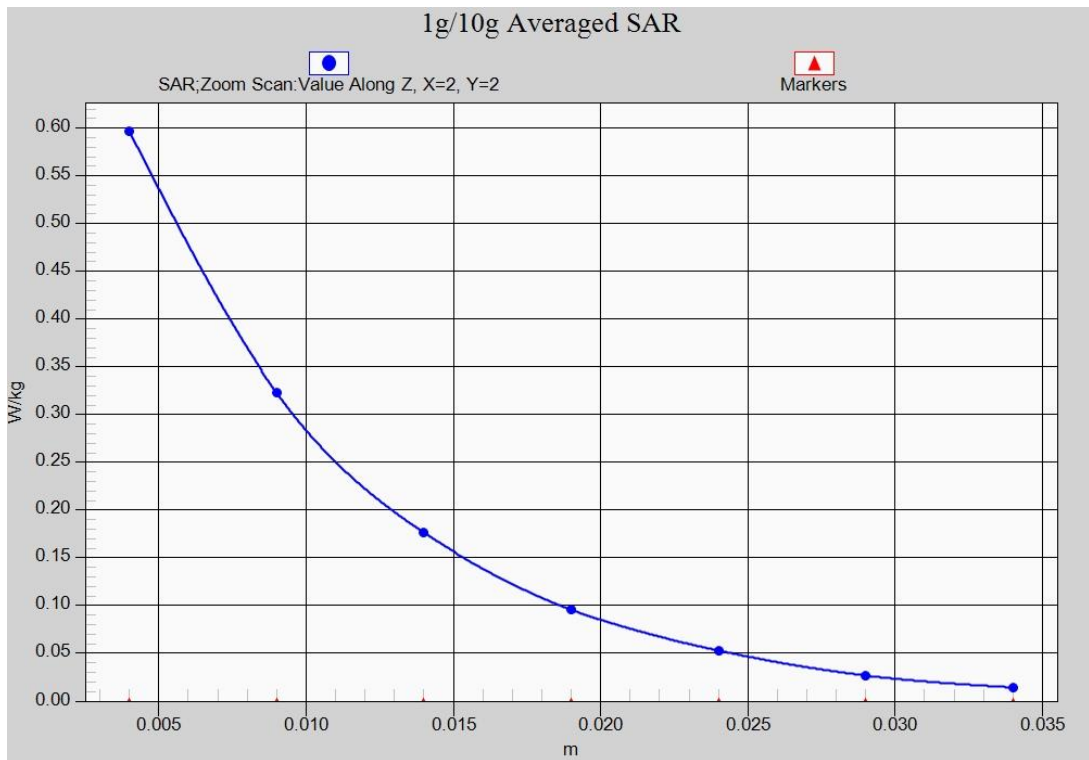

Fig.19-1 Z-Scan at power reference point (Wi-Fi 2.4G)

Wi-Fi2.4G 802.11b Body Rear Channel 11

Date/Time: 7/4/2017

Electronics: DAE4 Sn786

Medium: 2450 Body

Medium parameters used: $f = 2462$ MHz; $\sigma = 1.988$ S/m; $\epsilon_r = 53.386$; $\rho = 1000$ kg/m³

Ambient Temperature: 22.0°C Liquid Temperature: 21.5°C

Communication System: UID 0, WLAN 2.4G CE Frequency: 2462 MHz Duty Cycle: 1:1

Probe: EX3DV4 - SN3633 ConvF(7.37, 7.37, 7.37);

Rear Side/Area Scan (61x111x1): Interpolated grid: dx=1.500 mm, dy=1.500 mm

Maximum value of SAR (interpolated) = 0.169 W/kg

Rear Side/Zoom Scan (5x5x7)/Cube 0: Measurement grid: dx=8mm, dy=8mm, dz=5mm

Reference Value = 4.342 V/m; Power Drift = 0.16 dB

Peak SAR (extrapolated) = 0.319 W/kg

SAR(1 g) = 0.149 W/kg; SAR(10 g) = 0.073 W/kg

Maximum value of SAR (measured) = 0.164 W/kg

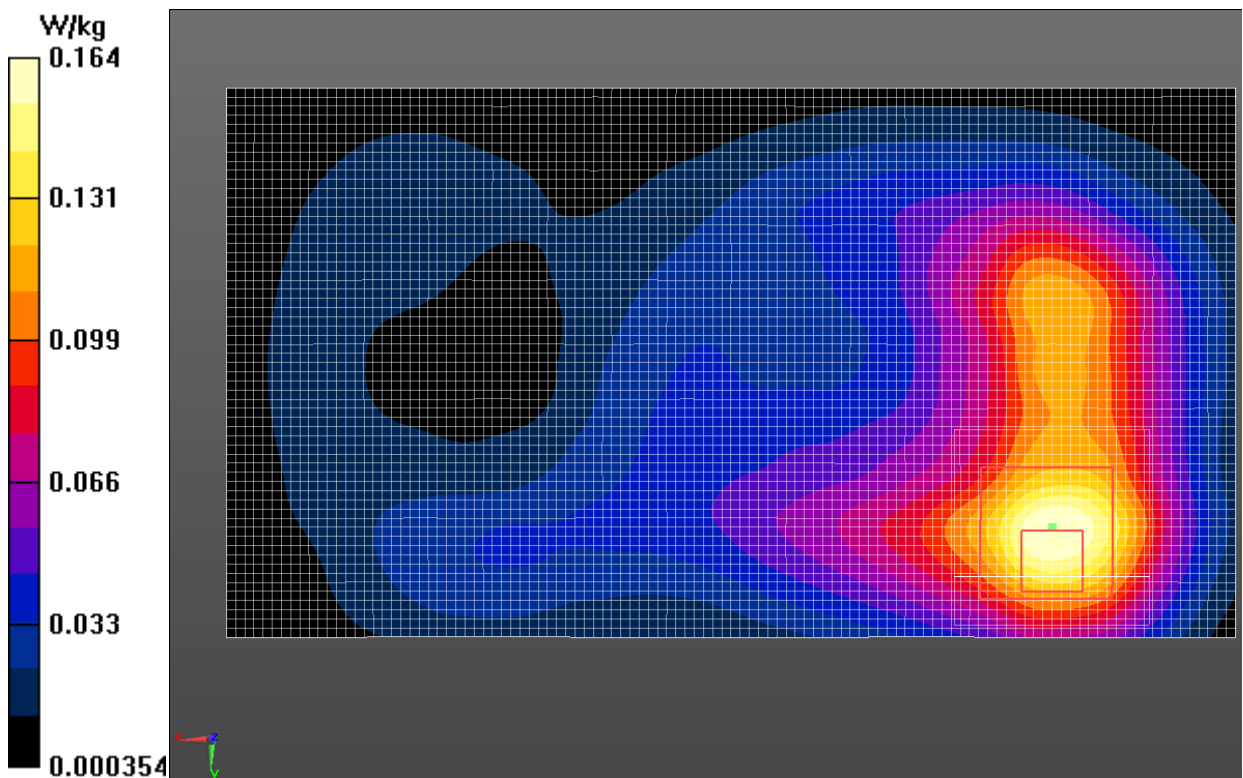

Fig.20 Wi-Fi 2.4G

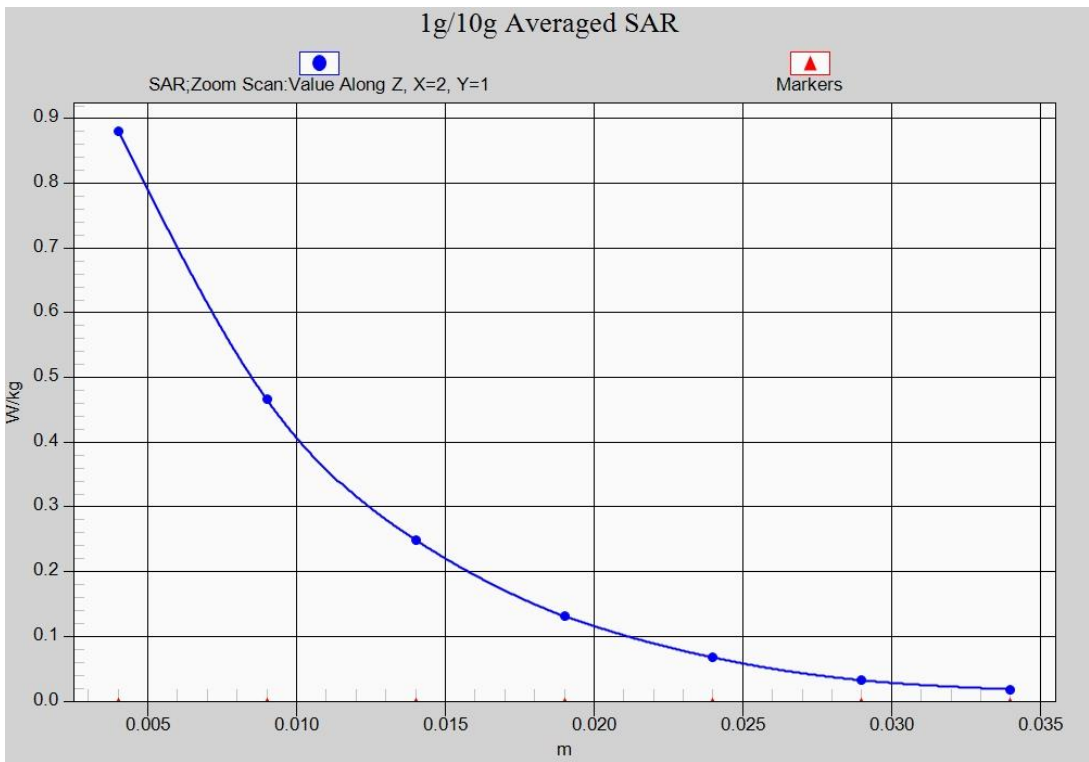

Fig.20-1 Z-Scan at power reference point (Wi-Fi 2.4G)

ANNEX B System Verification Results

835MHz

Date: 2017-6-27

Electronics: DAE4 Sn786

Medium: Head 835 MHz

Medium parameters used: $f = 835 \text{ MHz}$; $\sigma = 0.926 \text{ S/m}$; $\epsilon_r = 40.831$; $\rho = 1000 \text{ kg/m}^3$

Ambient Temperature: 22.9°C Liquid Temperature: 22.5°C

Communication System: CW Frequency: 835 MHz Duty Cycle: 1:1

Probe: EX3DV4 - SN3633 ConvF (8.88, 8.88, 8.88)

System Validation /Area Scan (81x161x1): Interpolated grid: $dx=1.000 \text{ mm}$, $dy=1.000 \text{ mm}$

Reference Value = 55.632 V/m ; Power Drift = 0.02 dB

Fast SAR: SAR(1 g) = 2.47 W/kg ; SAR(10 g) = 1.56 W/kg

Maximum value of SAR (interpolated) = 2.55 W/kg

System Validation /Zoom Scan (7x7x7)/Cube 0: Measurement grid: $dx=5\text{mm}$, $dy=5\text{mm}$, $dz=5\text{mm}$

Reference Value = 55.632 V/m ; Power Drift = 0.02 dB

Peak SAR (extrapolated) = 3.57 W/kg

SAR(1 g) = 2.35 W/kg ; SAR(10 g) = 1.53 W/kg

Maximum value of SAR (measured) = 2.49 W/kg

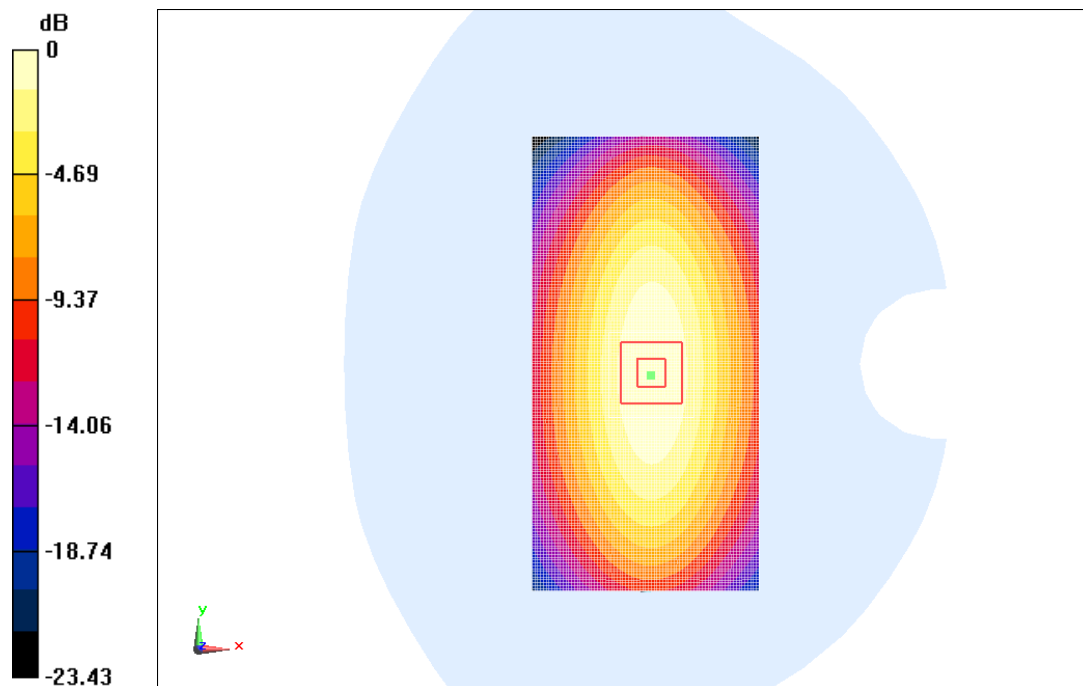

0 dB = 2.49 W/kg = 3.96 dBW/kg

Fig.B.1 validation 835MHz 250mW

835MHz

Date: 2017-6-27

Electronics: DAE4 Sn786

Medium: Body 835 MHz

Medium parameters used: $f = 835$ MHz; $\sigma = 0.997$ S/m; $\epsilon_r = 53.694$; $\rho = 1000$ kg/m³

Ambient Temperature: 22.9°C Liquid Temperature: 22.5°C

Communication System: CW Frequency: 835 MHz Duty Cycle: 1:1

Probe: EX3DV4 - SN3633 ConvF (9.24, 9.24, 9.24)

System Validation /Area Scan (81x171x1): Interpolated grid: dx=1.000 mm, dy=1.000 mm

Reference Value = 53.284 V/m; Power Drift = 0.04 dB

Fast SAR: SAR(1 g) = 2.41 W/kg; SAR(10 g) = 1.58 W/kg

Maximum value of SAR (interpolated) = 2.58 W/kg

System Validation /Zoom Scan (7x7x7)/Cube 0: Measurement grid: dx=5mm, dy=5mm, dz=5mm

Reference Value = 53.284 V/m; Power Drift = 0.04 dB

Peak SAR (extrapolated) = 3.35 W/kg

SAR(1 g) = 2.39 W/kg; SAR(10 g) = 1.57 W/kg

Maximum value of SAR (measured) = 2.52 W/kg

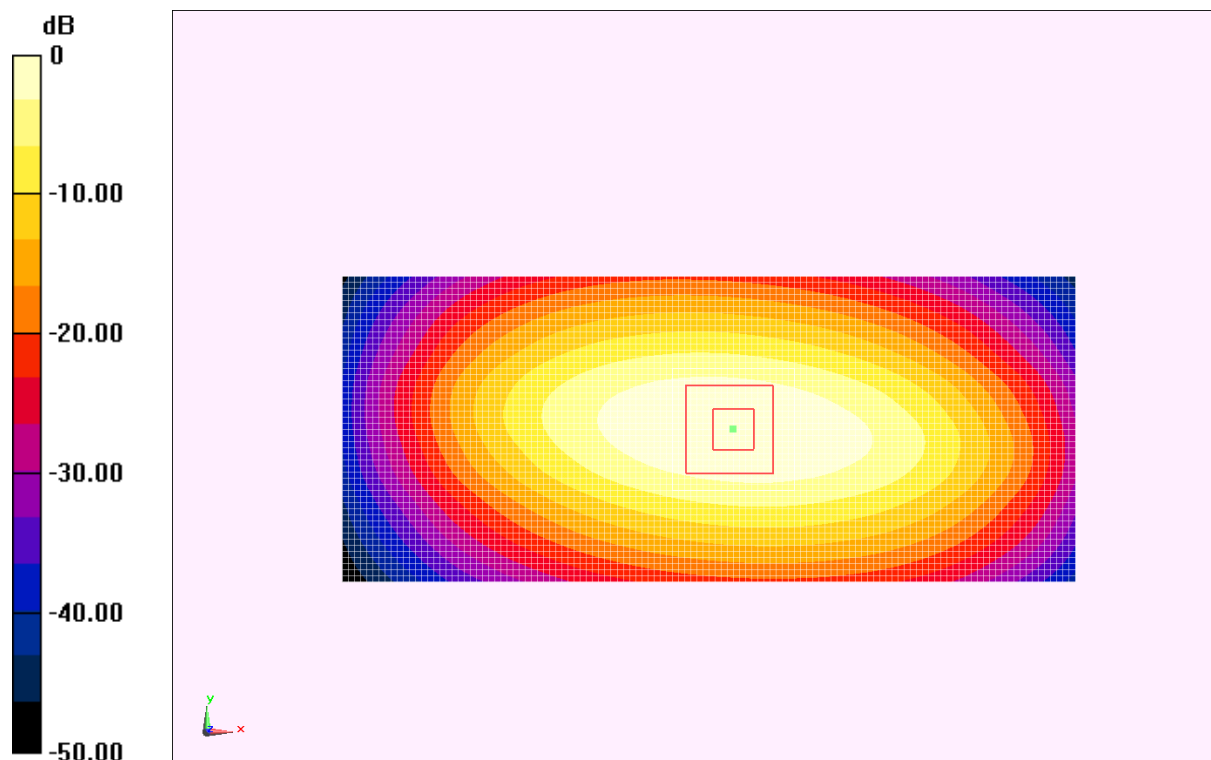

0 dB = 2.52 W/kg = 4.01 dBW/kg

Fig.B.2 validation 835MHz 250mW

1800MHz

Date/Time: 2017-6-30

Electronics: DAE4 Sn786

Medium: Head 1800 MHz

Medium parameters used: $f = 1800 \text{ MHz}$; $\sigma = 1.378 \text{ S/m}$; $\epsilon_r = 39.47$; $\rho = 1000 \text{ kg/m}^3$

Ambient Temperature: 22.0°C Liquid Temperature: 21.5°C

Communication System: CW Frequency: 1800 MHz Duty Cycle: 1:1

Probe: EX3DV4 - SN3633 ConvF (8.08, 8.08, 8.08)

System Validation/Area Scan (61x121x1): Interpolated grid: $dx=1.000 \text{ mm}$, $dy=1.000 \text{ mm}$

Reference Value = 78.214 V/m ; Power Drift = 0.08 dB

Fast SAR: SAR(1 g) = 9.59 W/kg ; SAR(10 g) = 5.17 W/kg

Maximum value of SAR (interpolated) = 11.8 W/kg

System Validation/Zoom Scan (7x7x7)/Cube 0: Measurement grid: $dx=5\text{mm}$, $dy=5\text{mm}$, $dz=5\text{mm}$

Reference Value = 78.214 V/m ; Power Drift = 0.08 dB

Peak SAR (extrapolated) = 18.2 W/kg

SAR(1 g) = 9.58 W/kg ; SAR(10 g) = 5.10 W/kg

Maximum value of SAR (measured) = 11.3 W/kg

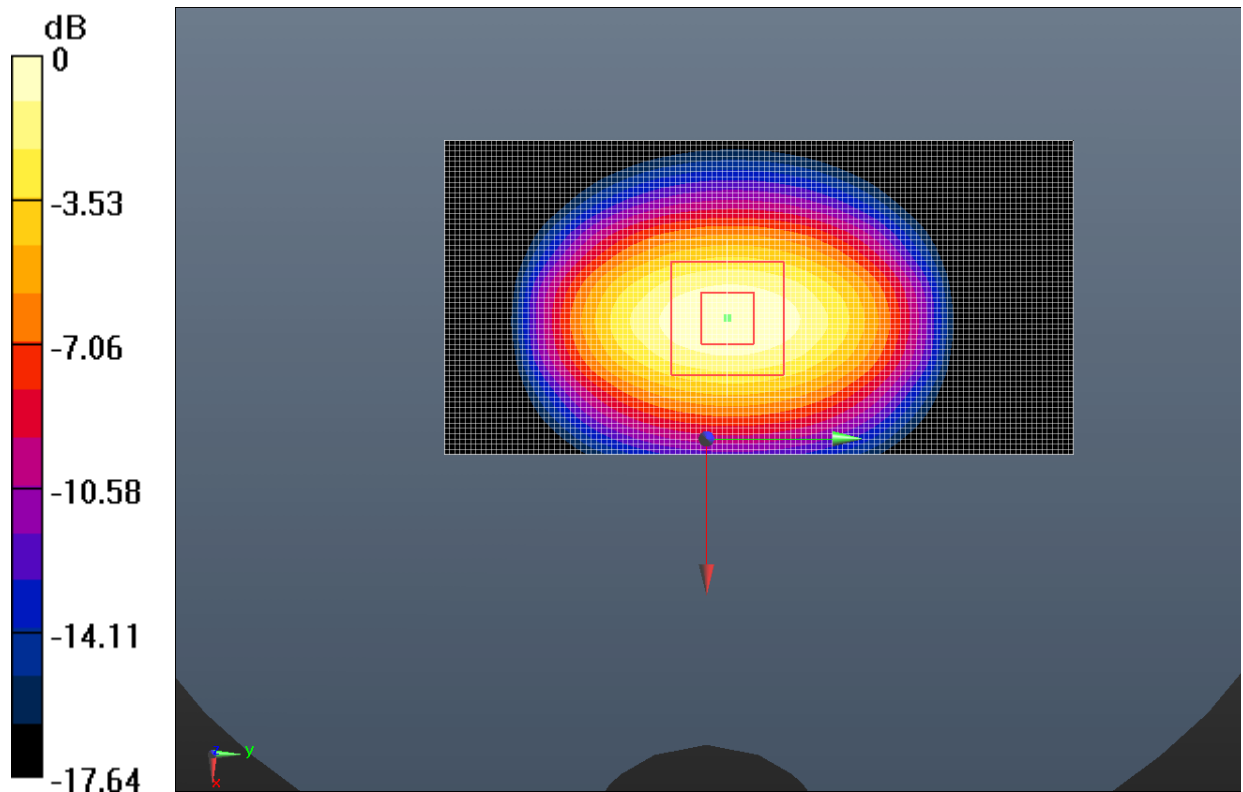

0 dB = 11.3 W/kg = 10.53 dBW/kg

Fig.B.3 validation 1800MHz 250mW

1800MHz

Date/Time: 2017-6-30

Electronics: DAE4 Sn786

Medium: Body 1800 MHz

Medium parameters used: $f = 1800 \text{ MHz}$; $\sigma = 1.497 \text{ S/m}$; $\epsilon_r = 53.211$; $\rho = 1000 \text{ kg/m}^3$

Ambient Temperature: 22.0°C Liquid Temperature: 21.5°C

Communication System: CW Frequency: 1800 MHz Duty Cycle: 1:1

Probe: ES3DV3 - SN3151 ConvF (7.90, 7.90, 7.90);

System Validation/Area Scan (61x121x1): Interpolated grid: $dx=1.000 \text{ mm}$, $dy=1.000 \text{ mm}$

Reference Value = 77.854 V/m ; Power Drift = -0.11 dB

Fast SAR: SAR(1 g) = 9.88 W/kg ; SAR(10 g) = 5.23 W/kg

Maximum value of SAR (interpolated) = 12.6 W/kg

System Validation/Zoom Scan (7x7x7)/Cube 0: Measurement grid: $dx=5\text{mm}$, $dy=5\text{mm}$, $dz=5\text{mm}$

Reference Value = 77.854 V/m ; Power Drift = -0.11 dB

Peak SAR (extrapolated) = 17.4 W/kg

SAR(1 g) = 9.77 W/kg ; SAR(10 g) = 5.21 W/kg

Maximum value of SAR (measured) = 12.4 W/kg

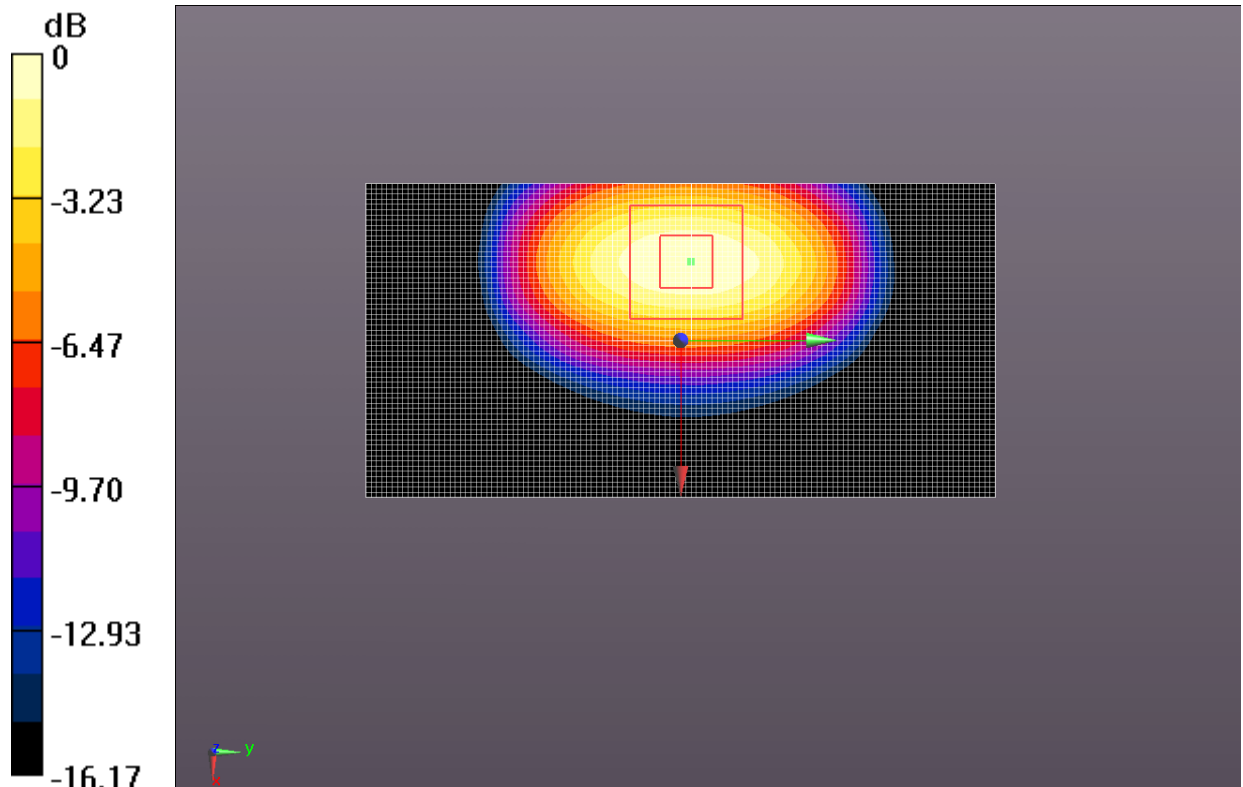

0 dB = 12.4 W/kg = 10.93 dBW/kg

Fig.B.3 validation 1800MHz 250mW

1900MHz

Date: 2017-7-2

Electronics: DAE4 Sn786

Medium: Head 1900 MHz

Medium parameters used: $f = 1900 \text{ MHz}$; $\sigma = 1.416 \text{ S/m}$; $\epsilon_r = 39.233$; $\rho = 1000 \text{ kg/m}^3$

Ambient Temperature: 22.9°C Liquid Temperature: 22.5°C

Communication System: CW Frequency: 1900 MHz Duty Cycle: 1:1

Probe: EX3DV4 - SN3633 ConvF (8, 8, 8)

System Validation /Area Scan (81x121x1): Interpolated grid: $dx=1.000 \text{ mm}$, $dy=1.000 \text{ mm}$

Reference Value = 93.455 V/m ; Power Drift = -0.09 dB

Fast SAR: SAR(1 g) = 10.41 W/kg ; SAR(10 g) = 5.33 W/kg

Maximum value of SAR (interpolated) = 12.5 W/kg

System Validation /Zoom Scan (7x7x7)/Cube 0: Measurement grid: $dx=5\text{mm}$, $dy=5\text{mm}$, $dz=5\text{mm}$

Reference Value = 93.455 V/m ; Power Drift = -0.09 dB

Peak SAR (extrapolated) = 18.6 W/kg

SAR(1 g) = 10.35 W/kg ; SAR(10 g) = 5.32 W/kg

Maximum value of SAR (measured) = 12.2 W/kg

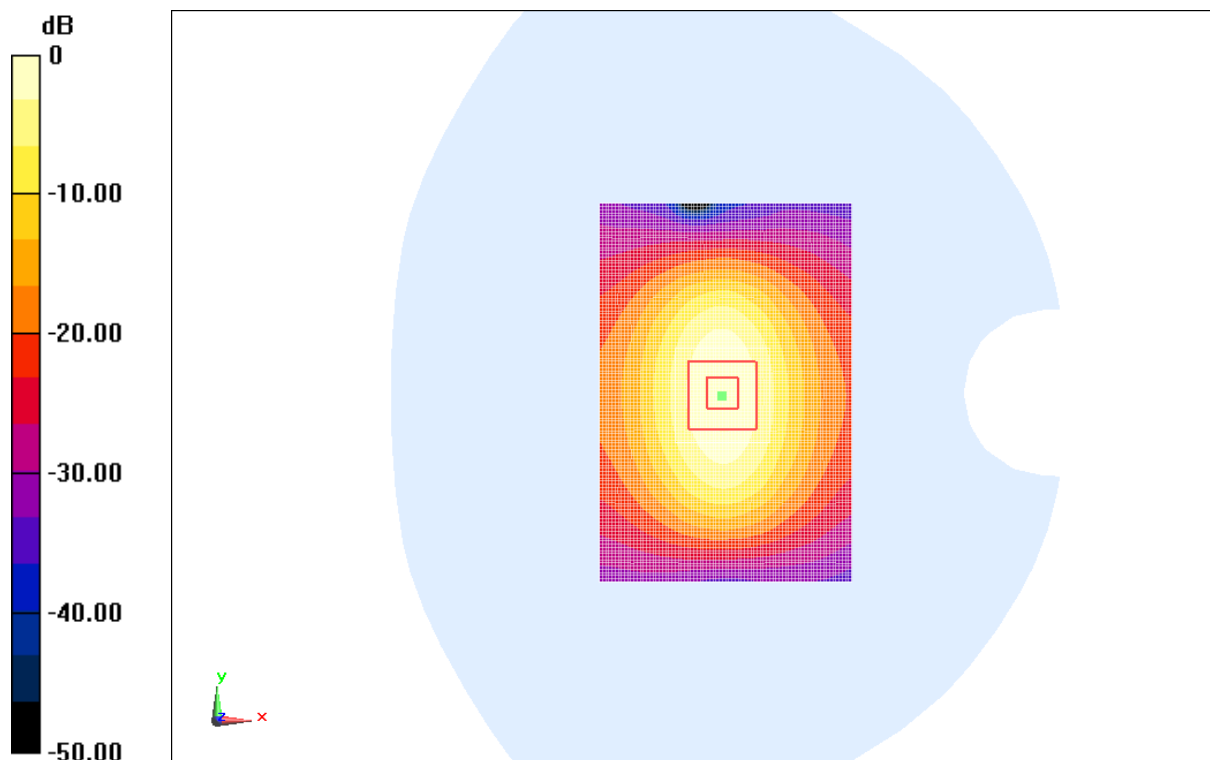

0 dB = 12.2 W/kg = 10.86 dBW/kg

Fig.B.3 validation 1900MHz 250mW

1900MHz

Date: 2017-7-2

Electronics: DAE4 Sn786

Medium: Body 1900 MHz

Medium parameters used: $f = 1900$ MHz; $\sigma = 1.544$ S/m; $\epsilon_r = 52.87$; $\rho = 1000$ kg/m³

Ambient Temperature: 22.9°C Liquid Temperature: 22.5°C

Communication System: CW Frequency: 1900 MHz Duty Cycle: 1:1

Probe: EX3DV4 - SN3633 ConvF (7.55, 7.55, 7.55)

System validation /Area Scan (81x121x1): Interpolated grid: dx=1.000 mm, dy=1.000 mm

Reference Value = 62.745 V/m; Power Drift = -0.02 dB

Fast SAR: SAR(1 g) = 10.67 W/kg; SAR(10 g) = 5.52W/kg

Maximum value of SAR (interpolated) = 12.8 W/kg

System validation /Zoom Scan (7x7x7)/Cube 0: Measurement grid: dx=5mm, dy=5mm, dz=5mm

Reference Value = 62.745 V/m; Power Drift = -0.02 dB

Peak SAR (extrapolated) = 19.6 W/kg

SAR(1 g) = 10.59 W/kg; SAR(10 g) = 5.44W/kg

Maximum value of SAR (measured) = 12.4 W/kg

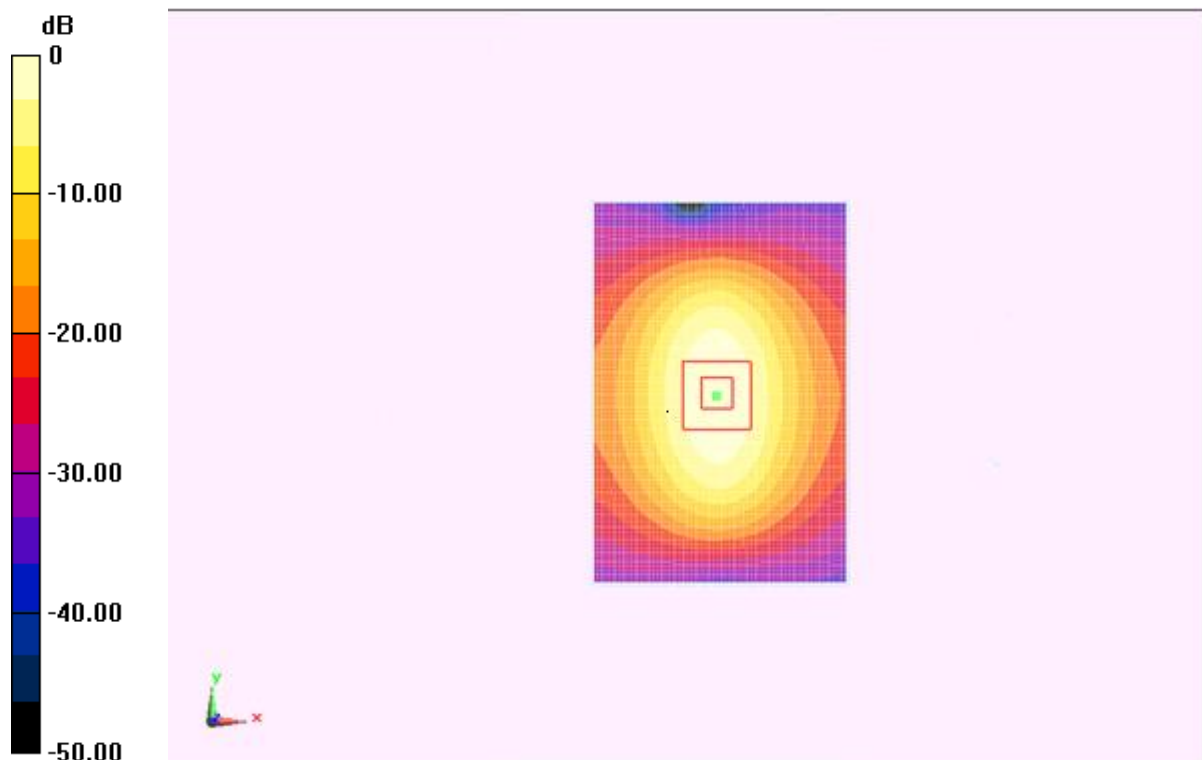

0 dB = 12.4 W/kg = 10.93 dBW/kg

Fig.B.3 validation 1900MHz 250mW

2450MHz

Date: 2017-7-4

Electronics: DAE4 Sn786

Medium: Head 2450 MHz

Medium parameters used: $f = 2450$ MHz; $\sigma = 1.826$ S/m; $\epsilon_r = 38.564$; $\rho = 1000$ kg/m³

Ambient Temperature: 22.0°C Liquid Temperature: 21.6°C

Communication System: CW Frequency: 2450 MHz Duty Cycle: 1:1

Probe: EX3DV4 - SN3633 ConvF (7.4, 7.4, 7.4)

System Validation /Area Scan (61x81x1): Interpolated grid: dx=1.000 mm, dy=1.000 mm

Reference Value = 86.552 V/m; Power Drift = 0.03 dB

Fast SAR: SAR(1 g) = 13.43 W/kg; SAR(10 g) = 6.14 W/kg

Maximum value of SAR (interpolated) = 16.7 W/kg

System Validation /Zoom Scan (7x7x7)/Cube 0: Measurement grid: dx=5mm, dy=5mm, dz=5mm

Reference Value = 86.552 V/m; Power Drift = 0.03 dB

Peak SAR (extrapolated) = 25.3 W/kg

SAR(1 g) = 13.28 W/kg; SAR(10 g) = 6.10W/kg

Maximum value of SAR (measured) = 15.9 W/kg

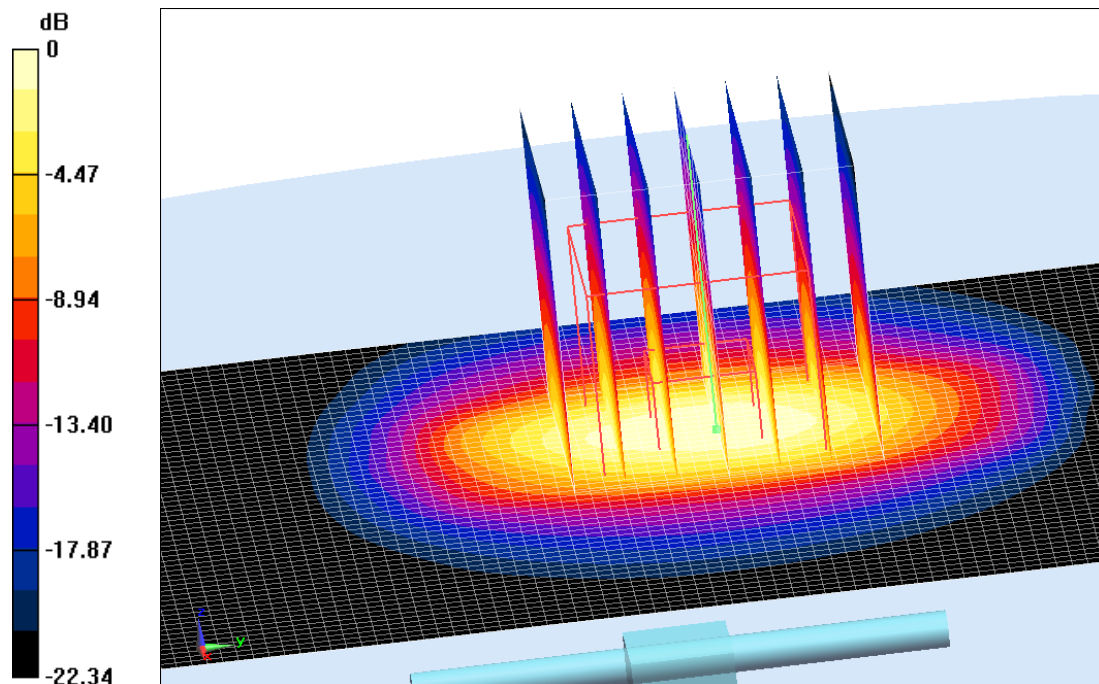

0 dB = 15.9 W/kg = 12.01 dBW/kg

Fig.B.5 validation 2450MHz 250mW

2450MHz

Date: 2017-7-4

Electronics: DAE4 Sn786

Medium: Body 2450 MHz

Medium parameters used: $f = 2450$ MHz; $\sigma = 1.979$ S/m; $\epsilon_r = 53.422$; $\rho = 1000$ kg/m³

Ambient Temperature: 22.0°C Liquid Temperature: 21.6°C

Communication System: CW Frequency: 2450 MHz Duty Cycle: 1:1

Probe: EX3DV4 - SN3633 ConvF (7.37, 7.37, 7.37)

System Validation/Area Scan (81x101x1): Interpolated grid: dx=1.000 mm, dy=1.000 mm

Reference Value = 88.417 V/m; Power Drift = -0.01 dB

Fast SAR: SAR(1 g) = 13.41 W/kg; SAR(10 g) = 6.18 W/kg

Maximum value of SAR (interpolated) = 15.4 W/kg

System Validation/Zoom Scan (7x7x7)/Cube 0: Measurement grid: dx=5mm, dy=5mm, dz=5mm

Reference Value = 88.417 V/m; Power Drift = -0.01 dB

Peak SAR (extrapolated) = 28.2 W/kg

SAR(1 g) = 13.32 W/kg; SAR(10 g) = 6.16 W/kg

Maximum value of SAR (measured) = 14.9 W/kg

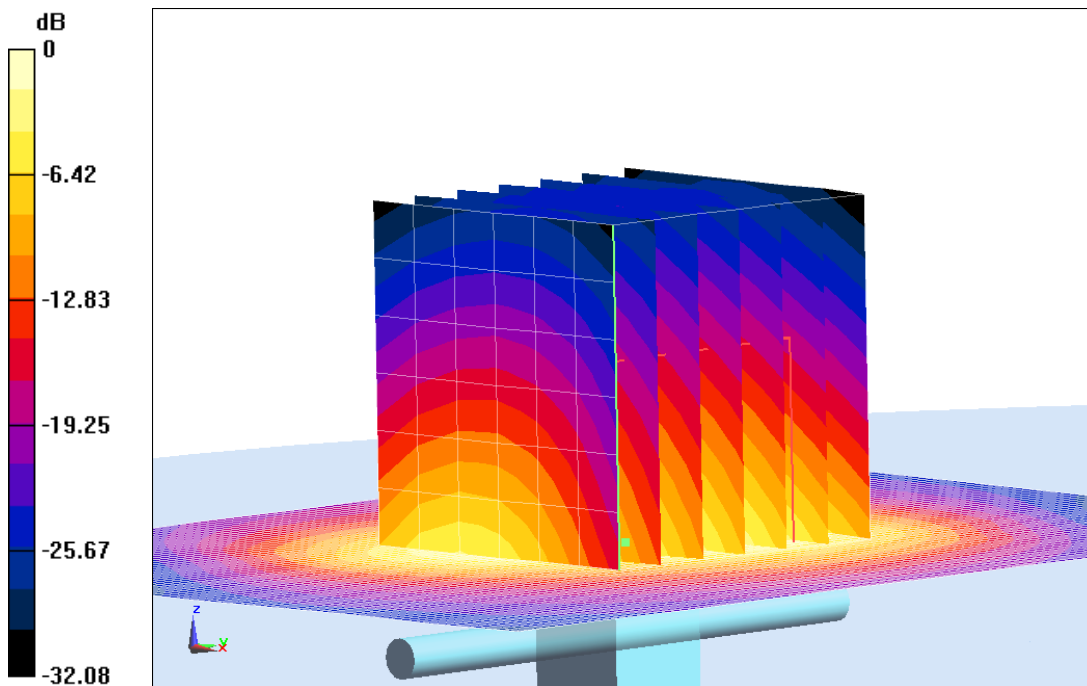

0 dB = 14.9 W/kg = 11.73 dB W/kg

Fig.B.6 validation 2450MHz 250mW

2550MHz

Date: 2017-7-8

Electronics: DAE4 Sn786

Medium: Head 2550 MHz

Medium parameters used: $f = 2550 \text{ MHz}$; $\sigma = 1.937 \text{ S/m}$; $\epsilon_r = 38.452$; $\rho = 1000 \text{ kg/m}^3$

Ambient Temperature: 22.0°C Liquid Temperature: 21.6°C

Communication System: CW Frequency: 2550 MHz Duty Cycle: 1:1

Probe: EX3DV4 - SN3633 ConvF (7.27, 7.27, 7.27)

System Validation /Area Scan (61x81x1): Interpolated grid: $dx=1.000 \text{ mm}$, $dy=1.000 \text{ mm}$

Reference Value = 85.424 V/m ; Power Drift = -0.04 dB

Fast SAR: SAR(1 g) = 14.9 W/kg ; SAR(10 g) = 6.62 W/kg

Maximum value of SAR (interpolated) = 17.5 W/kg

System Validation /Zoom Scan (7x7x7)/Cube 0: Measurement grid: $dx=5\text{mm}$, $dy=5\text{mm}$, $dz=5\text{mm}$

Reference Value = 85.424 V/m ; Power Drift = -0.04 dB

Peak SAR (extrapolated) = 29.6 W/kg

SAR(1 g) = 14.7 W/kg ; SAR(10 g) = 6.59 W/kg

Maximum value of SAR (measured) = 16.8 W/kg

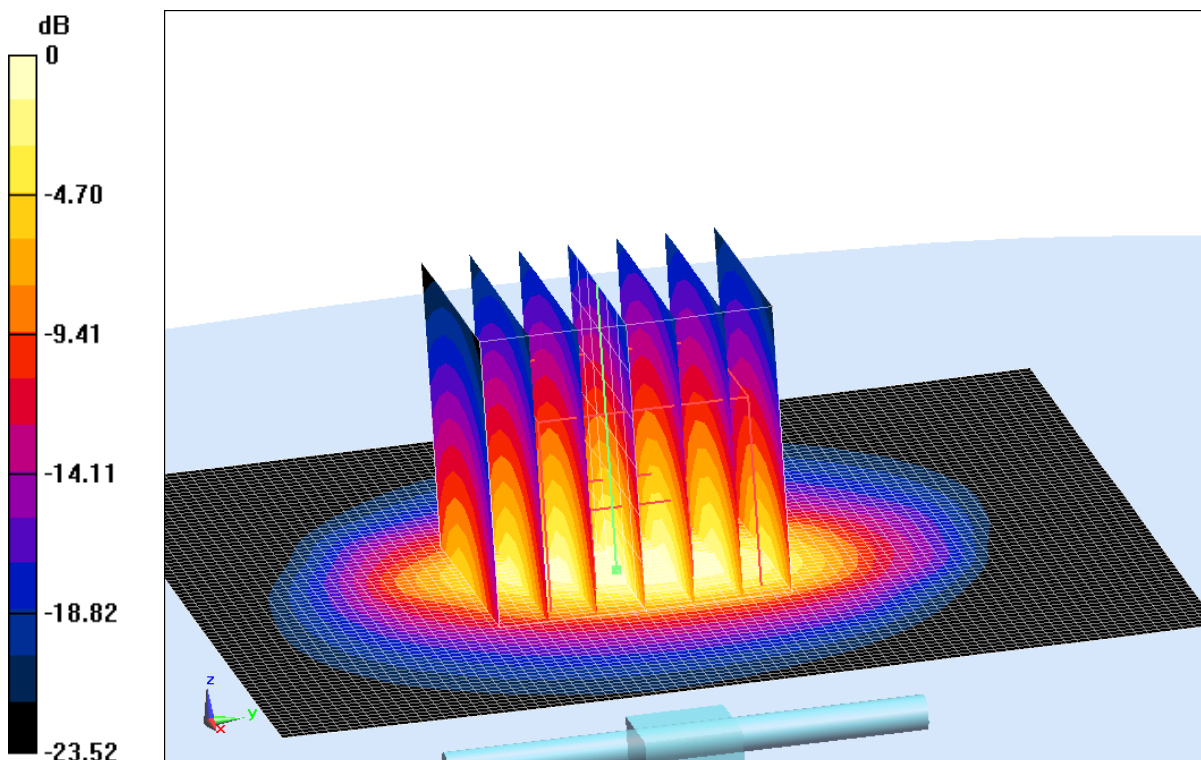

0 dB = 16.8 W/kg = 12.25 dBW/kg

Fig.B.7 validation 2550MHz 250mW

2550MHz

Date: 2017-7-8

Electronics: DAE4 Sn786

Medium: Body 2550 MHz

Medium parameters used: $f = 2450$ MHz; $\sigma = 2.117$ S/m; $\epsilon_r = 53.340$; $\rho = 1000$ kg/m³

Ambient Temperature: 22.0°C Liquid Temperature: 21.6°C

Communication System: CW Frequency: 2550 MHz Duty Cycle: 1:1

Probe: EX3DV4 - SN3633 ConvF (7.24, 7.24, 7.24)

System Validation/Area Scan (81x101x1): Interpolated grid: dx=1.000 mm, dy=1.000 mm

Reference Value = 85.427 V/m; Power Drift = 0.07 dB

Fast SAR:SAR(1 g) = 13.4 W/kg; SAR(10 g) = 6.16 W/kg

Maximum value of SAR (interpolated) = 16.4 W/kg

System Validation/Zoom Scan (7x7x7)/Cube 0: Measurement grid: dx=5mm, dy=5mm, dz=5mm

Reference Value = 85.427 V/m; Power Drift = 0.07 dB

Peak SAR (extrapolated) = 27.7 W/kg

SAR(1 g) = 13.19 W/kg; SAR(10 g) = 6.182 W/kg

Maximum value of SAR (measured) = 15.7 W/kg

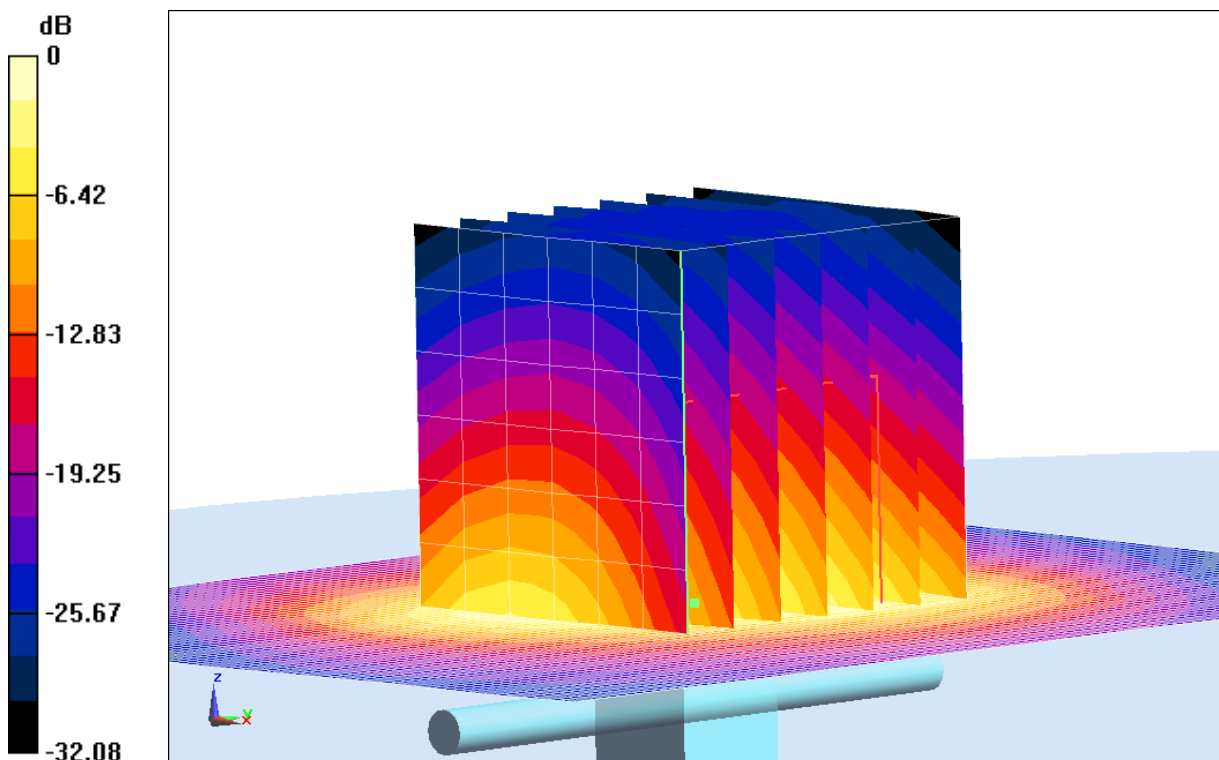

0 dB = 15.7 W/kg = 11.96 dB W/kg

Fig.B.8 validation 2550MHz 250mW

ANNEX C SAR Measurement Setup

C.1 Measurement Set-up

DASY5 system for performing compliance tests is illustrated above graphically. This system consists of the following items:

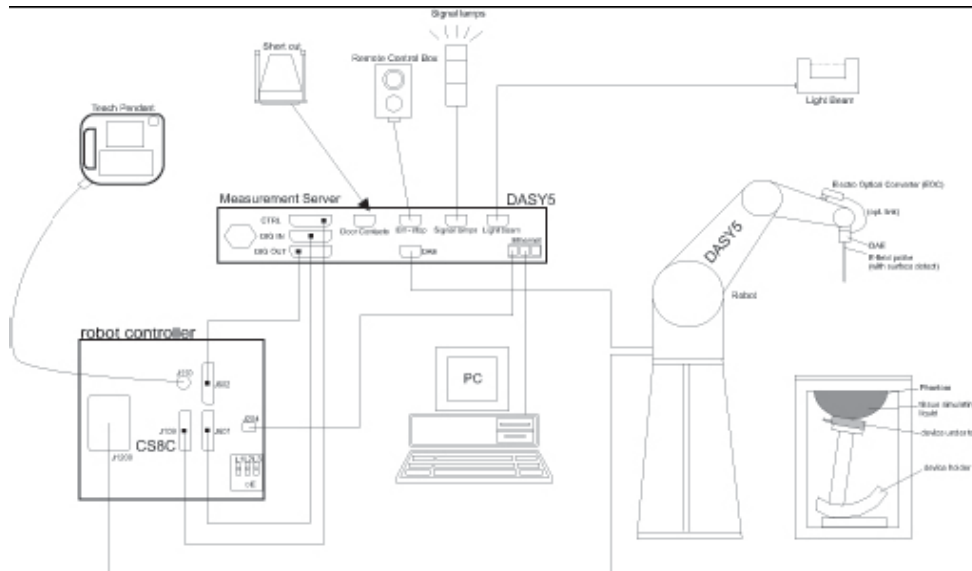

Picture C.1 SAR Lab Test Measurement Set-up

- A standard high precision 6-axis robot (Stäubli TX=RX family) with controller, teach pendant and software. An arm extension for accommodating the data acquisition electronics (DAE).
- An isotropic field probe optimized and calibrated for the targeted measurement.
- A data acquisition electronics (DAE) which performs the signal amplification, signal multiplexing, AD-conversion, offset measurements, mechanical surface detection, collision detection, etc. The unit is battery powered with standard or rechargeable batteries. The signal is optically transmitted to the EOC.
- The Electro-optical converter (EOC) performs the conversion from optical to electrical signals for the digital communication to the DAE. To use optical surface detection, a special version of the EOC is required. The EOC signal is transmitted to the measurement server.
- The function of the measurement server is to perform the time critical tasks such as signal filtering, control of the robot operation and fast movement interrupts.
- The Light Beam used is for probe alignment. This improves the (absolute) accuracy of the probe positioning.
- A computer running WinXP and the DASY5 software.
- Remote control and teach pendant as well as additional circuitry for robot safety such as
- warning lamps, etc.
- The phantom, the device holder and other accessories according to the targeted measurement.

C.2 DASY5 E-field Probe System

The SAR measurements were conducted with the dosimetric probe designed in the classical triangular configuration and optimized for dosimetric evaluation. The probe is constructed using the thick film technique; with printed resistive lines on ceramic substrates. The probe is equipped with an optical multifiber line ending at the front of the probe tip. It is connected to the EOC box on the robot arm and provides an automatic detection of the phantom surface. Half of the fibers are connected to a pulsed infrared transmitter, the other half to a synchronized receiver. As the probe approaches the surface, the reflection from the surface produces a coupling from the transmitting to the receiving fibers. This reflection increases first during the approach, reaches maximum and then decreases. If the probe is flatly touching the surface, the coupling is zero. The distance of the coupling maximum to the surface is independent of the surface reflectivity and largely independent of the surface to probe angle. The DASY5 software reads the reflection during a software approach and looks for the maximum using 2nd order curve fitting. The approach is stopped at reaching the maximum.

Probe Specifications:

Model:	ES3DV3, EX3DV4
Frequency	10MHz — 6.0GHz(EX3DV4)
Range:	10MHz — 4GHz(ES3DV3)
Calibration:	In head and body simulating tissue at Frequencies from 835 up to 5800MHz
Linearity:	± 0.2 dB(30 MHz to 6 GHz) for EX3DV4 ± 0.2 dB(30 MHz to 4 GHz) for ES3DV3
Dynamic Range:	10 mW/kg — 100W/kg
Probe Length:	330 mm
Probe Tip	
Length:	20 mm
Body Diameter:	12 mm
Tip Diameter:	2.5 mm (3.9 mm for ES3DV3)
Tip-Center:	1 mm (2.0mm for ES3DV3)
Application:	SAR Dosimetry Testing Compliance tests of mobile phones Dosimetry in strong gradient fields



Picture C.2 Near-field Probe



Picture C.3 E-field Probe

C.3 E-field Probe Calibration

Each E-Probe/Probe Amplifier combination has unique calibration parameters. A TEM cell calibration procedure is conducted to determine the proper amplifier settings to enter in the probe parameters. The amplifier settings are determined for a given frequency by subjecting the probe to a known E-field density (1 mW/cm^2) using an RF Signal generator, TEM cell, and RF Power Meter.

The free space E-field from amplified probe outputs is determined in a test chamber. This calibration can be performed in a TEM cell if the frequency is below 1 GHz and in a waveguide or other methodologies above 1 GHz for free space. For the free space calibration, the probe is placed

in the volumetric center of the cavity and at the proper orientation with the field. The probe is then rotated 360 degrees until the three channels show the maximum reading. The power density readings equates to 1 mW/ cm²:

E-field temperature correlation calibration is performed in a flat phantom filled with the appropriate simulated brain tissue. The E-field in the medium correlates with the temperature rise in the dielectric medium. For temperature correlation calibration a RF transparent thermistor-based temperature probe is used in conjunction with the E-field probe.

$$SAR = C \frac{\Delta T}{\Delta t}$$

Where:

Δt = Exposure time (30 seconds),

C = Heat capacity of tissue (brain or muscle),

ΔT = Temperature increase due to RF exposure.

$$SAR = \frac{|E|^2 \cdot \sigma}{\rho}$$

Where:

σ = Simulated tissue conductivity,

ρ = Tissue density (kg/m³).

C.4 Other Test Equipment

C.4.1 Data Acquisition Electronics (DAE)

The data acquisition electronics consist of a highly sensitive electrometer-grade preamplifier with auto-zeroing, a channel and gain-switching multiplexer, a fast 16 bit AD-converter and a command decoder with a control logic unit. Transmission to the measurement server is accomplished through an optical downlink for data and status information, as well as an optical uplink for commands and the clock.

The mechanical probe mounting device includes two different sensor systems for frontal and sideways probe contacts. They are used for mechanical surface detection and probe collision detection.

The input impedance of the DAE is 200 MOhm; the inputs are symmetrical and floating. Common mode rejection is above 80 dB.



PictureC.4: DAE

C.4.2 Robot

The SPEAG DASY system uses the high precision robots (DASY5: RX160L) type from Stäubli SA (France). For the 6-axis controller system, the robot controller version from Stäubli is used. The Stäubli robot series have many features that are important for our application:

- High precision (repeatability 0.02mm)
- High reliability (industrial design)
- Low maintenance costs (virtually maintenance free due to direct drive gears; no belt drives)
- Jerk-free straight movements (brushless synchron motors; no stepper motors)
- Low ELF interference (motor control fields shielded via the closed metallic construction shields)



Picture C.5 DASY 5

C.4.3 Measurement Server

The Measurement server is based on a PC/104 CPU board with CPU (DASY5: 400 MHz, Intel Celeron), chipdisk (DASY5:128MB), RAM (DASY5:128MB). The necessary circuits for communication with the DAE electronic box, as well as the 16 bit AD converter system for optical detection and digital I/O interface are contained on the DASY I/O board, which is directly connected to the PC/104 bus of the CPU board.

The measurement server performs all real-time data evaluation of field measurements and surface detection, controls robot movements and handles safety operation. The PC operating system cannot interfere with these time critical processes. All connections are supervised by a watchdog, and disconnection of any of the cables to the measurement server will automatically disarm the robot and disable all program-controlled robot movements. Furthermore, the measurement server is equipped with an expansion port which is reserved for future applications. Please note that this expansion port does not have a standardized pinout, and therefore only devices provided by SPEAG can be connected. Devices from any other supplier could seriously damage the measurement server.



Picture C.6 Server for DASY 5

C.4.4 Device Holder for Phantom

The SAR in the phantom is approximately inversely proportional to the square of the distance between the source and the liquid surface. For a source at 5mm distance, a positioning uncertainty of $\pm 0.5\text{mm}$ would produce a SAR uncertainty of $\pm 20\%$. Accurate device positioning is therefore crucial for accurate and repeatable measurements. The positions in which the devices must be measured are defined by the standards.

The DASY device holder is designed to cope with the different positions given in the standard. It has two scales for device rotation (with respect to the body axis) and device inclination (with respect to the line between the ear reference points). The rotation centers for both scales is the ear reference point (ERP). Thus the device needs no repositioning when changing the angles.

The DASY device holder is constructed of low-loss POM material having the following dielectric

parameters: relative permittivity $\epsilon = 3$ and loss tangent $\delta = 0.02$. The amount of dielectric material has been reduced in the closest vicinity of the device, since measurements have suggested that the influence of the clamp on the test results could thus be lowered.

<Laptop Extension Kit>

The extension is lightweight and made of POM, acrylic glass and foam. It fits easily on the upper part of the Mounting Device in place of the phone positioner. The extension is fully compatible with the Twin-SAM and ELI phantoms.



Picture C.7-1: Device Holder

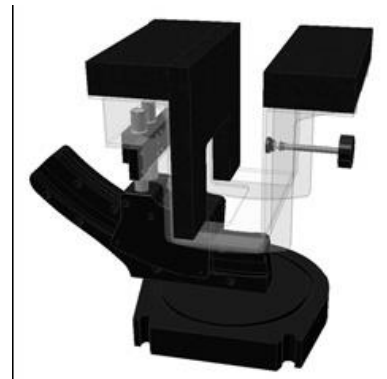

Picture C.7-2: Laptop Extension Kit

C.4.5 Phantom

The SAM Twin Phantom V4.0 is constructed of a fiberglass shell integrated in a table. The shape of the shell is based on data from an anatomical study designed to

Represent the 90th percentile of the population. The phantom enables the dissymmetric evaluation of SAR for both left and right handed handset usage, as well as body-worn usage using the flat phantom region. Reference markings on the Phantom allow the complete setup of all predefined phantom positions and measurement grids by manually teaching three points in the robot. The shell phantom has a 2mm shell thickness (except the ear region where shell thickness increases to 6 mm).

Shell Thickness: 2 ± 0.2 mm
Filling Volume: Approx. 25 liters
Dimensions: 810 x 1000 x 500 mm (H x L x W)
Available: Special



Picture C.8: SAM Twin Phantom

ANNEX D Position of the wireless device in relation to the phantom

D.1 General considerations

This standard specifies two handset test positions against the head phantom – the “cheek” position and the “tilt” position.

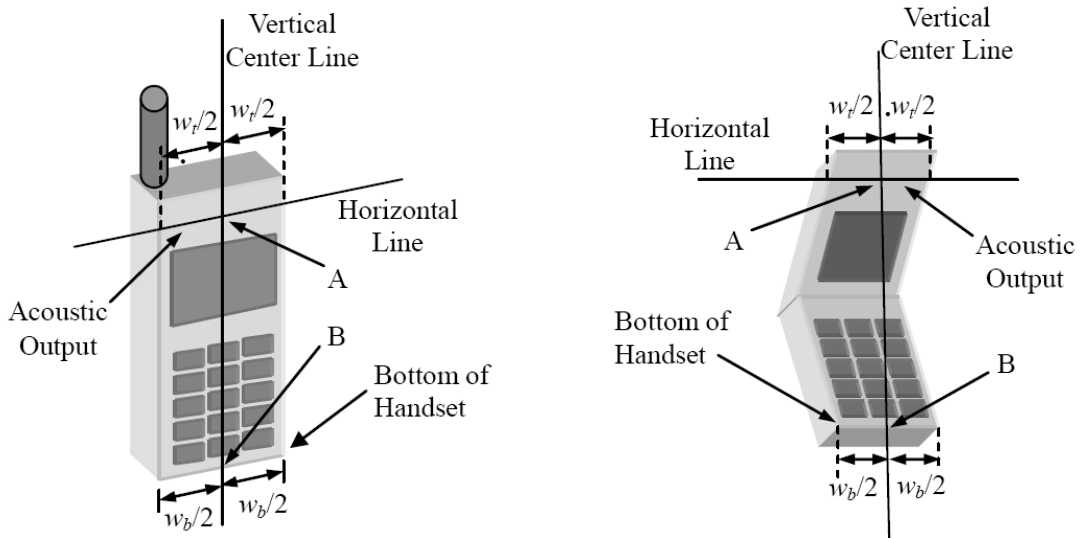

- w_t Width of the handset at the level of the acoustic
- w_b Width of the bottom of the handset
- A Midpoint of the width w_t of the handset at the level of the acoustic output
- B Midpoint of the width w_b of the bottom of the handset

Picture D.1-a Typical “fixed” case handset Picture D.1-b Typical “clam-shell” case handset

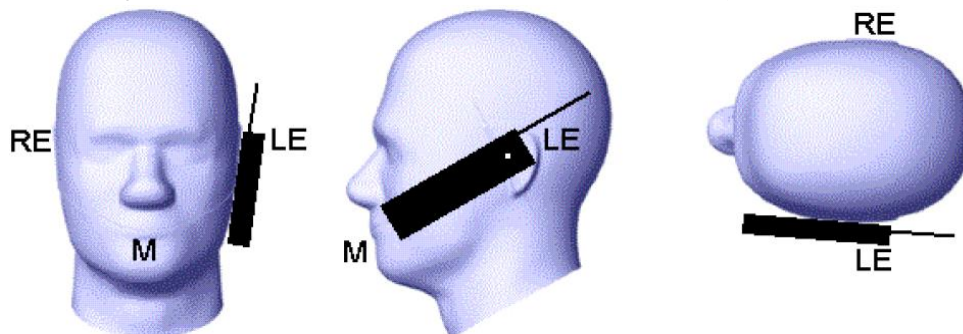

Picture D.2 Cheek position of the wireless device on the left side of SAM

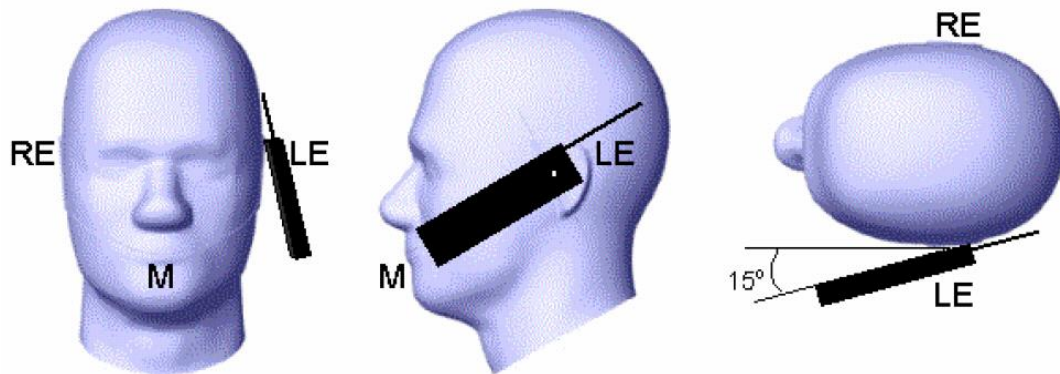

Picture D.3 Tilt position of the wireless device on the left side of SAM

D.2 Body-worn device

A typical example of a body-worn device is a mobile phone, wireless enabled PDA or other battery operated wireless device with the ability to transmit while mounted on a person's body using a carry accessory approved by the wireless device manufacturer.

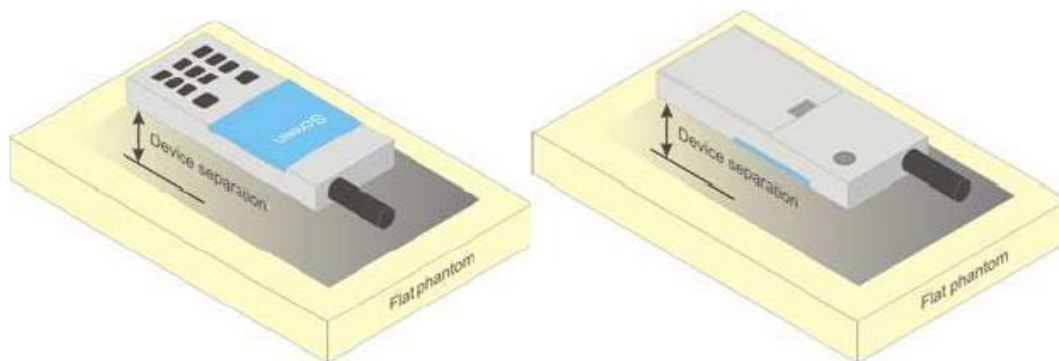

Picture D.4 Test positions for body-worn devices

D.3 Desktop device

A typical example of a desktop device is a wireless enabled desktop computer placed on a table or desk when used.

The DUT shall be positioned at the distance and in the orientation to the phantom that corresponds to the intended use as specified by the manufacturer in the user instructions. For devices that employ an external antenna with variable positions, tests shall be performed for all antenna positions specified. Picture 8.5 show positions for desktop device SAR tests. If the intended use is not specified, the device shall be tested directly against the flat phantom.

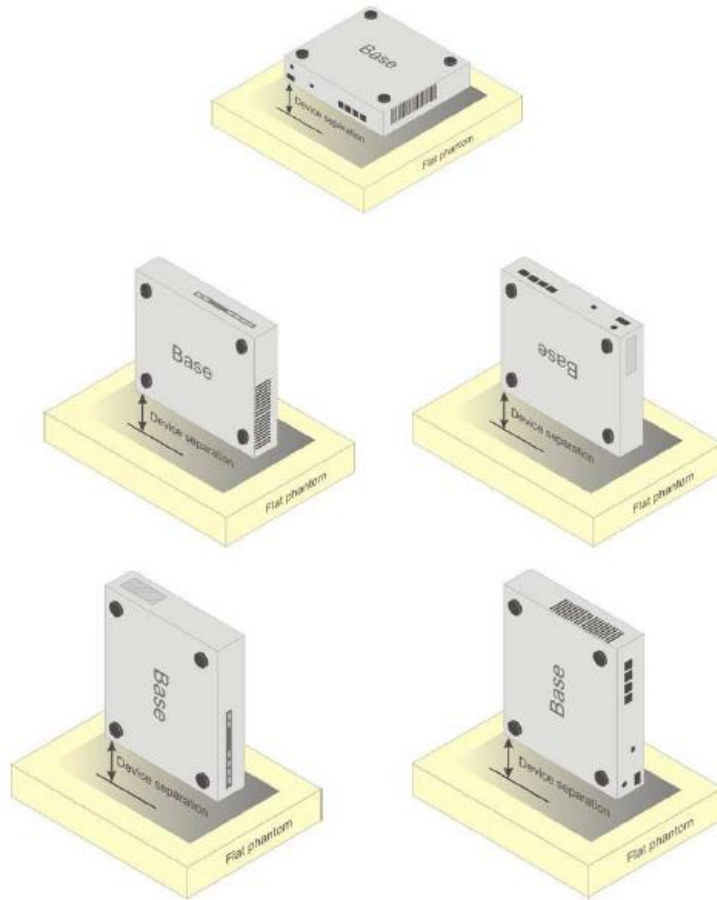

Picture D.5 Test positions for desktop devices

D.4 DUT Setup Photos



Picture D.6

ANNEX E Equivalent Media Recipes

The liquid used for the frequency range of 700-6000 MHz consisted of water, sugar, salt, preventol, glycol monobutyl and Cellulose. The liquid has been previously proven to be suited for worst-case. The Table E.1 shows the detail solution. It's satisfying the latest tissue dielectric parameters requirements proposed by the IEEE 1528 and IEC 62209.

Table E.1: Composition of the Tissue Equivalent Matter

Frequency (MHz)	835 Head	835 Body	1900 Head	1900 Body	2450 Head	2450 Body	5800 Head	5800 Body
Ingredients (% by weight)								
Water	41.45	52.5	55.242	69.91	58.79	72.60	65.53	65.53
Sugar	56.0	45.0	\	\	\	\	\	\
Salt	1.45	1.4	0.306	0.13	0.06	0.18	\	\
Preventol	0.1	0.1	\	\	\	\	\	\
Cellulose	1.0	1.0	\	\	\	\	\	\
Glycol Monobutyl	\	\	44.452	29.96	41.15	27.22	\	\
Diethylenglycol monohexylether	\	\	\	\	\	\	17.24	17.24
Triton X-100	\	\	\	\	\	\	17.24	17.24
Dielectric Parameters Target Value	$\epsilon=41.5$ $\sigma=0.90$	$\epsilon=55.2$ $\sigma=0.97$	$\epsilon=40.0$ $\sigma=1.40$	$\epsilon=53.3$ $\sigma=1.52$	$\epsilon=39.2$ $\sigma=1.80$	$\epsilon=52.7$ $\sigma=1.95$	$\epsilon=35.3$ $\sigma=5.27$	$\epsilon=48.2$ $\sigma=6.00$

Note: There is a little adjustment respectively for 750, 1800 and 2600, based on the recipe of closest frequency in table E.1

ANNEX F System Validation

The SAR system must be validated against its performance specifications before it is deployed. When SAR probes, system components or software are changed, upgraded or recalibrated, these must be validated with the SAR system(s) that operates with such components.

Table F.1: System Validation

3633	Head 835MHz	2017-6-27	835 MHz	OK
3633	Head 1800MHz	2017-6-30	1800 MHz	OK
3633	Head 1900MHz	2017-7-2	1900 MHz	OK
3633	Head 2450MHz	2017-7-4	2450 MHz	OK
3633	Head 2550MHz	2017-7-8	2550 MHz	OK
3633	Body 835MHz	2017-6-27	835 MHz	OK
3633	Body 1800MHz	2017-6-30	1800 MHz	OK
3633	Body 1900MHz	2017-7-2	1900 MHz	OK
3633	Body 2450MHz	2017-7-4	2450 MHz	OK
3633	Body 2550MHz	2017-7-8	2550 MHz	OK

ANNEX G DAE Calibration Certificate

DAE4 SN:786 Calibration Certificate

Calibration Laboratory of
Schmid & Partner
Engineering AG
Zeughausstrasse 43, 8004 Zurich, Switzerland



S Schweizerischer Kalibrierdienst
C Service suisse d'étalonnage
S Servizio svizzero di taratura
S Swiss Calibration Service

Accredited by the Swiss Accreditation Service (SAS)
The Swiss Accreditation Service is one of the signatories to the EA
Multilateral Agreement for the recognition of calibration certificates

Accreditation No.: **SCS 0108**

Client **CTTL (Auden)**

Certificate No: **DAE4-786_Dec16**

CALIBRATION CERTIFICATE

Object **DAE4 - SD 000 D04 BM - SN: 786**

Calibration procedure(s) **QA CAL-06.v29
Calibration procedure for the data acquisition electronics (DAE)**



Calibration date: **December 08, 2016**

This calibration certificate documents the traceability to national standards, which realize the physical units of measurements (SI).
The measurements and the uncertainties with confidence probability are given on the following pages and are part of the certificate.

All calibrations have been conducted in the closed laboratory facility: environment temperature (22 ± 3)°C and humidity < 70%.

Calibration Equipment used (M&TE critical for calibration)

Primary Standards	ID #	Cal Date (Certificate No.)	Scheduled Calibration
Keithley Multimeter Type 2001	SN: 0810278	09-Sep-16 (No:19065)	Sep-17
Secondary Standards	ID #	Check Date (in house)	Scheduled Check
Auto DAE Calibration Unit	SE UWS 053 AA 1001	05-Jan-16 (in house check)	In house check: Jan-17
Calibrator Box V2.1	SE UMS 006 AA 1002	05-Jan-16 (in house check)	In house check: Jan-17

Calibrated by:	Name Eric Hainfeld	Function Technician	Signature 
Approved by:	Fin Bomholt	Deputy Technical Manager	

Issued: December 8, 2016

This calibration certificate shall not be reproduced except in full without written approval of the laboratory.

**Calibration Laboratory of
Schmid & Partner
Engineering AG**
Zeughausstrasse 43, 8004 Zurich, Switzerland



S Schweizerischer Kalibrierdienst
C Service suisse d'étalonnage
S Servizio svizzero di taratura
S Swiss Calibration Service

Accredited by the Swiss Accreditation Service (SAS)
The Swiss Accreditation Service is one of the signatories to the EA
Multilateral Agreement for the recognition of calibration certificates

Accreditation No.: **SCS 0108**

Glossary

DAE data acquisition electronics
Connector angle information used in DASY system to align probe sensor X to the robot coordinate system.

Methods Applied and Interpretation of Parameters

- *DC Voltage Measurement:* Calibration Factor assessed for use in DASY system by comparison with a calibrated instrument traceable to national standards. The figure given corresponds to the full scale range of the voltmeter in the respective range.
- *Connector angle:* The angle of the connector is assessed measuring the angle mechanically by a tool inserted. Uncertainty is not required.
- The following parameters as documented in the Appendix contain technical information as a result from the performance test and require no uncertainty.
 - *DC Voltage Measurement Linearity:* Verification of the Linearity at +10% and -10% of the nominal calibration voltage. Influence of offset voltage is included in this measurement.
 - *Common mode sensitivity:* Influence of a positive or negative common mode voltage on the differential measurement.
 - *Channel separation:* Influence of a voltage on the neighbor channels not subject to an input voltage.
 - *AD Converter Values with inputs shorted:* Values on the internal AD converter corresponding to zero input voltage
 - *Input Offset Measurement:* Output voltage and statistical results over a large number of zero voltage measurements.
 - *Input Offset Current:* Typical value for information; Maximum channel input offset current, not considering the input resistance.
 - *Input resistance:* Typical value for information: DAE input resistance at the connector, during internal auto-zeroing and during measurement.
 - *Low Battery Alarm Voltage:* Typical value for information. Below this voltage, a battery alarm signal is generated.
 - *Power consumption:* Typical value for information. Supply currents in various operating modes.

DC Voltage Measurement

A/D - Converter Resolution nominal

High Range: 1LSB = 6.1 μ V , full range = -100...+300 mV

Low Range: 1LSB = 61nV , full range = -1.....+3mV

DASY measurement parameters: Auto Zero Time: 3 sec; Measuring time: 3 sec

Calibration Factors	X	Y	Z
High Range	403.298 \pm 0.02% (k=2)	403.491 \pm 0.02% (k=2)	403.881 \pm 0.02% (k=2)
Low Range	3.96445 \pm 1.50% (k=2)	3.96537 \pm 1.50% (k=2)	3.95169 \pm 1.50% (k=2)

Connector Angle

Connector Angle to be used in DASY system	226.0 $^{\circ}$ \pm 1 $^{\circ}$
---	-------------------------------------

Appendix (Additional assessments outside the scope of SCS0108)

1. DC Voltage Linearity

High Range	Reading (μV)	Difference (μV)	Error (%)
Channel X + Input	200026.19	-5.79	-0.00
Channel X + Input	20005.74	1.53	0.01
Channel X - Input	-19998.94	6.48	-0.03
Channel Y + Input	200029.93	-2.27	-0.00
Channel Y + Input	20002.71	-1.40	-0.01
Channel Y - Input	-20003.56	1.97	-0.01
Channel Z + Input	200031.82	-0.21	-0.00
Channel Z + Input	20003.07	-0.95	-0.00
Channel Z - Input	-20004.84	0.72	-0.00

Low Range	Reading (μV)	Difference (μV)	Error (%)
Channel X + Input	2002.07	1.48	0.07
Channel X + Input	200.89	0.14	0.07
Channel X - Input	-199.34	-0.07	0.04
Channel Y + Input	1999.99	-0.49	-0.02
Channel Y + Input	200.10	-0.60	-0.30
Channel Y - Input	-200.06	-0.69	0.34
Channel Z + Input	2000.67	0.22	0.01
Channel Z + Input	199.73	-0.77	-0.38
Channel Z - Input	-201.22	-1.74	0.87

2. Common mode sensitivity

DASY measurement parameters: Auto Zero Time: 3 sec; Measuring time: 3 sec

	Common mode Input Voltage (mV)	High Range Average Reading (μV)	Low Range Average Reading (μV)
Channel X	200	12.75	10.67
	- 200	-10.14	-11.33
Channel Y	200	20.16	19.71
	- 200	-21.14	-21.51
Channel Z	200	6.53	6.44
	- 200	-9.02	-9.17

3. Channel separation

DASY measurement parameters: Auto Zero Time: 3 sec; Measuring time: 3 sec

	Input Voltage (mV)	Channel X (μV)	Channel Y (μV)	Channel Z (μV)
Channel X	200	-	-1.43	-3.68
Channel Y	200	10.01	-	-0.12
Channel Z	200	7.49	7.39	-