



EMC Test Report

Product Name: Smart Phone

Model Number: RNE-L23,RNE-L03

Report No: SYBH(Z-EMC)20180416010001-2

FCC ID: QISRNE-LX3

Reliability Laboratory of Huawei Technologies Co., Ltd.

(Global Compliance and Testing Center of Huawei Technologies Co., Ltd)

Administration Building, Headquarters of Huawei Technologies Co., Ltd., Bantian, Longgang District,
Shenzhen, 518129, P.R.C

Tel: +86 755 28780808 Fax: +86 755 89652518

Notice

1. The laboratory has obtained the accreditation of China National Accreditation Service for Conformity Assessment (CNAS), and accreditation number: L0310.
2. The laboratory has passed the accreditation by The American Association for Laboratory Accreditation (A2LA). The accreditation number is 2174.01
3. The laboratory has been listed by Industry Canada to perform electromagnetic emission measurements. The recognition numbers of test site are 6369A-1.
4. The laboratory (Reliability Lab of Huawei Technologies Co., Ltd) is also named as “Global Compliance and Testing Center of Huawei Technologies Co., Ltd”, the both names have coexisted since 2009.
5. The laboratory has been recognized by the US Federal Communications Commission (FCC) to perform compliance testing subject to the Commission's Declaration Of Conformity (DOC) and Certification rules. The Designation Number is CN1173, and the Test Firm Registration Number is 294140.”
6. The test report is invalid if not marked with the stamps or the signatures of the persons responsible for performing, revising and approving the test report.
7. The test report is invalid if there is any evidence of erasure and/or falsification.
8. If there is any dissidence for the test report, please file objection to the test centre within 15 days from the date of receiving the test report.
9. Normally, the test report is only responsible for the samples that have undergone the test.
10. Context of the test report cannot be used partially or in full for publicity and/or promotional purposes without previous written approval of the laboratory.



Applicant: Huawei Technologies Co., Ltd.
Address: Administration Building, Headquarters of Huawei Technologies Co., Ltd., Bantian, Longgang District, Shenzhen, 518129, P.R.C

Date of Receipt Test Item: Apr.15,2018
Start Date of Test: Apr.15,2018
End Date of Test: Apr.23,2018

Test Result: Pass

**Approved By
(Lab Manager)**

2018-04-28
Date

Hehao
Name

He Hao
Signature

**Prepared by
(Test Engineer)**

2018-04-25
Date

Huamei
Name

Hua Mei
Signature

**Modification Record**

No.	Last Report No.	Modification Description
1	NA	First Report.
2	SYBH(Z-EMC)095092017-2	Second report: (1) Add new adapter model and Manufacturer (2) Two new earphone manufacture added.

TABLE OF CONTENT









1	General Information	6
1.1	EUT Description	6
1.2	Modification Information	9
1.3	Differences Description	10
1.4	Test Site Information	11
1.5	Applied Standards	11
2	Summary of Results.....	12
3	System Configuration during EMC Test.....	13
3.1	Test Mode	13
3.2	Test System Configuration.....	14
3.3	Cables Used during Test.....	16
3.4	Associated Equipment Used during Test.....	16
4	Electromagnetic Interference (EMI).....	17
4.1	Radiated Disturbance 30MHz to 26.5GHz	17
4.2	Conducted Disturbance 0.15 MHz to 30MHz.....	19
5	Main Test Instruments.....	20
6	System Measurement Uncertainty	20
7	Test Data and Graph.....	21
7.1	Radiated Disturbance	21
7.2	Conducted Disturbance.....	24

1 General Information

1.1 EUT Description

EUT Description	
Product Name	Smart Phone
Model Number	RNE-L23,RNE-L03
Input voltage	3.8V DC
TX Frequency	GSM 850: 824MHz to 849MHz PCS 1900: 1850MHz to 1910MHz WCDMA Band II: 1850MHz to 1910MHz WCDMA Band IV: 1710MHz to 1755MHz WCDMA Band V:: 824MHz to 849MHz LTE BAND 2: 1850MHz to 1910MHz LTE BAND 4: 1710MHz to 1755MHz LTE BAND 5: 824MHz to 849MHz LTE BAND 7: 2500MHz to 2570MHz LTE BAND 12: 699MHz to 716MHz LTE BAND 17: 704MHz to 716MHz Bluetooth: 2402MHz to 2480MHz WIFI:2412MHz to 2462MHz
RX Frequency	GSM 850: 869MHz to 894MHz PSM 1900: 1930MHz to 1990MHz WCDMA Band II: 1930MHz to 1990MHz WCDMA Band IV: 2110MHz to 2155MHz WCDMA Band V:: 869MHz to 894MHz LTE BAND 2: 1930MHz to 1990MHz LTE BAND 4: 2110MHz to 2155MHz LTE BAND 5: 869MHz to 894MHz LTE BAND 7: 2620MHz to 2690MHz LTE BAND 12: 729MHz to 746MHz LTE BAND 17: 704MHz to 716MHz Bluetooth: 2402MHz to 2480MHz WIFI:2412MHz to 2462MHz FM:87.5MHz to 108MHz GPS: 1575.42MHz
S/N	M4VDU17828000115
HW Version	HL1RNEL23M
SW Version	RNE-L23C900B124, RNE-L03C900B124
EUT Accessory	
Data cable	Data Cable USB A Male to Micro Usb, Shielded Manufacturer: HONGLIN TECHNOLOGY CO.,LTD. FOXCONN INTERCONNECT TECHNOLOGY LIMITED. Luxshare Precision industry Co., Ltd SHEN ZHEN PANG NGAI INDUSTRIAL CO., LTD NINGBO BROAD TELECOMMUNICATION CO.,LTD
Adapter	Manufacturer:Huawei Technologies Co.,Ltd. Model: HW-050200U02 Input voltage: 100-240V 50/60Hz ,0.5A Output voltage: 5V  2A Rated Power: 10W



	SN: B95532J1N00007;K95501J1N00036 P95521J4E00024;H955K1YMD45612
Adapter	Manufacturer:Huawei Technologies Co.,Ltd. Model: HW-050200B02 Input voltage: 100-240V 50/60Hz ,0.5A Output voltage: 5V  2A Rated Power: 10W SN: B95332HC100115;K95301J1N00014; H95316J4200028;P95316J4300007
Adapter	Manufacturer:Huawei Technologies Co.,Ltd. Model: HW-050200E02 Input voltage: 100-240V 50/60Hz ,0.5A Output voltage: 5V  2A Rated Power: 10W SN: B95432J1V00238;K95401HA900005; H954K5J2T00041;P95414J3H00047;
Adapter	Manufacturer:Huawei Technologies Co.,Ltd. Model: HW-050200A02 Input voltage: 100-240V 50/60Hz ,0.5A Output voltage: 5V  2A Rated Power: 10W SN: B95632H9J00033;K95601J1N00032
Adapter	Manufacturer:Huawei Technologies Co.,Ltd. Model: HW-050200U01 Input voltage: 100-240V 50/60Hz ,0.5A Output voltage: 5V  2A Rated Power: 10W SN: H786K7H6M03016;P78613H4H66770; B7869OGBC20541;
Adapter	Manufacturer:Huawei Technologies Co.,Ltd. Model: HW-050200E01 Input voltage: 100-240V 50/60Hz ,0.5A Output voltage: 5V  2A Rated Power: 10W SN: H787K7H6201060;P78713H2008966; B78714H7H00975;
Adapter	Manufacturer:Huawei Technologies Co.,Ltd. Model: HW-050200B01 Input voltage: 100-240V 50/60Hz ,0.5A Output voltage: 5V  2A Rated Power: 10W SN:H676K7H4N00544;P78817H7D35407; B78830H7H01619
Adapter	Manufacturer:Huawei Technologies Co.,Ltd. Model: HW-050200A01 Input voltage: 100-240V 50/60Hz ,0.5A Output voltage: 5V  2A Rated Power: 10W SN: P78911H6A05283;B78975GCE02988; H78986H5D06522
Rechargeable Li-ion	Manufacturer:Huawei Technologies Co.,Ltd. Battery Model: HB356687ECW Rated capacity: 3240mAh Nominal Voltage:  +3.82V



	Charging Voltage:  +4.40V SN: 5UADACJ302900001; 2306SYH509X008FD 2306AIH508X01F36
Earphone	Manufacturer: Jiangxi Lianchuang Hongsheng Electronic Co.,LTD ; GoerTek Inc. ; FOXCONN INTERCONNECT TECHNOLOGY LIMITED Boluo County Quancheng Electronic Co.,ltd

Remark: The above EUT's information is declared by manufacturer. Please refer to the specifications or user's manual for more detailed information.

1.2 Modification Information

Compared with the previous report :(SYBH(Z-EMC)073082017-2)

The difference are as follows:

(1) Add new adapter model and Manufacturer

Before	After
Model: HW-050200B01 HW-050200E01 HW-050200U01 HW-050200A01	Model: HW-050200B01; HW-050200B02 HW-050200E01; HW-050200E02 HW-050200U01; HW-050200U02 HW-050200A01; HW-050200A02

(2) Two new earphone manufacture added.

Before	After
Manufacturer: Jiangxi Lianchuang Hongsheng Electronic Co.,LTD ; GoerTek Inc.;	Manufacturer: Jiangxi Lianchuang Hongsheng Electronic Co.,LTD ; GoerTek Inc. ; FOXCONN INTERCONNECT TECHNOLOGY LIMITED Boluo County Quancheng Electronic Co.,ltd

Notes: With the consideration of identities and differences listed above, EMC do full test . The test data of this report is for smart Phone with new adapter and earphone model .

1.3 Differences Description

The mobile phone RNE-L23 and RNE-L03 are LTE/UMTS/GSM mobile phone with Bluetooth. The differences between RNE-L23 and RNE-L03 are showed in the following table. RNE-L03 delete one SIM by software. Other parts of the mobile phone are the same, including the appearance, the antenna, Chipset, Bluetooth mode, Wifi mode, Adapter, Battery, and so on.

	RNE-L23	RNE-L03
GSM four bands	B2/B3/B5/B8	B2/B3/B5/B8
WCDMA bands	B1/B2/B4/B5/B8	B1/B2/B4/B5/B8
LTE bands	B2/B4/B5/B7/B12/B17/B28	B2/B4/B5/B7/B12/B17/B28
FCC bands	GSM850/1900 W850/W1700/W1900 LTE B2/B4/B5/B7/B12/B17	GSM850/1900 W850/W1700/W1900 LTE B2/B4/B5/B7/B12/B17
SIM card	Two	One
PCB layout	the same	the same
Appearance	the same	the same
Adapter	the same	the same
Battery	the same	the same
Chipset	the same	the same
Memory	the same	the same
Dimension	the same	the same

With the consideration of identities and differences listed above, RNE-L03 is based on the model RNE-L23.



1.4 Test Site Information

Test Site 1:	RELIABILITY LABORATORY OF HUAWEI TECHNOLOGIES CO., LTD.
Test Site Location:	Administration Building, Headquarters of Huawei Technologies Co., Ltd., Bantian, Longgang District, Shenzhen, 518129, P.R.C

1.5 Applied Standards

APPLIED STANDARD

47 CFR FCC Part 15, Subpart B

2 Summary of Results

Summary of Results				
Test Items	Test Mode	Performance Class & Required Performance Criteria	Result	Site
<u>Radiated Emissions</u> Enclosure Port	Mode2~ Mode 5	CLASS B	Pass	Site1
<u>Conducted Emissions</u> <input type="checkbox"/> DC Power Port <input checked="" type="checkbox"/> AC Power Port <input type="checkbox"/> Telecommunication Ports	Mode1~ Mode 5	CLASS B	Pass	Site1
Note: 1, Measurement taken is within the uncertainty of test system. 2, <input checked="" type="checkbox"/> The item has been tested; <input type="checkbox"/> The item has not been tested.				

During the measurement, the environmental conditions complied with the range listed as below.

Item	Required
Ambient temperature	15°C ~ 35°C
Relative humidity	25% ~ 75%
Atmospheric pressure	86kPa ~ 106kPa

3 System Configuration during EMC Test

3.1 Test Mode

The EUT was configured, installed, arranged and operated in a manner consistent with typical application. The following mode(s) were applied during the compliance test.

Test Mode	
Mode 1:	Charging+traffic+WIFI +BT +GPS On+Earphone
Mode 2:	Charging+ Camera On+ Earphone +idle
Mode 3:	Charging+Video Playing+ Earphone +idle
Mode 4:	Charging+FM+ Earphone idle
Mode 5:	USB Copy(EUT with PC) + Earphone

Remark:

- 1) If there is one kind of accessories with different models, each one should be applied throughout the compliance test respectively, however, only the worst case will be recorded in this report.
- 2) If EUT has more than one typical operation, only the worst test mode will be recorded in this report.

Traffic Mode:

When the EUT state is switched on and with Radio Resource Control (RRC) connection established.

Idle Mode:

When the EUT state is switched on but without Radio Resource Control (RRC) connection.

Worst Case:

- 1) Radiated Emission
Mode 4: Adapter(Model: HW-050200E01, SN: H787K7H6201060) + Charging+FM+ Earphone+idle
the result is the worst.
- 2) Conducted Emission
Mode 4:Adapter(Model: HW-050200U01, SN: H786K7H6M03016) + Charging+FM+ Earphone+idle
the result is the worst.

3.2 Test System Configuration

Connection Diagram (Mode 1)

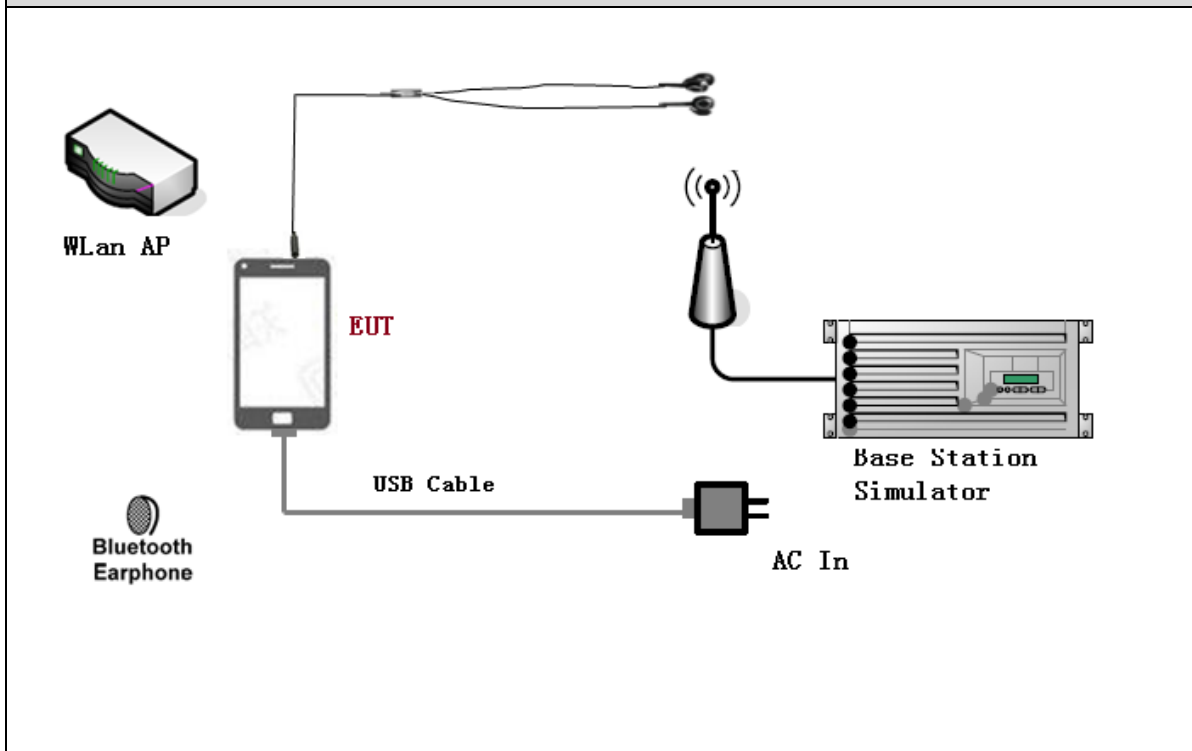

Connection Diagram (Mode 2~3)

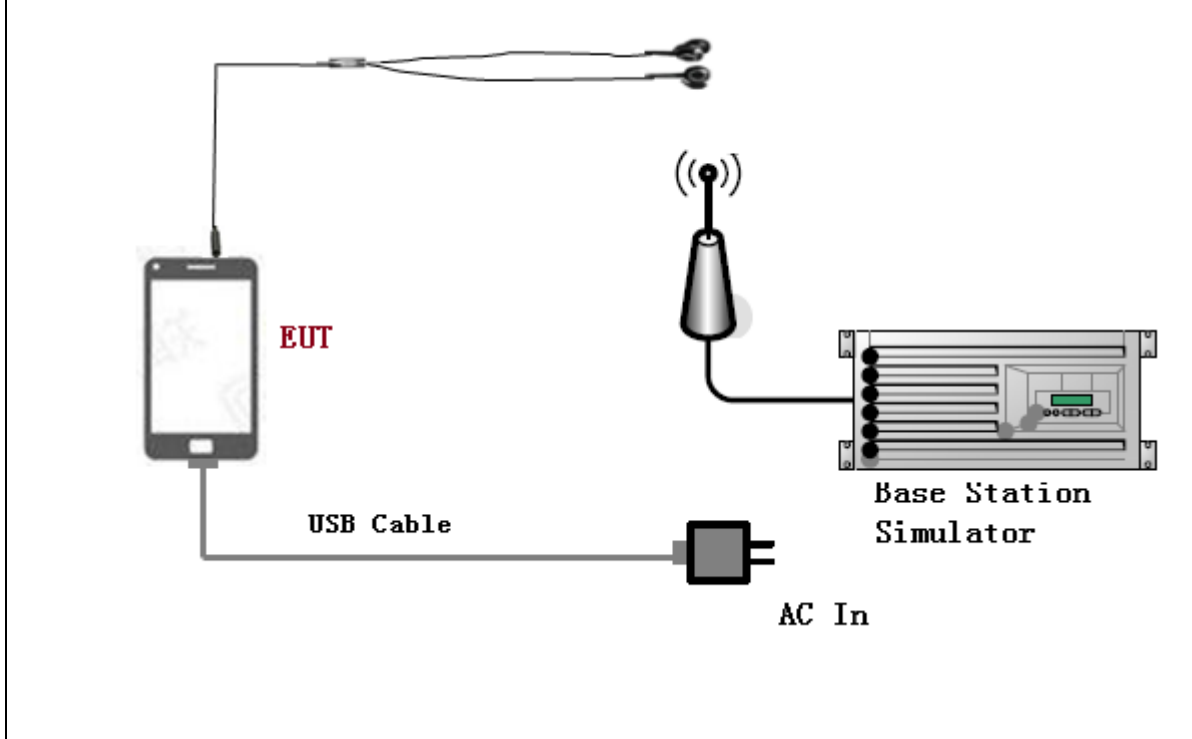

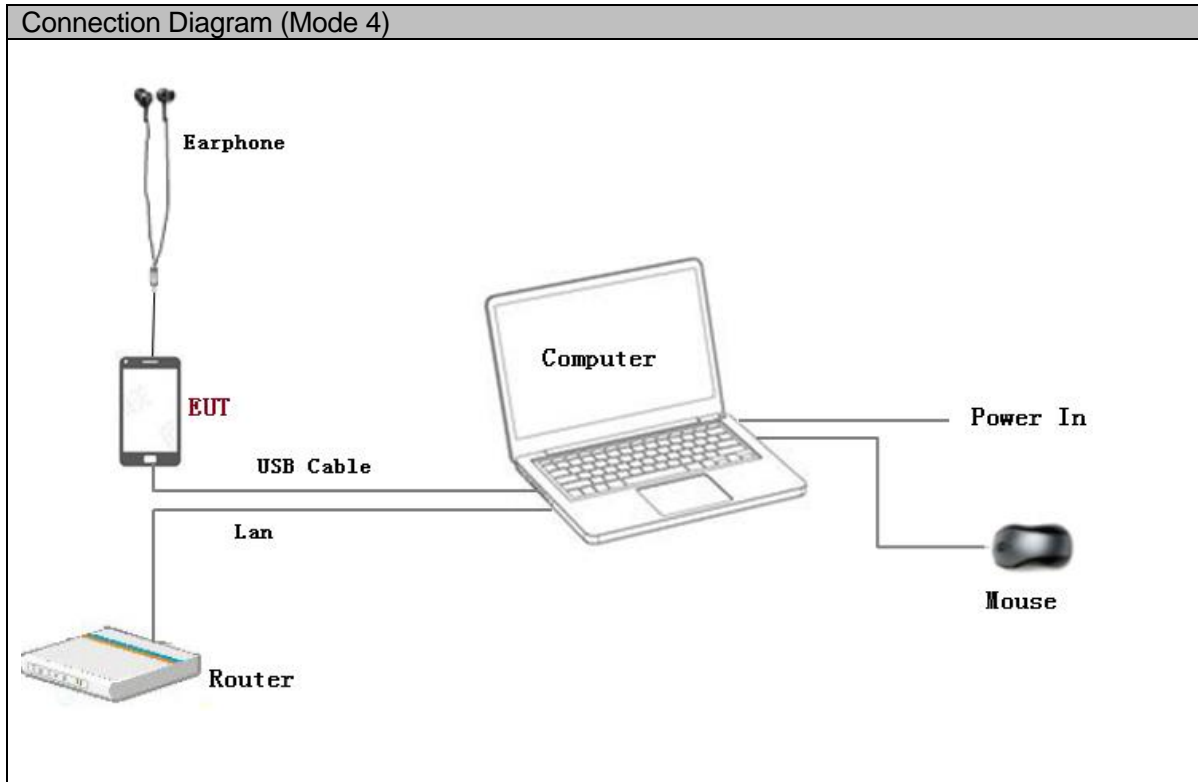

3.3 Cables Used during Test

Cable	Quantity	Length	Type of Cable
USB	1	<3m	Shielded
Earphone	1	<3m	Unshielded

3.4 Associated Equipment Used during Test

Name	Model	Manufacturer	S/N	Calibrated Deadline	Cal interval
Radio Communication Tester	CMU200	R&S	3608082535	2018-05-15	12
Radio Communication Tester	MT8820C	Anritsu	A110518805	2018-05-15	12
Notebook	S3	ThinkPad	A140714638	/	/
mouse	M-U0025-O	Lenovo	HS423HB22TB	/	/

4 Electromagnetic Interference (EMI)

4.1 Radiated Disturbance 30MHz to 26.5GHz

4.1.1 Test Procedure

The test site semi-anechoic chamber has met the requirement of NSA tolerance 4dB according to the standards: ANCI C63.4: 2014. The test distance was 3m. The set-up and test methods were according to ANCI C63.4: 2014.

A preliminary scan and a final scan of the emissions were made from 30 MHz to 26.5 GHz by using test script of software; The emissions were measured using Quasi-Peak Detector (30MHz~1GHz) and AV/PK detector (above 1GHz). The maximal emission value was acquired by adjusting the antenna height, polarisation and turntable azimuth in accordance with the software setup. Normally, the height range of antenna was 1m to 4m. The azimuth range of turntable was 0° to 360°. The receiving antenna has two polarizations V and H.

Measurement bandwidth (RBW) for 30MHz to 1000 MHz: 120 kHz;

Measurement bandwidth (RBW) for 1000MHz to 26500 MHz: 1MHz;

EUT was configured in idle mode and the test performed at worst emission state.

4.1.2 Test setup

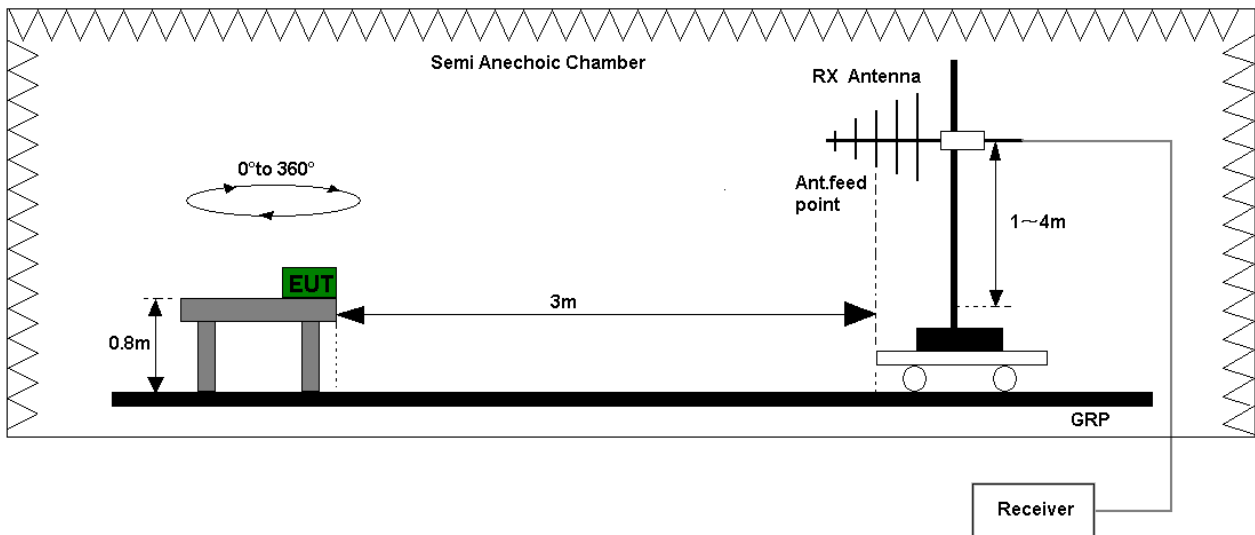

Figure 1. Test set-up of radiated disturbance(30MHz-1GHz)

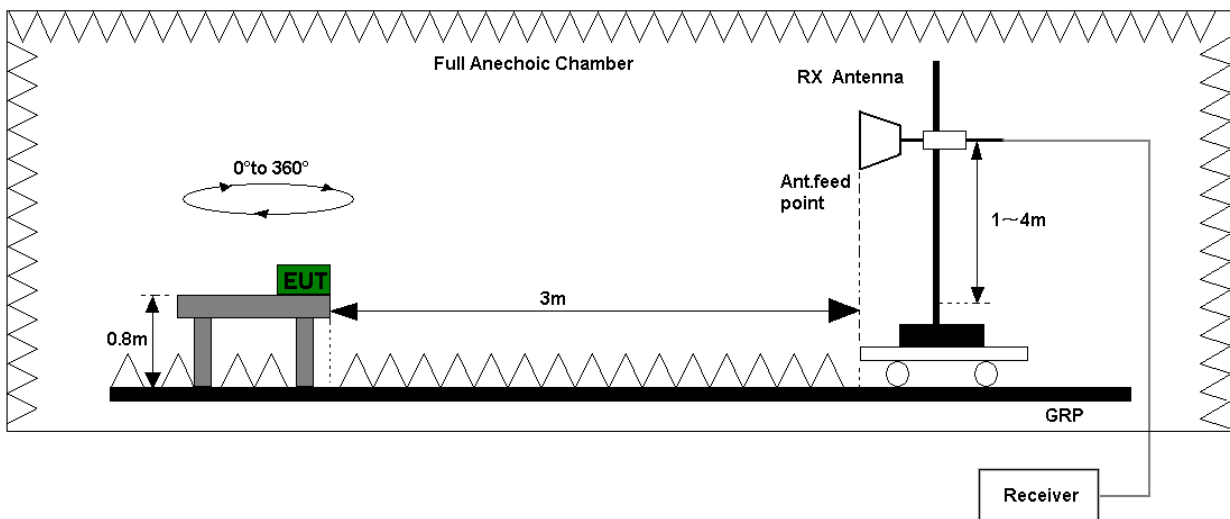

Figure 2. Test set-up of radiated disturbance(above 1GHz)

4.1.3 Test Results

The EUT has met the requirements for Radiated Emission of enclosure port.
Refer to the section 7.1.1 of this report for test data.

Test Limits (Class B)				
Frequency of Emission (MHz)	Radiated Limit			
	Unit(μ V/m)		Unit(dB μ V/m)	
30-88	100		40	
88-216	150		43.5	
216-960	200		46	
Above 960	500		54	
Above 1000	AV	PK	AV	PK
	500	5000	54	74

4.2 Conducted Disturbance 0.15 MHz to 30MHz

4.2.1 Test Procedure

The Table-top EUT was placed upon a non-metallic table 0.8 m above the horizontal metal reference ground plane. EUT was connected to LISN and LISN was connected to reference Ground Plane. EUT was 80cm away from LISN. The set-up and test methods were according to ANCI C63.4: 2014 Conducted Disturbance at AC Port measurements were undertaken on the L and N Lines. The emissions were measured using a Quasi-Peak Detector and Average Detector.

EUT was communicated with the simulator through Air interface, the simulator controls the EUT to transmitter the maximum power which defined in specification of product. The EUT operated on the typical channel.

Measurement bandwidth (RBW) for 150 kHz to 30 MHz: 9 kHz;

The EUT was set in the shielded chamber and operated under nominal conditions.

4.2.2 Test Setup

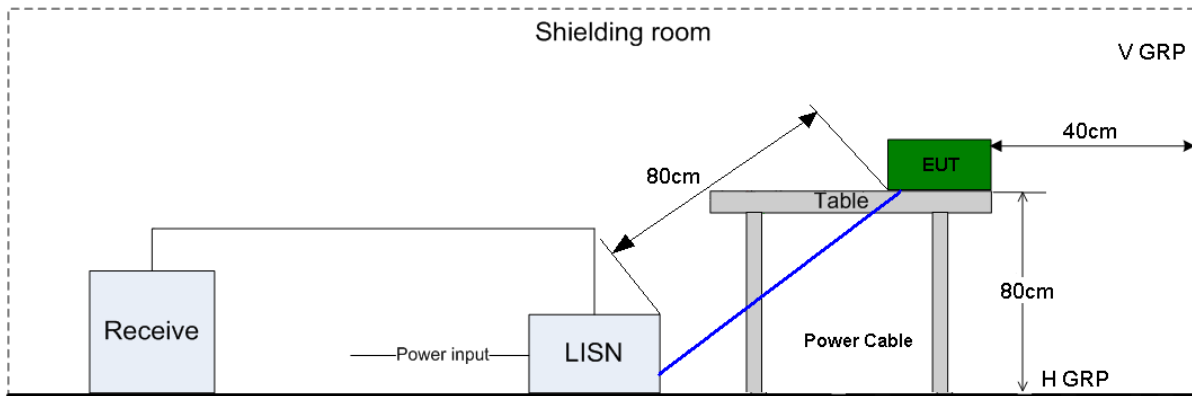

Figure 3. Test Set-up of conducted disturbance

4.2.3 Test Results

The EUT has met requirements for Conducted disturbance of power lines.

Refer to the section 7.2.1 of this report for test data.

Test Limit of AC Power Port		
Frequency range	150kHz ~ 30MHz	
Frequency	Voltage limits	
	QP (dB μ V)	AV (dB μ V)
0.15MHz~0.5MHz	66-56	56-46
0.5MHz-5MHz	56	46
5MHz~30MHz	60	50

5 Main Test Instruments

Main Test Equipments						
Test item	Test Instrument	Model	S/N	Manufacturer	Calibrated Deadline	Cal interval
RE	EMI Test receiver	ESU26	100150	R&S	Jan. 18, 2019	12
	Spectrum Analyzer	FSU43	100048	R&S	Jun. 06, 2018	12
	Broadband Antenna	VULB 9163	9163-491	SCHWARZ BECK	Mar. 28, 2019	24
	Horn Antenna	HF906	100683	R&S	Mar. 28, 2019	24
	Horn antenna (18 to 26.5G)	3160-09	5140299	ETS	Jul. 20, 2019	24
	Amplifier	SCU40	10016	R&S	May. 16, 2018	12
CE	EMI Test receiver	ESU26	100150	R&S	May. 15, 2018	12
	Artificial Mains Network	ENV4200	100134	R&S	May. 15, 2018	12
	Artificial Mains Network	ENV216	100382	R&S	May. 15, 2018	12
Software Information						
Test Item	Software Name	Manufacturer		Version		
RE	EMC32	R&S		V9.25.0		
CE	EMC32	R&S		V9.25.0		

6 System Measurement Uncertainty

For a 95% confidence level, the measurement expanded uncertainties for defined systems, in accordance with the recommendations of ISO 17025 were:

System Measurement Uncertainty		
Items	Extended Uncertainty	
RE(30MHz-1GHz)	Field strength (dB μ V/m)	U=4.1dB; k=2
RE(1GHz-18GHz)	Field strength (dB μ V/m)	U=5.1dB; k=2
RE(18 GHz-26.5GHz)	Field strength (dB μ V/m)	U=4.82dB; k=2
CE	Disturbance Voltage (dB μ V)	U=2.5dB; k=2

7 Test Data and Graph

Only the worst test results were shown

7.1 Radiated Disturbance

7.1.1 30MHz~1GHz

Test Mode 2: Charging+Camera On+ Earphone+idle

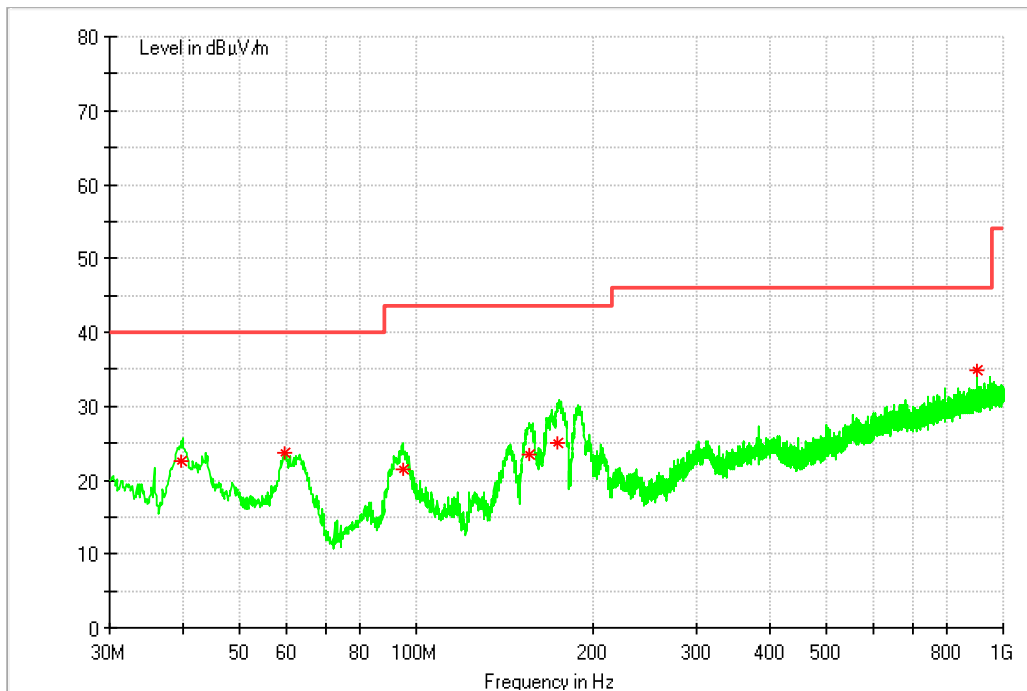

MEASUREMENT RESULT: QP Detector

Frequency MHz	Level dBµV/m	Transd dB	Limit dBµV/m	Margin dB	Height cm	Azimuth deg	Polarisation
39.680900	22.68	14.5	40.00	17.32	100.0	160.0	V
59.595450	23.61	13.9	40.00	16.39	100.0	350.0	V
94.807000	21.35	14.3	40.00	22.15	100.0	186.0	V
156.120500	23.48	10.5	40.00	20.02	105.0	69.0	V
174.174750	24.94	11.4	46.00	18.56	100.0	50.0	V
903.690800	34.97	26.6	46.00	11.03	100.0	147.0	V

Note:

Level =Reading level by receiver + Transd (Antenna factor + cable loss – preamplifier gain)
 The reading level is calculated by software which is not shown in the sheet.

7.1.2 1GHz~18GHz

Test Mode 4: Charging+FM+ Earphone+idle

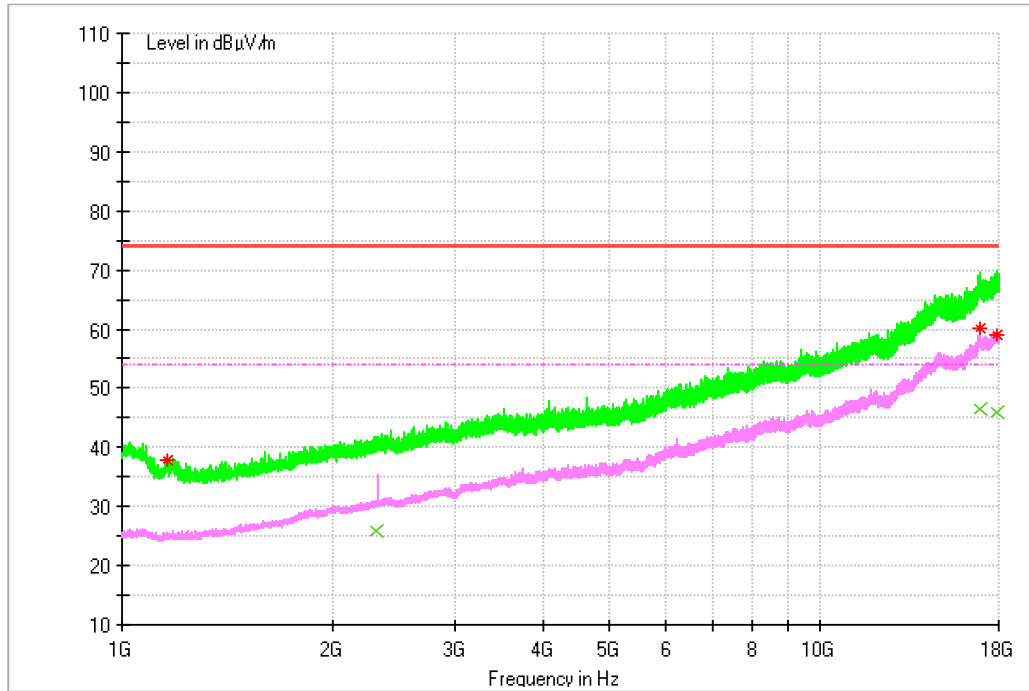

MEASUREMENT RESULT: PK Detector

Frequency MHz	Level dBµV/m	Transd dB	Limit dBµV/m	Margin dB	Height cm	Azimuth deg	Polarisation
1163.140666	38.79	-14.8	74	35.21	100	235	V
16889.88067	60.17	21	74	13.83	118	134	V
17875.72	58.98	21.6	74	15.02	144	200	V

MEASUREMENT RESULT: AV Detector

Frequency MHz	Level dBµV/m	Transd dB	Limit dBµV/m	Margin dB	Height cm	Azimuth deg	Polarisation
2315.764667	25.94	-7.7	54	28.06	100	342	V
16878.09533	46.44	21	54	7.56	200	45	V
17908.57133	45.92	21.7	54	8.08	200	264	V

Note:

Level = Reading level by receiver + Transd (Antenna factor + cable loss – preamplifier gain)
The reading level is calculated by software which is not shown in the sheet.

7.1.3 18GHz~26.5GHz

Test Mode 2:Charging +Camera On +Earphone +idle

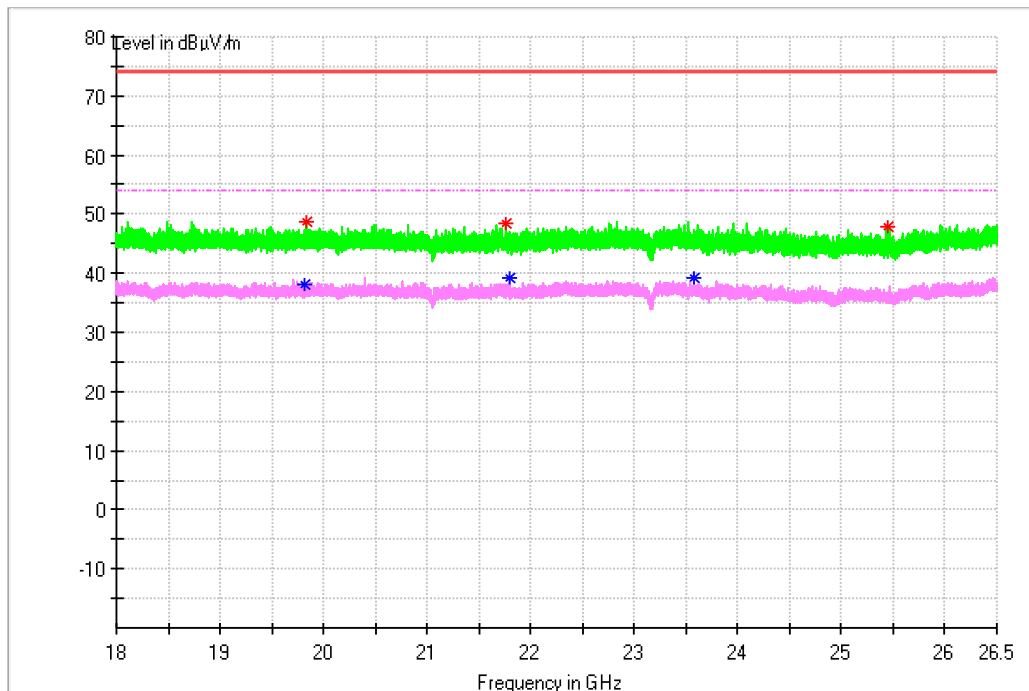

MEASUREMENT RESULT: PK Detector

Frequency MHz	Level dBµV/m	Transd dB	Limit dBµV/m	Margin dB	Height cm	Azimuth deg	Polarisation
19829.625	48.78	-4.8	74	25.22	100	234	V
21765.075	48.51	-4.1	74	25.49	100	245	V
25451.1	47.99	-2.5	74	26.01	100	86	V

MEASUREMENT RESULT: AV Detector

Frequency MHz	Level dBµV/m	Transd dB	Limit dBµV/m	Margin dB	Height cm	Azimuth deg	Polarisation
19815.6	38.03	-4.8	54	15.97	100	347	V
21804.175	39.11	-4.1	54	14.89	100	211	V
23580.675	39.22	-3	54	14.78	100	303	V

Note:

Level =Reading level by receiver + Transd (Antenna factor + cable loss – preamplifier gain)

The reading level is calculated by software which is not shown in the sheet.

7.2 Conducted Disturbance

7.2.1 AC Port Test Data

Test Mode 2:Charging +Camera On +Earphone +idle

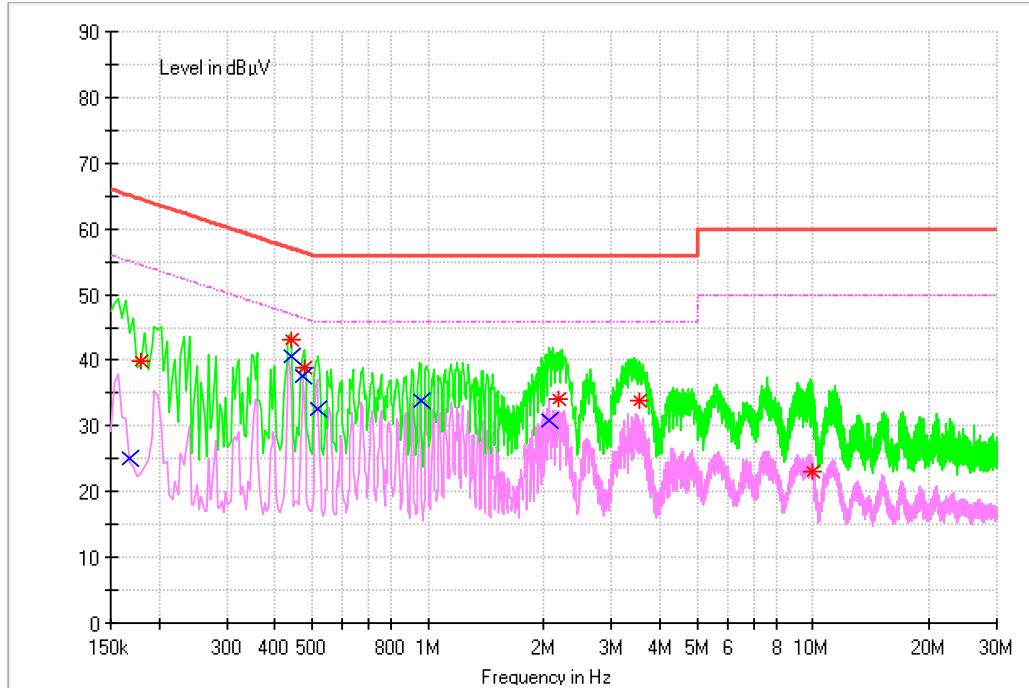

MEASUREMENT RESULT: QP Detector

Frequency MHz	Level dBµV	Line	Transd dB	Margin dB	Limit dBµV	PE
0.180132	39.75	N	9.7	24.73	64.48	FLO
0.441869	43.16	N	9.7	13.87	57.03	FLO
0.476392	38.79	L1	9.7	17.61	56.4	FLO
2.193959	34.04	N	9.7	21.96	56	FLO
3.536012	33.72	N	9.8	22.28	56	FLO
9.969376	23.14	N	10	36.86	60	FLO

MEASUREMENT RESULT: AV Detector

Frequency MHz	Level dBµV	Line	Transd dB	Margin dB	Limit dBµV	PE
0.168686	24.95	N	9.7	30.08	55.03	FLO
0.442444	40.7	N	9.7	6.32	47.02	FLO
0.47412	37.53	N	9.7	8.91	46.44	FLO
0.515898	32.59	N	9.7	13.41	46	FLO
0.955209	33.95	N	9.7	12.05	46	FLO
2.053228	30.93	N	9.7	15.07	46	FLO

Note:

Level =Reading level by receiver + Transd (Antenna factor + cable loss – preamplifier gain)
The reading level is calculated by software which is not shown in the sheet.

-----**END**-----