

FCC PART 15.407
DYNAMIC FREQUENCY SELECTION
TEST REPORT

For

Huawei Technologies Co., Ltd

Administration Building, Headquarters of Huawei Technologies Co., Ltd., Bantian, Longgang District, Shenzhen, 518129, P.R.C

FCC ID: QISR250D-E

Report Type: Class II permissive change	Product Name: Remote Unit
Test Engineer: Edison Hu	<i>Edison.hu</i>
Report Number: RDG161107002-00	
Report Date: 2017-01-19	
Reviewed By: EMC Engineer	<i>Jesse Huang</i>
Test Laboratory: Bay Area Compliance Laboratories Corp. (Kunshan) No.248 Chenghu Road, Kunshan, Jiangsu province, China Tel: +86-0512-86175000 Fax: +86-0512-88934268 www.baclcorp.com.cn	

Note: This test report is prepared for the customer shown above and for the device described herein. It may not be duplicated or used in part without prior written consent from Bay Area Compliance Laboratories Corp. (Kunshan). This report is valid only with a valid digital signature. The digital signature may be available only under the Adobe software above version 7.0.

TABLE OF CONTENTS

GENERAL INFORMATION.....	3
PRODUCT DESCRIPTION FOR EQUIPMENT UNDER TEST (EUT)	3
OBJECTIVE	3
RELATED SUBMITTAL(S)/GRANT(S).....	3
TEST METHODOLOGY	3
TEST FACILITY	4
SYSTEM TEST CONFIGURATION.....	5
DESCRIPTION OF TEST CONFIGURATION	5
EUT EXERCISE SOFTWARE	5
EQUIPMENT MODIFICATIONS	5
SUPPORT EQUIPMENT LIST AND DETAILS	5
EXTERNAL CABLE.....	5
SUMMARY OF TEST RESULTS	6
APPLICABLE STANDARDS.....	7
DFS REQUIREMENT	7
DFS MEASUREMENT SYSTEM.....	11
SYSTEM BLOCK DIAGRAM.....	11
CONDUCTED METHOD	12
RADIATED METHOD.....	13
TEST PROCEDURE	13
TEST RESULTS.....	14
DESCRIPTION OF EUT	14
TEST EQUIPMENT LIST AND DETAILS.....	14
RADAR WAVEFORM CALIBRATION	15
TEST ENVIRONMENTAL CONDITIONS	15
CHANNEL AVAILABILITY CHECK TIME (CAC)	24
TEST PROCEDURE	24
CHANNEL MOVE TIME AND CHANNEL CLOSING TRANSMISSION TIME	28
TEST PROCEDURE	28
TEST RESULTS	28
NON-OCCUPANCY PERIOD.....	33
TEST PROCEDURE	33
TEST RESULT	33
DETECTION BANDWIDTH.....	35
TEST PROCEDURE	35
TEST RESULT	35
STATISTICAL PERFORMANCE CHECK	42

GENERAL INFORMATION

Product Description for Equipment under Test (EUT)

The *Huawei Technologies Co., Ltd*'s product, model number: **R250D-E(FCC ID: QISR250D-E)** (or "EUT") in this report is a **Remote Unit**, which was measured approximately: 8.6cm (L) x 14cm (W) x 3.6cm (H), rated input voltage: *rated input voltage: DC 48V from adapter.*

Adapter Information:

MODEL: HW-100-48AC14D

INPUT: 100-240Vac, 50/60Hz, 2A

OUTPUT: DC48V, 2.08A

**All measurement and test data in this report was gathered from production sample serial number: 20161107002. (Assigned by the BACL. The EUT supplied by the applicant was received on 2016-11-18).*

Objective

This report is prepared on behalf of *Huawei Technologies Co., Ltd* in accordance with Part 2-Subpart J, Part 15-Subparts A, B and E of the Federal Communications Commission's rules.

The tests were performed in order to determine compliance with FCC Part 15, Subpart E, section 15.203, 15.205, 15.207, 15.209 and 15.407 rules.

Related Submittal(s)/Grant(s)

FCC Part 15C DTS submissions with FCC ID: QISR250D-E.

FCC Part 15B JBP submissions with FCC ID: QISR250D-E.

Test Methodology

FCC KDB 905462 D02 UNII DFS Compliance Procedures New Rules v02.

Test Facility

The test site used by Bay Area Compliance Laboratories Corp. (Kunshan) to collect test data is located on No.248 Chenghu Road, Kunshan, Jiangsu province, China.

Test site at Bay Area Compliance Laboratories Corp. (Kunshan) has been fully described in reports submitted to the Federal Communication Commission (FCC). The details of these reports have been found to be in compliance with the requirements of Section 2.948 of the FCC Rules on November 06, 2014. The facility also complies with the radiated and AC line conducted test site criteria set forth in ANSI C63.4.

The Federal Communications Commission has the reports on file and is listed under FCC Registration No.: 815570. The test site has been approved by the FCC for public use and is listed in the FCC Public Access Link (PAL) database.

SYSTEM TEST CONFIGURATION

Description of Test Configuration

The EUT was configured for testing in an engineering mode which was provided by the manufacturer.

EUT Exercise Software

The test was performed under: DOS command, which was provided by the manufacturer.

Equipment Modifications

N/A

Support Equipment List and Details

Manufacturer	Description	Model	Serial Number
Dell	Laptop	E6410	/
DELL	Laptop	PP11L	QDS-BRCM1331

External Cable

Cable Description	Shielding Type	Ferrite Core	Length (m)	From Port	To
RJ45 Cable	No	Yes	10	RJ45 Port of Laptop	EUT

SUMMARY OF TEST RESULTS

The following result table represents the list of measurements required under the CFR §47 Part 15.407(h), and KDB: 905462 D02 UNII DFS Compliance Procedures New Rules v02

Items	Description of Test	Result
Detection Bandwidth	UNII Detection Bandwidth	Compliant
Performance Requirements Check	Initial Channel Availability Check Time (CAC)	Compliant
	Radar Burst at the Beginning of the CAC	Compliant
	Radar Burst at the End of the CAC	Compliant
In-Service Monitoring	Channel Move Time	Compliant
	Channel Closing Transmission Time	Compliant
	Non-Occupancy Period	Compliant
Radar Detection	Statistical Performance Check	Compliant

APPLICABLE STANDARDS

DFS Requirement

CFR §47 Part 15.407(h)

FCC KDB 905462 D02 UNII DFS Compliance Procedures New Rules v02

Table 1: Applicability of DFS Requirements Prior to Use of a Channel

Requirement	Operational Mode		
	Master	Client Without Radar Detection	Client With Radar Detection
<i>Non-Occupancy Period</i>	Yes	Not required	Yes
<i>DFS Detection Threshold</i>	Yes	Not required	Yes
<i>Channel Availability Check Time</i>	Yes	Not required	Not required
<i>U-NII Detection Bandwidth</i>	Yes	Not required	Yes

Table 2: Applicability of DFS requirements during normal operation

Requirement	Operational Mode	
	Master Device or Client with Radar Detection	Client Without Radar Detection
<i>DFS Detection Threshold</i>	Yes	Not required
<i>Channel Closing Transmission Time</i>	Yes	Yes
<i>Channel Move Time</i>	Yes	Yes
<i>U-NII Detection Bandwidth</i>	Yes	Not required

Additional requirements for devices with multiple bandwidth modes	Master Device or Client with Radar Detection	Client Without Radar Detection
<i>U-NII Detection Bandwidth and Statistical Performance Check</i>	All BW modes must be tested	Not required
<i>Channel Move Time and Channel Closing Transmission Time</i>	Test using widest BW mode available	Test using the widest BW mode available for the link
<i>All other tests</i>	Any single BW mode	Not required
<p>Note: Frequencies selected for statistical performance check (Section 7.8.4) should include several frequencies within the radar detection bandwidth and frequencies near the edge of the radar detection bandwidth. For 802.11 devices it is suggested to select frequencies in each of the bonded 20 MHz channels and the channel center frequency.</p>		

Table 3: DFS Detection Thresholds for Master Devices and Client Devices With Radar Detection

Maximum Transmit Power	Value (See Notes 1, 2, and 3)
EIRP ≥ 200 milliwatt	-64 dBm
EIRP < 200 milliwatt and power spectral density < 10 dBm/MHz	-62 dBm
EIRP < 200 milliwatt that do not meet the power spectral density requirement	-64 dBm
<p>Note 1: This is the level at the input of the receiver assuming a 0 dBi receive antenna.</p> <p>Note 2: Throughout these test procedures an additional 1 dB has been added to the amplitude of the test transmission waveforms to account for variations in measurement equipment. This will ensure that the test signal is at or above the detection threshold level to trigger a DFS response.</p> <p>Note3: EIRP is based on the highest antenna gain. For MIMO devices refer to KDB Publication 662911 D01.</p>	

Table 4: DFS Response Requirement Values

Parameter	Value
<i>Non-occupancy period</i>	Minimum 30 minutes
<i>Channel Availability Check Time</i>	60 seconds
<i>Channel Move Time</i>	10 seconds See Note 1.
<i>Channel Closing Transmission Time</i>	200 milliseconds + an aggregate of 60 milliseconds over remaining 10 second period. See Notes 1 and 2.
<i>U-NII Detection Bandwidth</i>	Minimum 100% of the U-NII 99% transmission power bandwidth. See Note 3.
<p>Note 1: <i>Channel Move Time</i> and the <i>Channel Closing Transmission Time</i> should be performed with Radar Type 0. The measurement timing begins at the end of the Radar Type 0 burst.</p> <p>Note 2: The <i>Channel Closing Transmission Time</i> is comprised of 200 milliseconds starting at the beginning of the <i>Channel Move Time</i> plus any additional intermittent control signals required to facilitate a <i>Channel</i> move (an aggregate of 60 milliseconds) during the remainder of the 10 second period. The aggregate duration of control signals will not count quiet periods in between transmissions.</p> <p>Note 3: During the <i>U-NII Detection Bandwidth</i> detection test, radar type 0 should be used. For each frequency step the minimum percentage of detection is 90 percent. Measurements are performed with no data traffic.</p>	

Table 5 – Short Pulse Radar Test Waveforms

Radar Type	Pulse Width (μsec)	PRI (μsec)	Number of Pulses	Minimum Percentage of Successful Detection	Minimum Number of Trials
0	1	1428	18	See Note 1	See Note 1
1	1	Test A: 15 unique PRI values randomly selected from the list of 23 PRI values in Table 5a	Roundup $\left\{ \left(\frac{1}{360} \right) \cdot \left(\frac{19 \cdot 10^6}{\text{PRI}_{\mu\text{sec}}} \right) \right\}$	60%	30
		Test B: 15 unique PRI values randomly selected within the range of 518-3066 μsec, with a minimum increment of 1 μsec, excluding PRI values selected in Test A			
2	1-5	150-230	23-29	60%	30
3	6-10	200-500	16-18	60%	30
4	11-20	200-500	12-16	60%	30
Aggregate (Radar Types 1-4)				80%	120
Note 1: Short Pulse Radar Type 0 should be used for the detection bandwidth test, channel move time, and channel closing time tests.					

A minimum of 30 unique waveforms are required for each of the Short Pulse Radar Types 2 through 4. If more than 30 waveforms are used for Short Pulse Radar Types 2 through 4, then each additional waveform must also be unique and not repeated from the previous waveforms. If more than 30 waveforms are used for Short Pulse Radar Type 1, then each additional waveform is generated with Test B and must also be unique and not repeated from the previous waveforms in Tests A or B.

For example if in Short Pulse Radar Type 1 Test B a PRI of 3066 usec is selected, the number of pulses

would be $\text{Roundup} \left\{ \left(\frac{1}{360} \right) \cdot \left(\frac{19 \cdot 10^6}{3066} \right) \right\} = \text{Roundup} \{17.2\} = 18.$

Table 5a - Pulse Repetition Intervals Values for Test A

Pulse Repetition Frequency Number	Pulse Repetition Frequency (Pulses Per Second)	Pulse Repetition Interval (Microseconds)
1	1930.5	518
2	1858.7	538
3	1792.1	558
4	1730.1	578
5	1672.2	598
6	1618.1	618
7	1567.4	638
8	1519.8	658
9	1474.9	678
10	1432.7	698
11	1392.8	718
12	1355	738
13	1319.3	758
14	1285.3	778
15	1253.1	798
16	1222.5	818
17	1193.3	838
18	1165.6	858
19	1139	878
20	1113.6	898
21	1089.3	918
22	1066.1	938
23	326.2	3066

The aggregate is the average of the percentage of successful detections of Short Pulse Radar Types 1-4. For example, the following table indicates how to compute the aggregate of percentage of successful detections.

Radar Type	Number of Trials	Number of Successful Detections	Minimum Percentage of Successful Detection
1	35	29	82.9%
2	30	18	60%
3	30	27	90%
4	50	44	88%
Aggregate $(82.9\% + 60\% + 90\% + 88\%)/4 = 80.2\%$			

Table 6 – Long Pulse Radar Test Waveform

Radar Type	Pulse Width (μsec)	Chirp Width (MHz)	PRI (μsec)	Number of Pulses per <i>Burst</i>	Number of <i>Bursts</i>	Minimum Percentage of Successful Detection	Minimum Number of Trials
5	50-100	5-20	1000-2000	1-3	8-20	80%	30

Table 7 – Frequency Hopping Radar Test Waveform

Radar Type	Pulse Width (μsec)	PRI (μsec)	Pulses per Hop	Hopping Rate (kHz)	Hopping Sequence Length (msec)	Minimum Percentage of Successful Detection	Minimum Number of Trials
6	1	333	9	0.333	300	70%	30

DFS Measurement System

BACL DFS measurement system consists of two subsystems: (1) The radar signal generating subsystem and (2) the traffic monitoring subsystem.

System Block Diagram

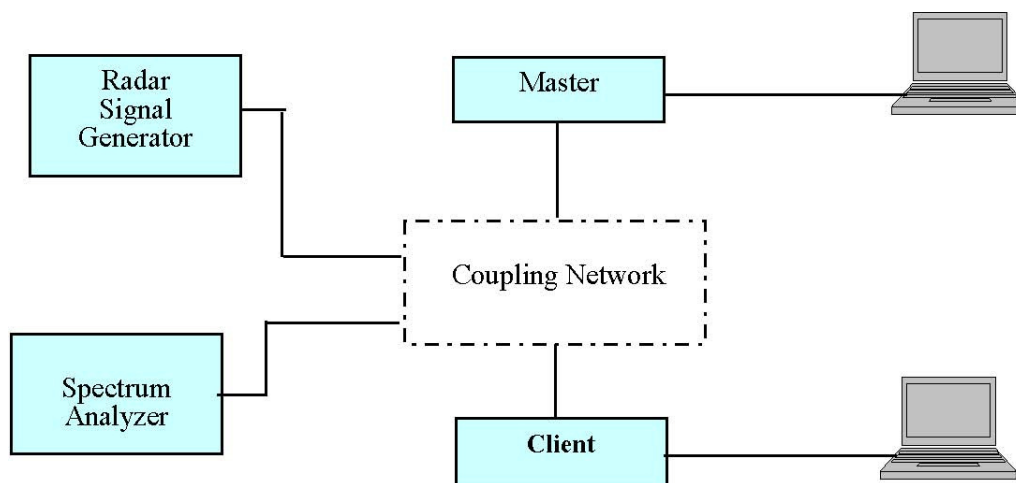

Conducted Method

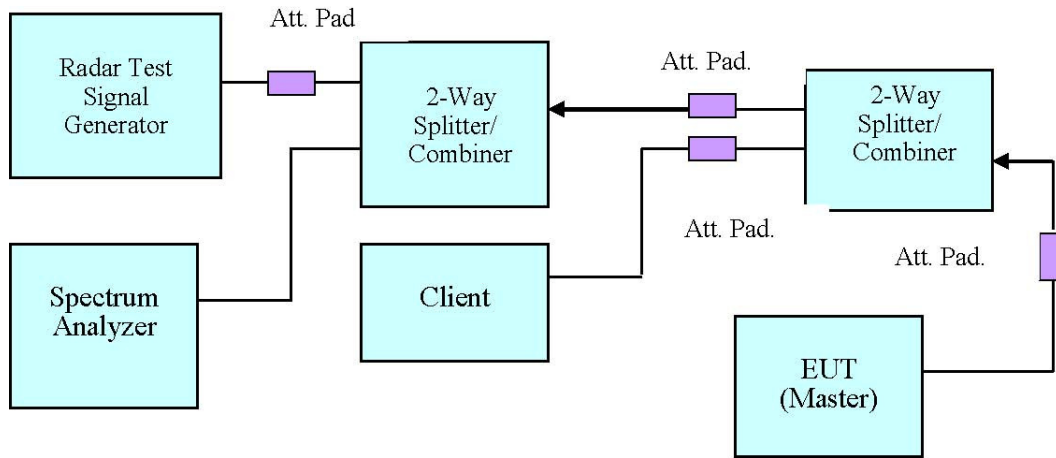

Setup for Master with injection at the Master

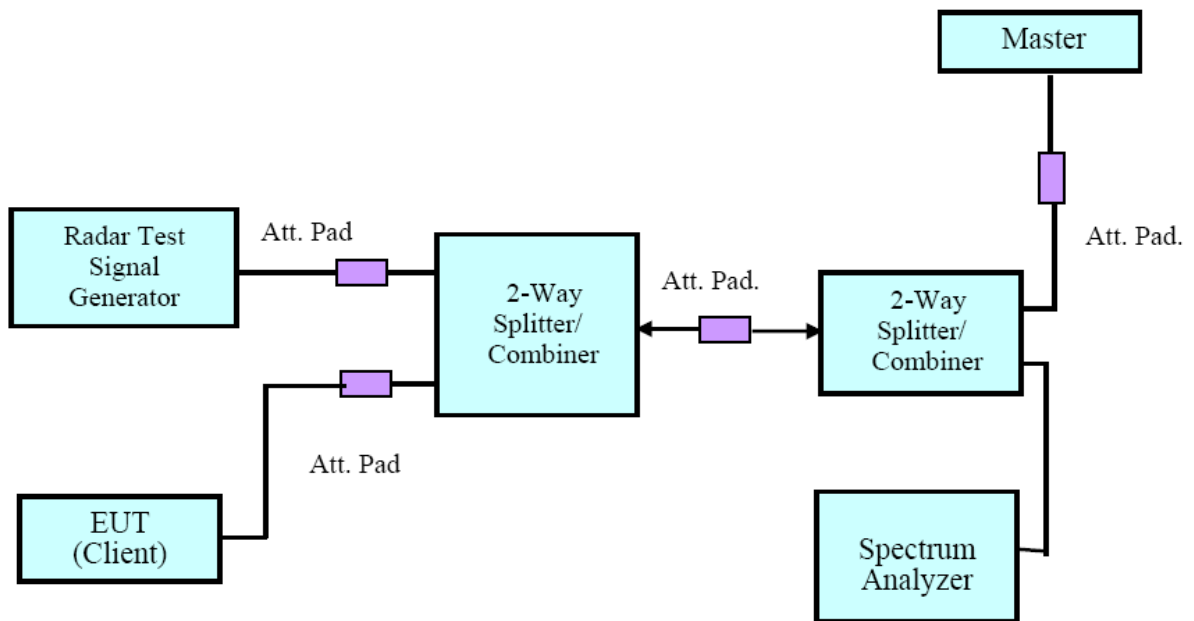

Setup for Client with injection at the Master

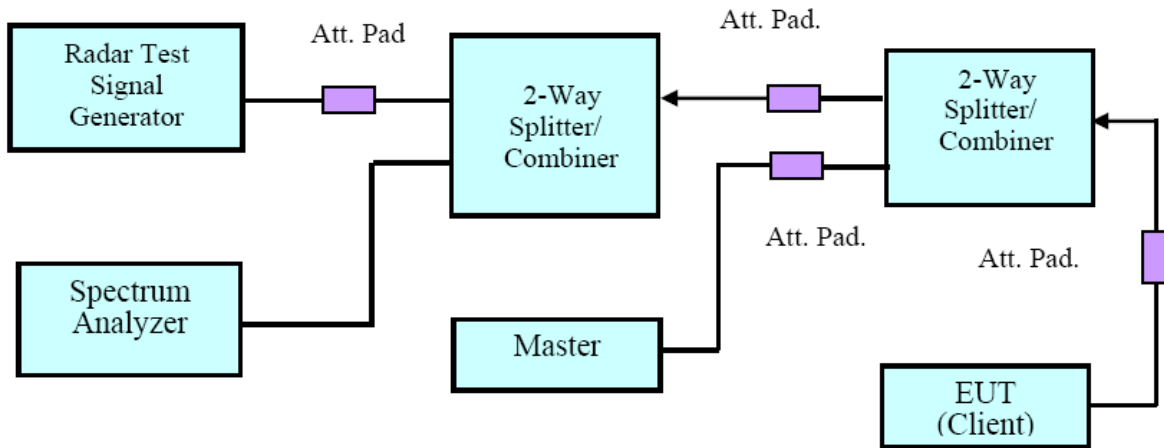

Setup for Client with injection at the Client

Radiated Method

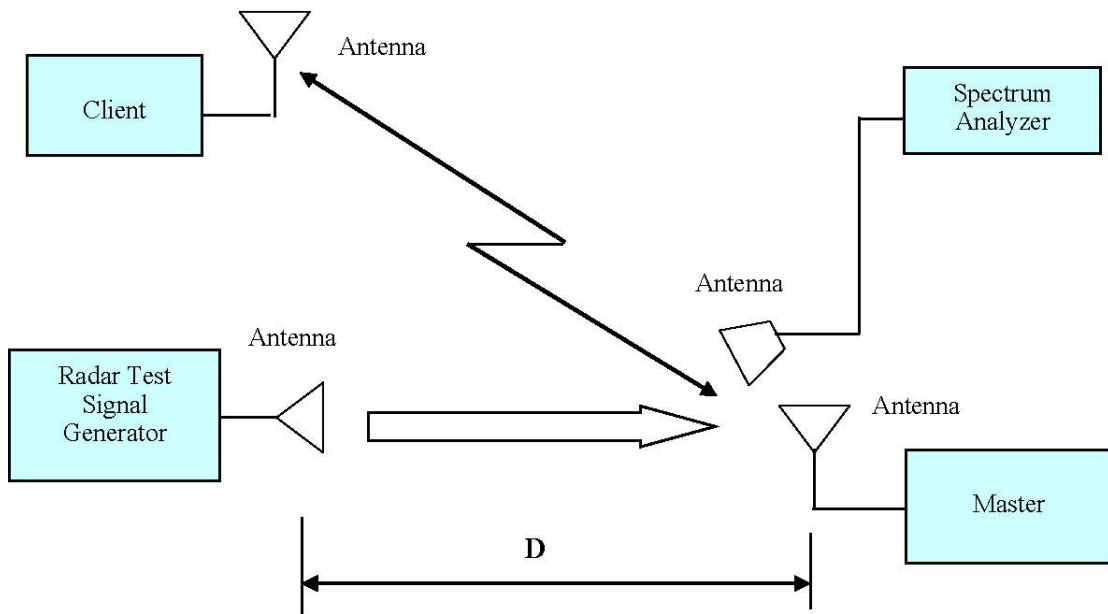

Test Procedure

A spectrum analyzer is used as a monitor verifies that the EUT status including Channel Closing Transmission Time and Channel Move Time, and does not transmit on a Channel during the Non-Occupancy Period after the diction and Channel move. It is also used to monitor EUT transmissions during the Channel Availability Check Time.

TEST RESULTS

Description of EUT

The EUT operates in 5230-5350 MHz and 5470-5725 MHz range

The maximum conducted output power of EUT is 18.38dBm, antenna gain is 9dBi, the Maximum E.I.R.P= $18.38+9=27.38\text{dBm}$ $>23\text{ dBm}$, Therefore the required interference threshold level is -64 dBm, the required radiated threshold at antenna port is -64dBm.

The calibrated radiated DFS detection threshold level is set to -64 dBm.

WLAN traffic is generated by streaming the video file TestFile.mpg, this file is used by IP and Frame based systems for loading the test channel during the In-service compliance testing of the U-NII device. The file is streamed from the Access Point to the Client in full motion video mode using the media player with the V2.61 Codec package.

Test Equipment List and Details

Manufacturer	Description	Model	Serial Number	Calibration Date	Calibration Due Date
Rohde & Schwarz	OSP120 BASE UNIT	OSP120	101247	2016-07-04	2017-07-03
Rohde & Schwarz	SIGNAL ANALYZER	FSV40	101116	2016-07-04	2017-07-03
Rohde & Schwarz	VECTOR SIGNAL GENERATOR	SMBV100A	261558	2016-07-04	2017-07-03
Rohde & Schwarz	SIGNAL GENERATOR	SMB100A	110390	2016-07-04	2017-07-03
Rohde & Schwarz	OSP120 BASE UNIT	OSP120	101247	2016-07-04	2017-07-03
Mini-circuits	Splitter/Combiner	ZX10-2-1252+	N/A	N/A	N/A
ETS	Horn Antenna	3115	6229	2016-01-11	2019-01-10
ETS	Horn Antenna	3115	00066542	N/A	N/A

* **Statement of Traceability:** Bay Area Compliance Laboratories Corp. (Kunshan) attests that all calibrations have been performed, traceable to National Primary Standards and International System of Units (SI).

Radar Waveform Calibration

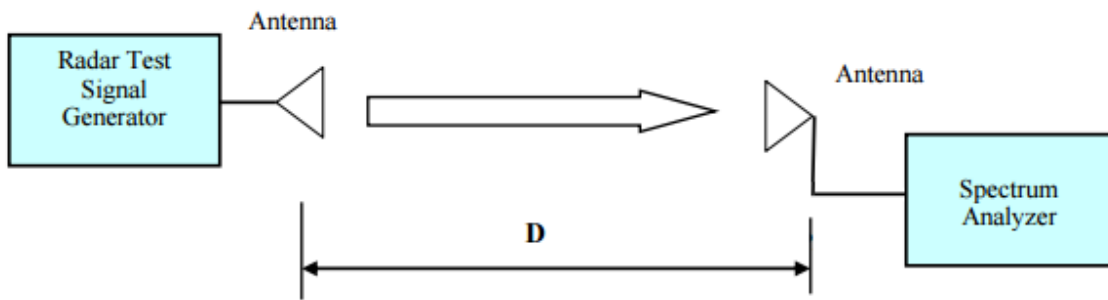

Radiated Calibration Setup Block Diagram

Test Environmental Conditions

Temperature:	22.1~26.5 °C
Relative Humidity:	30~39 %
ATM Pressure:	101.2 kPa

The testing was performed by Edison Hu from 2016-11-24 to 2017-01-16.

Plots of Radar Waveforms

5280 MHz:

Radar Type 0

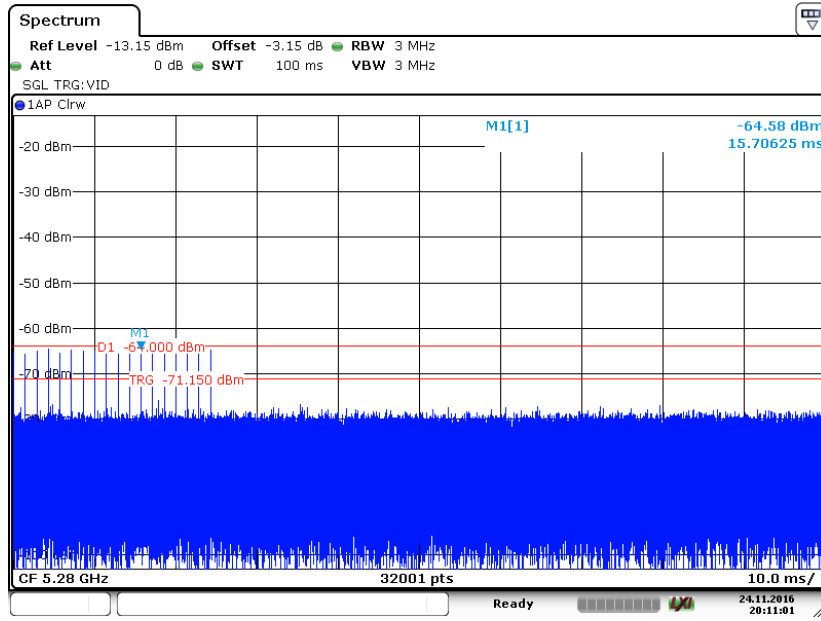

Radar Type 1A

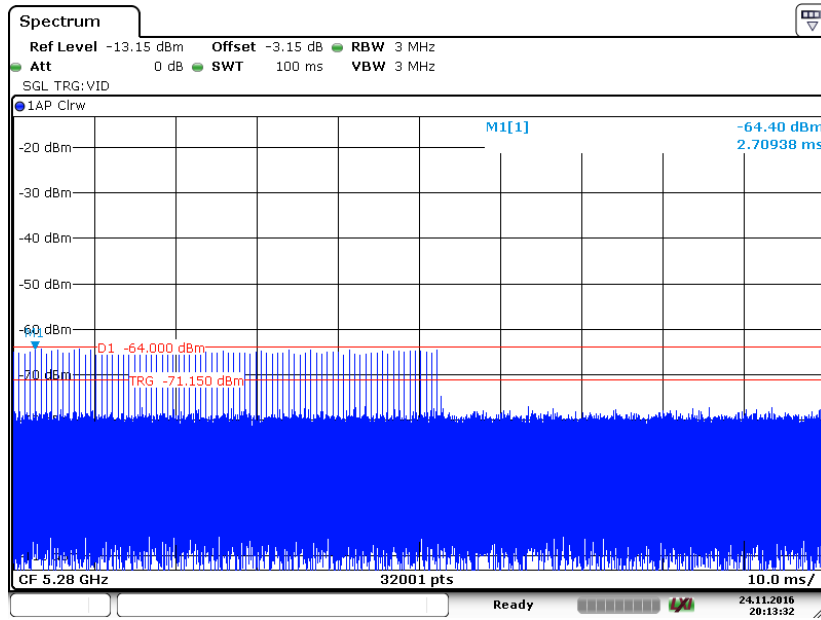

Radar Type 1B

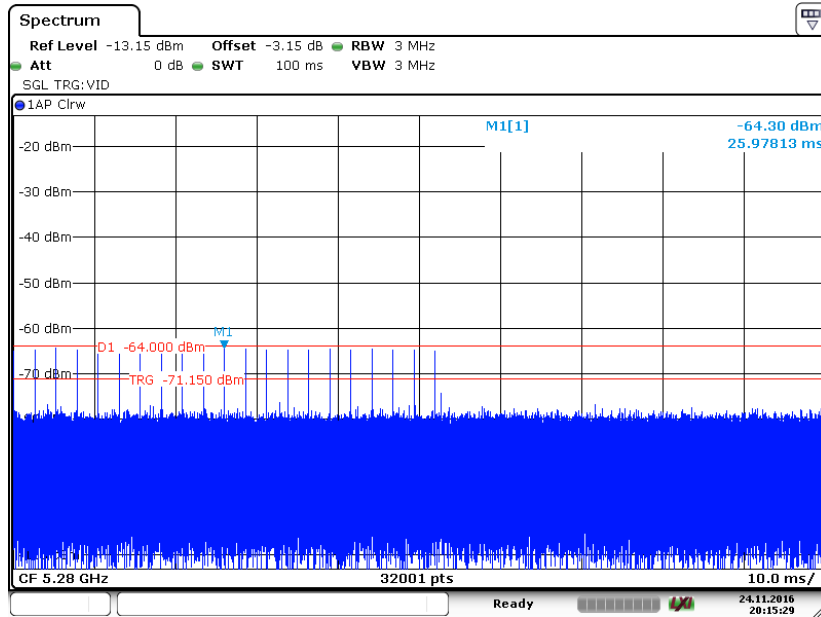

Date: 24 NOV 2016 20:15:29

Radar Type 2

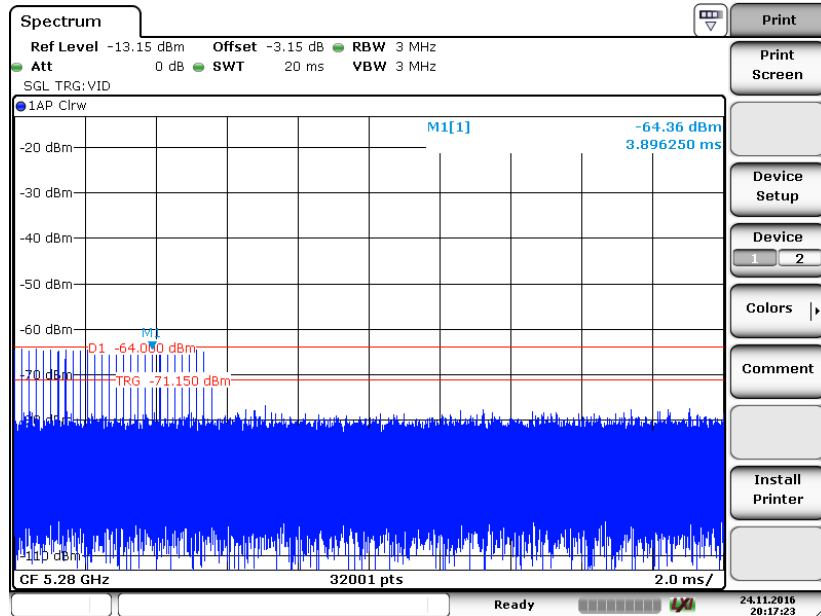

Date: 24 NOV 2016 20:17:23

Radar Type 3

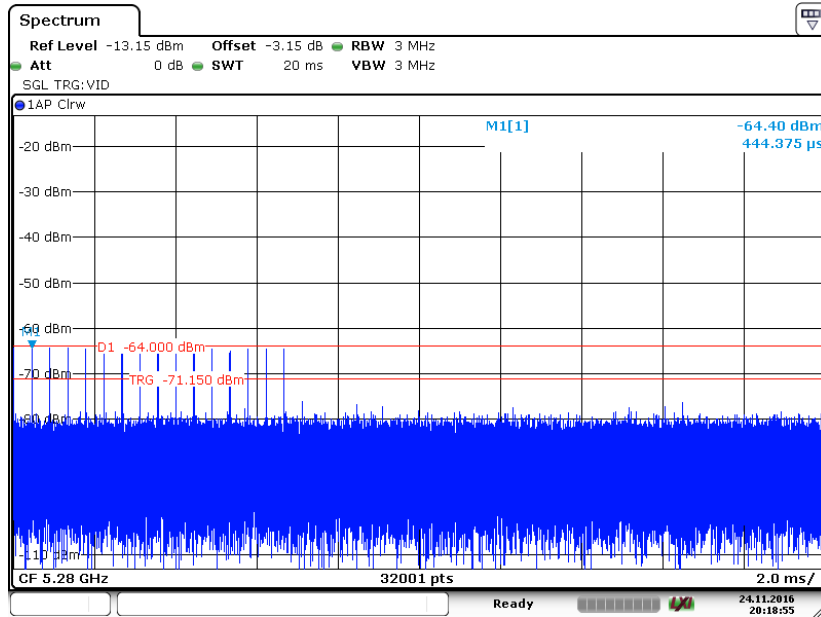

Date: 24.NOV.2016 20:18:54

Radar Type 4

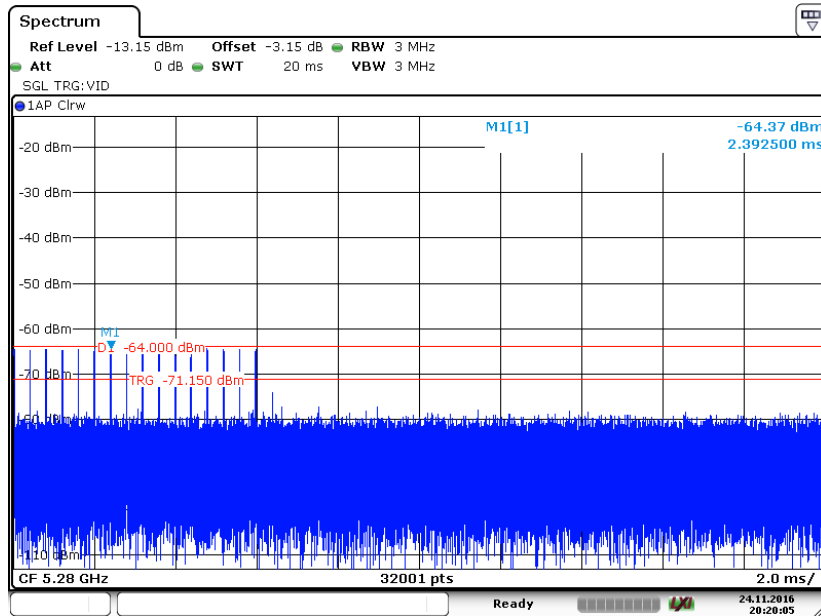

Date: 24.NOV.2016 20:20:05

Radar Type 5

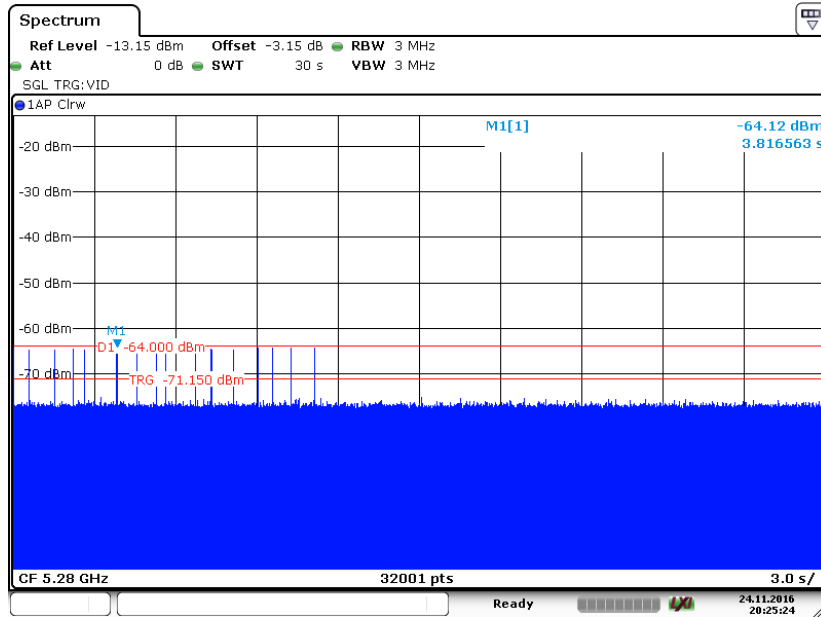

Date: 24.NOV.2016 20:25:23

Radar Type 6

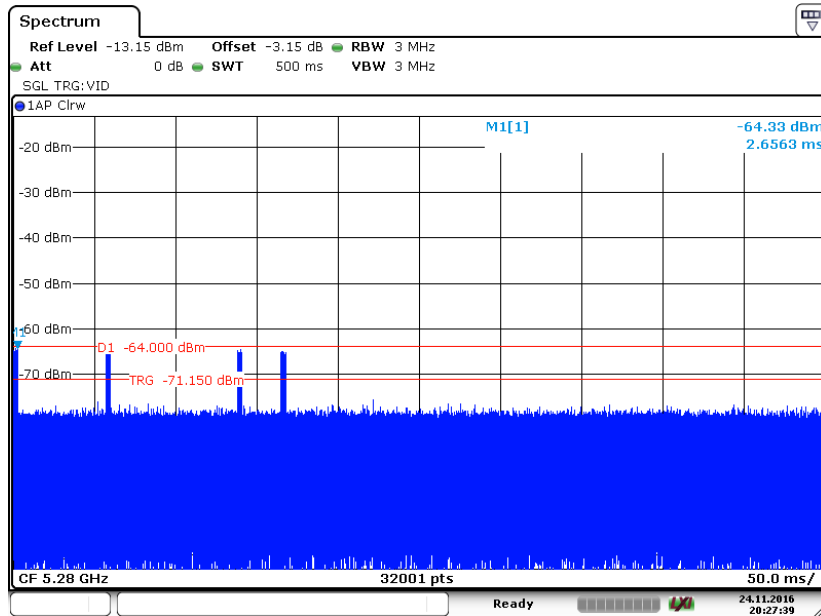

Date: 24.NOV.2016 20:27:35

5500 MHz:

Radar Type 0

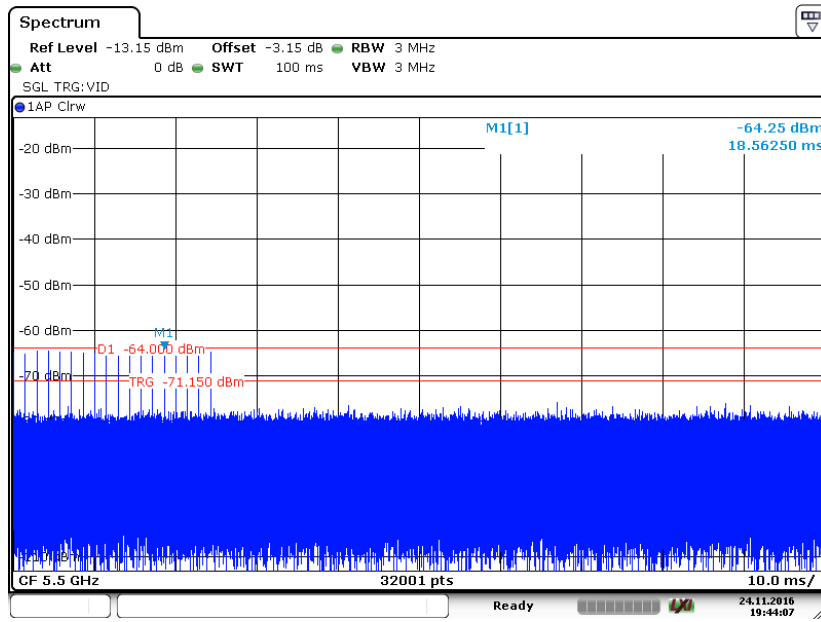

Date: 24 NOV 2016 19:44:06

Radar Type 1A

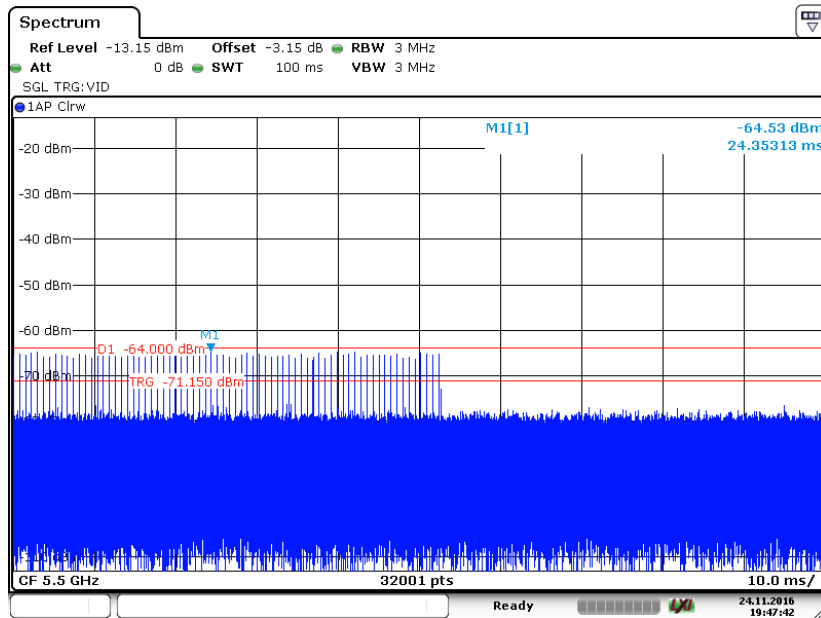

Date: 24 NOV 2016 19:47:41

Radar Type 1B

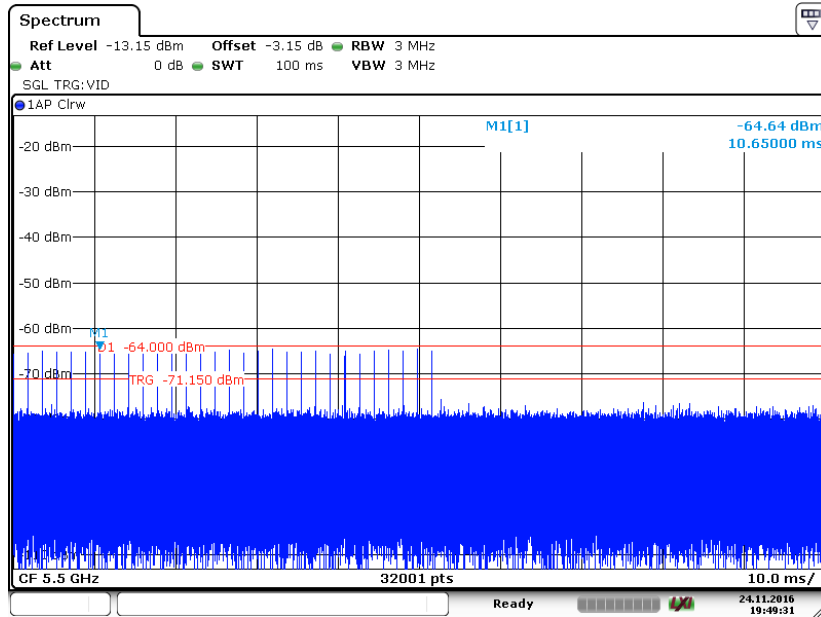

Date: 24 NOV 2016 19:49:32

Radar Type 2

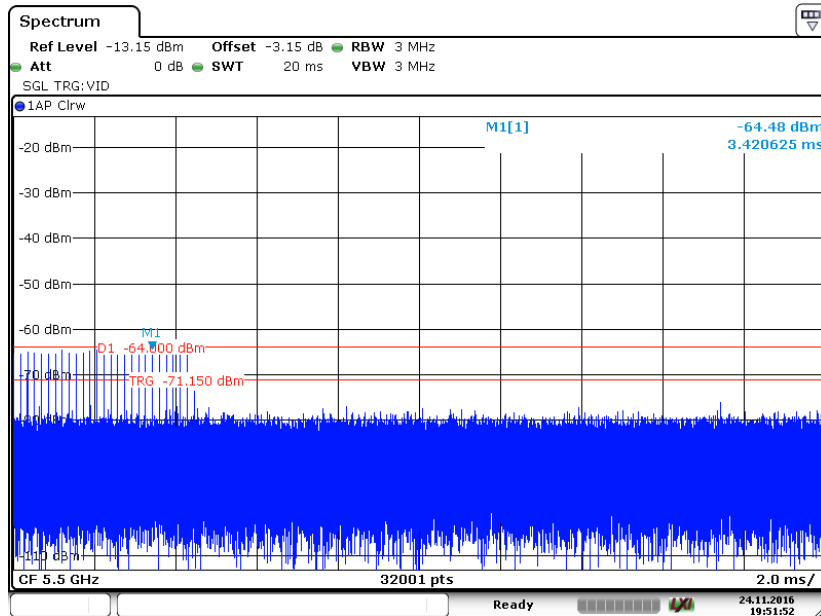

Date: 24 NOV 2016 19:51:53

Radar Type 3

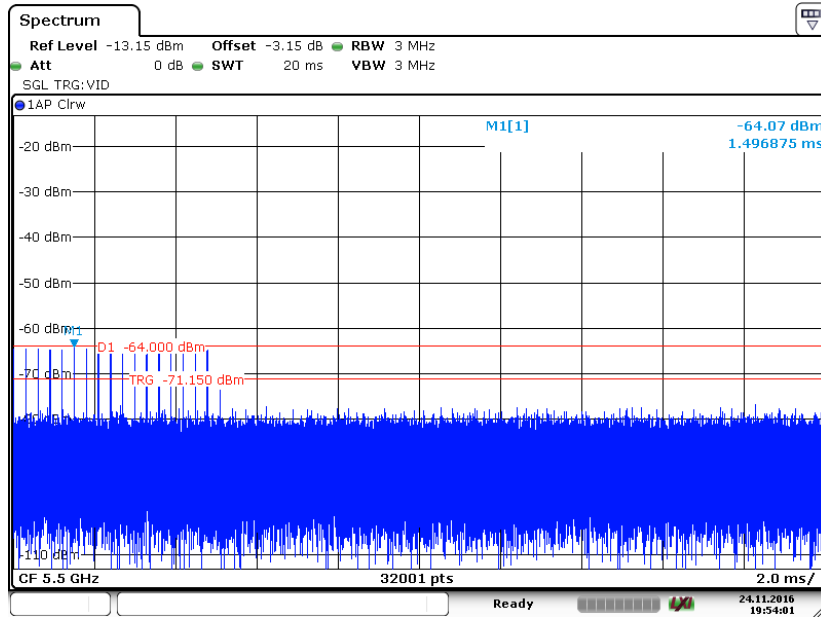

Radar Type 4

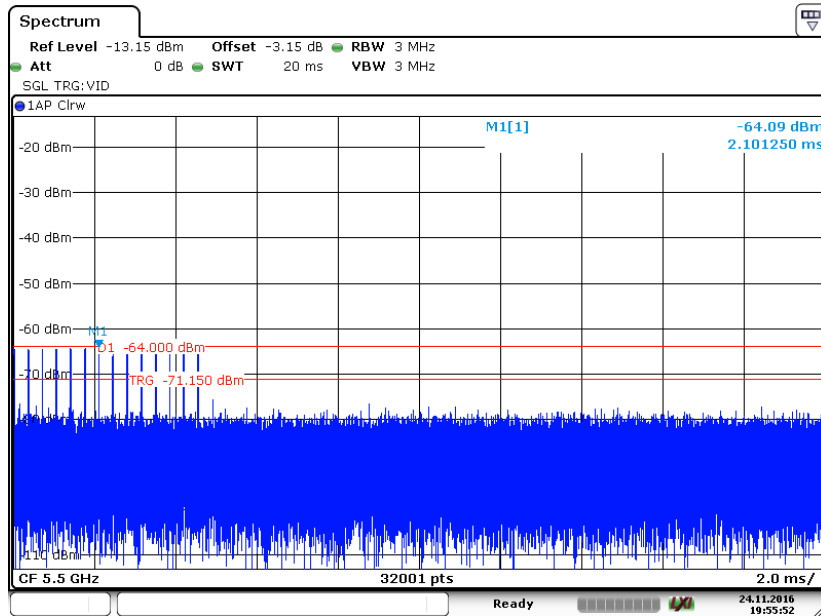

Radar Type 5

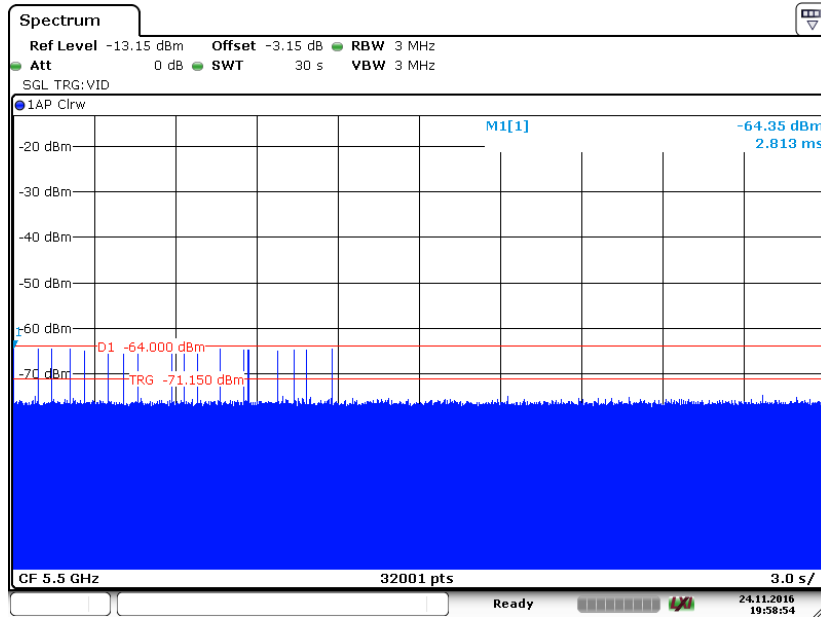

Date: 24.NOV.2016 19:58:54

Radar Type 6

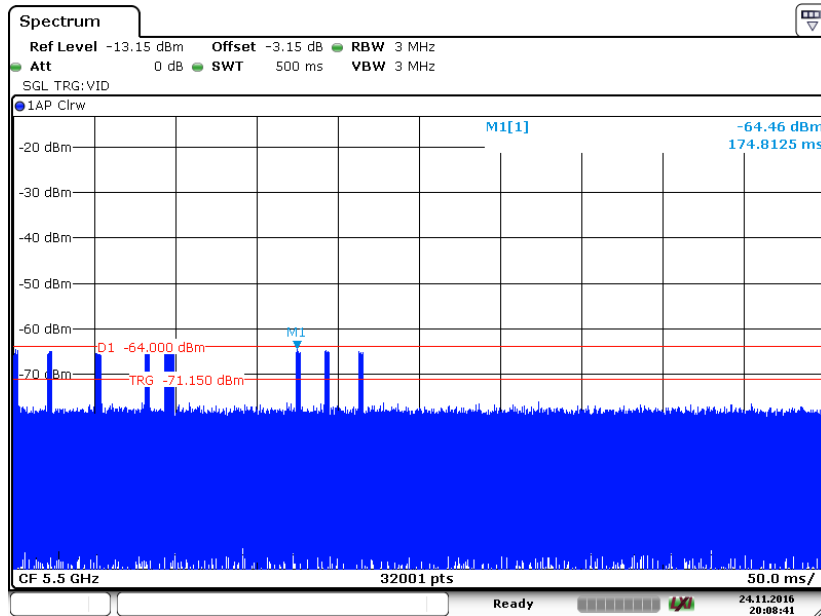

Date: 24.NOV.2016 20:08:37

CHANNEL AVAILABILITY CHECK TIME (CAC)

Test Procedure

- 1) Channel Availability Check Time (CAC)
- 2) With link established on channel, apply a radar signal within 0~6 seconds after the initial power-up period; monitor the transmissions on channel from the spectrum analyzer.
- 3) Reboot EUT, with a link established on channel, apply a radar signal within 54~60 seconds after the initial power-up period, and monitor the transmission on channel from the spectrum analyzer.

EUT Initial power-up Cycle Time

Test Frequency (MHz)	EUT initial Power-up cycle (Second)
5280	248.6
5500	252.1

Results:

Timing of Radar Burst	Spectrum Analyzer Display
No Radar Triggered	Transmission begin after power-up cycle +60 seconds CAC
Within 2 seconds of the CAC starting	No transmission
Within the last 2 seconds of the CAC	No transmission

Please refer to the following plots.

5280 MHz:

Plot of without Radar signal applied

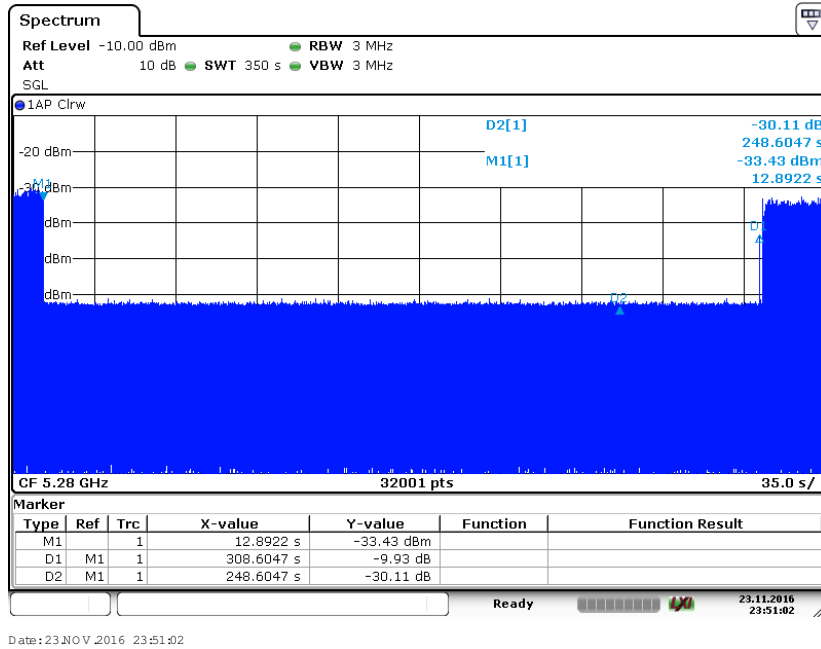

Note: The power-up cycle is 248.6 seconds.

Plot of Radar signal applied within 6 seconds of start of CAC

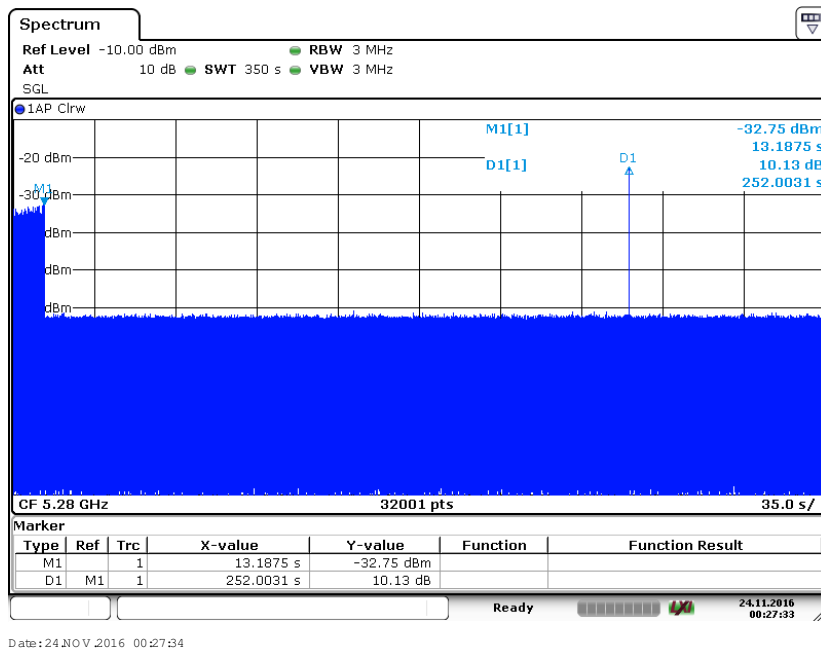

No transmissions found after radar signal applied.

Plot of Radar signal applied at the end of 6 seconds of CAC

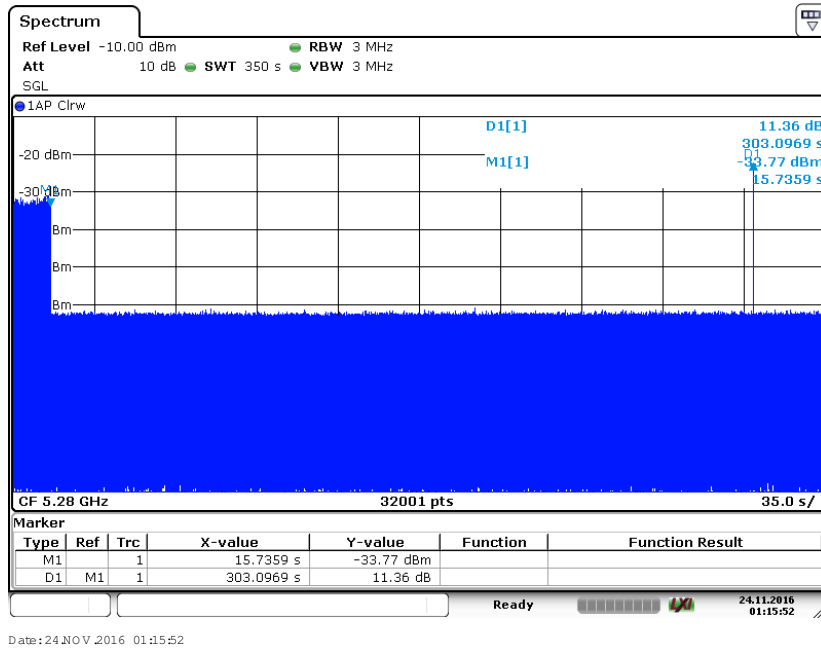

Date: 24 NOV 2016 01:15:52

No transmissions found after radar signal applied.

5500 MHz:

Plot of without Radar signal applied

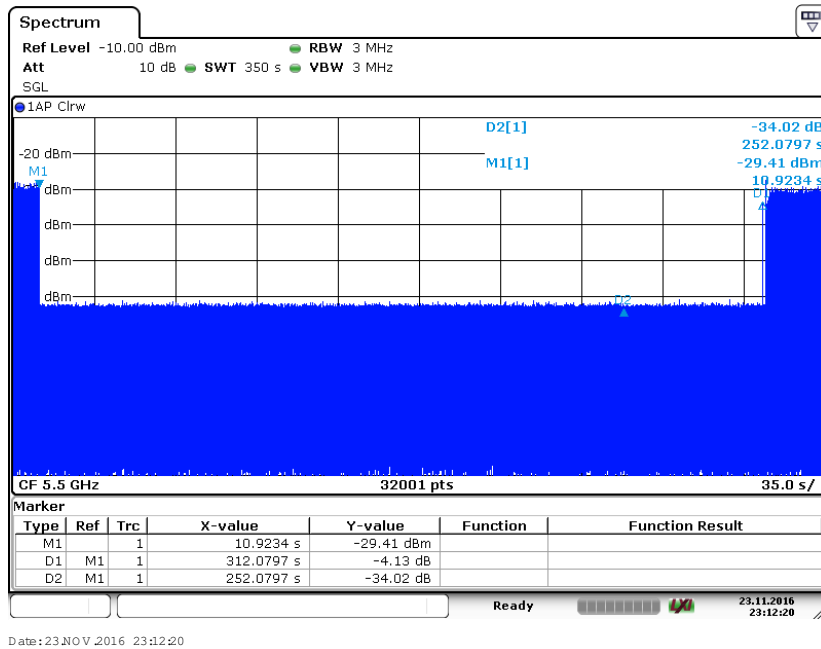

Date: 23 NOV 2016 23:12:20

Note: The power-up cycle is 252.1 seconds.

Plot of Radar signal applied within 6 seconds of start of CAC

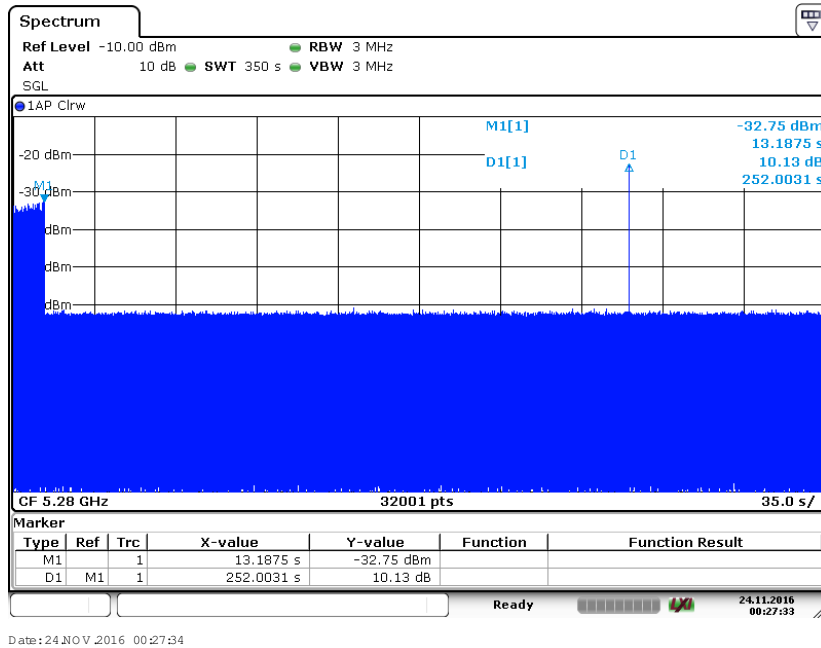

No transmissions found after radar signal applied.

Plot of Radar signal applied at the end of 6 seconds of CAC

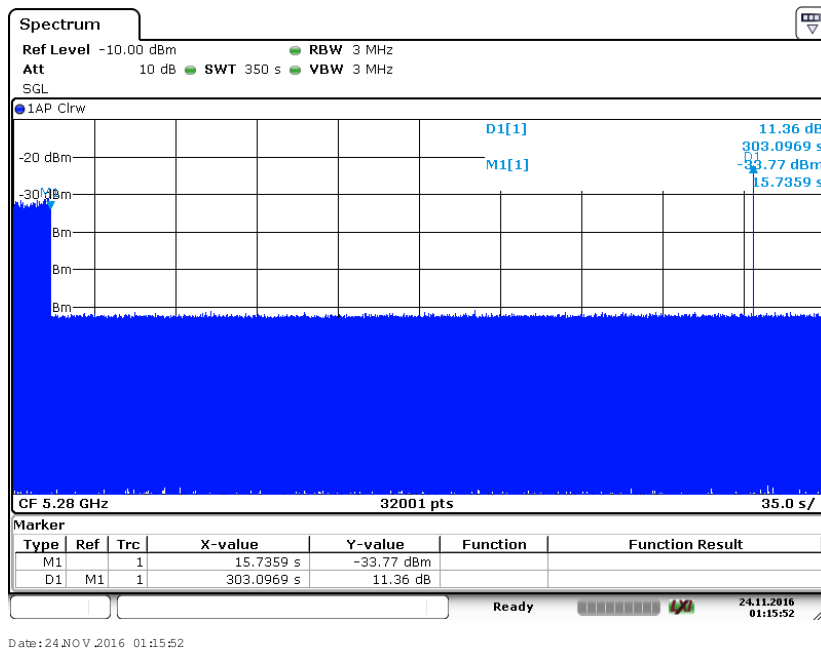

No transmissions found after radar signal applied.

CHANNEL MOVE TIME AND CHANNEL CLOSING TRANSMISSION TIME

Test Procedure

Perform type 0 short pulse radar waveform, repeat using a long pulse radar type5 waveform.
 The aggregate channel closing transmission time is calculated as follows:

$$\text{Aggregate Transmission Time} = N * \text{Dwell Time}$$

N is the number of spectrum analyzer bins showing a device transmission Dwell Time is the dwell time per bin (i.e. $\text{Dwell Time} = S/B$, S is the sweep time and B is the number of bin, i.e. 8192)

Test Results

Frequency (MHz)	Bandwidth (MHz)	Radar Type	Results
5290	80	Type 0	Compliant
5530	80	Type 0	Compliant

Please refer to the following tables and plots.

5290 MHz

Type 0 radar channel move time result:

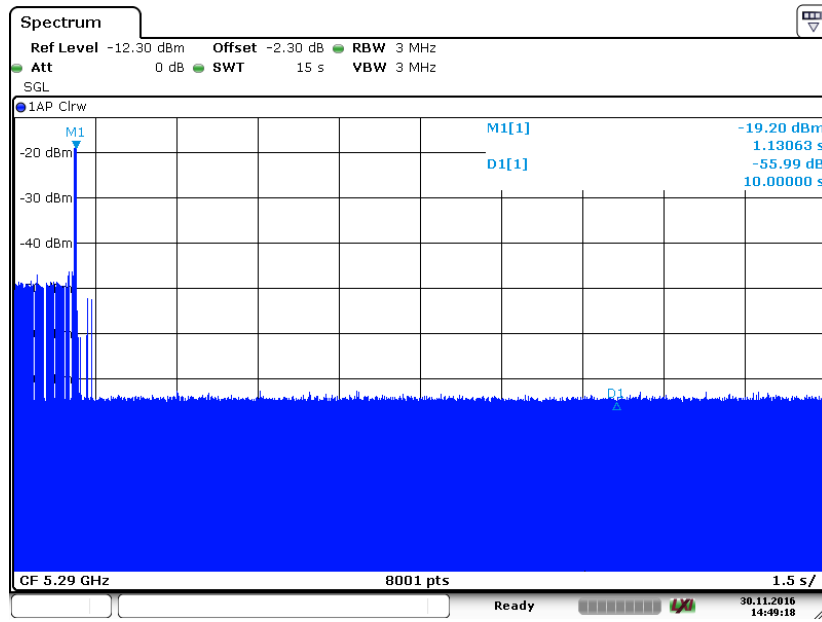

Date: 30.NOV.2016 14:49:16

Type0 radar channel closing transmission time result:

Item	Time (ms)	Limit (ms)
Closing Transmission Time	5.62	200
Aggregate Transmission Time	20.62	60

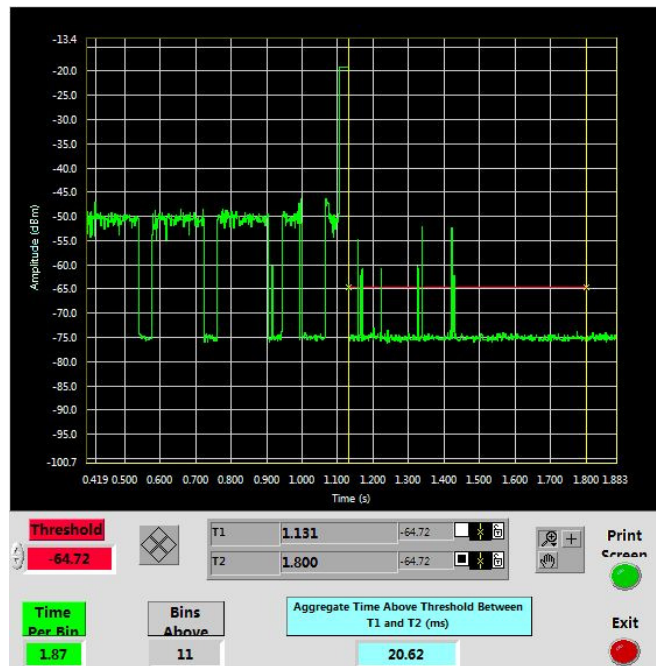
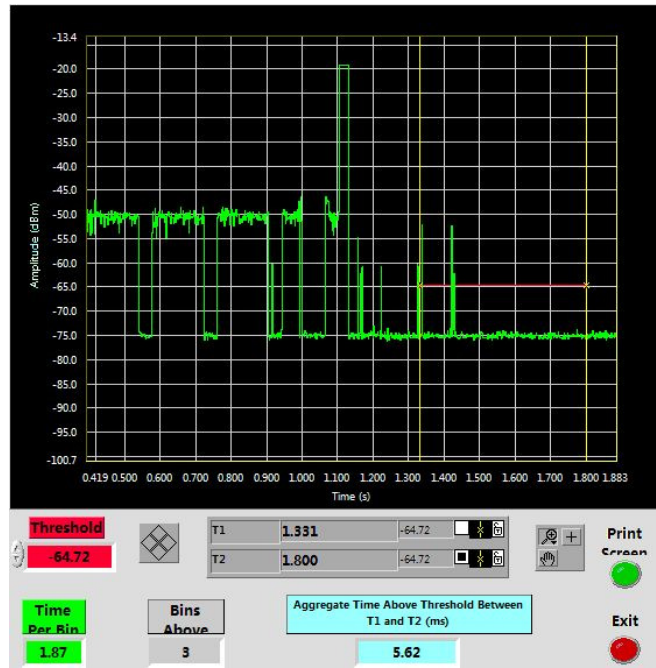

5530 MHz

Type 0 radar channel move time result:

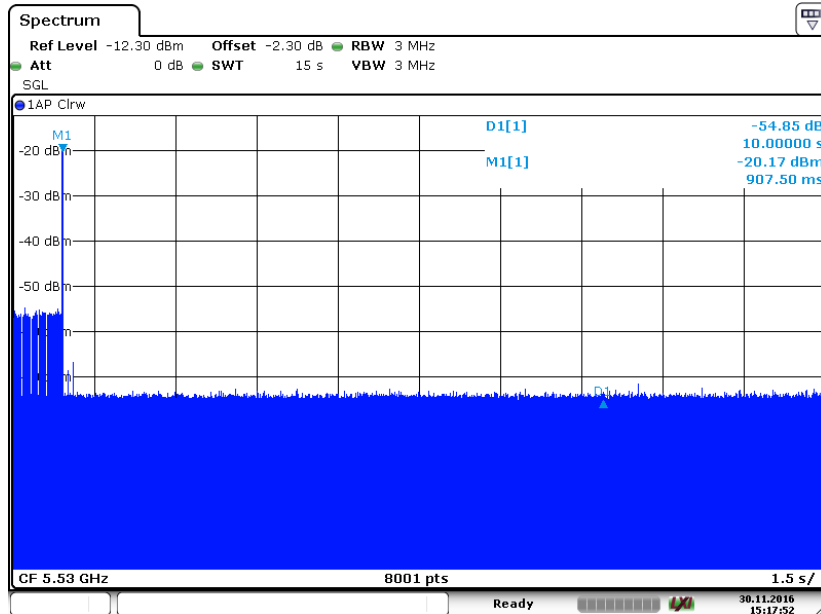

Date: 30.NOV.2016 15:17:52

Type0 radar channel closing transmission time result:

Item	Time (ms)	Limit (ms)
Closing Transmission Time	1.87	200
Aggregate Transmission Time	5.62	60

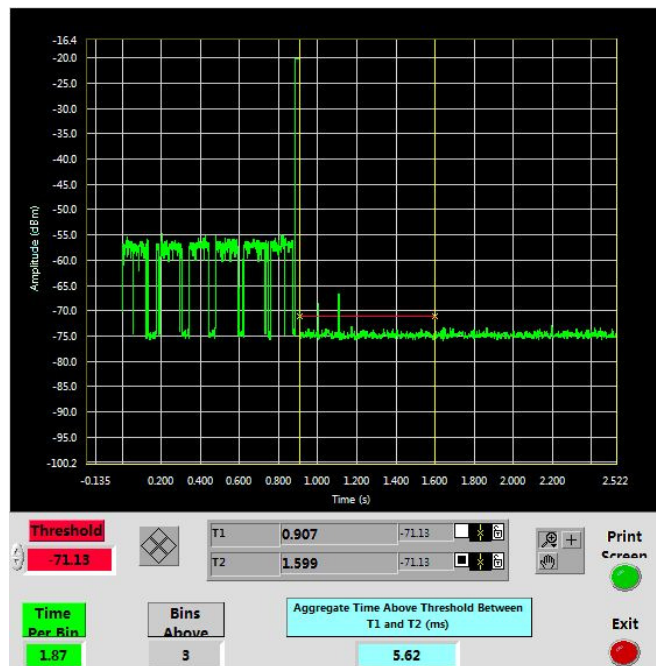
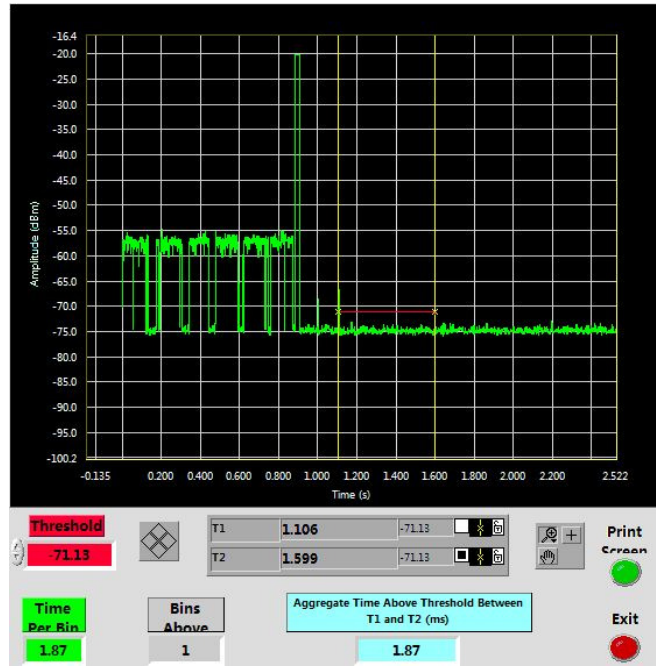

NON-OCCUPANCY PERIOD

Test Procedure

Measure the EUT for more than 30 minutes following the channel close/move time to verify that the EUT does not resume any transmissions on this channel. Provide one plot to demonstrate no transmission on the channel for the non-occupancy period (30 minutes observation time)

Test Result

Frequency(MHz)	Bandwidth (MHz)	Spectrum Analyzer Display
5280	20	No transmission within 30 minutes
5500	20	No transmission within 30 minutes

Please refer to the following plots.

5280 MHz

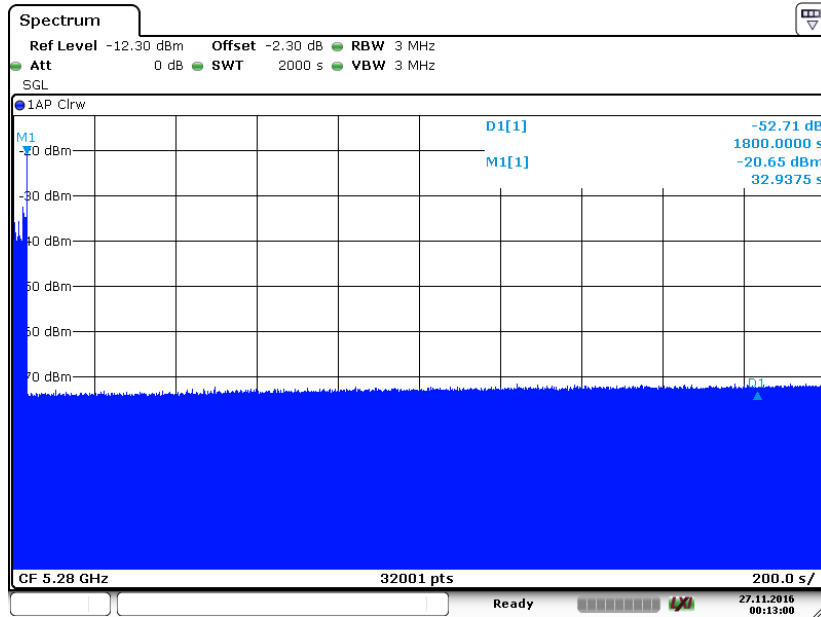

Date: 27.NOV.2016 00:13:01

5500 MHz

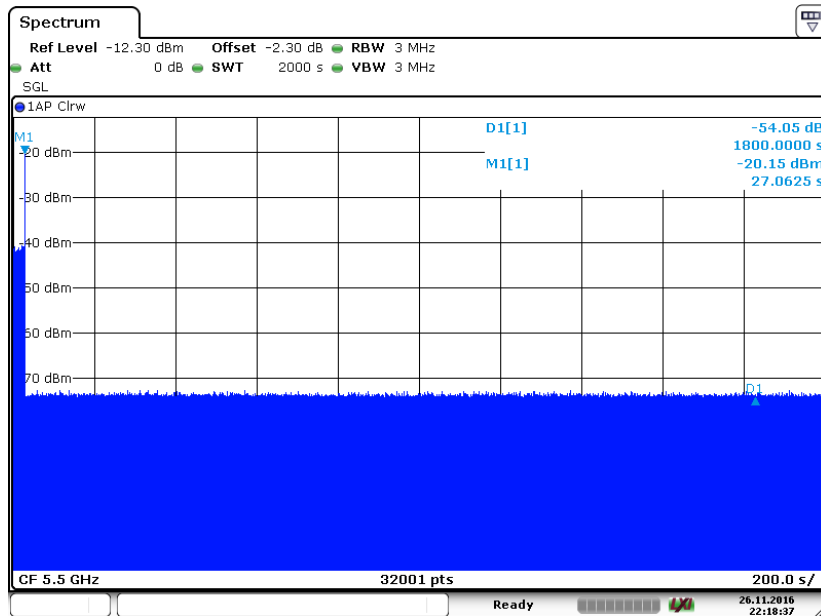

Date: 26.NOV.2016 22:18:37

DETECTION BANDWIDTH

Test Procedure

Performed with Type 0 radar waveforms

Starting at the center frequency of the UUT operating *Channel*, increase the radar frequency in 5 MHz steps, repeating the above test sequence, until the detection rate falls below the *U-NII Detection Bandwidth* criterion specified in **Table 4**. Repeat this measurement in 1MHz steps at frequencies 5 MHz below where the detection rate begins to fall. Record the highest frequency (denote as F_H) at which detection is greater than or equal to the *U-NII Detection Bandwidth* criterion. Recording the detection rate at frequencies above F_H is not required to demonstrate compliance.

Starting at the center frequency of the UUT operating *Channel*, decrease the radar frequency in 5 MHz steps, repeating the above test sequence, until the detection rate falls below the *U-NII Detection Bandwidth* criterion specified in **Table 4**. Repeat this measurement in 1MHz steps at frequencies 5 MHz above where the detection rate begins to fall. Record the lowest frequency (denote as F_L) at which detection is greater than or equal to the *U-NII Detection Bandwidth* criterion. Recording the detection rate at frequencies below F_L is not required to demonstrate compliance.

The *U-NII Detection Bandwidth* is calculated as follows:

$$U-NII\ Detection\ Bandwidth = F_H - F_L$$

The *U-NII Detection Bandwidth* must meet the *U-NII Detection Bandwidth* criterion specified in **Table 4**. Otherwise, the UUT does not comply with DFS requirements. This is essential to ensure that the UUT is capable of detecting *Radar Waveforms* across the same frequency spectrum that contains the significant energy from the system. In the case that the *U-NII Detection Bandwidth* is greater than or equal to the 99 percent power bandwidth for the measured F_H and F_L , the test can be truncated and the *U-NII Detection Bandwidth* can be reported as the measured F_H and F_L .

Test Result

Frequency (MHz)	Bandwidth Systems (MHz)	F_L (MHz)	F_H (MHz)	Detection Bandwidth (MHz)	99% Occupied Bandwidth (MHz)	Minimum Limit	Result
5280	20	5270	5290	20	18.16	100%	Compliance
5310	40	5291	5329	38	36.48	100%	Compliance
5290	80	5251	5329	78	76.16	100%	Compliance
5500	20	5490	5510	20	18.16	100%	Compliance
5510	40	5491	5529	38	36.48	100%	Compliance
5530	80	5491	5569	78	76.16	100%	Compliance

Please refer to the following tables and plots.

Results of Detection Bandwidth:

20MHz Bandwidth, EUT Frequency = 5280MHz											
DFS Detection Trials (1 = Detected, 0 = No Detected)											
Radar Frequency (MHz)	1	2	3	4	5	6	7	8	9	10	Detection Rate (%)
5270(F_L)	1	1	1	1	1	1	1	1	1	1	100 %
5271	1	1	1	1	1	1	1	1	1	1	100 %
5272	1	1	1	1	1	1	1	1	1	1	100 %
5273	1	1	1	1	1	1	1	1	1	1	100 %
5274	1	1	1	1	1	1	1	1	1	1	100 %
5275	1	1	1	1	1	1	1	1	1	1	100 %
5280	1	1	1	1	1	1	1	1	1	1	100 %
5285	1	1	1	1	1	1	1	1	1	1	100 %
5286	1	1	1	1	1	1	1	1	1	1	100 %
5287	1	1	1	1	1	1	1	1	1	1	100 %
5488	1	1	1	1	1	1	1	1	1	1	100 %
5289	1	1	1	1	1	1	1	1	1	1	100 %
5290(F_H)	1	1	1	1	1	1	0	1	1	1	100 %
Detection Bandwidth = F _H – F _L = 5290-5270 = 20 MHz											
EUT 99% BW = 18.16 MHz;											Result: Pass

20MHz Bandwidth, EUT Frequency = 5500MHz											
DFS Detection Trials (1 = Detected, 0 = No Detected)											
Radar Frequency (MHz)	1	2	3	4	5	6	7	8	9	10	Detection Rate (%)
5490(F_L)	1	1	1	1	1	1	0	1	1	1	90 %
5491	1	1	1	1	1	1	1	1	1	1	100 %
5492	1	1	1	1	1	1	1	1	1	1	100 %
5493	1	1	1	1	1	1	1	1	1	1	100 %
5494	1	1	1	1	1	1	1	1	1	1	100 %
5495	1	1	1	1	1	1	1	1	1	1	100 %
5500	1	1	1	1	1	1	1	1	1	1	100 %
5505	1	1	1	1	1	1	1	1	1	1	100 %
5506	1	1	1	1	1	1	1	1	1	1	100 %
5507	1	1	1	1	1	1	1	1	1	1	100 %
5508	1	1	1	1	1	1	1	1	1	1	100 %
5509	1	1	1	1	1	1	1	1	1	1	100 %
5510(F_H)	1	1	1	1	1	1	1	1	1	1	100 %
Detection Bandwidth = F_H - F_L = 5510-5490 = 20 MHz											
EUT 99% BW = 18.16 MHz;											Result: Pass

40MHz Bandwidth, EUT Frequency = 5310 MHz											
DFS Detection Trials (1 = Detected, 0 = No Detected)											
Radar Frequency (MHz)	1	2	3	4	5	6	7	8	9	10	Detection Rate (%)
5291(F_L)	1	1	1	1	1	1	1	1	1	0	90 %
5292	1	1	1	1	1	1	1	1	1	1	100 %
5293	1	1	1	1	1	1	1	1	1	1	100 %
5294	1	1	1	1	1	1	1	1	1	1	100 %
5295	1	1	1	1	1	1	1	1	1	1	100 %
5300	1	1	1	1	1	1	1	1	1	1	100 %
5305	1	1	1	1	0	1	1	1	1	1	90 %
5310	1	1	1	1	1	1	1	1	1	1	100 %
5315	1	1	1	1	1	1	1	1	1	1	100 %
5320	1	1	1	1	1	1	1	1	1	1	100 %
5325	1	1	1	1	1	1	1	1	1	1	100 %
5326	1	1	1	1	1	1	1	1	1	1	100 %
5326	1	1	1	1	1	1	1	1	1	1	100 %
5327	1	1	1	1	0	1	1	1	1	1	90 %
5328	1	0	1	1	1	1	1	1	1	1	90 %
5329(F_H)	1	1	1	1	1	1	1	1	1	1	100 %
Detection Bandwidth = F_H – F_L = 5329-5291 = 38 MHz											
EUT 99% BW = 36.48 MHz;											Result: Pass

40MHz Bandwidth, EUT Frequency = 5510 MHz											
DFS Detection Trials (1 = Detected, 0 = No Detected)											
Radar Frequency (MHz)	1	2	3	4	5	6	7	8	9	10	Detection Rate (%)
5491(F_L)	1	1	1	1	1	1	1	0	1	1	90 %
5492	1	1	1	1	1	1	1	1	1	1	100 %
5493	1	1	1	1	1	1	1	1	1	1	100 %
5494	1	1	1	1	1	1	1	1	1	1	100 %
5495	1	1	1	1	1	1	1	1	1	1	100 %
5500	1	1	1	1	1	1	1	1	1	1	100 %
5505	1	1	1	1	1	1	1	1	1	1	100 %
5510	1	1	1	1	1	1	1	1	1	1	100 %
5515	1	1	1	1	1	1	1	1	1	1	100 %
5520	1	1	1	1	1	1	1	1	1	1	100 %
5525	1	1	1	1	1	1	1	1	1	1	100 %
5526	1	1	1	1	1	1	1	1	1	1	100 %
5527	1	1	1	1	1	1	1	1	1	1	100 %
5528	1	1	1	1	1	0	1	1	1	1	90 %
5529(F_H)	1	1	1	1	1	1	1	1	1	1	100 %
Detection Bandwidth = F _H – F _L = 5529-5491 = 38 MHz											
EUT 99% BW = 36.48 MHz;											Result: Pass

80MHz Bandwidth, EUT Frequency = 5290 MHz											
DFS Detection Trials (1 = Detected, 0 = No Detected)											
Radar Frequency (MHz)	1	2	3	4	5	6	7	8	9	10	Detection Rate (%)
5251(F_L)	1	1	1	1	1	1	1	1	1	1	100 %
5252	1	1	1	1	1	1	1	1	1	1	100 %
5253	1	1	1	1	1	1	1	1	1	1	100 %
5254	1	1	1	1	1	1	1	1	1	1	100 %
5255	1	1	1	1	1	1	1	1	1	1	100 %
5260	1	1	1	1	1	1	1	1	1	1	100 %
5265	1	1	1	1	1	1	1	1	1	1	100 %
5270	1	1	1	1	1	1	1	1	1	1	100 %
5275	1	1	1	1	1	1	1	1	1	1	100 %
5280	1	1	1	1	1	1	1	1	1	1	100 %
5285	1	1	1	1	1	1	1	1	1	1	100 %
5290	1	1	1	1	1	1	1	1	1	1	100 %
5295	1	1	1	1	1	1	1	1	1	1	100 %
5300	1	1	1	1	1	1	1	1	1	1	100 %
5305	1	1	1	1	1	1	1	1	1	1	100 %
5310	1	1	1	1	1	1	1	1	1	1	100 %
5315	1	1	1	1	1	1	0	1	1	1	90 %
5320	1	1	1	1	1	1	1	1	1	1	100 %
5325	1	1	1	1	1	1	1	1	1	1	100 %
5326	1	1	1	1	1	1	1	1	1	1	100 %
5327	1	1	1	1	1	1	1	1	1	1	100 %
5328	1	1	1	1	1	1	1	1	1	1	100 %
5329(F_H)	1	1	1	1	1	1	1	1	0	1	90 %
Detection Bandwidth = F _H - F _L = 5329-5251 = 78 MHz											
EUT 99% BW = 76.16 MHz										Result: Pass	

80MHz Bandwidth, EUT Frequency = 5530 MHz											
DFS Detection Trials (1 = Detected, 0 = No Detected)											
Radar Frequency (MHz)	1	2	3	4	5	6	7	8	9	10	Detection Rate (%)
5491(F_L)	1	1	1	1	1	1	1	1	1	1	100 %
5492	1	1	1	1	1	1	1	1	1	1	100 %
5493	1	1	1	1	1	1	1	1	1	1	100 %
5494	1	1	1	1	1	1	1	1	1	1	100 %
5495	1	0	1	1	1	1	1	1	1	1	90 %
5500	1	1	1	0	1	1	1	1	1	1	90 %
5505	1	1	1	1	1	1	1	1	1	1	100 %
5510	1	1	1	1	1	1	1	1	1	1	100 %
5515	1	1	1	1	1	1	1	1	1	1	100 %
5520	1	1	1	1	1	1	1	1	1	1	100 %
5525	1	1	1	1	1	1	1	1	1	1	100 %
5530	1	1	1	1	1	1	1	1	1	1	100 %
5535	1	1	1	1	1	1	1	1	1	1	100 %
5540	1	1	1	1	1	1	1	1	1	1	100 %
5545	1	1	1	1	1	1	1	1	1	1	100 %
5550	1	1	1	1	1	1	1	1	1	1	100 %
5555	1	1	1	1	1	1	1	1	1	1	100 %
5560	1	1	1	1	1	1	1	1	1	1	100 %
5565	1	1	1	1	1	1	1	1	1	1	100 %
5566	1	1	1	1	1	1	1	1	1	1	100 %
5567	1	1	1	1	1	1	1	1	1	1	100 %
5568	1	1	1	1	1	1	1	1	1	0	90 %
5569(F_H)	1	1	1	1	1	1	1	1	1	1	100 %
Detection Bandwidth = F _H – F _L = 5569-5491 = 78MHz											
EUT 99% BW = 76.16 MHz;											Result: Pass

STATISTICAL PERFORMANCE CHECK

Procedure:

The steps below define the procedure to determine the minimum percentage of successful detection requirements found in **Tables 5-7** when a radar burst with a level equal to the *DFS Detection Threshold* + 1dB is generated on the *Operating Channel* of the U-NII device (*In- Service Monitoring*).

- a) One frequency will be chosen from the *Operating Channels* of the UUT within the 5250-5350 MHz or 5470-5725 MHz bands.
- b) In case the UUT is a U-NII device operating as a Client Device (with or without Radar Detection), a U-NII device operating as a Master Device will be used to allow the UUT (Client device) to Associate with the Master Device. In case the UUT is a Master Device, a U-NII device operating as a Client Device will be used and it is assumed that the Client will Associate with the UUT (Master). In both cases for conducted tests, the Radar Waveform generator will be connected to the Master Device. For radiated tests, the emissions of the Radar Waveform generator will be directed towards the Master Device. If the Master Device has antenna gain, the main beam of the antenna will be directed toward the radar emitter. Vertical polarization is used for testing.
- c) Stream the channel loading test file from the *Master Device* to the Client Device on the test *Channel* for the entire period of the test.
- d) At time T_0 the *Radar Waveform* generator sends the individual waveform for each of the Radar Types 1- 6 in **Tables 5-7**, at levels defined in **Table 3**, on the *Operating Channel*. An additional 1 dB is added to the radar test signal to ensure it is at or above the *DFS Detection Threshold*, accounting for equipment variations/errors.
- e) Observe the transmissions of the UUT at the end of the Burst on the *Operating Channel* for duration greater than 10 seconds for Radar Type 0 to ensure detection occurs.
- f) Observe the transmissions of the UUT at the end of the Burst on the *Operating Channel* for duration greater than 22 seconds for Long Pulse Radar Type 5 to ensure detection occurs.
- g) In case the UUT is a U-NII device operating as a *Client Device* with *In-Service Monitoring*, perform steps a) to f).

Result:

5250-5350MHz, 20MHz,

Radar SignalType	Waveform/Trial Number	Detection (%)	Limit (%)	Pass/Fail
Type 1A	15	100%	60%	pass
Type 1B	15	100%		
Type 2	30	100 %	60%	Pass
Type 3	30	100 %	60%	Pass
Type 4	30	100 %	60%	Pass
Aggregate(Type1 to 4)	120	100 %	80%	Pass
Type 5	30	100%	80%	Pass
Type 6	30	100 %	70%	Pass

Please refer to the following statistical tables:

5280MHz**Radar Type 1A Statistical Performance**

Trial #	Fc (MHz)	Pulse/Burst	Pulse Width (μS)	PRI (μs)	Detection (1:yes; 0:no)
1	5280	72	1	738	1
2	5280	57	1	938	1
3	5280	65	1	818	1
4	5280	78	1	678	1
5	5280	86	1	618	1
6	5280	92	1	578	1
7	5280	70	1	758	1
8	5280	63	1	838	1
9	5280	67	1	798	1
10	5280	83	1	638	1
11	5280	61	1	878	1
12	5280	58	1	918	1
13	5280	74	1	718	1
14	5280	68	1	778	1
15	5280	98	1	538	1
Detection Percentage: 100 % (>60%)					

Radar Type 1B Statistical Performance

Trial #	Fc (MHz)	Pulse/Burst	Pulse Width (μS)	PRI (μs)	Detection (1:yes; 0:no)
1	5280	20	1	2653	1
2	5280	33	1	1635	1
3	5280	52	1	1033	1
4	5280	19	1	2805	1
5	5280	19	1	2841	1
6	5280	22	1	2491	1
7	5280	62	1	857	1
8	5280	24	1	2274	1
9	5280	19	1	2881	1
10	5280	69	1	771	1
11	5280	30	1	1775	1
12	5280	28	1	1886	1
13	5280	43	1	1237	1
14	5280	52	1	1031	1
15	5280	91	1	582	1
Detection Percentage: 100 % (>60%)					

Radar Type 2 Statistical Performance

Trial #	Fc (MHz)	Pulse/Burst	Pulse Width (μS)	PRI (μs)	Detection (1:yes; 0:no)
1	5280	29	3.9	190	1
2	5280	25	2.1	169	1
3	5280	26	1.1	157	1
4	5280	26	3.2	187	1
5	5280	25	4	185	1
6	5280	23	1.4	208	1
7	5280	26	5	167	1
8	5280	26	4.7	209	1
9	5280	27	1.7	208	1
10	5280	26	4.7	173	1
11	5280	29	4.4	153	1
12	5280	25	1.2	229	1
13	5280	24	3.2	156	1
14	5280	28	1.8	162	1
15	5280	23	4.1	164	1
16	5280	23	3.6	229	1
17	5280	25	1.9	179	1
18	5280	26	1.2	171	1
19	5280	29	4.4	230	1
20	5280	26	2.2	162	1
21	5280	27	4.7	216	1
22	5280	29	3.5	219	1
23	5280	26	3.2	226	1
24	5280	24	3.6	195	1
25	5280	23	3.4	170	1
26	5280	27	2.1	174	1
27	5280	27	2.6	229	1
28	5280	24	2.8	194	1
29	5280	28	2.1	185	1
30	5280	28	4.2	165	1
Detection Percentage: 100 % (>60%)					

Radar Type 3 Statistical Performance

Trial #	Fc (MHz)	Pulse/Burst	Pulse Width (µS)	PRI (µs)	Detection (1:yes; 0:no)
1	5280	16	7.3	497	1
2	5280	17	7.6	399	1
3	5280	18	8.4	429	1
4	5280	17	6.6	423	1
5	5280	17	9.2	326	1
6	5280	18	8	389	1
7	5280	16	9.6	350	1
8	5280	16	7.6	356	1
9	5280	17	8	261	1
10	5280	16	9.3	390	1
11	5280	17	9.9	298	1
12	5280	17	7.2	260	1
13	5280	16	7	284	1
14	5280	18	7.9	234	1
15	5280	17	9.2	205	1
16	5280	17	8.7	415	1
17	5280	16	6.3	368	1
18	5280	18	7.1	458	1
19	5280	18	9.1	341	1
20	5280	17	7	412	1
21	5280	17	8.5	382	1
22	5280	18	9.5	403	1
23	5280	17	8	499	1
24	5280	17	9.5	388	1
25	5280	17	7	336	1
26	5280	16	6.1	499	1
27	5280	18	8.5	469	1
28	5280	16	8.7	247	1
29	5280	18	7.5	333	1
30	5280	17	6.9	292	1
Detection Percentage: 100 % (>60%)					

Radar Type 4 Statistical Performance

Trial #	Fc (MHz)	Pulse/Burst	Pulse Width (µS)	PRI (µs)	Detection (1:yes; 0:no)
1	5280	12	16.7	354	1
2	5280	13	16.3	482	1
3	5280	15	14.6	433	1
4	5280	13	16.4	355	1
5	5280	14	16.3	361	1
6	5280	16	12.5	391	1
7	5280	15	15.6	309	1
8	5280	13	15.5	360	1
9	5280	13	17.1	463	1
10	5280	14	20	349	1
11	5280	12	16.1	258	1
12	5280	15	11.8	236	1
13	5280	13	17.3	464	1
14	5280	15	18.1	291	1
15	5280	13	18.8	413	1
16	5280	13	15.2	370	1
17	5280	14	11.8	461	1
18	5280	14	12.1	425	1
19	5280	13	13.4	347	1
20	5280	14	13.4	370	1
21	5280	14	15.5	337	1
22	5280	15	16.4	409	1
23	5280	13	11.9	391	1
24	5280	16	11.2	478	1
25	5280	16	16	432	1
26	5280	12	16.4	435	1
27	5280	15	19.5	336	1
28	5280	16	11.7	291	1
29	5280	15	18.4	236	1
30	5280	14	15.4	266	1
Detection Percentage: 100 % (>60%)					

Radar Type 5 Statistical Performance

Statistics 1 (ChirpCenter Frequency: 5260MHz)

Trial #	Pulse	Chirp(MHz)	Pulse Width (µS)	Pulse 1-2 spacing(µS)	Pulse 2-3 spacing(µS)	Pulse Start(mS)	Detection (1:yes;0:no)
1	3	10	63.2	1720	1982	459.841	1
2	2	10	79.2	1650		14.083	
3	2	10	60.4	1507		516.266	
4	3	10	95.1	1973	1351	707.659	
5	2	10	85.3	1633		485.332	
6	2	10	65.9	1841		371.505	
7	2	10	75.7	1719		215.558	
8	2	10	87.8	1094		271.572	
9	2	10	82.7	1009		649.655	
10	2	10	56.9	1753		173.828	
11	2	10	94.4	1628		653.191	
12	2	10	90.6	1023		592.854	
13	1	10	80.1			206.677	

Statistics 2 (ChirpCenter Frequency: 5260 MHz)

Trial #	Pulse	Chirp(MHz)	Pulse Width (µS)	Pulse 1-2 spacing(µS)	Pulse 2-3 spacing(µS)	Pulse Start(mS)	Detection (1:yes;0:no)
1	3	9	64.9	1706	1914	424.815	1
2	2	9	87.5	1875		376.675	
3	2	9	63.3	1617		407.03	
4	3	9	80.1	1889	1703	525.39	
5	2	9	57.1	1381		154.16	
6	1	9	94.5			533.44	
7	3	9	90.9	1917	1441	463.86	
8	2	9	57.3	1342		436.56	
9	2	9	85.7	1566		247.64	
10	1	9	73.8			291.03	
11	3	9	59	1684	1923	407.93	
12	1	9	55.7			180.69	
13	2	9	59.4	1325		70.35	
14	3	9	93.2	1697	1608	145.24	
15	2	9	73.2	1272		2.26	
16	1	9	71.5			579.24	
17	2	9	52.3	1800		55.57	
18	1	9	89.8			84.9	
19	3	9	85.7	1053	1377	396.9	
20	2	9	81.2	1413		267	

Statistics 3 (ChirpCenter Frequency: 5260 MHz)

Trial #	Pulse	Chirp(MHz)	Pulse Width (µS)	Pulse 1-2 spacing(µS)	Pulse 2-3 spacing(µS)	Pulse Start(mS)	Detection (1:yes;0:no)
1	2	14	63.7	1347		166.207	1
2	2	14	70.2	1972		509.93	
3	3	14	63.6	1710	1208	582.36	
4	3	14	92.6	1593	1068	652.07	
5	1	14	74			306.85	
6	3	14	53	1398	1484	212.15	
7	3	14	73.3	1330	1783	8.43	
8	1	14	67.6			504.45	
9	3	14	80.1	1338	1771	399.89	
10	3	14	67.5	1640	1748	496.23	
11	2	14	54.9	1471		117.44	
12	2	14	81.4	1460		221.82	
13	2	14	60.1	1864		450.18	
14	2	14	84.9	1679		620.7	
15	3	14	55.7	1208	1275	296.7	
16	2	14	75.3	1625		593.3	

Statistics 4 (ChirpCenter Frequency: 5260 MHz)

Trial #	Pulse	Chirp(MHz)	Pulse Width (µS)	Pulse 1-2 spacing(µS)	Pulse 2-3 spacing(µS)	Pulse Start(mS)	Detection (1:yes;0:no)
1	1	11	76.2			530.986	1
2	2	11	86.5	1161		537.298	
3	1	11	72.9			555.545	
4	1	11	54.2			1.533	
5	1	11	85.6			342.901	
6	2	11	97.7	1748		341.168	
7	3	11	66.4	1677	1905	142.836	
8	3	11	89.2	1305	1440	114.424	
9	3	11	71.4	1002	1104	333.821	
10	2	11	73.2	1132		229.739	
11	1	11	54.5			658.146	
12	3	11	70.8	1513	1183	91.614	
13	1	11	51.1			257.772	
14	1	11	84.3			392.469	
15	2	11	69	1533		500.847	
16	2	11	81.1	1672		103.565	
17	2	11	55.4	1941		160.282	

Statistics 5(ChirpCenter Frequency: 5260 MHz)

Trial #	Pulse	Chirp(MHz)	Pulse Width (µS)	Pulse 1-2 spacing(µS)	Pulse 2-3 spacing(µS)	Pulse Start(mS)	Detection (1:yes;0:no)
1	2	20	52.7	1333		667.599	1
2	3	20	67.2	1703	1652	456.648	
3	2	20	56.4	1027		221.945	
4	3	20	72.6	1861	1740	375.013	
5	2	20	92.7	1993		449.711	
6	1	20	64.4			526.018	
7	2	20	58.3	1271		71.436	
8	2	20	97.4	1305		16.674	
9	2	20	61.5	1096		633.731	
10	2	20	61.9	1941		330.299	
11	3	20	88.2	1955	1353	590.086	
12	1	20	71.3			639.694	
13	2	20	73.6	1801		513.302	
14	1	20	77.6			427.529	
15	1	20	74.4			312.547	
16	2	20	74.6	1069		458.565	
17	1	20	94.6			447.182	

Statistics 6 (ChirpCenter Frequency: 5260 MHz)

Trial #	Pulse	Chirp(MHz)	Pulse Width (µS)	Pulse 1-2 spacing(µS)	Pulse 2-3 spacing(µS)	Pulse Start(mS)	Detection (1:yes;0:no)
1	2	14	53.9	1502		15.225	1
2	2	14	52.4	1070		963.26	
3	2	14	97	1234		436.94	
4	3	14	64.3	1978	1771	957.44	
5	2	14	75.6	1066		413.19	
6	1	14	52.9			385.23	
7	1	14	71			888.27	
8	2	14	95.7	1634		162.09	
9	2	14	91.2	1241		146.15	
10	1	14	59.3			800.1	
11	2	14	68.5	1872		26.9	
12	2	14	64	1718		292.4	

Statistics 7(ChirpCenter Frequency: 5260 MHz)

Trial #	Pulse	Chirp(MHz)	Pulse Width (µS)	Pulse 1-2 spacing(µS)	Pulse 2-3 spacing(µS)	Pulse Start(mS)	Detection (1:yes;0:no)
1	2	10	58	1489		649.557	1
2	1	10	72.7			122.84	
3	2	10	69.9	1066		830.65	
4	2	10	88.5	1614		990.7	
5	2	10	80.9	1888		954.36	
6	2	10	87.5	1441		344.41	
7	2	10	54.2	1692		616.84	
8	2	10	62.7	1714		921.06	
9	2	10	66.8	1644		672.72	
10	1	10	81.5			95.29	
11	3	10	66.2	1571	1558	159.4	
12	2	10	89.2	1597		931.1	

Statistics 8 (ChirpCenter Frequency: 5260 MHz)

Trial #	Pulse	Chirp(MHz)	Pulse Width (µS)	Pulse 1-2 spacing(µS)	Pulse 2-3 spacing(µS)	Pulse Start(mS)	Detection (1:yes;0:no)
1	2	20	64.8	1119		457.112	1
2	2	20	96.7	1442		522.173	
3	2	20	74.8	1933		601.527	
4	3	20	99.8	1007	1259	298.39	
5	2	20	80.6	1934		257.033	
6	2	20	72.3	1854		25.767	
7	2	20	79.1	1994		71.35	
8	2	20	87.9	1161		405.533	
9	1	20	68.1			632.537	
10	2	20	74.4	1554		513.51	
11	2	20	91.9	1550		249.643	
12	2	20	97.8	1549		206.417	
13	2	20	64.1	1353		232.12	
14	2	20	51.5	1576		131.093	
15	3	20	63.8	1591	1755	23.907	
16	3	20	52.3	1071	1759	463.4	
17	1	20	94.8			335.533	
18	2	20	65.4	1580		78.367	

Statistics 9 (ChirpCenter Frequency: 5260 MHz)

Trial #	Pulse	Chirp(MHz)	Pulse Width (µS)	Pulse 1-2 spacing(µS)	Pulse 2-3 spacing(µS)	Pulse Start(mS)	Detection (1:yes;0:no)
1	2	20	54.2	1869		535.154	1
2	1	20	85.4			252.817	
3	3	20	61	1122	1732	239.933	
4	1	20	80.3			194.23	
5	1	20	58.1			246.957	
6	2	20	92.5	1922		936.273	
7	3	20	59.3	1206	1103	1314	
8	2	20	59.6	1322		901.067	
9	1	20	68.1			782.733	

Statistics 10 (ChirpCenter Frequency: 5280 MHz)

Trial #	Pulse	Chirp(MHz)	Pulse Width (µS)	Pulse 1-2 spacing(µS)	Pulse 2-3 spacing(µS)	Pulse Start(mS)	Detection (1:yes;0:no)
1	2	8	63.6	1338		989.19	1
2	2	8	82.3	1210		300.801	
3	2	8	55.7	1244		589.342	
4	2	8	91.1	1057		890.893	
5	2	8	97.6	1872		446.984	
6	2	8	56.7	1479		409.525	
7	2	8	67.3	1847		1071.275	
8	1	8	62.4			661.696	
9	2	8	73.7	1397		3.807	
10	1	8	63.8			632.018	
11	2	8	55.8	1094		502.809	

Statistics 11 (ChirpCenter Frequency: 5255.4 MHz)

Trial #	Pulse	Chirp(MHz)	Pulse Width (µS)	Pulse 1-2 spacing(µS)	Pulse 2-3 spacing(µS)	Pulse Start(mS)	Detection (1:yes;0:no)
1	3	11	66.3	1310	1794	1.258	1
2	2	11	88.3	1343		57.864	
3	1	11	51.5			116.41	
4	3	11	53.8	1586	1664	146.75	
5	2	11	57.7	1645		219.62	
6	3	11	85.8	1237	1287	318.58	
7	2	11	86.8	1140		352.51	
8	3	11	87.1	1196	1439	103.61	
9	2	11	93.3	1152		195.51	
10	3	11	55.2	1130	1794	171.57	
11	1	11	91.6			515.8	
12	2	11	66	1756		51.14	
13	3	11	62.5	1851	1327	620.6	
14	3	11	73.3	1501	1013	370	
15	2	11	70.1	1804		100.2	

Statistics 12 (ChirpCenter Frequency: 5253.4 MHz)

Trial #	Pulse	Chirp(MHz)	Pulse Width (µS)	Pulse 1-2 spacing(µS)	Pulse 2-3 spacing(µS)	Pulse Start(mS)	Detection (1:yes;0:no)
1	3	6	51.3	1303	1886	332.173	0
2	3	6	83.2	1296	1294	385.573	
3	2	6	74.4	1045		184.787	
4	2	6	70.1	1768		245.75	
5	2	6	55.1	1952		433.093	
6	3	6	90.2	1881	1496	498.717	
7	1	6	77.7			23.15	
8	3	6	90.6	1656	1042	118.313	
9	2	6	64.3	1798		33.477	
10	2	6	58.4	1106		243.32	
11	2	6	91.7	1458		278.043	
12	2	6	78.1	1688		22.527	
13	1	6	58.1			448.61	
14	2	6	97.1	1394		650.753	
15	2	6	78.5	1633		233.377	
16	1	6	59.1			498.9	
17	2	6	88.4	1374		639.833	
18	3	6	78.2	1938	1121	481.967	

Statistics 13 (ChirpCenter Frequency: 5257.8 MHz)

Trial #	Pulse	Chirp(MHz)	Pulse Width (µS)	Pulse 1-2 spacing(µS)	Pulse 2-3 spacing(µS)	Pulse Start(mS)	Detection (1:yes;0:no)
1	3	17	64.9	1630	1818	917.986	1
2	2	17	81.6	1563		340.12	
3	2	17	56.9	1848		702.68	
4	2	17	54.6	1656		279.23	
5	3	17	79	1695	1697	715.69	
6	1	17	71.9			83.04	
7	2	17	60	1906		456.49	
8	1	17	76.3			337.71	
9	2	17	74.9	1612		923.83	
10	2	17	52.8	1773		896.3	
11	1	17	79.1			64.3	
12	1	17	53.3			910.8	

Statistics 14 (ChirpCenter Frequency: 5253.8 MHz)

Trial #	Pulse	Chirp(MHz)	Pulse Width (µS)	Pulse 1-2 spacing(µS)	Pulse 2-3 spacing(µS)	Pulse Start(mS)	Detection (1:yes;0:no)
1	1	7	57.8			631.667	1
2	1	7	64.9			786.22	
3	2	7	50.6	1206		553.62	
4	3	7	93.1	1442	1340	787.1	
5	2	7	91.4	1518		706.39	
6	2	7	61.3	1687		501.26	
7	2	7	100	1150		536.15	
8	2	7	77.6	1968		247.64	
9	1	7	67			712.25	
10	1	7	82.9			355.95	
11	3	7	91.7	1596	1431	478.29	
12	3	7	70.9	1027	1151	397.35	
13	2	7	56.1	1499		47.86	
14	2	7	98.5	1293		329.4	
15	2	7	93.6	1155		543.5	

Statistics 15 (ChirpCenter Frequency: 5259 MHz)

Trial #	Pulse	Chirp(MHz)	Pulse Width (µS)	Pulse 1-2 spacing(µS)	Pulse 2-3 spacing(µS)	Pulse Start(mS)	Detection (1:yes;0:no)
1	3	20	90.6	1943	1280	472.72	1
2	1	20	88			292.324	
3	2	20	62.2	1243		503.025	
4	2	20	52.4	1996		450.123	
5	2	20	65.4	1286		425.681	
6	3	20	78.7	1725	1533	8.468	
7	2	20	86.9	1059		38.456	
8	2	20	68.3	1436		410.024	
9	1	20	55.5			423.551	
10	2	20	85.8	1509		458.099	
11	2	20	90.1	1459		155.896	
12	3	20	70.6	1204	1334	346.214	
13	3	20	60.4	1080	1463	112.362	
14	2	20	55.4	1140		541.999	
15	3	20	68.8	1067	1050	353.347	
16	1	20	58			630.365	
17	3	20	59.3	1159	1521	665.482	

Statistics 16 (ChirpCenter Frequency: 5255.4 MHz)

Trial #	Pulse	Chirp(MHz)	Pulse Width (µS)	Pulse 1-2 spacing(µS)	Pulse 2-3 spacing(µS)	Pulse Start(mS)	Detection (1:yes;0:no)
1	3	11	83.7	1757	1967	95.953	1
2	2	11	72.8	1185		160.651	
3	2	11	70.8	1903		389.005	
4	1	11	63.7			109.333	
5	1	11	96.6			473.441	
6	2	11	56.5	1825		675.488	
7	3	11	95	1262	1702	115.076	
8	1	11	99.3			303.224	
9	2	11	96	1147		531.911	
10	2	11	88.8	1475		15.199	
11	2	11	92.3	1347		523.796	
12	3	11	86.7	1583	1777	481.474	
13	3	11	82.5	1951	1533	224.232	
14	2	11	74.8	1581		455.389	
15	1	11	85.6			130.347	
16	3	11	75	1074	1152	482.065	
17	2	11	57.4	1173		396.482	

Statistics 17 (ChirpCenter Frequency: 5258.2 MHz)

Trial #	Pulse	Chirp(MHz)	Pulse Width (µS)	Pulse 1-2 spacing(µS)	Pulse 2-3 spacing(µS)	Pulse Start(mS)	Detection (1:yes;0:no)
1	3	18	88.6	1959	1689	279.877	0
2	2	18	81	1899		19.7	
3	2	18	71.3	1189		1119.58	
4	2	18	78.6	1431		738.86	
5	2	18	90.8	1350		750.77	
6	1	18	92.9			1296.34	
7	3	18	62.4	1879	1930	1367.2	
8	2	18	67.6	1870		1141.2	

Statistics 18 (ChirpCenter Frequency: 5254.2 MHz)

Trial #	Pulse	Chirp(MHz)	Pulse Width (µS)	Pulse 1-2 spacing(µS)	Pulse 2-3 spacing(µS)	Pulse Start(mS)	Detection (1:yes;0:no)
1	2	8	57	1346		437.582	1
2	1	8	53.5			357.637	
3	3	8	68.9	1098	1595	199.704	
4	3	8	79.7	1531	1243	135.201	
5	2	8	84	1543		391.439	
6	3	8	73.2	1457	1640	7.706	
7	3	8	62.8	1119	1381	833.193	
8	2	8	96.2	1870		436.64	
9	2	8	56.6	1840		701.187	
10	1	8	85.1			116.724	
11	2	8	75.9	1725		182.741	
12	2	8	60.1	1745		272.009	
13	2	8	78	1220		33.786	
14	2	8	61.8	1559		257.743	

Statistics 19 (ChirpCenter Frequency: 5258.6 MHz)

Trial #	Pulse	Chirp(MHz)	Pulse Width (µS)	Pulse 1-2 spacing(µS)	Pulse 2-3 spacing(µS)	Pulse Start(mS)	Detection (1:yes;0:no)
1	2	19	96.7	1263		914.423	1
2	3	19	54.3	1021	1108	765.793	
3	1	19	78.9			840.716	
4	3	19	58.5	1374	1402	741.269	
5	1	19	82.3			180.502	
6	1	19	93.4			177.175	
7	2	19	50.7	1186		568.628	
8	2	19	92	1690		147.802	
9	2	19	71.3	1315		572.195	
10	2	19	70.1	1476		479.608	
11	1	19	98			371.661	
12	3	19	68.9	1856	1205	446.354	
13	3	19	74.2	1449	1112	630.677	

Statistics 20 (ChirpCenter Frequency: 5253.4 MHz)

Trial #	Pulse	Chirp(MHz)	Pulse Width (µS)	Pulse 1-2 spacing(µS)	Pulse 2-3 spacing(µS)	Pulse Start(mS)	Detection (1:yes;0:no)
1	1	6	96.6			698.125	1
2	3	6	72.3	1359	1626	953.8	
3	2	6	73.9	1841		933.98	
4	2	6	99.5	1462		713.56	
5	2	6	74.2	1992		745.69	
6	3	6	83.2	1934	1777	564.7	
7	2	6	85.3	1784		249.88	
8	3	6	71.5	1604	1616	802.98	
9	2	6	96.4	1409		917.5	
10	1	6	91.3			1139.6	

Statistics 21 (ChirpCenter Frequency: 5263.8 MHz)

Trial #	Pulse	Chirp(MHz)	Pulse Width (μS)	Pulse 1-2 spacing(μS)	Pulse 2-3 spacing(μS)	Pulse Start(mS)	Detection (1:yes;0:no)
1	2	13	58.8	1788		397.652	1
2	2	13	69.5	1787		601.247	
3	2	13	76.6	1915		480.683	
4	2	13	83.5	1725		72.27	
5	3	13	95.1	1349	1435	169.037	
6	1	13	80.2			1007.673	
7	2	13	84.7	1334		138.47	
8	3	13	52.7	1409	1014	521.537	
9	2	13	80.3	1216		306.333	

Statistics 22 (ChirpCenter Frequency: 5264.2 MHz)

Trial #	Pulse	Chirp(MHz)	Pulse Width (μS)	Pulse 1-2 spacing(μS)	Pulse 2-3 spacing(μS)	Pulse Start(mS)	Detection (1:yes;0:no)
1	1	12	91.7			188.923	1
2	1	12	65.3			323.71	
3	2	12	88	1797		148.35	
4	1	12	68.4			2.92	
5	3	12	62.3	1201	1755	404.83	
6	1	12	62.6			13.16	
7	1	12	81.2			188.27	
8	2	12	77.7	1297		193.48	
9	2	12	70.4	1868		294.83	
10	1	12	70.4			76.33	
11	2	12	53.3	1713		441.37	
12	1	12	83.2			80.07	
13	2	12	63.7	1785		147.36	
14	3	12	65.6	1499	1491	185.96	
15	2	12	70.3	1242		414.56	
16	3	12	80.6	1141	1009	397.42	
17	3	12	93.7	1487	1648	170.5	
18	3	12	57.7	1126	1233	257.7	
19	2	12	85.4	1102		440.6	
20	2	12	83.5	1408		235.6	

Statistics 23 (ChirpCenter Frequency: 5261 MHz)

Trial #	Pulse	Chirp(MHz)	Pulse Width (µS)	Pulse 1-2 spacing(µS)	Pulse 2-3 spacing(µS)	Pulse Start(mS)	Detection (1:yes;0:no)
1	3	20	55.5	1686	1566	355.125	1
2	2	20	61.3	1876		68.532	
3	3	20	62.3	1199	1094	544.187	
4	1	20	69.6			484.37	
5	2	20	51.6	1793		512.953	
6	2	20	85.6	1120		213.157	
7	2	20	99	1682		299.81	
8	3	20	92.2	1813	1723	145.733	
9	2	20	94.1	1714		148.787	
10	2	20	58.6	1212		16.12	
11	1	20	69.6			8.963	
12	2	20	66.5	1436		659.467	
13	3	20	79.7	1291	1786	131.23	
14	3	20	77.4	1495	1959	435.163	
15	1	20	88.3			502.237	
16	2	20	99.3	1134		203	
17	2	20	73.5	1291		484.433	
18	2	20	73.1	1563		68.967	

Statistics 24 (ChirpCenter Frequency: 5263 MHz)

Trial #	Pulse	Chirp(MHz)	Pulse Width (µS)	Pulse 1-2 spacing(µS)	Pulse 2-3 spacing(µS)	Pulse Start(mS)	Detection (1:yes;0:no)
1	3	15	92.5	1445	1031	348.413	1
2	3	15	95.7	1689	1503	334.964	
3	2	15	69.6	1683		363.73	
4	2	15	54.7	1540		424.33	
5	2	15	58.4	1512		257.93	
6	3	15	53.2	1865	1339	265.3	
7	2	15	76.5	1551		195.23	
8	2	15	68.9	1809		105.05	
9	3	15	82.2	1142	1179	490.69	
10	1	15	99.3			33.72	
11	2	15	54.1	1165		159.81	
12	1	15	96.3			387.67	
13	1	15	98.7			260.35	
14	2	15	73.8	1829		440.6	
15	3	15	78.5	1964	1630	481.44	
16	2	15	60.9	1797		130.44	
17	1	15	81.5			286.97	
18	2	15	59.3	1144		97.7	
19	1	15	99.2			335.2	
20	3	15	86.6	1079	1883	438.4	

Statistics 25 (ChirpCenter Frequency: 5267 MHz)

Trial #	Pulse	Chirp(MHz)	Pulse Width (µS)	Pulse 1-2 spacing(µS)	Pulse 2-3 spacing(µS)	Pulse Start(mS)	Detection (1:yes;0:no)
1	3	5	96.1	1703	1847	773.346	1
2	3	5	54.6	1976	1752	429.453	
3	3	5	98	1251	1772	131.266	
4	1	5	69.5			30.989	
5	2	5	79	1091		499.242	
6	2	5	81.8	1510		182.215	
7	3	5	70.7	1644	1643	222.548	
8	3	5	51.8	1020	1962	566.782	
9	2	5	55.9	1008		253.255	
10	2	5	58.2	1241		453.788	
11	3	5	69.7	1016	1886	403.671	
12	1	5	60.2			74.454	
13	2	5	74.8	1367		673.577	

Statistics 26 (ChirpCenter Frequency: 5261.8 MHz)

Trial #	Pulse	Chirp(MHz)	Pulse Width (µS)	Pulse 1-2 spacing(µS)	Pulse 2-3 spacing(µS)	Pulse Start(mS)	Detection (1:yes;0:no)
1	3	18	66.3	1183	1583	201.457	1
2	3	18	52.2	1593	1325	418.25	
3	2	18	91.9	1418		459.88	
4	1	18	53.6			669.15	
5	2	18	80.6	1464		135.99	
6	1	18	78.3			296.25	
7	3	18	68	1738	1549	99.58	
8	2	18	76.4	1125		920.46	
9	2	18	70.7	1975		636.92	
10	2	18	51.5	1959		664.1	
11	2	18	85.9	1447		907.5	
12	2	18	91.4	1813		345.2	

Statistics 27 (ChirpCenter Frequency: 5262.2 MHz)

Trial #	Pulse	Chirp(MHz)	Pulse Width (µS)	Pulse 1-2 spacing(µS)	Pulse 2-3 spacing(µS)	Pulse Start(mS)	Detection (1:yes;0:no)
1	2	17	63.6	1570		579.701	1
2	3	17	91.6	1957	1434	467.611	
3	3	17	81.1	1993	1598	451.622	
4	3	17	90	1091	1877	405.603	
5	1	17	62.1			0.014	
6	2	17	76	1970		364.505	
7	1	17	95.1			251.596	
8	2	17	68.3	1533		345.017	
9	1	17	88.7			96.798	
10	2	17	78.9	1447		511.599	
11	2	17	77.7	1463		288.521	
12	1	17	66.5			191.312	
13	1	17	68.8			422.443	
14	2	17	92.8	1074		294.834	
15	1	17	77.3			161.405	
16	2	17	88.3	1325		185.816	
17	1	17	50.3			25.237	
18	1	17	92.2			83.158	
19	3	17	70.3	1162	1389	168.679	

Statistics 28 (ChirpCenter Frequency: 5265.8 MHz)

Trial #	Pulse	Chirp(MHz)	Pulse Width (µS)	Pulse 1-2 spacing(µS)	Pulse 2-3 spacing(µS)	Pulse Start(mS)	Detection (1:yes;0:no)
1	2	8	88.3	1523		260.114	1
2	2	8	83.1	1889		646.398	
3	2	8	90.4	1368		659.605	
4	2	8	74.3	1810		367.213	
5	2	8	82.3	1712		697.841	
6	3	8	81.6	1648	1894	29.798	
7	3	8	54.2	1833	1431	111.936	
8	1	8	69.6			219.654	
9	2	8	63.4	1899		59.111	
10	1	8	78.4			531.349	
11	2	8	85	1097		30.176	
12	1	8	70.8			553.104	
13	2	8	50.1	1255		86.852	
14	1	8	57.9			221.479	
15	3	8	66.8	1241	1822	358.147	
16	1	8	69.2			337.965	
17	2	8	89	1801		690.182	

Statistics 29 (ChirpCenter Frequency: 5261.4 MHz)

Trial #	Pulse	Chirp(MHz)	Pulse Width (µS)	Pulse 1-2 spacing(µS)	Pulse 2-3 spacing(µS)	Pulse Start(mS)	Detection (1:yes;0:no)
1	3	19	60.5	1371	1174	903.957	1
2	3	19	60.6	1756	1631	1059.231	
3	3	19	93.6	1828	1012	929.212	
4	3	19	75	1030	1288	854.603	
5	3	19	85.9	1964	1378	799.014	
6	2	19	82.8	1282		712.225	
7	2	19	98.9	1008		667.815	
8	3	19	92.6	1507	1479	717.896	
9	1	19	80.6			354.967	
10	2	19	79.2	1254		262.918	
11	2	19	61.4	1224		393.209	

Statistics 30 (ChirpCenter Frequency: 5264.6 MHz)

Trial #	Pulse	Chirp(MHz)	Pulse Width (µS)	Pulse 1-2 spacing(µS)	Pulse 2-3 spacing(µS)	Pulse Start(mS)	Detection (1:yes;0:no)
1	2	11	90.7	1412		105.494	1
2	1	11	73			509.9	
3	2	11	60.4	1486		585.41	
4	2	11	68.4	1420		282.56	
5	2	11	53.4	1890		701.2	
6	3	11	97.6	1851	1765	491.01	
7	2	11	56.3	1995		133.13	
8	1	11	91.2			313.95	
9	3	11	80	1185	1489	128.23	
10	1	11	71.5			632.34	
11	3	11	61	1499	1388	660.17	
12	2	11	73	1510		365.63	
13	3	11	62.5	1933	1187	195.37	
14	2	11	96	1508		695.3	
15	3	11	94.1	1062	1156	502.7	
16	3	11	79.4	1218	1980	75.7	

Radar Type 6 Statistical Performance

Trial #	Fc (MHz)	Pulse /Burst	Pulse Width (µS)	PRI (µs)	Detection (1:yes; 0:no)	Hopping Sequence(GHz)
1	5280	9	1	333	1	5.452, 5.390, 5.487, 5.392, 5.475, 5.649, 5.597, 5.484, 5.614, 5.320, 5.369, 5.546, 5.387, 5.443, 5.255, 5.365, 5.640, 5.643, 5.334, 5.271, 5.378, 5.469, 5.564, 5.424, 5.697, 5.635, 5.459, 5.377, 5.595, 5.552, 5.494, 5.362, 5.426, 5.625, 5.407, 5.315, 5.616, 5.569, 5.532, 5.417, 5.683, 5.715, 5.385, 5.504, 5.690, 5.439, 5.718, 5.530, 5.358, 5.676, 5.545, 5.396, 5.682, 5.694, 5.299, 5.540, 5.544, 5.580, 5.411, 5.349, 5.345, 5.451, 5.337, 5.542, 5.402, 5.280, 5.425, 5.441, 5.630, 5.261, 5.593, 5.561, 5.380, 5.551, 5.328, 5.479, 5.670, 5.305, 5.292, 5.482, 5.617, 5.335, 5.553, 5.281, 5.347, 5.623, 5.316, 5.270, 5.692, 5.360, 5.465, 5.311, 5.457, 5.481, 5.517, 5.505, 5.679, 5.370, 5.300, 5.383
2	5280	9	1	333	1	5.398, 5.562, 5.616, 5.409, 5.720, 5.665, 5.655, 5.602, 5.460, 5.394, 5.415, 5.555, 5.431, 5.366, 5.569, 5.531, 5.598, 5.299, 5.355, 5.473, 5.697, 5.628, 5.451, 5.699, 5.290, 5.261, 5.352, 5.670, 5.405, 5.426, 5.439, 5.545, 5.544, 5.391, 5.257, 5.693, 5.712, 5.528, 5.471, 5.353, 5.380, 5.645, 5.717, 5.713, 5.293, 5.404, 5.337, 5.255, 5.304, 5.363, 5.298, 5.610, 5.370, 5.558, 5.464, 5.618, 5.340, 5.538, 5.521, 5.626, 5.448, 5.329, 5.457, 5.437, 5.421, 5.599, 5.344, 5.350, 5.478, 5.332, 5.253, 5.265, 5.604, 5.482, 5.311, 5.706, 5.378, 5.547, 5.705, 5.512, 5.501, 5.523, 5.495, 5.310, 5.282, 5.650, 5.694, 5.263, 5.566, 5.319, 5.549, 5.685, 5.365, 5.322, 5.641, 5.297, 5.349, 5.413, 5.383, 5.312
3	5280	9	1	333	1	5.632, 5.250, 5.609, 5.360, 5.619, 5.441, 5.420, 5.269, 5.563, 5.482, 5.602, 5.294, 5.548, 5.446, 5.376, 5.449, 5.492, 5.534, 5.319, 5.265, 5.564, 5.434, 5.253, 5.670, 5.286, 5.677, 5.321, 5.590, 5.328, 5.579, 5.358, 5.287, 5.329, 5.630, 5.572, 5.662, 5.637, 5.290, 5.489, 5.282, 5.626, 5.561, 5.555, 5.316, 5.689, 5.390, 5.502, 5.472, 5.547, 5.694, 5.301, 5.268, 5.499, 5.456, 5.251, 5.646, 5.488, 5.443, 5.711, 5.322, 5.651, 5.264, 5.520, 5.607, 5.537, 5.586, 5.695, 5.485, 5.467, 5.477, 5.363, 5.298, 5.293, 5.304, 5.369, 5.483, 5.641, 5.351, 5.708, 5.468, 5.252, 5.295, 5.517, 5.571, 5.356, 5.578, 5.466, 5.664, 5.593, 5.274, 5.270, 5.554, 5.504, 5.627, 5.673, 5.588, 5.495, 5.557, 5.510, 5.263
4	5280	9	1	333	1	5.411, 5.312, 5.705, 5.377, 5.345, 5.463, 5.440, 5.688, 5.339, 5.505, 5.563, 5.691,

						5.652, 5.390, 5.519, 5.340, 5.293, 5.263, 5.331, 5.648, 5.609, 5.297, 5.709, 5.416, 5.722, 5.279, 5.262, 5.314, 5.399, 5.487, 5.265, 5.461, 5.465, 5.600, 5.445, 5.646, 5.723, 5.429, 5.373, 5.712, 5.438, 5.496, 5.424, 5.538, 5.462, 5.327, 5.504, 5.366, 5.386, 5.363, 5.396, 5.483, 5.349, 5.466, 5.592, 5.387, 5.694, 5.471, 5.388, 5.472, 5.524, 5.584, 5.633, 5.687, 5.499, 5.382, 5.494, 5.595, 5.324, 5.302, 5.336, 5.439, 5.575, 5.548, 5.619, 5.475, 5.375, 5.367, 5.555, 5.479, 5.520, 5.285, 5.697, 5.359, 5.389, 5.525, 5.640, 5.501, 5.456, 5.669, 5.303, 5.533, 5.516, 5.275, 5.392, 5.549, 5.395, 5.610, 5.624, 5.486
5	5280	9	1	333	1	5.513, 5.389, 5.381, 5.664, 5.332, 5.584, 5.258, 5.348, 5.315, 5.402, 5.390, 5.548, 5.557, 5.541, 5.579, 5.486, 5.596, 5.536, 5.261, 5.293, 5.476, 5.712, 5.363, 5.379, 5.260, 5.542, 5.671, 5.708, 5.439, 5.645, 5.427, 5.660, 5.597, 5.457, 5.595, 5.492, 5.505, 5.327, 5.421, 5.621, 5.606, 5.370, 5.311, 5.408, 5.535, 5.707, 5.355, 5.672, 5.714, 5.709, 5.358, 5.479, 5.279, 5.472, 5.675, 5.651, 5.471, 5.560, 5.352, 5.489, 5.478, 5.611, 5.540, 5.407, 5.338, 5.405, 5.692, 5.652, 5.257, 5.514, 5.633, 5.721, 5.428, 5.254, 5.291, 5.373, 5.386, 5.719, 5.583, 5.383, 5.424, 5.276, 5.250, 5.387, 5.267, 5.277, 5.528, 5.522, 5.377, 5.624, 5.687, 5.296, 5.599, 5.545, 5.447, 5.412, 5.401, 5.290, 5.406, 5.403
6	5280	9	1	333	1	5.466, 5.457, 5.349, 5.280, 5.329, 5.309, 5.452, 5.465, 5.436, 5.710, 5.702, 5.447, 5.438, 5.283, 5.266, 5.563, 5.459, 5.460, 5.327, 5.382, 5.554, 5.673, 5.635, 5.544, 5.675, 5.496, 5.612, 5.448, 5.686, 5.324, 5.567, 5.449, 5.316, 5.514, 5.712, 5.472, 5.487, 5.359, 5.315, 5.507, 5.505, 5.273, 5.308, 5.495, 5.565, 5.623, 5.351, 5.394, 5.293, 5.509, 5.381, 5.538, 5.372, 5.456, 5.723, 5.301, 5.342, 5.518, 5.598, 5.499, 5.297, 5.384, 5.671, 5.647, 5.335, 5.641, 5.299, 5.681, 5.395, 5.643, 5.444, 5.510, 5.574, 5.302, 5.515, 5.687, 5.532, 5.282, 5.339, 5.250, 5.356, 5.461, 5.494, 5.541, 5.500, 5.617, 5.387, 5.513, 5.573, 5.270, 5.388, 5.639, 5.440, 5.373, 5.665, 5.506, 5.638, 5.474, 5.357, 5.695
7	5280	9	1	333	1	5.639, 5.268, 5.608, 5.352, 5.597, 5.708, 5.523, 5.711, 5.258, 5.426, 5.443, 5.498, 5.666, 5.333, 5.310, 5.550, 5.293, 5.424, 5.467, 5.349, 5.543, 5.615, 5.334, 5.581, 5.699, 5.266, 5.586, 5.573, 5.463, 5.562, 5.331, 5.552, 5.431, 5.265, 5.578, 5.510, 5.528, 5.422, 5.691, 5.264, 5.448, 5.315, 5.572, 5.325, 5.449, 5.644, 5.364, 5.367, 5.417, 5.713, 5.433, 5.347, 5.650, 5.275, 5.390, 5.567, 5.256, 5.482, 5.690, 5.452, 5.689, 5.462, 5.285, 5.290, 5.505, 5.584,

						5.403, 5.493, 5.476, 5.299, 5.427, 5.297, 5.366, 5.400, 5.707, 5.694, 5.530, 5.474, 5.429, 5.407, 5.576, 5.389, 5.397, 5.406, 5.391, 5.588, 5.548, 5.296, 5.580, 5.434, 5.359, 5.542, 5.395, 5.350, 5.304, 5.439, 5.408, 5.652, 5.693, 5.679
8	5280	9	1	333	1	5.517, 5.585, 5.379, 5.493, 5.368, 5.471, 5.414, 5.455, 5.595, 5.266, 5.436, 5.292, 5.361, 5.259, 5.508, 5.271, 5.462, 5.669, 5.689, 5.524, 5.635, 5.500, 5.339, 5.466, 5.683, 5.375, 5.550, 5.526, 5.417, 5.629, 5.345, 5.285, 5.380, 5.342, 5.590, 5.639, 5.499, 5.599, 5.390, 5.489, 5.421, 5.393, 5.661, 5.480, 5.251, 5.541, 5.366, 5.666, 5.494, 5.673, 5.283, 5.723, 5.447, 5.586, 5.395, 5.589, 5.364, 5.722, 5.403, 5.257, 5.609, 5.518, 5.425, 5.697, 5.579, 5.616, 5.670, 5.347, 5.479, 5.350, 5.574, 5.482, 5.709, 5.318, 5.648, 5.558, 5.316, 5.297, 5.279, 5.668, 5.582, 5.360, 5.571, 5.338, 5.603, 5.418, 5.506, 5.501, 5.424, 5.684, 5.646, 5.434, 5.678, 5.544, 5.547, 5.637, 5.593, 5.467, 5.408, 5.486
9	5280	9	1	333	1	5.482, 5.470, 5.538, 5.359, 5.257, 5.585, 5.569, 5.408, 5.571, 5.505, 5.417, 5.392, 5.292, 5.369, 5.360, 5.588, 5.396, 5.704, 5.325, 5.375, 5.527, 5.707, 5.403, 5.681, 5.533, 5.501, 5.327, 5.443, 5.671, 5.703, 5.458, 5.339, 5.582, 5.547, 5.444, 5.318, 5.433, 5.345, 5.481, 5.539, 5.513, 5.713, 5.256, 5.303, 5.661, 5.418, 5.542, 5.584, 5.596, 5.468, 5.348, 5.688, 5.516, 5.430, 5.268, 5.664, 5.299, 5.696, 5.632, 5.326, 5.368, 5.414, 5.579, 5.611, 5.385, 5.719, 5.663, 5.344, 5.576, 5.715, 5.478, 5.549, 5.475, 5.490, 5.308, 5.346, 5.714, 5.285, 5.724, 5.457, 5.405, 5.573, 5.395, 5.660, 5.499, 5.341, 5.692, 5.483, 5.331, 5.355, 5.370, 5.423, 5.311, 5.398, 5.419, 5.431, 5.682, 5.391, 5.378, 5.634
10	5280	9	1	333	1	5.451, 5.361, 5.564, 5.587, 5.369, 5.322, 5.598, 5.624, 5.274, 5.670, 5.481, 5.664, 5.510, 5.312, 5.429, 5.506, 5.508, 5.593, 5.673, 5.589, 5.599, 5.386, 5.432, 5.550, 5.287, 5.601, 5.588, 5.566, 5.686, 5.467, 5.385, 5.349, 5.633, 5.612, 5.299, 5.558, 5.532, 5.482, 5.676, 5.342, 5.256, 5.395, 5.292, 5.278, 5.438, 5.698, 5.625, 5.562, 5.620, 5.305, 5.628, 5.325, 5.400, 5.547, 5.326, 5.719, 5.524, 5.332, 5.641, 5.414, 5.269, 5.555, 5.662, 5.425, 5.319, 5.672, 5.396, 5.667, 5.452, 5.284, 5.370, 5.259, 5.338, 5.476, 5.302, 5.546, 5.362, 5.397, 5.712, 5.384, 5.714, 5.582, 5.721, 5.434, 5.416, 5.504, 5.486, 5.472, 5.627, 5.490, 5.687, 5.412, 5.527, 5.262, 5.568, 5.576, 5.705, 5.474, 5.430, 5.290
11	5280	9	1	333	1	5.308, 5.706, 5.391, 5.460, 5.276, 5.357, 5.433, 5.375, 5.633, 5.302, 5.389, 5.583, 5.609, 5.332, 5.721, 5.425, 5.257, 5.395,

						5.432, 5.251, 5.529, 5.585, 5.439, 5.591, 5.511, 5.644, 5.665, 5.419, 5.339, 5.605, 5.329, 5.539, 5.360, 5.323, 5.288, 5.501, 5.707, 5.688, 5.593, 5.703, 5.624, 5.647, 5.693, 5.684, 5.370, 5.261, 5.272, 5.494, 5.495, 5.661, 5.626, 5.351, 5.372, 5.723, 5.554, 5.476, 5.394, 5.603, 5.712, 5.380, 5.310, 5.530, 5.424, 5.574, 5.344, 5.568, 5.594, 5.497, 5.618, 5.590, 5.314, 5.313, 5.507, 5.290, 5.600, 5.429, 5.534, 5.683, 5.298, 5.695, 5.401, 5.517, 5.595, 5.390, 5.558, 5.352, 5.562, 5.473, 5.570, 5.309, 5.388, 5.428, 5.342, 5.340, 5.399, 5.274, 5.416, 5.557, 5.292, 5.315
12	5280	9	1	333	1	5.633, 5.481, 5.579, 5.564, 5.374, 5.366, 5.478, 5.399, 5.497, 5.270, 5.361, 5.346, 5.331, 5.291, 5.710, 5.401, 5.282, 5.647, 5.523, 5.358, 5.344, 5.477, 5.594, 5.702, 5.519, 5.314, 5.572, 5.716, 5.296, 5.380, 5.467, 5.603, 5.335, 5.334, 5.495, 5.307, 5.306, 5.286, 5.496, 5.504, 5.321, 5.338, 5.390, 5.582, 5.646, 5.384, 5.439, 5.551, 5.556, 5.717, 5.251, 5.571, 5.376, 5.550, 5.484, 5.696, 5.698, 5.534, 5.410, 5.449, 5.492, 5.546, 5.620, 5.641, 5.494, 5.644, 5.654, 5.611, 5.649, 5.518, 5.461, 5.383, 5.287, 5.655, 5.357, 5.443, 5.545, 5.350, 5.565, 5.260, 5.429, 5.367, 5.573, 5.329, 5.680, 5.279, 5.557, 5.570, 5.691, 5.365, 5.440, 5.312, 5.352, 5.471, 5.351, 5.325, 5.578, 5.432, 5.700, 5.645,
13	5280	9	1	333	1	5.271, 5.650, 5.424, 5.677, 5.702, 5.322, 5.360, 5.395, 5.570, 5.646, 5.590, 5.352, 5.427, 5.517, 5.460, 5.565, 5.666, 5.534, 5.421, 5.306, 5.442, 5.342, 5.625, 5.350, 5.524, 5.603, 5.399, 5.376, 5.497, 5.282, 5.371, 5.453, 5.518, 5.274, 5.626, 5.326, 5.433, 5.315, 5.586, 5.320, 5.674, 5.563, 5.525, 5.455, 5.335, 5.304, 5.542, 5.281, 5.715, 5.639, 5.293, 5.337, 5.359, 5.538, 5.318, 5.266, 5.484, 5.299, 5.522, 5.435, 5.284, 5.690, 5.580, 5.633, 5.710, 5.384, 5.653, 5.467, 5.353, 5.696, 5.699, 5.426, 5.499, 5.508, 5.434, 5.294, 5.417, 5.642, 5.492, 5.662, 5.250, 5.268, 5.635, 5.334, 5.451, 5.437, 5.369, 5.361, 5.393, 5.261, 5.618, 5.471, 5.616, 5.676, 5.348, 5.288, 5.521, 5.385, 5.526, 5.609
14	5280	9	1	333	1	5.606, 5.290, 5.464, 5.462, 5.367, 5.528, 5.714, 5.344, 5.604, 5.532, 5.317, 5.314, 5.569, 5.718, 5.396, 5.368, 5.516, 5.347, 5.643, 5.269, 5.703, 5.580, 5.381, 5.364, 5.592, 5.601, 5.724, 5.312, 5.636, 5.621, 5.416, 5.698, 5.452, 5.514, 5.313, 5.289, 5.477, 5.690, 5.355, 5.512, 5.377, 5.641, 5.517, 5.262, 5.285, 5.573, 5.533, 5.722, 5.568, 5.382, 5.354, 5.620, 5.427, 5.408, 5.707, 5.706, 5.392, 5.405, 5.494, 5.515, 5.358, 5.574, 5.361, 5.549, 5.670, 5.274, 5.263, 5.321, 5.279, 5.483, 5.547, 5.428,

						5.591, 5.281, 5.648, 5.492, 5.634, 5.423, 5.488, 5.524, 5.395, 5.366, 5.588, 5.677, 5.505, 5.359, 5.280, 5.697, 5.268, 5.559, 5.328, 5.415, 5.480, 5.327, 5.653, 5.411, 5.696, 5.451, 5.271, 5.254
15	5280	9	1	333	1	5.517, 5.356, 5.464, 5.668, 5.561, 5.442, 5.328, 5.462, 5.388, 5.406, 5.574, 5.516, 5.295, 5.509, 5.577, 5.664, 5.393, 5.673, 5.450, 5.660, 5.369, 5.636, 5.410, 5.274, 5.579, 5.258, 5.339, 5.700, 5.575, 5.560, 5.677, 5.327, 5.439, 5.661, 5.380, 5.377, 5.663, 5.371, 5.426, 5.447, 5.384, 5.310, 5.587, 5.335, 5.564, 5.563, 5.599, 5.303, 5.453, 5.376, 5.505, 5.567, 5.293, 5.400, 5.441, 5.387, 5.613, 5.647, 5.711, 5.297, 5.572, 5.425, 5.287, 5.512, 5.385, 5.290, 5.603, 5.497, 5.556, 5.459, 5.454, 5.292, 5.313, 5.690, 5.722, 5.609, 5.401, 5.597, 5.675, 5.344, 5.474, 5.272, 5.373, 5.431, 5.403, 5.601, 5.271, 5.300, 5.280, 5.584, 5.332, 5.632, 5.634, 5.424, 5.552, 5.611, 5.480, 5.285, 5.314, 5.699
16	5280	9	1	333	1	5.519, 5.586, 5.410, 5.446, 5.392, 5.336, 5.484, 5.387, 5.582, 5.422, 5.369, 5.545, 5.646, 5.673, 5.409, 5.621, 5.528, 5.527, 5.306, 5.698, 5.619, 5.352, 5.312, 5.319, 5.360, 5.404, 5.631, 5.354, 5.256, 5.267, 5.533, 5.361, 5.394, 5.485, 5.565, 5.470, 5.564, 5.616, 5.291, 5.289, 5.280, 5.627, 5.502, 5.353, 5.254, 5.480, 5.606, 5.707, 5.408, 5.377, 5.421, 5.494, 5.337, 5.651, 5.318, 5.379, 5.441, 5.273, 5.684, 5.688, 5.513, 5.414, 5.391, 5.594, 5.696, 5.671, 5.689, 5.323, 5.452, 5.486, 5.642, 5.313, 5.588, 5.331, 5.383, 5.662, 5.475, 5.685, 5.603, 5.342, 5.381, 5.426, 5.253, 5.428, 5.567, 5.655, 5.523, 5.335, 5.690, 5.615, 5.340, 5.571, 5.668, 5.552, 5.612, 5.490, 5.715, 5.257, 5.301, 5.462
17	5280	9	1	333	1	5.423, 5.424, 5.438, 5.350, 5.431, 5.534, 5.451, 5.400, 5.580, 5.411, 5.657, 5.688, 5.596, 5.368, 5.637, 5.258, 5.668, 5.601, 5.458, 5.678, 5.449, 5.639, 5.298, 5.681, 5.441, 5.379, 5.605, 5.357, 5.559, 5.395, 5.337, 5.444, 5.318, 5.634, 5.723, 5.380, 5.533, 5.273, 5.448, 5.540, 5.719, 5.280, 5.561, 5.284, 5.524, 5.659, 5.682, 5.360, 5.610, 5.388, 5.579, 5.654, 5.331, 5.381, 5.516, 5.590, 5.703, 5.466, 5.335, 5.308, 5.529, 5.435, 5.499, 5.439, 5.387, 5.447, 5.461, 5.685, 5.582, 5.491, 5.323, 5.329, 5.679, 5.644, 5.535, 5.394, 5.459, 5.485, 5.673, 5.412, 5.371, 5.389, 5.556, 5.306, 5.509, 5.518, 5.519, 5.597, 5.593, 5.532, 5.544, 5.498, 5.492, 5.376, 5.712, 5.619, 5.321, 5.562, 5.464, 5.375
18	5280	9	1	333	1	5.701, 5.600, 5.647, 5.614, 5.411, 5.389, 5.383, 5.533, 5.671, 5.504, 5.480, 5.583, 5.297, 5.432, 5.676, 5.375, 5.442, 5.666, 5.267, 5.716, 5.567, 5.486, 5.690, 5.292,

						5.536, 5.643, 5.354, 5.459, 5.352, 5.312, 5.696, 5.627, 5.305, 5.587, 5.549, 5.631, 5.511, 5.273, 5.465, 5.291, 5.472, 5.424, 5.607, 5.258, 5.686, 5.270, 5.558, 5.301, 5.366, 5.409, 5.410, 5.489, 5.406, 5.575, 5.522, 5.633, 5.288, 5.531, 5.630, 5.345, 5.622, 5.637, 5.313, 5.478, 5.665, 5.560, 5.673, 5.326, 5.582, 5.700, 5.498, 5.569, 5.298, 5.257, 5.310, 5.644, 5.667, 5.699, 5.576, 5.554, 5.594, 5.371, 5.596, 5.373, 5.481, 5.568, 5.675, 5.722, 5.285, 5.382, 5.553, 5.510, 5.348, 5.358, 5.691, 5.303, 5.346, 5.440, 5.613, 5.717
19	5280	9	1	333	1	5.702, 5.380, 5.423, 5.622, 5.713, 5.514, 5.428, 5.366, 5.305, 5.343, 5.591, 5.577, 5.636, 5.486, 5.311, 5.608, 5.313, 5.724, 5.301, 5.524, 5.610, 5.408, 5.389, 5.437, 5.324, 5.291, 5.534, 5.321, 5.309, 5.362, 5.721, 5.407, 5.297, 5.519, 5.657, 5.684, 5.256, 5.533, 5.686, 5.653, 5.599, 5.448, 5.563, 5.443, 5.609, 5.259, 5.515, 5.322, 5.285, 5.584, 5.315, 5.277, 5.332, 5.310, 5.452, 5.646, 5.664, 5.582, 5.627, 5.590, 5.262, 5.607, 5.463, 5.304, 5.596, 5.361, 5.716, 5.637, 5.485, 5.493, 5.495, 5.334, 5.501, 5.678, 5.626, 5.549, 5.597, 5.580, 5.615, 5.299, 5.381, 5.512, 5.411, 5.330, 5.338, 5.427, 5.365, 5.509, 5.258, 5.535, 5.341, 5.251, 5.357, 5.676, 5.307, 5.417, 5.625, 5.477, 5.689, 5.518
20	5280	9	1	333	1	5.380, 5.720, 5.419, 5.390, 5.366, 5.437, 5.430, 5.585, 5.615, 5.660, 5.596, 5.425, 5.517, 5.643, 5.420, 5.256, 5.324, 5.562, 5.677, 5.569, 5.371, 5.472, 5.647, 5.723, 5.514, 5.623, 5.523, 5.387, 5.364, 5.448, 5.583, 5.443, 5.411, 5.688, 5.404, 5.391, 5.501, 5.370, 5.302, 5.656, 5.521, 5.717, 5.401, 5.360, 5.694, 5.422, 5.373, 5.467, 5.473, 5.581, 5.712, 5.555, 5.384, 5.652, 5.575, 5.671, 5.295, 5.537, 5.554, 5.650, 5.586, 5.461, 5.255, 5.687, 5.528, 5.666, 5.479, 5.540, 5.681, 5.413, 5.525, 5.436, 5.431, 5.595, 5.318, 5.567, 5.452, 5.352, 5.706, 5.631, 5.721, 5.294, 5.304, 5.657, 5.386, 5.282, 5.484, 5.565, 5.475, 5.439, 5.700, 5.465, 5.542, 5.616, 5.454, 5.369, 5.342, 5.640, 5.307, 5.574
21	5280	9	1	333	1	5.318, 5.594, 5.486, 5.565, 5.694, 5.551, 5.699, 5.624, 5.466, 5.672, 5.544, 5.367, 5.451, 5.611, 5.559, 5.667, 5.271, 5.682, 5.270, 5.396, 5.497, 5.426, 5.502, 5.348, 5.650, 5.495, 5.560, 5.577, 5.424, 5.659, 5.436, 5.696, 5.414, 5.274, 5.280, 5.657, 5.632, 5.394, 5.630, 5.543, 5.479, 5.698, 5.445, 5.644, 5.635, 5.669, 5.555, 5.685, 5.395, 5.437, 5.406, 5.603, 5.420, 5.561, 5.712, 5.432, 5.697, 5.592, 5.571, 5.262, 5.472, 5.453, 5.397, 5.327, 5.668, 5.378, 5.633, 5.613, 5.417, 5.574, 5.552, 5.303, 5.468, 5.289, 5.549, 5.322, 5.721, 5.384,

						5.413, 5.405, 5.507, 5.675, 5.530, 5.341, 5.591, 5.343, 5.676, 5.295, 5.368, 5.723, 5.610, 5.373, 5.317, 5.689, 5.645, 5.251, 5.641, 5.402, 5.362, 5.442
22	5280	9	1	333	1	5.582, 5.445, 5.674, 5.699, 5.315, 5.701, 5.363, 5.302, 5.623, 5.485, 5.553, 5.303, 5.279, 5.573, 5.682, 5.576, 5.715, 5.462, 5.264, 5.532, 5.626, 5.430, 5.686, 5.294, 5.680, 5.253, 5.566, 5.297, 5.280, 5.373, 5.338, 5.437, 5.468, 5.710, 5.367, 5.465, 5.589, 5.641, 5.395, 5.429, 5.423, 5.431, 5.316, 5.446, 5.348, 5.400, 5.350, 5.270, 5.561, 5.353, 5.557, 5.486, 5.396, 5.639, 5.360, 5.335, 5.260, 5.547, 5.508, 5.615, 5.683, 5.489, 5.719, 5.333, 5.723, 5.638, 5.559, 5.402, 5.420, 5.592, 5.483, 5.511, 5.480, 5.385, 5.530, 5.313, 5.359, 5.664, 5.515, 5.328, 5.520, 5.329, 5.657, 5.254, 5.361, 5.617, 5.493, 5.358, 5.572, 5.637, 5.457, 5.533, 5.411, 5.619, 5.403, 5.473, 5.424, 5.539, 5.262, 5.688
23	5280	9	1	333	1	5.412, 5.504, 5.285, 5.724, 5.539, 5.360, 5.375, 5.470, 5.602, 5.288, 5.709, 5.629, 5.478, 5.255, 5.344, 5.537, 5.397, 5.583, 5.683, 5.652, 5.402, 5.282, 5.401, 5.447, 5.669, 5.418, 5.465, 5.454, 5.721, 5.514, 5.257, 5.363, 5.647, 5.427, 5.296, 5.451, 5.549, 5.385, 5.306, 5.383, 5.660, 5.687, 5.567, 5.556, 5.494, 5.624, 5.691, 5.500, 5.674, 5.429, 5.643, 5.251, 5.439, 5.644, 5.389, 5.414, 5.354, 5.701, 5.487, 5.380, 5.303, 5.449, 5.490, 5.298, 5.594, 5.373, 5.574, 5.663, 5.636, 5.287, 5.612, 5.678, 5.350, 5.457, 5.548, 5.312, 5.404, 5.372, 5.473, 5.596, 5.474, 5.538, 5.278, 5.421, 5.676, 5.460, 5.355, 5.696, 5.293, 5.358, 5.581, 5.456, 5.479, 5.472, 5.651, 5.544, 5.484, 5.706, 5.713, 5.551
24	5280	9	1	333	1	5.504, 5.481, 5.450, 5.299, 5.343, 5.455, 5.656, 5.633, 5.662, 5.310, 5.284, 5.577, 5.304, 5.380, 5.254, 5.544, 5.476, 5.278, 5.359, 5.308, 5.663, 5.250, 5.334, 5.604, 5.624, 5.311, 5.622, 5.441, 5.518, 5.594, 5.459, 5.317, 5.267, 5.335, 5.462, 5.347, 5.436, 5.555, 5.422, 5.488, 5.495, 5.611, 5.354, 5.515, 5.469, 5.651, 5.296, 5.432, 5.516, 5.258, 5.587, 5.602, 5.617, 5.675, 5.585, 5.596, 5.391, 5.661, 5.351, 5.571, 5.387, 5.612, 5.567, 5.402, 5.290, 5.293, 5.649, 5.532, 5.589, 5.302, 5.457, 5.444, 5.643, 5.592, 5.641, 5.683, 5.513, 5.350, 5.654, 5.572, 5.648, 5.345, 5.277, 5.260, 5.677, 5.695, 5.411, 5.638, 5.586, 5.686, 5.475, 5.487, 5.384, 5.264, 5.569, 5.349, 5.295, 5.367, 5.539, 5.591
25	5280	9	1	333	1	5.312, 5.392, 5.494, 5.561, 5.250, 5.352, 5.365, 5.276, 5.674, 5.623, 5.515, 5.453, 5.567, 5.709, 5.716, 5.319, 5.251, 5.421, 5.589, 5.384, 5.680, 5.495, 5.363, 5.487, 5.358, 5.373, 5.482, 5.513, 5.587, 5.259,

						5.659, 5.283, 5.327, 5.366, 5.617, 5.522, 5.695, 5.275, 5.394, 5.415, 5.557, 5.501, 5.370, 5.367, 5.353, 5.317, 5.389, 5.446, 5.471, 5.634, 5.644, 5.668, 5.260, 5.432, 5.426, 5.344, 5.350, 5.253, 5.652, 5.465, 5.477, 5.309, 5.461, 5.256, 5.531, 5.592, 5.441, 5.428, 5.648, 5.323, 5.677, 5.408, 5.605, 5.667, 5.357, 5.511, 5.425, 5.321, 5.341, 5.574, 5.686, 5.320, 5.322, 5.629, 5.585, 5.413, 5.411, 5.268, 5.544, 5.286, 5.336, 5.307, 5.703, 5.347, 5.454, 5.310, 5.615, 5.608, 5.699, 5.334
26	5280	9	1	333	1	5.343, 5.533, 5.602, 5.458, 5.433, 5.639, 5.601, 5.396, 5.271, 5.310, 5.332, 5.445, 5.645, 5.634, 5.463, 5.671, 5.308, 5.372, 5.513, 5.420, 5.313, 5.480, 5.651, 5.584, 5.375, 5.718, 5.472, 5.352, 5.501, 5.612, 5.255, 5.624, 5.421, 5.293, 5.336, 5.254, 5.449, 5.683, 5.699, 5.402, 5.571, 5.572, 5.534, 5.564, 5.623, 5.577, 5.450, 5.426, 5.475, 5.380, 5.335, 5.470, 5.370, 5.252, 5.642, 5.389, 5.618, 5.666, 5.354, 5.365, 5.250, 5.299, 5.655, 5.408, 5.459, 5.411, 5.361, 5.280, 5.596, 5.374, 5.446, 5.277, 5.548, 5.696, 5.314, 5.525, 5.619, 5.347, 5.320, 5.355, 5.514, 5.366, 5.711, 5.685, 5.679, 5.294, 5.432, 5.658, 5.326, 5.390, 5.520, 5.306, 5.478, 5.424, 5.392, 5.502, 5.644, 5.704, 5.540, 5.376
27	5280	9	1	333	1	5.401, 5.684, 5.372, 5.547, 5.444, 5.567, 5.571, 5.584, 5.266, 5.676, 5.640, 5.534, 5.562, 5.429, 5.544, 5.345, 5.367, 5.559, 5.674, 5.251, 5.436, 5.417, 5.311, 5.701, 5.548, 5.625, 5.339, 5.452, 5.391, 5.270, 5.395, 5.324, 5.683, 5.360, 5.477, 5.661, 5.713, 5.694, 5.322, 5.489, 5.537, 5.468, 5.440, 5.680, 5.630, 5.276, 5.348, 5.364, 5.267, 5.672, 5.316, 5.652, 5.487, 5.315, 5.485, 5.407, 5.641, 5.592, 5.582, 5.491, 5.414, 5.503, 5.553, 5.531, 5.380, 5.688, 5.542, 5.459, 5.495, 5.536, 5.691, 5.449, 5.366, 5.260, 5.716, 5.658, 5.282, 5.666, 5.451, 5.523, 5.572, 5.293, 5.653, 5.703, 5.529, 5.256, 5.655, 5.314, 5.707, 5.665, 5.649, 5.687, 5.354, 5.586, 5.646, 5.481, 5.328, 5.554, 5.309, 5.258
28	5280	9	1	333	1	5.598, 5.528, 5.553, 5.349, 5.519, 5.623, 5.430, 5.500, 5.522, 5.485, 5.559, 5.404, 5.676, 5.329, 5.525, 5.477, 5.597, 5.696, 5.575, 5.606, 5.470, 5.314, 5.397, 5.501, 5.331, 5.481, 5.318, 5.452, 5.324, 5.578, 5.313, 5.709, 5.546, 5.612, 5.270, 5.307, 5.292, 5.319, 5.566, 5.466, 5.337, 5.312, 5.344, 5.583, 5.694, 5.277, 5.303, 5.464, 5.563, 5.311, 5.384, 5.448, 5.330, 5.392, 5.405, 5.674, 5.514, 5.643, 5.440, 5.413, 5.591, 5.456, 5.461, 5.718, 5.302, 5.409, 5.262, 5.286, 5.626, 5.428, 5.573, 5.416, 5.483, 5.723, 5.432, 5.668, 5.677, 5.513, 5.414, 5.557, 5.629, 5.646, 5.280, 5.621,

						5.695, 5.385, 5.609, 5.710, 5.473, 5.340, 5.394, 5.520, 5.549, 5.289, 5.352, 5.535, 5.341, 5.529, 5.252, 5.491
29	5280	9	1	333	1	5.568, 5.374, 5.429, 5.293, 5.595, 5.628, 5.378, 5.346, 5.585, 5.441, 5.288, 5.385, 5.495, 5.616, 5.521, 5.642, 5.432, 5.619, 5.611, 5.324, 5.319, 5.658, 5.668, 5.320, 5.257, 5.472, 5.682, 5.543, 5.666, 5.526, 5.620, 5.525, 5.410, 5.592, 5.339, 5.653, 5.372, 5.305, 5.555, 5.326, 5.714, 5.383, 5.503, 5.540, 5.457, 5.504, 5.507, 5.271, 5.348, 5.494, 5.435, 5.639, 5.693, 5.363, 5.542, 5.431, 5.594, 5.565, 5.703, 5.685, 5.398, 5.439, 5.290, 5.571, 5.312, 5.488, 5.333, 5.419, 5.656, 5.338, 5.491, 5.373, 5.309, 5.679, 5.294, 5.357, 5.644, 5.360, 5.691, 5.711, 5.631, 5.367, 5.251, 5.532, 5.460, 5.574, 5.484, 5.502, 5.258, 5.407, 5.403, 5.335, 5.388, 5.272, 5.255, 5.401, 5.285, 5.700, 5.538, 5.705
30	5280	9	1	333	1	5.537, 5.640, 5.283, 5.401, 5.383, 5.698, 5.642, 5.449, 5.612, 5.712, 5.308, 5.471, 5.407, 5.346, 5.314, 5.587, 5.460, 5.400, 5.300, 5.689, 5.536, 5.648, 5.307, 5.396, 5.590, 5.347, 5.606, 5.617, 5.638, 5.538, 5.274, 5.294, 5.467, 5.597, 5.293, 5.686, 5.409, 5.688, 5.475, 5.455, 5.716, 5.370, 5.722, 5.534, 5.317, 5.549, 5.639, 5.270, 5.493, 5.677, 5.657, 5.485, 5.588, 5.665, 5.253, 5.647, 5.477, 5.331, 5.671, 5.349, 5.556, 5.564, 5.700, 5.548, 5.527, 5.353, 5.476, 5.500, 5.286, 5.487, 5.287, 5.625, 5.339, 5.713, 5.430, 5.457, 5.368, 5.577, 5.690, 5.514, 5.513, 5.524, 5.470, 5.709, 5.369, 5.422, 5.701, 5.620, 5.652, 5.674, 5.356, 5.692, 5.315, 5.705, 5.434, 5.539, 5.558, 5.498, 5.547, 5.265

40MHz,

Radar SignalType	Waveform/Trial Number	Detection (%)	Limit (%)	Pass/Fail
Type 1A	15	100%	60%	pass
Type 1B	15	100%		
Type 2	30	100 %	60%	Pass
Type 3	30	100 %	60%	Pass
Type 4	30	100 %	60%	Pass
Aggregate(Type1 to 4)	120	100 %	80%	Pass
Type 5	25	83%	80%	Pass
Type 6	30	100 %	70%	Pass

Please refer to the following statistical tables:

5310MHz**Radar Type 1A Statistical Performance**

Trial #	Fc (MHz)	Pulse/Burst	Pulse Width (μS)	PRI (μs)	Detection (1:yes; 0:no)
1	5310	61	1	878	1
2	5310	81	1	658	1
3	5310	59	1	898	1
4	5310	58	1	918	1
5	5310	67	1	798	1
6	5310	98	1	538	1
7	5310	62	1	858	1
8	5310	63	1	838	1
9	5310	57	1	938	1
10	5310	65	1	818	1
11	5310	83	1	638	1
12	5310	68	1	778	1
13	5310	95	1	558	1
14	5310	78	1	678	1
15	5310	89	1	598	1
Detection Percentage: 100 % (>60%)					

Radar Type 1B Statistical Performance

Trial #	Fc (MHz)	Pulse/Burst	Pulse Width (μS)	PRI (μs)	Detection (1:yes; 0:no)
1	5310	28	1	1892	1
2	5310	64	1	835	1
3	5310	22	1	2425	1
4	5310	29	1	1842	1
5	5310	21	1	2551	1
6	5310	69	1	773	1
7	5310	62	1	852	1
8	5310	19	1	2857	1
9	5310	18	1	2940	1
10	5310	25	1	2161	1
11	5310	18	1	2931	1
12	5310	19	1	2826	1
13	5310	63	1	849	1
14	5310	53	1	995	1
15	5310	39	1	1382	1
Detection Percentage: 100 % (>60%)					

Radar Type 2 Statistical Performance

Trial #	Fc (MHz)	Pulse/Burst	Pulse Width (μS)	PRI (μs)	Detection (1:yes; 0:no)
1	5310	27	4.3	174	1
2	5310	23	1.1	157	1
3	5310	27	2.3	181	1
4	5310	25	3.4	174	1
5	5310	23	3.1	201	1
6	5310	26	5	177	1
7	5310	27	2.5	211	1
8	5310	23	2.9	229	1
9	5310	28	4.9	177	1
10	5310	25	1.1	226	1
11	5310	27	2.3	156	1
12	5310	29	3.4	157	1
13	5310	26	2.3	180	1
14	5310	23	1	155	1
15	5310	27	2.6	216	1
16	5310	29	1.1	216	1
17	5310	26	1.8	159	1
18	5310	24	3.4	178	1
19	5310	24	2.5	160	1
20	5310	28	3.1	190	1
21	5310	24	2	164	1
22	5310	24	1.9	215	1
23	5310	28	4.3	191	1
24	5310	28	2.4	215	1
25	5310	27	2	189	1
26	5310	26	1.1	168	1
27	5310	27	2.9	160	1
28	5310	26	3.7	162	1
29	5310	27	4.5	183	1
30	5310	23	1.9	225	1
Detection Percentage: 100 % (>60%)					

Radar Type 3 Statistical Performance

Trial #	Fc (MHz)	Pulse/Burst	Pulse Width (µS)	PRI (µs)	Detection (1:yes; 0:no)
1	5310	17	10	305	1
2	5310	18	9	306	1
3	5310	17	9.1	467	1
4	5310	18	8.3	493	1
5	5310	18	6.2	460	1
6	5310	18	6.3	366	1
7	5310	17	9	437	1
8	5310	16	6.6	229	1
9	5310	18	8.4	360	1
10	5310	16	9.6	232	1
11	5310	18	9.6	353	1
12	5310	17	8.3	433	1
13	5310	17	8.8	380	1
14	5310	18	8	356	1
15	5310	18	9.7	240	1
16	5310	16	6.8	257	1
17	5310	18	6.9	427	1
18	5310	18	6.5	478	1
19	5310	17	6.6	343	1
20	5310	16	8.5	300	1
21	5310	17	7.5	201	1
22	5310	17	7.4	468	1
23	5310	17	9.8	400	1
24	5310	18	9.1	477	1
25	5310	17	6.9	383	1
26	5310	17	8.3	299	1
27	5310	18	8.3	383	1
28	5310	17	8.8	223	1
29	5310	17	9.3	452	1
30	5310	17	9.1	415	1
Detection Percentage: 100 % (>60%)					

Radar Type 4 Statistical Performance

Trial #	Fc (MHz)	Pulse/Burst	Pulse Width (µS)	PRI (µs)	Detection (1:yes; 0:no)
1	5310	13	14.1	341	1
2	5310	12	18	271	1
3	5310	15	17.5	236	1
4	5310	13	11.5	468	1
5	5310	14	15.1	358	1
6	5310	13	12.7	387	1
7	5310	14	15.4	435	1
8	5310	15	18	337	1
9	5310	15	12.4	329	1
10	5310	14	14.8	358	1
11	5310	16	19.6	363	1
12	5310	14	19.6	242	1
13	5310	14	17.7	497	1
14	5310	15	16.2	467	1
15	5310	14	18	280	1
16	5310	14	14.8	426	1
17	5310	15	14.2	319	1
18	5310	15	11.4	449	1
19	5310	13	12.9	284	1
20	5310	16	19.2	288	1
21	5310	15	19.6	362	1
22	5310	16	13.4	340	1
23	5310	12	13	252	1
24	5310	16	16.4	481	1
25	5310	13	16.5	237	1
26	5310	15	18.7	329	1
27	5310	14	14.7	422	1
28	5310	13	18.5	452	1
29	5310	14	15.7	223	1
30	5310	12	15	408	1
Detection Percentage: 100 % (>60%)					

Radar Type 5 Statistical Performance

Statistics 1 (ChirpCenter Frequency: 5290 MHz)

Trial #	Pulse	Chirp(MHz)	Pulse Width (µS)	Pulse 1-2 spacing(µS)	Pulse 2-3 spacing(µS)	Pulse Start(mS)	Detection (1:yes;0:no)
1	3	10	63.2	1720	1982	459.841	1
2	2	10	79.2	1650		14.083	
3	2	10	60.4	1507		516.266	
4	3	10	95.1	1973	1351	707.659	
5	2	10	85.3	1633		485.332	
6	2	10	65.9	1841		371.505	
7	2	10	75.7	1719		215.558	
8	2	10	87.8	1094		271.572	
9	2	10	82.7	1009		649.655	
10	2	10	56.9	1753		173.828	
11	2	10	94.4	1628		653.191	
12	2	10	90.6	1023		592.854	
13	1	10	80.1			206.677	

Statistics 2 (ChirpCenter Frequency: 5290 MHz)

Trial #	Pulse	Chirp(MHz)	Pulse Width (µS)	Pulse 1-2 spacing(µS)	Pulse 2-3 spacing(µS)	Pulse Start(mS)	Detection (1:yes;0:no)
1	3	9	64.9	1706	1914	424.815	1
2	2	9	87.5	1875		376.675	
3	2	9	63.3	1617		407.03	
4	3	9	80.1	1889	1703	525.39	
5	2	9	57.1	1381		154.16	
6	1	9	94.5			533.44	
7	3	9	90.9	1917	1441	463.86	
8	2	9	57.3	1342		436.56	
9	2	9	85.7	1566		247.64	
10	1	9	73.8			291.03	
11	3	9	59	1684	1923	407.93	
12	1	9	55.7			180.69	
13	2	9	59.4	1325		70.35	
14	3	9	93.2	1697	1608	145.24	
15	2	9	73.2	1272		2.26	
16	1	9	71.5			579.24	
17	2	9	52.3	1800		55.57	
18	1	9	89.8			84.9	
19	3	9	85.7	1053	1377	396.9	
20	2	9	81.2	1413		267	

Statistics 3 (ChirpCenter Frequency: 5290 MHz)

Trial #	Pulse	Chirp(MHz)	Pulse Width (µS)	Pulse 1-2 spacing(µS)	Pulse 2-3 spacing(µS)	Pulse Start(mS)	Detection (1:yes;0:no)
1	2	14	63.7	1347		166.207	1
2	2	14	70.2	1972		509.93	
3	3	14	63.6	1710	1208	582.36	
4	3	14	92.6	1593	1068	652.07	
5	1	14	74			306.85	
6	3	14	53	1398	1484	212.15	
7	3	14	73.3	1330	1783	8.43	
8	1	14	67.6			504.45	
9	3	14	80.1	1338	1771	399.89	
10	3	14	67.5	1640	1748	496.23	
11	2	14	54.9	1471		117.44	
12	2	14	81.4	1460		221.82	
13	2	14	60.1	1864		450.18	
14	2	14	84.9	1679		620.7	
15	3	14	55.7	1208	1275	296.7	
16	2	14	75.3	1625		593.3	

Statistics 4 (ChirpCenter Frequency: 5290 MHz)

Trial #	Pulse	Chirp(MHz)	Pulse Width (µS)	Pulse 1-2 spacing(µS)	Pulse 2-3 spacing(µS)	Pulse Start(mS)	Detection (1:yes;0:no)
1	1	11	76.2			530.986	1
2	2	11	86.5	1161		537.298	
3	1	11	72.9			555.545	
4	1	11	54.2			1.533	
5	1	11	85.6			342.901	
6	2	11	97.7	1748		341.168	
7	3	11	66.4	1677	1905	142.836	
8	3	11	89.2	1305	1440	114.424	
9	3	11	71.4	1002	1104	333.821	
10	2	11	73.2	1132		229.739	
11	1	11	54.5			658.146	
12	3	11	70.8	1513	1183	91.614	
13	1	11	51.1			257.772	
14	1	11	84.3			392.469	
15	2	11	69	1533		500.847	
16	2	11	81.1	1672		103.565	
17	2	11	55.4	1941		160.282	

Statistics 5(ChirpCenter Frequency: 5290 MHz)

Trial #	Pulse	Chirp(MHz)	Pulse Width (µS)	Pulse 1-2 spacing(µS)	Pulse 2-3 spacing(µS)	Pulse Start(mS)	Detection (1:yes;0:no)
1	2	20	52.7	1333		667.599	1
2	3	20	67.2	1703	1652	456.648	
3	2	20	56.4	1027		221.945	
4	3	20	72.6	1861	1740	375.013	
5	2	20	92.7	1993		449.711	
6	1	20	64.4			526.018	
7	2	20	58.3	1271		71.436	
8	2	20	97.4	1305		16.674	
9	2	20	61.5	1096		633.731	
10	2	20	61.9	1941		330.299	
11	3	20	88.2	1955	1353	590.086	
12	1	20	71.3			639.694	
13	2	20	73.6	1801		513.302	
14	1	20	77.6			427.529	
15	1	20	74.4			312.547	
16	2	20	74.6	1069		458.565	
17	1	20	94.6			447.182	

Statistics 6 (ChirpCenter Frequency: 5290 MHz)

Trial #	Pulse	Chirp(MHz)	Pulse Width (µS)	Pulse 1-2 spacing(µS)	Pulse 2-3 spacing(µS)	Pulse Start(mS)	Detection (1:yes;0:no)
1	2	14	53.9	1502		15.225	1
2	2	14	52.4	1070		963.26	
3	2	14	97	1234		436.94	
4	3	14	64.3	1978	1771	957.44	
5	2	14	75.6	1066		413.19	
6	1	14	52.9			385.23	
7	1	14	71			888.27	
8	2	14	95.7	1634		162.09	
9	2	14	91.2	1241		146.15	
10	1	14	59.3			800.1	
11	2	14	68.5	1872		26.9	
12	2	14	64	1718		292.4	

Statistics 7(ChirpCenter Frequency: 5290 MHz)

Trial #	Pulse	Chirp(MHz)	Pulse Width (µS)	Pulse 1-2 spacing(µS)	Pulse 2-3 spacing(µS)	Pulse Start(mS)	Detection (1:yes;0:no)
1	2	10	58	1489		649.557	1
2	1	10	72.7			122.84	
3	2	10	69.9	1066		830.65	
4	2	10	88.5	1614		990.7	
5	2	10	80.9	1888		954.36	
6	2	10	87.5	1441		344.41	
7	2	10	54.2	1692		616.84	
8	2	10	62.7	1714		921.06	
9	2	10	66.8	1644		672.72	
10	1	10	81.5			95.29	
11	3	10	66.2	1571	1558	159.4	
12	2	10	89.2	1597		931.1	

Statistics 8 (ChirpCenter Frequency: 5290 MHz)

Trial #	Pulse	Chirp(MHz)	Pulse Width (µS)	Pulse 1-2 spacing(µS)	Pulse 2-3 spacing(µS)	Pulse Start(mS)	Detection (1:yes;0:no)
1	2	20	64.8	1119		457.112	1
2	2	20	96.7	1442		522.173	
3	2	20	74.8	1933		601.527	
4	3	20	99.8	1007	1259	298.39	
5	2	20	80.6	1934		257.033	
6	2	20	72.3	1854		25.767	
7	2	20	79.1	1994		71.35	
8	2	20	87.9	1161		405.533	
9	1	20	68.1			632.537	
10	2	20	74.4	1554		513.51	
11	2	20	91.9	1550		249.643	
12	2	20	97.8	1549		206.417	
13	2	20	64.1	1353		232.12	
14	2	20	51.5	1576		131.093	
15	3	20	63.8	1591	1755	23.907	
16	3	20	52.3	1071	1759	463.4	
17	1	20	94.8			335.533	
18	2	20	65.4	1580		78.367	

Statistics 9 (ChirpCenter Frequency: 5290 MHz)

Trial #	Pulse	Chirp(MHz)	Pulse Width (µS)	Pulse 1-2 spacing(µS)	Pulse 2-3 spacing(µS)	Pulse Start(mS)	Detection (1:yes;0:no)
1	2	20	54.2	1869		535.154	1
2	1	20	85.4			252.817	
3	3	20	61	1122	1732	239.933	
4	1	20	80.3			194.23	
5	1	20	58.1			246.957	
6	2	20	92.5	1922		936.273	
7	3	20	59.3	1206	1103	1314	
8	2	20	59.6	1322		901.067	
9	1	20	68.1			782.733	

Statistics 10 (ChirpCenter Frequency: 5290 MHz)

Trial #	Pulse	Chirp(MHz)	Pulse Width (µS)	Pulse 1-2 spacing(µS)	Pulse 2-3 spacing(µS)	Pulse Start(mS)	Detection (1:yes;0:no)
1	2	8	63.6	1338		989.19	1
2	2	8	82.3	1210		300.801	
3	2	8	55.7	1244		589.342	
4	2	8	91.1	1057		890.893	
5	2	8	97.6	1872		446.984	
6	2	8	56.7	1479		409.525	
7	2	8	67.3	1847		1071.275	
8	1	8	62.4			661.696	
9	2	8	73.7	1397		3.807	
10	1	8	63.8			632.018	
11	2	8	55.8	1094		502.809	

Statistics 11 (ChirpCenter Frequency: 5256.4 MHz)

Trial #	Pulse	Chirp(MHz)	Pulse Width (µS)	Pulse 1-2 spacing(µS)	Pulse 2-3 spacing(µS)	Pulse Start(mS)	Detection (1:yes;0:no)
1	3	11	66.3	1310	1794	1.258	1
2	2	11	88.3	1343		57.864	
3	1	11	51.5			116.41	
4	3	11	53.8	1586	1664	146.75	
5	2	11	57.7	1645		219.62	
6	3	11	85.8	1237	1287	318.58	
7	2	11	86.8	1140		352.51	
8	3	11	87.1	1196	1439	103.61	
9	2	11	93.3	1152		195.51	
10	3	11	55.2	1130	1794	171.57	
11	1	11	91.6			515.8	
12	2	11	66	1756		51.14	
13	3	11	62.5	1851	1327	620.6	
14	3	11	73.3	1501	1013	370	
15	2	11	70.1	1804		100.2	

Statistics 12 (ChirpCenter Frequency: 5254.4 MHz)

Trial #	Pulse	Chirp(MHz)	Pulse Width (µS)	Pulse 1-2 spacing(µS)	Pulse 2-3 spacing(µS)	Pulse Start(mS)	Detection (1:yes;0:no)
1	3	6	51.3	1303	1886	332.173	0
2	3	6	83.2	1296	1294	385.573	
3	2	6	74.4	1045		184.787	
4	2	6	70.1	1768		245.75	
5	2	6	55.1	1952		433.093	
6	3	6	90.2	1881	1496	498.717	
7	1	6	77.7			23.15	
8	3	6	90.6	1656	1042	118.313	
9	2	6	64.3	1798		33.477	
10	2	6	58.4	1106		243.32	
11	2	6	91.7	1458		278.043	
12	2	6	78.1	1688		22.527	
13	1	6	58.1			448.61	
14	2	6	97.1	1394		650.753	
15	2	6	78.5	1633		233.377	
16	1	6	59.1			498.9	
17	2	6	88.4	1374		639.833	
18	3	6	78.2	1938	1121	481.967	

Statistics 13 (ChirpCenter Frequency: 5258.8 MHz)

Trial #	Pulse	Chirp(MHz)	Pulse Width (µS)	Pulse 1-2 spacing(µS)	Pulse 2-3 spacing(µS)	Pulse Start(mS)	Detection (1:yes;0:no)
1	3	17	64.9	1630	1818	917.986	1
2	2	17	81.6	1563		340.12	
3	2	17	56.9	1848		702.68	
4	2	17	54.6	1656		279.23	
5	3	17	79	1695	1697	715.69	
6	1	17	71.9			83.04	
7	2	17	60	1906		456.49	
8	1	17	76.3			337.71	
9	2	17	74.9	1612		923.83	
10	2	17	52.8	1773		896.3	
11	1	17	79.1			64.3	
12	1	17	53.3			910.8	

Statistics 14 (ChirpCenter Frequency: 5254.8 MHz)

Trial #	Pulse	Chirp(MHz)	Pulse Width (µS)	Pulse 1-2 spacing(µS)	Pulse 2-3 spacing(µS)	Pulse Start(mS)	Detection (1:yes;0:no)
1	1	7	57.8			631.667	1
2	1	7	64.9			786.22	
3	2	7	50.6	1206		553.62	
4	3	7	93.1	1442	1340	787.1	
5	2	7	91.4	1518		706.39	
6	2	7	61.3	1687		501.26	
7	2	7	100	1150		536.15	
8	2	7	77.6	1968		247.64	
9	1	7	67			712.25	
10	1	7	82.9			355.95	
11	3	7	91.7	1596	1431	478.29	
12	3	7	70.9	1027	1151	397.35	
13	2	7	56.1	1499		47.86	
14	2	7	98.5	1293		329.4	
15	2	7	93.6	1155		543.5	

Statistics 15 (ChirpCenter Frequency: 5260 MHz)

Trial #	Pulse	Chirp(MHz)	Pulse Width (µS)	Pulse 1-2 spacing(µS)	Pulse 2-3 spacing(µS)	Pulse Start(mS)	Detection (1:yes;0:no)
1	3	20	90.6	1943	1280	472.72	0
2	1	20	88			292.324	
3	2	20	62.2	1243		503.025	
4	2	20	52.4	1996		450.123	
5	2	20	65.4	1286		425.681	
6	3	20	78.7	1725	1533	8.468	
7	2	20	86.9	1059		38.456	
8	2	20	68.3	1436		410.024	
9	1	20	55.5			423.551	
10	2	20	85.8	1509		458.099	
11	2	20	90.1	1459		155.896	
12	3	20	70.6	1204	1334	346.214	
13	3	20	60.4	1080	1463	112.362	
14	2	20	55.4	1140		541.999	
15	3	20	68.8	1067	1050	353.347	
16	1	20	58			630.365	
17	3	20	59.3	1159	1521	665.482	

Statistics 16 (ChirpCenter Frequency: 5256.4 MHz)

Trial #	Pulse	Chirp(MHz)	Pulse Width (µS)	Pulse 1-2 spacing(µS)	Pulse 2-3 spacing(µS)	Pulse Start(mS)	Detection (1:yes;0:no)
1	3	11	83.7	1757	1967	95.953	1
2	2	11	72.8	1185		160.651	
3	2	11	70.8	1903		389.005	
4	1	11	63.7			109.333	
5	1	11	96.6			473.441	
6	2	11	56.5	1825		675.488	
7	3	11	95	1262	1702	115.076	
8	1	11	99.3			303.224	
9	2	11	96	1147		531.911	
10	2	11	88.8	1475		15.199	
11	2	11	92.3	1347		523.796	
12	3	11	86.7	1583	1777	481.474	
13	3	11	82.5	1951	1533	224.232	
14	2	11	74.8	1581		455.389	
15	1	11	85.6			130.347	
16	3	11	75	1074	1152	482.065	
17	2	11	57.4	1173		396.482	

Statistics 17 (ChirpCenter Frequency: 5259.2MHz)

Trial #	Pulse	Chirp(MHz)	Pulse Width (µS)	Pulse 1-2 spacing(µS)	Pulse 2-3 spacing(µS)	Pulse Start(mS)	Detection (1:yes;0:no)
1	3	18	88.6	1959	1689	279.877	0
2	2	18	81	1899		19.7	
3	2	18	71.3	1189		1119.58	
4	2	18	78.6	1431		738.86	
5	2	18	90.8	1350		750.77	
6	1	18	92.9			1296.34	
7	3	18	62.4	1879	1930	1367.2	
8	2	18	67.6	1870		1141.2	

Statistics 18 (ChirpCenter Frequency: 5255.2 MHz)

Trial #	Pulse	Chirp(MHz)	Pulse Width (µS)	Pulse 1-2 spacing(µS)	Pulse 2-3 spacing(µS)	Pulse Start(mS)	Detection (1:yes;0:no)
1	2	8	57	1346		437.582	0
2	1	8	53.5			357.637	
3	3	8	68.9	1098	1595	199.704	
4	3	8	79.7	1531	1243	135.201	
5	2	8	84	1543		391.439	
6	3	8	73.2	1457	1640	7.706	
7	3	8	62.8	1119	1381	833.193	
8	2	8	96.2	1870		436.64	
9	2	8	56.6	1840		701.187	
10	1	8	85.1			116.724	
11	2	8	75.9	1725		182.741	
12	2	8	60.1	1745		272.009	
13	2	8	78	1220		33.786	
14	2	8	61.8	1559		257.743	

Statistics 19 (ChirpCenter Frequency: 5259.6 MHz)

Trial #	Pulse	Chirp(MHz)	Pulse Width (µS)	Pulse 1-2 spacing(µS)	Pulse 2-3 spacing(µS)	Pulse Start(mS)	Detection (1:yes;0:no)
1	2	19	96.7	1263		914.423	1
2	3	19	54.3	1021	1108	765.793	
3	1	19	78.9			840.716	
4	3	19	58.5	1374	1402	741.269	
5	1	19	82.3			180.502	
6	1	19	93.4			177.175	
7	2	19	50.7	1186		568.628	
8	2	19	92	1690		147.802	
9	2	19	71.3	1315		572.195	
10	2	19	70.1	1476		479.608	
11	1	19	98			371.661	
12	3	19	68.9	1856	1205	446.354	
13	3	19	74.2	1449	1112	630.677	

Statistics 20 (ChirpCenter Frequency: 5254.4 MHz)

Trial #	Pulse	Chirp(MHz)	Pulse Width (µS)	Pulse 1-2 spacing(µS)	Pulse 2-3 spacing(µS)	Pulse Start(mS)	Detection (1:yes;0:no)
1	1	6	96.6			698.125	0
2	3	6	72.3	1359	1626	953.8	
3	2	6	73.9	1841		933.98	
4	2	6	99.5	1462		713.56	
5	2	6	74.2	1992		745.69	
6	3	6	83.2	1934	1777	564.7	
7	2	6	85.3	1784		249.88	
8	3	6	71.5	1604	1616	802.98	
9	2	6	96.4	1409		917.5	
10	1	6	91.3			1139.6	

Statistics 21 (ChirpCenter Frequency: 5322.8 MHz)

Trial #	Pulse	Chirp(MHz)	Pulse Width (µS)	Pulse 1-2 spacing(µS)	Pulse 2-3 spacing(µS)	Pulse Start(mS)	Detection (1:yes;0:no)
1	2	13	58.8	1788		397.652	1
2	2	13	69.5	1787		601.247	
3	2	13	76.6	1915		480.683	
4	2	13	83.5	1725		72.27	
5	3	13	95.1	1349	1435	169.037	
6	1	13	80.2			1007.673	
7	2	13	84.7	1334		138.47	
8	3	13	52.7	1409	1014	521.537	
9	2	13	80.3	1216		306.333	

Statistics 22 (ChirpCenter Frequency: 5323.2)

Trial #	Pulse	Chirp(MHz)	Pulse Width (µS)	Pulse 1-2 spacing(µS)	Pulse 2-3 spacing(µS)	Pulse Start(mS)	Detection (1:yes;0:no)
1	1	12	91.7			188.923	1
2	1	12	65.3			323.71	
3	2	12	88	1797		148.35	
4	1	12	68.4			2.92	
5	3	12	62.3	1201	1755	404.83	
6	1	12	62.6			13.16	
7	1	12	81.2			188.27	
8	2	12	77.7	1297		193.48	
9	2	12	70.4	1868		294.83	
10	1	12	70.4			76.33	
11	2	12	53.3	1713		441.37	
12	1	12	83.2			80.07	
13	2	12	63.7	1785		147.36	
14	3	12	65.6	1499	1491	185.96	
15	2	12	70.3	1242		414.56	
16	3	12	80.6	1141	1009	397.42	
17	3	12	93.7	1487	1648	170.5	
18	3	12	57.7	1126	1233	257.7	
19	2	12	85.4	1102		440.6	
20	2	12	83.5	1408		235.6	

Statistics 23 (ChirpCenter Frequency: 5320 MHz)

Trial #	Pulse	Chirp(MHz)	Pulse Width (µS)	Pulse 1-2 spacing(µS)	Pulse 2-3 spacing(µS)	Pulse Start(mS)	Detection (1:yes;0:no)
1	3	20	55.5	1686	1566	355.125	1
2	2	20	61.3	1876		68.532	
3	3	20	62.3	1199	1094	544.187	
4	1	20	69.6			484.37	
5	2	20	51.6	1793		512.953	
6	2	20	85.6	1120		213.157	
7	2	20	99	1682		299.81	
8	3	20	92.2	1813	1723	145.733	
9	2	20	94.1	1714		148.787	
10	2	20	58.6	1212		16.12	
11	1	20	69.6			8.963	
12	2	20	66.5	1436		659.467	
13	3	20	79.7	1291	1786	131.23	
14	3	20	77.4	1495	1959	435.163	
15	1	20	88.3			502.237	
16	2	20	99.3	1134		203	
17	2	20	73.5	1291		484.433	
18	2	20	73.1	1563		68.967	

Statistics 24 (ChirpCenter Frequency: 5322 MHz)

Trial #	Pulse	Chirp(MHz)	Pulse Width (µS)	Pulse 1-2 spacing(µS)	Pulse 2-3 spacing(µS)	Pulse Start(mS)	Detection (1:yes;0:no)
1	3	15	92.5	1445	1031	348.413	1
2	3	15	95.7	1689	1503	334.964	
3	2	15	69.6	1683		363.73	
4	2	15	54.7	1540		424.33	
5	2	15	58.4	1512		257.93	
6	3	15	53.2	1865	1339	265.3	
7	2	15	76.5	1551		195.23	
8	2	15	68.9	1809		105.05	
9	3	15	82.2	1142	1179	490.69	
10	1	15	99.3			33.72	
11	2	15	54.1	1165		159.81	
12	1	15	96.3			387.67	
13	1	15	98.7			260.35	
14	2	15	73.8	1829		440.6	
15	3	15	78.5	1964	1630	481.44	
16	2	15	60.9	1797		130.44	
17	1	15	81.5			286.97	
18	2	15	59.3	1144		97.7	
19	1	15	99.2			335.2	
20	3	15	86.6	1079	1883	438.4	

Statistics 25 (ChirpCenter Frequency: 5326 MHz)

Trial #	Pulse	Chirp(MHz)	Pulse Width (µS)	Pulse 1-2 spacing(µS)	Pulse 2-3 spacing(µS)	Pulse Start(mS)	Detection (1:yes;0:no)
1	3	5	96.1	1703	1847	773.346	1
2	3	5	54.6	1976	1752	429.453	
3	3	5	98	1251	1772	131.266	
4	1	5	69.5			30.989	
5	2	5	79	1091		499.242	
6	2	5	81.8	1510		182.215	
7	3	5	70.7	1644	1643	222.548	
8	3	5	51.8	1020	1962	566.782	
9	2	5	55.9	1008		253.255	
10	2	5	58.2	1241		453.788	
11	3	5	69.7	1016	1886	403.671	
12	1	5	60.2			74.454	
13	2	5	74.8	1367		673.577	

Statistics 26 (ChirpCenter Frequency: 5320.8 MHz)

Trial #	Pulse	Chirp(MHz)	Pulse Width (µS)	Pulse 1-2 spacing(µS)	Pulse 2-3 spacing(µS)	Pulse Start(mS)	Detection (1:yes;0:no)
1	3	18	66.3	1183	1583	201.457	1
2	3	18	52.2	1593	1325	418.25	
3	2	18	91.9	1418		459.88	
4	1	18	53.6			669.15	
5	2	18	80.6	1464		135.99	
6	1	18	78.3			296.25	
7	3	18	68	1738	1549	99.58	
8	2	18	76.4	1125		920.46	
9	2	18	70.7	1975		636.92	
10	2	18	51.5	1959		664.1	
11	2	18	85.9	1447		907.5	
12	2	18	91.4	1813		345.2	

Statistics 27 (ChirpCenter Frequency: 5321.2 MHz)

Trial #	Pulse	Chirp(MHz)	Pulse Width (µS)	Pulse 1-2 spacing(µS)	Pulse 2-3 spacing(µS)	Pulse Start(mS)	Detection (1:yes;0:no)
1	2	17	63.6	1570		579.701	1
2	3	17	91.6	1957	1434	467.611	
3	3	17	81.1	1993	1598	451.622	
4	3	17	90	1091	1877	405.603	
5	1	17	62.1			0.014	
6	2	17	76	1970		364.505	
7	1	17	95.1			251.596	
8	2	17	68.3	1533		345.017	
9	1	17	88.7			96.798	
10	2	17	78.9	1447		511.599	
11	2	17	77.7	1463		288.521	
12	1	17	66.5			191.312	
13	1	17	68.8			422.443	
14	2	17	92.8	1074		294.834	
15	1	17	77.3			161.405	
16	2	17	88.3	1325		185.816	
17	1	17	50.3			25.237	
18	1	17	92.2			83.158	
19	3	17	70.3	1162	1389	168.679	

Statistics 28 (ChirpCenter Frequency: 5324.8 MHz)

Trial #	Pulse	Chirp(MHz)	Pulse Width (µS)	Pulse 1-2 spacing(µS)	Pulse 2-3 spacing(µS)	Pulse Start(mS)	Detection (1:yes;0:no)
1	2	8	88.3	1523		260.114	1
2	2	8	83.1	1889		646.398	
3	2	8	90.4	1368		659.605	
4	2	8	74.3	1810		367.213	
5	2	8	82.3	1712		697.841	
6	3	8	81.6	1648	1894	29.798	
7	3	8	54.2	1833	1431	111.936	
8	1	8	69.6			219.654	
9	2	8	63.4	1899		59.111	
10	1	8	78.4			531.349	
11	2	8	85	1097		30.176	
12	1	8	70.8			553.104	
13	2	8	50.1	1255		86.852	
14	1	8	57.9			221.479	
15	3	8	66.8	1241	1822	358.147	
16	1	8	69.2			337.965	
17	2	8	89	1801		690.182	

Statistics 29 (ChirpCenter Frequency: 5320.4 MHz)

Trial #	Pulse	Chirp(MHz)	Pulse Width (µS)	Pulse 1-2 spacing(µS)	Pulse 2-3 spacing(µS)	Pulse Start(mS)	Detection (1:yes;0:no)
1	3	19	60.5	1371	1174	903.957	1
2	3	19	60.6	1756	1631	1059.231	
3	3	19	93.6	1828	1012	929.212	
4	3	19	75	1030	1288	854.603	
5	3	19	85.9	1964	1378	799.014	
6	2	19	82.8	1282		712.225	
7	2	19	98.9	1008		667.815	
8	3	19	92.6	1507	1479	717.896	
9	1	19	80.6			354.967	
10	2	19	79.2	1254		262.918	
11	2	19	61.4	1224		393.209	

Statistics 30 (ChirpCenter Frequency: 5323.6 MHz)

Trial #	Pulse	Chirp(MHz)	Pulse Width (µS)	Pulse 1-2 spacing(µS)	Pulse 2-3 spacing(µS)	Pulse Start(mS)	Detection (1:yes;0:no)
1	2	11	90.7	1412		105.494	1
2	1	11	73			509.9	
3	2	11	60.4	1486		585.41	
4	2	11	68.4	1420		282.56	
5	2	11	53.4	1890		701.2	
6	3	11	97.6	1851	1765	491.01	
7	2	11	56.3	1995		133.13	
8	1	11	91.2			313.95	
9	3	11	80	1185	1489	128.23	
10	1	11	71.5			632.34	
11	3	11	61	1499	1388	660.17	
12	2	11	73	1510		365.63	
13	3	11	62.5	1933	1187	195.37	
14	2	11	96	1508		695.3	
15	3	11	94.1	1062	1156	502.7	
16	3	11	79.4	1218	1980	75.7	

Radar Type 6 Statistical Performance

Trial #	Fc (MHz)	Pulse /Burst	Pulse Width (µS)	PRI (µs)	Detection (1:yes; 0:no)	Hopping Sequence (GHz)
1	5310	9	1	333	1	5.316, 5.299, 5.575, 5.521, 5.679, 5.419, 5.566, 5.717, 5.663, 5.431, 5.512, 5.720, 5.354, 5.683, 5.462, 5.295, 5.562, 5.639, 5.409, 5.696, 5.653, 5.344, 5.416, 5.346, 5.338, 5.313, 5.379, 5.328, 5.428, 5.453, 5.511, 5.546, 5.523, 5.620, 5.626, 5.560, 5.535, 5.386, 5.371, 5.582, 5.283, 5.543, 5.444, 5.608, 5.302, 5.254, 5.450, 5.706, 5.712, 5.565, 5.265, 5.493, 5.458, 5.262, 5.445, 5.644, 5.540, 5.698, 5.564, 5.682, 5.474, 5.479, 5.378, 5.667, 5.516, 5.278, 5.290, 5.362, 5.442, 5.357, 5.402, 5.708, 5.723, 5.472, 5.719, 5.350, 5.482, 5.592, 5.658, 5.473, 5.656, 5.578, 5.542, 5.271, 5.624, 5.703, 5.695, 5.525, 5.607, 5.539, 5.319, 5.547, 5.467, 5.349, 5.329, 5.700, 5.381, 5.415, 5.261, 5.253
2	5310	9	1	333	1	5.363, 5.503, 5.427, 5.269, 5.640, 5.406, 5.714, 5.589, 5.698, 5.617, 5.677, 5.663, 5.344, 5.552, 5.380, 5.260, 5.690, 5.419, 5.646, 5.429, 5.390, 5.250, 5.255, 5.288, 5.536, 5.274, 5.667, 5.440, 5.520, 5.327, 5.522, 5.532, 5.388, 5.706, 5.614, 5.542, 5.488, 5.569, 5.313, 5.638, 5.564, 5.493, 5.402, 5.298, 5.263, 5.431, 5.583, 5.279, 5.326, 5.284, 5.543, 5.306, 5.422, 5.423, 5.606, 5.497, 5.580, 5.328, 5.703, 5.573, 5.323, 5.256, 5.609, 5.302, 5.339, 5.404, 5.516, 5.673, 5.407, 5.267, 5.387, 5.512, 5.603, 5.418, 5.596, 5.448, 5.557, 5.312, 5.501, 5.668, 5.471, 5.616, 5.572, 5.412, 5.473, 5.558, 5.316, 5.293, 5.425, 5.666, 5.530, 5.581, 5.392, 5.682, 5.294, 5.465, 5.266, 5.254, 5.399, 5.683
3	5310	9	1	333	1	5.549, 5.254, 5.312, 5.311, 5.635, 5.536, 5.420, 5.518, 5.256, 5.596, 5.316, 5.319, 5.674, 5.317, 5.670, 5.667, 5.361, 5.493, 5.350, 5.653, 5.664, 5.648, 5.689, 5.423, 5.639, 5.526, 5.372, 5.476, 5.328, 5.418, 5.680, 5.589, 5.456, 5.516, 5.633, 5.483, 5.577, 5.398, 5.323, 5.265, 5.271, 5.666, 5.616, 5.534, 5.438, 5.274, 5.629, 5.705, 5.682, 5.291, 5.266, 5.650, 5.380, 5.623, 5.336, 5.280, 5.564, 5.495, 5.537, 5.558, 5.353, 5.500, 5.397, 5.447, 5.402, 5.718, 5.582, 5.494, 5.624, 5.313, 5.299, 5.467, 5.510, 5.550, 5.421, 5.551, 5.610, 5.285, 5.687, 5.446, 5.335, 5.276, 5.542, 5.449, 5.375, 5.327, 5.399, 5.251, 5.435, 5.641, 5.555, 5.703, 5.651, 5.471, 5.469, 5.351, 5.676, 5.293, 5.357, 5.488
4	5310	9	1	333	1	5.531, 5.574, 5.334, 5.567, 5.441, 5.442, 5.662, 5.560, 5.538, 5.547, 5.664, 5.459,

						5.267, 5.632, 5.409, 5.541, 5.421, 5.497, 5.403, 5.576, 5.361, 5.370, 5.528, 5.723, 5.562, 5.524, 5.451, 5.595, 5.254, 5.373, 5.331, 5.313, 5.631, 5.551, 5.529, 5.434, 5.718, 5.594, 5.626, 5.587, 5.689, 5.554, 5.498, 5.338, 5.320, 5.443, 5.473, 5.382, 5.292, 5.452, 5.456, 5.500, 5.669, 5.449, 5.491, 5.512, 5.489, 5.281, 5.510, 5.659, 5.506, 5.329, 5.427, 5.703, 5.651, 5.601, 5.522, 5.316, 5.536, 5.378, 5.450, 5.312, 5.372, 5.660, 5.691, 5.644, 5.429, 5.465, 5.496, 5.432, 5.291, 5.337, 5.543, 5.444, 5.623, 5.711, 5.340, 5.286, 5.591, 5.277, 5.494, 5.406, 5.525, 5.333, 5.696, 5.341, 5.593, 5.611, 5.558, 5.266
5	5310	9	1	333	1	5.324, 5.553, 5.667, 5.282, 5.329, 5.563, 5.327, 5.687, 5.594, 5.307, 5.626, 5.613, 5.719, 5.600, 5.627, 5.716, 5.481, 5.322, 5.373, 5.720, 5.479, 5.413, 5.359, 5.639, 5.678, 5.568, 5.618, 5.583, 5.718, 5.452, 5.411, 5.605, 5.523, 5.402, 5.288, 5.442, 5.448, 5.693, 5.698, 5.591, 5.670, 5.271, 5.417, 5.612, 5.275, 5.488, 5.483, 5.449, 5.257, 5.573, 5.660, 5.657, 5.722, 5.332, 5.636, 5.451, 5.560, 5.551, 5.680, 5.279, 5.272, 5.315, 5.512, 5.287, 5.607, 5.334, 5.490, 5.349, 5.455, 5.292, 5.253, 5.450, 5.394, 5.499, 5.456, 5.695, 5.521, 5.517, 5.545, 5.516, 5.370, 5.493, 5.686, 5.502, 5.286, 5.532, 5.508, 5.535, 5.701, 5.461, 5.357, 5.645, 5.576, 5.637, 5.525, 5.296, 5.290, 5.666, 5.582, 5.513
6	5310	9	1	333	1	5.321, 5.325, 5.721, 5.576, 5.276, 5.676, 5.631, 5.358, 5.315, 5.327, 5.362, 5.684, 5.326, 5.313, 5.666, 5.562, 5.492, 5.513, 5.662, 5.605, 5.317, 5.286, 5.308, 5.433, 5.651, 5.404, 5.556, 5.620, 5.319, 5.554, 5.643, 5.540, 5.526, 5.592, 5.583, 5.481, 5.495, 5.701, 5.532, 5.401, 5.336, 5.269, 5.278, 5.708, 5.342, 5.421, 5.606, 5.320, 5.424, 5.284, 5.303, 5.434, 5.384, 5.541, 5.416, 5.386, 5.501, 5.309, 5.650, 5.256, 5.509, 5.683, 5.253, 5.329, 5.524, 5.361, 5.575, 5.503, 5.474, 5.348, 5.715, 5.634, 5.569, 5.478, 5.409, 5.594, 5.290, 5.422, 5.555, 5.292, 5.343, 5.628, 5.712, 5.494, 5.603, 5.391, 5.508, 5.470, 5.674, 5.670, 5.410, 5.472, 5.322, 5.557, 5.289, 5.475, 5.681, 5.447, 5.464, 5.356
7	5310	9	1	333	1	5.366, 5.268, 5.583, 5.408, 5.364, 5.561, 5.352, 5.459, 5.375, 5.679, 5.317, 5.452, 5.261, 5.555, 5.654, 5.382, 5.394, 5.506, 5.695, 5.293, 5.492, 5.709, 5.668, 5.465, 5.563, 5.553, 5.377, 5.384, 5.693, 5.443, 5.660, 5.344, 5.462, 5.510, 5.564, 5.628, 5.312, 5.326, 5.447, 5.383, 5.671, 5.559, 5.353, 5.489, 5.680, 5.549, 5.694, 5.579, 5.291, 5.494, 5.477, 5.619, 5.294, 5.296, 5.285, 5.355, 5.321, 5.593, 5.621, 5.688, 5.666, 5.485, 5.648, 5.330, 5.524, 5.297,

						5.645, 5.529, 5.470, 5.701, 5.373, 5.449, 5.269, 5.636, 5.441, 5.453, 5.527, 5.306, 5.260, 5.705, 5.361, 5.388, 5.265, 5.360, 5.299, 5.351, 5.490, 5.279, 5.493, 5.566, 5.702, 5.545, 5.414, 5.609, 5.713, 5.250, 5.339, 5.336, 5.302, 5.378
8	5310	9	1	333	1	5.341, 5.398, 5.654, 5.482, 5.437, 5.626, 5.552, 5.658, 5.282, 5.391, 5.651, 5.408, 5.359, 5.271, 5.628, 5.612, 5.445, 5.379, 5.281, 5.709, 5.311, 5.284, 5.571, 5.375, 5.589, 5.326, 5.659, 5.708, 5.305, 5.260, 5.363, 5.581, 5.524, 5.630, 5.490, 5.516, 5.674, 5.595, 5.656, 5.497, 5.364, 5.307, 5.699, 5.704, 5.405, 5.255, 5.300, 5.383, 5.350, 5.449, 5.339, 5.637, 5.324, 5.666, 5.534, 5.528, 5.433, 5.519, 5.565, 5.716, 5.426, 5.401, 5.647, 5.361, 5.657, 5.480, 5.487, 5.316, 5.427, 5.557, 5.664, 5.609, 5.493, 5.277, 5.525, 5.469, 5.590, 5.691, 5.569, 5.599, 5.718, 5.272, 5.586, 5.724, 5.576, 5.267, 5.501, 5.558, 5.448, 5.279, 5.257, 5.700, 5.554, 5.601, 5.492, 5.498, 5.395, 5.444, 5.597, 5.288
9	5310	9	1	333	1	5.293, 5.614, 5.335, 5.699, 5.427, 5.254, 5.475, 5.688, 5.301, 5.564, 5.311, 5.294, 5.577, 5.691, 5.348, 5.646, 5.398, 5.376, 5.524, 5.597, 5.298, 5.367, 5.550, 5.553, 5.659, 5.644, 5.380, 5.303, 5.455, 5.668, 5.703, 5.710, 5.414, 5.277, 5.534, 5.662, 5.389, 5.250, 5.704, 5.701, 5.569, 5.605, 5.478, 5.463, 5.276, 5.337, 5.265, 5.289, 5.676, 5.572, 5.609, 5.492, 5.259, 5.450, 5.472, 5.330, 5.546, 5.457, 5.518, 5.312, 5.536, 5.585, 5.656, 5.296, 5.651, 5.618, 5.395, 5.615, 5.481, 5.638, 5.422, 5.525, 5.336, 5.568, 5.650, 5.511, 5.306, 5.436, 5.420, 5.310, 5.438, 5.358, 5.445, 5.447, 5.711, 5.257, 5.473, 5.460, 5.598, 5.717, 5.470, 5.578, 5.648, 5.695, 5.387, 5.674, 5.708, 5.446, 5.573, 5.261
10	5310	9	1	333	1	5.301, 5.312, 5.506, 5.645, 5.564, 5.254, 5.282, 5.424, 5.572, 5.294, 5.687, 5.272, 5.556, 5.595, 5.654, 5.399, 5.558, 5.603, 5.630, 5.258, 5.466, 5.284, 5.407, 5.404, 5.302, 5.417, 5.260, 5.361, 5.696, 5.676, 5.496, 5.437, 5.623, 5.365, 5.634, 5.290, 5.507, 5.490, 5.686, 5.355, 5.388, 5.531, 5.476, 5.689, 5.565, 5.457, 5.336, 5.600, 5.291, 5.701, 5.454, 5.469, 5.313, 5.646, 5.560, 5.483, 5.453, 5.271, 5.711, 5.315, 5.580, 5.401, 5.553, 5.529, 5.323, 5.369, 5.723, 5.391, 5.478, 5.607, 5.451, 5.363, 5.346, 5.688, 5.568, 5.721, 5.548, 5.533, 5.550, 5.259, 5.255, 5.438, 5.545, 5.429, 5.518, 5.474, 5.574, 5.480, 5.714, 5.326, 5.554, 5.602, 5.251, 5.279, 5.473, 5.338, 5.563, 5.269, 5.573, 5.609
11	5310	9	1	333	1	5.350, 5.589, 5.360, 5.496, 5.408, 5.331, 5.446, 5.301, 5.709, 5.300, 5.359, 5.598, 5.358, 5.573, 5.549, 5.489, 5.584, 5.572,

						5.400, 5.343, 5.537, 5.466, 5.401, 5.252, 5.611, 5.719, 5.544, 5.366, 5.472, 5.505, 5.323, 5.307, 5.683, 5.260, 5.523, 5.374, 5.519, 5.664, 5.348, 5.671, 5.347, 5.448, 5.369, 5.468, 5.628, 5.706, 5.717, 5.527, 5.434, 5.396, 5.320, 5.420, 5.554, 5.436, 5.501, 5.615, 5.526, 5.327, 5.594, 5.430, 5.428, 5.674, 5.488, 5.340, 5.490, 5.577, 5.337, 5.403, 5.570, 5.293, 5.264, 5.297, 5.352, 5.318, 5.261, 5.553, 5.517, 5.633, 5.265, 5.305, 5.515, 5.596, 5.312, 5.289, 5.543, 5.721, 5.668, 5.521, 5.650, 5.476, 5.259, 5.456, 5.640, 5.368, 5.484, 5.677, 5.470, 5.557, 5.291, 5.626
12	5310	9	1	333	1	5.478, 5.319, 5.645, 5.449, 5.276, 5.498, 5.415, 5.294, 5.343, 5.369, 5.293, 5.392, 5.500, 5.584, 5.450, 5.541, 5.706, 5.644, 5.431, 5.265, 5.468, 5.283, 5.492, 5.312, 5.652, 5.515, 5.545, 5.682, 5.404, 5.337, 5.298, 5.411, 5.507, 5.537, 5.587, 5.332, 5.495, 5.496, 5.258, 5.448, 5.311, 5.580, 5.462, 5.340, 5.342, 5.590, 5.640, 5.467, 5.277, 5.627, 5.554, 5.285, 5.256, 5.261, 5.347, 5.641, 5.488, 5.556, 5.559, 5.667, 5.430, 5.367, 5.542, 5.503, 5.518, 5.435, 5.262, 5.401, 5.721, 5.502, 5.571, 5.350, 5.643, 5.463, 5.335, 5.291, 5.491, 5.382, 5.274, 5.519, 5.326, 5.374, 5.668, 5.664, 5.394, 5.323, 5.679, 5.550, 5.620, 5.514, 5.524, 5.588, 5.479, 5.642, 5.316, 5.469, 5.714, 5.558, 5.683, 5.320
13	5310	9	1	333	1	5.486, 5.674, 5.666, 5.333, 5.538, 5.625, 5.675, 5.424, 5.654, 5.433, 5.460, 5.485, 5.457, 5.693, 5.677, 5.638, 5.508, 5.526, 5.476, 5.636, 5.560, 5.551, 5.449, 5.713, 5.347, 5.472, 5.354, 5.293, 5.673, 5.362, 5.441, 5.688, 5.366, 5.365, 5.593, 5.428, 5.369, 5.578, 5.306, 5.273, 5.574, 5.269, 5.420, 5.667, 5.615, 5.453, 5.612, 5.411, 5.300, 5.406, 5.436, 5.645, 5.435, 5.619, 5.445, 5.607, 5.572, 5.484, 5.720, 5.397, 5.499, 5.446, 5.330, 5.361, 5.672, 5.552, 5.497, 5.404, 5.368, 5.335, 5.719, 5.380, 5.329, 5.346, 5.690, 5.685, 5.524, 5.355, 5.461, 5.599, 5.500, 5.646, 5.379, 5.400, 5.587, 5.617, 5.359, 5.547, 5.256, 5.375, 5.630, 5.305, 5.357, 5.663, 5.288, 5.363, 5.637, 5.432, 5.684, 5.294
14	5310	9	1	333	1	5.718, 5.429, 5.546, 5.380, 5.424, 5.404, 5.648, 5.302, 5.400, 5.464, 5.250, 5.676, 5.660, 5.708, 5.280, 5.524, 5.700, 5.707, 5.647, 5.600, 5.279, 5.357, 5.282, 5.618, 5.445, 5.545, 5.483, 5.516, 5.525, 5.419, 5.371, 5.569, 5.369, 5.669, 5.685, 5.354, 5.564, 5.471, 5.585, 5.328, 5.493, 5.379, 5.677, 5.396, 5.621, 5.671, 5.557, 5.528, 5.565, 5.561, 5.303, 5.408, 5.334, 5.350, 5.255, 5.614, 5.644, 5.318, 5.406, 5.577, 5.314, 5.454, 5.556, 5.716, 5.262, 5.317, 5.295, 5.484, 5.299, 5.573, 5.427, 5.286

						5.392, 5.547, 5.536, 5.284, 5.719, 5.323, 5.620, 5.551, 5.562, 5.634, 5.276, 5.602, 5.657, 5.522, 5.260, 5.554, 5.320, 5.632, 5.409, 5.609, 5.375, 5.640, 5.692, 5.356, 5.272, 5.388, 5.285, 5.606
15	5310	9	1	333	1	5.321, 5.294, 5.298, 5.308, 5.448, 5.586, 5.692, 5.542, 5.361, 5.567, 5.382, 5.636, 5.317, 5.497, 5.533, 5.695, 5.403, 5.280, 5.394, 5.701, 5.694, 5.721, 5.708, 5.614, 5.467, 5.716, 5.696, 5.527, 5.348, 5.538, 5.406, 5.449, 5.556, 5.722, 5.492, 5.460, 5.584, 5.719, 5.547, 5.414, 5.517, 5.334, 5.265, 5.444, 5.710, 5.404, 5.704, 5.417, 5.446, 5.296, 5.425, 5.387, 5.260, 5.612, 5.445, 5.269, 5.626, 5.501, 5.558, 5.430, 5.411, 5.581, 5.311, 5.266, 5.574, 5.568, 5.475, 5.291, 5.650, 5.466, 5.258, 5.374, 5.549, 5.376, 5.453, 5.288, 5.545, 5.649, 5.601, 5.677, 5.724, 5.391, 5.482, 5.367, 5.504, 5.703, 5.535, 5.530, 5.368, 5.675, 5.654, 5.355, 5.720, 5.299, 5.337, 5.295, 5.254, 5.663, 5.551, 5.483
16	5310	9	1	333	1	5.599, 5.349, 5.594, 5.421, 5.358, 5.262, 5.671, 5.414, 5.626, 5.420, 5.314, 5.370, 5.563, 5.267, 5.386, 5.452, 5.569, 5.347, 5.673, 5.688, 5.529, 5.567, 5.629, 5.467, 5.276, 5.348, 5.368, 5.640, 5.477, 5.343, 5.601, 5.411, 5.687, 5.363, 5.289, 5.430, 5.274, 5.298, 5.428, 5.440, 5.287, 5.339, 5.538, 5.584, 5.446, 5.678, 5.503, 5.665, 5.647, 5.545, 5.551, 5.644, 5.317, 5.281, 5.344, 5.701, 5.548, 5.325, 5.683, 5.255, 5.606, 5.484, 5.663, 5.275, 5.264, 5.686, 5.530, 5.694, 5.627, 5.657, 5.498, 5.356, 5.512, 5.541, 5.587, 5.327, 5.461, 5.425, 5.630, 5.649, 5.288, 5.474, 5.340, 5.540, 5.539, 5.550, 5.632, 5.476, 5.380, 5.451, 5.641, 5.269, 5.449, 5.558, 5.313, 5.361, 5.482, 5.253, 5.285, 5.311
17	5310	9	1	333	1	5.468, 5.573, 5.289, 5.570, 5.306, 5.664, 5.426, 5.251, 5.415, 5.607, 5.704, 5.382, 5.485, 5.358, 5.353, 5.286, 5.659, 5.302, 5.572, 5.372, 5.258, 5.276, 5.499, 5.618, 5.549, 5.723, 5.464, 5.374, 5.722, 5.585, 5.301, 5.379, 5.502, 5.341, 5.337, 5.506, 5.259, 5.364, 5.299, 5.698, 5.627, 5.318, 5.629, 5.300, 5.550, 5.626, 5.635, 5.399, 5.349, 5.315, 5.513, 5.650, 5.631, 5.505, 5.612, 5.309, 5.403, 5.268, 5.458, 5.632, 5.381, 5.701, 5.671, 5.511, 5.386, 5.280, 5.715, 5.393, 5.702, 5.682, 5.461, 5.587, 5.614, 5.636, 5.488, 5.477, 5.434, 5.530, 5.663, 5.501, 5.369, 5.679, 5.320, 5.436, 5.519, 5.688, 5.351, 5.429, 5.602, 5.707, 5.691, 5.540, 5.494, 5.291, 5.457, 5.498, 5.433, 5.561, 5.384, 5.616
18	5310	9	1	333	1	5.708, 5.593, 5.694, 5.578, 5.288, 5.562, 5.263, 5.262, 5.324, 5.631, 5.661, 5.492, 5.558, 5.718, 5.267, 5.548, 5.528, 5.334, 5.272, 5.679, 5.313, 5.687, 5.603, 5.671,

						5.668, 5.444, 5.415, 5.450, 5.689, 5.542, 5.457, 5.723, 5.432, 5.601, 5.500, 5.520, 5.321, 5.518, 5.652, 5.447, 5.359, 5.547, 5.595, 5.445, 5.609, 5.484, 5.453, 5.417, 5.497, 5.292, 5.405, 5.539, 5.460, 5.649, 5.623, 5.384, 5.381, 5.537, 5.297, 5.387, 5.625, 5.613, 5.583, 5.485, 5.670, 5.546, 5.350, 5.380, 5.394, 5.407, 5.455, 5.343, 5.559, 5.406, 5.572, 5.620, 5.340, 5.441, 5.575, 5.404, 5.486, 5.549, 5.251, 5.421, 5.351, 5.425, 5.332, 5.358, 5.506, 5.433, 5.496, 5.470, 5.557, 5.473, 5.499, 5.502, 5.458, 5.677, 5.599, 5.571
19	5310	9	1	333	1	5.703, 5.634, 5.354, 5.351, 5.617, 5.629, 5.577, 5.674, 5.681, 5.352, 5.261, 5.412, 5.540, 5.608, 5.672, 5.340, 5.337, 5.476, 5.408, 5.510, 5.717, 5.430, 5.507, 5.417, 5.285, 5.361, 5.281, 5.625, 5.670, 5.700, 5.353, 5.583, 5.716, 5.550, 5.645, 5.724, 5.330, 5.647, 5.555, 5.435, 5.611, 5.387, 5.570, 5.621, 5.595, 5.418, 5.680, 5.357, 5.619, 5.461, 5.547, 5.668, 5.255, 5.593, 5.580, 5.614, 5.605, 5.380, 5.265, 5.307, 5.684, 5.652, 5.462, 5.561, 5.271, 5.259, 5.720, 5.253, 5.649, 5.565, 5.552, 5.375, 5.260, 5.572, 5.665, 5.414, 5.371, 5.297, 5.449, 5.562, 5.272, 5.279, 5.712, 5.413, 5.275, 5.421, 5.598, 5.374, 5.557, 5.687, 5.395, 5.475, 5.697, 5.434, 5.677, 5.343, 5.359, 5.709, 5.389, 5.571
20	5310	9	1	333	1	5.335, 5.298, 5.520, 5.494, 5.295, 5.600, 5.289, 5.595, 5.702, 5.514, 5.400, 5.661, 5.606, 5.398, 5.578, 5.686, 5.668, 5.329, 5.339, 5.441, 5.349, 5.498, 5.442, 5.638, 5.655, 5.570, 5.476, 5.641, 5.280, 5.705, 5.372, 5.340, 5.534, 5.562, 5.703, 5.448, 5.551, 5.377, 5.542, 5.692, 5.617, 5.416, 5.525, 5.679, 5.724, 5.304, 5.331, 5.629, 5.586, 5.255, 5.508, 5.699, 5.278, 5.571, 5.674, 5.315, 5.601, 5.266, 5.599, 5.355, 5.447, 5.382, 5.685, 5.433, 5.625, 5.341, 5.548, 5.317, 5.637, 5.627, 5.468, 5.287, 5.358, 5.544, 5.715, 5.369, 5.465, 5.535, 5.276, 5.375, 5.396, 5.519, 5.667, 5.582, 5.332, 5.664, 5.393, 5.397, 5.721, 5.581, 5.487, 5.268, 5.463, 5.669, 5.660, 5.690, 5.480, 5.346, 5.294, 5.312
21	5310	9	1	333	1	5.713, 5.711, 5.349, 5.553, 5.428, 5.281, 5.313, 5.384, 5.715, 5.582, 5.607, 5.258, 5.714, 5.638, 5.456, 5.336, 5.694, 5.303, 5.521, 5.387, 5.279, 5.448, 5.474, 5.609, 5.429, 5.410, 5.274, 5.268, 5.519, 5.304, 5.487, 5.508, 5.692, 5.290, 5.681, 5.403, 5.637, 5.437, 5.447, 5.494, 5.341, 5.408, 5.418, 5.459, 5.524, 5.457, 5.296, 5.510, 5.423, 5.534, 5.390, 5.496, 5.648, 5.340, 5.687, 5.357, 5.379, 5.251, 5.417, 5.427, 5.433, 5.676, 5.359, 5.275, 5.298, 5.698, 5.364, 5.592, 5.712, 5.629, 5.685, 5.516, 5.585, 5.703, 5.570, 5.576, 5.684, 5.460,

						5.724, 5.600, 5.682, 5.262, 5.657, 5.312, 5.255, 5.250, 5.632, 5.291, 5.662, 5.528, 5.360, 5.699, 5.647, 5.722, 5.523, 5.264, 5.614, 5.677, 5.603, 5.361
22	5310	9	1	333	1	5.722, 5.546, 5.358, 5.688, 5.419, 5.267, 5.263, 5.418, 5.499, 5.314, 5.590, 5.550, 5.502, 5.433, 5.517, 5.274, 5.445, 5.423, 5.626, 5.532, 5.682, 5.273, 5.522, 5.678, 5.372, 5.293, 5.346, 5.394, 5.284, 5.470, 5.338, 5.365, 5.469, 5.307, 5.615, 5.663, 5.721, 5.271, 5.563, 5.655, 5.637, 5.279, 5.516, 5.330, 5.406, 5.412, 5.519, 5.515, 5.347, 5.490, 5.425, 5.255, 5.292, 5.642, 5.457, 5.414, 5.680, 5.251, 5.377, 5.500, 5.438, 5.612, 5.388, 5.387, 5.619, 5.437, 5.518, 5.698, 5.654, 5.442, 5.649, 5.667, 5.344, 5.575, 5.665, 5.577, 5.597, 5.435, 5.591, 5.613, 5.564, 5.692, 5.270, 5.416, 5.599, 5.645, 5.565, 5.396, 5.572, 5.391, 5.657, 5.432, 5.426, 5.704, 5.398, 5.595, 5.304, 5.652, 5.329, 5.582
23	5310	9	1	333	1	5.653, 5.615, 5.589, 5.686, 5.525, 5.700, 5.423, 5.541, 5.479, 5.400, 5.326, 5.704, 5.694, 5.270, 5.635, 5.665, 5.633, 5.358, 5.317, 5.419, 5.449, 5.404, 5.259, 5.382, 5.364, 5.692, 5.365, 5.570, 5.561, 5.509, 5.387, 5.495, 5.394, 5.476, 5.475, 5.517, 5.497, 5.507, 5.255, 5.405, 5.623, 5.333, 5.506, 5.722, 5.572, 5.721, 5.697, 5.277, 5.568, 5.592, 5.488, 5.643, 5.421, 5.618, 5.478, 5.272, 5.587, 5.401, 5.514, 5.699, 5.518, 5.356, 5.454, 5.335, 5.381, 5.571, 5.299, 5.275, 5.724, 5.302, 5.284, 5.295, 5.611, 5.516, 5.703, 5.522, 5.576, 5.307, 5.325, 5.591, 5.446, 5.651, 5.406, 5.513, 5.491, 5.549, 5.279, 5.430, 5.472, 5.315, 5.426, 5.655, 5.582, 5.708, 5.601, 5.427, 5.267, 5.493, 5.252, 5.464
24	5310	9	1	333	1	5.287, 5.616, 5.607, 5.704, 5.429, 5.649, 5.262, 5.646, 5.269, 5.496, 5.435, 5.685, 5.373, 5.347, 5.438, 5.424, 5.635, 5.483, 5.686, 5.707, 5.648, 5.359, 5.708, 5.377, 5.318, 5.590, 5.570, 5.484, 5.258, 5.522, 5.698, 5.362, 5.559, 5.366, 5.673, 5.612, 5.330, 5.298, 5.701, 5.596, 5.553, 5.478, 5.440, 5.531, 5.475, 5.423, 5.487, 5.710, 5.340, 5.399, 5.382, 5.453, 5.610, 5.672, 5.339, 5.500, 5.415, 5.255, 5.451, 5.578, 5.355, 5.509, 5.620, 5.583, 5.545, 5.329, 5.465, 5.317, 5.364, 5.393, 5.661, 5.480, 5.679, 5.700, 5.454, 5.381, 5.299, 5.564, 5.652, 5.336, 5.600, 5.687, 5.691, 5.532, 5.542, 5.404, 5.618, 5.650, 5.594, 5.400, 5.569, 5.354, 5.302, 5.458, 5.566, 5.389, 5.305, 5.688, 5.568, 5.360
25	5310	9	1	333	1	5.424, 5.493, 5.312, 5.400, 5.569, 5.298, 5.555, 5.524, 5.258, 5.476, 5.492, 5.480, 5.610, 5.627, 5.415, 5.399, 5.422, 5.612, 5.637, 5.431, 5.521, 5.639, 5.440, 5.393, 5.629, 5.701, 5.530, 5.323, 5.544, 5.348,

						5.625, 5.536, 5.332, 5.634, 5.697, 5.435, 5.655, 5.554, 5.251, 5.691, 5.345, 5.707, 5.267, 5.556, 5.448, 5.517, 5.349, 5.578, 5.469, 5.507, 5.299, 5.687, 5.717, 5.613, 5.445, 5.664, 5.705, 5.276, 5.303, 5.680, 5.325, 5.692, 5.444, 5.662, 5.600, 5.668, 5.318, 5.644, 5.326, 5.703, 5.640, 5.591, 5.380, 5.383, 5.377, 5.402, 5.485, 5.409, 5.561, 5.403, 5.293, 5.623, 5.528, 5.271, 5.314, 5.489, 5.553, 5.272, 5.310, 5.283, 5.585, 5.674, 5.438, 5.447, 5.473, 5.459, 5.678, 5.478, 5.386, 5.331
26	5310	9	1	333	1	5.347, 5.492, 5.527, 5.428, 5.664, 5.573, 5.543, 5.566, 5.649, 5.409, 5.678, 5.283, 5.431, 5.478, 5.318, 5.668, 5.665, 5.421, 5.537, 5.500, 5.618, 5.686, 5.499, 5.251, 5.301, 5.694, 5.645, 5.480, 5.366, 5.699, 5.353, 5.278, 5.252, 5.489, 5.460, 5.269, 5.471, 5.257, 5.407, 5.634, 5.486, 5.444, 5.293, 5.675, 5.667, 5.321, 5.464, 5.697, 5.350, 5.518, 5.275, 5.465, 5.708, 5.540, 5.525, 5.296, 5.532, 5.453, 5.592, 5.511, 5.308, 5.498, 5.377, 5.310, 5.331, 5.627, 5.514, 5.470, 5.384, 5.288, 5.373, 5.643, 5.488, 5.641, 5.720, 5.721, 5.593, 5.426, 5.481, 5.559, 5.253, 5.325, 5.354, 5.494, 5.700, 5.586, 5.364, 5.683, 5.504, 5.555, 5.397, 5.576, 5.625, 5.607, 5.723, 5.496, 5.327, 5.659, 5.303, 5.671
27	5310	9	1	333	1	5.515, 5.393, 5.569, 5.678, 5.699, 5.414, 5.476, 5.369, 5.517, 5.721, 5.488, 5.288, 5.273, 5.426, 5.599, 5.387, 5.536, 5.613, 5.479, 5.528, 5.535, 5.690, 5.588, 5.343, 5.465, 5.475, 5.384, 5.723, 5.540, 5.607, 5.449, 5.425, 5.349, 5.503, 5.385, 5.256, 5.351, 5.313, 5.602, 5.562, 5.456, 5.537, 5.645, 5.261, 5.320, 5.686, 5.722, 5.339, 5.697, 5.523, 5.516, 5.707, 5.468, 5.617, 5.501, 5.527, 5.459, 5.574, 5.553, 5.399, 5.350, 5.531, 5.262, 5.572, 5.594, 5.377, 5.595, 5.473, 5.583, 5.259, 5.446, 5.474, 5.334, 5.408, 5.327, 5.679, 5.325, 5.504, 5.253, 5.303, 5.629, 5.664, 5.279, 5.348, 5.480, 5.443, 5.543, 5.472, 5.373, 5.615, 5.433, 5.701, 5.439, 5.441, 5.675, 5.590, 5.491, 5.542, 5.634, 5.251
28	5310	9	1	333	1	5.294, 5.257, 5.343, 5.516, 5.482, 5.638, 5.496, 5.489, 5.625, 5.623, 5.293, 5.536, 5.255, 5.274, 5.478, 5.520, 5.441, 5.577, 5.659, 5.630, 5.616, 5.463, 5.589, 5.460, 5.710, 5.319, 5.535, 5.401, 5.327, 5.584, 5.598, 5.629, 5.663, 5.720, 5.651, 5.330, 5.695, 5.384, 5.568, 5.511, 5.349, 5.262, 5.469, 5.601, 5.334, 5.373, 5.455, 5.549, 5.724, 5.684, 5.346, 5.430, 5.614, 5.602, 5.416, 5.579, 5.400, 5.657, 5.671, 5.309, 5.465, 5.492, 5.261, 5.454, 5.446, 5.574, 5.315, 5.342, 5.347, 5.320, 5.680, 5.554, 5.603, 5.699, 5.634, 5.322, 5.683, 5.447, 5.588, 5.378, 5.444, 5.519, 5.413, 5.655,

						5.332, 5.524, 5.669, 5.263, 5.273, 5.481, 5.692, 5.619, 5.363, 5.537, 5.486, 5.386, 5.493, 5.371, 5.459, 5.567
29	5310	9	1	333	1	5.663, 5.253, 5.702, 5.425, 5.478, 5.413, 5.489, 5.424, 5.352, 5.333, 5.567, 5.361, 5.337, 5.523, 5.345, 5.546, 5.401, 5.590, 5.705, 5.660, 5.474, 5.679, 5.625, 5.433, 5.290, 5.414, 5.606, 5.383, 5.504, 5.298, 5.515, 5.626, 5.264, 5.636, 5.664, 5.367, 5.505, 5.681, 5.500, 5.599, 5.639, 5.709, 5.251, 5.671, 5.580, 5.690, 5.356, 5.502, 5.269, 5.442, 5.694, 5.323, 5.490, 5.265, 5.497, 5.595, 5.473, 5.373, 5.257, 5.556, 5.488, 5.616, 5.496, 5.348, 5.303, 5.648, 5.501, 5.324, 5.435, 5.339, 5.463, 5.630, 5.421, 5.618, 5.363, 5.371, 5.533, 5.318, 5.526, 5.581, 5.389, 5.646, 5.436, 5.540, 5.471, 5.483, 5.441, 5.693, 5.405, 5.449, 5.527, 5.287, 5.587, 5.643, 5.510, 5.650, 5.547, 5.263, 5.492, 5.467
30	5310	9	1	333	1	5.308, 5.463, 5.538, 5.644, 5.711, 5.271, 5.590, 5.445, 5.482, 5.476, 5.458, 5.609, 5.653, 5.292, 5.493, 5.500, 5.461, 5.474, 5.633, 5.302, 5.374, 5.686, 5.359, 5.367, 5.565, 5.645, 5.335, 5.270, 5.468, 5.582, 5.604, 5.256, 5.277, 5.310, 5.497, 5.601, 5.586, 5.331, 5.657, 5.411, 5.518, 5.301, 5.306, 5.561, 5.327, 5.705, 5.452, 5.471, 5.349, 5.478, 5.592, 5.492, 5.521, 5.577, 5.710, 5.410, 5.371, 5.614, 5.662, 5.667, 5.415, 5.697, 5.283, 5.512, 5.694, 5.718, 5.588, 5.489, 5.511, 5.480, 5.481, 5.717, 5.539, 5.688, 5.629, 5.563, 5.678, 5.655, 5.579, 5.556, 5.666, 5.437, 5.624, 5.723, 5.599, 5.299, 5.531, 5.254, 5.507, 5.406, 5.393, 5.397, 5.413, 5.580, 5.560, 5.284, 5.530, 5.504, 5.262, 5.602

80MHz,

Radar SignalType	Waveform/Trial Number	Detection (%)	Limit (%)	Pass/Fail
Type 1A	15	100%	60%	pass
Type 1B	15	100%		
Type 2	30	100%	60%	Pass
Type 3	30	100%	60%	Pass
Type 4	30	100%	60%	Pass
Aggregate(Type1 to 4)	120	100 %	80%	Pass
Type 5	29	100%	80%	Pass
Type 6	30	100 %	70%	Pass

Please refer to the following statistical tables:

5290MHz**Radar Type 1A Statistical Performance**

Trial #	Fc (MHz)	Pulse/Burst	Pulse Width (μS)	PRI (μs)	Detection (1:yes; 0:no)
1	5290	86	1	618	1
2	5290	78	1	678	1
3	5290	92	1	578	1
4	5290	62	1	858	1
5	5290	18	1	3066	1
6	5290	98	1	538	1
7	5290	67	1	798	1
8	5290	74	1	718	1
9	5290	57	1	938	1
10	5290	89	1	598	1
11	5290	68	1	778	1
12	5290	59	1	898	1
13	5290	63	1	838	1
14	5290	95	1	558	1
15	5290	65	1	818	1
Detection Percentage: 100 % (>60%)					

Radar Type 1B Statistical Performance

Trial #	Fc (MHz)	Pulse/Burst	Pulse Width (μS)	PRI (μs)	Detection (1:yes; 0:no)
1	5290	33	1	1619	1
2	5290	27	1	2024	1
3	5290	20	1	2732	1
4	5290	53	1	1011	1
5	5290	36	1	1498	1
6	5290	21	1	2598	1
7	5290	21	1	2546	1
8	5290	30	1	1795	1
9	5290	27	1	2004	1
10	5290	19	1	2852	1
11	5290	33	1	1645	1
12	5290	19	1	2816	1
13	5290	24	1	2278	1
14	5290	31	1	1719	1
15	5290	18	1	3038	1
Detection Percentage: 100 % (>60%)					

Radar Type 2 Statistical Performance

Trial #	Fc (MHz)	Pulse/Burst	Pulse Width (μS)	PRI (μs)	Detection (1:yes; 0:no)
1	5290	26	1.4	227	1
2	5290	26	2	175	1
3	5290	26	2.2	178	1
4	5290	24	2	185	1
5	5290	28	2.6	208	1
6	5290	25	5	194	1
7	5290	23	3.6	225	1
8	5290	28	1	226	1
9	5290	23	3.1	208	1
10	5290	25	1.4	194	1
11	5290	25	1.6	201	1
12	5290	26	1.9	205	1
13	5290	25	2	198	1
14	5290	27	3	150	1
15	5290	27	2.1	190	1
16	5290	27	3.6	205	1
17	5290	28	1.6	179	1
18	5290	23	1.7	216	1
19	5290	26	1.4	228	1
20	5290	27	2.8	185	1
21	5290	25	3.5	211	1
22	5290	27	1	197	1
23	5290	27	4.7	156	1
24	5290	28	2.1	184	1
25	5290	29	4.1	152	1
26	5290	29	3.3	188	1
27	5290	27	1.2	216	1
28	5290	28	2.3	167	1
29	5290	27	4.4	164	1
30	5290	26	5	197	1
Detection Percentage: 100 % (>60%)					

Radar Type 3 Statistical Performance

Trial #	Fc (MHz)	Pulse/Burst	Pulse Width (μS)	PRI (μs)	Detection (1:yes; 0:no)
1	5290	17	9	308	1
2	5290	16	9.1	401	1
3	5290	18	9.9	430	1
4	5290	17	7.8	493	1
5	5290	16	6.2	452	1
6	5290	16	8.3	416	1
7	5290	18	8.4	398	1
8	5290	16	7.8	439	1
9	5290	16	7.7	369	1
10	5290	17	8.1	287	1
11	5290	16	9.2	478	1
12	5290	17	7.6	446	1
13	5290	17	9.1	441	1
14	5290	17	9.9	327	1
15	5290	17	7.9	292	1
16	5290	18	8.7	335	1
17	5290	17	9.5	439	1
18	5290	17	9.1	435	1
19	5290	16	7.4	265	1
20	5290	17	7.5	288	1
21	5290	18	6	462	1
22	5290	18	8.8	207	1
23	5290	16	8.2	444	1
24	5290	18	8.9	492	1
25	5290	18	6.1	241	1
26	5290	17	7.8	318	1
27	5290	16	9.8	260	1
28	5290	17	7.3	353	1
29	5290	17	7.6	240	1
30	5290	18	9.6	500	1
Detection Percentage: 100 % (>60%)					

Radar Type 4 Statistical Performance

Trial #	Fc (MHz)	Pulse/Burst	Pulse Width (µS)	PRI (µs)	Detection (1:yes; 0:no)
1	5290	13	13.4	434	1
2	5290	14	17.5	380	1
3	5290	14	14	376	1
4	5290	15	12	212	1
5	5290	13	13	315	1
6	5290	14	16.5	394	1
7	5290	13	14.5	293	1
8	5290	15	18.8	332	1
9	5290	14	18.3	495	1
10	5290	15	18.3	485	1
11	5290	15	13.5	284	1
12	5290	16	11.3	259	1
13	5290	15	17.7	316	1
14	5290	16	18	257	1
15	5290	15	12.5	441	1
16	5290	12	11.7	239	1
17	5290	16	18	397	1
18	5290	13	18.2	246	1
19	5290	15	15.9	389	1
20	5290	14	14.2	363	1
21	5290	13	17.5	473	1
22	5290	15	19.2	332	1
23	5290	13	14.9	419	1
24	5290	14	11.9	376	1
25	5290	16	19.5	358	1
26	5290	16	17.5	337	1
27	5290	13	13.1	297	1
28	5290	12	11.7	236	1
29	5290	15	18.7	245	1
30	5290	13	14.1	235	1
Detection Percentage: 100 % (>60%)					

Radar Type 5 Statistical Performance

Statistics 1 (ChirpCenter Frequency: 5270 MHz)

Trial #	Pulse	Chirp(MHz)	Pulse Width (µS)	Pulse 1-2 spacing(µS)	Pulse 2-3 spacing(µS)	Pulse Start(mS)	Detection (1:yes;0:no)
1	3	10	63.2	1720	1982	459.841	1
2	2	10	79.2	1650		14.083	
3	2	10	60.4	1507		516.266	
4	3	10	95.1	1973	1351	707.659	
5	2	10	85.3	1633		485.332	
6	2	10	65.9	1841		371.505	
7	2	10	75.7	1719		215.558	
8	2	10	87.8	1094		271.572	
9	2	10	82.7	1009		649.655	
10	2	10	56.9	1753		173.828	
11	2	10	94.4	1628		653.191	
12	2	10	90.6	1023		592.854	
13	1	10	80.1			206.677	

Statistics 2 (ChirpCenter Frequency: 5270 MHz)

Trial #	Pulse	Chirp(MHz)	Pulse Width (µS)	Pulse 1-2 spacing(µS)	Pulse 2-3 spacing(µS)	Pulse Start(mS)	Detection (1:yes;0:no)
1	3	9	64.9	1706	1914	424.815	1
2	2	9	87.5	1875		376.675	
3	2	9	63.3	1617		407.03	
4	3	9	80.1	1889	1703	525.39	
5	2	9	57.1	1381		154.16	
6	1	9	94.5			533.44	
7	3	9	90.9	1917	1441	463.86	
8	2	9	57.3	1342		436.56	
9	2	9	85.7	1566		247.64	
10	1	9	73.8			291.03	
11	3	9	59	1684	1923	407.93	
12	1	9	55.7			180.69	
13	2	9	59.4	1325		70.35	
14	3	9	93.2	1697	1608	145.24	
15	2	9	73.2	1272		2.26	
16	1	9	71.5			579.24	
17	2	9	52.3	1800		55.57	
18	1	9	89.8			84.9	
19	3	9	85.7	1053	1377	396.9	
20	2	9	81.2	1413		267	

Statistics 3 (ChirpCenter Frequency: 5270 MHz)

Trial #	Pulse	Chirp(MHz)	Pulse Width (µS)	Pulse 1-2 spacing(µS)	Pulse 2-3 spacing(µS)	Pulse Start(mS)	Detection (1:yes;0:no)
1	2	14	63.7	1347		166.207	1
2	2	14	70.2	1972		509.93	
3	3	14	63.6	1710	1208	582.36	
4	3	14	92.6	1593	1068	652.07	
5	1	14	74			306.85	
6	3	14	53	1398	1484	212.15	
7	3	14	73.3	1330	1783	8.43	
8	1	14	67.6			504.45	
9	3	14	80.1	1338	1771	399.89	
10	3	14	67.5	1640	1748	496.23	
11	2	14	54.9	1471		117.44	
12	2	14	81.4	1460		221.82	
13	2	14	60.1	1864		450.18	
14	2	14	84.9	1679		620.7	
15	3	14	55.7	1208	1275	296.7	
16	2	14	75.3	1625		593.3	

Statistics 4 (ChirpCenter Frequency: 5270 MHz)

Trial #	Pulse	Chirp(MHz)	Pulse Width (µS)	Pulse 1-2 spacing(µS)	Pulse 2-3 spacing(µS)	Pulse Start(mS)	Detection (1:yes;0:no)
1	1	11	76.2			530.986	1
2	2	11	86.5	1161		537.298	
3	1	11	72.9			555.545	
4	1	11	54.2			1.533	
5	1	11	85.6			342.901	
6	2	11	97.7	1748		341.168	
7	3	11	66.4	1677	1905	142.836	
8	3	11	89.2	1305	1440	114.424	
9	3	11	71.4	1002	1104	333.821	
10	2	11	73.2	1132		229.739	
11	1	11	54.5			658.146	
12	3	11	70.8	1513	1183	91.614	
13	1	11	51.1			257.772	
14	1	11	84.3			392.469	
15	2	11	69	1533		500.847	
16	2	11	81.1	1672		103.565	
17	2	11	55.4	1941		160.282	

Statistics 5 (ChirpCenter Frequency: 5270 MHz)

Trial #	Pulse	Chirp(MHz)	Pulse Width (μS)	Pulse 1-2 spacing(μS)	Pulse 2-3 spacing(μS)	Pulse Start(mS)	Detection (1:yes;0:no)
1	2	20	52.7	1333		667.599	1
2	3	20	67.2	1703	1652	456.648	
3	2	20	56.4	1027		221.945	
4	3	20	72.6	1861	1740	375.013	
5	2	20	92.7	1993		449.711	
6	1	20	64.4			526.018	
7	2	20	58.3	1271		71.436	
8	2	20	97.4	1305		16.674	
9	2	20	61.5	1096		633.731	
10	2	20	61.9	1941		330.299	
11	3	20	88.2	1955	1353	590.086	
12	1	20	71.3			639.694	
13	2	20	73.6	1801		513.302	
14	1	20	77.6			427.529	
15	1	20	74.4			312.547	
16	2	20	74.6	1069		458.565	
17	1	20	94.6			447.182	

Statistics 6 (ChirpCenter Frequency: 5270 MHz)

Trial #	Pulse	Chirp(MHz)	Pulse Width (μS)	Pulse 1-2 spacing(μS)	Pulse 2-3 spacing(μS)	Pulse Start(mS)	Detection (1:yes;0:no)
1	2	14	53.9	1502		15.225	1
2	2	14	52.4	1070		963.26	
3	2	14	97	1234		436.94	
4	3	14	64.3	1978	1771	957.44	
5	2	14	75.6	1066		413.19	
6	1	14	52.9			385.23	
7	1	14	71			888.27	
8	2	14	95.7	1634		162.09	
9	2	14	91.2	1241		146.15	
10	1	14	59.3			800.1	
11	2	14	68.5	1872		26.9	
12	2	14	64	1718		292.4	

Statistics 7 (ChirpCenter Frequency: 5270 MHz)

Trial #	Pulse	Chirp(MHz)	Pulse Width (µS)	Pulse 1-2 spacing(µS)	Pulse 2-3 spacing(µS)	Pulse Start(mS)	Detection (1:yes;0:no)
1	2	10	58	1489		649.557	1
2	1	10	72.7			122.84	
3	2	10	69.9	1066		830.65	
4	2	10	88.5	1614		990.7	
5	2	10	80.9	1888		954.36	
6	2	10	87.5	1441		344.41	
7	2	10	54.2	1692		616.84	
8	2	10	62.7	1714		921.06	
9	2	10	66.8	1644		672.72	
10	1	10	81.5			95.29	
11	3	10	66.2	1571	1558	159.4	
12	2	10	89.2	1597		931.1	

Statistics 8 (ChirpCenter Frequency: 5270MHz)

Trial #	Pulse	Chirp(MHz)	Pulse Width (µS)	Pulse 1-2 spacing(µS)	Pulse 2-3 spacing(µS)	Pulse Start(mS)	Detection (1:yes;0:no)
1	2	20	64.8	1119		457.112	1
2	2	20	96.7	1442		522.173	
3	2	20	74.8	1933		601.527	
4	3	20	99.8	1007	1259	298.39	
5	2	20	80.6	1934		257.033	
6	2	20	72.3	1854		25.767	
7	2	20	79.1	1994		71.35	
8	2	20	87.9	1161		405.533	
9	1	20	68.1			632.537	
10	2	20	74.4	1554		513.51	
11	2	20	91.9	1550		249.643	
12	2	20	97.8	1549		206.417	
13	2	20	64.1	1353		232.12	
14	2	20	51.5	1576		131.093	
15	3	20	63.8	1591	1755	23.907	
16	3	20	52.3	1071	1759	463.4	
17	1	20	94.8			335.533	
18	2	20	65.4	1580		78.367	

Statistics 9 (ChirpCenter Frequency: 5270 MHz)

Trial #	Pulse	Chirp(MHz)	Pulse Width (µS)	Pulse 1-2 spacing(µS)	Pulse 2-3 spacing(µS)	Pulse Start(mS)	Detection (1:yes;0:no)
1	2	20	54.2	1869		535.154	1
2	1	20	85.4			252.817	
3	3	20	61	1122	1732	239.933	
4	1	20	80.3			194.23	
5	1	20	58.1			246.957	
6	2	20	92.5	1922		936.273	
7	3	20	59.3	1206	1103	1314	
8	2	20	59.6	1322		901.067	
9	1	20	68.1			782.733	

Statistics 10 (ChirpCenter Frequency: 5270 MHz)

Trial #	Pulse	Chirp(MHz)	Pulse Width (µS)	Pulse 1-2 spacing(µS)	Pulse 2-3 spacing(µS)	Pulse Start(mS)	Detection (1:yes;0:no)
1	2	8	63.6	1338		989.19	1
2	2	8	82.3	1210		300.801	
3	2	8	55.7	1244		589.342	
4	2	8	91.1	1057		890.893	
5	2	8	97.6	1872		446.984	
6	2	8	56.7	1479		409.525	
7	2	8	67.3	1847		1071.275	
8	1	8	62.4			661.696	
9	2	8	73.7	1397		3.807	
10	1	8	63.8			632.018	
11	2	8	55.8	1094		502.809	

Statistics 11 (ChirpCenter Frequency: 5256.4 MHz)

Trial #	Pulse	Chirp(MHz)	Pulse Width (µS)	Pulse 1-2 spacing(µS)	Pulse 2-3 spacing(µS)	Pulse Start(mS)	Detection (1:yes;0:no)
1	3	11	66.3	1310	1794	1.258	1
2	2	11	88.3	1343		57.864	
3	1	11	51.5			116.41	
4	3	11	53.8	1586	1664	146.75	
5	2	11	57.7	1645		219.62	
6	3	11	85.8	1237	1287	318.58	
7	2	11	86.8	1140		352.51	
8	3	11	87.1	1196	1439	103.61	
9	2	11	93.3	1152		195.51	
10	3	11	55.2	1130	1794	171.57	
11	1	11	91.6			515.8	
12	2	11	66	1756		51.14	
13	3	11	62.5	1851	1327	620.6	
14	3	11	73.3	1501	1013	370	
15	2	11	70.1	1804		100.2	

Statistics 12 (ChirpCenter Frequency: 5254.4 MHz)

Trial #	Pulse	Chirp(MHz)	Pulse Width (µS)	Pulse 1-2 spacing(µS)	Pulse 2-3 spacing(µS)	Pulse Start(mS)	Detection (1:yes;0:no)
1	3	6	51.3	1303	1886	332.173	1
2	3	6	83.2	1296	1294	385.573	
3	2	6	74.4	1045		184.787	
4	2	6	70.1	1768		245.75	
5	2	6	55.1	1952		433.093	
6	3	6	90.2	1881	1496	498.717	
7	1	6	77.7			23.15	
8	3	6	90.6	1656	1042	118.313	
9	2	6	64.3	1798		33.477	
10	2	6	58.4	1106		243.32	
11	2	6	91.7	1458		278.043	
12	2	6	78.1	1688		22.527	
13	1	6	58.1			448.61	
14	2	6	97.1	1394		650.753	
15	2	6	78.5	1633		233.377	
16	1	6	59.1			498.9	
17	2	6	88.4	1374		639.833	
18	3	6	78.2	1938	1121	481.967	

Statistics 13 (ChirpCenter Frequency: 5258.8 MHz)

Trial #	Pulse	Chirp(MHz)	Pulse Width (μS)	Pulse 1-2 spacing(μS)	Pulse 2-3 spacing(μS)	Pulse Start(mS)	Detection (1:yes;0:no)
1	3	17	64.9	1630	1818	917.986	1
2	2	17	81.6	1563		340.12	
3	2	17	56.9	1848		702.68	
4	2	17	54.6	1656		279.23	
5	3	17	79	1695	1697	715.69	
6	1	17	71.9			83.04	
7	2	17	60	1906		456.49	
8	1	17	76.3			337.71	
9	2	17	74.9	1612		923.83	
10	2	17	52.8	1773		896.3	
11	1	17	79.1			64.3	
12	1	17	53.3			910.8	

Statistics 14 (ChirpCenter Frequency: 5254.8 MHz)

Trial #	Pulse	Chirp(MHz)	Pulse Width (μS)	Pulse 1-2 spacing(μS)	Pulse 2-3 spacing(μS)	Pulse Start(mS)	Detection (1:yes;0:no)
1	1	7	57.8			631.667	1
2	1	7	64.9			786.22	
3	2	7	50.6	1206		553.62	
4	3	7	93.1	1442	1340	787.1	
5	2	7	91.4	1518		706.39	
6	2	7	61.3	1687		501.26	
7	2	7	100	1150		536.15	
8	2	7	77.6	1968		247.64	
9	1	7	67			712.25	
10	1	7	82.9			355.95	
11	3	7	91.7	1596	1431	478.29	
12	3	7	70.9	1027	1151	397.35	
13	2	7	56.1	1499		47.86	
14	2	7	98.5	1293		329.4	
15	2	7	93.6	1155		543.5	

Statistics 15 (ChirpCenter Frequency: 5260 MHz)

Trial #	Pulse	Chirp(MHz)	Pulse Width (µS)	Pulse 1-2 spacing(µS)	Pulse 2-3 spacing(µS)	Pulse Start(mS)	Detection (1:yes;0:no)
1	3	20	90.6	1943	1280	472.72	0
2	1	20	88			292.324	
3	2	20	62.2	1243		503.025	
4	2	20	52.4	1996		450.123	
5	2	20	65.4	1286		425.681	
6	3	20	78.7	1725	1533	8.468	
7	2	20	86.9	1059		38.456	
8	2	20	68.3	1436		410.024	
9	1	20	55.5			423.551	
10	2	20	85.8	1509		458.099	
11	2	20	90.1	1459		155.896	
12	3	20	70.6	1204	1334	346.214	
13	3	20	60.4	1080	1463	112.362	
14	2	20	55.4	1140		541.999	
15	3	20	68.8	1067	1050	353.347	
16	1	20	58			630.365	
17	3	20	59.3	1159	1521	665.482	

Statistics 16 (ChirpCenter Frequency: 5256.4 MHz)

Trial #	Pulse	Chirp(MHz)	Pulse Width (µS)	Pulse 1-2 spacing(µS)	Pulse 2-3 spacing(µS)	Pulse Start(mS)	Detection (1:yes;0:no)
1	3	11	83.7	1757	1967	95.953	1
2	2	11	72.8	1185		160.651	
3	2	11	70.8	1903		389.005	
4	1	11	63.7			109.333	
5	1	11	96.6			473.441	
6	2	11	56.5	1825		675.488	
7	3	11	95	1262	1702	115.076	
8	1	11	99.3			303.224	
9	2	11	96	1147		531.911	
10	2	11	88.8	1475		15.199	
11	2	11	92.3	1347		523.796	
12	3	11	86.7	1583	1777	481.474	
13	3	11	82.5	1951	1533	224.232	
14	2	11	74.8	1581		455.389	
15	1	11	85.6			130.347	
16	3	11	75	1074	1152	482.065	
17	2	11	57.4	1173		396.482	

Statistics 17 (ChirpCenter Frequency: 5259.2 MHz)

Trial #	Pulse	Chirp(MHz)	Pulse Width (µS)	Pulse 1-2 spacing(µS)	Pulse 2-3 spacing(µS)	Pulse Start(mS)	Detection (1:yes;0:no)
1	3	18	88.6	1959	1689	279.877	1
2	2	18	81	1899		19.7	
3	2	18	71.3	1189		1119.58	
4	2	18	78.6	1431		738.86	
5	2	18	90.8	1350		750.77	
6	1	18	92.9			1296.34	
7	3	18	62.4	1879	1930	1367.2	
8	2	18	67.6	1870		1141.2	

Statistics 18 (ChirpCenter Frequency: 5255.2 MHz)

Trial #	Pulse	Chirp(MHz)	Pulse Width (µS)	Pulse 1-2 spacing(µS)	Pulse 2-3 spacing(µS)	Pulse Start(mS)	Detection (1:yes;0:no)
1	2	8	57	1346		437.582	1
2	1	8	53.5			357.637	
3	3	8	68.9	1098	1595	199.704	
4	3	8	79.7	1531	1243	135.201	
5	2	8	84	1543		391.439	
6	3	8	73.2	1457	1640	7.706	
7	3	8	62.8	1119	1381	833.193	
8	2	8	96.2	1870		436.64	
9	2	8	56.6	1840		701.187	
10	1	8	85.1			116.724	
11	2	8	75.9	1725		182.741	
12	2	8	60.1	1745		272.009	
13	2	8	78	1220		33.786	
14	2	8	61.8	1559		257.743	

Statistics 19 (ChirpCenter Frequency: 5259.6 MHz)

Trial #	Pulse	Chirp(MHz)	Pulse Width (µS)	Pulse 1-2 spacing(µS)	Pulse 2-3 spacing(µS)	Pulse Start(mS)	Detection (1:yes;0:no)
1	2	19	96.7	1263		914.423	1
2	3	19	54.3	1021	1108	765.793	
3	1	19	78.9			840.716	
4	3	19	58.5	1374	1402	741.269	
5	1	19	82.3			180.502	
6	1	19	93.4			177.175	
7	2	19	50.7	1186		568.628	
8	2	19	92	1690		147.802	
9	2	19	71.3	1315		572.195	
10	2	19	70.1	1476		479.608	
11	1	19	98			371.661	
12	3	19	68.9	1856	1205	446.354	
13	3	19	74.2	1449	1112	630.677	

Statistics 20 (ChirpCenter Frequency: 5254.4 MHz)

Trial #	Pulse	Chirp(MHz)	Pulse Width (µS)	Pulse 1-2 spacing(µS)	Pulse 2-3 spacing(µS)	Pulse Start(mS)	Detection (1:yes;0:no)
1	1	6	96.6			698.125	1
2	3	6	72.3	1359	1626	953.8	
3	2	6	73.9	1841		933.98	
4	2	6	99.5	1462		713.56	
5	2	6	74.2	1992		745.69	
6	3	6	83.2	1934	1777	564.7	
7	2	6	85.3	1784		249.88	
8	3	6	71.5	1604	1616	802.98	
9	2	6	96.4	1409		917.5	
10	1	6	91.3			1139.6	

Statistics 21 (ChirpCenter Frequency: 5282.8 MHz)

Trial #	Pulse	Chirp(MHz)	Pulse Width (µS)	Pulse 1-2 spacing(µS)	Pulse 2-3 spacing(µS)	Pulse Start(mS)	Detection (1:yes;0:no)
1	2	13	58.8	1788		397.652	1
2	2	13	69.5	1787		601.247	
3	2	13	76.6	1915		480.683	
4	2	13	83.5	1725		72.27	
5	3	13	95.1	1349	1435	169.037	
6	1	13	80.2			1007.673	
7	2	13	84.7	1334		138.47	
8	3	13	52.7	1409	1014	521.537	
9	2	13	80.3	1216		306.333	

Statistics 22 (ChirpCenter Frequency: 5283.2 MHz)

Trial #	Pulse	Chirp(MHz)	Pulse Width (µS)	Pulse 1-2 spacing(µS)	Pulse 2-3 spacing(µS)	Pulse Start(S)	Detection (1:yes;0:no)
1	1	12	91.7			188.923	1
2	1	12	65.3			323.71	
3	2	12	88	1797		148.35	
4	1	12	68.4			2.92	
5	3	12	62.3	1201	1755	404.83	
6	1	12	62.6			13.16	
7	1	12	81.2			188.27	
8	2	12	77.7	1297		193.48	
9	2	12	70.4	1868		294.83	
10	1	12	70.4			76.33	
11	2	12	53.3	1713		441.37	
12	1	12	83.2			80.07	
13	2	12	63.7	1785		147.36	
14	3	12	65.6	1499	1491	185.96	
15	2	12	70.3	1242		414.56	
16	3	12	80.6	1141	1009	397.42	
17	3	12	93.7	1487	1648	170.5	
18	3	12	57.7	1126	1233	257.7	
19	2	12	85.4	1102		440.6	
20	2	12	83.5	1408		235.6	

Statistics 23(ChirpCenter Frequency: 5280 MHz)

Trial #	Pulse	Chirp(MHz)	Pulse Width (µS)	Pulse 1-2 spacing(µS)	Pulse 2-3 spacing(µS)	Pulse Start(mS)	Detection (1:yes;0:no)
1	3	20	55.5	1686	1566	355.125	1
2	2	20	61.3	1876		68.532	
3	3	20	62.3	1199	1094	544.187	
4	1	20	69.6			484.37	
5	2	20	51.6	1793		512.953	
6	2	20	85.6	1120		213.157	
7	2	20	99	1682		299.81	
8	3	20	92.2	1813	1723	145.733	
9	2	20	94.1	1714		148.787	
10	2	20	58.6	1212		16.12	
11	1	20	69.6			8.963	
12	2	20	66.5	1436		659.467	
13	3	20	79.7	1291	1786	131.23	
14	3	20	77.4	1495	1959	435.163	
15	1	20	88.3			502.237	
16	2	20	99.3	1134		203	
17	2	20	73.5	1291		484.433	
18	2	20	73.1	1563		68.967	

Statistics 24(ChirpCenter Frequency: 5282 MHz)

Trial #	Pulse	Chirp(MHz)	Pulse Width (µS)	Pulse 1-2 spacing(µS)	Pulse 2-3 spacing(µS)	Pulse Start(mS)	Detection (1:yes;0:no)
1	3	15	92.5	1445	1031	348.413	1
2	3	15	95.7	1689	1503	334.964	
3	2	15	69.6	1683		363.73	
4	2	15	54.7	1540		424.33	
5	2	15	58.4	1512		257.93	
6	3	15	53.2	1865	1339	265.3	
7	2	15	76.5	1551		195.23	
8	2	15	68.9	1809		105.05	
9	3	15	82.2	1142	1179	490.69	
10	1	15	99.3			33.72	
11	2	15	54.1	1165		159.81	
12	1	15	96.3			387.67	
13	1	15	98.7			260.35	
14	2	15	73.8	1829		440.6	
15	3	15	78.5	1964	1630	481.44	
16	2	15	60.9	1797		130.44	
17	1	15	81.5			286.97	
18	2	15	59.3	1144		97.7	
19	1	15	99.2			335.2	
20	3	15	86.6	1079	1883	438.4	

Statistics 25(ChirpCenter Frequency: 5286 MHz)

Trial #	Pulse	Chirp(MHz)	Pulse Width (µS)	Pulse 1-2 spacing(µS)	Pulse 2-3 spacing(µS)	Pulse Start(mS)	Detection (1:yes;0:no)
1	3	5	96.1	1703	1847	773.346	1
2	3	5	54.6	1976	1752	429.453	
3	3	5	98	1251	1772	131.266	
4	1	5	69.5			30.989	
5	2	5	79	1091		499.242	
6	2	5	81.8	1510		182.215	
7	3	5	70.7	1644	1643	222.548	
8	3	5	51.8	1020	1962	566.782	
9	2	5	55.9	1008		253.255	
10	2	5	58.2	1241		453.788	
11	3	5	69.7	1016	1886	403.671	
12	1	5	60.2			74.454	
13	2	5	74.8	1367		673.577	

Statistics 26 (ChirpCenter Frequency: 5280.8 MHz)

Trial #	Pulse	Chirp(MHz)	Pulse Width (µS)	Pulse 1-2 spacing(µS)	Pulse 2-3 spacing(µS)	Pulse Start(mS)	Detection (1:yes;0:no)
1	3	18	66.3	1183	1583	201.457	1
2	3	18	52.2	1593	1325	418.25	
3	2	18	91.9	1418		459.88	
4	1	18	53.6			669.15	
5	2	18	80.6	1464		135.99	
6	1	18	78.3			296.25	
7	3	18	68	1738	1549	99.58	
8	2	18	76.4	1125		920.46	
9	2	18	70.7	1975		636.92	
10	2	18	51.5	1959		664.1	
11	2	18	85.9	1447		907.5	
12	2	18	91.4	1813		345.2	

Statistics 27 (ChirpCenter Frequency: 5281.2 MHz)

Trial #	Pulse	Chirp(MHz)	Pulse Width (µS)	Pulse 1-2 spacing(µS)	Pulse 2-3 spacing(µS)	Pulse Start(mS)	Detection (1:yes;0:no)
1	2	17	63.6	1570		579.701	1
2	3	17	91.6	1957	1434	467.611	
3	3	17	81.1	1993	1598	451.622	
4	3	17	90	1091	1877	405.603	
5	1	17	62.1			0.014	
6	2	17	76	1970		364.505	
7	1	17	95.1			251.596	
8	2	17	68.3	1533		345.017	
9	1	17	88.7			96.798	
10	2	17	78.9	1447		511.599	
11	2	17	77.7	1463		288.521	
12	1	17	66.5			191.312	
13	1	17	68.8			422.443	
14	2	17	92.8	1074		294.834	
15	1	17	77.3			161.405	
16	2	17	88.3	1325		185.816	
17	1	17	50.3			25.237	
18	1	17	92.2			83.158	
19	3	17	70.3	1162	1389	168.679	

Statistics 28 (ChirpCenter Frequency: 5284.8 MHz)

Trial #	Pulse	Chirp(MHz)	Pulse Width (µS)	Pulse 1-2 spacing(µS)	Pulse 2-3 spacing(µS)	Pulse Start(mS)	Detection (1:yes;0:no)
1	2	8	88.3	1523		260.114	1
2	2	8	83.1	1889		646.398	
3	2	8	90.4	1368		659.605	
4	2	8	74.3	1810		367.213	
5	2	8	82.3	1712		697.841	
6	3	8	81.6	1648	1894	29.798	
7	3	8	54.2	1833	1431	111.936	
8	1	8	69.6			219.654	
9	2	8	63.4	1899		59.111	
10	1	8	78.4			531.349	
11	2	8	85	1097		30.176	
12	1	8	70.8			553.104	
13	2	8	50.1	1255		86.852	
14	1	8	57.9			221.479	
15	3	8	66.8	1241	1822	358.147	
16	1	8	69.2			337.965	
17	2	8	89	1801		690.182	

Statistics 29 (ChirpCenter Frequency: 5280.4 MHz)

Trial #	Pulse	Chirp(MHz)	Pulse Width (µS)	Pulse 1-2 spacing(µS)	Pulse 2-3 spacing(µS)	Pulse Start(mS)	Detection (1:yes;0:no)
1	3	19	60.5	1371	1174	903.957	1
2	3	19	60.6	1756	1631	1059.231	
3	3	19	93.6	1828	1012	929.212	
4	3	19	75	1030	1288	854.603	
5	3	19	85.9	1964	1378	799.014	
6	2	19	82.8	1282		712.225	
7	2	19	98.9	1008		667.815	
8	3	19	92.6	1507	1479	717.896	
9	1	19	80.6			354.967	
10	2	19	79.2	1254		262.918	
11	2	19	61.4	1224		393.209	

Statistics 30 (ChirpCenter Frequency: 5283.6 MHz)

Trial #	Pulse	Chirp(MHz)	Pulse Width (µS)	Pulse 1-2 spacing(µS)	Pulse 2-3 spacing(µS)	Pulse Start(mS)	Detection (1:yes;0:no)
1	2	11	90.7	1412		105.494	1
2	1	11	73			509.9	
3	2	11	60.4	1486		585.41	
4	2	11	68.4	1420		282.56	
5	2	11	53.4	1890		701.2	
6	3	11	97.6	1851	1765	491.01	
7	2	11	56.3	1995		133.13	
8	1	11	91.2			313.95	
9	3	11	80	1185	1489	128.23	
10	1	11	71.5			632.34	
11	3	11	61	1499	1388	660.17	
12	2	11	73	1510		365.63	
13	3	11	62.5	1933	1187	195.37	
14	2	11	96	1508		695.3	
15	3	11	94.1	1062	1156	502.7	
16	3	11	79.4	1218	1980	75.7	

Radar Type 6 Statistical Performance

Trial #	Fc (MHz)	Pulse /Burst	Pulse Width (µS)	PRI (µs)	Detection (1:yes; 0:no)	Hopping Sequence (GHz)
1	5290	9	1	333	1	5.596, 5.481, 5.253, 5.530, 5.439, 5.550, 5.331, 5.335, 5.665, 5.723, 5.455, 5.595, 5.369, 5.326, 5.658, 5.539, 5.565, 5.490, 5.264, 5.685, 5.561, 5.537, 5.710, 5.586, 5.394, 5.587, 5.260, 5.309, 5.422, 5.368, 5.613, 5.403, 5.563, 5.334, 5.307, 5.496, 5.552, 5.707, 5.640, 5.484, 5.662, 5.562, 5.708, 5.345, 5.716, 5.360, 5.402, 5.608, 5.471, 5.600, 5.329, 5.391, 5.620, 5.463, 5.378, 5.374, 5.535, 5.284, 5.626, 5.703, 5.311, 5.680, 5.443, 5.293, 5.649, 5.487, 5.580, 5.525, 5.693, 5.663, 5.637, 5.485, 5.489, 5.355, 5.494, 5.321, 5.319, 5.532, 5.497, 5.251, 5.701, 5.371, 5.668, 5.502, 5.636, 5.450, 5.483, 5.694, 5.653, 5.672, 5.721, 5.554, 5.426, 5.615, 5.578, 5.298, 5.597, 5.364, 5.558, 5.696
2	5290	9	1	333	1	5.685, 5.456, 5.380, 5.621, 5.723, 5.306, 5.683, 5.561, 5.430, 5.358, 5.607, 5.277, 5.508, 5.562, 5.412, 5.669, 5.342, 5.314, 5.363, 5.515, 5.450, 5.625, 5.406, 5.610, 5.553, 5.420, 5.579, 5.648, 5.616, 5.466, 5.343, 5.594, 5.461, 5.340, 5.624, 5.637, 5.512, 5.496, 5.529, 5.468, 5.707, 5.254, 5.473, 5.639, 5.295, 5.549, 5.626, 5.448, 5.569, 5.260, 5.519, 5.521, 5.354, 5.524, 5.257, 5.267, 5.575, 5.671, 5.339, 5.395, 5.336, 5.325, 5.632, 5.705, 5.402, 5.526, 5.369, 5.255, 5.489, 5.578, 5.504, 5.411, 5.511, 5.316, 5.289, 5.465, 5.290, 5.481, 5.644, 5.623, 5.365, 5.373, 5.581, 5.650, 5.264, 5.536, 5.389, 5.273, 5.350, 5.679, 5.474, 5.513, 5.666, 5.499, 5.269, 5.446, 5.517, 5.716, 5.722, 5.330
3	5290	9	1	333	1	5.598, 5.689, 5.648, 5.473, 5.662, 5.412, 5.682, 5.266, 5.562, 5.323, 5.659, 5.329, 5.518, 5.611, 5.469, 5.404, 5.667, 5.385, 5.719, 5.687, 5.299, 5.644, 5.507, 5.310, 5.721, 5.437, 5.259, 5.690, 5.596, 5.268, 5.506, 5.642, 5.328, 5.282, 5.382, 5.250, 5.421, 5.538, 5.374, 5.646, 5.593, 5.529, 5.582, 5.590, 5.326, 5.516, 5.616, 5.515, 5.645, 5.670, 5.674, 5.653, 5.276, 5.678, 5.393, 5.723, 5.351, 5.278, 5.273, 5.291, 5.267, 5.519, 5.474, 5.307, 5.702, 5.612, 5.383, 5.510, 5.535, 5.425, 5.573, 5.288, 5.275, 5.446, 5.309, 5.621, 5.699, 5.550, 5.524, 5.380, 5.520, 5.530, 5.409, 5.685, 5.713, 5.280, 5.413, 5.549, 5.556, 5.395, 5.459, 5.368, 5.497, 5.481, 5.252, 5.683, 5.654, 5.696, 5.478, 5.439
4	5290	9	1	333	1	5.339, 5.427, 5.316, 5.322, 5.445, 5.479, 5.667, 5.426, 5.252, 5.588, 5.697, 5.659,

						5.599, 5.475, 5.630, 5.628, 5.498, 5.387, 5.466, 5.405, 5.629, 5.377, 5.607, 5.568, 5.320, 5.603, 5.352, 5.550, 5.342, 5.474, 5.261, 5.689, 5.297, 5.717, 5.670, 5.718, 5.581, 5.644, 5.425, 5.530, 5.558, 5.600, 5.448, 5.345, 5.293, 5.529, 5.308, 5.371, 5.569, 5.513, 5.641, 5.702, 5.577, 5.344, 5.545, 5.713, 5.415, 5.432, 5.682, 5.655, 5.285, 5.464, 5.542, 5.457, 5.337, 5.563, 5.260, 5.251, 5.575, 5.476, 5.375, 5.536, 5.416, 5.695, 5.304, 5.680, 5.532, 5.366, 5.453, 5.509, 5.552, 5.408, 5.343, 5.348, 5.580, 5.318, 5.681, 5.497, 5.720, 5.555, 5.678, 5.384, 5.484, 5.357, 5.446, 5.686, 5.414, 5.421, 5.531, 5.587
5	5290	9	1	333	1	5.401, 5.438, 5.505, 5.329, 5.393, 5.337, 5.656, 5.259, 5.508, 5.442, 5.606, 5.492, 5.428, 5.716, 5.301, 5.489, 5.432, 5.386, 5.306, 5.448, 5.355, 5.610, 5.545, 5.587, 5.532, 5.588, 5.705, 5.255, 5.435, 5.357, 5.530, 5.326, 5.582, 5.543, 5.485, 5.350, 5.459, 5.404, 5.472, 5.557, 5.312, 5.458, 5.302, 5.387, 5.403, 5.400, 5.265, 5.276, 5.271, 5.535, 5.342, 5.392, 5.483, 5.602, 5.263, 5.570, 5.328, 5.375, 5.455, 5.569, 5.429, 5.600, 5.254, 5.320, 5.413, 5.604, 5.378, 5.714, 5.685, 5.652, 5.572, 5.266, 5.547, 5.501, 5.349, 5.579, 5.274, 5.477, 5.436, 5.377, 5.323, 5.424, 5.675, 5.703, 5.670, 5.558, 5.431, 5.504, 5.490, 5.257, 5.518, 5.317, 5.468, 5.332, 5.427, 5.416, 5.632, 5.421, 5.405, 5.336
6	5290	9	1	333	1	5.280, 5.571, 5.356, 5.610, 5.514, 5.363, 5.636, 5.259, 5.494, 5.521, 5.425, 5.681, 5.276, 5.282, 5.533, 5.307, 5.270, 5.370, 5.637, 5.656, 5.575, 5.391, 5.420, 5.680, 5.311, 5.603, 5.364, 5.489, 5.676, 5.532, 5.376, 5.393, 5.482, 5.602, 5.491, 5.390, 5.467, 5.572, 5.350, 5.300, 5.651, 5.385, 5.433, 5.616, 5.506, 5.555, 5.643, 5.279, 5.502, 5.541, 5.394, 5.330, 5.596, 5.380, 5.479, 5.538, 5.388, 5.458, 5.702, 5.644, 5.442, 5.685, 5.718, 5.666, 5.600, 5.328, 5.421, 5.310, 5.355, 5.487, 5.281, 5.372, 5.296, 5.349, 5.536, 5.664, 5.430, 5.358, 5.539, 5.551, 5.646, 5.402, 5.583, 5.516, 5.622, 5.476, 5.698, 5.660, 5.318, 5.584, 5.412, 5.333, 5.480, 5.579, 5.367, 5.589, 5.361, 5.658, 5.461, 5.558
7	5290	9	1	333	1	5.427, 5.443, 5.674, 5.534, 5.537, 5.290, 5.432, 5.453, 5.325, 5.327, 5.379, 5.285, 5.587, 5.516, 5.316, 5.254, 5.650, 5.641, 5.305, 5.330, 5.353, 5.382, 5.482, 5.639, 5.527, 5.720, 5.550, 5.467, 5.300, 5.433, 5.665, 5.320, 5.490, 5.595, 5.468, 5.545, 5.406, 5.524, 5.698, 5.592, 5.478, 5.706, 5.309, 5.417, 5.476, 5.657, 5.459, 5.687, 5.563, 5.271, 5.583, 5.289, 5.385, 5.556, 5.298, 5.388, 5.568, 5.458, 5.460, 5.387, 5.634, 5.552, 5.608, 5.643, 5.384, 5.409,

						5.348, 5.301, 5.486, 5.304, 5.562, 5.620, 5.561, 5.383, 5.415, 5.293, 5.369, 5.542, 5.544, 5.603, 5.402, 5.644, 5.536, 5.446, 5.690, 5.412, 5.399, 5.616, 5.613, 5.599, 5.642, 5.463, 5.250, 5.512, 5.707, 5.288, 5.547, 5.410, 5.253, 5.278
8	5290	9	1	333	1	5.452, 5.419, 5.681, 5.350, 5.649, 5.363, 5.455, 5.396, 5.369, 5.711, 5.345, 5.373, 5.484, 5.685, 5.625, 5.621, 5.284, 5.579, 5.720, 5.412, 5.535, 5.383, 5.564, 5.593, 5.708, 5.339, 5.347, 5.534, 5.683, 5.271, 5.585, 5.595, 5.565, 5.610, 5.377, 5.334, 5.552, 5.633, 5.619, 5.395, 5.571, 5.332, 5.428, 5.461, 5.510, 5.268, 5.380, 5.480, 5.588, 5.590, 5.717, 5.280, 5.644, 5.346, 5.357, 5.724, 5.591, 5.641, 5.660, 5.550, 5.680, 5.476, 5.342, 5.584, 5.642, 5.530, 5.330, 5.618, 5.529, 5.405, 5.698, 5.385, 5.496, 5.298, 5.408, 5.622, 5.470, 5.518, 5.662, 5.420, 5.658, 5.691, 5.306, 5.407, 5.502, 5.475, 5.517, 5.483, 5.513, 5.320, 5.520, 5.329, 5.569, 5.359, 5.512, 5.682, 5.436, 5.252, 5.527, 5.304
9	5290	9	1	333	1	5.634, 5.679, 5.627, 5.403, 5.336, 5.436, 5.702, 5.429, 5.339, 5.266, 5.437, 5.720, 5.587, 5.256, 5.535, 5.280, 5.694, 5.524, 5.716, 5.308, 5.285, 5.428, 5.539, 5.439, 5.661, 5.604, 5.697, 5.350, 5.613, 5.556, 5.380, 5.581, 5.529, 5.534, 5.618, 5.614, 5.678, 5.426, 5.617, 5.427, 5.302, 5.491, 5.344, 5.478, 5.262, 5.633, 5.700, 5.383, 5.332, 5.298, 5.682, 5.382, 5.567, 5.519, 5.621, 5.688, 5.254, 5.375, 5.279, 5.473, 5.660, 5.483, 5.687, 5.411, 5.293, 5.625, 5.385, 5.715, 5.351, 5.253, 5.603, 5.363, 5.642, 5.517, 5.624, 5.447, 5.402, 5.424, 5.722, 5.630, 5.400, 5.709, 5.372, 5.260, 5.395, 5.546, 5.706, 5.667, 5.347, 5.284, 5.387, 5.462, 5.307, 5.590, 5.606, 5.561, 5.251, 5.656, 5.376, 5.510
10	5290	9	1	333	1	5.422, 5.335, 5.507, 5.371, 5.611, 5.547, 5.693, 5.620, 5.255, 5.557, 5.670, 5.259, 5.269, 5.337, 5.703, 5.480, 5.536, 5.327, 5.637, 5.722, 5.316, 5.287, 5.635, 5.442, 5.364, 5.432, 5.286, 5.558, 5.697, 5.723, 5.681, 5.533, 5.680, 5.308, 5.478, 5.542, 5.563, 5.559, 5.336, 5.252, 5.666, 5.513, 5.489, 5.469, 5.708, 5.473, 5.561, 5.673, 5.627, 5.593, 5.421, 5.318, 5.436, 5.365, 5.285, 5.319, 5.509, 5.532, 5.419, 5.332, 5.482, 5.687, 5.410, 5.490, 5.312, 5.617, 5.393, 5.321, 5.706, 5.383, 5.678, 5.695, 5.261, 5.488, 5.265, 5.640, 5.288, 5.628, 5.263, 5.307, 5.389, 5.277, 5.324, 5.662, 5.320, 5.683, 5.439, 5.668, 5.685, 5.426, 5.689, 5.385, 5.322, 5.264, 5.369, 5.601, 5.630, 5.325, 5.294, 5.672
11	5290	9	1	333	1	5.713, 5.548, 5.297, 5.362, 5.643, 5.452, 5.490, 5.391, 5.664, 5.335, 5.404, 5.500, 5.327, 5.666, 5.600, 5.569, 5.310, 5.367,

						5.488, 5.379, 5.524, 5.469, 5.410, 5.642, 5.277, 5.586, 5.463, 5.442, 5.471, 5.364, 5.359, 5.378, 5.501, 5.282, 5.604, 5.345, 5.615, 5.568, 5.303, 5.251, 5.328, 5.692, 5.293, 5.320, 5.706, 5.253, 5.418, 5.295, 5.581, 5.543, 5.721, 5.413, 5.330, 5.515, 5.266, 5.407, 5.383, 5.430, 5.419, 5.453, 5.603, 5.441, 5.269, 5.399, 5.460, 5.275, 5.651, 5.530, 5.402, 5.523, 5.574, 5.340, 5.510, 5.347, 5.261, 5.305, 5.662, 5.512, 5.257, 5.710, 5.387, 5.445, 5.595, 5.300, 5.653, 5.611, 5.357, 5.385, 5.317, 5.464, 5.674, 5.318, 5.623, 5.551, 5.443, 5.482, 5.502, 5.480, 5.541, 5.593
12	5290	9	1	333	1	5.391, 5.570, 5.593, 5.493, 5.523, 5.575, 5.329, 5.381, 5.346, 5.587, 5.279, 5.644, 5.627, 5.454, 5.565, 5.287, 5.544, 5.392, 5.372, 5.339, 5.530, 5.347, 5.457, 5.657, 5.312, 5.412, 5.603, 5.539, 5.590, 5.718, 5.616, 5.301, 5.397, 5.303, 5.340, 5.500, 5.261, 5.309, 5.621, 5.562, 5.650, 5.582, 5.659, 5.585, 5.655, 5.674, 5.519, 5.378, 5.449, 5.260, 5.604, 5.418, 5.262, 5.532, 5.557, 5.406, 5.462, 5.440, 5.641, 5.327, 5.509, 5.259, 5.419, 5.580, 5.656, 5.693, 5.551, 5.511, 5.589, 5.256, 5.624, 5.475, 5.350, 5.720, 5.403, 5.618, 5.325, 5.395, 5.579, 5.600, 5.448, 5.456, 5.545, 5.423, 5.524, 5.370, 5.658, 5.510, 5.345, 5.328, 5.608, 5.319, 5.690, 5.554, 5.413, 5.348, 5.414, 5.316, 5.636, 5.401
13	5290	9	1	333	1	5.329, 5.553, 5.713, 5.443, 5.703, 5.442, 5.360, 5.704, 5.685, 5.370, 5.414, 5.252, 5.453, 5.544, 5.649, 5.523, 5.436, 5.401, 5.515, 5.345, 5.402, 5.541, 5.639, 5.605, 5.504, 5.389, 5.689, 5.457, 5.527, 5.276, 5.599, 5.382, 5.411, 5.525, 5.262, 5.573, 5.290, 5.465, 5.304, 5.537, 5.636, 5.529, 5.317, 5.616, 5.265, 5.369, 5.302, 5.633, 5.591, 5.716, 5.624, 5.645, 5.675, 5.381, 5.680, 5.397, 5.334, 5.279, 5.287, 5.594, 5.652, 5.372, 5.542, 5.417, 5.471, 5.684, 5.561, 5.575, 5.434, 5.479, 5.602, 5.379, 5.321, 5.396, 5.611, 5.387, 5.428, 5.666, 5.463, 5.491, 5.551, 5.395, 5.664, 5.286, 5.254, 5.629, 5.564, 5.429, 5.301, 5.327, 5.342, 5.697, 5.268, 5.468, 5.534, 5.679, 5.393, 5.326, 5.572, 5.261
14	5290	9	1	333	1	5.317, 5.541, 5.392, 5.700, 5.640, 5.695, 5.373, 5.416, 5.583, 5.428, 5.517, 5.551, 5.423, 5.288, 5.332, 5.267, 5.558, 5.414, 5.311, 5.580, 5.711, 5.595, 5.623, 5.372, 5.486, 5.295, 5.692, 5.250, 5.603, 5.514, 5.543, 5.722, 5.330, 5.424, 5.464, 5.618, 5.523, 5.308, 5.545, 5.715, 5.710, 5.379, 5.588, 5.258, 5.381, 5.635, 5.328, 5.296, 5.550, 5.477, 5.321, 5.305, 5.465, 5.385, 5.491, 5.672, 5.587, 5.342, 5.260, 5.252, 5.693, 5.270, 5.576, 5.638, 5.337, 5.577, 5.466, 5.669, 5.327, 5.405, 5.470, 5.585,

						5.610, 5.469, 5.712, 5.643, 5.457, 5.496, 5.438, 5.639, 5.320, 5.432, 5.426, 5.384, 5.297, 5.589, 5.542, 5.445, 5.661, 5.315, 5.402, 5.411, 5.673, 5.592, 5.531, 5.367, 5.261, 5.645, 5.637, 5.632
15	5290	9	1	333	1	5.373, 5.382, 5.606, 5.341, 5.352, 5.323, 5.391, 5.514, 5.557, 5.457, 5.681, 5.348, 5.539, 5.428, 5.714, 5.660, 5.264, 5.499, 5.502, 5.511, 5.668, 5.503, 5.345, 5.518, 5.455, 5.318, 5.289, 5.396, 5.375, 5.595, 5.290, 5.256, 5.650, 5.705, 5.426, 5.446, 5.611, 5.593, 5.680, 5.293, 5.374, 5.406, 5.702, 5.423, 5.327, 5.419, 5.431, 5.392, 5.347, 5.598, 5.267, 5.251, 5.301, 5.558, 5.350, 5.538, 5.678, 5.649, 5.405, 5.469, 5.554, 5.710, 5.664, 5.300, 5.666, 5.358, 5.275, 5.588, 5.531, 5.500, 5.717, 5.590, 5.432, 5.543, 5.690, 5.614, 5.552, 5.416, 5.326, 5.279, 5.384, 5.616, 5.693, 5.600, 5.654, 5.561, 5.393, 5.462, 5.308, 5.353, 5.349, 5.417, 5.255, 5.459, 5.283, 5.414, 5.291, 5.450, 5.700, 5.704
16	5290	9	1	333	1	5.683, 5.540, 5.520, 5.480, 5.533, 5.566, 5.604, 5.300, 5.587, 5.500, 5.555, 5.489, 5.329, 5.456, 5.473, 5.472, 5.548, 5.482, 5.334, 5.277, 5.253, 5.608, 5.395, 5.562, 5.565, 5.424, 5.371, 5.462, 5.673, 5.702, 5.490, 5.675, 5.663, 5.350, 5.634, 5.712, 5.452, 5.336, 5.298, 5.351, 5.645, 5.708, 5.359, 5.640, 5.685, 5.284, 5.599, 5.508, 5.286, 5.275, 5.639, 5.694, 5.649, 5.394, 5.326, 5.719, 5.370, 5.543, 5.617, 5.360, 5.564, 5.680, 5.271, 5.321, 5.667, 5.658, 5.251, 5.718, 5.654, 5.547, 5.716, 5.386, 5.322, 5.636, 5.651, 5.289, 5.455, 5.294, 5.257, 5.354, 5.355, 5.717, 5.281, 5.517, 5.478, 5.690, 5.516, 5.301, 5.513, 5.681, 5.632, 5.523, 5.492, 5.255, 5.307, 5.552, 5.288, 5.678, 5.557, 5.311
17	5290	9	1	333	1	5.636, 5.710, 5.538, 5.428, 5.517, 5.364, 5.698, 5.432, 5.531, 5.582, 5.285, 5.383, 5.294, 5.430, 5.510, 5.377, 5.282, 5.507, 5.257, 5.440, 5.397, 5.288, 5.424, 5.425, 5.549, 5.709, 5.609, 5.573, 5.596, 5.692, 5.367, 5.688, 5.681, 5.634, 5.718, 5.559, 5.272, 5.392, 5.479, 5.555, 5.292, 5.382, 5.444, 5.332, 5.279, 5.620, 5.303, 5.569, 5.481, 5.401, 5.261, 5.307, 5.564, 5.423, 5.372, 5.316, 5.682, 5.410, 5.722, 5.474, 5.291, 5.309, 5.666, 5.312, 5.431, 5.456, 5.614, 5.580, 5.317, 5.338, 5.340, 5.271, 5.701, 5.467, 5.497, 5.570, 5.664, 5.676, 5.323, 5.650, 5.301, 5.702, 5.269, 5.575, 5.256, 5.355, 5.647, 5.274, 5.695, 5.537, 5.622, 5.669, 5.601, 5.365, 5.328, 5.297, 5.553, 5.447, 5.679, 5.674
18	5290	9	1	333	1	5.378, 5.353, 5.648, 5.635, 5.683, 5.326, 5.470, 5.581, 5.561, 5.396, 5.708, 5.574, 5.421, 5.568, 5.526, 5.632, 5.412, 5.672, 5.297, 5.667, 5.473, 5.638, 5.356, 5.296,

						5.276, 5.436, 5.413, 5.403, 5.615, 5.582, 5.265, 5.660, 5.486, 5.346, 5.294, 5.542, 5.476, 5.379, 5.674, 5.371, 5.358, 5.634, 5.494, 5.433, 5.487, 5.408, 5.397, 5.361, 5.375, 5.679, 5.293, 5.585, 5.448, 5.689, 5.546, 5.649, 5.310, 5.325, 5.339, 5.572, 5.625, 5.399, 5.282, 5.268, 5.614, 5.707, 5.364, 5.686, 5.709, 5.659, 5.675, 5.680, 5.360, 5.657, 5.386, 5.398, 5.369, 5.584, 5.418, 5.622, 5.359, 5.366, 5.391, 5.324, 5.423, 5.714, 5.251, 5.522, 5.458, 5.548, 5.424, 5.607, 5.721, 5.335, 5.507, 5.597, 5.724, 5.500, 5.513, 5.670
19	5290	9	1	333	1	5.544, 5.542, 5.531, 5.518, 5.611, 5.319, 5.514, 5.331, 5.391, 5.515, 5.536, 5.642, 5.278, 5.635, 5.384, 5.346, 5.587, 5.602, 5.431, 5.541, 5.710, 5.400, 5.612, 5.722, 5.450, 5.685, 5.398, 5.600, 5.264, 5.256, 5.622, 5.506, 5.376, 5.477, 5.505, 5.698, 5.503, 5.388, 5.299, 5.373, 5.347, 5.257, 5.655, 5.440, 5.290, 5.652, 5.499, 5.357, 5.668, 5.624, 5.407, 5.369, 5.573, 5.468, 5.281, 5.270, 5.437, 5.603, 5.291, 5.352, 5.682, 5.473, 5.432, 5.665, 5.558, 5.661, 5.462, 5.306, 5.340, 5.580, 5.545, 5.677, 5.337, 5.274, 5.280, 5.678, 5.551, 5.315, 5.381, 5.393, 5.608, 5.424, 5.266, 5.680, 5.289, 5.362, 5.302, 5.521, 5.279, 5.720, 5.453, 5.687, 5.683, 5.345, 5.287, 5.350, 5.459, 5.377, 5.358, 5.650
20	5290	9	1	333	1	5.502, 5.408, 5.282, 5.322, 5.627, 5.659, 5.548, 5.304, 5.676, 5.418, 5.542, 5.490, 5.452, 5.454, 5.662, 5.476, 5.432, 5.503, 5.325, 5.411, 5.421, 5.545, 5.638, 5.353, 5.312, 5.506, 5.493, 5.647, 5.309, 5.350, 5.438, 5.296, 5.719, 5.632, 5.696, 5.256, 5.320, 5.286, 5.431, 5.565, 5.285, 5.478, 5.722, 5.428, 5.610, 5.539, 5.298, 5.651, 5.533, 5.344, 5.523, 5.311, 5.675, 5.276, 5.528, 5.485, 5.433, 5.474, 5.362, 5.457, 5.382, 5.579, 5.674, 5.637, 5.508, 5.564, 5.519, 5.512, 5.342, 5.552, 5.629, 5.372, 5.387, 5.314, 5.333, 5.718, 5.654, 5.524, 5.338, 5.687, 5.601, 5.413, 5.297, 5.514, 5.272, 5.393, 5.266, 5.701, 5.673, 5.577, 5.299, 5.267, 5.326, 5.423, 5.537, 5.302, 5.688, 5.336, 5.697, 5.510
21	5290	9	1	333	1	5.541, 5.460, 5.419, 5.259, 5.514, 5.299, 5.416, 5.405, 5.297, 5.340, 5.254, 5.658, 5.560, 5.296, 5.355, 5.553, 5.358, 5.278, 5.414, 5.721, 5.344, 5.579, 5.629, 5.582, 5.592, 5.347, 5.661, 5.688, 5.401, 5.294, 5.663, 5.266, 5.441, 5.643, 5.498, 5.439, 5.399, 5.335, 5.608, 5.279, 5.349, 5.319, 5.568, 5.448, 5.432, 5.359, 5.672, 5.339, 5.434, 5.404, 5.565, 5.552, 5.428, 5.548, 5.533, 5.554, 5.610, 5.624, 5.547, 5.269, 5.384, 5.708, 5.480, 5.379, 5.558, 5.697, 5.437, 5.589, 5.468, 5.660, 5.435, 5.481, 5.543, 5.584, 5.495, 5.271, 5.585, 5.493,

						5.364, 5.517, 5.472, 5.318, 5.420, 5.723, 5.564, 5.425, 5.639, 5.532, 5.510, 5.575, 5.353, 5.515, 5.373, 5.387, 5.713, 5.276, 5.292, 5.421, 5.655, 5.496
22	5290	9	1	333	1	5.428, 5.698, 5.573, 5.304, 5.334, 5.265, 5.575, 5.281, 5.295, 5.414, 5.300, 5.620, 5.706, 5.498, 5.715, 5.640, 5.631, 5.662, 5.611, 5.426, 5.667, 5.626, 5.495, 5.396, 5.510, 5.526, 5.660, 5.550, 5.508, 5.509, 5.412, 5.684, 5.564, 5.657, 5.562, 5.543, 5.597, 5.588, 5.653, 5.421, 5.632, 5.259, 5.463, 5.519, 5.375, 5.604, 5.593, 5.546, 5.299, 5.389, 5.599, 5.340, 5.617, 5.584, 5.459, 5.489, 5.666, 5.264, 5.478, 5.379, 5.719, 5.481, 5.441, 5.321, 5.650, 5.425, 5.376, 5.420, 5.557, 5.607, 5.395, 5.570, 5.286, 5.712, 5.255, 5.312, 5.303, 5.254, 5.274, 5.571, 5.548, 5.551, 5.585, 5.407, 5.645, 5.458, 5.717, 5.496, 5.394, 5.371, 5.252, 5.453, 5.302, 5.680, 5.354, 5.713, 5.686, 5.305, 5.374, 5.670
23	5290	9	1	333	1	5.281, 5.572, 5.514, 5.365, 5.336, 5.285, 5.337, 5.534, 5.540, 5.426, 5.260, 5.679, 5.323, 5.278, 5.468, 5.546, 5.477, 5.333, 5.518, 5.584, 5.722, 5.287, 5.475, 5.523, 5.561, 5.543, 5.290, 5.386, 5.338, 5.364, 5.486, 5.618, 5.678, 5.595, 5.596, 5.585, 5.718, 5.357, 5.448, 5.455, 5.416, 5.709, 5.452, 5.583, 5.436, 5.480, 5.532, 5.300, 5.441, 5.481, 5.619, 5.519, 5.409, 5.571, 5.360, 5.297, 5.425, 5.348, 5.286, 5.319, 5.638, 5.491, 5.446, 5.445, 5.341, 5.275, 5.511, 5.259, 5.504, 5.674, 5.550, 5.573, 5.332, 5.258, 5.627, 5.689, 5.268, 5.469, 5.520, 5.340, 5.647, 5.331, 5.563, 5.404, 5.693, 5.460, 5.399, 5.664, 5.695, 5.272, 5.552, 5.381, 5.630, 5.690, 5.366, 5.612, 5.625, 5.430, 5.434, 5.422
24	5290	9	1	333	1	5.331, 5.295, 5.627, 5.670, 5.712, 5.471, 5.309, 5.301, 5.404, 5.512, 5.321, 5.623, 5.681, 5.600, 5.695, 5.519, 5.668, 5.344, 5.382, 5.684, 5.389, 5.496, 5.710, 5.318, 5.253, 5.334, 5.316, 5.461, 5.304, 5.277, 5.427, 5.693, 5.653, 5.412, 5.590, 5.401, 5.323, 5.464, 5.355, 5.463, 5.526, 5.640, 5.361, 5.709, 5.280, 5.502, 5.255, 5.477, 5.485, 5.422, 5.632, 5.602, 5.444, 5.289, 5.441, 5.520, 5.594, 5.482, 5.688, 5.583, 5.452, 5.330, 5.391, 5.439, 5.674, 5.467, 5.258, 5.348, 5.723, 5.649, 5.371, 5.585, 5.633, 5.565, 5.651, 5.539, 5.553, 5.409, 5.432, 5.251, 5.297, 5.359, 5.521, 5.362, 5.491, 5.542, 5.655, 5.254, 5.486, 5.541, 5.582, 5.500, 5.281, 5.349, 5.510, 5.722, 5.534, 5.378, 5.689, 5.532
25	5290	9	1	333	1	5.491, 5.380, 5.634, 5.686, 5.269, 5.678, 5.252, 5.623, 5.387, 5.283, 5.544, 5.614, 5.638, 5.508, 5.324, 5.629, 5.427, 5.680, 5.418, 5.459, 5.515, 5.406, 5.463, 5.314, 5.367, 5.333, 5.345, 5.561, 5.532, 5.416,

						5.692, 5.596, 5.576, 5.586, 5.545, 5.468, 5.359, 5.363, 5.388, 5.322, 5.573, 5.449, 5.278, 5.657, 5.286, 5.496, 5.298, 5.397, 5.327, 5.279, 5.646, 5.625, 5.357, 5.505, 5.600, 5.658, 5.350, 5.610, 5.316, 5.386, 5.294, 5.577, 5.696, 5.667, 5.376, 5.493, 5.535, 5.317, 5.369, 5.411, 5.689, 5.425, 5.299, 5.693, 5.454, 5.719, 5.613, 5.540, 5.472, 5.568, 5.394, 5.487, 5.716, 5.446, 5.628, 5.448, 5.705, 5.349, 5.713, 5.536, 5.606, 5.648, 5.590, 5.293, 5.285, 5.398, 5.602, 5.326, 5.432, 5.650
26	5290	9	1	333	1	5.358, 5.506, 5.382, 5.288, 5.640, 5.474, 5.672, 5.407, 5.394, 5.378, 5.616, 5.290, 5.720, 5.623, 5.373, 5.302, 5.351, 5.650, 5.479, 5.356, 5.419, 5.434, 5.274, 5.602, 5.586, 5.273, 5.581, 5.420, 5.465, 5.633, 5.363, 5.342, 5.494, 5.437, 5.659, 5.405, 5.607, 5.343, 5.254, 5.410, 5.387, 5.269, 5.486, 5.337, 5.692, 5.258, 5.557, 5.629, 5.680, 5.597, 5.390, 5.576, 5.491, 5.321, 5.441, 5.384, 5.723, 5.439, 5.251, 5.466, 5.664, 5.275, 5.262, 5.634, 5.721, 5.590, 5.282, 5.375, 5.595, 5.409, 5.493, 5.483, 5.688, 5.301, 5.704, 5.655, 5.687, 5.477, 5.304, 5.701, 5.578, 5.324, 5.588, 5.445, 5.564, 5.599, 5.440, 5.292, 5.671, 5.621, 5.322, 5.637, 5.335, 5.340, 5.572, 5.442, 5.436, 5.619, 5.334, 5.690
27	5290	9	1	333	1	5.635, 5.461, 5.468, 5.479, 5.486, 5.401, 5.342, 5.686, 5.398, 5.697, 5.357, 5.613, 5.721, 5.580, 5.577, 5.581, 5.674, 5.611, 5.406, 5.445, 5.555, 5.550, 5.549, 5.497, 5.309, 5.448, 5.345, 5.382, 5.689, 5.404, 5.438, 5.480, 5.590, 5.356, 5.372, 5.619, 5.623, 5.326, 5.475, 5.396, 5.703, 5.275, 5.494, 5.618, 5.513, 5.685, 5.411, 5.523, 5.254, 5.551, 5.430, 5.253, 5.652, 5.322, 5.464, 5.669, 5.440, 5.289, 5.595, 5.324, 5.687, 5.651, 5.316, 5.298, 5.453, 5.409, 5.573, 5.709, 5.375, 5.353, 5.484, 5.576, 5.524, 5.644, 5.584, 5.290, 5.616, 5.264, 5.312, 5.558, 5.416, 5.681, 5.624, 5.575, 5.636, 5.711, 5.553, 5.470, 5.499, 5.495, 5.333, 5.360, 5.371, 5.348, 5.482, 5.594, 5.370, 5.282, 5.441, 5.682
28	5290	9	1	333	1	5.359, 5.471, 5.687, 5.279, 5.524, 5.672, 5.669, 5.511, 5.565, 5.513, 5.625, 5.341, 5.648, 5.491, 5.493, 5.528, 5.426, 5.670, 5.401, 5.658, 5.380, 5.351, 5.677, 5.559, 5.404, 5.664, 5.358, 5.298, 5.370, 5.326, 5.544, 5.656, 5.393, 5.282, 5.413, 5.496, 5.555, 5.411, 5.469, 5.435, 5.522, 5.596, 5.665, 5.290, 5.702, 5.386, 5.547, 5.288, 5.269, 5.577, 5.317, 5.538, 5.379, 5.718, 5.455, 5.536, 5.630, 5.613, 5.553, 5.453, 5.569, 5.722, 5.521, 5.597, 5.373, 5.459, 5.615, 5.545, 5.619, 5.353, 5.476, 5.602, 5.497, 5.508, 5.281, 5.609, 5.364, 5.633, 5.554, 5.463, 5.449, 5.724, 5.560, 5.307,

						5.439, 5.424, 5.698, 5.504, 5.502, 5.552, 5.708, 5.534, 5.526, 5.296, 5.715, 5.324, 5.437, 5.305, 5.661, 5.583
29	5290	9	1	333	1	5.420, 5.388, 5.449, 5.540, 5.409, 5.251, 5.424, 5.521, 5.395, 5.276, 5.362, 5.559, 5.494, 5.299, 5.560, 5.285, 5.423, 5.258, 5.399, 5.531, 5.284, 5.495, 5.679, 5.591, 5.720, 5.707, 5.265, 5.528, 5.342, 5.520, 5.693, 5.302, 5.463, 5.473, 5.586, 5.407, 5.433, 5.669, 5.321, 5.612, 5.310, 5.419, 5.514, 5.477, 5.456, 5.326, 5.666, 5.405, 5.689, 5.674, 5.457, 5.704, 5.627, 5.280, 5.374, 5.272, 5.400, 5.529, 5.412, 5.351, 5.609, 5.582, 5.361, 5.512, 5.723, 5.654, 5.676, 5.672, 5.642, 5.435, 5.270, 5.638, 5.381, 5.523, 5.274, 5.519, 5.444, 5.671, 5.445, 5.429, 5.290, 5.480, 5.541, 5.490, 5.446, 5.478, 5.428, 5.682, 5.364, 5.458, 5.461, 5.619, 5.282, 5.425, 5.291, 5.471, 5.292, 5.625, 5.427, 5.370
30	5290	9	1	333	1	5.317, 5.394, 5.303, 5.715, 5.356, 5.533, 5.698, 5.658, 5.301, 5.722, 5.271, 5.297, 5.395, 5.418, 5.375, 5.654, 5.502, 5.531, 5.530, 5.458, 5.252, 5.415, 5.687, 5.493, 5.349, 5.328, 5.536, 5.576, 5.352, 5.588, 5.562, 5.685, 5.509, 5.308, 5.287, 5.407, 5.400, 5.387, 5.300, 5.444, 5.705, 5.603, 5.459, 5.481, 5.258, 5.524, 5.256, 5.519, 5.525, 5.461, 5.539, 5.532, 5.571, 5.504, 5.399, 5.257, 5.344, 5.573, 5.315, 5.681, 5.478, 5.412, 5.561, 5.676, 5.706, 5.267, 5.402, 5.413, 5.717, 5.566, 5.323, 5.625, 5.697, 5.306, 5.578, 5.384, 5.537, 5.261, 5.659, 5.707, 5.550, 5.630, 5.639, 5.579, 5.633, 5.474, 5.577, 5.526, 5.641, 5.346, 5.720, 5.401, 5.617, 5.438, 5.529, 5.611, 5.629, 5.359, 5.483, 5.713

5470-5725MHz, 20MHz Bandwidth

Radar SignalType	Waveform/Trial Number	Detection (%)	Limit (%)	Pass/Fail
Type 1A	15	100 %	60%	Pass
Type 1B	15	100%		
Type 2	30	100 %	60%	Pass
Type 3	30	100 %	60%	Pass
Type 4	30	100 %	60%	Pass
Aggregate (Type1 to 4)	120	100 %	80%	Pass
Type 5	28	93%	80%	Pass
Type 6	30	100 %	70%	Pass

Please refer to the following statistical tables:

Radar Type 1A Statistical Performance

Trial #	Fc (MHz)	Pulse/Burst	Pulse Width (μS)	PRI (μs)	Detection (1:yes; 0:no)
1	5500	81	1	658	1
2	5500	68	1	778	1
3	5500	92	1	578	1
4	5500	61	1	878	1
5	5500	67	1	798	1
6	5500	76	1	698	1
7	5500	57	1	938	1
8	5500	63	1	838	1
9	5500	62	1	858	1
10	5500	78	1	678	1
11	5500	70	1	758	1
12	5500	59	1	898	1
13	5500	83	1	638	1
14	5500	18	1	3066	1
15	5500	95	1	558	1
Detection Percentage: 100 % (>60%)					

Radar Type 1B Statistical Performance

Trial #	Fc (MHz)	Pulse/Burst	Pulse Width (μS)	PRI (μs)	Detection (1:yes; 0:no)
1	5500	24	1	2207	1
2	5500	68	1	786	1
3	5500	20	1	2736	1
4	5500	22	1	2501	1
5	5500	26	1	2099	1
6	5500	22	1	2491	1
7	5500	29	1	1832	1
8	5500	25	1	2149	1
9	5500	79	1	673	1
10	5500	37	1	1441	1
11	5500	22	1	2486	1
12	5500	24	1	2221	1
13	5500	44	1	1220	1
14	5500	46	1	1156	1
15	5500	40	1	1350	1
Detection Percentage: 100 % (>60%)					

Radar Type 2 Statistical Performance

Trial #	Fc (MHz)	Pulse/Burst	Pulse Width (μS)	PRI (μs)	Detection (1:yes; 0:no)
1	5500	26	2.2	221	1
2	5500	25	1.6	161	1
3	5500	24	3.9	230	1
4	5500	24	1.4	204	1
5	5500	27	4.9	175	1
6	5500	29	3.8	173	1
7	5500	24	3.2	209	1
8	5500	29	1.8	171	1
9	5500	28	2.1	204	1
10	5500	29	2.6	156	1
11	5500	29	1.6	221	1
12	5500	29	2.1	192	1
13	5500	25	4.9	196	1
14	5500	24	2.8	228	1
15	5500	27	2.9	209	1
16	5500	23	1.4	224	1
17	5500	25	1.5	225	1
18	5500	26	3	173	1
19	5500	27	5	198	1
20	5500	27	2.4	227	1
21	5500	24	3.5	170	1
22	5500	23	1	150	1
23	5500	25	1.2	151	1
24	5500	25	1.5	165	1
25	5500	24	3.6	177	1
26	5500	29	2.5	185	1
27	5500	28	3.1	172	1
28	5500	29	4.9	221	1
29	5500	23	1.2	198	1
30	5500	29	1.6	192	1
Detection Percentage: 100 % (>60%)					

Radar Type 3 Statistical Performance

Trial #	Fc (MHz)	Pulse/Burst	Pulse Width (μS)	PRI (μs)	Detection (1:yes; 0:no)
1	5500	17	7	420	1
2	5500	17	9.4	315	1
3	5500	16	8	251	1
4	5500	17	7.2	246	1
5	5500	18	6.5	207	1
6	5500	17	8.3	339	1
7	5500	17	6.9	297	1
8	5500	18	7.2	436	1
9	5500	17	7.7	376	1
10	5500	17	9.4	432	1
11	5500	16	6.4	387	1
12	5500	16	7.4	434	1
13	5500	17	6	271	1
14	5500	17	8	301	1
15	5500	16	6.7	491	1
16	5500	18	6.1	366	1
17	5500	17	9.4	354	1
18	5500	17	6.8	443	1
19	5500	17	9	212	1
20	5500	17	9.5	231	1
21	5500	17	7.2	431	1
22	5500	18	9.2	351	1
23	5500	16	7.9	211	1
24	5500	16	6.6	309	1
25	5500	17	8.5	219	1
26	5500	17	9.4	494	1
27	5500	18	7.8	378	1
28	5500	18	7.1	267	1
29	5500	17	8.7	486	1
30	5500	17	6.8	279	1
Detection Percentage: 100 % (>60%)					

Radar Type 4 Statistical Performance

Trial #	Fc (MHz)	Pulse/Burst	Pulse Width (μS)	PRI (μs)	Detection (1:yes; 0:no)
1	5500	14	12.8	285	1
2	5500	14	13	437	1
3	5500	14	14	468	1
4	5500	13	11.6	407	1
5	5500	13	12.6	412	1
6	5500	15	16.4	410	1
7	5500	13	13.9	324	1
8	5500	15	13.8	317	1
9	5500	12	19.6	471	1
10	5500	15	15.6	220	1
11	5500	13	13.3	201	1
12	5500	14	12.6	251	1
13	5500	15	18.5	309	1
14	5500	14	12.8	241	1
15	5500	13	19.3	488	1
16	5500	13	14.3	400	1
17	5500	16	15.5	482	1
18	5500	14	13.1	498	1
19	5500	16	15.9	408	1
20	5500	16	12.7	401	1
21	5500	12	11	432	1
22	5500	13	14	412	1
23	5500	15	15.1	444	1
24	5500	14	18.8	231	1
25	5500	13	20	440	1
26	5500	15	14.7	428	1
27	5500	15	17.6	347	1
28	5500	16	16.8	343	1
29	5500	15	16.1	203	1
30	5500	13	19.1	420	1
Detection Percentage: 100 % (>60%)					

Radar Type 5 Statistical Performance

Statistics 1 (ChirpCenter Frequency: 5500 MHz)

Trial #	Pulse	Chirp(MHz)	Pulse Width (µS)	Pulse 1-2 spacing(µS)	Pulse 2-3 spacing(µS)	Pulse Start(mS)	Detection (1:yes;0:no)
1	3	10	63.2	1720	1982	459.841	1
2	2	10	79.2	1650		14.083	
3	2	10	60.4	1507		516.266	
4	3	10	95.1	1973	1351	707.659	
5	2	10	85.3	1633		485.332	
6	2	10	65.9	1841		371.505	
7	2	10	75.7	1719		215.558	
8	2	10	87.8	1094		271.572	
9	2	10	82.7	1009		649.655	
10	2	10	56.9	1753		173.828	
11	2	10	94.4	1628		653.191	
12	2	10	90.6	1023		592.854	
13	1	10	80.1			206.677	

Statistics 2 (ChirpCenter Frequency: 5500 MHz)

Trial #	Pulse	Chirp(MHz)	Pulse Width (µS)	Pulse 1-2 spacing(µS)	Pulse 2-3 spacing(µS)	Pulse Start(mS)	Detection (1:yes;0:no)
1	3	9	64.9	1706	1914	424.815	1
2	2	9	87.5	1875		376.675	
3	2	9	63.3	1617		407.03	
4	3	9	80.1	1889	1703	525.39	
5	2	9	57.1	1381		154.16	
6	1	9	94.5			533.44	
7	3	9	90.9	1917	1441	463.86	
8	2	9	57.3	1342		436.56	
9	2	9	85.7	1566		247.64	
10	1	9	73.8			291.03	
11	3	9	59	1684	1923	407.93	
12	1	9	55.7			180.69	
13	2	9	59.4	1325		70.35	
14	3	9	93.2	1697	1608	145.24	
15	2	9	73.2	1272		2.26	
16	1	9	71.5			579.24	
17	2	9	52.3	1800		55.57	
18	1	9	89.8			84.9	
19	3	9	85.7	1053	1377	396.9	
20	2	9	81.2	1413		267	

Statistics 3 (ChirpCenter Frequency: 5500 MHz)

Trial #	Pulse	Chirp(MHz)	Pulse Width (µS)	Pulse 1-2 spacing(µS)	Pulse 2-3 spacing(µS)	Pulse Start(mS)	Detection (1:yes;0:no)
1	2	14	63.7	1347		166.207	1
2	2	14	70.2	1972		509.93	
3	3	14	63.6	1710	1208	582.36	
4	3	14	92.6	1593	1068	652.07	
5	1	14	74			306.85	
6	3	14	53	1398	1484	212.15	
7	3	14	73.3	1330	1783	8.43	
8	1	14	67.6			504.45	
9	3	14	80.1	1338	1771	399.89	
10	3	14	67.5	1640	1748	496.23	
11	2	14	54.9	1471		117.44	
12	2	14	81.4	1460		221.82	
13	2	14	60.1	1864		450.18	
14	2	14	84.9	1679		620.7	
15	3	14	55.7	1208	1275	296.7	
16	2	14	75.3	1625		593.3	

Statistics 4 (ChirpCenter Frequency: 5500 MHz)

Trial #	Pulse	Chirp(MHz)	Pulse Width (µS)	Pulse 1-2 spacing(µS)	Pulse 2-3 spacing(µS)	Pulse Start(mS)	Detection (1:yes;0:no)
1	1	11	76.2			530.986	1
2	2	11	86.5	1161		537.298	
3	1	11	72.9			555.545	
4	1	11	54.2			1.533	
5	1	11	85.6			342.901	
6	2	11	97.7	1748		341.168	
7	3	11	66.4	1677	1905	142.836	
8	3	11	89.2	1305	1440	114.424	
9	3	11	71.4	1002	1104	333.821	
10	2	11	73.2	1132		229.739	
11	1	11	54.5			658.146	
12	3	11	70.8	1513	1183	91.614	
13	1	11	51.1			257.772	
14	1	11	84.3			392.469	
15	2	11	69	1533		500.847	
16	2	11	81.1	1672		103.565	
17	2	11	55.4	1941		160.282	

Statistics 5(ChirpCenter Frequency: 5500 MHz)

Trial #	Pulse	Chirp(MHz)	Pulse Width (µS)	Pulse 1-2 spacing(µS)	Pulse 2-3 spacing(µS)	Pulse Start(mS)	Detection (1:yes;0:no)
1	2	20	52.7	1333		667.599	1
2	3	20	67.2	1703	1652	456.648	
3	2	20	56.4	1027		221.945	
4	3	20	72.6	1861	1740	375.013	
5	2	20	92.7	1993		449.711	
6	1	20	64.4			526.018	
7	2	20	58.3	1271		71.436	
8	2	20	97.4	1305		16.674	
9	2	20	61.5	1096		633.731	
10	2	20	61.9	1941		330.299	
11	3	20	88.2	1955	1353	590.086	
12	1	20	71.3			639.694	
13	2	20	73.6	1801		513.302	
14	1	20	77.6			427.529	
15	1	20	74.4			312.547	
16	2	20	74.6	1069		458.565	
17	1	20	94.6			447.182	

Statistics 6 (ChirpCenter Frequency: 5500 MHz)

Trial #	Pulse	Chirp(MHz)	Pulse Width (µS)	Pulse 1-2 spacing(µS)	Pulse 2-3 spacing(µS)	Pulse Start(mS)	Detection (1:yes;0:no)
1	2	14	53.9	1502		15.225	1
2	2	14	52.4	1070		963.26	
3	2	14	97	1234		436.94	
4	3	14	64.3	1978	1771	957.44	
5	2	14	75.6	1066		413.19	
6	1	14	52.9			385.23	
7	1	14	71			888.27	
8	2	14	95.7	1634		162.09	
9	2	14	91.2	1241		146.15	
10	1	14	59.3			800.1	
11	2	14	68.5	1872		26.9	
12	2	14	64	1718		292.4	

Statistics 7(ChirpCenter Frequency: 5500 MHz)

Trial #	Pulse	Chirp(MHz)	Pulse Width (µS)	Pulse 1-2 spacing(µS)	Pulse 2-3 spacing(µS)	Pulse Start(mS)	Detection (1:yes;0:no)
1	2	10	58	1489		649.557	1
2	1	10	72.7			122.84	
3	2	10	69.9	1066		830.65	
4	2	10	88.5	1614		990.7	
5	2	10	80.9	1888		954.36	
6	2	10	87.5	1441		344.41	
7	2	10	54.2	1692		616.84	
8	2	10	62.7	1714		921.06	
9	2	10	66.8	1644		672.72	
10	1	10	81.5			95.29	
11	3	10	66.2	1571	1558	159.4	
12	2	10	89.2	1597		931.1	

Statistics 8 (ChirpCenter Frequency: 5500 MHz)

Trial #	Pulse	Chirp(MHz)	Pulse Width (µS)	Pulse 1-2 spacing(µS)	Pulse 2-3 spacing(µS)	Pulse Start(mS)	Detection (1:yes;0:no)
1	2	20	64.8	1119		457.112	1
2	2	20	96.7	1442		522.173	
3	2	20	74.8	1933		601.527	
4	3	20	99.8	1007	1259	298.39	
5	2	20	80.6	1934		257.033	
6	2	20	72.3	1854		25.767	
7	2	20	79.1	1994		71.35	
8	2	20	87.9	1161		405.533	
9	1	20	68.1			632.537	
10	2	20	74.4	1554		513.51	
11	2	20	91.9	1550		249.643	
12	2	20	97.8	1549		206.417	
13	2	20	64.1	1353		232.12	
14	2	20	51.5	1576		131.093	
15	3	20	63.8	1591	1755	23.907	
16	3	20	52.3	1071	1759	463.4	
17	1	20	94.8			335.533	
18	2	20	65.4	1580		78.367	

Statistics 9 (ChirpCenter Frequency: 5500 MHz)

Trial #	Pulse	Chirp(MHz)	Pulse Width (µS)	Pulse 1-2 spacing(µS)	Pulse 2-3 spacing(µS)	Pulse Start(mS)	Detection (1:yes;0:no)
1	2	20	54.2	1869		535.154	1
2	1	20	85.4			252.817	
3	3	20	61	1122	1732	239.933	
4	1	20	80.3			194.23	
5	1	20	58.1			246.957	
6	2	20	92.5	1922		936.273	
7	3	20	59.3	1206	1103	1314	
8	2	20	59.6	1322		901.067	
9	1	20	68.1			782.733	

Statistics 10 (ChirpCenter Frequency: 5500 MHz)

Trial #	Pulse	Chirp(MHz)	Pulse Width (µS)	Pulse 1-2 spacing(µS)	Pulse 2-3 spacing(µS)	Pulse Start(mS)	Detection (1:yes;0:no)
1	2	8	63.6	1338		989.19	1
2	2	8	82.3	1210		300.801	
3	2	8	55.7	1244		589.342	
4	2	8	91.1	1057		890.893	
5	2	8	97.6	1872		446.984	
6	2	8	56.7	1479		409.525	
7	2	8	67.3	1847		1071.275	
8	1	8	62.4			661.696	
9	2	8	73.7	1397		3.807	
10	1	8	63.8			632.018	
11	2	8	55.8	1094		502.809	

Statistics 11 (ChirpCenter Frequency: 5495.4 MHz)

Trial #	Pulse	Chirp(MHz)	Pulse Width (µS)	Pulse 1-2 spacing(µS)	Pulse 2-3 spacing(µS)	Pulse Start(mS)	Detection (1:yes;0:no)
1	3	11	66.3	1310	1794	1.258	1
2	2	11	88.3	1343		57.864	
3	1	11	51.5			116.41	
4	3	11	53.8	1586	1664	146.75	
5	2	11	57.7	1645		219.62	
6	3	11	85.8	1237	1287	318.58	
7	2	11	86.8	1140		352.51	
8	3	11	87.1	1196	1439	103.61	
9	2	11	93.3	1152		195.51	
10	3	11	55.2	1130	1794	171.57	
11	1	11	91.6			515.8	
12	2	11	66	1756		51.14	
13	3	11	62.5	1851	1327	620.6	
14	3	11	73.3	1501	1013	370	
15	2	11	70.1	1804		100.2	

Statistics 12 (ChirpCenter Frequency: 5493.4 MHz)

Trial #	Pulse	Chirp(MHz)	Pulse Width (µS)	Pulse 1-2 spacing(µS)	Pulse 2-3 spacing(µS)	Pulse Start(mS)	Detection (1:yes;0:no)
1	3	6	51.3	1303	1886	332.173	0
2	3	6	83.2	1296	1294	385.573	
3	2	6	74.4	1045		184.787	
4	2	6	70.1	1768		245.75	
5	2	6	55.1	1952		433.093	
6	3	6	90.2	1881	1496	498.717	
7	1	6	77.7			23.15	
8	3	6	90.6	1656	1042	118.313	
9	2	6	64.3	1798		33.477	
10	2	6	58.4	1106		243.32	
11	2	6	91.7	1458		278.043	
12	2	6	78.1	1688		22.527	
13	1	6	58.1			448.61	
14	2	6	97.1	1394		650.753	
15	2	6	78.5	1633		233.377	
16	1	6	59.1			498.9	
17	2	6	88.4	1374		639.833	
18	3	6	78.2	1938	1121	481.967	

Statistics 13 (ChirpCenter Frequency: 5497.8 MHz)

Trial #	Pulse	Chirp(MHz)	Pulse Width (µS)	Pulse 1-2 spacing(µS)	Pulse 2-3 spacing(µS)	Pulse Start(mS)	Detection (1:yes;0:no)
1	3	17	64.9	1630	1818	917.986	1
2	2	17	81.6	1563		340.12	
3	2	17	56.9	1848		702.68	
4	2	17	54.6	1656		279.23	
5	3	17	79	1695	1697	715.69	
6	1	17	71.9			83.04	
7	2	17	60	1906		456.49	
8	1	17	76.3			337.71	
9	2	17	74.9	1612		923.83	
10	2	17	52.8	1773		896.3	
11	1	17	79.1			64.3	
12	1	17	53.3			910.8	

Statistics 14 (ChirpCenter Frequency: 5493.8 MHz)

Trial #	Pulse	Chirp(MHz)	Pulse Width (µS)	Pulse 1-2 spacing(µS)	Pulse 2-3 spacing(µS)	Pulse Start(mS)	Detection (1:yes;0:no)
1	1	7	57.8			631.667	1
2	1	7	64.9			786.22	
3	2	7	50.6	1206		553.62	
4	3	7	93.1	1442	1340	787.1	
5	2	7	91.4	1518		706.39	
6	2	7	61.3	1687		501.26	
7	2	7	100	1150		536.15	
8	2	7	77.6	1968		247.64	
9	1	7	67			712.25	
10	1	7	82.9			355.95	
11	3	7	91.7	1596	1431	478.29	
12	3	7	70.9	1027	1151	397.35	
13	2	7	56.1	1499		47.86	
14	2	7	98.5	1293		329.4	
15	2	7	93.6	1155		543.5	

Statistics 15 (ChirpCenter Frequency: 5499 MHz)

Trial #	Pulse	Chirp(MHz)	Pulse Width (µS)	Pulse 1-2 spacing(µS)	Pulse 2-3 spacing(µS)	Pulse Start(mS)	Detection (1:yes;0:no)
1	3	20	90.6	1943	1280	472.72	1
2	1	20	88			292.324	
3	2	20	62.2	1243		503.025	
4	2	20	52.4	1996		450.123	
5	2	20	65.4	1286		425.681	
6	3	20	78.7	1725	1533	8.468	
7	2	20	86.9	1059		38.456	
8	2	20	68.3	1436		410.024	
9	1	20	55.5			423.551	
10	2	20	85.8	1509		458.099	
11	2	20	90.1	1459		155.896	
12	3	20	70.6	1204	1334	346.214	
13	3	20	60.4	1080	1463	112.362	
14	2	20	55.4	1140		541.999	
15	3	20	68.8	1067	1050	353.347	
16	1	20	58			630.365	
17	3	20	59.3	1159	1521	665.482	

Statistics 16 (ChirpCenter Frequency: 5495.4 MHz)

Trial #	Pulse	Chirp(MHz)	Pulse Width (µS)	Pulse 1-2 spacing(µS)	Pulse 2-3 spacing(µS)	Pulse Start(mS)	Detection (1:yes;0:no)
1	3	11	83.7	1757	1967	95.953	1
2	2	11	72.8	1185		160.651	
3	2	11	70.8	1903		389.005	
4	1	11	63.7			109.333	
5	1	11	96.6			473.441	
6	2	11	56.5	1825		675.488	
7	3	11	95	1262	1702	115.076	
8	1	11	99.3			303.224	
9	2	11	96	1147		531.911	
10	2	11	88.8	1475		15.199	
11	2	11	92.3	1347		523.796	
12	3	11	86.7	1583	1777	481.474	
13	3	11	82.5	1951	1533	224.232	
14	2	11	74.8	1581		455.389	
15	1	11	85.6			130.347	
16	3	11	75	1074	1152	482.065	
17	2	11	57.4	1173		396.482	

Statistics 17 (ChirpCenter Frequency: 5498.2 MHz)

Trial #	Pulse	Chirp(MHz)	Pulse Width (µS)	Pulse 1-2 spacing(µS)	Pulse 2-3 spacing(µS)	Pulse Start(mS)	Detection (1:yes;0:no)
1	3	18	88.6	1959	1689	279.877	0
2	2	18	81	1899		19.7	
3	2	18	71.3	1189		1119.58	
4	2	18	78.6	1431		738.86	
5	2	18	90.8	1350		750.77	
6	1	18	92.9			1296.34	
7	3	18	62.4	1879	1930	1367.2	
8	2	18	67.6	1870		1141.2	

Statistics 18 (ChirpCenter Frequency: 5494.2 MHz)

Trial #	Pulse	Chirp(MHz)	Pulse Width (µS)	Pulse 1-2 spacing(µS)	Pulse 2-3 spacing(µS)	Pulse Start(mS)	Detection (1:yes;0:no)
1	2	8	57	1346		437.582	1
2	1	8	53.5			357.637	
3	3	8	68.9	1098	1595	199.704	
4	3	8	79.7	1531	1243	135.201	
5	2	8	84	1543		391.439	
6	3	8	73.2	1457	1640	7.706	
7	3	8	62.8	1119	1381	833.193	
8	2	8	96.2	1870		436.64	
9	2	8	56.6	1840		701.187	
10	1	8	85.1			116.724	
11	2	8	75.9	1725		182.741	
12	2	8	60.1	1745		272.009	
13	2	8	78	1220		33.786	
14	2	8	61.8	1559		257.743	

Statistics 19 (ChirpCenter Frequency: 5498.6 MHz)

Trial #	Pulse	Chirp(MHz)	Pulse Width (µS)	Pulse 1-2 spacing(µS)	Pulse 2-3 spacing(µS)	Pulse Start(mS)	Detection (1:yes;0:no)
1	2	19	96.7	1263		914.423	1
2	3	19	54.3	1021	1108	765.793	
3	1	19	78.9			840.716	
4	3	19	58.5	1374	1402	741.269	
5	1	19	82.3			180.502	
6	1	19	93.4			177.175	
7	2	19	50.7	1186		568.628	
8	2	19	92	1690		147.802	
9	2	19	71.3	1315		572.195	
10	2	19	70.1	1476		479.608	
11	1	19	98			371.661	
12	3	19	68.9	1856	1205	446.354	
13	3	19	74.2	1449	1112	630.677	

Statistics 20 (ChirpCenter Frequency: 5493.4 MHz)

Trial #	Pulse	Chirp(MHz)	Pulse Width (µS)	Pulse 1-2 spacing(µS)	Pulse 2-3 spacing(µS)	Pulse Start(mS)	Detection (1:yes;0:no)
1	1	6	96.6			698.125	1
2	3	6	72.3	1359	1626	953.8	
3	2	6	73.9	1841		933.98	
4	2	6	99.5	1462		713.56	
5	2	6	74.2	1992		745.69	
6	3	6	83.2	1934	1777	564.7	
7	2	6	85.3	1784		249.88	
8	3	6	71.5	1604	1616	802.98	
9	2	6	96.4	1409		917.5	
10	1	6	91.3			1139.6	

Statistics 21 (ChirpCenter Frequency: 5503.8 MHz)

Trial #	Pulse	Chirp(MHz)	Pulse Width (µS)	Pulse 1-2 spacing(µS)	Pulse 2-3 spacing(µS)	Pulse Start(mS)	Detection (1:yes;0:no)
1	2	13	58.8	1788		397.652	1
2	2	13	69.5	1787		601.247	
3	2	13	76.6	1915		480.683	
4	2	13	83.5	1725		72.27	
5	3	13	95.1	1349	1435	169.037	
6	1	13	80.2			1007.673	
7	2	13	84.7	1334		138.47	
8	3	13	52.7	1409	1014	521.537	
9	2	13	80.3	1216		306.333	

Statistics 22 (ChirpCenter Frequency: 5504.2 MHz)

Trial #	Pulse	Chirp(MHz)	Pulse Width (µS)	Pulse 1-2 spacing(µS)	Pulse 2-3 spacing(µS)	Pulse Start(mS)	Detection (1:yes;0:no)
1	1	12	91.7			188.923	1
2	1	12	65.3			323.71	
3	2	12	88	1797		148.35	
4	1	12	68.4			2.92	
5	3	12	62.3	1201	1755	404.83	
6	1	12	62.6			13.16	
7	1	12	81.2			188.27	
8	2	12	77.7	1297		193.48	
9	2	12	70.4	1868		294.83	
10	1	12	70.4			76.33	
11	2	12	53.3	1713		441.37	
12	1	12	83.2			80.07	
13	2	12	63.7	1785		147.36	
14	3	12	65.6	1499	1491	185.96	
15	2	12	70.3	1242		414.56	
16	3	12	80.6	1141	1009	397.42	
17	3	12	93.7	1487	1648	170.5	
18	3	12	57.7	1126	1233	257.7	
19	2	12	85.4	1102		440.6	
20	2	12	83.5	1408		235.6	

Statistics 23 (ChirpCenter Frequency: 5501 MHz)

Trial #	Pulse	Chirp(MHz)	Pulse Width (µS)	Pulse 1-2 spacing(µS)	Pulse 2-3 spacing(µS)	Pulse Start(mS)	Detection (1:yes;0:no)
1	3	20	55.5	1686	1566	355.125	1
2	2	20	61.3	1876		68.532	
3	3	20	62.3	1199	1094	544.187	
4	1	20	69.6			484.37	
5	2	20	51.6	1793		512.953	
6	2	20	85.6	1120		213.157	
7	2	20	99	1682		299.81	
8	3	20	92.2	1813	1723	145.733	
9	2	20	94.1	1714		148.787	
10	2	20	58.6	1212		16.12	
11	1	20	69.6			8.963	
12	2	20	66.5	1436		659.467	
13	3	20	79.7	1291	1786	131.23	
14	3	20	77.4	1495	1959	435.163	
15	1	20	88.3			502.237	
16	2	20	99.3	1134		203	
17	2	20	73.5	1291		484.433	
18	2	20	73.1	1563		68.967	

Statistics 24 (ChirpCenter Frequency: 5503 MHz)

Trial #	Pulse	Chirp(MHz)	Pulse Width (µS)	Pulse 1-2 spacing(µS)	Pulse 2-3 spacing(µS)	Pulse Start(mS)	Detection (1:yes;0:no)
1	3	15	92.5	1445	1031	348.413	1
2	3	15	95.7	1689	1503	334.964	
3	2	15	69.6	1683		363.73	
4	2	15	54.7	1540		424.33	
5	2	15	58.4	1512		257.93	
6	3	15	53.2	1865	1339	265.3	
7	2	15	76.5	1551		195.23	
8	2	15	68.9	1809		105.05	
9	3	15	82.2	1142	1179	490.69	
10	1	15	99.3			33.72	
11	2	15	54.1	1165		159.81	
12	1	15	96.3			387.67	
13	1	15	98.7			260.35	
14	2	15	73.8	1829		440.6	
15	3	15	78.5	1964	1630	481.44	
16	2	15	60.9	1797		130.44	
17	1	15	81.5			286.97	
18	2	15	59.3	1144		97.7	
19	1	15	99.2			335.2	
20	3	15	86.6	1079	1883	438.4	

Statistics 25 (ChirpCenter Frequency: 5507 MHz)

Trial #	Pulse	Chirp(MHz)	Pulse Width (µS)	Pulse 1-2 spacing(µS)	Pulse 2-3 spacing(µS)	Pulse Start(mS)	Detection (1:yes;0:no)
1	3	5	96.1	1703	1847	773.346	1
2	3	5	54.6	1976	1752	429.453	
3	3	5	98	1251	1772	131.266	
4	1	5	69.5			30.989	
5	2	5	79	1091		499.242	
6	2	5	81.8	1510		182.215	
7	3	5	70.7	1644	1643	222.548	
8	3	5	51.8	1020	1962	566.782	
9	2	5	55.9	1008		253.255	
10	2	5	58.2	1241		453.788	
11	3	5	69.7	1016	1886	403.671	
12	1	5	60.2			74.454	
13	2	5	74.8	1367		673.577	

Statistics 26 (ChirpCenter Frequency: 5501.8 MHz)

Trial #	Pulse	Chirp(MHz)	Pulse Width (µS)	Pulse 1-2 spacing(µS)	Pulse 2-3 spacing(µS)	Pulse Start(mS)	Detection (1:yes;0:no)
1	3	18	66.3	1183	1583	201.457	1
2	3	18	52.2	1593	1325	418.25	
3	2	18	91.9	1418		459.88	
4	1	18	53.6			669.15	
5	2	18	80.6	1464		135.99	
6	1	18	78.3			296.25	
7	3	18	68	1738	1549	99.58	
8	2	18	76.4	1125		920.46	
9	2	18	70.7	1975		636.92	
10	2	18	51.5	1959		664.1	
11	2	18	85.9	1447		907.5	
12	2	18	91.4	1813		345.2	

Statistics 27 (ChirpCenter Frequency: 5502.2 MHz)

Trial #	Pulse	Chirp(MHz)	Pulse Width (µS)	Pulse 1-2 spacing(µS)	Pulse 2-3 spacing(µS)	Pulse Start(mS)	Detection (1:yes;0:no)
1	2	17	63.6	1570		579.701	1
2	3	17	91.6	1957	1434	467.611	
3	3	17	81.1	1993	1598	451.622	
4	3	17	90	1091	1877	405.603	
5	1	17	62.1			0.014	
6	2	17	76	1970		364.505	
7	1	17	95.1			251.596	
8	2	17	68.3	1533		345.017	
9	1	17	88.7			96.798	
10	2	17	78.9	1447		511.599	
11	2	17	77.7	1463		288.521	
12	1	17	66.5			191.312	
13	1	17	68.8			422.443	
14	2	17	92.8	1074		294.834	
15	1	17	77.3			161.405	
16	2	17	88.3	1325		185.816	
17	1	17	50.3			25.237	
18	1	17	92.2			83.158	
19	3	17	70.3	1162	1389	168.679	

Statistics 28 (ChirpCenter Frequency: 5505.8 MHz)

Trial #	Pulse	Chirp(MHz)	Pulse Width (µS)	Pulse 1-2 spacing(µS)	Pulse 2-3 spacing(µS)	Pulse Start(mS)	Detection (1:yes;0:no)
1	2	8	88.3	1523		260.114	1
2	2	8	83.1	1889		646.398	
3	2	8	90.4	1368		659.605	
4	2	8	74.3	1810		367.213	
5	2	8	82.3	1712		697.841	
6	3	8	81.6	1648	1894	29.798	
7	3	8	54.2	1833	1431	111.936	
8	1	8	69.6			219.654	
9	2	8	63.4	1899		59.111	
10	1	8	78.4			531.349	
11	2	8	85	1097		30.176	
12	1	8	70.8			553.104	
13	2	8	50.1	1255		86.852	
14	1	8	57.9			221.479	
15	3	8	66.8	1241	1822	358.147	
16	1	8	69.2			337.965	
17	2	8	89	1801		690.182	

Statistics 29 (ChirpCenter Frequency: 5501.4 MHz)

Trial #	Pulse	Chirp(MHz)	Pulse Width (µS)	Pulse 1-2 spacing(µS)	Pulse 2-3 spacing(µS)	Pulse Start(mS)	Detection (1:yes;0:no)
1	3	19	60.5	1371	1174	903.957	1
2	3	19	60.6	1756	1631	1059.231	
3	3	19	93.6	1828	1012	929.212	
4	3	19	75	1030	1288	854.603	
5	3	19	85.9	1964	1378	799.014	
6	2	19	82.8	1282		712.225	
7	2	19	98.9	1008		667.815	
8	3	19	92.6	1507	1479	717.896	
9	1	19	80.6			354.967	
10	2	19	79.2	1254		262.918	
11	2	19	61.4	1224		393.209	

Statistics 30 (ChirpCenter Frequency: 5504.6 MHz)

Trial #	Pulse	Chirp(MHz)	Pulse Width (µS)	Pulse 1-2 spacing(µS)	Pulse 2-3 spacing(µS)	Pulse Start(mS)	Detection (1:yes;0:no)
1	2	11	90.7	1412		105.494	1
2	1	11	73			509.9	
3	2	11	60.4	1486		585.41	
4	2	11	68.4	1420		282.56	
5	2	11	53.4	1890		701.2	
6	3	11	97.6	1851	1765	491.01	
7	2	11	56.3	1995		133.13	
8	1	11	91.2			313.95	
9	3	11	80	1185	1489	128.23	
10	1	11	71.5			632.34	
11	3	11	61	1499	1388	660.17	
12	2	11	73	1510		365.63	
13	3	11	62.5	1933	1187	195.37	
14	2	11	96	1508		695.3	
15	3	11	94.1	1062	1156	502.7	
16	3	11	79.4	1218	1980	75.7	

Radar Type 6 Statistical Performance

Trial #	Fc (MHz)	Pulse /Burst	Pulse Width (μS)	PRI (μs)	Detection (1:yes; 0:no)	Hopping Sequence (GHz)
1	5500	9	1	333	1	5.439, 5.663, 5.540, 5.700, 5.627, 5.434, 5.304, 5.301, 5.355, 5.598, 5.279, 5.696, 5.701, 5.575, 5.662, 5.334, 5.377, 5.537, 5.623, 5.524, 5.350, 5.603, 5.364, 5.685, 5.386, 5.699, 5.639, 5.533, 5.395, 5.257, 5.277, 5.683, 5.702, 5.264, 5.470, 5.388, 5.490, 5.452, 5.604, 5.473, 5.378, 5.635, 5.650, 5.477, 5.347, 5.619, 5.599, 5.396, 5.567, 5.652, 5.595, 5.515, 5.375, 5.283, 5.710, 5.330, 5.332, 5.609, 5.411, 5.360, 5.596, 5.597, 5.578, 5.310, 5.628, 5.428, 5.501, 5.571, 5.672, 5.554, 5.616, 5.302, 5.259, 5.394, 5.666, 5.643, 5.593, 5.466, 5.344, 5.581, 5.461, 5.496, 5.531, 5.697, 5.633, 5.405, 5.543, 5.471, 5.617, 5.447, 5.653, 5.305, 5.272, 5.260, 5.448, 5.536, 5.615, 5.342, 5.465, 5.564
2	5500	9	1	333	1	5.432, 5.358, 5.489, 5.280, 5.368, 5.562, 5.289, 5.293, 5.304, 5.326, 5.647, 5.668, 5.367, 5.342, 5.557, 5.440, 5.356, 5.349, 5.428, 5.513, 5.663, 5.313, 5.582, 5.377, 5.360, 5.468, 5.398, 5.441, 5.471, 5.502, 5.628, 5.643, 5.508, 5.646, 5.382, 5.512, 5.672, 5.331, 5.552, 5.260, 5.462, 5.701, 5.614, 5.463, 5.608, 5.341, 5.491, 5.370, 5.649, 5.395, 5.722, 5.529, 5.620, 5.526, 5.494, 5.569, 5.606, 5.705, 5.443, 5.305, 5.532, 5.505, 5.553, 5.296, 5.534, 5.310, 5.415, 5.333, 5.568, 5.351, 5.374, 5.652, 5.357, 5.704, 5.403, 5.667, 5.530, 5.273, 5.507, 5.651, 5.624, 5.259, 5.633, 5.306, 5.380, 5.354, 5.693, 5.294, 5.291, 5.431, 5.602, 5.255, 5.262, 5.641, 5.661, 5.486, 5.446, 5.583, 5.514, 5.433
3	5500	9	1	333	1	5.442, 5.390, 5.589, 5.636, 5.619, 5.582, 5.317, 5.440, 5.559, 5.535, 5.662, 5.327, 5.563, 5.697, 5.268, 5.426, 5.536, 5.337, 5.537, 5.587, 5.253, 5.380, 5.719, 5.250, 5.483, 5.339, 5.290, 5.572, 5.547, 5.469, 5.395, 5.282, 5.420, 5.717, 5.604, 5.584, 5.625, 5.451, 5.303, 5.492, 5.341, 5.529, 5.349, 5.468, 5.553, 5.551, 5.398, 5.407, 5.296, 5.334, 5.454, 5.497, 5.622, 5.543, 5.409, 5.558, 5.463, 5.651, 5.406, 5.445, 5.519, 5.393, 5.478, 5.557, 5.638, 5.266, 5.663, 5.505, 5.577, 5.527, 5.655, 5.389, 5.482, 5.384, 5.419, 5.335, 5.530, 5.689, 5.272, 5.410, 5.495, 5.252, 5.378, 5.394, 5.456, 5.676, 5.682, 5.263, 5.288, 5.460, 5.502, 5.649, 5.674, 5.474, 5.305, 5.385, 5.658, 5.465, 5.706, 5.698
4	5500	9	1	333	1	5.644, 5.688, 5.510, 5.513, 5.462, 5.670, 5.560, 5.334, 5.584, 5.439, 5.475, 5.537, 5.568, 5.331, 5.699, 5.307, 5.267, 5.529,

						5.680, 5.274, 5.587, 5.713, 5.500, 5.581, 5.633, 5.607, 5.420, 5.548, 5.347, 5.318, 5.260, 5.464, 5.341, 5.333, 5.275, 5.715, 5.448, 5.528, 5.647, 5.486, 5.531, 5.284, 5.667, 5.546, 5.589, 5.433, 5.273, 5.482, 5.702, 5.705, 5.252, 5.527, 5.261, 5.328, 5.308, 5.373, 5.575, 5.545, 5.453, 5.706, 5.600, 5.419, 5.512, 5.516, 5.533, 5.349, 5.461, 5.423, 5.592, 5.506, 5.618, 5.455, 5.596, 5.626, 5.437, 5.351, 5.639, 5.336, 5.342, 5.383, 5.511, 5.316, 5.498, 5.683, 5.312, 5.689, 5.291, 5.445, 5.710, 5.664, 5.579, 5.411, 5.576, 5.714, 5.674, 5.694, 5.696, 5.606, 5.429, 5.487
5	5500	9	1	333	1	5.392, 5.261, 5.668, 5.519, 5.663, 5.608, 5.531, 5.389, 5.394, 5.501, 5.259, 5.679, 5.372, 5.385, 5.645, 5.314, 5.471, 5.391, 5.705, 5.586, 5.458, 5.647, 5.468, 5.619, 5.276, 5.524, 5.707, 5.455, 5.502, 5.594, 5.345, 5.251, 5.312, 5.567, 5.624, 5.417, 5.268, 5.308, 5.610, 5.403, 5.289, 5.414, 5.267, 5.432, 5.409, 5.316, 5.546, 5.333, 5.408, 5.548, 5.541, 5.638, 5.374, 5.489, 5.500, 5.575, 5.574, 5.297, 5.690, 5.272, 5.328, 5.350, 5.273, 5.615, 5.365, 5.513, 5.421, 5.450, 5.685, 5.463, 5.475, 5.446, 5.658, 5.368, 5.462, 5.621, 5.343, 5.285, 5.688, 5.554, 5.439, 5.377, 5.572, 5.487, 5.542, 5.453, 5.700, 5.483, 5.370, 5.379, 5.702, 5.454, 5.529, 5.634, 5.476, 5.578, 5.288, 5.359, 5.614, 5.423
6	5500	9	1	333	1	5.314, 5.583, 5.372, 5.442, 5.706, 5.577, 5.317, 5.406, 5.427, 5.654, 5.337, 5.419, 5.572, 5.657, 5.320, 5.274, 5.628, 5.470, 5.415, 5.456, 5.567, 5.311, 5.492, 5.531, 5.310, 5.436, 5.397, 5.377, 5.505, 5.496, 5.447, 5.563, 5.586, 5.512, 5.587, 5.324, 5.553, 5.266, 5.410, 5.598, 5.697, 5.401, 5.421, 5.560, 5.501, 5.517, 5.610, 5.499, 5.375, 5.568, 5.712, 5.724, 5.466, 5.329, 5.655, 5.412, 5.347, 5.254, 5.621, 5.319, 5.344, 5.418, 5.530, 5.461, 5.503, 5.683, 5.285, 5.558, 5.520, 5.356, 5.605, 5.659, 5.595, 5.340, 5.677, 5.435, 5.521, 5.637, 5.550, 5.446, 5.423, 5.676, 5.714, 5.389, 5.321, 5.522, 5.692, 5.538, 5.490, 5.696, 5.564, 5.286, 5.709, 5.615, 5.284, 5.306, 5.386, 5.369, 5.252, 5.513,
7	5500	9	1	333	1	5.323, 5.453, 5.678, 5.379, 5.294, 5.697, 5.363, 5.463, 5.486, 5.328, 5.545, 5.608, 5.501, 5.343, 5.269, 5.432, 5.483, 5.713, 5.671, 5.586, 5.367, 5.434, 5.448, 5.425, 5.593, 5.352, 5.394, 5.630, 5.446, 5.690, 5.637, 5.472, 5.420, 5.447, 5.559, 5.313, 5.353, 5.558, 5.626, 5.319, 5.554, 5.347, 5.723, 5.708, 5.475, 5.421, 5.473, 5.461, 5.541, 5.502, 5.413, 5.650, 5.544, 5.507, 5.527, 5.430, 5.435, 5.455, 5.579, 5.356, 5.309, 5.676, 5.255, 5.304, 5.651, 5.388, 5.505, 5.530, 5.597, 5.336, 5.572, 5.569,

						5.638, 5.562, 5.495, 5.479, 5.440, 5.720, 5.706, 5.259, 5.700, 5.649, 5.599, 5.557, 5.267, 5.443, 5.282, 5.619, 5.292, 5.460, 5.261, 5.364, 5.426, 5.462, 5.566, 5.314, 5.251, 5.622, 5.600, 5.300
8	5500	9	1	333	1	5.259, 5.443, 5.392, 5.480, 5.356, 5.554, 5.420, 5.364, 5.453, 5.449, 5.579, 5.688, 5.619, 5.339, 5.588, 5.379, 5.702, 5.334, 5.614, 5.261, 5.470, 5.325, 5.380, 5.624, 5.502, 5.520, 5.276, 5.313, 5.282, 5.611, 5.301, 5.512, 5.407, 5.299, 5.608, 5.455, 5.314, 5.375, 5.374, 5.378, 5.362, 5.415, 5.556, 5.357, 5.291, 5.533, 5.467, 5.615, 5.297, 5.284, 5.563, 5.535, 5.308, 5.632, 5.418, 5.551, 5.547, 5.303, 5.359, 5.350, 5.260, 5.693, 5.431, 5.252, 5.255, 5.404, 5.340, 5.633, 5.508, 5.591, 5.488, 5.390, 5.526, 5.319, 5.597, 5.680, 5.552, 5.365, 5.283, 5.316, 5.698, 5.253, 5.429, 5.410, 5.602, 5.286, 5.630, 5.484, 5.257, 5.623, 5.475, 5.483, 5.351, 5.572, 5.458, 5.589, 5.332, 5.307, 5.278, 5.522
9	5500	9	1	333	1	5.448, 5.318, 5.603, 5.312, 5.540, 5.393, 5.410, 5.347, 5.477, 5.261, 5.328, 5.607, 5.390, 5.426, 5.552, 5.634, 5.523, 5.567, 5.485, 5.623, 5.605, 5.655, 5.412, 5.366, 5.614, 5.565, 5.253, 5.389, 5.706, 5.257, 5.299, 5.564, 5.407, 5.259, 5.346, 5.362, 5.592, 5.336, 5.633, 5.420, 5.534, 5.422, 5.612, 5.367, 5.319, 5.650, 5.352, 5.391, 5.344, 5.456, 5.375, 5.724, 5.460, 5.511, 5.486, 5.464, 5.494, 5.432, 5.378, 5.343, 5.648, 5.667, 5.573, 5.326, 5.544, 5.643, 5.694, 5.421, 5.716, 5.703, 5.527, 5.296, 5.577, 5.624, 5.700, 5.563, 5.508, 5.600, 5.518, 5.719, 5.379, 5.308, 5.641, 5.331, 5.665, 5.353, 5.373, 5.443, 5.397, 5.380, 5.517, 5.453, 5.661, 5.282, 5.690, 5.275, 5.370, 5.606, 5.363, 5.279
10	5500	9	1	333	1	5.449, 5.684, 5.353, 5.338, 5.609, 5.575, 5.547, 5.378, 5.413, 5.403, 5.440, 5.694, 5.718, 5.627, 5.286, 5.569, 5.439, 5.278, 5.576, 5.707, 5.391, 5.488, 5.536, 5.527, 5.301, 5.393, 5.622, 5.670, 5.267, 5.303, 5.667, 5.428, 5.359, 5.513, 5.503, 5.288, 5.266, 5.578, 5.637, 5.620, 5.596, 5.420, 5.341, 5.673, 5.354, 5.283, 5.597, 5.297, 5.705, 5.556, 5.312, 5.570, 5.572, 5.640, 5.369, 5.625, 5.376, 5.423, 5.702, 5.401, 5.588, 5.652, 5.324, 5.252, 5.291, 5.629, 5.598, 5.546, 5.386, 5.337, 5.441, 5.292, 5.419, 5.462, 5.363, 5.545, 5.689, 5.432, 5.698, 5.309, 5.453, 5.268, 5.638, 5.289, 5.626, 5.457, 5.433, 5.500, 5.646, 5.666, 5.360, 5.320, 5.676, 5.273, 5.678, 5.720, 5.554, 5.669, 5.343, 5.533
11	5500	9	1	333	1	5.392, 5.709, 5.269, 5.390, 5.590, 5.663, 5.706, 5.328, 5.642, 5.528, 5.456, 5.360, 5.446, 5.674, 5.300, 5.565, 5.515, 5.533, 5.501, 5.409, 5.479, 5.348, 5.641, 5.386,

						5.717, 5.489, 5.476, 5.358, 5.697, 5.461, 5.428, 5.423, 5.596, 5.578, 5.510, 5.455, 5.357, 5.636, 5.410, 5.306, 5.486, 5.686, 5.494, 5.421, 5.503, 5.322, 5.713, 5.319, 5.651, 5.332, 5.618, 5.256, 5.366, 5.532, 5.592, 5.693, 5.259, 5.254, 5.714, 5.378, 5.463, 5.291, 5.519, 5.431, 5.426, 5.612, 5.368, 5.630, 5.622, 5.595, 5.487, 5.414, 5.415, 5.711, 5.354, 5.400, 5.564, 5.382, 5.610, 5.408, 5.695, 5.477, 5.559, 5.435, 5.440, 5.327, 5.523, 5.673, 5.591, 5.608, 5.310, 5.379, 5.582, 5.261, 5.307, 5.637, 5.601, 5.318, 5.384, 5.469
12	5500	9	1	333	1	5.395, 5.648, 5.294, 5.723, 5.629, 5.593, 5.541, 5.261, 5.370, 5.601, 5.706, 5.660, 5.414, 5.453, 5.564, 5.497, 5.514, 5.435, 5.396, 5.343, 5.533, 5.358, 5.310, 5.316, 5.291, 5.520, 5.271, 5.683, 5.596, 5.714, 5.584, 5.420, 5.255, 5.581, 5.503, 5.662, 5.667, 5.543, 5.574, 5.669, 5.300, 5.523, 5.538, 5.597, 5.611, 5.302, 5.687, 5.554, 5.620, 5.613, 5.357, 5.578, 5.654, 5.474, 5.676, 5.405, 5.452, 5.632, 5.372, 5.276, 5.381, 5.490, 5.528, 5.437, 5.303, 5.400, 5.340, 5.522, 5.477, 5.626, 5.494, 5.461, 5.297, 5.319, 5.616, 5.427, 5.345, 5.351, 5.265, 5.515, 5.374, 5.540, 5.366, 5.527, 5.542, 5.699, 5.257, 5.306, 5.330, 5.356, 5.308, 5.553, 5.399, 5.329, 5.281, 5.322, 5.605, 5.456, 5.468, 5.417
13	5500	9	1	333	1	5.301, 5.445, 5.489, 5.288, 5.314, 5.354, 5.646, 5.613, 5.341, 5.250, 5.317, 5.459, 5.675, 5.707, 5.517, 5.493, 5.374, 5.478, 5.311, 5.266, 5.277, 5.553, 5.527, 5.608, 5.373, 5.483, 5.586, 5.336, 5.614, 5.382, 5.282, 5.722, 5.584, 5.329, 5.280, 5.411, 5.568, 5.375, 5.254, 5.406, 5.258, 5.295, 5.612, 5.468, 5.715, 5.522, 5.548, 5.471, 5.443, 5.423, 5.269, 5.562, 5.502, 5.634, 5.519, 5.426, 5.278, 5.462, 5.342, 5.685, 5.606, 5.438, 5.389, 5.257, 5.465, 5.669, 5.275, 5.520, 5.671, 5.276, 5.689, 5.330, 5.303, 5.563, 5.452, 5.543, 5.352, 5.447, 5.325, 5.451, 5.600, 5.324, 5.513, 5.348, 5.255, 5.402, 5.491, 5.510, 5.472, 5.412, 5.599, 5.539, 5.708, 5.370, 5.272, 5.305, 5.595, 5.400, 5.649, 5.309
14	5500	9	1	333	1	5.296, 5.297, 5.493, 5.467, 5.353, 5.463, 5.628, 5.407, 5.559, 5.448, 5.332, 5.434, 5.409, 5.724, 5.686, 5.398, 5.270, 5.294, 5.442, 5.488, 5.588, 5.657, 5.278, 5.663, 5.656, 5.305, 5.486, 5.579, 5.260, 5.676, 5.481, 5.491, 5.546, 5.623, 5.299, 5.338, 5.411, 5.355, 5.344, 5.636, 5.598, 5.704, 5.383, 5.507, 5.556, 5.465, 5.716, 5.561, 5.416, 5.262, 5.267, 5.358, 5.251, 5.323, 5.625, 5.394, 5.391, 5.275, 5.316, 5.298, 5.624, 5.519, 5.540, 5.708, 5.443, 5.528, 5.291, 5.538, 5.718, 5.690, 5.321, 5.357, 5.650, 5.589, 5.597, 5.721, 5.331, 5.527,

						5.700, 5.640, 5.392, 5.281, 5.389, 5.719, 5.687, 5.330, 5.268, 5.647, 5.637, 5.511, 5.635, 5.652, 5.513, 5.406, 5.455, 5.536, 5.570, 5.715, 5.516, 5.578
15	5500	9	1	333	1	5.463, 5.348, 5.524, 5.722, 5.633, 5.533, 5.495, 5.372, 5.720, 5.481, 5.598, 5.450, 5.679, 5.509, 5.273, 5.526, 5.313, 5.677, 5.312, 5.364, 5.452, 5.543, 5.539, 5.546, 5.449, 5.276, 5.422, 5.461, 5.566, 5.614, 5.652, 5.370, 5.438, 5.696, 5.265, 5.502, 5.537, 5.702, 5.542, 5.603, 5.326, 5.656, 5.570, 5.414, 5.493, 5.284, 5.600, 5.559, 5.561, 5.713, 5.311, 5.291, 5.518, 5.435, 5.682, 5.307, 5.343, 5.538, 5.647, 5.611, 5.341, 5.523, 5.641, 5.390, 5.503, 5.591, 5.480, 5.568, 5.659, 5.517, 5.530, 5.636, 5.640, 5.608, 5.681, 5.393, 5.294, 5.325, 5.324, 5.674, 5.577, 5.512, 5.446, 5.366, 5.444, 5.592, 5.299, 5.385, 5.365, 5.329, 5.514, 5.458, 5.572, 5.441, 5.621, 5.305, 5.382, 5.388, 5.569, 5.723
16	5500	9	1	333	1	5.535, 5.589, 5.460, 5.267, 5.657, 5.432, 5.540, 5.640, 5.487, 5.641, 5.367, 5.711, 5.530, 5.291, 5.251, 5.627, 5.450, 5.349, 5.568, 5.384, 5.699, 5.393, 5.441, 5.316, 5.667, 5.546, 5.693, 5.330, 5.625, 5.705, 5.613, 5.328, 5.610, 5.390, 5.523, 5.503, 5.716, 5.497, 5.375, 5.605, 5.631, 5.660, 5.284, 5.337, 5.253, 5.601, 5.668, 5.347, 5.666, 5.376, 5.690, 5.691, 5.429, 5.299, 5.292, 5.629, 5.532, 5.555, 5.672, 5.484, 5.689, 5.405, 5.709, 5.362, 5.454, 5.332, 5.462, 5.289, 5.351, 5.592, 5.304, 5.593, 5.334, 5.268, 5.719, 5.333, 5.404, 5.590, 5.649, 5.313, 5.297, 5.695, 5.331, 5.704, 5.406, 5.681, 5.338, 5.661, 5.252, 5.519, 5.652, 5.502, 5.682, 5.285, 5.428, 5.557, 5.273, 5.271, 5.294, 5.356
17	5500	9	1	333	1	5.685, 5.503, 5.681, 5.529, 5.591, 5.586, 5.713, 5.489, 5.625, 5.317, 5.549, 5.450, 5.656, 5.428, 5.349, 5.645, 5.659, 5.316, 5.525, 5.593, 5.376, 5.535, 5.652, 5.270, 5.561, 5.716, 5.629, 5.691, 5.462, 5.697, 5.508, 5.290, 5.425, 5.596, 5.434, 5.336, 5.578, 5.493, 5.687, 5.553, 5.363, 5.610, 5.308, 5.368, 5.598, 5.486, 5.724, 5.393, 5.692, 5.414, 5.501, 5.530, 5.631, 5.556, 5.403, 5.571, 5.634, 5.684, 5.554, 5.456, 5.400, 5.385, 5.710, 5.569, 5.507, 5.430, 5.672, 5.609, 5.601, 5.533, 5.350, 5.471, 5.536, 5.514, 5.557, 5.267, 5.436, 5.315, 5.476, 5.600, 5.429, 5.373, 5.431, 5.484, 5.624, 5.663, 5.715, 5.565, 5.637, 5.520, 5.251, 5.253, 5.271, 5.548, 5.371, 5.292, 5.401, 5.502, 5.355, 5.714
18	5500	9	1	333	1	5.604, 5.500, 5.492, 5.390, 5.571, 5.713, 5.684, 5.264, 5.622, 5.486, 5.509, 5.463, 5.320, 5.695, 5.675, 5.404, 5.434, 5.702, 5.460, 5.516, 5.589, 5.709, 5.629, 5.642, 5.540, 5.426, 5.452, 5.565, 5.592, 5.688,

						5.546, 5.382, 5.450, 5.448, 5.271, 5.393, 5.374, 5.294, 5.278, 5.665, 5.401, 5.312, 5.687, 5.310, 5.354, 5.578, 5.596, 5.644, 5.641, 5.575, 5.683, 5.445, 5.336, 5.251, 5.424, 5.559, 5.627, 5.262, 5.394, 5.413, 5.707, 5.636, 5.405, 5.628, 5.358, 5.616, 5.700, 5.674, 5.356, 5.341, 5.618, 5.512, 5.360, 5.389, 5.577, 5.703, 5.576, 5.254, 5.339, 5.699, 5.443, 5.305, 5.721, 5.598, 5.408, 5.677, 5.692, 5.653, 5.668, 5.535, 5.422, 5.501, 5.521, 5.425, 5.704, 5.406, 5.714, 5.654, 5.648, 5.375
19	5500	9	1	333	1	5.359, 5.301, 5.680, 5.529, 5.273, 5.687, 5.713, 5.442, 5.624, 5.413, 5.443, 5.265, 5.409, 5.649, 5.526, 5.597, 5.684, 5.400, 5.403, 5.622, 5.261, 5.504, 5.415, 5.545, 5.496, 5.539, 5.627, 5.373, 5.643, 5.570, 5.274, 5.346, 5.447, 5.397, 5.450, 5.376, 5.576, 5.315, 5.258, 5.467, 5.420, 5.614, 5.537, 5.402, 5.369, 5.419, 5.343, 5.490, 5.628, 5.502, 5.304, 5.406, 5.324, 5.457, 5.358, 5.253, 5.431, 5.569, 5.600, 5.678, 5.383, 5.582, 5.560, 5.288, 5.546, 5.528, 5.286, 5.424, 5.572, 5.399, 5.418, 5.593, 5.519, 5.459, 5.515, 5.653, 5.473, 5.711, 5.364, 5.326, 5.723, 5.571, 5.610, 5.590, 5.498, 5.270, 5.379, 5.410, 5.577, 5.477, 5.578, 5.328, 5.669, 5.565, 5.329, 5.356, 5.681, 5.444, 5.547, 5.332
20	5500	9	1	333	1	5.513, 5.251, 5.370, 5.400, 5.500, 5.606, 5.447, 5.711, 5.381, 5.445, 5.333, 5.610, 5.267, 5.604, 5.307, 5.675, 5.329, 5.547, 5.688, 5.457, 5.387, 5.427, 5.540, 5.706, 5.640, 5.680, 5.459, 5.554, 5.454, 5.636, 5.719, 5.528, 5.512, 5.357, 5.462, 5.280, 5.586, 5.450, 5.451, 5.613, 5.664, 5.350, 5.397, 5.344, 5.366, 5.665, 5.426, 5.293, 5.271, 5.526, 5.607, 5.475, 5.560, 5.582, 5.565, 5.626, 5.262, 5.270, 5.385, 5.591, 5.337, 5.692, 5.416, 5.464, 5.339, 5.504, 5.408, 5.456, 5.635, 5.345, 5.449, 5.499, 5.351, 5.707, 5.438, 5.314, 5.317, 5.313, 5.342, 5.461, 5.641, 5.720, 5.724, 5.714, 5.569, 5.681, 5.327, 5.594, 5.340, 5.491, 5.413, 5.377, 5.311, 5.328, 5.369, 5.577, 5.531, 5.355, 5.518, 5.393
21	5500	9	1	333	1	5.646, 5.667, 5.609, 5.499, 5.717, 5.684, 5.368, 5.634, 5.400, 5.277, 5.568, 5.422, 5.304, 5.376, 5.456, 5.541, 5.305, 5.450, 5.514, 5.329, 5.495, 5.363, 5.680, 5.383, 5.585, 5.419, 5.472, 5.352, 5.409, 5.493, 5.649, 5.534, 5.620, 5.557, 5.719, 5.589, 5.687, 5.671, 5.386, 5.458, 5.441, 5.644, 5.577, 5.445, 5.611, 5.606, 5.681, 5.669, 5.559, 5.699, 5.360, 5.599, 5.356, 5.721, 5.601, 5.701, 5.639, 5.307, 5.689, 5.378, 5.442, 5.366, 5.337, 5.686, 5.520, 5.555, 5.576, 5.491, 5.625, 5.355, 5.538, 5.257, 5.715, 5.359, 5.469, 5.533, 5.496, 5.303, 5.259, 5.529, 5.421, 5.542, 5.312, 5.603,

						5.350, 5.673, 5.547, 5.260, 5.367, 5.672, 5.641, 5.318, 5.315, 5.569, 5.265, 5.327, 5.412, 5.322, 5.447, 5.488
22	5500	9	1	333	1	5.587, 5.494, 5.493, 5.640, 5.595, 5.438, 5.637, 5.491, 5.265, 5.374, 5.487, 5.258, 5.430, 5.664, 5.372, 5.330, 5.551, 5.557, 5.559, 5.286, 5.633, 5.440, 5.323, 5.541, 5.370, 5.276, 5.290, 5.352, 5.526, 5.691, 5.496, 5.387, 5.479, 5.252, 5.289, 5.324, 5.607, 5.308, 5.582, 5.311, 5.663, 5.539, 5.605, 5.684, 5.550, 5.618, 5.634, 5.540, 5.256, 5.656, 5.529, 5.445, 5.495, 5.281, 5.608, 5.645, 5.628, 5.384, 5.511, 5.364, 5.604, 5.589, 5.653, 5.462, 5.642, 5.615, 5.661, 5.376, 5.703, 5.546, 5.719, 5.292, 5.305, 5.523, 5.598, 5.512, 5.678, 5.320, 5.521, 5.646, 5.669, 5.319, 5.692, 5.627, 5.483, 5.721, 5.442, 5.295, 5.322, 5.517, 5.475, 5.576, 5.444, 5.421, 5.531, 5.613, 5.435, 5.635, 5.431, 5.277
23	5500	9	1	333	1	5.356, 5.559, 5.458, 5.303, 5.558, 5.314, 5.643, 5.250, 5.684, 5.381, 5.325, 5.362, 5.491, 5.552, 5.646, 5.532, 5.464, 5.419, 5.522, 5.630, 5.377, 5.654, 5.658, 5.320, 5.589, 5.284, 5.253, 5.674, 5.473, 5.679, 5.701, 5.713, 5.286, 5.397, 5.562, 5.453, 5.438, 5.378, 5.363, 5.514, 5.475, 5.502, 5.276, 5.510, 5.577, 5.311, 5.404, 5.716, 5.457, 5.696, 5.677, 5.361, 5.431, 5.261, 5.639, 5.488, 5.267, 5.497, 5.317, 5.549, 5.668, 5.585, 5.291, 5.690, 5.390, 5.410, 5.352, 5.592, 5.315, 5.435, 5.566, 5.441, 5.609, 5.505, 5.718, 5.336, 5.420, 5.610, 5.293, 5.511, 5.642, 5.682, 5.263, 5.648, 5.561, 5.288, 5.304, 5.347, 5.535, 5.322, 5.252, 5.421, 5.694, 5.655, 5.675, 5.542, 5.712, 5.316, 5.409, 5.440
24	5500	9	1	333	1	5.647, 5.305, 5.607, 5.641, 5.399, 5.720, 5.528, 5.635, 5.534, 5.529, 5.701, 5.250, 5.673, 5.389, 5.270, 5.362, 5.578, 5.412, 5.665, 5.562, 5.454, 5.614, 5.278, 5.262, 5.715, 5.466, 5.331, 5.648, 5.290, 5.269, 5.352, 5.637, 5.713, 5.381, 5.719, 5.655, 5.427, 5.257, 5.377, 5.629, 5.345, 5.484, 5.435, 5.566, 5.553, 5.497, 5.700, 5.423, 5.361, 5.426, 5.422, 5.436, 5.520, 5.672, 5.496, 5.319, 5.297, 5.287, 5.515, 5.326, 5.449, 5.707, 5.374, 5.504, 5.314, 5.397, 5.471, 5.272, 5.441, 5.338, 5.333, 5.493, 5.437, 5.668, 5.255, 5.483, 5.602, 5.600, 5.624, 5.500, 5.512, 5.596, 5.413, 5.656, 5.627, 5.691, 5.613, 5.259, 5.589, 5.329, 5.321, 5.428, 5.339, 5.545, 5.403, 5.350, 5.451, 5.653, 5.638, 5.605
25	5500	9	1	333	1	5.492, 5.577, 5.336, 5.542, 5.436, 5.537, 5.313, 5.407, 5.634, 5.440, 5.426, 5.564, 5.517, 5.254, 5.479, 5.361, 5.659, 5.267, 5.398, 5.482, 5.649, 5.481, 5.662, 5.461, 5.301, 5.395, 5.298, 5.300, 5.322, 5.421, 5.325, 5.702, 5.465, 5.261, 5.494, 5.583,

						5.412, 5.339, 5.521, 5.625, 5.654, 5.379, 5.545, 5.543, 5.435, 5.694, 5.434, 5.349, 5.520, 5.672, 5.425, 5.652, 5.719, 5.666, 5.464, 5.340, 5.682, 5.362, 5.356, 5.640, 5.724, 5.673, 5.430, 5.651, 5.302, 5.594, 5.685, 5.669, 5.579, 5.309, 5.406, 5.311, 5.442, 5.689, 5.678, 5.501, 5.263, 5.503, 5.712, 5.679, 5.351, 5.676, 5.460, 5.591, 5.308, 5.291, 5.671, 5.620, 5.611, 5.328, 5.331, 5.346, 5.279, 5.585, 5.295, 5.363, 5.658, 5.509, 5.660, 5.299
26	5500	9	1	333	1	5.468, 5.687, 5.359, 5.314, 5.387, 5.608, 5.444, 5.611, 5.689, 5.719, 5.568, 5.302, 5.352, 5.561, 5.703, 5.335, 5.416, 5.264, 5.319, 5.523, 5.271, 5.668, 5.685, 5.642, 5.438, 5.692, 5.675, 5.513, 5.707, 5.472, 5.662, 5.345, 5.639, 5.317, 5.458, 5.609, 5.646, 5.395, 5.710, 5.614, 5.681, 5.495, 5.469, 5.577, 5.482, 5.581, 5.258, 5.527, 5.537, 5.440, 5.296, 5.712, 5.570, 5.669, 5.371, 5.578, 5.427, 5.326, 5.429, 5.690, 5.683, 5.501, 5.638, 5.434, 5.332, 5.559, 5.598, 5.478, 5.691, 5.563, 5.603, 5.504, 5.515, 5.430, 5.483, 5.533, 5.709, 5.396, 5.321, 5.625, 5.635, 5.616, 5.452, 5.381, 5.722, 5.453, 5.293, 5.421, 5.671, 5.351, 5.716, 5.542, 5.594, 5.259, 5.423, 5.512, 5.632, 5.362, 5.506, 5.648
27	5500	9	1	333	1	5.433, 5.353, 5.618, 5.603, 5.687, 5.267, 5.274, 5.350, 5.326, 5.396, 5.333, 5.536, 5.701, 5.535, 5.594, 5.689, 5.502, 5.649, 5.541, 5.301, 5.654, 5.400, 5.550, 5.367, 5.361, 5.483, 5.259, 5.452, 5.351, 5.529, 5.519, 5.357, 5.503, 5.552, 5.724, 5.645, 5.592, 5.278, 5.372, 5.589, 5.637, 5.538, 5.489, 5.407, 5.713, 5.651, 5.317, 5.666, 5.262, 5.595, 5.348, 5.365, 5.369, 5.450, 5.448, 5.675, 5.330, 5.640, 5.721, 5.554, 5.470, 5.268, 5.496, 5.635, 5.289, 5.377, 5.671, 5.404, 5.573, 5.269, 5.475, 5.534, 5.621, 5.605, 5.416, 5.434, 5.500, 5.425, 5.706, 5.270, 5.253, 5.495, 5.354, 5.584, 5.622, 5.710, 5.411, 5.293, 5.530, 5.373, 5.339, 5.679, 5.624, 5.601, 5.338, 5.488, 5.349, 5.435, 5.464, 5.308
28	5500	9	1	333	1	5.587, 5.372, 5.276, 5.367, 5.365, 5.540, 5.712, 5.301, 5.444, 5.523, 5.669, 5.566, 5.445, 5.641, 5.389, 5.509, 5.552, 5.418, 5.713, 5.484, 5.342, 5.511, 5.325, 5.322, 5.522, 5.410, 5.710, 5.488, 5.709, 5.321, 5.278, 5.403, 5.260, 5.286, 5.699, 5.685, 5.633, 5.642, 5.529, 5.430, 5.585, 5.385, 5.318, 5.629, 5.290, 5.570, 5.390, 5.289, 5.649, 5.439, 5.427, 5.394, 5.363, 5.350, 5.479, 5.316, 5.557, 5.471, 5.360, 5.279, 5.361, 5.352, 5.270, 5.298, 5.377, 5.581, 5.468, 5.560, 5.423, 5.701, 5.583, 5.255, 5.535, 5.482, 5.645, 5.451, 5.504, 5.680, 5.454, 5.438, 5.606, 5.495, 5.655, 5.437, 5.369, 5.487, 5.257, 5.459, 5.376, 5.330,

						5.639, 5.700, 5.452, 5.396, 5.382, 5.371, 5.717, 5.624, 5.524, 5.601
29	5500	9	1	333	1	5.378, 5.698, 5.388, 5.671, 5.640, 5.469, 5.594, 5.487, 5.619, 5.498, 5.647, 5.402, 5.279, 5.583, 5.448, 5.596, 5.653, 5.587, 5.561, 5.709, 5.276, 5.530, 5.657, 5.631, 5.286, 5.267, 5.431, 5.712, 5.439, 5.466, 5.613, 5.360, 5.691, 5.643, 5.591, 5.724, 5.356, 5.426, 5.504, 5.336, 5.433, 5.435, 5.664, 5.600, 5.382, 5.321, 5.367, 5.563, 5.558, 5.332, 5.353, 5.548, 5.297, 5.715, 5.711, 5.272, 5.400, 5.535, 5.713, 5.509, 5.719, 5.419, 5.672, 5.496, 5.681, 5.298, 5.414, 5.250, 5.444, 5.274, 5.307, 5.357, 5.514, 5.323, 5.703, 5.471, 5.501, 5.560, 5.406, 5.424, 5.483, 5.651, 5.440, 5.364, 5.418, 5.253, 5.630, 5.503, 5.375, 5.680, 5.468, 5.331, 5.257, 5.369, 5.632, 5.601, 5.280, 5.470, 5.633, 5.552
30	5500	9	1	333	1	5.547, 5.253, 5.688, 5.269, 5.673, 5.693, 5.421, 5.651, 5.320, 5.295, 5.563, 5.649, 5.470, 5.678, 5.604, 5.545, 5.476, 5.542, 5.352, 5.639, 5.610, 5.284, 5.314, 5.332, 5.514, 5.701, 5.499, 5.480, 5.527, 5.302, 5.334, 5.719, 5.443, 5.333, 5.711, 5.427, 5.712, 5.440, 5.554, 5.506, 5.487, 5.418, 5.368, 5.656, 5.723, 5.282, 5.589, 5.353, 5.411, 5.255, 5.369, 5.520, 5.580, 5.327, 5.448, 5.717, 5.541, 5.278, 5.685, 5.557, 5.330, 5.425, 5.616, 5.346, 5.507, 5.431, 5.549, 5.404, 5.388, 5.329, 5.344, 5.696, 5.341, 5.627, 5.581, 5.593, 5.645, 5.364, 5.674, 5.357, 5.379, 5.692, 5.643, 5.518, 5.397, 5.266, 5.433, 5.538, 5.408, 5.290, 5.285, 5.417, 5.251, 5.256, 5.348, 5.528, 5.375, 5.633, 5.336, 5.632

40MHz Bandwidth

Radar SignalType	Waveform/Trial Number	Detection (%)	Limit (%)	Pass/Fail
Type 1A	15	100 %	60%	Pass
Type 1B	15	100%		
Type 2	30	100 %	60%	Pass
Type 3	30	100 %	60%	Pass
Type 4	30	100 %	60%	Pass
Aggregate (Type1 to 4)	120	100 %	80%	Pass
Type 5	30	96.7%	80%	Pass
Type 6	30	100 %	70%	Pass

Please refer to the following statistical tables:

Radar Type 1A Statistical Performance

Trial #	Fc (MHz)	Pulse/Burst	Pulse Width (µS)	PRI (µs)	Detection (1:yes; 0:no)
1	5510	18	1	3066	1
2	5510	89	1	598	1
3	5510	95	1	558	1
4	5510	92	1	578	1
5	5510	72	1	738	1
6	5510	65	1	818	1
7	5510	61	1	878	1
8	5510	76	1	698	1
9	5510	62	1	858	1
10	5510	70	1	758	1
11	5510	63	1	838	1
12	5510	58	1	918	1
13	5510	81	1	658	1
14	5510	83	1	638	1
15	5510	59	1	898	1
Detection Percentage: 100 % (>60%)					

Radar Type 1B Statistical Performance

Trial #	Fc (MHz)	Pulse/Burst	Pulse Width (µS)	PRI (µs)	Detection (1:yes; 0:no)
1	5510	31	1	1742	1
2	5510	24	1	2231	1
3	5510	86	1	617	1
4	5510	19	1	2852	1
5	5510	23	1	2388	1
6	5510	42	1	1256	1
7	5510	18	1	2979	1
8	5510	18	1	3003	1
9	5510	97	1	546	1
10	5510	21	1	2541	1
11	5510	25	1	2113	1
12	5510	18	1	2975	1
13	5510	27	1	1968	1
14	5510	22	1	2418	1
15	5510	23	1	2368	1
Detection Percentage: 100 % (>60%)					

Radar Type 2 Statistical Performance

Trial #	Fc (MHz)	Pulse/Burst	Pulse Width (μS)	PRI (μs)	Detection (1:yes; 0:no)
1	5510	28	2.8	155	1
2	5510	23	2.6	226	1
3	5510	25	1.7	226	1
4	5510	24	1.9	230	1
5	5510	28	2.7	213	1
6	5510	26	1	169	1
7	5510	25	2.8	227	1
8	5510	23	4.6	222	1
9	5510	28	4.6	230	1
10	5510	28	4.3	200	1
11	5510	28	1	199	1
12	5510	26	4.2	202	1
13	5510	26	3	152	1
14	5510	28	1.4	225	1
15	5510	26	3.2	219	1
16	5510	26	2.1	193	1
17	5510	26	2.1	166	1
18	5510	28	4	201	1
19	5510	25	1.7	185	1
20	5510	25	2	218	1
21	5510	23	3.6	161	1
22	5510	29	1.6	156	1
23	5510	27	2	165	1
24	5510	25	4.1	211	1
25	5510	24	1.8	150	1
26	5510	24	2.8	179	1
27	5510	25	4.5	221	1
28	5510	24	1.7	202	1
29	5510	27	3.9	170	1
30	5510	25	1.6	226	1
Detection Percentage: 100 % (>60%)					

Radar Type 3 Statistical Performance

Trial #	Fc (MHz)	Pulse/Burst	Pulse Width (µS)	PRI (µs)	Detection (1:yes; 0:no)
1	5510	18	6	469	1
2	5510	17	7	487	1
3	5510	17	9.2	428	1
4	5510	17	6.5	275	1
5	5510	17	9	295	1
6	5510	18	9.8	290	1
7	5510	17	8.3	279	1
8	5510	16	9.7	488	1
9	5510	16	7.6	267	1
10	5510	16	8.9	375	1
11	5510	16	7.9	367	1
12	5510	16	8.8	492	1
13	5510	18	6.6	492	1
14	5510	18	9.9	263	1
15	5510	17	7.5	347	1
16	5510	17	8.1	309	1
17	5510	16	7.2	402	1
18	5510	17	9.8	218	1
19	5510	16	6.2	258	1
20	5510	17	9.4	473	1
21	5510	17	9.5	424	1
22	5510	16	9.8	330	1
23	5510	17	6.5	341	1
24	5510	17	8	343	1
25	5510	17	7.6	409	1
26	5510	16	7.3	492	1
27	5510	16	8.3	237	1
28	5510	18	6.5	239	1
29	5510	17	6.8	321	1
30	5510	16	6.8	249	1
Detection Percentage: 100 % (>60%)					

Radar Type 4 Statistical Performance

Trial #	Fc (MHz)	Pulse/Burst	Pulse Width (μS)	PRI (μs)	Detection (1:yes; 0:no)
1	5510	15	13.5	450	1
2	5510	12	17.6	454	1
3	5510	12	17	495	1
4	5510	13	14.7	298	1
5	5510	13	18.8	404	1
6	5510	13	14.2	225	1
7	5510	14	11.8	369	1
8	5510	15	11.5	498	1
9	5510	14	16.5	441	1
10	5510	15	16.6	364	1
11	5510	14	15.3	237	1
12	5510	15	19.2	232	1
13	5510	14	15.2	387	1
14	5510	16	16	410	1
15	5510	14	16.3	464	1
16	5510	13	12.2	217	1
17	5510	13	14.7	325	1
18	5510	14	12	348	1
19	5510	12	15.4	374	1
20	5510	13	15.4	414	1
21	5510	13	17.4	374	1
22	5510	14	17.9	219	1
23	5510	16	11.7	382	1
24	5510	14	12.2	254	1
25	5510	13	11.2	495	1
26	5510	14	13.1	321	1
27	5510	15	15.1	296	1
28	5510	14	12.2	493	1
29	5510	13	11.2	290	1
30	5510	12	18.9	443	1
Detection Percentage: 100 % (>60%)					

Radar Type 5 Statistical Performance

Statistics 1 (ChirpCenter Frequency: 5510 MHz)

Trial #	Pulse	Chirp(MHz)	Pulse Width (µS)	Pulse 1-2 spacing(µS)	Pulse 2-3 spacing(µS)	Pulse Start(mS)	Detection (1:yes;0:no)
1	3	10	63.2	1720	1982	459.841	1
2	2	10	79.2	1650		14.083	
3	2	10	60.4	1507		516.266	
4	3	10	95.1	1973	1351	707.659	
5	2	10	85.3	1633		485.332	
6	2	10	65.9	1841		371.505	
7	2	10	75.7	1719		215.558	
8	2	10	87.8	1094		271.572	
9	2	10	82.7	1009		649.655	
10	2	10	56.9	1753		173.828	
11	2	10	94.4	1628		653.191	
12	2	10	90.6	1023		592.854	
13	1	10	80.1			206.677	

Statistics 2 (ChirpCenter Frequency: 5510 MHz)

Trial #	Pulse	Chirp(MHz)	Pulse Width (µS)	Pulse 1-2 spacing(µS)	Pulse 2-3 spacing(µS)	Pulse Start(mS)	Detection (1:yes;0:no)
1	3	9	64.9	1706	1914	424.815	1
2	2	9	87.5	1875		376.675	
3	2	9	63.3	1617		407.03	
4	3	9	80.1	1889	1703	525.39	
5	2	9	57.1	1381		154.16	
6	1	9	94.5			533.44	
7	3	9	90.9	1917	1441	463.86	
8	2	9	57.3	1342		436.56	
9	2	9	85.7	1566		247.64	
10	1	9	73.8			291.03	
11	3	9	59	1684	1923	407.93	
12	1	9	55.7			180.69	
13	2	9	59.4	1325		70.35	
14	3	9	93.2	1697	1608	145.24	
15	2	9	73.2	1272		2.26	
16	1	9	71.5			579.24	
17	2	9	52.3	1800		55.57	
18	1	9	89.8			84.9	
19	3	9	85.7	1053	1377	396.9	
20	2	9	81.2	1413		267	

Statistics 3 (ChirpCenter Frequency: 5510 MHz)

Trial #	Pulse	Chirp(MHz)	Pulse Width (µS)	Pulse 1-2 spacing(µS)	Pulse 2-3 spacing(µS)	Pulse Start(mS)	Detection (1:yes;0:no)
1	2	14	63.7	1347		166.207	1
2	2	14	70.2	1972		509.93	
3	3	14	63.6	1710	1208	582.36	
4	3	14	92.6	1593	1068	652.07	
5	1	14	74			306.85	
6	3	14	53	1398	1484	212.15	
7	3	14	73.3	1330	1783	8.43	
8	1	14	67.6			504.45	
9	3	14	80.1	1338	1771	399.89	
10	3	14	67.5	1640	1748	496.23	
11	2	14	54.9	1471		117.44	
12	2	14	81.4	1460		221.82	
13	2	14	60.1	1864		450.18	
14	2	14	84.9	1679		620.7	
15	3	14	55.7	1208	1275	296.7	
16	2	14	75.3	1625		593.3	

Statistics 4 (ChirpCenter Frequency: 5510 MHz)

Trial #	Pulse	Chirp(MHz)	Pulse Width (µS)	Pulse 1-2 spacing(µS)	Pulse 2-3 spacing(µS)	Pulse Start(mS)	Detection (1:yes;0:no)
1	1	11	76.2			530.986	1
2	2	11	86.5	1161		537.298	
3	1	11	72.9			555.545	
4	1	11	54.2			1.533	
5	1	11	85.6			342.901	
6	2	11	97.7	1748		341.168	
7	3	11	66.4	1677	1905	142.836	
8	3	11	89.2	1305	1440	114.424	
9	3	11	71.4	1002	1104	333.821	
10	2	11	73.2	1132		229.739	
11	1	11	54.5			658.146	
12	3	11	70.8	1513	1183	91.614	
13	1	11	51.1			257.772	
14	1	11	84.3			392.469	
15	2	11	69	1533		500.847	
16	2	11	81.1	1672		103.565	
17	2	11	55.4	1941		160.282	

Statistics 5 (ChirpCenter Frequency: 5510 MHz)

Trial #	Pulse	Chirp(MHz)	Pulse Width (µS)	Pulse 1-2 spacing(µS)	Pulse 2-3 spacing(µS)	Pulse Start(mS)	Detection (1:yes;0:no)
1	2	20	52.7	1333		667.599	1
2	3	20	67.2	1703	1652	456.648	
3	2	20	56.4	1027		221.945	
4	3	20	72.6	1861	1740	375.013	
5	2	20	92.7	1993		449.711	
6	1	20	64.4			526.018	
7	2	20	58.3	1271		71.436	
8	2	20	97.4	1305		16.674	
9	2	20	61.5	1096		633.731	
10	2	20	61.9	1941		330.299	
11	3	20	88.2	1955	1353	590.086	
12	1	20	71.3			639.694	
13	2	20	73.6	1801		513.302	
14	1	20	77.6			427.529	
15	1	20	74.4			312.547	
16	2	20	74.6	1069		458.565	
17	1	20	94.6			447.182	

Statistics 6 (ChirpCenter Frequency: 5510 MHz)

Trial #	Pulse	Chirp(MHz)	Pulse Width (µS)	Pulse 1-2 spacing(µS)	Pulse 2-3 spacing(µS)	Pulse Start(mS)	Detection (1:yes;0:no)
1	2	14	53.9	1502		15.225	1
2	2	14	52.4	1070		963.26	
3	2	14	97	1234		436.94	
4	3	14	64.3	1978	1771	957.44	
5	2	14	75.6	1066		413.19	
6	1	14	52.9			385.23	
7	1	14	71			888.27	
8	2	14	95.7	1634		162.09	
9	2	14	91.2	1241		146.15	
10	1	14	59.3			800.1	
11	2	14	68.5	1872		26.9	
12	2	14	64	1718		292.4	

Statistics 7 (ChirpCenter Frequency: 5510 MHz)

Trial #	Pulse	Chirp(MHz)	Pulse Width (µS)	Pulse 1-2 spacing(µS)	Pulse 2-3 spacing(µS)	Pulse Start(mS)	Detection (1:yes;0:no)
1	2	10	58	1489		649.557	1
2	1	10	72.7			122.84	
3	2	10	69.9	1066		830.65	
4	2	10	88.5	1614		990.7	
5	2	10	80.9	1888		954.36	
6	2	10	87.5	1441		344.41	
7	2	10	54.2	1692		616.84	
8	2	10	62.7	1714		921.06	
9	2	10	66.8	1644		672.72	
10	1	10	81.5			95.29	
11	3	10	66.2	1571	1558	159.4	
12	2	10	89.2	1597		931.1	

Statistics 8 (ChirpCenter Frequency: 5510 MHz)

Trial #	Pulse	Chirp(MHz)	Pulse Width (µS)	Pulse 1-2 spacing(µS)	Pulse 2-3 spacing(µS)	Pulse Start(mS)	Detection (1:yes;0:no)
1	2	20	64.8	1119		457.112	1
2	2	20	96.7	1442		522.173	
3	2	20	74.8	1933		601.527	
4	3	20	99.8	1007	1259	298.39	
5	2	20	80.6	1934		257.033	
6	2	20	72.3	1854		25.767	
7	2	20	79.1	1994		71.35	
8	2	20	87.9	1161		405.533	
9	1	20	68.1			632.537	
10	2	20	74.4	1554		513.51	
11	2	20	91.9	1550		249.643	
12	2	20	97.8	1549		206.417	
13	2	20	64.1	1353		232.12	
14	2	20	51.5	1576		131.093	
15	3	20	63.8	1591	1755	23.907	
16	3	20	52.3	1071	1759	463.4	
17	1	20	94.8			335.533	
18	2	20	65.4	1580		78.367	

Statistics 9 (ChirpCenter Frequency: 5510 MHz)

Trial #	Pulse	Chirp(MHz)	Pulse Width (μS)	Pulse 1-2 spacing(μS)	Pulse 2-3 spacing(μS)	Pulse Start(mS)	Detection (1:yes;0:no)
1	2	20	54.2	1869		535.154	1
2	1	20	85.4			252.817	
3	3	20	61	1122	1732	239.933	
4	1	20	80.3			194.23	
5	1	20	58.1			246.957	
6	2	20	92.5	1922		936.273	
7	3	20	59.3	1206	1103	1314	
8	2	20	59.6	1322		901.067	
9	1	20	68.1			782.733	

Statistics 10 (ChirpCenter Frequency: 5510 MHz)

Trial #	Pulse	Chirp(MHz)	Pulse Width (μS)	Pulse 1-2 spacing(μS)	Pulse 2-3 spacing(μS)	Pulse Start(mS)	Detection (1:yes;0:no)
1	2	8	63.6	1338		989.19	1
2	2	8	82.3	1210		300.801	
3	2	8	55.7	1244		589.342	
4	2	8	91.1	1057		890.893	
5	2	8	97.6	1872		446.984	
6	2	8	56.7	1479		409.525	
7	2	8	67.3	1847		1071.275	
8	1	8	62.4			661.696	
9	2	8	73.7	1397		3.807	
10	1	8	63.8			632.018	
11	2	8	55.8	1094		502.809	

Statistics 11 (ChirpCenter Frequency: 5496.4 MHz)

Trial #	Pulse	Chirp(MHz)	Pulse Width (µS)	Pulse 1-2 spacing(µS)	Pulse 2-3 spacing(µS)	Pulse Start(mS)	Detection (1:yes;0:no)
1	3	11	66.3	1310	1794	1.258	1
2	2	11	88.3	1343		57.864	
3	1	11	51.5			116.41	
4	3	11	53.8	1586	1664	146.75	
5	2	11	57.7	1645		219.62	
6	3	11	85.8	1237	1287	318.58	
7	2	11	86.8	1140		352.51	
8	3	11	87.1	1196	1439	103.61	
9	2	11	93.3	1152		195.51	
10	3	11	55.2	1130	1794	171.57	
11	1	11	91.6			515.8	
12	2	11	66	1756		51.14	
13	3	11	62.5	1851	1327	620.6	
14	3	11	73.3	1501	1013	370	
15	2	11	70.1	1804		100.2	

Statistics 12 (ChirpCenter Frequency: 5494.4 MHz)

Trial #	Pulse	Chirp(MHz)	Pulse Width (µS)	Pulse 1-2 spacing(µS)	Pulse 2-3 spacing(µS)	Pulse Start(mS)	Detection (1:yes;0:no)
1	3	6	51.3	1303	1886	332.173	1
2	3	6	83.2	1296	1294	385.573	
3	2	6	74.4	1045		184.787	
4	2	6	70.1	1768		245.75	
5	2	6	55.1	1952		433.093	
6	3	6	90.2	1881	1496	498.717	
7	1	6	77.7			23.15	
8	3	6	90.6	1656	1042	118.313	
9	2	6	64.3	1798		33.477	
10	2	6	58.4	1106		243.32	
11	2	6	91.7	1458		278.043	
12	2	6	78.1	1688		22.527	
13	1	6	58.1			448.61	
14	2	6	97.1	1394		650.753	
15	2	6	78.5	1633		233.377	
16	1	6	59.1			498.9	
17	2	6	88.4	1374		639.833	
18	3	6	78.2	1938	1121	481.967	

Statistics 13 (ChirpCenter Frequency: 5498.8 MHz)

Trial #	Pulse	Chirp(MHz)	Pulse Width (µS)	Pulse 1-2 spacing(µS)	Pulse 2-3 spacing(µS)	Pulse Start(mS)	Detection (1:yes;0:no)
1	3	17	64.9	1630	1818	917.986	1
2	2	17	81.6	1563		340.12	
3	2	17	56.9	1848		702.68	
4	2	17	54.6	1656		279.23	
5	3	17	79	1695	1697	715.69	
6	1	17	71.9			83.04	
7	2	17	60	1906		456.49	
8	1	17	76.3			337.71	
9	2	17	74.9	1612		923.83	
10	2	17	52.8	1773		896.3	
11	1	17	79.1			64.3	
12	1	17	53.3			910.8	

Statistics 14 (ChirpCenter Frequency: 5494.8 MHz)

Trial #	Pulse	Chirp(MHz)	Pulse Width (µS)	Pulse 1-2 spacing(µS)	Pulse 2-3 spacing(µS)	Pulse Start(mS)	Detection (1:yes;0:no)
1	1	7	57.8			631.667	1
2	1	7	64.9			786.22	
3	2	7	50.6	1206		553.62	
4	3	7	93.1	1442	1340	787.1	
5	2	7	91.4	1518		706.39	
6	2	7	61.3	1687		501.26	
7	2	7	100	1150		536.15	
8	2	7	77.6	1968		247.64	
9	1	7	67			712.25	
10	1	7	82.9			355.95	
11	3	7	91.7	1596	1431	478.29	
12	3	7	70.9	1027	1151	397.35	
13	2	7	56.1	1499		47.86	
14	2	7	98.5	1293		329.4	
15	2	7	93.6	1155		543.5	

Statistics 15 (ChirpCenter Frequency: 5500 MHz)

Trial #	Pulse	Chirp(MHz)	Pulse Width (µS)	Pulse 1-2 spacing(µS)	Pulse 2-3 spacing(µS)	Pulse Start(mS)	Detection (1:yes;0:no)
1	3	20	90.6	1943	1280	472.72	0
2	1	20	88			292.324	
3	2	20	62.2	1243		503.025	
4	2	20	52.4	1996		450.123	
5	2	20	65.4	1286		425.681	
6	3	20	78.7	1725	1533	8.468	
7	2	20	86.9	1059		38.456	
8	2	20	68.3	1436		410.024	
9	1	20	55.5			423.551	
10	2	20	85.8	1509		458.099	
11	2	20	90.1	1459		155.896	
12	3	20	70.6	1204	1334	346.214	
13	3	20	60.4	1080	1463	112.362	
14	2	20	55.4	1140		541.999	
15	3	20	68.8	1067	1050	353.347	
16	1	20	58			630.365	
17	3	20	59.3	1159	1521	665.482	

Statistics 16 (ChirpCenter Frequency: 5496.4 MHz)

Trial #	Pulse	Chirp(MHz)	Pulse Width (µS)	Pulse 1-2 spacing(µS)	Pulse 2-3 spacing(µS)	Pulse Start(mS)	Detection (1:yes;0:no)
1	3	11	83.7	1757	1967	95.953	1
2	2	11	72.8	1185		160.651	
3	2	11	70.8	1903		389.005	
4	1	11	63.7			109.333	
5	1	11	96.6			473.441	
6	2	11	56.5	1825		675.488	
7	3	11	95	1262	1702	115.076	
8	1	11	99.3			303.224	
9	2	11	96	1147		531.911	
10	2	11	88.8	1475		15.199	
11	2	11	92.3	1347		523.796	
12	3	11	86.7	1583	1777	481.474	
13	3	11	82.5	1951	1533	224.232	
14	2	11	74.8	1581		455.389	
15	1	11	85.6			130.347	
16	3	11	75	1074	1152	482.065	
17	2	11	57.4	1173		396.482	

Statistics 17 (ChirpCenter Frequency: 5499.2 MHz)

Trial #	Pulse	Chirp(MHz)	Pulse Width (μS)	Pulse 1-2 spacing(μS)	Pulse 2-3 spacing(μS)	Pulse Start(mS)	Detection (1:yes;0:no)
1	3	18	88.6	1959	1689	279.877	1
2	2	18	81	1899		19.7	
3	2	18	71.3	1189		1119.58	
4	2	18	78.6	1431		738.86	
5	2	18	90.8	1350		750.77	
6	1	18	92.9			1296.34	
7	3	18	62.4	1879	1930	1367.2	
8	2	18	67.6	1870		1141.2	

Statistics 18 (ChirpCenter Frequency: 5495.2 MHz)

Trial #	Pulse	Chirp(MHz)	Pulse Width (μS)	Pulse 1-2 spacing(μS)	Pulse 2-3 spacing(μS)	Pulse Start(mS)	Detection (1:yes;0:no)
1	2	8	57	1346		437.582	1
2	1	8	53.5			357.637	
3	3	8	68.9	1098	1595	199.704	
4	3	8	79.7	1531	1243	135.201	
5	2	8	84	1543		391.439	
6	3	8	73.2	1457	1640	7.706	
7	3	8	62.8	1119	1381	833.193	
8	2	8	96.2	1870		436.64	
9	2	8	56.6	1840		701.187	
10	1	8	85.1			116.724	
11	2	8	75.9	1725		182.741	
12	2	8	60.1	1745		272.009	
13	2	8	78	1220		33.786	
14	2	8	61.8	1559		257.743	

Statistics 19 (ChirpCenter Frequency: 5499.6 MHz)

Trial #	Pulse	Chirp(MHz)	Pulse Width (µS)	Pulse 1-2 spacing(µS)	Pulse 2-3 spacing(µS)	Pulse Start(mS)	Detection (1:yes;0:no)
1	2	19	96.7	1263		914.423	1
2	3	19	54.3	1021	1108	765.793	
3	1	19	78.9			840.716	
4	3	19	58.5	1374	1402	741.269	
5	1	19	82.3			180.502	
6	1	19	93.4			177.175	
7	2	19	50.7	1186		568.628	
8	2	19	92	1690		147.802	
9	2	19	71.3	1315		572.195	
10	2	19	70.1	1476		479.608	
11	1	19	98			371.661	
12	3	19	68.9	1856	1205	446.354	
13	3	19	74.2	1449	1112	630.677	

Statistics 20 (ChirpCenter Frequency: 5494.4 MHz)

Trial #	Pulse	Chirp(MHz)	Pulse Width (µS)	Pulse 1-2 spacing(µS)	Pulse 2-3 spacing(µS)	Pulse Start(mS)	Detection (1:yes;0:no)
1	1	6	96.6			698.125	1
2	3	6	72.3	1359	1626	953.8	
3	2	6	73.9	1841		933.98	
4	2	6	99.5	1462		713.56	
5	2	6	74.2	1992		745.69	
6	3	6	83.2	1934	1777	564.7	
7	2	6	85.3	1784		249.88	
8	3	6	71.5	1604	1616	802.98	
9	2	6	96.4	1409		917.5	
10	1	6	91.3			1139.6	

Statistics 21 (ChirpCenter Frequency: 5522.8 MHz)

Trial #	Pulse	Chirp(MHz)	Pulse Width (µS)	Pulse 1-2 spacing(µS)	Pulse 2-3 spacing(µS)	Pulse Start(mS)	Detection (1:yes;0:no)
1	2	13	58.8	1788		397.652	1
2	2	13	69.5	1787		601.247	
3	2	13	76.6	1915		480.683	
4	2	13	83.5	1725		72.27	
5	3	13	95.1	1349	1435	169.037	
6	1	13	80.2			1007.673	
7	2	13	84.7	1334		138.47	
8	3	13	52.7	1409	1014	521.537	
9	2	13	80.3	1216		306.333	

Statistics 22 (ChirpCenter Frequency: 5523.2 MHz)

Trial #	Pulse	Chirp(MHz)	Pulse Width (µS)	Pulse 1-2 spacing(µS)	Pulse 2-3 spacing(µS)	Pulse Start(mS)	Detection (1:yes;0:no)
1	1	12	91.7			188.923	1
2	1	12	65.3			323.71	
3	2	12	88	1797		148.35	
4	1	12	68.4			2.92	
5	3	12	62.3	1201	1755	404.83	
6	1	12	62.6			13.16	
7	1	12	81.2			188.27	
8	2	12	77.7	1297		193.48	
9	2	12	70.4	1868		294.83	
10	1	12	70.4			76.33	
11	2	12	53.3	1713		441.37	
12	1	12	83.2			80.07	
13	2	12	63.7	1785		147.36	
14	3	12	65.6	1499	1491	185.96	
15	2	12	70.3	1242		414.56	
16	3	12	80.6	1141	1009	397.42	
17	3	12	93.7	1487	1648	170.5	
18	3	12	57.7	1126	1233	257.7	
19	2	12	85.4	1102		440.6	
20	2	12	83.5	1408		235.6	

Statistics 23(ChirpCenter Frequency: 5520 MHz)

Trial #	Pulse	Chirp(MHz)	Pulse Width (µS)	Pulse 1-2 spacing(µS)	Pulse 2-3 spacing(µS)	Pulse Start(mS)	Detection (1:yes;0:no)
1	3	20	55.5	1686	1566	355.125	1
2	2	20	61.3	1876		68.532	
3	3	20	62.3	1199	1094	544.187	
4	1	20	69.6			484.37	
5	2	20	51.6	1793		512.953	
6	2	20	85.6	1120		213.157	
7	2	20	99	1682		299.81	
8	3	20	92.2	1813	1723	145.733	
9	2	20	94.1	1714		148.787	
10	2	20	58.6	1212		16.12	
11	1	20	69.6			8.963	
12	2	20	66.5	1436		659.467	
13	3	20	79.7	1291	1786	131.23	
14	3	20	77.4	1495	1959	435.163	
15	1	20	88.3			502.237	
16	2	20	99.3	1134		203	
17	2	20	73.5	1291		484.433	
18	2	20	73.1	1563		68.967	

Statistics 24(ChirpCenter Frequency: 5522 MHz)

Trial #	Pulse	Chirp(MHz)	Pulse Width (µS)	Pulse 1-2 spacing(µS)	Pulse 2-3 spacing(µS)	Pulse Start(mS)	Detection (1:yes;0:no)
1	3	15	92.5	1445	1031	348.413	1
2	3	15	95.7	1689	1503	334.964	
3	2	15	69.6	1683		363.73	
4	2	15	54.7	1540		424.33	
5	2	15	58.4	1512		257.93	
6	3	15	53.2	1865	1339	265.3	
7	2	15	76.5	1551		195.23	
8	2	15	68.9	1809		105.05	
9	3	15	82.2	1142	1179	490.69	
10	1	15	99.3			33.72	
11	2	15	54.1	1165		159.81	
12	1	15	96.3			387.67	
13	1	15	98.7			260.35	
14	2	15	73.8	1829		440.6	
15	3	15	78.5	1964	1630	481.44	
16	2	15	60.9	1797		130.44	
17	1	15	81.5			286.97	
18	2	15	59.3	1144		97.7	
19	1	15	99.2			335.2	
20	3	15	86.6	1079	1883	438.4	

Statistics 25(ChirpCenter Frequency: 5526 MHz)

Trial #	Pulse	Chirp(MHz)	Pulse Width (µS)	Pulse 1-2 spacing(µS)	Pulse 2-3 spacing(µS)	Pulse Start(mS)	Detection (1:yes;0:no)
1	3	5	96.1	1703	1847	773.346	1
2	3	5	54.6	1976	1752	429.453	
3	3	5	98	1251	1772	131.266	
4	1	5	69.5			30.989	
5	2	5	79	1091		499.242	
6	2	5	81.8	1510		182.215	
7	3	5	70.7	1644	1643	222.548	
8	3	5	51.8	1020	1962	566.782	
9	2	5	55.9	1008		253.255	
10	2	5	58.2	1241		453.788	
11	3	5	69.7	1016	1886	403.671	
12	1	5	60.2			74.454	
13	2	5	74.8	1367		673.577	

Statistics 26 (ChirpCenter Frequency: 5520.8 MHz)

Trial #	Pulse	Chirp(MHz)	Pulse Width (µS)	Pulse 1-2 spacing(µS)	Pulse 2-3 spacing(µS)	Pulse Start(mS)	Detection (1:yes;0:no)
1	3	18	66.3	1183	1583	201.457	1
2	3	18	52.2	1593	1325	418.25	
3	2	18	91.9	1418		459.88	
4	1	18	53.6			669.15	
5	2	18	80.6	1464		135.99	
6	1	18	78.3			296.25	
7	3	18	68	1738	1549	99.58	
8	2	18	76.4	1125		920.46	
9	2	18	70.7	1975		636.92	
10	2	18	51.5	1959		664.1	
11	2	18	85.9	1447		907.5	
12	2	18	91.4	1813		345.2	

Statistics 27 (ChirpCenter Frequency: 5521.2 MHz)

Trial #	Pulse	Chirp(MHz)	Pulse Width (µS)	Pulse 1-2 spacing(µS)	Pulse 2-3 spacing(µS)	Pulse Start(mS)	Detection (1:yes;0:no)
1	2	17	63.6	1570		579.701	1
2	3	17	91.6	1957	1434	467.611	
3	3	17	81.1	1993	1598	451.622	
4	3	17	90	1091	1877	405.603	
5	1	17	62.1			0.014	
6	2	17	76	1970		364.505	
7	1	17	95.1			251.596	
8	2	17	68.3	1533		345.017	
9	1	17	88.7			96.798	
10	2	17	78.9	1447		511.599	
11	2	17	77.7	1463		288.521	
12	1	17	66.5			191.312	
13	1	17	68.8			422.443	
14	2	17	92.8	1074		294.834	
15	1	17	77.3			161.405	
16	2	17	88.3	1325		185.816	
17	1	17	50.3			25.237	
18	1	17	92.2			83.158	
19	3	17	70.3	1162	1389	168.679	

Statistics 28 (ChirpCenter Frequency: 5524.8 MHz)

Trial #	Pulse	Chirp(MHz)	Pulse Width (µS)	Pulse 1-2 spacing(µS)	Pulse 2-3 spacing(µS)	Pulse Start(mS)	Detection (1:yes;0:no)
1	2	8	88.3	1523		260.114	1
2	2	8	83.1	1889		646.398	
3	2	8	90.4	1368		659.605	
4	2	8	74.3	1810		367.213	
5	2	8	82.3	1712		697.841	
6	3	8	81.6	1648	1894	29.798	
7	3	8	54.2	1833	1431	111.936	
8	1	8	69.6			219.654	
9	2	8	63.4	1899		59.111	
10	1	8	78.4			531.349	
11	2	8	85	1097		30.176	
12	1	8	70.8			553.104	
13	2	8	50.1	1255		86.852	
14	1	8	57.9			221.479	
15	3	8	66.8	1241	1822	358.147	
16	1	8	69.2			337.965	
17	2	8	89	1801		690.182	

Statistics 29 (ChirpCenter Frequency: 5520.4 MHz)

Trial #	Pulse	Chirp(MHz)	Pulse Width (µS)	Pulse 1-2 spacing(µS)	Pulse 2-3 spacing(µS)	Pulse Start(mS)	Detection (1:yes;0:no)
1	3	19	60.5	1371	1174	903.957	1
2	3	19	60.6	1756	1631	1059.231	
3	3	19	93.6	1828	1012	929.212	
4	3	19	75	1030	1288	854.603	
5	3	19	85.9	1964	1378	799.014	
6	2	19	82.8	1282		712.225	
7	2	19	98.9	1008		667.815	
8	3	19	92.6	1507	1479	717.896	
9	1	19	80.6			354.967	
10	2	19	79.2	1254		262.918	
11	2	19	61.4	1224		393.209	

Statistics 30 (ChirpCenter Frequency: 5523.6 MHz)

Trial #	Pulse	Chirp(MHz)	Pulse Width (µS)	Pulse 1-2 spacing(µS)	Pulse 2-3 spacing(µS)	Pulse Start(mS)	Detection (1:yes;0:no)
1	2	11	90.7	1412		105.494	1
2	1	11	73			509.9	
3	2	11	60.4	1486		585.41	
4	2	11	68.4	1420		282.56	
5	2	11	53.4	1890		701.2	
6	3	11	97.6	1851	1765	491.01	
7	2	11	56.3	1995		133.13	
8	1	11	91.2			313.95	
9	3	11	80	1185	1489	128.23	
10	1	11	71.5			632.34	
11	3	11	61	1499	1388	660.17	
12	2	11	73	1510		365.63	
13	3	11	62.5	1933	1187	195.37	
14	2	11	96	1508		695.3	
15	3	11	94.1	1062	1156	502.7	
16	3	11	79.4	1218	1980	75.7	

Radar Type 6 Statistical Performance

Trial #	Fc (MHz)	Pulse /Burst	Pulse Width (µS)	PRI (µs)	Detection (1:yes; 0:no)	Hopping Sequence (GHz)
1	5510	9	1	333	1	5.362, 5.697, 5.284, 5.582, 5.309, 5.550, 5.685, 5.267, 5.686, 5.470, 5.436, 5.476, 5.289, 5.363, 5.672, 5.537, 5.471, 5.690, 5.463, 5.360, 5.663, 5.334, 5.250, 5.641, 5.571, 5.634, 5.667, 5.692, 5.356, 5.264, 5.544, 5.719, 5.370, 5.415, 5.496, 5.265, 5.509, 5.535, 5.460, 5.510, 5.365, 5.352, 5.425, 5.349, 5.401, 5.384, 5.273, 5.691, 5.372, 5.553, 5.637, 5.272, 5.499, 5.338, 5.721, 5.439, 5.364, 5.696, 5.640, 5.386, 5.409, 5.612, 5.524, 5.593, 5.523, 5.373, 5.388, 5.500, 5.422, 5.304, 5.345, 5.406, 5.490, 5.528, 5.591, 5.260, 5.257, 5.702, 5.502, 5.568, 5.283, 5.417, 5.298, 5.300, 5.423, 5.644, 5.598, 5.519, 5.709, 5.707, 5.534, 5.323, 5.342, 5.507, 5.293, 5.387, 5.503, 5.708, 5.412, 5.682
2	5510	9	1	333	1	5.304, 5.504, 5.266, 5.375, 5.712, 5.346, 5.416, 5.682, 5.264, 5.257, 5.660, 5.524, 5.438, 5.469, 5.280, 5.322, 5.675, 5.260, 5.376, 5.373, 5.477, 5.310, 5.569, 5.502, 5.613, 5.641, 5.607, 5.399, 5.374, 5.325, 5.588, 5.485, 5.379, 5.533, 5.384, 5.333, 5.383, 5.535, 5.458, 5.308, 5.511, 5.559, 5.637, 5.643, 5.670, 5.610, 5.387, 5.529, 5.412, 5.614, 5.560, 5.450, 5.429, 5.447, 5.500, 5.534, 5.590, 5.468, 5.591, 5.679, 5.284, 5.708, 5.632, 5.261, 5.467, 5.713, 5.324, 5.659, 5.714, 5.517, 5.548, 5.388, 5.430, 5.272, 5.286, 5.319, 5.454, 5.585, 5.715, 5.341, 5.482, 5.493, 5.397, 5.303, 5.557, 5.411, 5.701, 5.703, 5.274, 5.509, 5.656, 5.623, 5.522, 5.654, 5.445, 5.343, 5.258, 5.410, 5.298, 5.556
3	5510	9	1	333	1	5.304, 5.331, 5.421, 5.529, 5.445, 5.452, 5.372, 5.338, 5.527, 5.515, 5.518, 5.625, 5.502, 5.430, 5.665, 5.264, 5.566, 5.319, 5.557, 5.534, 5.713, 5.719, 5.341, 5.490, 5.422, 5.495, 5.576, 5.301, 5.595, 5.382, 5.682, 5.522, 5.678, 5.427, 5.584, 5.715, 5.708, 5.435, 5.575, 5.697, 5.723, 5.405, 5.360, 5.470, 5.609, 5.526, 5.692, 5.467, 5.614, 5.269, 5.302, 5.567, 5.630, 5.724, 5.666, 5.453, 5.359, 5.374, 5.519, 5.406, 5.414, 5.252, 5.335, 5.393, 5.257, 5.391, 5.607, 5.500, 5.530, 5.352, 5.604, 5.449, 5.250, 5.450, 5.432, 5.598, 5.436, 5.277, 5.425, 5.655, 5.369, 5.290, 5.627, 5.569, 5.586, 5.643, 5.468, 5.626, 5.624, 5.644, 5.662, 5.558, 5.379, 5.444, 5.637, 5.294, 5.487, 5.669, 5.690, 5.481
4	5510	9	1	333	1	5.431, 5.516, 5.458, 5.569, 5.285, 5.678, 5.550, 5.403, 5.322, 5.554, 5.384, 5.486, 5.493, 5.609, 5.657, 5.387, 5.254, 5.506,

						5.718, 5.315, 5.640, 5.596, 5.292, 5.698, 5.356, 5.261, 5.423, 5.538, 5.400, 5.577, 5.258, 5.510, 5.565, 5.290, 5.709, 5.662, 5.531, 5.522, 5.476, 5.295, 5.672, 5.328, 5.372, 5.523, 5.561, 5.514, 5.526, 5.471, 5.485, 5.649, 5.576, 5.677, 5.654, 5.537, 5.614, 5.351, 5.663, 5.540, 5.710, 5.612, 5.699, 5.291, 5.652, 5.627, 5.631, 5.413, 5.594, 5.385, 5.686, 5.408, 5.683, 5.708, 5.706, 5.390, 5.420, 5.425, 5.571, 5.441, 5.402, 5.301, 5.500, 5.622, 5.490, 5.359, 5.604, 5.541, 5.687, 5.591, 5.255, 5.371, 5.695, 5.277, 5.615, 5.719, 5.440, 5.415, 5.405, 5.276, 5.340, 5.481
5	5510	9	1	333	1	5.446, 5.260, 5.583, 5.493, 5.448, 5.500, 5.275, 5.478, 5.599, 5.681, 5.499, 5.380, 5.559, 5.678, 5.601, 5.617, 5.262, 5.453, 5.282, 5.521, 5.429, 5.706, 5.267, 5.285, 5.485, 5.253, 5.482, 5.402, 5.600, 5.593, 5.327, 5.707, 5.557, 5.398, 5.558, 5.636, 5.604, 5.354, 5.580, 5.333, 5.479, 5.509, 5.563, 5.591, 5.306, 5.522, 5.628, 5.567, 5.491, 5.408, 5.612, 5.307, 5.347, 5.572, 5.270, 5.629, 5.670, 5.624, 5.290, 5.710, 5.252, 5.677, 5.434, 5.722, 5.639, 5.289, 5.598, 5.469, 5.573, 5.279, 5.531, 5.663, 5.328, 5.618, 5.515, 5.284, 5.319, 5.587, 5.562, 5.536, 5.441, 5.358, 5.520, 5.451, 5.300, 5.389, 5.269, 5.348, 5.561, 5.442, 5.626, 5.646, 5.657, 5.332, 5.642, 5.334, 5.713, 5.312, 5.314, 5.295
6	5510	9	1	333	1	5.342, 5.324, 5.279, 5.706, 5.651, 5.514, 5.598, 5.565, 5.641, 5.662, 5.364, 5.457, 5.582, 5.370, 5.302, 5.484, 5.555, 5.586, 5.693, 5.587, 5.379, 5.308, 5.444, 5.331, 5.463, 5.542, 5.577, 5.358, 5.303, 5.363, 5.437, 5.263, 5.280, 5.377, 5.597, 5.271, 5.453, 5.307, 5.295, 5.459, 5.345, 5.499, 5.563, 5.458, 5.614, 5.272, 5.281, 5.621, 5.648, 5.538, 5.292, 5.721, 5.448, 5.322, 5.615, 5.432, 5.640, 5.558, 5.367, 5.296, 5.314, 5.285, 5.643, 5.485, 5.494, 5.520, 5.428, 5.570, 5.411, 5.698, 5.650, 5.381, 5.472, 5.681, 5.669, 5.398, 5.503, 5.578, 5.264, 5.691, 5.707, 5.635, 5.434, 5.258, 5.498, 5.265, 5.440, 5.290, 5.608, 5.483, 5.429, 5.616, 5.623, 5.626, 5.509, 5.366, 5.561, 5.568, 5.661, 5.336
7	5510	9	1	333	1	5.475, 5.566, 5.510, 5.654, 5.559, 5.309, 5.313, 5.357, 5.659, 5.414, 5.567, 5.687, 5.680, 5.429, 5.658, 5.653, 5.628, 5.648, 5.602, 5.708, 5.551, 5.482, 5.381, 5.595, 5.355, 5.349, 5.529, 5.392, 5.290, 5.492, 5.635, 5.300, 5.643, 5.516, 5.545, 5.535, 5.538, 5.399, 5.649, 5.498, 5.304, 5.376, 5.462, 5.549, 5.520, 5.646, 5.372, 5.619, 5.570, 5.517, 5.676, 5.449, 5.294, 5.531, 5.431, 5.306, 5.605, 5.720, 5.327, 5.308, 5.688, 5.384, 5.448, 5.626, 5.473, 5.366, 5.440, 5.296, 5.451, 5.432, 5.319, 5.664,

						5.397, 5.524, 5.666, 5.477, 5.674, 5.272, 5.371, 5.665, 5.351, 5.317, 5.675, 5.583, 5.340, 5.415, 5.598, 5.623, 5.271, 5.438, 5.721, 5.487, 5.501, 5.679, 5.639, 5.275, 5.698, 5.386, 5.717, 5.278
8	5510	9	1	333	1	5.663, 5.543, 5.627, 5.428, 5.363, 5.535, 5.478, 5.387, 5.459, 5.684, 5.675, 5.451, 5.487, 5.619, 5.351, 5.271, 5.302, 5.554, 5.579, 5.426, 5.508, 5.285, 5.411, 5.524, 5.303, 5.688, 5.466, 5.490, 5.343, 5.532, 5.565, 5.587, 5.465, 5.371, 5.321, 5.352, 5.486, 5.467, 5.613, 5.678, 5.424, 5.325, 5.402, 5.539, 5.582, 5.567, 5.265, 5.334, 5.470, 5.261, 5.267, 5.382, 5.464, 5.702, 5.530, 5.338, 5.548, 5.449, 5.439, 5.379, 5.423, 5.264, 5.630, 5.316, 5.529, 5.601, 5.358, 5.713, 5.361, 5.621, 5.429, 5.333, 5.415, 5.533, 5.275, 5.615, 5.505, 5.592, 5.440, 5.354, 5.345, 5.297, 5.605, 5.427, 5.721, 5.392, 5.719, 5.576, 5.495, 5.643, 5.666, 5.274, 5.506, 5.683, 5.724, 5.432, 5.536, 5.346, 5.310, 5.365
9	5510	9	1	333	1	5.294, 5.387, 5.475, 5.473, 5.556, 5.339, 5.625, 5.612, 5.517, 5.429, 5.467, 5.589, 5.714, 5.591, 5.568, 5.498, 5.304, 5.275, 5.423, 5.362, 5.342, 5.485, 5.681, 5.472, 5.358, 5.613, 5.648, 5.488, 5.694, 5.634, 5.355, 5.373, 5.645, 5.453, 5.479, 5.638, 5.266, 5.347, 5.656, 5.400, 5.528, 5.689, 5.384, 5.320, 5.398, 5.709, 5.539, 5.395, 5.679, 5.524, 5.451, 5.655, 5.413, 5.608, 5.290, 5.454, 5.715, 5.582, 5.661, 5.299, 5.408, 5.274, 5.460, 5.468, 5.307, 5.359, 5.428, 5.664, 5.462, 5.491, 5.291, 5.435, 5.332, 5.431, 5.351, 5.444, 5.492, 5.457, 5.535, 5.611, 5.544, 5.376, 5.487, 5.543, 5.668, 5.437, 5.552, 5.562, 5.478, 5.569, 5.576, 5.416, 5.548, 5.278, 5.501, 5.305, 5.318, 5.380, 5.418, 5.432
10	5510	9	1	333	1	5.289, 5.506, 5.405, 5.327, 5.657, 5.637, 5.513, 5.447, 5.332, 5.412, 5.523, 5.595, 5.547, 5.436, 5.716, 5.549, 5.631, 5.428, 5.462, 5.518, 5.570, 5.282, 5.676, 5.399, 5.503, 5.557, 5.683, 5.635, 5.609, 5.422, 5.542, 5.359, 5.325, 5.620, 5.576, 5.307, 5.377, 5.366, 5.476, 5.567, 5.675, 5.535, 5.594, 5.492, 5.644, 5.639, 5.276, 5.601, 5.562, 5.488, 5.721, 5.300, 5.531, 5.677, 5.660, 5.525, 5.577, 5.559, 5.553, 5.442, 5.699, 5.481, 5.604, 5.258, 5.494, 5.686, 5.364, 5.253, 5.262, 5.354, 5.551, 5.400, 5.658, 5.259, 5.571, 5.349, 5.603, 5.393, 5.580, 5.305, 5.383, 5.606, 5.623, 5.622, 5.272, 5.360, 5.263, 5.471, 5.304, 5.510, 5.313, 5.597, 5.334, 5.449, 5.584, 5.591, 5.266, 5.704, 5.625, 5.656
11	5510	9	1	333	1	5.491, 5.309, 5.720, 5.333, 5.552, 5.495, 5.326, 5.344, 5.545, 5.453, 5.286, 5.470, 5.356, 5.423, 5.488, 5.611, 5.513, 5.405, 5.460, 5.414, 5.267, 5.397, 5.374, 5.323,

						5.408, 5.654, 5.561, 5.674, 5.570, 5.671, 5.390, 5.592, 5.426, 5.329, 5.534, 5.617, 5.566, 5.412, 5.633, 5.602, 5.404, 5.292, 5.334, 5.483, 5.464, 5.528, 5.501, 5.620, 5.573, 5.660, 5.457, 5.320, 5.497, 5.302, 5.526, 5.558, 5.303, 5.683, 5.291, 5.482, 5.669, 5.325, 5.644, 5.557, 5.572, 5.700, 5.576, 5.533, 5.475, 5.565, 5.269, 5.420, 5.542, 5.417, 5.506, 5.679, 5.377, 5.277, 5.363, 5.687, 5.342, 5.562, 5.260, 5.250, 5.331, 5.551, 5.456, 5.447, 5.530, 5.531, 5.494, 5.579, 5.299, 5.596, 5.547, 5.366, 5.618, 5.650, 5.626, 5.648
12	5510	9	1	333	1	5.348, 5.382, 5.650, 5.433, 5.653, 5.444, 5.651, 5.327, 5.709, 5.620, 5.524, 5.411, 5.363, 5.376, 5.360, 5.428, 5.478, 5.294, 5.315, 5.576, 5.381, 5.402, 5.475, 5.310, 5.340, 5.344, 5.563, 5.276, 5.418, 5.614, 5.391, 5.588, 5.640, 5.578, 5.622, 5.516, 5.422, 5.265, 5.439, 5.388, 5.359, 5.497, 5.455, 5.313, 5.685, 5.534, 5.496, 5.708, 5.674, 5.406, 5.421, 5.498, 5.336, 5.362, 5.297, 5.544, 5.642, 5.539, 5.566, 5.593, 5.440, 5.585, 5.719, 5.575, 5.681, 5.635, 5.561, 5.541, 5.546, 5.258, 5.457, 5.480, 5.536, 5.702, 5.262, 5.519, 5.426, 5.485, 5.501, 5.408, 5.334, 5.586, 5.555, 5.531, 5.261, 5.646, 5.484, 5.607, 5.273, 5.256, 5.284, 5.689, 5.572, 5.338, 5.292, 5.636, 5.415, 5.436, 5.320, 5.266
13	5510	9	1	333	1	5.652, 5.646, 5.577, 5.623, 5.466, 5.437, 5.616, 5.310, 5.290, 5.457, 5.545, 5.382, 5.469, 5.440, 5.539, 5.298, 5.639, 5.405, 5.430, 5.719, 5.431, 5.366, 5.438, 5.462, 5.307, 5.413, 5.598, 5.655, 5.566, 5.613, 5.513, 5.309, 5.582, 5.318, 5.558, 5.690, 5.384, 5.393, 5.449, 5.596, 5.707, 5.329, 5.555, 5.550, 5.698, 5.444, 5.346, 5.692, 5.656, 5.597, 5.347, 5.544, 5.394, 5.303, 5.571, 5.644, 5.412, 5.377, 5.704, 5.446, 5.530, 5.527, 5.579, 5.277, 5.342, 5.700, 5.556, 5.665, 5.617, 5.714, 5.535, 5.676, 5.574, 5.270, 5.368, 5.304, 5.486, 5.266, 5.686, 5.492, 5.258, 5.619, 5.370, 5.645, 5.569, 5.414, 5.496, 5.546, 5.378, 5.330, 5.637, 5.254, 5.474, 5.651, 5.588, 5.561, 5.548, 5.271, 5.592, 5.606
14	5510	9	1	333	1	5.414, 5.282, 5.404, 5.470, 5.416, 5.511, 5.554, 5.397, 5.359, 5.606, 5.267, 5.564, 5.716, 5.537, 5.463, 5.391, 5.509, 5.413, 5.308, 5.436, 5.398, 5.541, 5.629, 5.377, 5.345, 5.613, 5.631, 5.423, 5.260, 5.505, 5.582, 5.705, 5.591, 5.712, 5.453, 5.546, 5.268, 5.648, 5.252, 5.270, 5.530, 5.695, 5.259, 5.311, 5.472, 5.455, 5.438, 5.350, 5.343, 5.330, 5.298, 5.512, 5.356, 5.593, 5.639, 5.357, 5.426, 5.294, 5.266, 5.676, 5.644, 5.638, 5.428, 5.544, 5.478, 5.504, 5.599, 5.516, 5.373, 5.670, 5.658, 5.400, 5.556, 5.538, 5.337, 5.374, 5.296, 5.718,

						5.587, 5.526, 5.584, 5.633, 5.723, 5.440, 5.614, 5.471, 5.469, 5.389, 5.561, 5.272, 5.702, 5.661, 5.621, 5.429, 5.572, 5.375, 5.503, 5.406, 5.559, 5.519
15	5510	9	1	333	1	5.283, 5.390, 5.358, 5.515, 5.336, 5.379, 5.630, 5.716, 5.602, 5.287, 5.285, 5.361, 5.410, 5.580, 5.429, 5.427, 5.274, 5.570, 5.543, 5.438, 5.507, 5.670, 5.642, 5.494, 5.676, 5.579, 5.254, 5.701, 5.299, 5.476, 5.343, 5.668, 5.638, 5.338, 5.296, 5.678, 5.505, 5.331, 5.318, 5.711, 5.522, 5.290, 5.704, 5.272, 5.673, 5.724, 5.351, 5.573, 5.473, 5.401, 5.542, 5.707, 5.694, 5.407, 5.471, 5.316, 5.627, 5.356, 5.687, 5.463, 5.435, 5.721, 5.614, 5.536, 5.686, 5.598, 5.619, 5.294, 5.592, 5.566, 5.391, 5.436, 5.682, 5.517, 5.621, 5.535, 5.426, 5.314, 5.649, 5.460, 5.520, 5.383, 5.695, 5.569, 5.381, 5.347, 5.700, 5.425, 5.633, 5.434, 5.300, 5.595, 5.525, 5.394, 5.641, 5.698, 5.276, 5.664, 5.685, 5.354
16	5510	9	1	333	1	5.692, 5.457, 5.556, 5.570, 5.493, 5.442, 5.571, 5.709, 5.472, 5.566, 5.681, 5.475, 5.633, 5.486, 5.398, 5.369, 5.446, 5.584, 5.579, 5.583, 5.504, 5.710, 5.646, 5.703, 5.465, 5.290, 5.492, 5.535, 5.359, 5.468, 5.279, 5.679, 5.333, 5.664, 5.257, 5.581, 5.462, 5.547, 5.517, 5.403, 5.288, 5.717, 5.306, 5.421, 5.319, 5.278, 5.439, 5.551, 5.476, 5.490, 5.256, 5.526, 5.508, 5.310, 5.595, 5.445, 5.408, 5.423, 5.580, 5.360, 5.426, 5.456, 5.289, 5.512, 5.515, 5.417, 5.628, 5.365, 5.364, 5.372, 5.690, 5.590, 5.680, 5.510, 5.366, 5.562, 5.641, 5.351, 5.541, 5.297, 5.587, 5.523, 5.712, 5.291, 5.675, 5.448, 5.694, 5.412, 5.295, 5.463, 5.317, 5.341, 5.502, 5.488, 5.634, 5.452, 5.388, 5.560, 5.361, 5.540
17	5510	9	1	333	1	5.544, 5.596, 5.553, 5.385, 5.606, 5.518, 5.623, 5.644, 5.370, 5.611, 5.484, 5.393, 5.512, 5.690, 5.481, 5.354, 5.677, 5.700, 5.330, 5.478, 5.410, 5.514, 5.359, 5.388, 5.608, 5.417, 5.446, 5.519, 5.715, 5.347, 5.489, 5.559, 5.591, 5.334, 5.555, 5.407, 5.331, 5.643, 5.304, 5.365, 5.358, 5.567, 5.599, 5.577, 5.301, 5.367, 5.617, 5.429, 5.610, 5.580, 5.302, 5.402, 5.607, 5.480, 5.594, 5.463, 5.513, 5.657, 5.398, 5.493, 5.585, 5.252, 5.704, 5.457, 5.277, 5.265, 5.399, 5.500, 5.450, 5.584, 5.414, 5.637, 5.273, 5.337, 5.651, 5.312, 5.672, 5.569, 5.566, 5.428, 5.333, 5.364, 5.706, 5.501, 5.573, 5.458, 5.349, 5.295, 5.292, 5.636, 5.406, 5.280, 5.262, 5.669, 5.472, 5.511, 5.571, 5.696, 5.600, 5.327
18	5510	9	1	333	1	5.382, 5.459, 5.473, 5.540, 5.354, 5.332, 5.446, 5.638, 5.338, 5.384, 5.526, 5.496, 5.304, 5.316, 5.350, 5.551, 5.539, 5.639, 5.606, 5.361, 5.520, 5.331, 5.327, 5.374, 5.293, 5.260, 5.413, 5.481, 5.303, 5.721,

						5.546, 5.498, 5.615, 5.602, 5.397, 5.418, 5.428, 5.577, 5.673, 5.579, 5.339, 5.287, 5.605, 5.693, 5.495, 5.642, 5.666, 5.501, 5.543, 5.632, 5.616, 5.552, 5.716, 5.344, 5.628, 5.517, 5.423, 5.295, 5.376, 5.589, 5.375, 5.489, 5.360, 5.367, 5.447, 5.265, 5.612, 5.530, 5.556, 5.654, 5.668, 5.675, 5.404, 5.386, 5.717, 5.573, 5.478, 5.665, 5.572, 5.506, 5.341, 5.291, 5.322, 5.419, 5.274, 5.570, 5.311, 5.271, 5.487, 5.672, 5.533, 5.359, 5.649, 5.700, 5.578, 5.351, 5.715, 5.432, 5.611, 5.346
19	5510	9	1	333	1	5.527, 5.619, 5.431, 5.287, 5.495, 5.386, 5.316, 5.250, 5.602, 5.440, 5.456, 5.326, 5.285, 5.451, 5.284, 5.625, 5.632, 5.587, 5.438, 5.261, 5.514, 5.418, 5.566, 5.329, 5.716, 5.333, 5.254, 5.530, 5.309, 5.453, 5.389, 5.458, 5.532, 5.523, 5.636, 5.279, 5.582, 5.407, 5.311, 5.704, 5.345, 5.655, 5.377, 5.304, 5.399, 5.290, 5.669, 5.441, 5.598, 5.398, 5.491, 5.662, 5.675, 5.350, 5.361, 5.388, 5.612, 5.639, 5.332, 5.282, 5.425, 5.629, 5.439, 5.330, 5.547, 5.450, 5.580, 5.395, 5.391, 5.360, 5.630, 5.571, 5.685, 5.596, 5.265, 5.264, 5.681, 5.348, 5.513, 5.644, 5.680, 5.445, 5.339, 5.349, 5.255, 5.457, 5.522, 5.430, 5.487, 5.325, 5.454, 5.370, 5.568, 5.670, 5.601, 5.301, 5.635, 5.534, 5.701, 5.508
20	5510	9	1	333	1	5.689, 5.378, 5.636, 5.486, 5.510, 5.536, 5.269, 5.570, 5.313, 5.702, 5.607, 5.685, 5.476, 5.644, 5.294, 5.576, 5.452, 5.660, 5.671, 5.450, 5.432, 5.595, 5.436, 5.508, 5.460, 5.523, 5.606, 5.500, 5.251, 5.395, 5.646, 5.374, 5.509, 5.417, 5.578, 5.506, 5.305, 5.604, 5.397, 5.551, 5.550, 5.710, 5.700, 5.650, 5.651, 5.379, 5.626, 5.389, 5.565, 5.426, 5.706, 5.323, 5.412, 5.343, 5.279, 5.282, 5.482, 5.429, 5.434, 5.492, 5.480, 5.481, 5.303, 5.514, 5.538, 5.256, 5.537, 5.443, 5.697, 5.589, 5.415, 5.544, 5.345, 5.519, 5.587, 5.667, 5.542, 5.254, 5.329, 5.300, 5.722, 5.295, 5.642, 5.630, 5.459, 5.337, 5.297, 5.344, 5.335, 5.413, 5.355, 5.657, 5.401, 5.427, 5.634, 5.590, 5.253, 5.709, 5.577, 5.599
21	5510	9	1	333	1	5.304, 5.353, 5.394, 5.486, 5.670, 5.420, 5.548, 5.356, 5.632, 5.431, 5.512, 5.301, 5.605, 5.423, 5.479, 5.704, 5.698, 5.352, 5.452, 5.354, 5.473, 5.450, 5.681, 5.540, 5.416, 5.570, 5.347, 5.340, 5.362, 5.556, 5.550, 5.652, 5.644, 5.717, 5.692, 5.256, 5.254, 5.603, 5.589, 5.543, 5.329, 5.579, 5.436, 5.299, 5.544, 5.475, 5.341, 5.428, 5.664, 5.639, 5.422, 5.586, 5.642, 5.549, 5.534, 5.656, 5.490, 5.713, 5.611, 5.610, 5.284, 5.485, 5.335, 5.600, 5.293, 5.441, 5.518, 5.397, 5.287, 5.566, 5.641, 5.648, 5.552, 5.521, 5.262, 5.380, 5.628, 5.384, 5.317, 5.407, 5.559, 5.497, 5.261, 5.651,

						5.495, 5.546, 5.309, 5.373, 5.306, 5.369, 5.582, 5.444, 5.277, 5.425, 5.391, 5.584, 5.302, 5.581, 5.252, 5.349
22	5510	9	1	333	1	5.405, 5.614, 5.320, 5.520, 5.478, 5.512, 5.639, 5.689, 5.697, 5.332, 5.394, 5.339, 5.300, 5.344, 5.265, 5.684, 5.475, 5.629, 5.500, 5.553, 5.410, 5.355, 5.262, 5.652, 5.289, 5.469, 5.254, 5.316, 5.663, 5.434, 5.345, 5.671, 5.367, 5.630, 5.462, 5.258, 5.542, 5.578, 5.448, 5.374, 5.708, 5.560, 5.431, 5.483, 5.593, 5.600, 5.310, 5.530, 5.453, 5.584, 5.641, 5.673, 5.490, 5.428, 5.532, 5.695, 5.650, 5.651, 5.459, 5.710, 5.521, 5.294, 5.416, 5.424, 5.585, 5.309, 5.318, 5.674, 5.260, 5.700, 5.277, 5.446, 5.252, 5.481, 5.360, 5.458, 5.587, 5.257, 5.574, 5.508, 5.675, 5.437, 5.703, 5.488, 5.649, 5.631, 5.335, 5.470, 5.280, 5.312, 5.581, 5.623, 5.401, 5.698, 5.516, 5.376, 5.718, 5.473, 5.463, 5.323
23	5510	9	1	333	1	5.615, 5.520, 5.508, 5.575, 5.250, 5.596, 5.267, 5.566, 5.456, 5.657, 5.350, 5.673, 5.278, 5.366, 5.408, 5.606, 5.681, 5.632, 5.291, 5.344, 5.354, 5.688, 5.294, 5.338, 5.403, 5.323, 5.705, 5.413, 5.371, 5.505, 5.661, 5.407, 5.465, 5.393, 5.438, 5.445, 5.356, 5.496, 5.314, 5.582, 5.324, 5.332, 5.540, 5.475, 5.436, 5.272, 5.659, 5.309, 5.307, 5.418, 5.549, 5.719, 5.552, 5.253, 5.449, 5.643, 5.384, 5.301, 5.391, 5.257, 5.603, 5.689, 5.597, 5.390, 5.567, 5.382, 5.586, 5.635, 5.410, 5.298, 5.678, 5.286, 5.444, 5.674, 5.362, 5.697, 5.352, 5.349, 5.653, 5.694, 5.512, 5.666, 5.702, 5.319, 5.376, 5.677, 5.311, 5.416, 5.668, 5.466, 5.417, 5.454, 5.614, 5.264, 5.486, 5.468, 5.716, 5.713, 5.370, 5.712
24	5510	9	1	333	1	5.482, 5.554, 5.688, 5.618, 5.345, 5.520, 5.266, 5.443, 5.709, 5.504, 5.611, 5.295, 5.442, 5.402, 5.387, 5.503, 5.355, 5.634, 5.311, 5.531, 5.666, 5.362, 5.303, 5.472, 5.372, 5.445, 5.253, 5.340, 5.342, 5.281, 5.625, 5.411, 5.460, 5.685, 5.597, 5.494, 5.517, 5.524, 5.641, 5.495, 5.712, 5.428, 5.310, 5.578, 5.582, 5.312, 5.679, 5.514, 5.354, 5.687, 5.318, 5.268, 5.575, 5.250, 5.631, 5.692, 5.259, 5.546, 5.584, 5.288, 5.405, 5.686, 5.365, 5.418, 5.560, 5.487, 5.258, 5.377, 5.431, 5.336, 5.683, 5.251, 5.374, 5.368, 5.410, 5.320, 5.720, 5.639, 5.385, 5.615, 5.388, 5.485, 5.702, 5.488, 5.528, 5.604, 5.378, 5.644, 5.501, 5.313, 5.700, 5.461, 5.623, 5.444, 5.344, 5.527, 5.529, 5.707, 5.637, 5.357
25	5510	9	1	333	1	5.342, 5.480, 5.670, 5.484, 5.688, 5.535, 5.635, 5.451, 5.555, 5.500, 5.379, 5.515, 5.583, 5.589, 5.694, 5.707, 5.601, 5.280, 5.402, 5.485, 5.529, 5.333, 5.358, 5.317, 5.659, 5.434, 5.339, 5.255, 5.585, 5.622, 5.687, 5.374, 5.446, 5.305, 5.536, 5.724,

						5.667, 5.256, 5.263, 5.660, 5.626, 5.620, 5.647, 5.426, 5.495, 5.609, 5.503, 5.652, 5.594, 5.287, 5.665, 5.638, 5.289, 5.253, 5.679, 5.387, 5.561, 5.669, 5.654, 5.523, 5.424, 5.493, 5.364, 5.606, 5.718, 5.331, 5.252, 5.612, 5.587, 5.415, 5.644, 5.303, 5.291, 5.335, 5.576, 5.530, 5.385, 5.602, 5.604, 5.617, 5.517, 5.502, 5.405, 5.593, 5.650, 5.268, 5.375, 5.720, 5.447, 5.284, 5.308, 5.464, 5.279, 5.369, 5.514, 5.513, 5.540, 5.528, 5.395, 5.673
26	5510	9	1	333	1	5.650, 5.418, 5.696, 5.545, 5.694, 5.716, 5.693, 5.425, 5.493, 5.500, 5.386, 5.352, 5.646, 5.587, 5.431, 5.660, 5.588, 5.302, 5.692, 5.449, 5.394, 5.704, 5.625, 5.720, 5.595, 5.265, 5.539, 5.464, 5.579, 5.624, 5.520, 5.479, 5.633, 5.322, 5.528, 5.622, 5.463, 5.551, 5.258, 5.663, 5.350, 5.517, 5.711, 5.310, 5.719, 5.618, 5.597, 5.619, 5.313, 5.424, 5.630, 5.516, 5.338, 5.664, 5.285, 5.684, 5.685, 5.654, 5.647, 5.289, 5.702, 5.334, 5.340, 5.412, 5.319, 5.291, 5.271, 5.533, 5.585, 5.294, 5.482, 5.717, 5.645, 5.503, 5.489, 5.407, 5.600, 5.546, 5.602, 5.577, 5.421, 5.480, 5.440, 5.562, 5.263, 5.508, 5.665, 5.288, 5.695, 5.349, 5.293, 5.510, 5.532, 5.280, 5.596, 5.639, 5.523, 5.566, 5.673, 5.356
27	5510	9	1	333	1	5.593, 5.423, 5.577, 5.617, 5.344, 5.500, 5.257, 5.276, 5.530, 5.317, 5.674, 5.613, 5.285, 5.720, 5.670, 5.306, 5.281, 5.458, 5.346, 5.351, 5.555, 5.478, 5.608, 5.542, 5.597, 5.708, 5.310, 5.294, 5.564, 5.580, 5.308, 5.507, 5.686, 5.334, 5.619, 5.256, 5.565, 5.408, 5.610, 5.623, 5.591, 5.316, 5.508, 5.361, 5.447, 5.349, 5.398, 5.362, 5.371, 5.412, 5.324, 5.372, 5.628, 5.638, 5.578, 5.575, 5.357, 5.702, 5.337, 5.475, 5.558, 5.348, 5.405, 5.604, 5.691, 5.413, 5.269, 5.473, 5.663, 5.273, 5.467, 5.544, 5.687, 5.459, 5.439, 5.315, 5.561, 5.396, 5.506, 5.419, 5.287, 5.268, 5.258, 5.359, 5.437, 5.456, 5.418, 5.693, 5.275, 5.296, 5.552, 5.538, 5.424, 5.706, 5.667, 5.722, 5.512, 5.421, 5.499, 5.440
28	5510	9	1	333	1	5.542, 5.391, 5.479, 5.577, 5.421, 5.424, 5.283, 5.344, 5.386, 5.666, 5.652, 5.250, 5.557, 5.268, 5.441, 5.714, 5.523, 5.599, 5.297, 5.446, 5.604, 5.600, 5.280, 5.341, 5.402, 5.687, 5.691, 5.664, 5.469, 5.575, 5.452, 5.284, 5.551, 5.611, 5.436, 5.718, 5.335, 5.590, 5.722, 5.322, 5.470, 5.426, 5.326, 5.532, 5.346, 5.709, 5.633, 5.393, 5.621, 5.422, 5.708, 5.517, 5.349, 5.673, 5.302, 5.345, 5.616, 5.447, 5.496, 5.589, 5.429, 5.520, 5.641, 5.487, 5.559, 5.682, 5.504, 5.458, 5.644, 5.358, 5.442, 5.368, 5.635, 5.278, 5.332, 5.454, 5.320, 5.643, 5.364, 5.713, 5.500, 5.668, 5.374, 5.629, 5.399, 5.369, 5.385, 5.324, 5.610, 5.637,

						5.381, 5.656, 5.291, 5.505, 5.425, 5.383, 5.639, 5.543, 5.435, 5.690
29	5510	9	1	333	1	5.589, 5.660, 5.391, 5.627, 5.319, 5.552, 5.605, 5.304, 5.438, 5.330, 5.306, 5.495, 5.342, 5.709, 5.291, 5.392, 5.701, 5.604, 5.578, 5.721, 5.484, 5.310, 5.388, 5.540, 5.722, 5.697, 5.273, 5.723, 5.595, 5.409, 5.707, 5.632, 5.549, 5.357, 5.570, 5.285, 5.297, 5.510, 5.524, 5.654, 5.681, 5.471, 5.674, 5.280, 5.301, 5.531, 5.486, 5.686, 5.700, 5.608, 5.417, 5.561, 5.468, 5.252, 5.413, 5.275, 5.479, 5.688, 5.431, 5.324, 5.281, 5.277, 5.668, 5.467, 5.350, 5.675, 5.320, 5.567, 5.457, 5.643, 5.617, 5.378, 5.684, 5.703, 5.263, 5.379, 5.399, 5.623, 5.426, 5.462, 5.713, 5.253, 5.385, 5.434, 5.271, 5.469, 5.251, 5.450, 5.356, 5.590, 5.573, 5.548, 5.533, 5.381, 5.293, 5.348, 5.640, 5.538, 5.525, 5.555
30	5510	9	1	333	1	5.270, 5.580, 5.462, 5.518, 5.587, 5.667, 5.415, 5.463, 5.721, 5.696, 5.307, 5.520, 5.396, 5.546, 5.718, 5.545, 5.461, 5.253, 5.350, 5.574, 5.656, 5.601, 5.267, 5.440, 5.492, 5.337, 5.317, 5.402, 5.548, 5.409, 5.500, 5.708, 5.400, 5.300, 5.282, 5.305, 5.445, 5.523, 5.590, 5.609, 5.392, 5.519, 5.426, 5.477, 5.634, 5.384, 5.610, 5.716, 5.258, 5.388, 5.489, 5.581, 5.701, 5.713, 5.554, 5.633, 5.367, 5.515, 5.428, 5.369, 5.529, 5.364, 5.334, 5.404, 5.532, 5.260, 5.370, 5.524, 5.375, 5.646, 5.567, 5.481, 5.251, 5.465, 5.595, 5.382, 5.604, 5.620, 5.387, 5.271, 5.401, 5.665, 5.504, 5.424, 5.569, 5.389, 5.352, 5.616, 5.399, 5.417, 5.719, 5.262, 5.513, 5.650, 5.413, 5.381, 5.677, 5.683, 5.715, 5.505

80MHz Bandwidth

Radar SignalType	Waveform/Trial Number	Detection (%)	Limit (%)	Pass/Fail
Type 1A	15	100 %	60%	Pass
Type 1B	15	100%		
Type 2	30	100 %	60%	Pass
Type 3	30	100%	60%	Pass
Type 4	30	100 %	60%	Pass
Aggregate (Type1 to 4)	120	100 %	80%	Pass
Type 5	30	83.3%	80%	Pass
Type 6	30	100 %	70%	Pass

Please refer to the following statistical tables:

Radar Type 1A Statistical Performance

Trial #	Fc (MHz)	Pulse/Burst	Pulse Width (μS)	PRI (μs)	Detection (1:yes; 0:no)
1	5530	98	1	538	1
2	5530	63	1	838	1
3	5530	70	1	758	1
4	5530	89	1	598	1
5	5530	74	1	718	1
6	5530	68	1	778	1
7	5530	58	1	918	1
8	5530	92	1	578	1
9	5530	59	1	898	1
10	5530	86	1	618	1
11	5530	95	1	558	1
12	5530	61	1	878	1
13	5530	83	1	638	1
14	5530	65	1	818	1
15	5530	76	1	698	1
Detection Percentage: 100 % (>60%)					

Radar Type 1B Statistical Performance

Trial #	Fc (MHz)	Pulse/Burst	Pulse Width (μS)	PRI (μs)	Detection (1:yes; 0:no)
1	5530	18	1	3028	1
2	5530	38	1	1417	1
3	5530	19	1	2856	1
4	5530	60	1	883	1
5	5530	23	1	2339	1
6	5530	31	1	1726	1
7	5530	19	1	2780	1
8	5530	30	1	1775	1
9	5530	57	1	938	1
10	5530	71	1	750	1
11	5530	41	1	1288	1
12	5530	26	1	2082	1
13	5530	33	1	1601	1
14	5530	34	1	1570	1
15	5530	66	1	805	1
Detection Percentage: 100 % (>60%)					

Radar Type 2 Statistical Performance

Trial #	Fc (MHz)	Pulse/Burst	Pulse Width (μS)	PRI (μs)	Detection (1:yes; 0:no)
1	5530	24	4.5	156	1
2	5530	27	4.4	225	1
3	5530	25	1.2	224	1
4	5530	23	4.4	173	1
5	5530	24	2.2	170	1
6	5530	25	2.5	154	1
7	5530	29	1.4	152	1
8	5530	26	3.4	174	1
9	5530	25	2.2	218	1
10	5530	23	1.2	196	1
11	5530	25	3.8	224	1
12	5530	28	1	229	1
13	5530	26	2.8	167	1
14	5530	24	2.5	184	1
15	5530	29	4.3	159	1
16	5530	28	4.4	229	1
17	5530	23	3.1	215	1
18	5530	28	1.2	212	1
19	5530	28	4.8	226	1
20	5530	26	5	228	1
21	5530	28	1.1	150	1
22	5530	24	5	211	1
23	5530	23	2.9	214	1
24	5530	26	1.2	221	1
25	5530	25	1.1	163	1
26	5530	26	2.3	215	1
27	5530	27	3	208	1
28	5530	25	3.9	165	1
29	5530	26	4.8	220	1
30	5530	27	4.7	225	1
Detection Percentage: 100 % (>60%)					

Radar Type 3 Statistical Performance

Trial #	Fc (MHz)	Pulse/Burst	Pulse Width (μS)	PRI (μs)	Detection (1:yes; 0:no)
1	5530	17	9.7	319	1
2	5530	17	7.6	235	1
3	5530	17	8.9	360	1
4	5530	17	8.1	220	1
5	5530	16	6.8	492	1
6	5530	17	9.3	208	1
7	5530	17	7.6	267	1
8	5530	17	7.2	282	1
9	5530	16	6.3	314	1
10	5530	17	8.5	228	1
11	5530	16	7.8	263	1
12	5530	18	8.8	369	1
13	5530	17	9.8	355	1
14	5530	17	7.9	481	1
15	5530	17	6.8	479	1
16	5530	17	8.1	317	1
17	5530	18	8	301	1
18	5530	18	6.8	448	1
19	5530	17	6.2	324	1
20	5530	18	8.1	365	1
21	5530	16	9.8	466	1
22	5530	16	8.1	451	1
23	5530	17	6.4	215	1
24	5530	17	6.2	217	1
25	5530	17	7.9	450	1
26	5530	17	6.1	452	1
27	5530	17	8.1	329	1
28	5530	16	9.1	262	1
29	5530	18	6.7	240	1
30	5530	17	7.5	454	1
Detection Percentage: 100% (>60%)					

Radar Type 4 Statistical Performance

Trial #	Fc (MHz)	Pulse/Burst	Pulse Width (µS)	PRI (µs)	Detection (1:yes; 0:no)
1	5530	14	13.3	353	1
2	5530	14	16.5	333	1
3	5530	15	12.1	257	1
4	5530	14	11.1	417	1
5	5530	16	16.2	248	1
6	5530	14	15.6	301	1
7	5530	12	13.7	377	1
8	5530	15	12.3	388	1
9	5530	14	17.3	424	1
10	5530	14	15.4	494	1
11	5530	14	19.6	402	1
12	5530	13	11.7	284	1
13	5530	15	18.7	206	1
14	5530	13	16.3	267	1
15	5530	16	12.9	497	1
16	5530	12	12.1	214	1
17	5530	16	18.2	387	1
18	5530	13	17	479	1
19	5530	14	16.2	222	1
20	5530	15	16.3	480	1
21	5530	13	18	278	1
22	5530	15	16.9	232	1
23	5530	15	17.5	308	1
24	5530	15	18.4	201	1
25	5530	15	18	253	1
26	5530	13	17	431	1
27	5530	12	20	200	1
28	5530	15	17	438	1
29	5530	15	13.7	358	1
30	5530	15	18.2	347	1
Detection Percentage: 100 % (>60%)					

Radar Type 5 Statistical Performance

Statistics 1 (ChirpCenter Frequency: 5530MHz)

Trial #	Pulse	Chirp(MHz)	Pulse Width (µS)	Pulse 1-2 spacing(µS)	Pulse 2-3 spacing(µS)	Pulse Start(mS)	Detection (1:yes;0:no)
1	3	10	63.2	1720	1982	459.841	1
2	2	10	79.2	1650		14.083	
3	2	10	60.4	1507		516.266	
4	3	10	95.1	1973	1351	707.659	
5	2	10	85.3	1633		485.332	
6	2	10	65.9	1841		371.505	
7	2	10	75.7	1719		215.558	
8	2	10	87.8	1094		271.572	
9	2	10	82.7	1009		649.655	
10	2	10	56.9	1753		173.828	
11	2	10	94.4	1628		653.191	
12	2	10	90.6	1023		592.854	
13	1	10	80.1			206.677	

Statistics 2 (ChirpCenter Frequency: 5530 MHz)

Trial #	Pulse	Chirp(MHz)	Pulse Width (µS)	Pulse 1-2 spacing(µS)	Pulse 2-3 spacing(µS)	Pulse Start(mS)	Detection (1:yes;0:no)
1	3	9	64.9	1706	1914	424.815	1
2	2	9	87.5	1875		376.675	
3	2	9	63.3	1617		407.03	
4	3	9	80.1	1889	1703	525.39	
5	2	9	57.1	1381		154.16	
6	1	9	94.5			533.44	
7	3	9	90.9	1917	1441	463.86	
8	2	9	57.3	1342		436.56	
9	2	9	85.7	1566		247.64	
10	1	9	73.8			291.03	
11	3	9	59	1684	1923	407.93	
12	1	9	55.7			180.69	
13	2	9	59.4	1325		70.35	
14	3	9	93.2	1697	1608	145.24	
15	2	9	73.2	1272		2.26	
16	1	9	71.5			579.24	
17	2	9	52.3	1800		55.57	
18	1	9	89.8			84.9	
19	3	9	85.7	1053	1377	396.9	
20	2	9	81.2	1413		267	

Statistics 3 (ChirpCenter Frequency: 5530 MHz)

Trial #	Pulse	Chirp(MHz)	Pulse Width (µS)	Pulse 1-2 spacing(µS)	Pulse 2-3 spacing(µS)	Pulse Start(mS)	Detection (1:yes;0:no)
1	2	14	63.7	1347		166.207	1
2	2	14	70.2	1972		509.93	
3	3	14	63.6	1710	1208	582.36	
4	3	14	92.6	1593	1068	652.07	
5	1	14	74			306.85	
6	3	14	53	1398	1484	212.15	
7	3	14	73.3	1330	1783	8.43	
8	1	14	67.6			504.45	
9	3	14	80.1	1338	1771	399.89	
10	3	14	67.5	1640	1748	496.23	
11	2	14	54.9	1471		117.44	
12	2	14	81.4	1460		221.82	
13	2	14	60.1	1864		450.18	
14	2	14	84.9	1679		620.7	
15	3	14	55.7	1208	1275	296.7	
16	2	14	75.3	1625		593.3	

Statistics 4 (ChirpCenter Frequency: 5530 MHz)

Trial #	Pulse	Chirp(MHz)	Pulse Width (µS)	Pulse 1-2 spacing(µS)	Pulse 2-3 spacing(µS)	Pulse Start(mS)	Detection (1:yes;0:no)
1	1	11	76.2			530.986	1
2	2	11	86.5	1161		537.298	
3	1	11	72.9			555.545	
4	1	11	54.2			1.533	
5	1	11	85.6			342.901	
6	2	11	97.7	1748		341.168	
7	3	11	66.4	1677	1905	142.836	
8	3	11	89.2	1305	1440	114.424	
9	3	11	71.4	1002	1104	333.821	
10	2	11	73.2	1132		229.739	
11	1	11	54.5			658.146	
12	3	11	70.8	1513	1183	91.614	
13	1	11	51.1			257.772	
14	1	11	84.3			392.469	
15	2	11	69	1533		500.847	
16	2	11	81.1	1672		103.565	
17	2	11	55.4	1941		160.282	

Statistics 5 (ChirpCenter Frequency: 5530 MHz)

Trial #	Pulse	Chirp(MHz)	Pulse Width (µS)	Pulse 1-2 spacing(µS)	Pulse 2-3 spacing(µS)	Pulse Start(mS)	Detection (1:yes;0:no)
1	2	20	52.7	1333		667.599	1
2	3	20	67.2	1703	1652	456.648	
3	2	20	56.4	1027		221.945	
4	3	20	72.6	1861	1740	375.013	
5	2	20	92.7	1993		449.711	
6	1	20	64.4			526.018	
7	2	20	58.3	1271		71.436	
8	2	20	97.4	1305		16.674	
9	2	20	61.5	1096		633.731	
10	2	20	61.9	1941		330.299	
11	3	20	88.2	1955	1353	590.086	
12	1	20	71.3			639.694	
13	2	20	73.6	1801		513.302	
14	1	20	77.6			427.529	
15	1	20	74.4			312.547	
16	2	20	74.6	1069		458.565	
17	1	20	94.6			447.182	

Statistics 6 (ChirpCenter Frequency: 5530 MHz)

Trial #	Pulse	Chirp(MHz)	Pulse Width (µS)	Pulse 1-2 spacing(µS)	Pulse 2-3 spacing(µS)	Pulse Start(mS)	Detection (1:yes;0:no)
1	2	14	53.9	1502		15.225	1
2	2	14	52.4	1070		963.26	
3	2	14	97	1234		436.94	
4	3	14	64.3	1978	1771	957.44	
5	2	14	75.6	1066		413.19	
6	1	14	52.9			385.23	
7	1	14	71			888.27	
8	2	14	95.7	1634		162.09	
9	2	14	91.2	1241		146.15	
10	1	14	59.3			800.1	
11	2	14	68.5	1872		26.9	
12	2	14	64	1718		292.4	

Statistics 7 (ChirpCenter Frequency: 5530 MHz)

Trial #	Pulse	Chirp(MHz)	Pulse Width (µS)	Pulse 1-2 spacing(µS)	Pulse 2-3 spacing(µS)	Pulse Start(mS)	Detection (1:yes;0:no)
1	2	10	58	1489		649.557	1
2	1	10	72.7			122.84	
3	2	10	69.9	1066		830.65	
4	2	10	88.5	1614		990.7	
5	2	10	80.9	1888		954.36	
6	2	10	87.5	1441		344.41	
7	2	10	54.2	1692		616.84	
8	2	10	62.7	1714		921.06	
9	2	10	66.8	1644		672.72	
10	1	10	81.5			95.29	
11	3	10	66.2	1571	1558	159.4	
12	2	10	89.2	1597		931.1	

Statistics 8 (ChirpCenter Frequency: 5530 MHz)

Trial #	Pulse	Chirp(MHz)	Pulse Width (µS)	Pulse 1-2 spacing(µS)	Pulse 2-3 spacing(µS)	Pulse Start(mS)	Detection (1:yes;0:no)
1	2	20	64.8	1119		457.112	1
2	2	20	96.7	1442		522.173	
3	2	20	74.8	1933		601.527	
4	3	20	99.8	1007	1259	298.39	
5	2	20	80.6	1934		257.033	
6	2	20	72.3	1854		25.767	
7	2	20	79.1	1994		71.35	
8	2	20	87.9	1161		405.533	
9	1	20	68.1			632.537	
10	2	20	74.4	1554		513.51	
11	2	20	91.9	1550		249.643	
12	2	20	97.8	1549		206.417	
13	2	20	64.1	1353		232.12	
14	2	20	51.5	1576		131.093	
15	3	20	63.8	1591	1755	23.907	
16	3	20	52.3	1071	1759	463.4	
17	1	20	94.8			335.533	
18	2	20	65.4	1580		78.367	

Statistics 9 (ChirpCenter Frequency: 5530 MHz)

Trial #	Pulse	Chirp(MHz)	Pulse Width (µS)	Pulse 1-2 spacing(µS)	Pulse 2-3 spacing(µS)	Pulse Start(mS)	Detection (1:yes;0:no)
1	2	20	54.2	1869		535.154	1
2	1	20	85.4			252.817	
3	3	20	61	1122	1732	239.933	
4	1	20	80.3			194.23	
5	1	20	58.1			246.957	
6	2	20	92.5	1922		936.273	
7	3	20	59.3	1206	1103	1314	
8	2	20	59.6	1322		901.067	
9	1	20	68.1			782.733	

Statistics 10 (ChirpCenter Frequency: 5530 MHz)

Trial #	Pulse	Chirp(MHz)	Pulse Width (µS)	Pulse 1-2 spacing(µS)	Pulse 2-3 spacing(µS)	Pulse Start(mS)	Detection (1:yes;0:no)
1	2	8	63.6	1338		989.19	1
2	2	8	82.3	1210		300.801	
3	2	8	55.7	1244		589.342	
4	2	8	91.1	1057		890.893	
5	2	8	97.6	1872		446.984	
6	2	8	56.7	1479		409.525	
7	2	8	67.3	1847		1071.275	
8	1	8	62.4			661.696	
9	2	8	73.7	1397		3.807	
10	1	8	63.8			632.018	
11	2	8	55.8	1094		502.809	

Statistics 11 (ChirpCenter Frequency: 5496.4 MHz)

Trial #	Pulse	Chirp(MHz)	Pulse Width (µS)	Pulse 1-2 spacing(µS)	Pulse 2-3 spacing(µS)	Pulse Start(mS)	Detection (1:yes;0:no)
1	3	11	66.3	1310	1794	1.258	1
2	2	11	88.3	1343		57.864	
3	1	11	51.5			116.41	
4	3	11	53.8	1586	1664	146.75	
5	2	11	57.7	1645		219.62	
6	3	11	85.8	1237	1287	318.58	
7	2	11	86.8	1140		352.51	
8	3	11	87.1	1196	1439	103.61	
9	2	11	93.3	1152		195.51	
10	3	11	55.2	1130	1794	171.57	
11	1	11	91.6			515.8	
12	2	11	66	1756		51.14	
13	3	11	62.5	1851	1327	620.6	
14	3	11	73.3	1501	1013	370	
15	2	11	70.1	1804		100.2	

Statistics 12 (ChirpCenter Frequency: 5494.4 MHz)

Trial #	Pulse	Chirp(MHz)	Pulse Width (µS)	Pulse 1-2 spacing(µS)	Pulse 2-3 spacing(µS)	Pulse Start(mS)	Detection (1:yes;0:no)
1	3	6	51.3	1303	1886	332.173	0
2	3	6	83.2	1296	1294	385.573	
3	2	6	74.4	1045		184.787	
4	2	6	70.1	1768		245.75	
5	2	6	55.1	1952		433.093	
6	3	6	90.2	1881	1496	498.717	
7	1	6	77.7			23.15	
8	3	6	90.6	1656	1042	118.313	
9	2	6	64.3	1798		33.477	
10	2	6	58.4	1106		243.32	
11	2	6	91.7	1458		278.043	
12	2	6	78.1	1688		22.527	
13	1	6	58.1			448.61	
14	2	6	97.1	1394		650.753	
15	2	6	78.5	1633		233.377	
16	1	6	59.1			498.9	
17	2	6	88.4	1374		639.833	
18	3	6	78.2	1938	1121	481.967	

Statistics 13 (ChirpCenter Frequency: 5498.8 MHz)

Trial #	Pulse	Chirp(MHz)	Pulse Width (µS)	Pulse 1-2 spacing(µS)	Pulse 2-3 spacing(µS)	Pulse Start(mS)	Detection (1:yes;0:no)
1	3	17	64.9	1630	1818	917.986	1
2	2	17	81.6	1563		340.12	
3	2	17	56.9	1848		702.68	
4	2	17	54.6	1656		279.23	
5	3	17	79	1695	1697	715.69	
6	1	17	71.9			83.04	
7	2	17	60	1906		456.49	
8	1	17	76.3			337.71	
9	2	17	74.9	1612		923.83	
10	2	17	52.8	1773		896.3	
11	1	17	79.1			64.3	
12	1	17	53.3			910.8	

Statistics 14 (ChirpCenter Frequency: 5494.8 MHz)

Trial #	Pulse	Chirp(MHz)	Pulse Width (µS)	Pulse 1-2 spacing(µS)	Pulse 2-3 spacing(µS)	Pulse Start(mS)	Detection (1:yes;0:no)
1	1	7	57.8			631.667	1
2	1	7	64.9			786.22	
3	2	7	50.6	1206		553.62	
4	3	7	93.1	1442	1340	787.1	
5	2	7	91.4	1518		706.39	
6	2	7	61.3	1687		501.26	
7	2	7	100	1150		536.15	
8	2	7	77.6	1968		247.64	
9	1	7	67			712.25	
10	1	7	82.9			355.95	
11	3	7	91.7	1596	1431	478.29	
12	3	7	70.9	1027	1151	397.35	
13	2	7	56.1	1499		47.86	
14	2	7	98.5	1293		329.4	
15	2	7	93.6	1155		543.5	

Statistics 15 (ChirpCenter Frequency: 5500 MHz)

Trial #	Pulse	Chirp(MHz)	Pulse Width (µS)	Pulse 1-2 spacing(µS)	Pulse 2-3 spacing(µS)	Pulse Start(mS)	Detection (1:yes;0:no)
1	3	20	90.6	1943	1280	472.72	0
2	1	20	88			292.324	
3	2	20	62.2	1243		503.025	
4	2	20	52.4	1996		450.123	
5	2	20	65.4	1286		425.681	
6	3	20	78.7	1725	1533	8.468	
7	2	20	86.9	1059		38.456	
8	2	20	68.3	1436		410.024	
9	1	20	55.5			423.551	
10	2	20	85.8	1509		458.099	
11	2	20	90.1	1459		155.896	
12	3	20	70.6	1204	1334	346.214	
13	3	20	60.4	1080	1463	112.362	
14	2	20	55.4	1140		541.999	
15	3	20	68.8	1067	1050	353.347	
16	1	20	58			630.365	
17	3	20	59.3	1159	1521	665.482	

Statistics 16 (ChirpCenter Frequency: 5496.4 MHz)

Trial #	Pulse	Chirp(MHz)	Pulse Width (µS)	Pulse 1-2 spacing(µS)	Pulse 2-3 spacing(µS)	Pulse Start(mS)	Detection (1:yes;0:no)
1	3	11	83.7	1757	1967	95.953	1
2	2	11	72.8	1185		160.651	
3	2	11	70.8	1903		389.005	
4	1	11	63.7			109.333	
5	1	11	96.6			473.441	
6	2	11	56.5	1825		675.488	
7	3	11	95	1262	1702	115.076	
8	1	11	99.3			303.224	
9	2	11	96	1147		531.911	
10	2	11	88.8	1475		15.199	
11	2	11	92.3	1347		523.796	
12	3	11	86.7	1583	1777	481.474	
13	3	11	82.5	1951	1533	224.232	
14	2	11	74.8	1581		455.389	
15	1	11	85.6			130.347	
16	3	11	75	1074	1152	482.065	
17	2	11	57.4	1173		396.482	

Statistics 17 (ChirpCenter Frequency: 5499.2MHz)

Trial #	Pulse	Chirp(MHz)	Pulse Width (µS)	Pulse 1-2 spacing(µS)	Pulse 2-3 spacing(µS)	Pulse Start(mS)	Detection (1:yes;0:no)
1	3	18	88.6	1959	1689	279.877	0
2	2	18	81	1899		19.7	
3	2	18	71.3	1189		1119.58	
4	2	18	78.6	1431		738.86	
5	2	18	90.8	1350		750.77	
6	1	18	92.9			1296.34	
7	3	18	62.4	1879	1930	1367.2	
8	2	18	67.6	1870		1141.2	

Statistics 18 (ChirpCenter Frequency: 5495.2 MHz)

Trial #	Pulse	Chirp(MHz)	Pulse Width (µS)	Pulse 1-2 spacing(µS)	Pulse 2-3 spacing(µS)	Pulse Start(mS)	Detection (1:yes;0:no)
1	2	8	57	1346		437.582	0
2	1	8	53.5			357.637	
3	3	8	68.9	1098	1595	199.704	
4	3	8	79.7	1531	1243	135.201	
5	2	8	84	1543		391.439	
6	3	8	73.2	1457	1640	7.706	
7	3	8	62.8	1119	1381	833.193	
8	2	8	96.2	1870		436.64	
9	2	8	56.6	1840		701.187	
10	1	8	85.1			116.724	
11	2	8	75.9	1725		182.741	
12	2	8	60.1	1745		272.009	
13	2	8	78	1220		33.786	
14	2	8	61.8	1559		257.743	

Statistics 19 (ChirpCenter Frequency: 5499.6 MHz)

Trial #	Pulse	Chirp(MHz)	Pulse Width (µS)	Pulse 1-2 spacing(µS)	Pulse 2-3 spacing(µS)	Pulse Start(mS)	Detection (1:yes;0:no)
1	2	19	96.7	1263		914.423	1
2	3	19	54.3	1021	1108	765.793	
3	1	19	78.9			840.716	
4	3	19	58.5	1374	1402	741.269	
5	1	19	82.3			180.502	
6	1	19	93.4			177.175	
7	2	19	50.7	1186		568.628	
8	2	19	92	1690		147.802	
9	2	19	71.3	1315		572.195	
10	2	19	70.1	1476		479.608	
11	1	19	98			371.661	
12	3	19	68.9	1856	1205	446.354	
13	3	19	74.2	1449	1112	630.677	

Statistics 20 (ChirpCenter Frequency: 5494.4 MHz)

Trial #	Pulse	Chirp(MHz)	Pulse Width (µS)	Pulse 1-2 spacing(µS)	Pulse 2-3 spacing(µS)	Pulse Start(mS)	Detection (1:yes;0:no)
1	1	6	96.6			698.125	0
2	3	6	72.3	1359	1626	953.8	
3	2	6	73.9	1841		933.98	
4	2	6	99.5	1462		713.56	
5	2	6	74.2	1992		745.69	
6	3	6	83.2	1934	1777	564.7	
7	2	6	85.3	1784		249.88	
8	3	6	71.5	1604	1616	802.98	
9	2	6	96.4	1409		917.5	
10	1	6	91.3			1139.6	

Statistics 21 (ChirpCenter Frequency: 5562.8 MHz)

Trial #	Pulse	Chirp(MHz)	Pulse Width (µS)	Pulse 1-2 spacing(µS)	Pulse 2-3 spacing(µS)	Pulse Start(mS)	Detection (1:yes;0:no)
1	2	13	58.8	1788		397.652	1
2	2	13	69.5	1787		601.247	
3	2	13	76.6	1915		480.683	
4	2	13	83.5	1725		72.27	
5	3	13	95.1	1349	1435	169.037	
6	1	13	80.2			1007.673	
7	2	13	84.7	1334		138.47	
8	3	13	52.7	1409	1014	521.537	
9	2	13	80.3	1216		306.333	

Statistics 22 (ChirpCenter Frequency: 5563.2 MHz)

Trial #	Pulse	Chirp(MHz)	Pulse Width (µS)	Pulse 1-2 spacing(µS)	Pulse 2-3 spacing(µS)	Pulse Start(mS)	Detection (1:yes;0:no)
1	1	12	91.7			188.923	1
2	1	12	65.3			323.71	
3	2	12	88	1797		148.35	
4	1	12	68.4			2.92	
5	3	12	62.3	1201	1755	404.83	
6	1	12	62.6			13.16	
7	1	12	81.2			188.27	
8	2	12	77.7	1297		193.48	
9	2	12	70.4	1868		294.83	
10	1	12	70.4			76.33	
11	2	12	53.3	1713		441.37	
12	1	12	83.2			80.07	
13	2	12	63.7	1785		147.36	
14	3	12	65.6	1499	1491	185.96	
15	2	12	70.3	1242		414.56	
16	3	12	80.6	1141	1009	397.42	
17	3	12	93.7	1487	1648	170.5	
18	3	12	57.7	1126	1233	257.7	
19	2	12	85.4	1102		440.6	
20	2	12	83.5	1408		235.6	

Statistics 23(ChirpCenter Frequency: 5560 MHz)

Trial #	Pulse	Chirp(MHz)	Pulse Width (µS)	Pulse 1-2 spacing(µS)	Pulse 2-3 spacing(µS)	Pulse Start(mS)	Detection (1:yes;0:no)
1	3	20	55.5	1686	1566	355.125	1
2	2	20	61.3	1876		68.532	
3	3	20	62.3	1199	1094	544.187	
4	1	20	69.6			484.37	
5	2	20	51.6	1793		512.953	
6	2	20	85.6	1120		213.157	
7	2	20	99	1682		299.81	
8	3	20	92.2	1813	1723	145.733	
9	2	20	94.1	1714		148.787	
10	2	20	58.6	1212		16.12	
11	1	20	69.6			8.963	
12	2	20	66.5	1436		659.467	
13	3	20	79.7	1291	1786	131.23	
14	3	20	77.4	1495	1959	435.163	
15	1	20	88.3			502.237	
16	2	20	99.3	1134		203	
17	2	20	73.5	1291		484.433	
18	2	20	73.1	1563		68.967	

Statistics 24(ChirpCenter Frequency: 5562 MHz)

Trial #	Pulse	Chirp(MHz)	Pulse Width (μS)	Pulse 1-2 spacing(μS)	Pulse 2-3 spacing(μS)	Pulse Start(mS)	Detection (1:yes;0:no)
1	3	15	92.5	1445	1031	348.413	1
2	3	15	95.7	1689	1503	334.964	
3	2	15	69.6	1683		363.73	
4	2	15	54.7	1540		424.33	
5	2	15	58.4	1512		257.93	
6	3	15	53.2	1865	1339	265.3	
7	2	15	76.5	1551		195.23	
8	2	15	68.9	1809		105.05	
9	3	15	82.2	1142	1179	490.69	
10	1	15	99.3			33.72	
11	2	15	54.1	1165		159.81	
12	1	15	96.3			387.67	
13	1	15	98.7			260.35	
14	2	15	73.8	1829		440.6	
15	3	15	78.5	1964	1630	481.44	
16	2	15	60.9	1797		130.44	
17	1	15	81.5			286.97	
18	2	15	59.3	1144		97.7	
19	1	15	99.2			335.2	
20	3	15	86.6	1079	1883	438.4	

Statistics 25(ChirpCenter Frequency: 5566 MHz)

Trial #	Pulse	Chirp(MHz)	Pulse Width (µS)	Pulse 1-2 spacing(µS)	Pulse 2-3 spacing(µS)	Pulse Start(mS)	Detection (1:yes;0:no)
1	3	5	96.1	1703	1847	773.346	1
2	3	5	54.6	1976	1752	429.453	
3	3	5	98	1251	1772	131.266	
4	1	5	69.5			30.989	
5	2	5	79	1091		499.242	
6	2	5	81.8	1510		182.215	
7	3	5	70.7	1644	1643	222.548	
8	3	5	51.8	1020	1962	566.782	
9	2	5	55.9	1008		253.255	
10	2	5	58.2	1241		453.788	
11	3	5	69.7	1016	1886	403.671	
12	1	5	60.2			74.454	
13	2	5	74.8	1367		673.577	

Statistics 26 (ChirpCenter Frequency: 5560.8 MHz)

Trial #	Pulse	Chirp(MHz)	Pulse Width (µS)	Pulse 1-2 spacing(µS)	Pulse 2-3 spacing(µS)	Pulse Start(mS)	Detection (1:yes;0:no)
1	3	18	66.3	1183	1583	201.457	1
2	3	18	52.2	1593	1325	418.25	
3	2	18	91.9	1418		459.88	
4	1	18	53.6			669.15	
5	2	18	80.6	1464		135.99	
6	1	18	78.3			296.25	
7	3	18	68	1738	1549	99.58	
8	2	18	76.4	1125		920.46	
9	2	18	70.7	1975		636.92	
10	2	18	51.5	1959		664.1	
11	2	18	85.9	1447		907.5	
12	2	18	91.4	1813		345.2	

Statistics 27 (ChirpCenter Frequency: 5561.2 MHz)

Trial #	Pulse	Chirp(MHz)	Pulse Width (µS)	Pulse 1-2 spacing(µS)	Pulse 2-3 spacing(µS)	Pulse Start(mS)	Detection (1:yes;0:no)
1	2	17	63.6	1570		579.701	1
2	3	17	91.6	1957	1434	467.611	
3	3	17	81.1	1993	1598	451.622	
4	3	17	90	1091	1877	405.603	
5	1	17	62.1			0.014	
6	2	17	76	1970		364.505	
7	1	17	95.1			251.596	
8	2	17	68.3	1533		345.017	
9	1	17	88.7			96.798	
10	2	17	78.9	1447		511.599	
11	2	17	77.7	1463		288.521	
12	1	17	66.5			191.312	
13	1	17	68.8			422.443	
14	2	17	92.8	1074		294.834	
15	1	17	77.3			161.405	
16	2	17	88.3	1325		185.816	
17	1	17	50.3			25.237	
18	1	17	92.2			83.158	
19	3	17	70.3	1162	1389	168.679	

Statistics 28 (ChirpCenter Frequency: 5564.8 MHz)

Trial #	Pulse	Chirp(MHz)	Pulse Width (µS)	Pulse 1-2 spacing(µS)	Pulse 2-3 spacing(µS)	Pulse Start(mS)	Detection (1:yes;0:no)
1	2	8	88.3	1523		260.114	1
2	2	8	83.1	1889		646.398	
3	2	8	90.4	1368		659.605	
4	2	8	74.3	1810		367.213	
5	2	8	82.3	1712		697.841	
6	3	8	81.6	1648	1894	29.798	
7	3	8	54.2	1833	1431	111.936	
8	1	8	69.6			219.654	
9	2	8	63.4	1899		59.111	
10	1	8	78.4			531.349	
11	2	8	85	1097		30.176	
12	1	8	70.8			553.104	
13	2	8	50.1	1255		86.852	
14	1	8	57.9			221.479	
15	3	8	66.8	1241	1822	358.147	
16	1	8	69.2			337.965	
17	2	8	89	1801		690.182	

Statistics 29 (ChirpCenter Frequency: 5560.4 MHz)

Trial #	Pulse	Chirp(MHz)	Pulse Width (µS)	Pulse 1-2 spacing(µS)	Pulse 2-3 spacing(µS)	Pulse Start(mS)	Detection (1:yes;0:no)
1	3	19	60.5	1371	1174	903.957	1
2	3	19	60.6	1756	1631	1059.231	
3	3	19	93.6	1828	1012	929.212	
4	3	19	75	1030	1288	854.603	
5	3	19	85.9	1964	1378	799.014	
6	2	19	82.8	1282		712.225	
7	2	19	98.9	1008		667.815	
8	3	19	92.6	1507	1479	717.896	
9	1	19	80.6			354.967	
10	2	19	79.2	1254		262.918	
11	2	19	61.4	1224		393.209	

Statistics 30 (ChirpCenter Frequency: 5563.6 MHz)

Trial #	Pulse	Chirp(MHz)	Pulse Width (µS)	Pulse 1-2 spacing(µS)	Pulse 2-3 spacing(µS)	Pulse Start(mS)	Detection (1:yes;0:no)
1	2	11	90.7	1412		105.494	1
2	1	11	73			509.9	
3	2	11	60.4	1486		585.41	
4	2	11	68.4	1420		282.56	
5	2	11	53.4	1890		701.2	
6	3	11	97.6	1851	1765	491.01	
7	2	11	56.3	1995		133.13	
8	1	11	91.2			313.95	
9	3	11	80	1185	1489	128.23	
10	1	11	71.5			632.34	
11	3	11	61	1499	1388	660.17	
12	2	11	73	1510		365.63	
13	3	11	62.5	1933	1187	195.37	
14	2	11	96	1508		695.3	
15	3	11	94.1	1062	1156	502.7	
16	3	11	79.4	1218	1980	75.7	

Radar Type 6 Statistical Performance

Trial #	Fc (MHz)	Pulse /Burst	Pulse Width (μS)	PRI (μs)	Detection (1:yes; 0:no)	Hopping Sequence (GHz)
1	5530	9	1	333	1	5.572, 5.596, 5.266, 5.272, 5.314, 5.267, 5.474, 5.500, 5.261, 5.575, 5.667, 5.351, 5.627, 5.609, 5.464, 5.473, 5.529, 5.669, 5.570, 5.616, 5.648, 5.712, 5.720, 5.546, 5.400, 5.699, 5.441, 5.600, 5.641, 5.549, 5.716, 5.369, 5.452, 5.380, 5.564, 5.288, 5.631, 5.403, 5.466, 5.484, 5.326, 5.307, 5.592, 5.507, 5.390, 5.299, 5.377, 5.576, 5.440, 5.659, 5.664, 5.450, 5.290, 5.479, 5.302, 5.448, 5.327, 5.621, 5.465, 5.584, 5.577, 5.615, 5.634, 5.425, 5.580, 5.453, 5.681, 5.469, 5.599, 5.640, 5.645, 5.467, 5.443, 5.320, 5.332, 5.294, 5.286, 5.337, 5.383, 5.543, 5.723, 5.415, 5.494, 5.708, 5.436, 5.534, 5.538, 5.673, 5.371, 5.454, 5.456, 5.622, 5.433, 5.702, 5.670, 5.556, 5.711, 5.344, 5.680, 5.651
2	5530	9	1	333	1	5.506, 5.343, 5.329, 5.722, 5.278, 5.471, 5.474, 5.510, 5.470, 5.531, 5.684, 5.707, 5.413, 5.654, 5.318, 5.383, 5.520, 5.291, 5.359, 5.680, 5.515, 5.409, 5.335, 5.699, 5.434, 5.268, 5.308, 5.345, 5.393, 5.576, 5.419, 5.258, 5.397, 5.600, 5.389, 5.265, 5.698, 5.577, 5.558, 5.692, 5.538, 5.394, 5.492, 5.493, 5.670, 5.423, 5.469, 5.334, 5.589, 5.588, 5.532, 5.724, 5.391, 5.552, 5.495, 5.617, 5.607, 5.592, 5.293, 5.396, 5.287, 5.668, 5.401, 5.274, 5.388, 5.542, 5.263, 5.353, 5.581, 5.649, 5.404, 5.428, 5.320, 5.701, 5.294, 5.578, 5.497, 5.509, 5.348, 5.441, 5.716, 5.677, 5.412, 5.478, 5.499, 5.327, 5.341, 5.432, 5.448, 5.456, 5.461, 5.395, 5.505, 5.403, 5.310, 5.498, 5.512, 5.340, 5.490, 5.651
3	5530	9	1	333	1	5.555, 5.511, 5.678, 5.283, 5.648, 5.275, 5.401, 5.422, 5.410, 5.697, 5.458, 5.653, 5.533, 5.461, 5.400, 5.419, 5.560, 5.599, 5.534, 5.559, 5.535, 5.537, 5.290, 5.336, 5.660, 5.671, 5.462, 5.490, 5.723, 5.665, 5.685, 5.528, 5.311, 5.483, 5.656, 5.680, 5.404, 5.457, 5.525, 5.477, 5.413, 5.328, 5.510, 5.668, 5.631, 5.396, 5.359, 5.261, 5.316, 5.293, 5.600, 5.281, 5.463, 5.312, 5.596, 5.301, 5.565, 5.645, 5.611, 5.450, 5.337, 5.455, 5.368, 5.521, 5.354, 5.519, 5.287, 5.632, 5.610, 5.403, 5.646, 5.480, 5.408, 5.557, 5.250, 5.332, 5.522, 5.270, 5.689, 5.353, 5.335, 5.282, 5.416, 5.314, 5.264, 5.473, 5.284, 5.469, 5.345, 5.677, 5.278, 5.424, 5.711, 5.644, 5.369, 5.271, 5.722, 5.546, 5.576, 5.474
4	5530	9	1	333	1	5.341, 5.668, 5.251, 5.715, 5.447, 5.613, 5.357, 5.702, 5.545, 5.517, 5.558, 5.696, 5.599, 5.494, 5.691, 5.387, 5.464, 5.723,

						5.674, 5.301, 5.448, 5.461, 5.400, 5.456, 5.408, 5.557, 5.520, 5.596, 5.677, 5.303, 5.325, 5.603, 5.485, 5.486, 5.658, 5.703, 5.315, 5.430, 5.373, 5.692, 5.337, 5.401, 5.428, 5.659, 5.302, 5.378, 5.608, 5.512, 5.439, 5.381, 5.567, 5.335, 5.422, 5.645, 5.465, 5.564, 5.675, 5.330, 5.609, 5.292, 5.476, 5.477, 5.305, 5.275, 5.482, 5.708, 5.350, 5.257, 5.297, 5.334, 5.663, 5.420, 5.699, 5.510, 5.612, 5.683, 5.283, 5.261, 5.698, 5.620, 5.288, 5.294, 5.621, 5.410, 5.617, 5.256, 5.458, 5.522, 5.440, 5.379, 5.701, 5.724, 5.588, 5.348, 5.265, 5.685, 5.566, 5.370, 5.407, 5.706
5	5530	9	1	333	1	5.634, 5.654, 5.447, 5.570, 5.353, 5.318, 5.707, 5.293, 5.620, 5.586, 5.699, 5.450, 5.682, 5.439, 5.564, 5.637, 5.391, 5.518, 5.626, 5.372, 5.627, 5.686, 5.592, 5.663, 5.550, 5.461, 5.669, 5.631, 5.668, 5.508, 5.417, 5.657, 5.477, 5.658, 5.615, 5.711, 5.279, 5.665, 5.445, 5.333, 5.710, 5.481, 5.660, 5.569, 5.273, 5.395, 5.591, 5.696, 5.264, 5.529, 5.349, 5.520, 5.421, 5.365, 5.551, 5.409, 5.295, 5.479, 5.578, 5.655, 5.526, 5.674, 5.302, 5.327, 5.375, 5.561, 5.609, 5.323, 5.341, 5.501, 5.577, 5.678, 5.606, 5.547, 5.718, 5.545, 5.265, 5.436, 5.311, 5.420, 5.455, 5.367, 5.492, 5.672, 5.351, 5.693, 5.470, 5.360, 5.702, 5.414, 5.510, 5.676, 5.687, 5.694, 5.472, 5.680, 5.566, 5.642, 5.706, 5.677
6	5530	9	1	333	1	5.543, 5.529, 5.324, 5.684, 5.480, 5.520, 5.356, 5.269, 5.272, 5.511, 5.644, 5.449, 5.391, 5.283, 5.625, 5.446, 5.563, 5.321, 5.592, 5.507, 5.569, 5.493, 5.530, 5.577, 5.621, 5.273, 5.705, 5.553, 5.435, 5.329, 5.604, 5.277, 5.663, 5.299, 5.345, 5.590, 5.261, 5.260, 5.608, 5.367, 5.722, 5.394, 5.492, 5.641, 5.567, 5.310, 5.661, 5.390, 5.505, 5.459, 5.639, 5.555, 5.519, 5.497, 5.342, 5.670, 5.611, 5.387, 5.581, 5.657, 5.455, 5.371, 5.388, 5.411, 5.682, 5.586, 5.638, 5.579, 5.494, 5.475, 5.587, 5.370, 5.525, 5.668, 5.612, 5.423, 5.677, 5.701, 5.631, 5.595, 5.334, 5.709, 5.653, 5.386, 5.288, 5.293, 5.576, 5.583, 5.425, 5.662, 5.603, 5.414, 5.330, 5.500, 5.397, 5.341, 5.300, 5.271, 5.254, 5.491
7	5530	9	1	333	1	5.363, 5.687, 5.714, 5.326, 5.414, 5.440, 5.421, 5.541, 5.553, 5.513, 5.670, 5.304, 5.423, 5.576, 5.601, 5.616, 5.450, 5.388, 5.468, 5.606, 5.486, 5.716, 5.609, 5.398, 5.561, 5.325, 5.551, 5.665, 5.295, 5.649, 5.336, 5.578, 5.627, 5.408, 5.713, 5.308, 5.339, 5.502, 5.270, 5.288, 5.535, 5.348, 5.644, 5.585, 5.377, 5.642, 5.467, 5.255, 5.591, 5.418, 5.562, 5.427, 5.442, 5.539, 5.568, 5.319, 5.694, 5.661, 5.577, 5.347, 5.621, 5.269, 5.310, 5.451, 5.456, 5.711, 5.617, 5.393, 5.489, 5.581, 5.257, 5.384,

						5.529, 5.540, 5.342, 5.610, 5.675, 5.641, 5.335, 5.723, 5.594, 5.494, 5.636, 5.465, 5.370, 5.530, 5.538, 5.605, 5.454, 5.314, 5.265, 5.387, 5.503, 5.268, 5.569, 5.505, 5.673, 5.289, 5.516, 5.328
8	5530	9	1	333	1	5.423, 5.663, 5.531, 5.458, 5.373, 5.321, 5.585, 5.694, 5.379, 5.535, 5.637, 5.390, 5.326, 5.640, 5.710, 5.578, 5.617, 5.463, 5.702, 5.519, 5.629, 5.638, 5.693, 5.273, 5.495, 5.285, 5.554, 5.386, 5.664, 5.420, 5.548, 5.616, 5.657, 5.354, 5.291, 5.551, 5.500, 5.596, 5.290, 5.491, 5.651, 5.595, 5.369, 5.536, 5.707, 5.499, 5.623, 5.358, 5.377, 5.613, 5.415, 5.582, 5.328, 5.484, 5.274, 5.449, 5.709, 5.602, 5.287, 5.659, 5.272, 5.660, 5.355, 5.550, 5.324, 5.507, 5.276, 5.372, 5.572, 5.720, 5.461, 5.583, 5.691, 5.634, 5.587, 5.555, 5.265, 5.427, 5.405, 5.284, 5.380, 5.606, 5.584, 5.348, 5.385, 5.428, 5.695, 5.712, 5.341, 5.601, 5.459, 5.645, 5.669, 5.625, 5.544, 5.698, 5.479, 5.679, 5.562, 5.389
9	5530	9	1	333	1	5.255, 5.421, 5.455, 5.371, 5.481, 5.349, 5.681, 5.605, 5.310, 5.658, 5.545, 5.461, 5.340, 5.437, 5.504, 5.561, 5.714, 5.670, 5.278, 5.716, 5.305, 5.392, 5.277, 5.442, 5.598, 5.329, 5.408, 5.656, 5.283, 5.263, 5.580, 5.335, 5.279, 5.476, 5.648, 5.412, 5.424, 5.318, 5.389, 5.294, 5.617, 5.602, 5.396, 5.600, 5.262, 5.380, 5.549, 5.298, 5.601, 5.664, 5.721, 5.674, 5.579, 5.430, 5.456, 5.379, 5.526, 5.311, 5.690, 5.355, 5.404, 5.618, 5.527, 5.345, 5.534, 5.346, 5.550, 5.444, 5.400, 5.553, 5.521, 5.531, 5.649, 5.300, 5.675, 5.323, 5.603, 5.320, 5.439, 5.654, 5.622, 5.454, 5.377, 5.358, 5.378, 5.657, 5.707, 5.287, 5.450, 5.445, 5.692, 5.281, 5.722, 5.511, 5.470, 5.717, 5.592, 5.406, 5.372, 5.647
10	5530	9	1	333	1	5.400, 5.569, 5.665, 5.340, 5.346, 5.575, 5.716, 5.550, 5.317, 5.477, 5.360, 5.297, 5.420, 5.492, 5.371, 5.564, 5.602, 5.671, 5.682, 5.611, 5.469, 5.254, 5.322, 5.553, 5.713, 5.612, 5.375, 5.304, 5.441, 5.281, 5.681, 5.658, 5.471, 5.301, 5.717, 5.432, 5.660, 5.623, 5.358, 5.656, 5.599, 5.649, 5.686, 5.640, 5.367, 5.373, 5.676, 5.394, 5.284, 5.266, 5.664, 5.632, 5.306, 5.330, 5.401, 5.704, 5.630, 5.447, 5.470, 5.513, 5.291, 5.268, 5.298, 5.547, 5.372, 5.315, 5.482, 5.570, 5.270, 5.526, 5.312, 5.666, 5.571, 5.250, 5.520, 5.379, 5.583, 5.276, 5.542, 5.252, 5.633, 5.445, 5.679, 5.461, 5.434, 5.433, 5.337, 5.343, 5.311, 5.478, 5.497, 5.684, 5.648, 5.413, 5.711, 5.275, 5.552, 5.481, 5.608, 5.282
11	5530	9	1	333	1	5.566, 5.274, 5.363, 5.688, 5.319, 5.328, 5.273, 5.410, 5.345, 5.417, 5.478, 5.693, 5.398, 5.632, 5.678, 5.332, 5.283, 5.524, 5.428, 5.703, 5.718, 5.459, 5.540, 5.557,

						5.276, 5.393, 5.334, 5.364, 5.339, 5.347, 5.580, 5.316, 5.287, 5.333, 5.679, 5.402, 5.517, 5.668, 5.335, 5.467, 5.613, 5.536, 5.680, 5.636, 5.552, 5.435, 5.711, 5.395, 5.443, 5.388, 5.604, 5.500, 5.541, 5.413, 5.442, 5.258, 5.691, 5.581, 5.677, 5.302, 5.519, 5.279, 5.411, 5.308, 5.714, 5.595, 5.477, 5.656, 5.665, 5.355, 5.321, 5.649, 5.479, 5.469, 5.579, 5.422, 5.250, 5.624, 5.633, 5.671, 5.414, 5.348, 5.554, 5.391, 5.309, 5.300, 5.511, 5.446, 5.546, 5.456, 5.362, 5.639, 5.712, 5.510, 5.305, 5.432, 5.346, 5.651, 5.405, 5.667
12	5530	9	1	333	1	5.301, 5.470, 5.536, 5.637, 5.519, 5.553, 5.326, 5.560, 5.341, 5.334, 5.658, 5.366, 5.258, 5.711, 5.561, 5.441, 5.292, 5.332, 5.650, 5.657, 5.413, 5.535, 5.311, 5.472, 5.252, 5.618, 5.471, 5.717, 5.722, 5.424, 5.452, 5.280, 5.462, 5.372, 5.539, 5.396, 5.712, 5.592, 5.283, 5.685, 5.521, 5.401, 5.362, 5.587, 5.641, 5.445, 5.289, 5.352, 5.672, 5.646, 5.548, 5.664, 5.333, 5.714, 5.623, 5.300, 5.264, 5.253, 5.276, 5.675, 5.691, 5.474, 5.674, 5.550, 5.365, 5.715, 5.306, 5.294, 5.275, 5.662, 5.310, 5.297, 5.625, 5.382, 5.603, 5.314, 5.448, 5.482, 5.690, 5.577, 5.632, 5.678, 5.602, 5.263, 5.425, 5.293, 5.508, 5.659, 5.323, 5.649, 5.286, 5.304, 5.552, 5.501, 5.271, 5.457, 5.616, 5.391, 5.684, 5.389
13	5530	9	1	333	1	5.270, 5.351, 5.613, 5.601, 5.631, 5.606, 5.317, 5.523, 5.517, 5.315, 5.357, 5.450, 5.722, 5.409, 5.583, 5.387, 5.401, 5.403, 5.473, 5.620, 5.360, 5.596, 5.405, 5.365, 5.336, 5.592, 5.496, 5.465, 5.691, 5.672, 5.358, 5.524, 5.509, 5.554, 5.421, 5.514, 5.383, 5.582, 5.429, 5.477, 5.686, 5.390, 5.468, 5.513, 5.460, 5.498, 5.682, 5.572, 5.461, 5.555, 5.527, 5.658, 5.469, 5.699, 5.303, 5.377, 5.326, 5.696, 5.332, 5.354, 5.323, 5.310, 5.285, 5.632, 5.327, 5.630, 5.663, 5.695, 5.426, 5.268, 5.322, 5.518, 5.402, 5.302, 5.448, 5.680, 5.389, 5.483, 5.297, 5.425, 5.349, 5.283, 5.651, 5.553, 5.535, 5.396, 5.305, 5.714, 5.474, 5.369, 5.479, 5.299, 5.347, 5.445, 5.361, 5.511, 5.662, 5.532, 5.710, 5.625
14	5530	9	1	333	1	5.537, 5.573, 5.355, 5.674, 5.676, 5.529, 5.554, 5.340, 5.430, 5.484, 5.378, 5.581, 5.454, 5.706, 5.279, 5.342, 5.423, 5.441, 5.691, 5.440, 5.622, 5.716, 5.576, 5.521, 5.388, 5.617, 5.697, 5.550, 5.326, 5.515, 5.649, 5.647, 5.452, 5.420, 5.512, 5.557, 5.656, 5.498, 5.467, 5.634, 5.684, 5.616, 5.606, 5.293, 5.466, 5.718, 5.401, 5.724, 5.308, 5.613, 5.379, 5.571, 5.604, 5.357, 5.393, 5.374, 5.513, 5.545, 5.651, 5.698, 5.307, 5.609, 5.704, 5.372, 5.407, 5.575, 5.590, 5.542, 5.403, 5.565, 5.582, 5.509, 5.669, 5.525, 5.601, 5.291, 5.564, 5.632,

						5.487, 5.334, 5.703, 5.473, 5.707, 5.553, 5.408, 5.410, 5.385, 5.263, 5.259, 5.429, 5.380, 5.480, 5.406, 5.611, 5.650, 5.397, 5.297, 5.436, 5.722, 5.535
15	5530	9	1	333	1	5.256, 5.341, 5.516, 5.342, 5.634, 5.370, 5.504, 5.399, 5.443, 5.442, 5.530, 5.537, 5.596, 5.599, 5.581, 5.482, 5.668, 5.503, 5.393, 5.624, 5.369, 5.665, 5.314, 5.573, 5.544, 5.676, 5.452, 5.365, 5.674, 5.591, 5.336, 5.276, 5.448, 5.437, 5.286, 5.615, 5.384, 5.327, 5.380, 5.337, 5.534, 5.519, 5.653, 5.392, 5.501, 5.564, 5.720, 5.601, 5.595, 5.484, 5.670, 5.296, 5.253, 5.254, 5.290, 5.589, 5.539, 5.499, 5.637, 5.372, 5.308, 5.416, 5.626, 5.529, 5.717, 5.456, 5.485, 5.353, 5.420, 5.714, 5.693, 5.453, 5.570, 5.449, 5.309, 5.293, 5.368, 5.655, 5.338, 5.579, 5.446, 5.556, 5.445, 5.616, 5.434, 5.594, 5.465, 5.436, 5.373, 5.304, 5.320, 5.483, 5.418, 5.593, 5.408, 5.332, 5.333, 5.568, 5.586, 5.690
16	5530	9	1	333	1	5.375, 5.320, 5.327, 5.352, 5.452, 5.663, 5.265, 5.700, 5.637, 5.672, 5.556, 5.403, 5.678, 5.594, 5.344, 5.271, 5.570, 5.258, 5.284, 5.581, 5.461, 5.614, 5.474, 5.349, 5.331, 5.332, 5.560, 5.514, 5.554, 5.281, 5.431, 5.299, 5.369, 5.551, 5.325, 5.362, 5.396, 5.658, 5.665, 5.364, 5.260, 5.573, 5.639, 5.290, 5.297, 5.711, 5.467, 5.380, 5.599, 5.636, 5.664, 5.423, 5.436, 5.578, 5.379, 5.361, 5.318, 5.626, 5.584, 5.351, 5.367, 5.448, 5.535, 5.404, 5.264, 5.540, 5.702, 5.355, 5.441, 5.439, 5.415, 5.475, 5.644, 5.710, 5.716, 5.632, 5.592, 5.630, 5.596, 5.346, 5.534, 5.497, 5.699, 5.575, 5.261, 5.454, 5.709, 5.515, 5.408, 5.481, 5.505, 5.484, 5.491, 5.411, 5.609, 5.690, 5.393, 5.495, 5.262, 5.298
17	5530	9	1	333	1	5.447, 5.717, 5.302, 5.536, 5.607, 5.680, 5.604, 5.395, 5.448, 5.276, 5.709, 5.471, 5.399, 5.263, 5.478, 5.312, 5.250, 5.589, 5.573, 5.403, 5.387, 5.515, 5.684, 5.541, 5.617, 5.266, 5.603, 5.535, 5.323, 5.547, 5.658, 5.361, 5.545, 5.522, 5.286, 5.439, 5.610, 5.665, 5.283, 5.449, 5.529, 5.611, 5.668, 5.459, 5.441, 5.595, 5.484, 5.362, 5.405, 5.719, 5.619, 5.659, 5.309, 5.410, 5.625, 5.511, 5.332, 5.298, 5.664, 5.560, 5.556, 5.261, 5.519, 5.609, 5.430, 5.701, 5.644, 5.682, 5.540, 5.435, 5.402, 5.469, 5.570, 5.599, 5.400, 5.453, 5.489, 5.326, 5.526, 5.559, 5.284, 5.324, 5.415, 5.534, 5.583, 5.549, 5.481, 5.366, 5.673, 5.479, 5.591, 5.457, 5.360, 5.389, 5.626, 5.374, 5.628, 5.558, 5.623, 5.514
18	5530	9	1	333	1	5.500, 5.642, 5.527, 5.629, 5.311, 5.304, 5.508, 5.327, 5.445, 5.378, 5.440, 5.313, 5.321, 5.452, 5.324, 5.722, 5.632, 5.578, 5.286, 5.299, 5.406, 5.570, 5.535, 5.565, 5.357, 5.414, 5.630, 5.643, 5.708, 5.322,

						5.507, 5.323, 5.666, 5.484, 5.701, 5.319, 5.467, 5.367, 5.462, 5.723, 5.647, 5.308, 5.426, 5.407, 5.622, 5.531, 5.705, 5.288, 5.573, 5.435, 5.338, 5.589, 5.611, 5.270, 5.278, 5.306, 5.341, 5.695, 5.460, 5.472, 5.352, 5.689, 5.431, 5.385, 5.365, 5.318, 5.343, 5.520, 5.437, 5.456, 5.377, 5.706, 5.513, 5.678, 5.260, 5.293, 5.597, 5.342, 5.514, 5.659, 5.279, 5.592, 5.434, 5.549, 5.617, 5.253, 5.395, 5.559, 5.651, 5.711, 5.532, 5.503, 5.307, 5.380, 5.337, 5.522, 5.373, 5.361, 5.489, 5.556
19	5530	9	1	333	1	5.380, 5.324, 5.347, 5.692, 5.520, 5.654, 5.480, 5.381, 5.674, 5.495, 5.419, 5.536, 5.404, 5.311, 5.712, 5.570, 5.602, 5.579, 5.452, 5.418, 5.400, 5.653, 5.306, 5.652, 5.427, 5.534, 5.343, 5.538, 5.338, 5.401, 5.613, 5.618, 5.550, 5.714, 5.688, 5.288, 5.340, 5.563, 5.359, 5.696, 5.704, 5.378, 5.382, 5.657, 5.440, 5.295, 5.544, 5.517, 5.557, 5.664, 5.457, 5.432, 5.521, 5.584, 5.385, 5.608, 5.524, 5.537, 5.624, 5.374, 5.705, 5.310, 5.396, 5.376, 5.313, 5.598, 5.372, 5.334, 5.439, 5.286, 5.433, 5.254, 5.555, 5.682, 5.422, 5.290, 5.377, 5.519, 5.639, 5.460, 5.251, 5.528, 5.685, 5.669, 5.285, 5.497, 5.660, 5.420, 5.337, 5.522, 5.443, 5.515, 5.437, 5.405, 5.642, 5.371, 5.394, 5.498, 5.547, 5.502
20	5530	9	1	333	1	5.617, 5.290, 5.586, 5.363, 5.592, 5.641, 5.525, 5.451, 5.675, 5.279, 5.627, 5.456, 5.610, 5.436, 5.425, 5.580, 5.370, 5.567, 5.702, 5.274, 5.271, 5.423, 5.401, 5.364, 5.495, 5.465, 5.352, 5.381, 5.468, 5.365, 5.360, 5.719, 5.593, 5.399, 5.552, 5.389, 5.280, 5.515, 5.354, 5.558, 5.512, 5.538, 5.293, 5.654, 5.565, 5.720, 5.544, 5.342, 5.408, 5.296, 5.407, 5.257, 5.609, 5.485, 5.564, 5.409, 5.400, 5.295, 5.545, 5.474, 5.337, 5.653, 5.386, 5.540, 5.569, 5.582, 5.332, 5.547, 5.491, 5.686, 5.478, 5.411, 5.692, 5.494, 5.496, 5.319, 5.380, 5.529, 5.484, 5.453, 5.477, 5.385, 5.371, 5.313, 5.548, 5.717, 5.695, 5.704, 5.503, 5.489, 5.452, 5.492, 5.671, 5.656, 5.325, 5.283, 5.549, 5.419, 5.463, 5.505
21	5530	9	1	333	1	5.607, 5.476, 5.586, 5.296, 5.280, 5.408, 5.593, 5.456, 5.273, 5.286, 5.418, 5.450, 5.614, 5.274, 5.554, 5.319, 5.577, 5.711, 5.516, 5.417, 5.336, 5.679, 5.393, 5.264, 5.615, 5.695, 5.409, 5.375, 5.709, 5.441, 5.405, 5.346, 5.687, 5.300, 5.343, 5.391, 5.655, 5.705, 5.598, 5.268, 5.451, 5.578, 5.558, 5.369, 5.572, 5.423, 5.384, 5.335, 5.489, 5.262, 5.490, 5.388, 5.517, 5.566, 5.646, 5.362, 5.447, 5.473, 5.525, 5.253, 5.591, 5.610, 5.472, 5.662, 5.634, 5.318, 5.532, 5.664, 5.376, 5.652, 5.373, 5.611, 5.502, 5.703, 5.365, 5.301, 5.288, 5.636, 5.290, 5.504, 5.527, 5.590, 5.589, 5.424,

						5.275, 5.446, 5.520, 5.477, 5.690, 5.633, 5.261, 5.606, 5.433, 5.585, 5.256, 5.625, 5.704, 5.328, 5.564, 5.403
22	5530	9	1	333	1	5.404, 5.662, 5.635, 5.669, 5.295, 5.554, 5.633, 5.706, 5.513, 5.620, 5.365, 5.279, 5.500, 5.371, 5.503, 5.375, 5.520, 5.455, 5.431, 5.517, 5.403, 5.264, 5.652, 5.499, 5.568, 5.629, 5.559, 5.253, 5.621, 5.563, 5.718, 5.348, 5.544, 5.270, 5.507, 5.340, 5.489, 5.343, 5.631, 5.605, 5.347, 5.443, 5.462, 5.501, 5.707, 5.523, 5.674, 5.583, 5.387, 5.618, 5.603, 5.471, 5.710, 5.595, 5.668, 5.361, 5.556, 5.352, 5.349, 5.354, 5.269, 5.716, 5.551, 5.689, 5.306, 5.565, 5.590, 5.409, 5.673, 5.598, 5.342, 5.623, 5.444, 5.570, 5.280, 5.530, 5.337, 5.696, 5.548, 5.502, 5.370, 5.688, 5.534, 5.542, 5.666, 5.467, 5.372, 5.378, 5.715, 5.681, 5.381, 5.368, 5.569, 5.298, 5.577, 5.412, 5.498, 5.636, 5.705, 5.566
23	5530	9	1	333	1	5.516, 5.706, 5.664, 5.697, 5.336, 5.601, 5.649, 5.304, 5.321, 5.559, 5.630, 5.264, 5.503, 5.668, 5.598, 5.674, 5.306, 5.515, 5.396, 5.588, 5.708, 5.569, 5.718, 5.415, 5.423, 5.363, 5.644, 5.407, 5.326, 5.392, 5.543, 5.468, 5.549, 5.411, 5.663, 5.279, 5.504, 5.647, 5.496, 5.526, 5.436, 5.387, 5.676, 5.283, 5.659, 5.715, 5.309, 5.251, 5.617, 5.424, 5.538, 5.353, 5.517, 5.623, 5.286, 5.691, 5.320, 5.719, 5.473, 5.651, 5.476, 5.461, 5.268, 5.474, 5.375, 5.511, 5.510, 5.354, 5.608, 5.430, 5.575, 5.456, 5.609, 5.330, 5.689, 5.580, 5.372, 5.378, 5.417, 5.570, 5.662, 5.459, 5.545, 5.486, 5.450, 5.646, 5.675, 5.344, 5.581, 5.530, 5.683, 5.404, 5.466, 5.296, 5.485, 5.501, 5.351, 5.701, 5.702, 5.483
24	5530	9	1	333	1	5.597, 5.309, 5.658, 5.261, 5.462, 5.512, 5.619, 5.268, 5.508, 5.407, 5.275, 5.666, 5.616, 5.650, 5.501, 5.516, 5.583, 5.485, 5.318, 5.341, 5.641, 5.278, 5.348, 5.697, 5.534, 5.250, 5.544, 5.568, 5.515, 5.510, 5.675, 5.389, 5.252, 5.555, 5.637, 5.362, 5.566, 5.324, 5.393, 5.376, 5.598, 5.587, 5.274, 5.367, 5.681, 5.497, 5.546, 5.506, 5.691, 5.375, 5.545, 5.539, 5.316, 5.560, 5.331, 5.703, 5.450, 5.680, 5.687, 5.422, 5.592, 5.503, 5.439, 5.672, 5.466, 5.277, 5.498, 5.699, 5.378, 5.611, 5.701, 5.528, 5.276, 5.602, 5.548, 5.332, 5.600, 5.380, 5.719, 5.424, 5.335, 5.392, 5.457, 5.495, 5.368, 5.717, 5.543, 5.395, 5.563, 5.502, 5.586, 5.342, 5.481, 5.458, 5.399, 5.668, 5.388, 5.427, 5.593, 5.423
25	5530	9	1	333	1	5.502, 5.625, 5.261, 5.375, 5.283, 5.368, 5.453, 5.336, 5.639, 5.293, 5.477, 5.278, 5.374, 5.540, 5.389, 5.493, 5.426, 5.470, 5.310, 5.582, 5.430, 5.325, 5.292, 5.555, 5.688, 5.476, 5.448, 5.590, 5.695, 5.251, 5.671, 5.455, 5.677, 5.286, 5.632, 5.522,

						5.467, 5.536, 5.451, 5.269, 5.624, 5.517, 5.254, 5.333, 5.588, 5.345, 5.553, 5.328, 5.701, 5.681, 5.391, 5.464, 5.402, 5.698, 5.704, 5.344, 5.664, 5.578, 5.429, 5.322, 5.635, 5.352, 5.436, 5.546, 5.683, 5.711, 5.449, 5.420, 5.636, 5.386, 5.531, 5.705, 5.319, 5.387, 5.702, 5.674, 5.574, 5.473, 5.438, 5.525, 5.423, 5.515, 5.627, 5.713, 5.600, 5.443, 5.480, 5.396, 5.484, 5.672, 5.330, 5.288, 5.606, 5.610, 5.505, 5.524, 5.594, 5.483, 5.299, 5.549
26	5530	9	1	333	1	5.598, 5.476, 5.488, 5.704, 5.326, 5.675, 5.411, 5.629, 5.535, 5.330, 5.261, 5.337, 5.478, 5.587, 5.416, 5.272, 5.496, 5.684, 5.501, 5.515, 5.695, 5.520, 5.682, 5.258, 5.642, 5.293, 5.454, 5.543, 5.626, 5.711, 5.341, 5.697, 5.508, 5.703, 5.698, 5.666, 5.595, 5.690, 5.335, 5.571, 5.531, 5.594, 5.308, 5.288, 5.498, 5.504, 5.395, 5.459, 5.419, 5.445, 5.607, 5.328, 5.528, 5.656, 5.310, 5.438, 5.434, 5.486, 5.516, 5.421, 5.641, 5.689, 5.255, 5.325, 5.389, 5.658, 5.583, 5.369, 5.457, 5.345, 5.472, 5.718, 5.578, 5.617, 5.623, 5.663, 5.430, 5.541, 5.471, 5.447, 5.382, 5.542, 5.256, 5.573, 5.370, 5.406, 5.313, 5.720, 5.624, 5.713, 5.339, 5.399, 5.420, 5.667, 5.576, 5.526, 5.545, 5.532, 5.609, 5.644
27	5530	9	1	333	1	5.574, 5.581, 5.344, 5.316, 5.366, 5.485, 5.600, 5.264, 5.355, 5.319, 5.672, 5.458, 5.712, 5.268, 5.324, 5.452, 5.330, 5.276, 5.396, 5.556, 5.549, 5.509, 5.262, 5.440, 5.668, 5.291, 5.715, 5.569, 5.555, 5.420, 5.612, 5.655, 5.521, 5.591, 5.461, 5.666, 5.378, 5.494, 5.716, 5.421, 5.374, 5.586, 5.351, 5.479, 5.698, 5.576, 5.314, 5.614, 5.267, 5.599, 5.720, 5.571, 5.423, 5.596, 5.468, 5.643, 5.641, 5.394, 5.525, 5.510, 5.428, 5.681, 5.695, 5.453, 5.441, 5.477, 5.526, 5.659, 5.674, 5.506, 5.251, 5.552, 5.664, 5.283, 5.270, 5.297, 5.656, 5.691, 5.583, 5.598, 5.322, 5.519, 5.527, 5.377, 5.280, 5.522, 5.708, 5.323, 5.363, 5.491, 5.447, 5.301, 5.382, 5.341, 5.254, 5.486, 5.476, 5.384, 5.419, 5.431
28	5530	9	1	333	1	5.551, 5.687, 5.337, 5.391, 5.719, 5.400, 5.656, 5.676, 5.690, 5.637, 5.523, 5.274, 5.718, 5.701, 5.287, 5.724, 5.272, 5.320, 5.497, 5.479, 5.482, 5.285, 5.353, 5.354, 5.357, 5.613, 5.617, 5.559, 5.401, 5.542, 5.442, 5.515, 5.440, 5.300, 5.576, 5.428, 5.455, 5.260, 5.340, 5.483, 5.490, 5.321, 5.526, 5.548, 5.643, 5.319, 5.544, 5.713, 5.341, 5.264, 5.714, 5.705, 5.286, 5.686, 5.532, 5.537, 5.308, 5.633, 5.291, 5.647, 5.524, 5.505, 5.405, 5.448, 5.610, 5.447, 5.368, 5.683, 5.641, 5.512, 5.508, 5.476, 5.693, 5.290, 5.470, 5.666, 5.513, 5.694, 5.619, 5.360, 5.432, 5.660, 5.489, 5.703, 5.366, 5.585, 5.453, 5.534, 5.355, 5.545,

						5.569, 5.359, 5.514, 5.581, 5.717, 5.486, 5.393, 5.422, 5.662, 5.668
29	5530	9	1	333	1	5.592, 5.384, 5.375, 5.572, 5.576, 5.534, 5.610, 5.629, 5.692, 5.668, 5.512, 5.266, 5.597, 5.443, 5.665, 5.687, 5.350, 5.595, 5.654, 5.341, 5.664, 5.523, 5.536, 5.343, 5.268, 5.307, 5.698, 5.497, 5.720, 5.438, 5.439, 5.455, 5.548, 5.544, 5.590, 5.581, 5.528, 5.432, 5.719, 5.349, 5.533, 5.608, 5.479, 5.328, 5.489, 5.482, 5.640, 5.625, 5.708, 5.566, 5.478, 5.335, 5.385, 5.513, 5.264, 5.311, 5.440, 5.378, 5.525, 5.377, 5.500, 5.410, 5.453, 5.702, 5.332, 5.667, 5.347, 5.285, 5.567, 5.259, 5.508, 5.298, 5.568, 5.346, 5.662, 5.258, 5.599, 5.391, 5.388, 5.419, 5.537, 5.360, 5.357, 5.651, 5.279, 5.486, 5.323, 5.575, 5.642, 5.706, 5.673, 5.527, 5.646, 5.715, 5.532, 5.372, 5.468, 5.435, 5.413, 5.648
30	5530	9	1	333	1	5.251, 5.490, 5.324, 5.332, 5.355, 5.543, 5.392, 5.629, 5.330, 5.553, 5.547, 5.519, 5.480, 5.459, 5.618, 5.409, 5.462, 5.375, 5.320, 5.322, 5.265, 5.347, 5.279, 5.704, 5.693, 5.403, 5.399, 5.342, 5.292, 5.706, 5.484, 5.285, 5.385, 5.595, 5.294, 5.560, 5.502, 5.607, 5.256, 5.610, 5.668, 5.397, 5.670, 5.692, 5.278, 5.415, 5.609, 5.405, 5.437, 5.604, 5.314, 5.431, 5.328, 5.456, 5.598, 5.555, 5.532, 5.286, 5.641, 5.620, 5.296, 5.535, 5.549, 5.393, 5.615, 5.473, 5.376, 5.701, 5.343, 5.424, 5.402, 5.382, 5.509, 5.349, 5.477, 5.592, 5.585, 5.697, 5.377, 5.383, 5.420, 5.496, 5.345, 5.586, 5.685, 5.404, 5.625, 5.613, 5.503, 5.656, 5.544, 5.616, 5.675, 5.339, 5.569, 5.671, 5.419, 5.691, 5.274, 5.449

***** END OF REPORT *****