



RF TEST REPORT

Applicant Huawei Technologies Co., Ltd.
FCC ID QISR227H
Product Mobile WiFi
Brand HUAWEI
Model R227h
Report No. RHA1705-0046RF02R1
Issue Date June 8, 2017

TA Technology (Shanghai) Co., Ltd. tested the above equipment in accordance with the requirements in **FCC CFR47 Part 2 (2017)/ FCC CFR 47 Part 24H (2017)**. The test results show that the equipment tested is capable of demonstrating compliance with the requirements as documented in this report.

Jiang peng Lan

Performed by: Jiangpeng Lan

Kai Xu

Approved by: Kai Xu

TA Technology (Shanghai) Co., Ltd.

No.145, Jintang Rd, Tangzhen Industry Park, Pudong Shanghai, China

TEL: +86-021-50791141/2/3

FAX: +86-021-50791141/2/3-8000



TABLE OF CONTENT

- 1. Test Laboratory4
 - 1.1. Notes of the test report.....4
 - 1.2. Test facility.....4
 - 1.3. Testing Location5
- 2. General Description of Equipment under Test.....6
- 3. Applied Standards.....9
- 4. Test Configuration.....10
- 5. Test Case Results.....11
 - 5.1. RF Power Output.....11
 - 5.2. Effective Isotropic Radiated Power13
 - 5.3. Occupied Bandwidth16
 - 5.4. Band Edge Compliance.....20
 - 5.5. Peak-to-Average Power Ratio (PAPR)23
 - 5.6. Frequency Stability25
 - 5.7. Spurious Emissions at Antenna Terminals28
 - 5.8. Radiates Spurious Emission31
- 6. Main Test Instruments36
- ANNEX A: EUT Appearance and Test Setup.....37
 - A.1 EUT Appearance37
 - A.2 Test Setup.....39



Summary of measurement results

No.	Test Case	Clause in FCC rules	Verdict
1	RF power output	2.1046	PASS
2	Effective Isotropic Radiated power	24.232	PASS
3	Occupied Bandwidth	2.1049	PASS
4	Band Edge Compliance	2.1051 /24.238	PASS
5	Peak-to-Average Power Ratio	24.232/KDB 971168 D01(5.7)	PASS
6	Frequency Stability	2.1055 / 24.235	PASS
7	Spurious Emissions at Antenna Terminals	2.1051 / 24.238	PASS
8	Radiates Spurious Emission	2.1053 / 24.238	PASS
Date of Testing: May 9, 2017~ May 18, 2017			
Note: PASS: The EUT complies with the essential requirements in the standard. FAIL: The EUT does not comply with the essential requirements in the standard.			

1. Test Laboratory

1.1. Notes of the test report

This report shall not be reproduced in full or partial, without the written approval of **TA technology (shanghai) co., Ltd.** The results documented in this report apply only to the tested sample, under the conditions and modes of operation as described herein. Measurement Uncertainties were not taken into account and are published for informational purposes only. This report is written to support regulatory compliance of the applicable standards stated above. This report must not be used by the client to claim product certification, approval, or endorsement by any government agencies.

1.2. Test facility

CNAS (accreditation number: L2264)

TA Technology (Shanghai) Co., Ltd. has obtained the accreditation of China National Accreditation Service for Conformity Assessment (CNAS).

FCC (recognition number is 428261)

TA Technology (Shanghai) Co., Ltd. has been listed on the US Federal Communications Commission list of test facilities recognized to perform electromagnetic emissions measurements.

IC (recognition number is 8510A)

TA Technology (Shanghai) Co., Ltd. has been listed by industry Canada to perform electromagnetic emission measurement.

VCCI (recognition number is C-4595, T-2154, R-4113, G-766)

TA Technology (Shanghai) Co., Ltd. has been listed by industry Japan to perform electromagnetic emission measurement.

A2LA (Certificate Number: 3857.01)

TA Technology (Shanghai) Co., Ltd. has been listed by American Association for Laboratory Accreditation to perform electromagnetic emission measurement.



1.3. Testing Location

Company: TA Technology (Shanghai) Co., Ltd.
Address: No.145, Jintang Rd, Tangzhen Industry Park, Pudong
City: Shanghai
Post code: 201201
Country: P. R. China
Contact: Xu Kai
Telephone: +86-021-50791141/2/3
Fax: +86-021-50791141/2/3-8000
Website: <http://www.ta-shanghai.com>
E-mail: xukai@ta-shanghai.com

2. General Description of Equipment under Test

Client Information

Applicant	Huawei Technologies Co., Ltd.
Applicant address	Administration Building, Headquarters of Huawei Technologies Co., Ltd., Bantian, Longgang District Shenzhen 518129 P.R.China
Manufacturer	Huawei Technologies Co., Ltd.
Manufacturer address	Administration Building, Headquarters of Huawei Technologies Co., Ltd., Bantian, Longgang District Shenzhen 518129 P.R.China

General information

EUT Description			
Model	R227h		
Product IMEI	/		
Hardware Version	CL1E5785SM06		
Software Version	21.130.00.00.00		
Power Supply	Battery/AC adapter		
Antenna Type	Internal Antenna		
Test Mode(s)	GSM1900; WCDMA Band II;		
Test Modulation	(GSM)GMSK,8PSK; (WCDMA)QPSK;		
GPRS Multislot Class	12		
EGPRS Multislot Class	12		
HSDPA UE Category	10		
HSUPA UE Category	6		
DC-HSDPA UE Category	24		
HSPA+ UE Category	14		
Maximum E.I.R.P	GSM 1900:	30.16 dBm	
	WCDMA Band II:	23.44 dBm	
Rated Power Supply Voltage	3.8V		
Extreme Voltage	Minimum: 3.6V Maximum: 4.2V		
Extreme Temperature	Lowest: 0°C Highest: +35°C		
Operating Frequency Range(s)	Band	Tx (MHz)	Rx (MHz)
	GSM1900	1850 ~ 1910	1930 ~ 1990
	WCDMA Band II	1850 ~ 1910	1930 ~ 1990
EUT Accessory			
Adapter 1	Manufacturer: Huizhou BYD Electronic Co., Ltd Model: HW-050200E01		
Adapter 2	Manufacturer: Shenzhen Huntkey Electronic Co., Ltd Model: HW-050200E01		
Adapter 3	Manufacturer: Huizhou BYD Electronic Co., Ltd Model: HW-050200U01		
Adapter 4	Manufacturer: Shenzhen Huntkey Electronic Co., Ltd Model: HW-050200U01		
Adapter 5	Manufacturer: Dongguan Phitek Electronic Co., Ltd Model: HW-050200U01		
Adapter 6	Manufacturer: Huizhou BYD Electronic Co., Ltd Model: HW-050200B01		
Adapter 7	Manufacturer: Shenzhen Huntkey Electronic Co., Ltd Model: HW-050200B01		
Adapter 8	Manufacturer: Dongguan Phitek Electronic Co., Ltd Model: HW-050200B01		
Adapter 9	Manufacturer: Huizhou BYD Electronic Co., Ltd Model: HW-050200A01		



Adapter 10	Manufacturer: Shenzhen Huntkey Electronic Co., Ltd Model: HW-050200A01
Adapter 11	Manufacturer: Dongguan Phitek Electronic Co., Ltd Model: HW-050200A01
Battery	Manufacturer: Huawei Technologies Co., Ltd. Model: HB824666RBC Power Rating: DC 3.8V, 3000mAh, Li-ion
USB Extend Cable	100m Cable, Shielded
Note: The information of the EUT is declared by the manufacturer. Please refer to the specifications or user manual for details.	



3. Applied Standards

According to the specifications of the manufacturer, it must comply with the requirements of the following standards:

FCC CFR47 Part 2 (2017)

FCC CFR 47 Part 24H (2017)

ANSI/TIA-603-D (2010)

KDB 971168 D01 Power Meas License Digital Systems v02r02

4. Test Configuration

Radiated measurements are performed by rotating the EUT in three different orthogonal test planes. EUT stand-up position (Z axis), lie-down position (X, Y axis). Receiver antenna polarization (horizontal and vertical), the worst emission was found in position (Z axis, vertical polarization) and the worst case was recorded.

All mode and data rates and positions and RB size and modulations were investigated.

Subsequently, only the worst case emissions are reported.

The following testing in GSM/WCDMA is set based on the maximum RF Output Power.

Test modes are chosen to be reported as the worst case configuration below:

	Test items	Modes/Modulation	
		GSM 1900	WCDMA Band II
Conducted Test cases	RF power output	GSM GPRS(1Tx slot) EGPRS(1Tx slot)	RMC/ HSDPA/ HSUPA
	Occupied Bandwidth	GSM GPRS(1Tx slot) EGPRS(1Tx slot)	RMC
	Band Edge Compliance	GSM GPRS(1Tx slot) EGPRS(1Tx slot)	RMC
	Peak-to-Average Power Ratio	GSM GPRS(1Tx slot) EGPRS(1Tx slot)	RMC
	Frequency Stability	GSM GPRS(1Tx slot) EGPRS(1Tx slot)	RMC
	Spurious Emissions at Antenna Terminals	GSM	RMC
Radiated Test cases	Effective Isotropic Radiated power	GSM GPRS(1Tx slot) EGPRS(1Tx slot)	RMC
	Radiates Spurious Emission	GSM	RMC

5. Test Case Results

5.1.RF Power Output

Ambient condition

Temperature	Relative humidity	Pressure
23°C ~25°C	45%~50%	101.5kPa

Methods of Measurement

During the process of the testing, The EUT is controlled by the Base Station Simulator to ensure max power transmission and proper modulation.

Test Setup

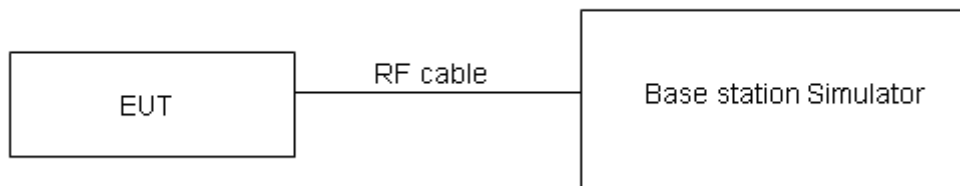

The loss between RF output port of the EUT and the input port of the tester has been taken into consideration.

Limits

No specific RF power output requirements in part 2.1046.

Measurement Uncertainty

The assessed measurement uncertainty to ensure 95% confidence level for the normal distribution is with the coverage factor $k = 2$, $U = 0.4$ dB.

**Test Results**

GSM 1900		Conducted Power(dBm)		
		Channel 512	Channel 661	Channel 810
		1850.2(MHz)	1880(MHz)	1909.8(MHz)
GSM	Results	29.87	29.75	29.75
GPRS (GMSK)	1TXslot	29.83	29.76	29.73
	2TXslots	27.75	27.66	27.60
	3TXslots	25.92	25.59	25.65
	4TXslots	23.87	23.57	23.71
EGPRS (8PSK)	1TXslot	26.01	25.82	25.83
	2TXslots	23.95	23.54	23.56
	3TXslots	21.39	21.36	21.46
	4TXslots	19.85	19.65	19.56

WCDMA Band II		Conducted Power(dBm)		
		Channel 9262	Channel 9400	Channel 9538
		1852.4(MHz)	1880(MHz)	1907.6(MHz)
RMC		22.82	22.88	22.67
HSDPA	Sub - Test 1	22.65	22.71	22.50
	Sub - Test 2	22.73	22.79	22.58
	Sub - Test 3	22.22	22.28	22.07
	Sub - Test 4	22.21	22.27	22.06
HSUPA	Sub - Test 1	22.70	22.76	22.55
	Sub - Test 2	20.89	20.95	20.74
	Sub - Test 3	21.62	21.68	21.63
	Sub - Test 4	20.84	20.9	20.72
	Sub - Test 5	22.76	22.82	22.61
DC-HSDPA	Sub - Test 1	22.75	22.77	22.56
	Sub - Test 2	22.74	22.76	22.55
	Sub - Test 3	22.23	22.25	22.04
	Sub - Test 4	22.22	22.34	22.02

5.2. Effective Isotropic Radiated Power

Ambient condition

Temperature	Relative humidity	Pressure
23°C ~25°C	45%~50%	101.5kPa

Methods of Measurement

1. The testing follows FCC KDB 971168 v02r02 Section 5.8 and ANSI / TIA-603-D-2010 Section 2.2.12.
2. EUT was placed on a 0.8 meter high non-conductive stand at a 3 meter test distance from the receive antenna. A receiving antenna was placed on the antenna mast 3 meters from the EUT for emission measurements. The height of receiving antenna between 1.0m and 4.0m. Detected emissions were maximized at each frequency by rotating the EUT through 360° and adjusting the receiving antenna polarization. The radiated emission measurements of all transmit frequencies in three channels (High, Middle, Low) were measured with peak detector.
3. A log-periodic antenna or double-ridged waveguide horn antenna shall be substituted in place of the EUT. The log-periodic antenna will be driven by a signal generator and the level will be adjusted till the same power value on the spectrum analyzer or receiver. The level of the spurious emissions can be calculated through the level of the signal generator, cable loss, the gain of the substitution antenna and the reading of the spectrum analyzer or receiver.
4. The EUT is then put into continuously transmitting mode at its maximum power level during the test. Set Test Receiver or Spectrum RBW=1MHz, VBW=3MHz for above 1GHz and RBW=100kHz, VBW=300kHz for 30MHz to 1GHz,, And the maximum value of the receiver should be recorded as (Pr).
5. The EUT shall be replaced by a substitution antenna. In the chamber, a substitution antenna for the frequency band of interest is placed at the reference point of the chamber. An RF Signal source for the frequency band of interest is connected to the substitution antenna with a cable that has been constructed to not interfere with the radiation pattern of the antenna. A power (PMea) is applied to the input of the substitution antenna, and adjust the level of the signal generator output until the value of the receiver reach the previously recorded (Pr). The power of signal source (PMea) is recorded. The test should be performed by rotating the test item and adjusting the receiving antenna polarization.
6. A amplifier should be connected to the Signal Source output port. And the cable should be connect between the Amplifier and the Substitution Antenna. The cable loss (Pcl), the Substitution Antenna Gain (Ga) and the Amplifier Gain (PAg) should be recorded after test.
7. The measurement results are obtained as described below:
Power(EIRP)=PMea- PAg - Pcl + Ga
The measurement results are amend as described below:
Power(EIRP)=PMea- Pcl + Ga
8. This value is EIRP since the measurement is calibrated using an antenna of known gain (2.15 dBi) and known input power. ERP can be calculated from EIRP by subtracting the gain of the dipole, ERP = EIRP-2.15dBi.

Test configuration

30MHz~~~ 1GHz

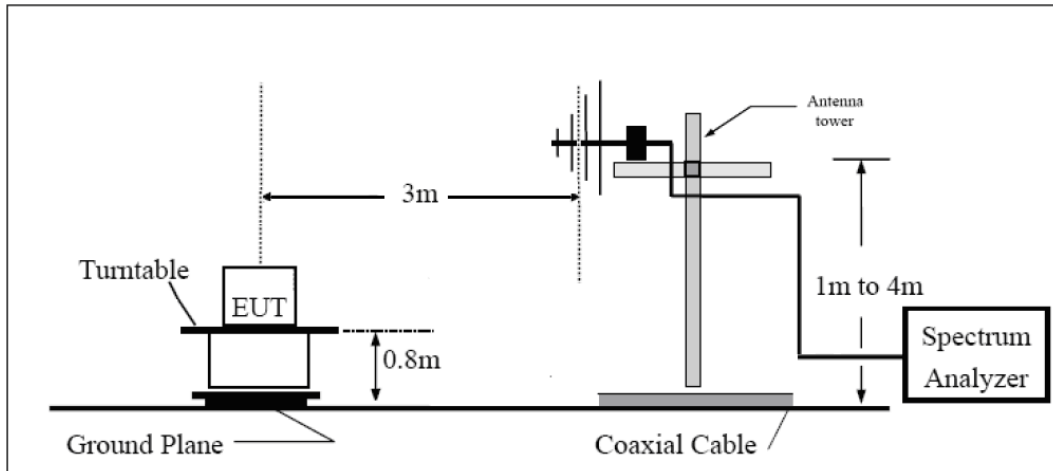

Above 1GHz

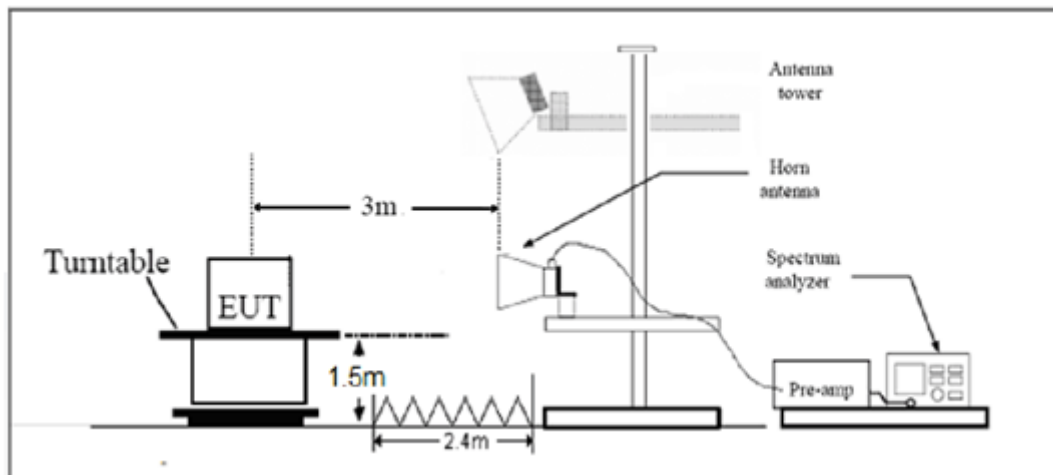

Limits

Rule Part 24.232(c) Mobile and portable stations are limited to 2 watts EIRP.

Rule Part 24.232(e) Peak transmit power must be measured over any interval of continuous transmission using instrumentation calibrated in terms of an rms-equivalent voltage.

Limit (EIRP)	$\leq 2\text{ W}$ (33 dBm)
--------------	----------------------------

Measurement Uncertainty

The assessed measurement uncertainty to ensure 95% confidence level for the normal distribution is with the coverage factor $k = 2$, $U = 1.19\text{ dB}$



Test Results:

Mode	Polarization	Frequency (MHz)	Rt (dBm)	Rs (dBm)	Ps (dBm)	Gs (dBi)	EIRP (dBm)	Limit (dBm)	Conclusion
GSM 1900	H	1850.2	-30.22	-53.21	0.00	1.92	24.91	33	Pass
	H	1880	-30.46	-53.42	0.00	1.94	24.90	33	Pass
	H	1909.8	-30.65	-53.67	0.00	1.90	24.92	33	Pass
	V	1850.2	-35.92	-53.70	0.00	1.92	19.70	33	Pass
	V	1880	-35.23	-53.91	0.00	1.94	20.62	33	Pass
	V	1909.8	-35.39	-54.55	0.00	1.90	21.06	33	Pass
GPRS 1900	H	1850.2	-16.43	-45.53	0.00	1.06	30.16	33	Pass
	H	1880	-16.75	-45.38	0.00	1.24	29.87	33	Pass
	H	1909.8	-17.36	-45.37	0.00	1.38	29.39	33	Pass
	V	1850.2	-29.61	-45.65	0.00	1.06	17.10	33	Pass
	V	1880	-31.34	-45.46	0.00	1.24	15.36	33	Pass
	V	1909.8	-33.48	-45.49	0.00	1.38	13.39	33	Pass
EGPRS 1900	H	1850.2	-28.95	-53.21	0.00	1.92	26.18	33	Pass
	H	1880	-28.87	-53.42	0.00	1.94	26.49	33	Pass
	H	1909.8	-28.91	-53.67	0.00	1.90	26.66	33	Pass
	V	1850.2	-34.75	-53.70	0.00	1.92	20.87	33	Pass
	V	1880	-34.41	-53.91	0.00	1.94	21.44	33	Pass
	V	1909.8	-34.29	-54.55	0.00	1.90	22.16	33	Pass
WCDMA Band II	H	1852.4	-31.72	-53.19	0.00	1.92	23.39	33	Pass
	H	1880	-32.96	-53.42	0.00	1.94	22.40	33	Pass
	H	1907.6	-32.14	-53.66	0.00	1.92	23.44	33	Pass
	V	1852.4	-37.09	-53.69	0.00	1.92	18.52	33	Pass
	V	1880	-38.71	-53.91	0.00	1.94	17.14	33	Pass
	V	1907.6	-39.61	-54.54	0.00	1.92	16.85	33	Pass

5.3.Occupied Bandwidth

Ambient condition

Temperature	Relative humidity	Pressure
23°C ~25°C	45%~50%	101.5kPa

Method of Measurement

The EUT was connected to Spectrum Analyzer and Base Station Simulator via power Splitter. The occupied bandwidth is measured using spectrum analyzer.

RBW is set to 3kHz, VBW is set to 10kHz for GSM 1900,

RBW is set to 51kHz, VBW is set to 160kHz for WCDMA Band II,

99% power and -26dBc occupied bandwidths are recorded. Spectrum analyzer plots are included on the following pages.

Test Setup

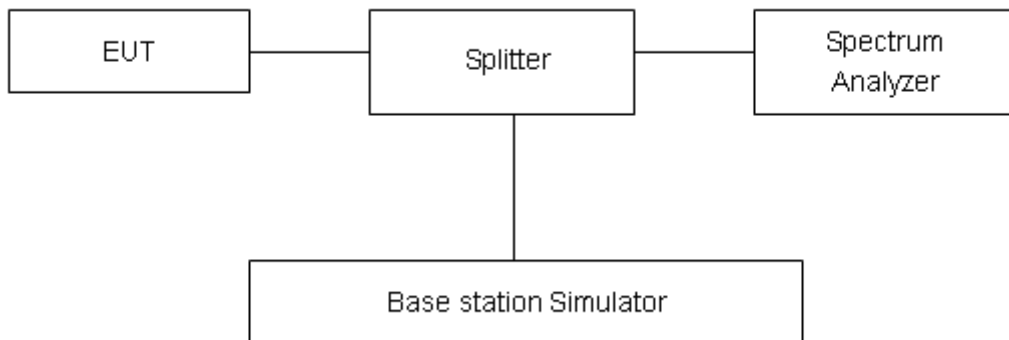

Limits

No specific occupied bandwidth requirements in part 2.1049.

Measurement Uncertainty

The assessed measurement uncertainty to ensure 95% confidence level for the normal distribution is with the coverage factor $k = 2$, $U = 624\text{Hz}$.

**Test Result**

Mode	Channel	Frequency (MHz)	99% Power Bandwidth (MHz)	-26dBc Bandwidth(MHz)
GSM 1900 (GSM)	512	1850.2	0.24782	0.3102
	661	1880.0	0.24630	0.3119
	810	1909.8	0.25029	0.3093
GPRS 1900 (GMSK)	512	1850.2	0.24413	0.3087
	661	1880.0	0.24224	0.3120
	810	1909.8	0.24656	0.3112
EGPRS 1900 (8-PSK)	512	1850.2	0.24827	0.3146
	661	1880.0	0.24848	0.3153
	810	1909.8	0.24480	0.3149
WCDMA Band II (RMC)	9262	1852.4	4.1529	4.712
	9400	1880	4.1505	4.695
	9538	1907.6	4.1405	4.704

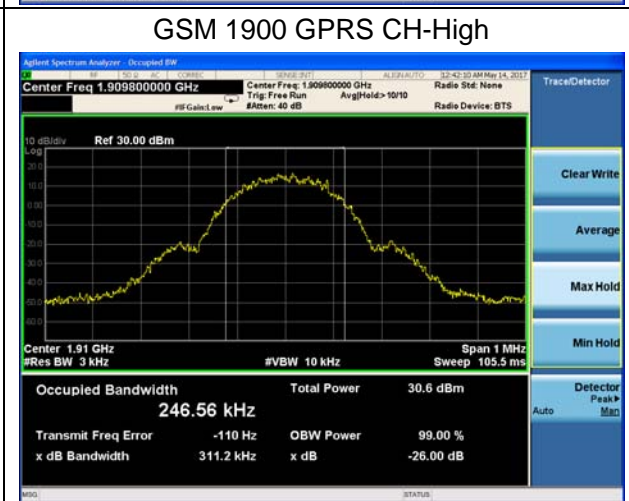
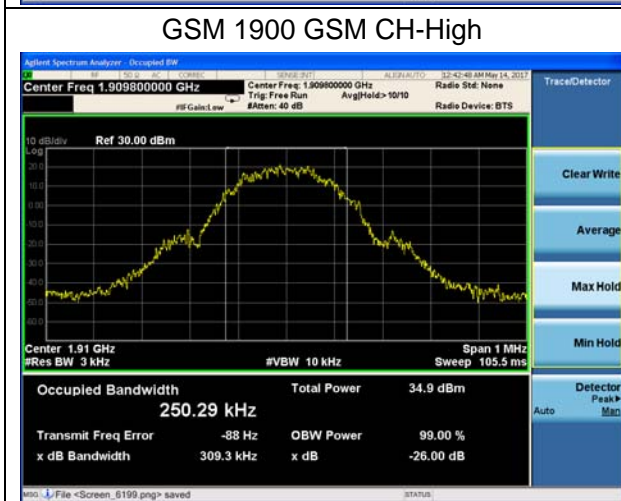
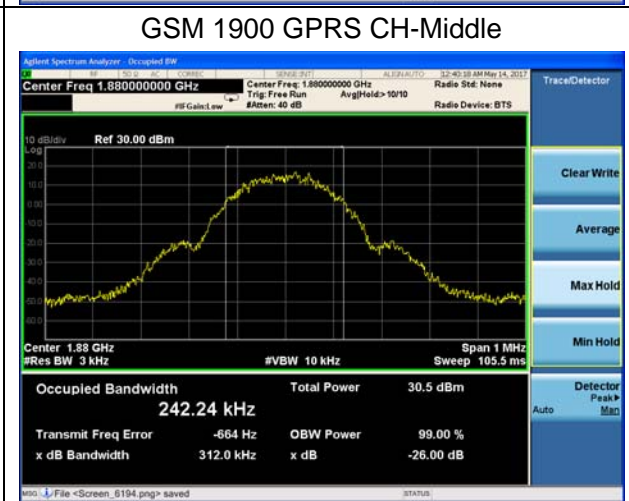
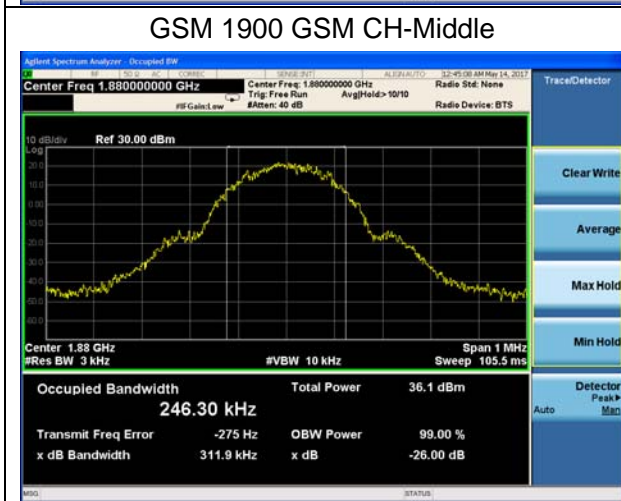
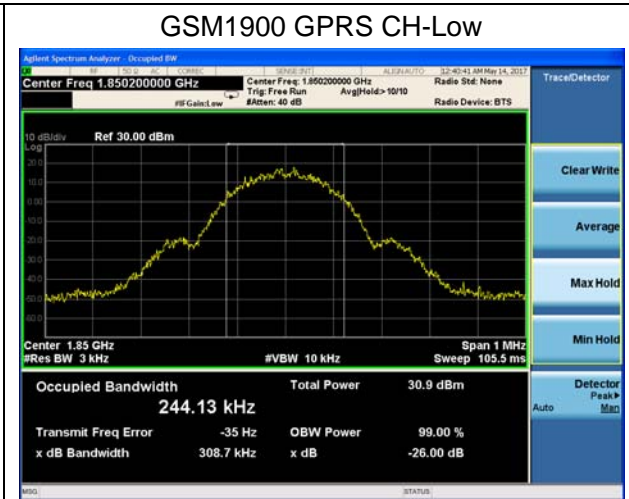
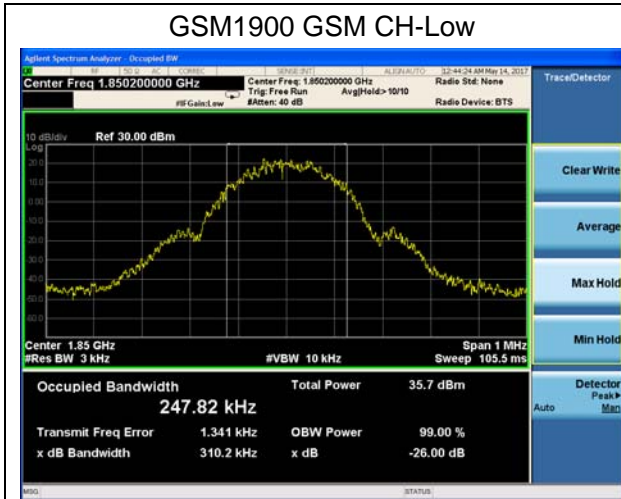

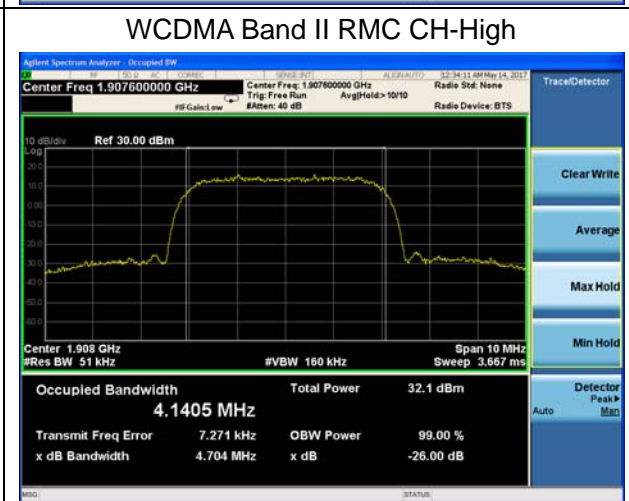
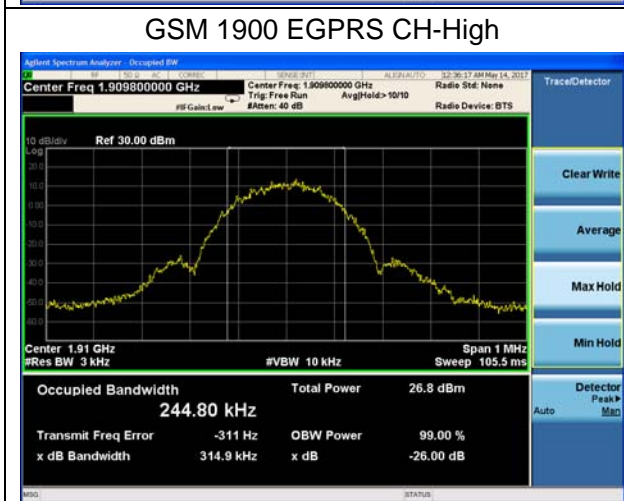
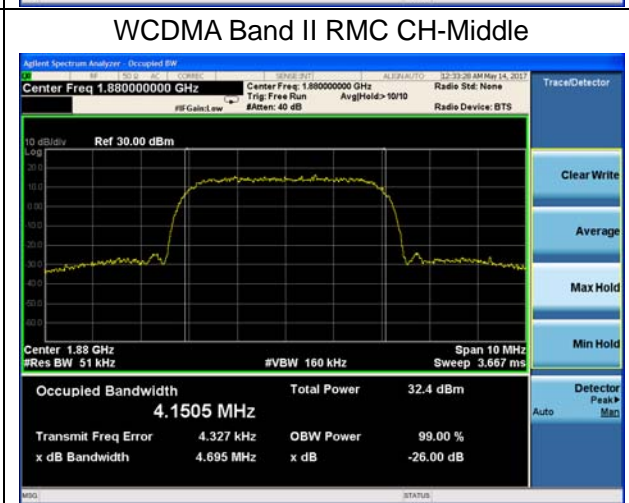
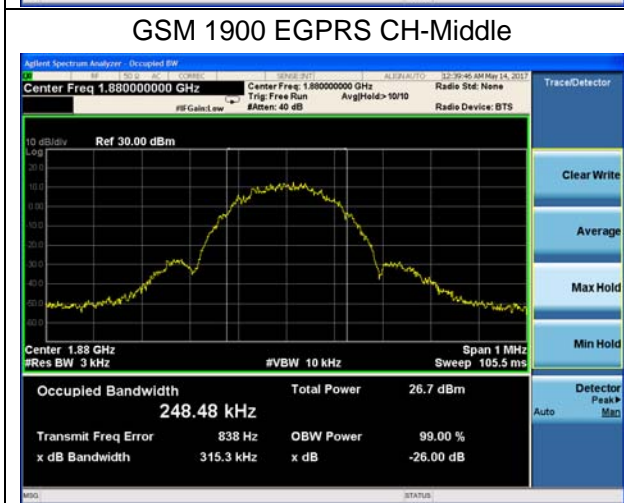
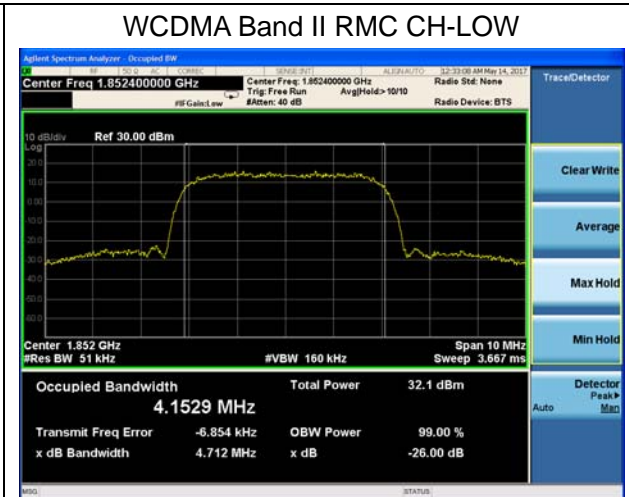
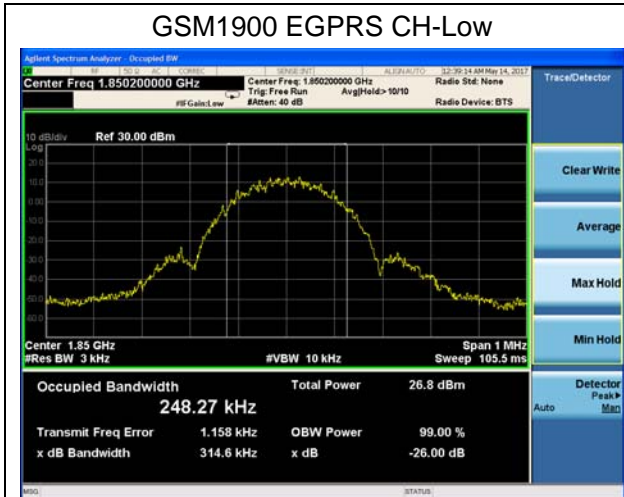

5.4. Band Edge Compliance

Ambient condition

Temperature	Relative humidity	Pressure
23°C ~25°C	45%~50%	101.5kPa

Method of Measurement

The EUT was connected to Spectrum Analyzer and Base Station Simulator via power Splitter. The band edge of the lowest and highest channels were measured. The Average detector is used and RBW is set to 3kHz, VBW is set to 10kHz for GSM 1900, RBW is set to 51kHz, VBW is set to 160kHz for WCDMA Band II, Spectrum analyzer plots are included on the following pages.

Test Setup

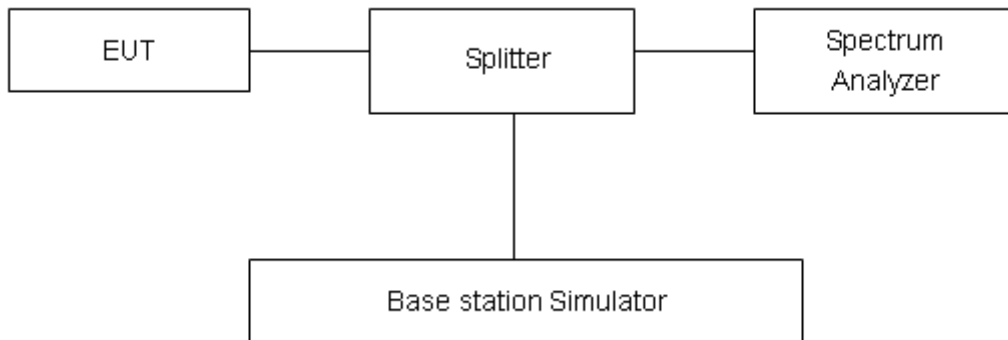

Limits

Rule Part 24.238(a) specifies that “on any frequency outside a licensee's frequency block, the power of any emission shall be attenuated below the transmitter power (P) by at least 43 + 10 log₁₀ (P) dB.”

Limit	-13 dBm
-------	---------

Measurement Uncertainty

The assessed measurement uncertainty to ensure 95% confidence level for the normal distribution is with the coverage factor $k = 1.96$, $U=0.684$ dB.



Test Result:

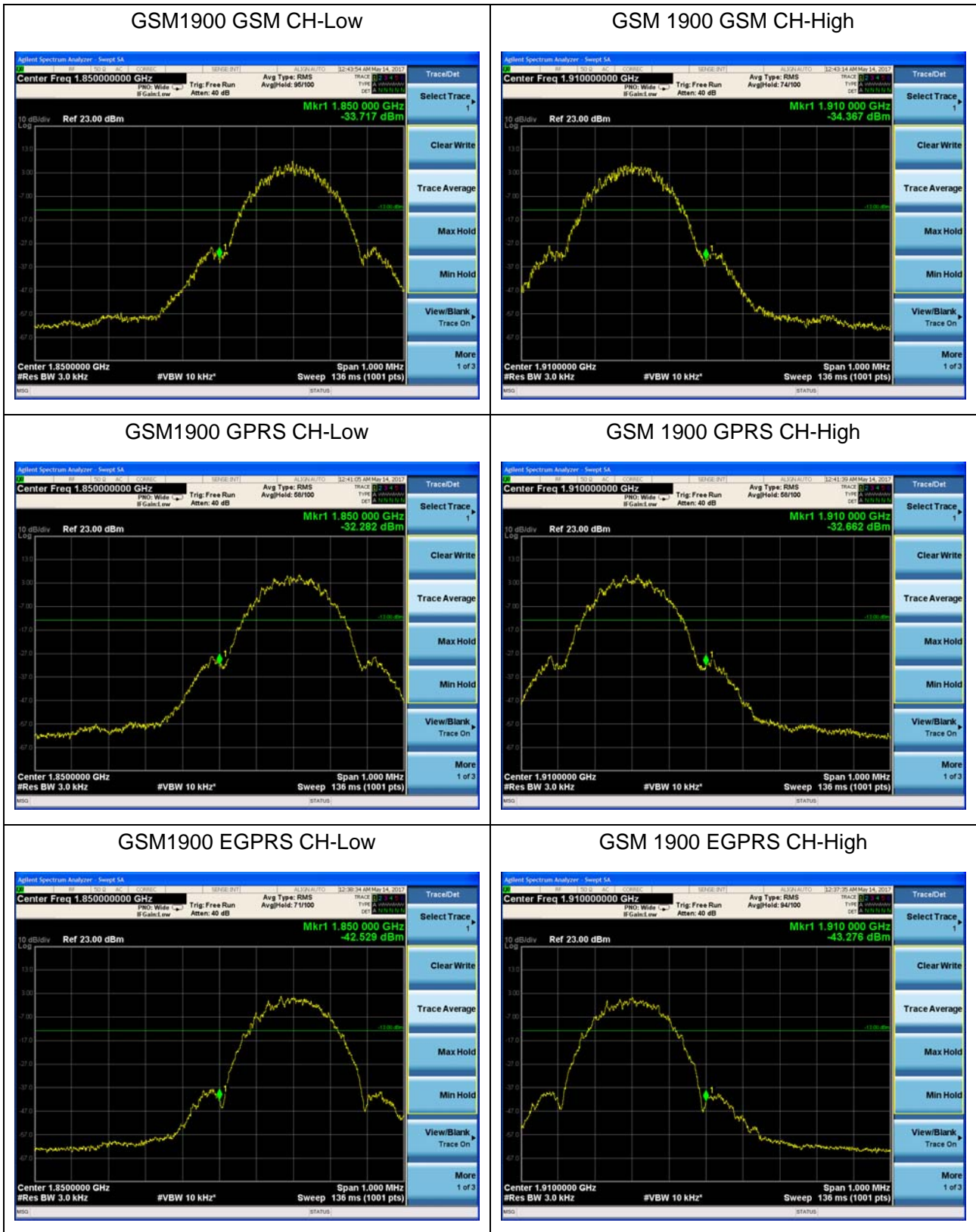

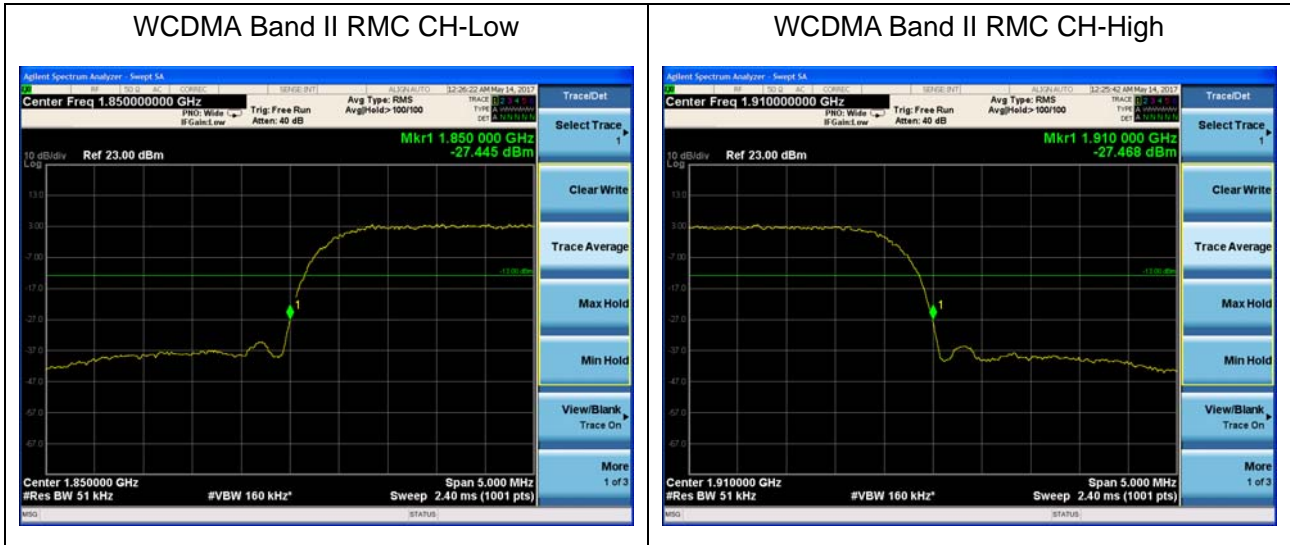

5.5. Peak-to-Average Power Ratio (PAPR)

Ambient condition

Temperature	Relative humidity	Pressure
23°C ~25°C	45%~50%	101.5kPa

Methods of Measurement

Measure the total peak power and record as PPk. And measure the total average power and record as PAvg. Both the peak and average power levels must be expressed in the same logarithmic units (e.g., dBm). Determine the PAPR from:

$$PAPR (dB) = PPk (dBm) - PAvg (dBm).$$

Test Setup

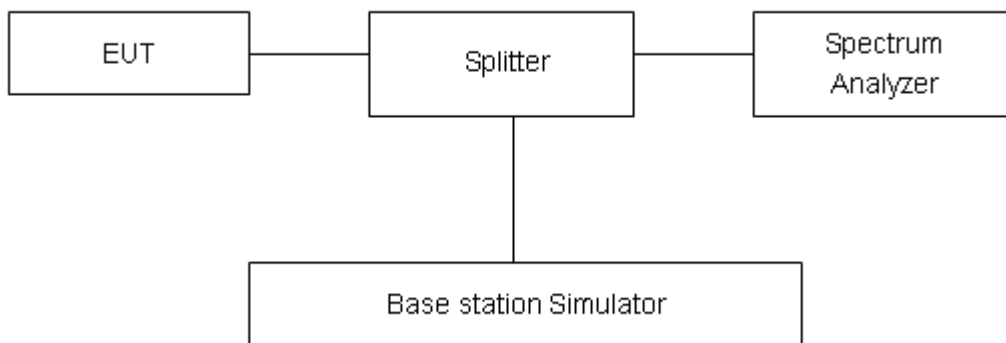

Limits

In measuring transmissions in this band using an average power technique, the peak-to-average ratio (PAR) of the transmission may not exceed 13 dB in 24.232(d).

Measurement Uncertainty

The assessed measurement uncertainty to ensure 95% confidence level for the normal distribution is with the coverage factor $k = 2$, $U = 0.4$ dB.

**Test Results**

Mode	Channel	Frequency (MHz)	Peak(dBm)	Avg(dBm)	PAPR(dB)	Limit(dB)	Conclusion
GSM 1900 (GSM)	512	1850.2	31.00	29.87	1.13	13	PASS
	661	1880	30.77	29.75	1.02	13	PASS
	810	1909.8	31.04	29.75	1.29	13	PASS
GPRS 1900 (GMSK)	512	1850.2	25.03	23.87	1.16	13	PASS
	661	1880	24.62	23.57	1.05	13	PASS
	810	1909.8	24.73	23.71	1.02	13	PASS
EGPRS 1900 (8-PSK)	512	1850.2	21.09	19.85	1.24	13	PASS
	661	1880	21.37	19.65	1.72	13	PASS
	810	1909.8	21.09	19.56	1.53	13	PASS
WCDMA Band II (RMC)	9262	1852.4	25.48	22.82	2.66	13	PASS
	9400	1880	25.63	22.88	2.75	13	PASS
	9538	1907.6	25.42	22.67	2.75	13	PASS

5.6. Frequency Stability

Ambient condition

Temperature	Relative humidity	Pressure
23°C ~25°C	45%~50%	101.5kPa

Method of Measurement

1. Frequency Stability (Temperature Variation)

The temperature inside the climate chamber is varied from -30°C to +50°C in 10°C step size,

(1) With all power removed, the temperature was decreased to 0°C and permitted to stabilize for three hours.

(2) Measure the carrier frequency with the test equipment in a “call mode”. These measurements should be made within 1 minute of powering up the mobile station, to prevent significant self warming.

(3) Repeat the above measurements at 10°C increments from -30°C to +50°C. Allow at least 1.5 hours at each temperature, un-powered, before making measurements.

2. Frequency Stability (Voltage Variation)

The frequency stability shall be measured with variation of primary supply voltage as follows:

(1) Vary primary supply voltage from 85 to 115 percent of the nominal value for other than hand carried battery equipment.

(2) For hand carried, battery powered equipment, reduce primary supply voltage to the battery-operating end point which shall be specified by the manufacturer.

This transceiver is specified to operate with an input voltage of between 3.6 V and 4.2 V, with a nominal voltage of 3.8V.

Test setup

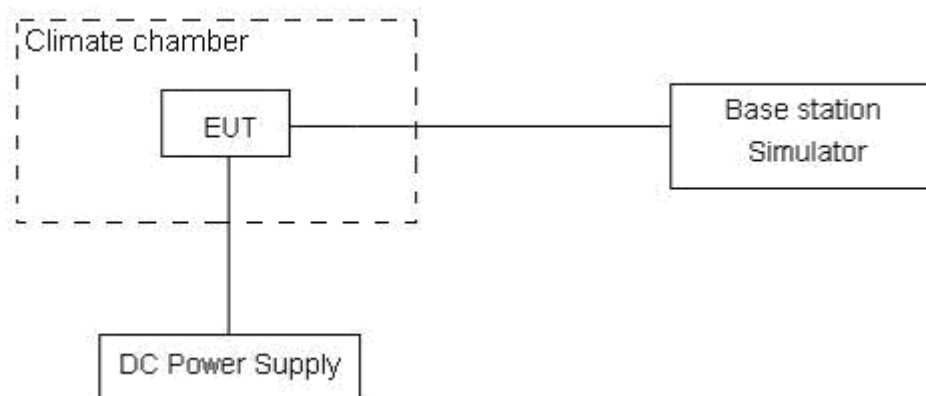



Limits

No specific frequency stability requirements in part 24.235

Measurement Uncertainty

The assessed measurement uncertainty to ensure 99.75% confidence level for the normal distribution is with the coverage factor $k = 3$, $U = 0.01\text{ppm}$.



Test Result

Mode	Test status	Test Results (ppm)		
		GSM(GMSK)	GPRS(GMSK)	EGPRS(8PSK)
GSM 1900 Middle Channel	50°C/Normal Voltage	0.0278	0.0413	0.0409
	40°C/Normal Voltage	0.0362	0.0418	0.0430
	30°C/Normal Voltage	0.0290	0.0402	0.0429
	20°C/Normal Voltage	0.0295	0.0385	0.0437
	10°C/Normal Voltage	0.0322	0.0382	0.0431
	0°C/Normal Voltage	0.0288	0.0391	0.0424
	-10°C/Normal Voltage	0.0280	0.0384	0.0439
	-20°C/Normal Voltage	0.0292	0.0415	0.0438
	-30°C/Normal Voltage	0.0268	0.0401	0.0429
	20°C/Max Voltage	0.0275	0.0467	0.0466
	20°C/Min Voltage	0.0323	0.0457	0.0466
/	/	RMC		
WCDMA Band II Middle Channel	50°C/Normal Voltage	0.003552		
	40°C/Normal Voltage	0.002768		
	30°C/Normal Voltage	-0.002440		
	20°C/Normal Voltage	-0.007543		
	10°C/Normal Voltage	0.004037		
	0°C/Normal Voltage	-0.003547		
	-10°C/Normal Voltage	-0.006214		
	-20°C/Normal Voltage	-0.001065		
	-30°C/Normal Voltage	-0.005781		
	20°C/Max Voltage	0.006859		
	20°C/Min Voltage	-0.003338		

5.7. Spurious Emissions at Antenna Terminals

Ambient condition

Temperature	Relative humidity	Pressure
23°C ~25°C	45%~50%	101.5kPa

Method of Measurement

The EUT was connected to Spectrum Analyzer and Base Station Simulator via power Splitter. The measurement is carried out using a spectrum analyzer. The spectrum analyzer scans from 9kHz to the 10th harmonic of the carrier. The peak detector is used. RBW and VBW are set to 100 kHz for the carrier frequency, or RBW and VBW are set to 1MHz (other frequency), Sweep is set to ATUO.

Test setup

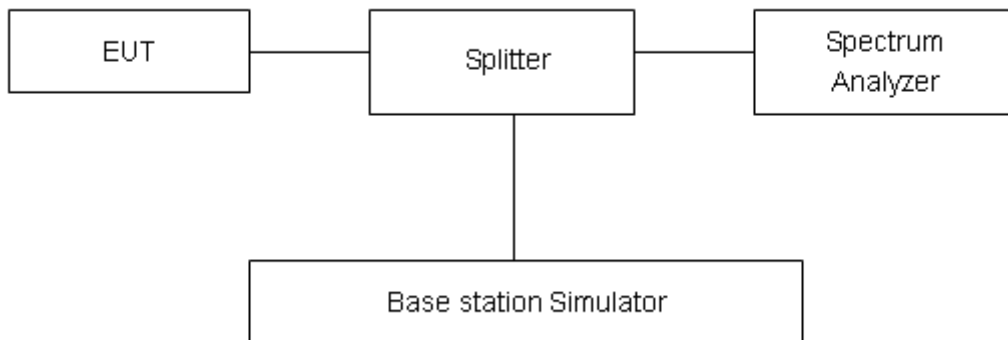

Limits

Rule Part 24.238(a) specifies that “on any frequency outside a licensee’s frequency block, the power of any emission shall be attenuated below the transmitter power (P) by at least 43 + 10 log₁₀ (P) dB.”

Limit	-13 dBm

Measurement Uncertainty

The assessed measurement uncertainty to ensure 99.75% confidence level for the normal distribution is with the coverage factor $k = 1.96$.

Frequency	Uncertainty
100kHz-2GHz	0.684 dB
2GHz-18GHz	1.407 dB

Test Result

Sweep from 9 kHz to 30MHz, and the emissions more than 20 dB below the permissible value are not reported.

If disturbances were found more than 20dB below limit line, the mark is not required for the EUT. The signal beyond the limit is carrier.

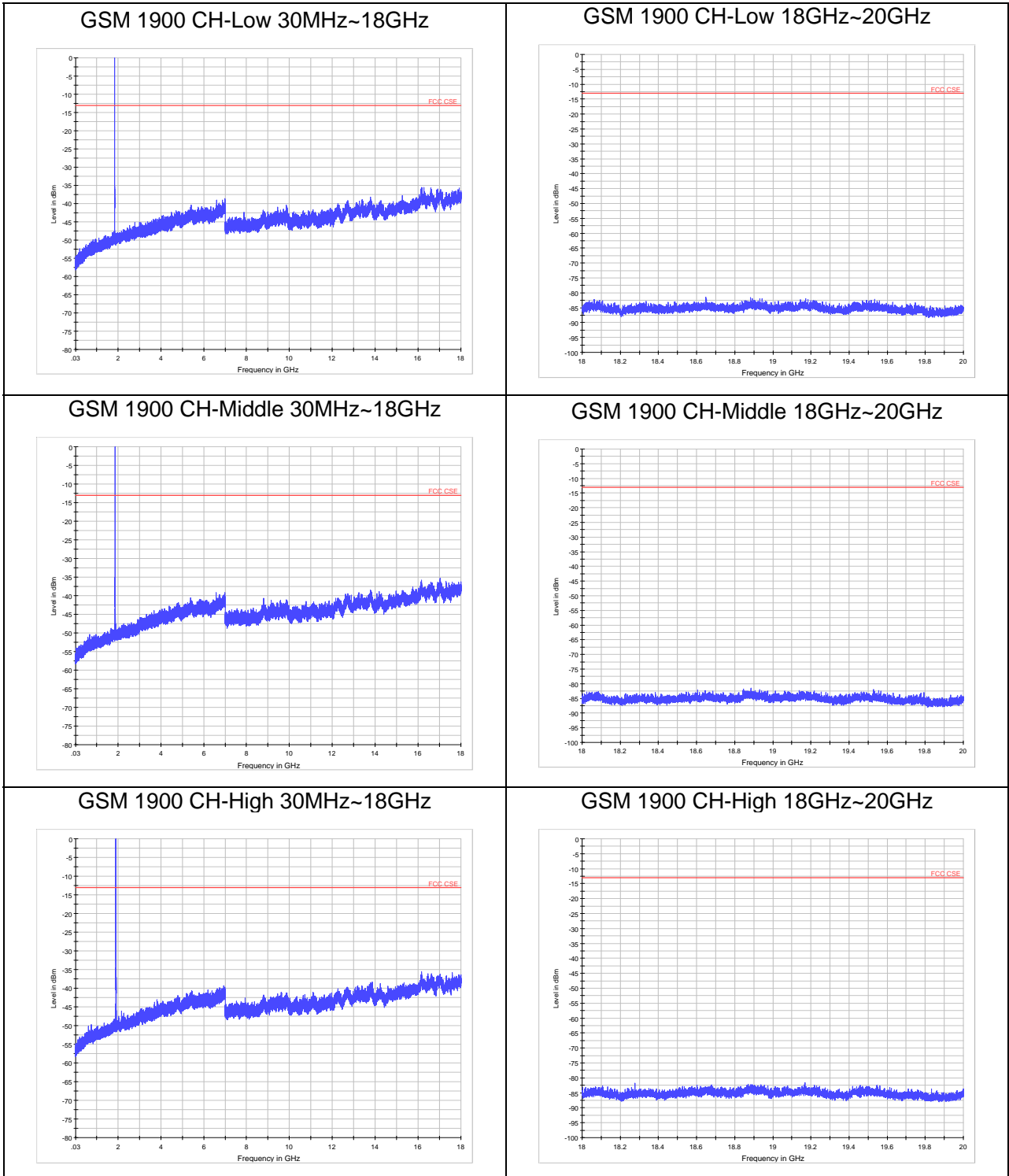



WCDMA Band II CH-Low 30MHz~18GHz

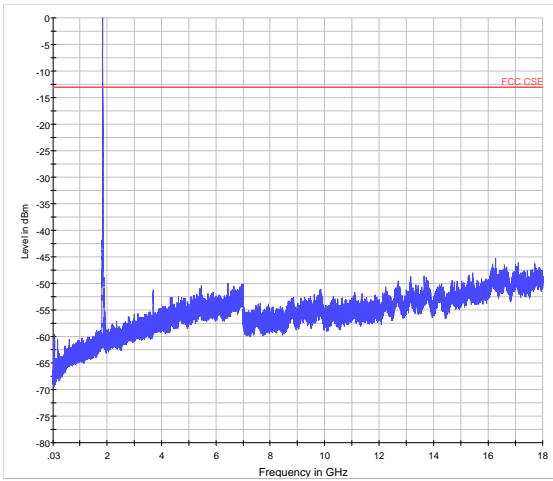

WCDMA Band II CH-Low 18GHz~20GHz

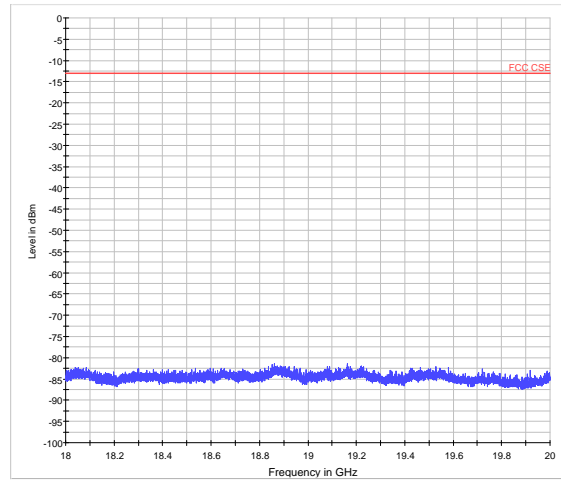

WCDMA Band II CH-Middle 30MHz~18GHz

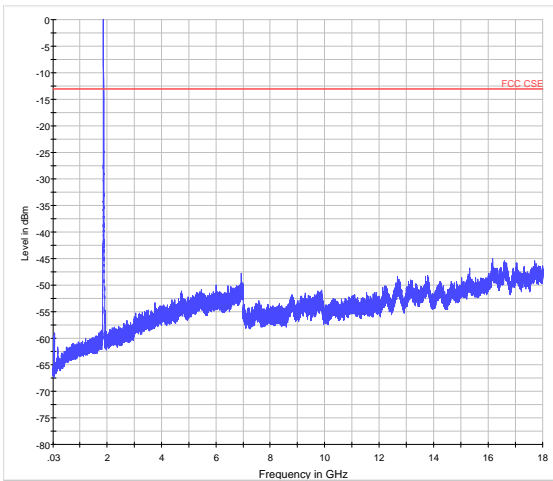

WCDMA Band II CH-Middle 18GHz~20GHz

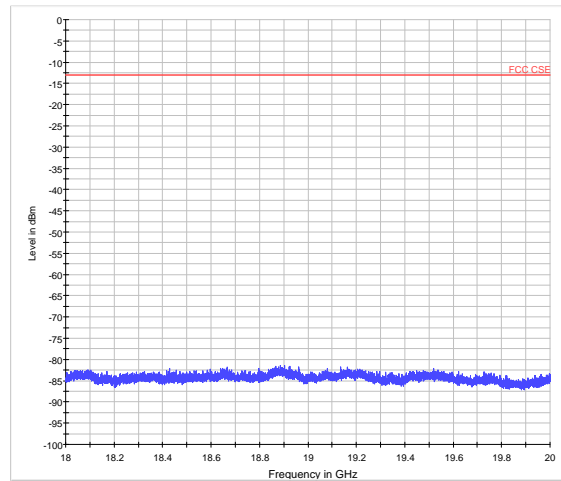

WCDMA Band II CH-High 30MHz~18GHz

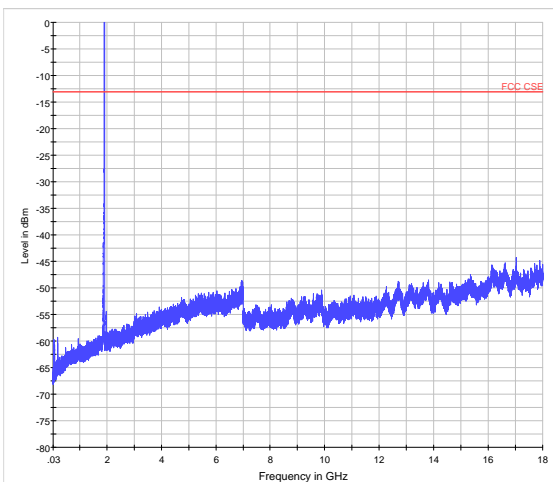

WCDMA Band II CH-High 18GHz~20GHz

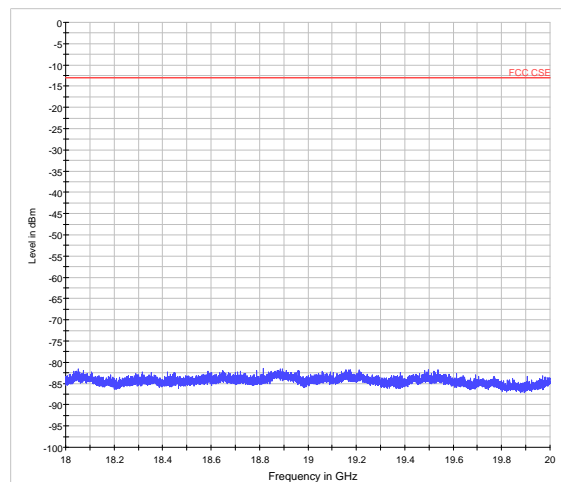

5.8. Radiates Spurious Emission

Ambient condition

Temperature	Relative humidity	Pressure
23°C ~25°C	45%~50%	101.5kPa

Method of Measurement

1. The testing follows FCC KDB 971168 v02r02 Section 5.8 and ANSI / TIA-603-D-2010 Section 2.2.12.
2. Above 30MHz: The EUT is placed on a turntable 0.8 meters above the ground in the chamber, 3 meter away from the antenna. The maximal emission value is acquired by adjusting the antenna height, polarisation and turntable azimuth. Normally, the height range of antenna is 1 m to 4 m, the azimuth range of turntable is 0° to 360°, and the receive antenna has two polarizations Vertical (V) and Horizontal (H). Above 1GHz: (Note: the FCC's permission to use 1.5m as an alternative per TCBC Conf call of Dec. 2, 2014.) The EUT is placed on a turntable 1.5 meters above the ground in the chamber, 3 meter away from the antenna. The maximal emission value is acquired by adjusting the antenna height, polarisation and turntable azimuth. Normally, the height range of antenna is 1 m to 4 m, the azimuth range of turntable is 0° to 360°, and the receive antenna has two polarizations Vertical (V) and Horizontal (H).
3. A log-periodic antenna or double-ridged waveguide horn antenna shall be substituted in place of the EUT. The log-periodic antenna will be driven by a signal generator and the level will be adjusted till the same power value on the spectrum analyzer or receiver. The level of the spurious emissions can be calculated through the level of the signal generator, cable loss, the gain of the substitution antenna and the reading of the spectrum analyzer or receiver.
4. The EUT is then put into continuously transmitting mode at its maximum power level during the test. Set Test Receiver or Spectrum RBW=1MHz, VBW=3MHz for above 1GHz and RBW=100kHz, VBW=300kHz for 30MHz to 1GHz., And the maximum value of the receiver should be recorded as (Pr).
5. The EUT shall be replaced by a substitution antenna. In the chamber, an substitution antenna for the frequency band of interest is placed at the reference point of the chamber. An RF Signal source for the frequency band of interest is connected to the substitution antenna with a cable that has been constructed to not interfere with the radiation pattern of the antenna. A power (PMea) is applied to the input of the substitution antenna, and adjust the level of the signal generator output until the value of the receiver reach the previously recorded (Pr). The power of signal source (PMea) is recorded. The test should be performed by rotating the test item and adjusting the receiving antenna polarization.
6. A amplifier should be connected to the Signal Source output port. And the cable should be connect between the Amplifier and the Substitution Antenna. The cable loss (Pcl) ,the Substitution Antenna Gain (Ga) and the Amplifier Gain (PAg) should be recorded after test.
7. The measurement results are obtained as described below:
Power(EIRP)=PMea- PAg - Pcl + Ga
The measurement results are amend as described below:
Power(EIRP)=PMea- Pcl + Ga

7. This value is EIRP since the measurement is calibrated using an antenna of known gain (2.15 dBi) and known input power. ERP can be calculated from EIRP by subtracting the gain of the dipole, $ERP = EIRP - 2.15\text{dBi}$.

Test setup

30MHz~~~ 1GHz

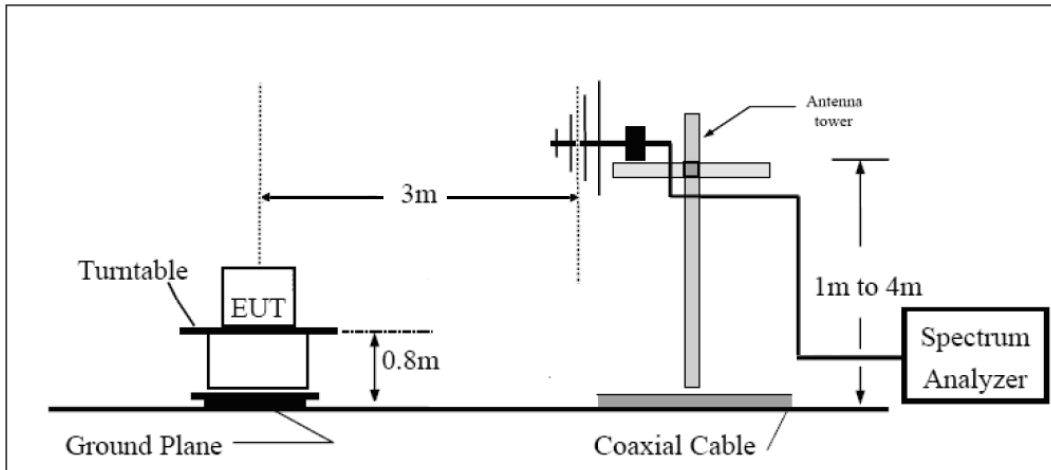

Above 1GHz

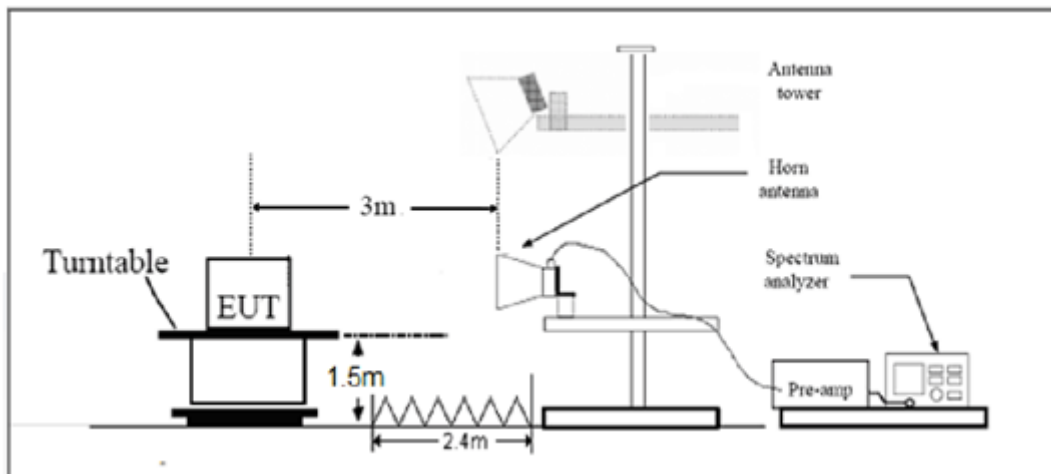

Note: Area side: 2.4mX3.6m

The radiated emission was measured in the following position: EUT stand-up position (Z axis), lie-down position (X, Y axis). The worst emission was found in stand-up position (Z axis) and the worst case was recorded.

Limits

Rule Part 24.238(a) specifies that “on any frequency outside a licensee's frequency block, the power of any emission shall be attenuated below the transmitter power (P) by at least $43 + 10 \log_{10} (P)$ dB.”

Limit	-13 dBm
-------	---------

Measurement Uncertainty

The assessed measurement uncertainty to ensure 95% confidence level for the normal distribution is with the coverage factor $k = 1.96$, $U = 3.55$ dB.

**Test Result**

GSM 1900 CH-Low

Harmonic	Frequency (MHz)	SG (dBm)	Cable Loss (dB)	Gain (dBi)	Antenna Polarization	EIRP Level (dBm)	Limit (dBm)	Margin (dB)	Azimuth (deg)
2	3700.4	-56.45	5.1	11.05	vertical	-50.5	-13	37.5	225
3	5550.6	-53.93	5.42	12.65	vertical	-46.7	-13	33.7	135
4	7400.8	-49.15	6.7	13.85	vertical	-42.0	-13	29.0	90
5	9251.0	-46.14	7.01	14.75	vertical	-38.4	-13	25.4	90
6	11101.2	-45.17	7.48	15.95	vertical	-36.7	-13	23.7	135
7	12951.4	-45.34	7.51	16.55	vertical	-36.3	-13	23.3	270
8	14801.6	-41.81	8.24	15.35	vertical	-34.7	-13	21.7	225
9	16651.8	-43.14	8.41	14.95	vertical	-36.6	-13	23.6	180
10	18502.0	-41.21	8.54	15.45	vertical	-34.3	-13	21.3	45

Note: 1. The other Spurious RF Radiated emissions level is no more than noise floor.
2. The worst emission was found in the antenna is vertical position.

GSM 1900 CH-Middle

Harmonic	Frequency (MHz)	SG (dBm)	Cable Loss (dB)	Gain (dBi)	Antenna Polarization	EIRP Level (dBm)	Limit (dBm)	Margin (dB)	Azimuth (deg)
2	3760.0	-56.65	5.1	11.05	vertical	-50.7	-13	37.7	90
3	5640.0	-54.63	5.42	12.65	vertical	-47.4	-13	34.4	225
4	7520.0	-49.35	6.7	13.85	vertical	-42.2	-13	29.2	135
5	9400.0	-46.94	7.01	14.75	vertical	-39.2	-13	26.2	90
6	11280.0	-44.57	7.48	15.95	vertical	-36.1	-13	23.1	135
7	13160.0	-45.34	7.51	16.55	vertical	-36.3	-13	23.3	270
8	15040.0	-44.11	8.24	15.35	vertical	-37.0	-13	24.0	225
9	16920.0	-41.54	8.41	14.95	vertical	-35.0	-13	22.0	180
10	18800.0	-41.31	8.54	15.45	vertical	-34.4	-13	21.4	45

Note: 1. The other Spurious RF Radiated emissions level is no more than noise floor.
2. The worst emission was found in the antenna is vertical position.



GSM 1900 CH-High

Harmonic	Frequency (MHz)	SG (dBm)	Cable Loss (dB)	Gain (dBi)	Antenna Polarization	EIRP Level (dBm)	Limit (dBm)	Margin (dB)	Azimuth (deg)
2	3819.6	-56.55	5.1	11.05	vertical	-50.6	-13	37.6	90
3	5729.4	-53.93	5.42	12.65	vertical	-46.7	-13	33.7	225
4	7639.2	-48.45	6.7	13.85	vertical	-41.3	-13	28.3	135
5	9549.0	-48.84	7.01	14.75	vertical	-41.1	-13	28.1	90
6	11458.8	-46.07	7.48	15.95	vertical	-37.6	-13	24.6	135
7	13368.6	-46.14	7.51	16.55	vertical	-37.1	-13	24.1	270
8	15278.4	-44.31	8.24	15.35	vertical	-37.2	-13	24.2	225
9	17188.2	-41.24	8.41	14.95	vertical	-34.7	-13	21.7	180
10	19098.0	-41.01	8.54	15.45	vertical	-34.1	-13	21.1	45

Note: 1.The other Spurious RF Radiated emissions level is no more than noise floor.
2. The worst emission was found in the antenna is vertical position.

WCDMA Band II CH-Low

Harmonic	Frequency (MHz)	SG (dBm)	Cable Loss (dB)	Gain (dBi)	Antenna Polarization	EIRP Level (dBm)	Limit (dBm)	Margin (dB)	Azimuth (deg)
2	3704.8	-55.75	5.1	11.05	vertical	-49.8	-13	36.8	180
3	5557.2	-53.33	5.42	12.65	vertical	-46.1	-13	33.1	45
4	7409.6	-51.85	6.7	13.85	vertical	-44.7	-13	31.7	90
5	9262.0	-48.54	7.01	14.75	vertical	-40.8	-13	27.8	225
6	11114.4	-47.97	7.48	15.95	vertical	-39.5	-13	26.5	135
7	12966.8	-45.44	7.51	16.55	vertical	-36.4	-13	23.4	90
8	14819.2	-41.81	8.24	15.35	vertical	-34.7	-13	21.7	90
9	16671.6	-43.34	8.41	14.95	vertical	-36.8	-13	23.8	135
10	18524.0	-40.71	8.54	15.45	vertical	-33.8	-13	20.8	270

Note: 1.The other Spurious RF Radiated emissions level is no more than noise floor.
2. The worst emission was found in the antenna is vertical position.



WCDMA Band II CH-Middle

Harmonic	Frequency (MHz)	SG (dBm)	Cable Loss (dB)	Gain (dBi)	Antenna Polarization	EIRP Level (dBm)	Limit (dBm)	Margin (dB)	Azimuth (deg)
2	3760.0	-55.65	5.1	11.05	vertical	-49.7	-13	36.7	225
3	5640.0	-55.83	5.42	12.65	vertical	-48.6	-13	35.6	180
4	7520.0	-51.45	6.7	13.85	vertical	-44.3	-13	31.3	45
5	9400.0	-49.44	7.01	14.75	vertical	-41.7	-13	28.7	90
6	11280.0	-47.67	7.48	15.95	vertical	-39.2	-13	26.2	225
7	13160.0	-45.84	7.51	16.55	vertical	-36.8	-13	23.8	135
8	15040.0	-43.41	8.24	15.35	vertical	-36.3	-13	23.3	90
9	16920.0	-40.64	8.41	14.95	vertical	-34.1	-13	21.1	135
10	18800.0	-41.11	8.54	15.45	vertical	-34.2	-13	21.2	270

Note: 1. The other Spurious RF Radiated emissions level is no more than noise floor.
2. The worst emission was found in the antenna is vertical position.

WCDMA Band II CH-High

Harmonic	Frequency (MHz)	SG (dBm)	Cable Loss (dB)	Gain (dBi)	Antenna Polarization	EIRP Level (dBm)	Limit (dBm)	Margin (dB)	Azimuth (deg)
2	3815.2	-55.25	5.1	11.05	vertical	-49.3	-13	36.3	225
3	5722.8	-53.73	5.42	12.65	vertical	-46.5	-13	33.5	180
4	7630.4	-50.45	6.7	13.85	vertical	-43.3	-13	30.3	45
5	9538.0	-49.04	7.01	14.75	vertical	-41.3	-13	28.3	90
6	11445.6	-47.47	7.48	15.95	vertical	-39.0	-13	26.0	225
7	13353.2	-45.24	7.51	16.55	vertical	-36.2	-13	23.2	180
8	15260.8	-41.91	8.24	15.35	vertical	-34.8	-13	21.8	45
9	17168.4	-41.94	8.41	14.95	vertical	-35.4	-13	22.4	90
10	19076.0	-41.31	8.54	15.45	vertical	-34.4	-13	21.4	225

Note: 1. The other Spurious RF Radiated emissions level is no more than noise floor.
2. The worst emission was found in the antenna is vertical position.



6. Main Test Instruments

Name	Type	Manufacturer	Serial Number	Calibration Date	Expiration Time
Base Station Simulator	CMU200	R&S	118133	2016-05-21	2017-05-20
Power Splitter	SHX-GF2-2-13	Hua Xiang	10120101	2016-05-21	2017-05-20
Spectrum Analyzer	N9010A	Agilent	MY47191109	2016-05-21	2017-05-20
Universal Radio Communication Tester	E5515C	Agilent	MY48367192	2016-05-21	2017-05-20
Signal Analyzer	FSV30	R&S	100815	2016-12-16	2017-12-15
Signal generator	SMB 100A	R&S	102594	2016-05-22	2017-05-21
Signal generator	SMR27	R&S	100365	2016-05-22	2017-05-21
EMI Test Receiver	ESCI	R&S	100948	2016-06-01	2017-05-31
Trilog Antenna	VUBL 9163	SCHWARZBECK	9163-201	2014-12-06	2017-12-05
Trilog Antenna	VUBL 9163	SCHWARZBECK	9163-391	2014-12-06	2017-12-05
Horn Antenna	HF907	R&S	100126	2014-12-06	2017-12-05
Horn Antenna	HF907	R&S	100125	2014-12-06	2017-12-05
Climatic Chamber	PT-30B	Re Ce	20101891	2016-07-17	2017-07-16
Horn Antenna	3160-09	ETS-Lindgren	00102644	2015-01-30	2018-01-29
RF Cable	SMA 15cm	Agilent	0001	2017-02-06	2017-08-05

*****END OF REPORT *****