



中国认可  
国际互认  
检测  
TESTING  
CNAS L0310



# FCC

# RF Test Report

**Product Name: Smart Phone**

**Model Number: HWV31**

**Report No: SYBH(Z-RF)005112017-2001**

**FCC ID: QISPIC-LX9**

**Reliability Laboratory of Huawei Technologies Co., Ltd.**

**(Global Compliance and Testing Center of Huawei Technologies Co., Ltd)**

Administration Building, Headquarters of Huawei Technologies Co., Ltd., Bantian, Longgang District,  
Shenzhen, 518129, P.R.C

Tel: +86 755 28780808 Fax: +86 755 89652518



## Notice

1. The laboratory has passed the accreditation by China National Accreditation Service for Conformity Assessment (CNAS). The accreditation number is L0310.
2. The laboratory has passed the accreditation by The American Association for Laboratory Accreditation (A2LA). The accreditation number is 2174.01
3. The laboratory has been recognized by the US Federal Communications Commission (FCC) to perform compliance testing subject to the Commission's Certification rules. The Designation Number is CN1173, and the Test Firm Registration Number is 294140.
4. The laboratory has been listed by Industry Canada to perform electromagnetic emission measurements. The recognition numbers of test site are 6369A-1.
5. The laboratory (Reliability Lab of Huawei Technologies Co., Ltd) is also named "Global Compliance and Testing Center of Huawei Technologies Co., Ltd", the both names have coexisted since 2009.
6. The test report is invalid if not marked with the signatures of the persons responsible for preparing and approving the test report.
7. The test report is invalid if there is any evidence of erasure and/or falsification.
8. The test report is only valid for the test samples.
9. Content of the test report, in part or in full, cannot be used for publicity and/or promotional purposes without prior written approval from the laboratory.



**Applicant:** Huawei Technologies Co., Ltd.  
**Address:** Administration Building, Headquarters of Huawei Technologies Co., Ltd.,  
 Bantian, Longgang District, Shenzhen, 518129, P.R.C

**Date of Receipt Sample:** 2017-11-14  
**Start Date of Test:** 2017-11-14  
**End Date of Test:** 2017-12-23

**Test Result:** Pass

<b>Approved by Senior Engineer:</b>	2017-12-23	Roger Zhang	<i>Roger Zhang</i>
	Date	Name	Signature

<b>Prepared by:</b>	2017-12-23	Zhang Shuangxia	<i>Zhang Shuangxia</i>
	Date	Name	Signature



**CONTENT**

1 General Information.....5  
1.1 Applied Standard.....5  
1.2 Test Location .....5  
1.3 Test Environment Condition.....5  
2 Test Summary .....6  
2.1 Cellular Band (824-849 MHz paired with 869-894 MHz) .....6  
2.2 PCS Band (1850-1910 MHz paired with 1930-1990 MHz).....7  
2.3 BRS&EBS Band (2500-2570 MHz paired with 2620-2690 MHz) .....8  
2.4 BRS&EBS Band38 (2570-2620 MHz paired with 2570-2620 MHz) .....9  
2.5 BRS&EBS Band41 (2545-2655 MHz paired with 2545-2655 MHz) .....10  
3 Description of the Equipment under Test (EUT) .....11  
3.1 General Description .....11  
3.2 EUT Identity .....11  
3.3 Technical Specification .....12  
4 General Test Conditions / Configurations .....14  
4.1 Test Modes .....14  
4.2 Test Environment.....14  
4.3 Test Frequency.....15  
4.4 DESCRIPTION OF TESTS .....19  
4.5 Test Setups.....25  
4.6 Test Conditions .....28  
5 Main Test Instruments .....30  
6 Measurement Uncertainty.....31  
7 Appendixes.....31



## 1 General Information

### 1.1 Applied Standard

Applied Rules:                   47 CFR FCC Part 02  
  47 CFR FCC Part 22  
  47 CFR FCC Part 24  
  47 CFR FCC Part 27

Test Method:                    FCC KDB 971168 D01 Power Meas License Digital Systems v03

### 1.2 Test Location

Test Location :                 Reliability Laboratory of Huawei Technologies Co., Ltd.  
Address:                         Administration Building, Headquarters of Huawei Technologies Co., Ltd.,  
  Bantian, Longgang District, Shenzhen, 518129, P.R.C

### 1.3 Test Environment Condition

Ambient Temperature:         19.5 to 25 °C  
Ambient Relative Humidity:   40 to 55 %  
Atmospheric Pressure:        Not applicable



## 2 Test Summary

### 2.1 Cellular Band (824-849 MHz paired with 869-894 MHz)

Test Item	FCC Rule No.	Requirements	Test Result	Verdict (Note1)
Effective (Isotropic) Radiated Power Output Data	§2.1046, §22.913	FCC: ERP ≤ 7 W.	Appendix A	Pass
Peak-Average Ratio	---	Limits ≤ 13 dB	Appendix B	Pass
Modulation Characteristics	§2.1047	Digital modulation	Appendix C	Pass
Bandwidth	§2.1049	OBW: No limit. EBW: No limit.	Appendix D	Pass
Band Edges Compliance	§2.1051, §22.917	≤ -13 dBm/1%*EBW, in 1 MHz bands immediately outside and adjacent to the frequency block.	Appendix E	Pass
Spurious Emission at Antenna Terminals	§2.1051, §22.917	FCC: ≤ -13 dBm/100 kHz, from 9 kHz to 10 <sup>th</sup> harmonics but outside authorized operating frequency ranges.	Appendix F	Pass
Field Strength of Spurious Radiation	§2.1053, §22.917	FCC: ≤ -13 dBm/100 kHz.	Appendix G	Pass
Frequency Stability	§2.1055, §22.355	≤ ±2.5ppm.	Appendix H	Pass

NOTE: For the verdict, the "N/A" denotes "not applicable", the "N/T" denotes "not tested".

**2.2 PCS Band (1850-1910 MHz paired with 1930-1990 MHz)**

Test Item	FCC Rule No.	Requirements	Test Result	Verdict (Note1)
Effective (Isotropic) Radiated Power Output Data	§2.1046, §24.232	$EIRP \leq 2\text{ W}$	Appendix A	Pass
Peak-Average Ratio	§2.1046, §24.232	Limits $\leq 13\text{ dB}$	Appendix B	Pass
Modulation Characteristics	§2.1047	Digital modulation	Appendix C	Pass
Bandwidth	§2.1049	OBW: No limit. EBW: No limit.	Appendix D	Pass
Band Edges Compliance	§2.1051, §24.238	$\leq -13\text{ dBm}/1\% \cdot \text{EBW}$ , in 1 MHz bands immediately outside and adjacent to the frequency block.	Appendix E	Pass
Spurious Emission at Antenna Terminals	§2.1051, §24.238	$\leq -13\text{ dBm}/1\text{ MHz}$ , from 9 kHz to $10^{\text{th}}$ harmonics but outside authorized operating frequency ranges.	Appendix F	Pass
Field Strength of Spurious Radiation	§2.1053, §24.238	$\leq -13\text{ dBm}/1\text{ MHz}$ .	Appendix G	Pass
Frequency Stability	§2.1055, §24.235	$\leq \pm 2.5\text{ ppm}$ .	Appendix H	Pass
NOTE: For the verdict, the "N/A" denotes "not applicable", the "N/T" denotes "not tested".				

**2.3 BRS&EBS Band7 (2500-2570 MHz paired with 2620-2690 MHz)**

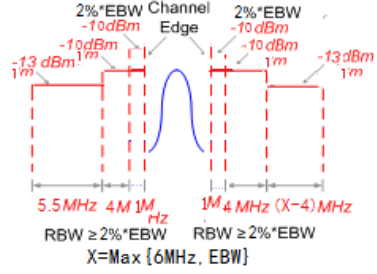
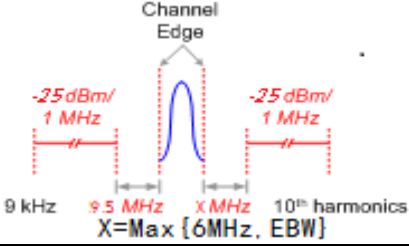
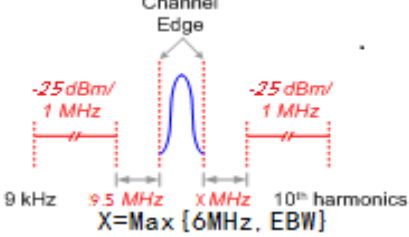
Test Item	FCC Rule No.	Requirements	Test Result	Verdict (Note1)
Effective (Isotropic) Radiated Power Output Data	§2.1046, §27.50(h)	EIRP ≤ 2W	Appendix A	Pass
Peak-Average Ratio	§27.50(a)	Limit≤13 dB	Appendix B	Pass
Modulation Characteristics	§2.1047	Digital modulation	Appendix C	Pass
Bandwidth	§2.1049	OBW: No limit. EBW: No limit.	Appendix D	Pass
Band Edges Compliance	§2.1051, §27.53(m4)	FCC: 	Appendix E	Pass
Spurious Emission at Antenna Terminals	§2.1051, §27.53(m)		Appendix F	Pass
Field Strength of Spurious Radiation	§2.1053, §27.53(m)		Appendix G	Pass
Frequency Stability	§2.1055, §27.54	Within authorized bands of operation/frequency block.	Appendix H	Pass

NOTE: For the verdict, the "N/A" denotes "not applicable", the "N/T" denotes "not tested".

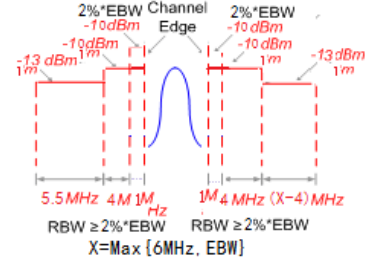
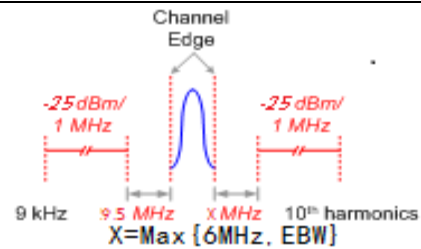
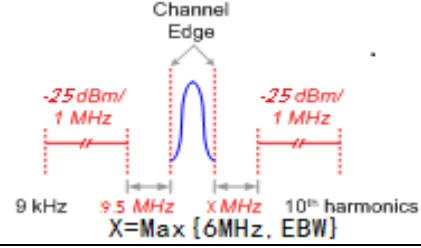

**2.4 BRS&EBS Band38 (2570-2620 MHz paired with 2570-2620 MHz)**

Test Item	FCC Rule No.	Requirements	Test Result	Verdict
Effective (Isotropic) Radiated Power Output Data	§2.1046, §27.50(h)	EIRP ≤ 2W	Appendix A	Pass
Peak-Average Ratio	§27.50(a)	FCC: Limit ≤ 13 dB	Appendix B	Pass
Modulation Characteristics	§2.1047	Digital modulation	Appendix C	Pass
Bandwidth	§2.1049	OBW: No limit. EBW: No limit.	Appendix D	Pass
Band Edges Compliance	§2.1051, §27.53(m)	FCC: 	Appendix E	Pass
Spurious Emission at Antenna Terminals	§2.1051, §27.53(m)		Appendix F	Pass
Field Strength of Spurious Radiation	§2.1053, §27.53(m)		Appendix G	Pass
Frequency Stability	§2.1055, §27.54	Within authorized bands of operation/frequency block.	Appendix H	Pass

NOTE 1: For the verdict, the "N/A" denotes "not applicable", the "N/T" denotes "not tested".

**2.5 BRS&EBS Band41 (2545-2655 MHz paired with 2545-2655 MHz)**

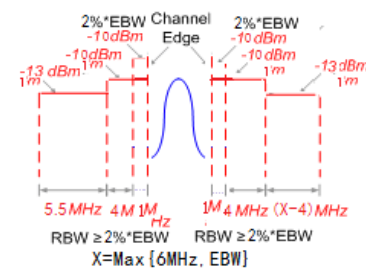
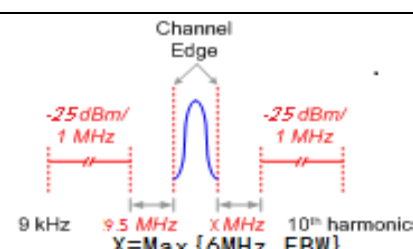
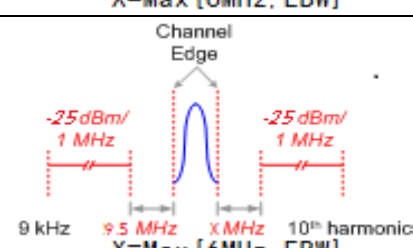
Test Item	FCC Rule No.	Requirements	Test Result	Verdict
Effective (Isotropic) Radiated Power Output Data	§2.1046, §27.50(h)	EIRP ≤ 2W	Appendix A	Pass
Peak-Average Ratio	§27.50(a)	FCC:Limit≤13 dB	Appendix B	Pass
Modulation Characteristics	§2.1047	Digital modulation	Appendix C	Pass
Bandwidth	§2.1049	OBW: No limit. EBW: No limit.	Appendix D	Pass
Band Edges Compliance	§2.1051, §27.53(m)	FCC: 	Appendix E	Pass
Spurious Emission at Antenna Terminals	§2.1051, §27.53(m)		Appendix F	Pass
Field Strength of Spurious Radiation	§2.1053, §27.53(m)		Appendix G	Pass
Frequency Stability	§2.1055, §27.54	Within authorized bands of operation/frequency block.	Appendix H	Pass

NOTE 1: For the verdict, the “N/A” denotes “not applicable”, the “N/T” denotes “not tested”.



### 3 Description of the Equipment under Test (EUT)

#### 3.1 General Description

HWV31 is subscriber equipment in the GSM/WCDMA/LTE/CDMA system. The GSM frequency band is GSM850 and GSM900 and DCS1800 and PCS1900. The UMTS frequency band is B1 and B5 and B6 and B8 and B19. The LTE frequency band is B1 and B3 and B5 and B7 and B8 and B18 and B19 and B20 and B38 and B40 and B41. The Mobile Phone implements such functions as RF signal receiving/transmitting, LTE/HSPA/UMTS and GSM/GPRS/EDGE protocol processing, voice, video MMS service, GPS, AGPS and WIFI etc. Externally it provides one micro SD card (it can also used as SIM card interface), earphone port (to provide voice service) and one SIM card interface. HWV31 is single SIM smart phone. It also provides Bluetooth module to synchronize data between a PC and the phone, or to use the built-in modem of the phone to access the Internet with a PC, or to exchange data with other Bluetooth devices. Note: Only GSM 850 and GSM1900, UMTS frequency B5,LTE frequency B5 and B7 and B38 and B41 bands test data included in this report.

#### 3.2 EUT Identity

NOTE: Unless otherwise noted in the report, the functional boards installed in the units shall be selected from the below list, but not means all the functional boards listed below shall be installed in one unit.

##### 3.2.1 Board

Board		
Description	Hardware Version	Software Version
Main Board	HL1PICL01M	HWV31C791B100

##### 3.2.2 Sub-Assembly

Sub-Assembly			
Sub-Assembly Name	Model	Manufacturer	Description
Adapter	HW-059200JHQ	Huawei Technologies Co., Ltd.	Input Voltage: ~100-240V 50/60Hz 0.5A Output Voltage: 5V  2A OR 9V  2A
Adapter	HW-059200UHQ	Huawei Technologies Co., Ltd.	Input Voltage: ~100-240V 50/60Hz 0.5A Output Voltage: 5V  2A OR 9V  2A
Rechargeable Li-ion	HB366179ECW	Huawei Technologies Co., Ltd.	Rated capacity: 2850mAh Nominal Voltage:  +3.82V Charging Voltage:  +4.40V

### 3.3 Technical Specification

Characteristics	Description	
Radio System Type	<input checked="" type="checkbox"/> GSM <input checked="" type="checkbox"/> UMTS <input checked="" type="checkbox"/> LTE	
Supported Frequency Range	GSM850/ WCDMA850	Transmission (TX): 824 to 849 MHz
		Receiving (RX): 869 to 894 MHz
	GSM1900	Transmission (TX): 1850 to 1910 MHz
		Receiving (RX): 1930 to 1990 MHz
	LTE BAND5	Transmission (TX): 824 to 849 MHz
		Receiving (RX): 869 to 894 MHz
	LTE BAND7	Transmission (TX): 2500 to 2570 MHz
		Receiving (RX): 2620 to 2690 MHz
	LTE BAND38	Transmission (TX): 2570 to 2620MHz
		Receiving (RX): 2570 to 2620 MHz
	LTE Band 41	Transmission (TX): 2545 to 2655 MHz
		Receiving (RX): 2545 to 2655 MHz
TX and RX Antenna Ports	TX & RX port:	1
	TX-only port:	0
	RX-only port:	1
Target TX Output Power	GSM850: 32.0 dBm GSM1900: 29.5 dBm UMTS850: 23.0 dBm LTE BAND5: 22.5 dBm LTE BAND7: 21.8 dBm LTE BAND38: 22.0 dBm LTE BAND41: 22.0 dBm	
Supported Channel Bandwidth	GSM system:	<input checked="" type="checkbox"/> 200 kHz
	UMTS system:	<input checked="" type="checkbox"/> 5 MHz
	LTE band 5	<input checked="" type="checkbox"/> 1.4MHz, <input checked="" type="checkbox"/> 3MHz <input checked="" type="checkbox"/> 5MHz, <input checked="" type="checkbox"/> 10MHz ,
	LTE band 7	<input checked="" type="checkbox"/> 5MHz, <input checked="" type="checkbox"/> 10MHz , <input checked="" type="checkbox"/> 15MHz , <input checked="" type="checkbox"/> 20MHz
	LTE band 38	<input checked="" type="checkbox"/> 5MHz, <input checked="" type="checkbox"/> 10MHz , <input checked="" type="checkbox"/> 15MHz , <input checked="" type="checkbox"/> 20MHz
	LTE band 41	<input checked="" type="checkbox"/> 5MHz, <input checked="" type="checkbox"/> 10MHz , <input checked="" type="checkbox"/> 15MHz , <input checked="" type="checkbox"/> 20MHz
Designation of Emissions (Note: the necessary bandwidth of which is the worst value from the measured occupied bandwidths for each type of channel bandwidth configuration.)	GSM850:	248KGXW, 251KG7W
	GSM1900:	250KGXW, 247KG7W
	UMTS850:	4M15F9W
	LTE BAND5:	1M10G7D (1.4 MHz QPSK modulation), 1M10W7D (1.4 MHz 16QAM modulation) 2M71G7D (3 MHz QPSK modulation), 2M72W7D (3 MHz 16QAM modulation) 4M52G7D (5 MHz QPSK modulation), 4M52W7D (5 MHz 16QAM modulation)

Characteristics	Description	
		9M00G7D (10 MHz QPSK modulation), 9M00W7D (10 MHz 16QAM modulation)
	LTE BAND7:	4M51G7D (5 MHz QPSK modulation), 4M52W7D (5 MHz 16QAM modulation) 9M00G7D (10 MHz QPSK modulation), 9M01W7D (10 MHz 16QAM modulation) 13M5G7D (15 MHz QPSK modulation), 13M5W7D (15 MHz 16QAM modulation) 18M0G7D (20 MHz QPSK modulation), 18M0W7D (20 MHz 16QAM modulation)
	LTE BAND38:	4M51G7D (5 MHz QPSK modulation), 4M51W7D (5 MHz 16QAM modulation) 9M03G7D (10 MHz QPSK modulation), 9M03W7D (10 MHz 16QAM modulation) 13M5G7D (15 MHz QPSK modulation), 13M5W7D (15 MHz 16QAM modulation) 18M0G7D (20 MHz QPSK modulation), 18M0W7D (20 MHz 16QAM modulation)
	LTE BAND41:	4M50G7D (5 MHz QPSK modulation), 4M48W7D (5 MHz 16QAM modulation) 8M99G7D (10 MHz QPSK modulation), 8M99W7D (10 MHz 16QAM modulation) 13M5G7D (15 MHz QPSK modulation), 13M5W7D (15 MHz 16QAM modulation) 17M9G7D (20 MHz QPSK modulation), 18M0W7D (20 MHz 16QAM modulation)



## 4 General Test Conditions / Configurations

### 4.1 Test Modes

NOTE: The test mode(s) are selected according to relevant radio technology specifications.

Test Mode	Test Modes Description
GSM/TM1	GSM system, GSM/GPRS, GMSK modulation
GSM/TM2	GSM system, EDGE, 8PSK modulation
UMTS/TM1	WCDMA system, QPSK modulation
LTE/TM1	LTE system, QPSK modulation
LTE/TM2	LTE system, 16QAM modulation

### 4.2 Test Environment

Environment Parameter	Selected Values During Tests	
Relative Humidity	Ambient	
Temperature	TN	Ambient
Voltage	VL	3.6V
	VN	3.8V
	VH	4.4V

NOTE: VL= lower extreme test voltage  
VN= nominal voltage  
VH= upper extreme test voltage  
TN= normal temperature

### 4.3 Test Frequency

Test Mode	TX / RX	RF Channel		
		Low (L)	Middle (M)	High (H)
GSM850	TX	Channel 128	Channel 190	Channel 251
		824.2MHz	836.6MHz	848.8MHz
	RX	Channel 128	Channel 190	Channel 251
		869.2MHz	881.6MHz	893.8MHz
WCDMA850	TX	Channel 4132	Channel 4182	Channel 4233
		826.4MHz	836.4MHz	846.6MHz
	RX	Channel 4357	Channel 4407	Channel 4458
		871.4MHz	881.4MHz	891.6MHz
Test Mode	TX / RX	RF Channel		
		Low (L)	Middle (M)	High (H)
GSM1900	TX	Channel 512	Channel 661	Channel 810
		1850.2MHz	1880.0MHz	1909.8MHz
	RX	Channel 512	Channel 661	Channel 810
		1930.2 MHz	1960.0 MHz	1989.8 MHz

Test Mode	TX / RX	RF Channel		
		Low (B)	Middle (M)	High (T)
LTE Band 5	TX(1.4M)	Channel 20407	Channel 20525	Channel 20643
		824.7 MHz	836.5 MHz	848.3 MHz
	TX(3M)	Channel 20415	Channel 20525	Channel 20635
		825.5 MHz	836.5 MHz	847.5 MHz
	TX(5M)	Channel 20425	Channel 20525	Channel 20625



Test Mode	TX / RX	RF Channel		
		Low (B)	Middle (M)	High (T)
	TX(10M)	826.5 MHz	836.5 MHz	846.5 MHz
		Channel 20450	Channel 20525	Channel 20600
	RX(1.4M)	829 MHz	836.5 MHz	844 MHz
		Channel 2407	Channel 2525	Channel 2643
	RX (3M)	869.7 MHz	881.5 MHz	893.3 MHz
		Channel 2415	Channel 2525	Channel 2635
	RX(5M)	870.5 MHz	881.5 MHz	892.5 MHz
		Channel 2425	Channel 2525	Channel 2625
	RX (10M)	871.5 MHz	881.5 MHz	891.5 MHz
		Channel 2450	Channel 2525	Channel 2600
		874 MHz	881.5 MHz	889 MHz

Test Mode	TX / RX	RF Channel		
		Low (B)	Middle (M)	High (T)
LTE Band 7	TX (5M)	Channel 20775	Channel 21100	Channel 21425
		2502.5 MHz	2535 MHz	2567.5 MHz
	TX (10M)	Channel 20800	Channel 21100	Channel 21400
		2505 MHz	2535 MHz	2565 MHz
	TX (15M)	Channel 20825	Channel 21100	Channel 21375
		2507.5 MHz	2535 MHz	2562.5 MHz
	TX (20M)	Channel 20850	Channel 21100	Channel 21350
		2510 MHz	2535 MHz	2560 MHz
	RX (5M)	Channel 2775	Channel 3100	Channel 3425





Test Mode	TX / RX	RF Channel		
		Low (B)	Middle (M)	High (T)
		2622.5 MHz	2655 MHz	2687.5 MHz
		Channel 2800	Channel 3100	Channel 3400
	RX (10M)	2625 MHz	2655 MHz	2685 MHz
		Channel 2825	Channel 3100	Channel 3375
	RX (15M)	2627.5 MHz	2655 MHz	2682.5 MHz
		Channel 2850	Channel 3100	Channel 3350
	RX (20M)	2630 MHz	2655 MHz	2680 MHz

Test Mode	TX / RX	RF Channel		
		Low (B)	Middle (M)	High (T)
LTE Band 38	TX(5M)	Channel 37775	Channel 38000	Channel 38225
		2572.5 MHz	2595 MHz	2617.5 MHz
	TX(10M)	Channel 37800	Channel 38000	Channel 38200
		2575 MHz	2595 MHz	2615 MHz
	TX(15M)	Channel 37825	Channel 38000	Channel 38175
		2577.5 MHz	2595 MHz	2612.5 MHz
	TX(20M)	Channel 37850	Channel 38000	Channel 38150
		2580 MHz	2595 MHz	2610 MHz
	RX(5M)	Channel 37775	Channel 38000	Channel 38225
		2572.5 MHz	2595 MHz	2617.5 MHz
	RX(10M)	Channel 37800	Channel 38000	Channel 38200
		2575 MHz	2595 MHz	2615 MHz
	RX(15M)	Channel 37825	Channel 38000	Channel 38175
		2577.5 MHz	2595 MHz	2612.5 MHz

Test Mode	TX / RX	RF Channel		
		Low (B)	Middle (M)	High (T)
	RX(20M)	Channel 37850	Channel 38000	Channel 38150
		2580 MHz	2595 MHz	2610 MHz

Test Mode	TX / RX	RF Channel		
		Low (B)	Middle (M)	High (T)
LTE Band 41	TX(5M)	Channel 40165	Channel 40690	Channel 41215
		2547.5 MHz	2600 MHz	2652.5 MHz
	TX(10M)	Channel 40190	Channel 40690	Channel 41190
		2550 MHz	2600 MHz	2650 MHz
	TX(15M)	Channel 40215	Channel 40690	Channel 41165
		2552.5 MHz	2600 MHz	2647.5 MHz
	TX(20M)	Channel 40240	Channel 40690	Channel 41140
		2555 MHz	2600 MHz	2645 MHz
	RX(5M)	Channel 40165	Channel 40690	Channel 41215
		2547.5 MHz	2600 MHz	2652.5 MHz
	RX(10M)	Channel 40190	Channel 40690	Channel 41190
		2550 MHz	2600 MHz	2650 MHz
	RX(15M)	Channel 40215	Channel 40690	Channel 41165
		2552.5 MHz	2600 MHz	2647.5 MHz
	RX(20M)	Channel 40240	Channel 40690	Channel 41140
		2555 MHz	2600 MHz	2645 MHz

## 4.4 DESCRIPTION OF TESTS

### 4.4.1 Radiated Power and Radiated Spurious Emissions

Radiated spurious emissions are investigated indoors in a semi-anechoic chamber to determine the frequencies producing the worst case emissions. Final measurements for radiated power and radiated spurious emissions are performed on the 3 meter OATS per the guidelines of ANSI/TIA-603-D-2010. The equipment under test was transmitting while connected to its integral antenna and is placed on a wooden turntable 80cm above the ground plane and 3 meters from the receive antenna. The spectrum is scanned from the lowest frequency generated in the equipment up to a frequency including its 10th harmonic. The receive antenna height is adjusted between 1 and 4 meter height, the turntable is rotated through 360 degrees, and the EUT is manipulated through all orthogonal planes representative of its typical use to achieve the highest reading on the receive spectrum analyzer. Emissions are also investigated with the receive antenna horizontally and vertically polarized.

A portable or small unlicensed wireless device shall be placed on a non-metallic test fixture or other non-metallic support during testing. The supporting fixture shall permit orientation of the EUT in each of three orthogonal (x, y, z) axis positions such that emissions from the EUT are maximized. Measure the EUT maximum RF power and record the result.

A half-wave dipole is then substituted in place of the EUT. For emissions above 3GHz, a horn antenna is substituted in place of the EUT. The substitute antenna is driven by a signal generator with the level of the signal generator being adjusted to obtain the same receive spectrum analyzer level previously recorded from the spurious emission from the EUT.

The power of the emission is calculated using the following formula:

$$P_d [\text{dBm}] = P_g [\text{dBm}] - \text{cable loss} [\text{dB}] + \text{antenna gain} [\text{dBd/dBi}]$$

Where,  $P_d$  is the dipole equivalent power,  $P_g$  is the generator output into the substitution antenna, and the antenna gain is the gain of the substitute antenna used relative to either a half-wave dipole (dBd) or an isotropic source (dBi). The substitute level is equal to  $P_g [\text{dBm}] - \text{cable loss} [\text{dB}]$ .

The calculated  $P_d$  levels are then compared to the absolute spurious emission limit of -13dBm which is equivalent to the required minimum attenuation of  $43 + 10\log_{10}(\text{Power} [\text{Watts}])$ .

### Test Procedures Used

KDB 971168 D01 v03-Section 5.2.2 / KDB 971168 D01 v03-Section 5.8

ANSI/TIA-603-D-2010-Section 2.2.17 / ANSI/TIA-603-D-2010-Section 2.2.12

Note: Reference test setup 3

#### 4.4.2 Peak-Average Ratio

A peak to average ratio measurement is performed at the conducted port of the EUT. For WCDMA signals, the spectrum analyzers Complementary Cumulative Distribution Function (CCDF) measurement profile is used to determine the largest deviation between the average and the peak power of the EUT in a given bandwidth. The CCDF curve shows how much time the peak waveform spends at or above a given average power level. The percent of time the signal spends at or above the level defines the probability for that particular power level. For GSM signals, an average and a peak trace are used on a spectrum analyzer to determine the largest deviation between the average and the peak power of the EUT in a bandwidth greater than the emission bandwidth. The traces are generated with the spectrum analyzer set to zero span mode.

#### Test Procedures Used

KDB 971168 D01 v03-Section 5.7.2

#### Test Settings

- 1、 The signal analyzer's CCDF measurement profile enabled
- 2、 Frequency= carrier center frequency
- 3、 Measurement BW > EBW of signal
- 4、 for continuous transmissions, set to 1ms
- 5、 Record the maximum PAPR level associated with a probability of 0.1%.

Note: Reference test setup 1

### 4.4.3 Occupied Bandwidth

The occupied bandwidth, that is the frequency bandwidth such that, below its lower and above its upper frequency limits, the mean powers radiated are each equal to 0.5 percent of the total mean power radiated by a given emission shall be measured. The span of the analyzer shall be set to capture all products of the modulation process, including the emission skirts. The resolution bandwidth shall be set to as close to 1 percent of the selected span as is possible without being below 1 percent. The video bandwidth shall be set to 3 times the resolution bandwidth. Video averaging is not permitted. Where practical, a sampling detector shall be used since a peak or, peak hold, may produce a wider bandwidth than actual. The trace data points are recovered and are directly summed in linear terms. The recovered amplitude data points, beginning at the lowest frequency, are placed in a running sum until 0.5 percent of the total is reached and that frequency recorded. The process is repeated for the highest frequency data points. This frequency is recorded. The span between the two recorded frequencies is the occupied bandwidth.

#### Test Procedures Used

KDB 971168 D01 v03-Section 4.3

#### Test Settings

- 1、 SET RBW=1-5% of OBW
- 2、 SET VBW  $\geq 3 \cdot$  RBW
- 3、 Detector: Peak
- 4、 Trace mode= max hold.
- 5、 Sweep= auto couple
- 6、 Steps 1-5 were repeated after it is stable

Note: Reference test setup 1.



#### 4.4.4 Band Edge Compliance

the 1 MHz bands immediately outside and adjacent to the frequency block a resolution bandwidth of at least one percent of the emission bandwidth of the fundamental emission of the transmitter may be employed. The emission power must be attenuated below the transmitting power (P) by a factor of at least  $43+10\log_{10}P$  dB.

#### Test Procedures Used

KDB 971168 D01 v03-Section 6

#### Test Settings

- 1、 SET RBW  $\geq$  1% of Emission BW.
- 2、 SET VBW about three times of RBW
- 3、 Detector: RMS
- 4、 Trace mode= max hold.
- 5、 Span= 2MHz

Note: Reference test setup 1.

#### 4.4.5 Spurious and Harmonic Emissions at Antenna Terminal

The level of the carrier and the various conducted spurious and harmonic frequencies is measured by means of a calibrated spectrum analyzer. The spectrum is scanned from the lowest frequency generated in the equipment up to a frequency including its 10<sup>th</sup> harmonic. On any frequency outside a licensee's frequency block, the power of any emission shall be attenuated below the transmitter power (P) by at least  $43 + 10 \log(P)$  dB. Compliance with these provisions is based on the use of measurement instrumentation employing a resolution bandwidth of 1 MHz or greater. However, in the 1 MHz bands immediately outside and adjacent to the frequency block a resolution bandwidth of at least one percent of the emission bandwidth of the fundamental emission of the transmitter may be employed. The emission bandwidth is defined as the width of the signal between two points, one below the carrier center frequency and one above the carrier center frequency, outside of which all emission are attenuated at least 26 dB below the transmitter power.

#### Test Procedures Used

KDB 971168 D01 v03-Section 6

#### Test Settings

- 1、 9kHz~150kHz, RBW = 1KHz, VBW  $\geq 3 \times$  RBW,  
150kHz~30MHz, RBW = 10KHz, VBW  $\geq 3 \times$  RBW,  
30MHz~1GHz, RBW = 100 kHz, VBW = 300 kHz.  
Above 1GHz, RBW = 1 MHz, VBW = 3 MHz.
- 2、 Detector: Peak
- 3、 Trace mode= max hold.

Note: Reference test setup 1.

#### 4.4.6 Frequency Stability / Temperature Variation

Frequency stability testing is performed in accordance with the guidelines of ANSI/TIA-603-D-2010. The frequency stability of the transmitter is measured by:

- a.) **Temperature:** The temperature is varied from -30°C to +50°C in 10°C increments using an environmental chamber.
- b.) **Primary Supply Voltage:** The primary supply voltage is varied from 85% to 115% of the nominal value for non hand-carried battery and AC powered equipment. For hand-carried, battery-powered equipment, primary supply voltage is reduced to the battery operating end point which shall be specified by the manufacturer.

Specification – The frequency stability shall be sufficient to ensure that the fundamental emission stays within the authorized frequency block. The frequency stability of the transmitter shall be maintained within  $\pm 0.00025\%$  ( $\pm 2.5$  ppm ) of the center frequency.

**Time Period and Procedure:**

1. The carrier frequency of the transmitter is measured at room temperature (20°C to provide a reference).
2. The equipment is turned on in a “standby” condition for fifteen minutes before applying power to the transmitter. Measurement of the carrier frequency of the transmitter is made within one minute after applying power to the transmitter.
3. Frequency measurements are made at 10°C intervals ranging from -30°C to +50°C. A period of at least one half-hour is provided to allow stabilization of the equipment at each temperature level.

**Test Procedures Used**

ANSI/TIA-603-D-2010

Note: Reference test setup 2.



## 4.5 Test Setups

### 4.5.1 Test Setup 1

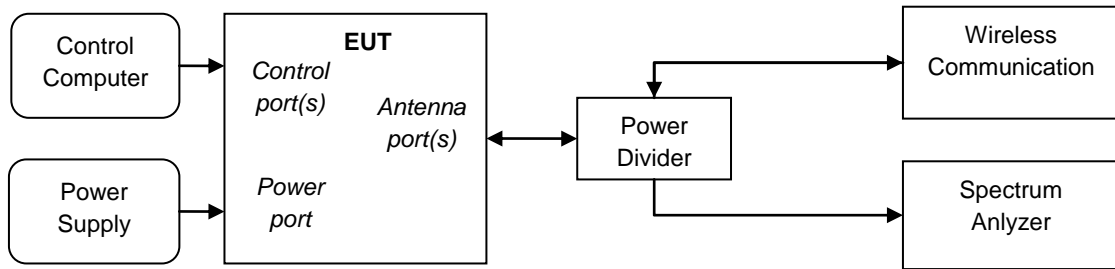

### 4.5.2 Test Setup 2

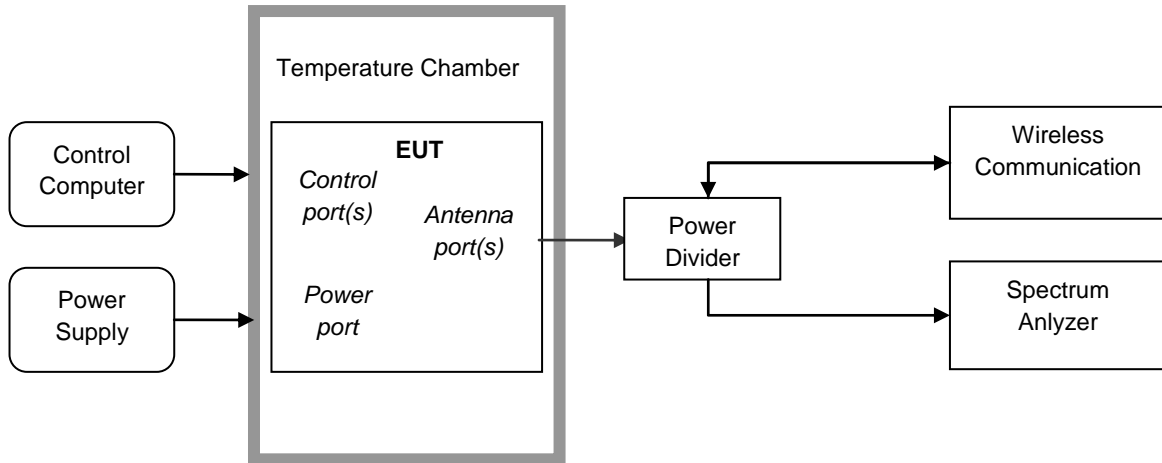

### 4.5.3 Test Setup 3

NOTE: Effective radiated power (ERP) and Equivalent Isotropic Radiated Power(EIRP) refers to the radiation power output of the EUT, assuming all emissions are radiated from half-wave dipole antennas.

#### 4.5.3.1 Step 1: Pre-test

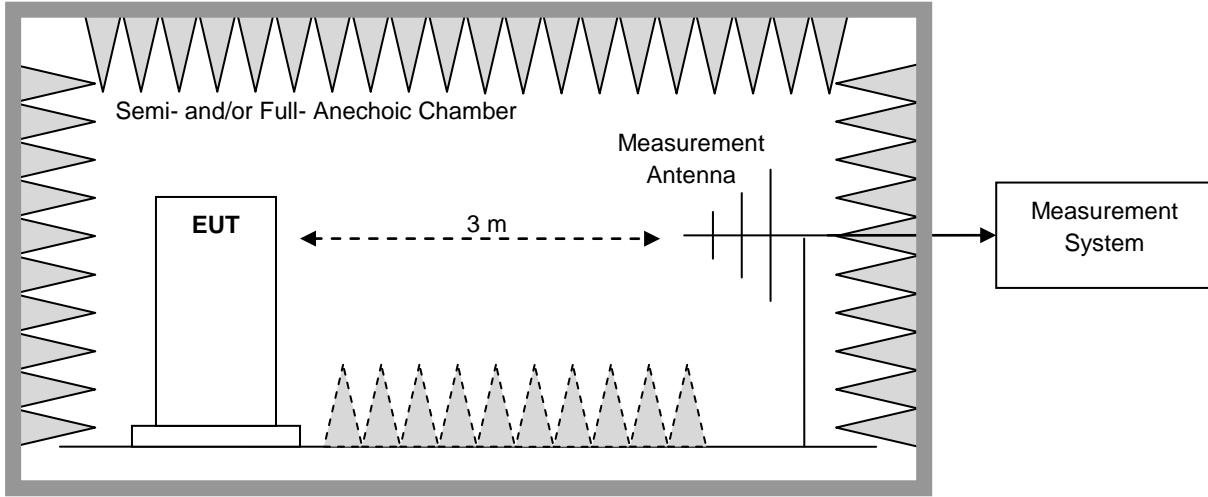

#### 4.5.3.2 Step 2: Substitution method to verify the maximum ERP/EIRP

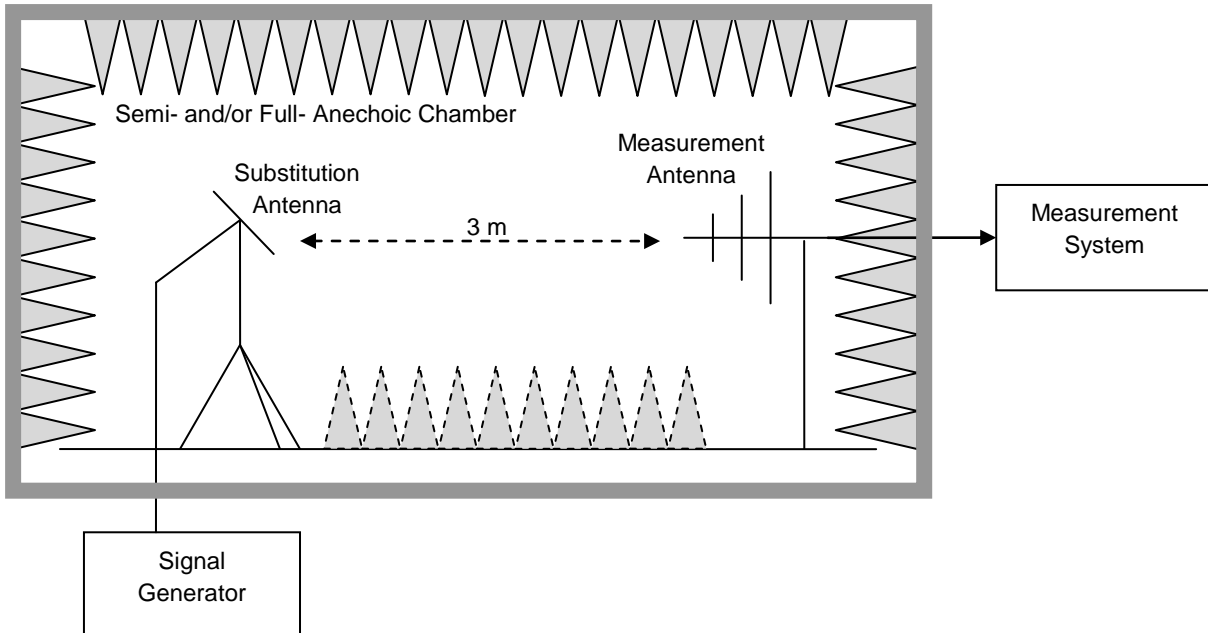

**4.6 Test Conditions**

Test Case		Test Conditions	
Transmit Output Power Data	Average Power, Total	Test Env.	Ambient Climate & Rated Voltage
		Test Setup	Test Setup 1
		RF Channels (TX)	L, M, H (L= low channel, M= middle channel, H= high channel )
		Test Mode	GSM/TM1,GSM/TM2,UMTS/TM1,LTE/TM1,LTE/TM2
	Average Power, Spectral Density (if required)	Test Env.	Ambient Climate & Rated Voltage
		Test Setup	Test Setup 1
		RF Channels (TX)	L, M, H (L= low channel, M= middle channel, H= high channel )
		Test Mode	GSM/TM1,GSM/TM2,UMTS/TM1,LTE/TM1,LTE/TM2
Peak-to-Average Ratio (if required)		Test Env.	Ambient Climate & Rated Voltage
		Test Setup	Test Setup 1
		RF Channels (TX)	L, M, H (L= low channel, M= middle channel, H= high channel )
		Test Mode	GSM/TM1,GSM/TM2,UMTS/TM1,LTE/TM1,LTE/TM2
Modulation Characteristics		Test Env.	Ambient Climate & Rated Voltage
		Test Setup	Test Setup 1
		RF Channels (TX)	M (L= low channel, M= middle channel, H= high channel )
		Test Mode	GSM/TM1,GSM/TM2,UMTS/TM1,LTE/TM1,LTE/TM2
Bandwidth	Occupied Bandwidth	Test Env.	Ambient Climate & Rated Voltage
		Test Setup	Test Setup 1
		RF Channels (TX)	L, M, H (L= low channel, M= middle channel, H= high channel )
		Test Mode	GSM/TM1,GSM/TM2,UMTS/TM1,LTE/TM1,LTE/TM2
	Emission Bandwidth (if required)	Test Env.	Ambient Climate & Rated Voltage
		Test Setup	Test Setup 1
		RF Channels (TX)	L, M, H (L= low channel, M= middle channel, H= high channel )
		Test Mode	GSM/TM1,GSM/TM2,UMTS/TM1,LTE/TM1,LTE/TM2
Band Edges Compliance		Test Env.	Ambient Climate & Rated Voltage
		Test Setup	Test Setup 1
		RF Channels (TX)	L, H (L= low channel, M= middle channel, H= high channel )
		Test Mode	GSM/TM1,GSM/TM2,UMTS/TM1,LTE/TM1,LTE/TM2
Spurious Emission at Antenna Terminals		Test Env.	Ambient Climate & Rated Voltage
		Test Setup	Test Setup 1
		RF Channels (TX)	L, M, H (L= low channel, M= middle channel, H= high channel )



Test Case	Test Conditions	
	Test Mode	GSM/TM1,GSM/TM2,UMTS/TM1,LTE/TM1,LTE/TM2
Field Strength of Spurious Radiation	Test Env.	Ambient Climate & Rated Voltage
	Test Setup	Test Setup 3
	Test Mode	GSM/TM1,GSM/TM2,UMTS/TM1/TM2/TM3,LTE/TM1,LTE/TM2 NOTE: If applicable, the EUT conf. that has maximum power density (based on the equivalent power level) is selected.
	RF Channels (TX)	L, M, H (L= low channel, M= middle channel, H= high channel )
Frequency Stability	Test Env.	(1) -30 °C to +50 °C with step 10 °C at Rated Voltage; (2) VL, VN and VH of Rated Voltage at Ambient Climate.
	Test Setup	Test Setup 2
	RF Channels (TX)	L, M, H (L= low channel, M= middle channel, H= high channel )
	Test Mode	GSM/TM1,GSM/TM2,UMTS/TM1,LTE/TM1,LTE/TM2

**5 Main Test Instruments**

<b>Main Test Equipments</b>					
Equipment Name	Manufacturer	Model	Serial Number	Cal Date	Cal- Due
Power supply	KEITHLEY	2303	000500E	2017/5/31	2018/5/30
Wireless Communication Test set	Agilent	N4010A	MY49081592	2017/7/31	2018/7/30
Universal Radio Communication Tester	R&S	CMU200	110932	2017/5/2	2018/5/1
Spectrum Analyzer	Agilent	N9020A	MY52090652	2017/7/10	2018/7/9
Universal Radio Communication Tester	R & S	CMW500	126854	2017/10/19	2018/10/18
Signal Analyzer	R&S	FSQ31	200021	2017/7/31	2018/7/30
Spectrum Analyzer	Agilent	N9030A	MY49431698	2017/7/31	2018/7/30
Temperature Chamber	ESPEC	MW3030	06114003	2017/02/22	2018/02/21
Signal generator	Agilent	E8257D	MY49281095	2017/7/31	2018/7/30
Vector Signal Generator	R&S	SMU200A	104162	2017/7/31	2018/7/30
Test receiver	R&S	ESU26	100387	2017/2/21	2018/2/20
Test receiver	R&S	ESCI	101163	2017/2/21	2018/2/20
Spectrum analyzer	R&S	FSU3	200474	2017/2/21	2018/2/20
Spectrum analyzer	R&S	FSU43	100144	2017/2/21	2018/2/20
LOOP Antennas(9kHz-30MHz)	R&S	HFH2-Z2	100262	2017/4/25	2019/4/25
LOOP Antennas(9kHz-30MHz)	R&S	HFH2-Z2	100263	2017/4/25	2019/4/25
Trilog Broadband Antenna (30M~3GHz)	SCHWARZBE CK	VULB 9163	9163-490	2017/3/29	2019/3/29
Trilog Broadband Antenna (30M~3GHz)	SCHWARZBE CK	VULB 9163	9163-521	2017/4/9	2019/4/9
Double-Ridged Waveguide Horn Antenna (1G~18GHz)	R&S	HF907	100304	2017/5/27	2019/5/27
Pyramidal Horn Antenna(18GHz-26.5GHz)	ETS-Lindgren	3160-09	206665	2017/3/24	2018/3/23
Artificial Main Network	R&S	ENV4200	100134	2017/5/15	2018/5/14
Line Impedance Stabilization Network	R&S	ENV216	100382	2017/5/15	2018/5/14
Power Detecting & Sampling Unit	R&S	OSP-B157	100914	2017/7/31	2018/7/30
<b>Software Information</b>					
Test Item	Software Name		Manufacturer	Version	
RSE	EMC32		R&S	V8.40.0	



## 6 Measurement Uncertainty

For a 95% confidence level ( $k = 2$ ), the measurement expanded uncertainties for defined systems, in accordance with the recommendations of ISO 17025 as following:

Test Item		Extended Uncertainty
Transmit Output Power Data	Power [dBm]	U = 0.42 dB
Bandwidth	Magnitude [%]	U = 0.2%
Band Edge Compliance	Disturbance Power [dBm]	U = 1.24 dB
Spurious Emissions, Conducted	Disturbance Power [dBm]	U = 1.62 dB
Field Strength of Spurious Radiation	ERP [dBm]	For 3 m Chamber: U = 4.9 dB (30 MHz to 26.5GHz)
Frequency Stability	Frequency Accuracy [ppm]	U = 0.017 ppm

## 7 Appendixes

Appendix No.	Description
SYBH(Z-RF)005112017-2001-A	Appendix_for_GSM
SYBH(Z-RF)005112017-2001-B	Appendix_for_WCDMA
SYBH(Z-RF)005112017-2001-C	Appendix_for_LTE Band5
SYBH(Z-RF)005112017-2001-D	Appendix_for_LTE Band7
SYBH(Z-RF)005112017-2001-E	Appendix_for_LTE Band38
SYBH(Z-RF)005112017-2001-F	Appendix_for_LTE Band41

Appendix	Description
Appendix A	Effective (Isotropic) Radiated Power Output Data
Appendix B	Peak-Average Ratio
Appendix C	Modulation Characteristics
Appendix D	Bandwidth
Appendix E	Band Edges Compliance
Appendix F	Spurious Emission at Antenna Terminals
Appendix G	Field Strength of Spurious Radiation
Appendix H	Frequency Stability

Note: For the RSE data we tested ant1&ant2, the data presented is all antenna mode; the other items we tested all antenna modes, but the data presented is the worst antenna mode

END