

# FCC Radio Test Report

## FCC ID: QISNYX-B10

This report concerns (check one): Original Grant Class I Change Class II Change

**Project No.** : 1703C225  
**Equipment** : Smart Band  
**Model Name** : NYX-B10  
**Applicant** : Huawei Technologies Co.,Ltd.  
**Address** : Administration Building, Headquarters of Huawei Technologies Co., Ltd., Bantian, Longgang District, Shenzhen, 518129, P.R.C

**Date of Receipt** : Mar. 27, 2017  
**Date of Test** : Mar. 27, 2017 ~ Apr. 12, 2017  
**Issued Date** : Apr. 13, 2017  
**Tested by** : BTL Inc.

**Testing Engineer** : Shawn Xiao  
(Shawn Xiao)

**Technical Manager** : David Mao  
(David Mao)

**Authorized Signatory** : Steven Lu  
(Steven Lu)

# **B T L I N C .**

No.3, Jinshagang 1st Road, Shixia, Dalang Town, Dongguan, Guangdong, China.

TEL: +86-769-8318-3000 FAX: +86-769-8319-6000

### **Declaration**

**BTL** represents to the client that testing is done in accordance with standard procedures as applicable and that test instruments used has been calibrated with standards traceable to international standard(s) and/or national standard(s).

**BTL's** reports apply only to the specific samples tested under conditions. It is manufacture's responsibility to ensure that additional production units of this model are manufactured with the identical electrical and mechanical components. **BTL** shall have no liability for any declarations, inferences or generalizations drawn by the client or others from **BTL** issued reports.

**BTL's** report must not be used by the client to claim product certification, approval, or endorsement by NVLAP, NIST, or any agency of the Federal Government.

This report is the confidential property of the client. As a mutual protection to the clients, the public and **BTL-self**, extracts from the test report shall not be reproduced except in full with **BTL's** authorized written approval.

**BTL's** laboratory quality assurance procedures are in compliance with the **ISO Guide 17025** requirements, and accredited by the conformity assessment authorities listed in this test report.

### **Limitation**

For the use of the authority's logo is limited unless the Test Standard(s)/Scope(s)/Item(s) mentioned in this test report is (are) included in the conformity assessment authorities acceptance respective.

<b>Table of Contents</b>	<b>Page</b>
<b>1 . CERTIFICATION</b>	<b>6</b>
<b>2 . SUMMARY OF TEST RESULTS</b>	<b>7</b>
2.1 TEST FACILITY	8
2.2 MEASUREMENT UNCERTAINTY	8
<b>3 . GENERAL INFORMATION</b>	<b>9</b>
3.1 GENERAL DESCRIPTION OF EUT	9
3.2 DESCRIPTION OF TEST MODES	11
3.3 TABLE OF PARAMETERS OF TEXT SOFTWARE SETTING	11
3.4 BLOCK DIAGRAM SHOWING THE CONFIGURATION OF SYSTEM TESTED	12
3.5 DESCRIPTION OF SUPPORT UNITS	12
<b>4 . EMC EMISSION TEST</b>	<b>13</b>
4.1 CONDUCTED EMISSION MEASUREMENT	13
4.1.1 POWER LINE CONDUCTED EMISSION LIMITS	13
4.1.2 TEST PROCEDURE	13
4.1.3 DEVIATION FROM TEST STANDARD	13
4.1.4 TEST SETUP	14
4.1.5 EUT OPERATING CONDITIONS	14
4.1.6 EUT TEST CONDITIONS	14
4.1.7 TEST RESULTS	14
4.2 RADIATED EMISSION MEASUREMENT	15
4.2.1 RADIATED EMISSION LIMITS	15
4.2.2 TEST PROCEDURE	16
4.2.3 DEVIATION FROM TEST STANDARD	16
4.2.4 TEST SETUP	17
4.2.5 EUT OPERATING CONDITIONS	19
4.2.6 EUT TEST CONDITIONS	19
4.2.7 TEST RESULTS (9KHZ TO 30MHZ)	19
4.2.8 TEST RESULTS (30MHZ TO 1000 MHZ)	19
4.2.9 TEST RESULTS (ABOVE 1000 MHZ)	19
<b>5 . BANDWIDTH TEST</b>	<b>20</b>
5.1 APPLIED PROCEDURES / LIMIT	20
5.1.1 TEST PROCEDURE	20
5.1.2 DEVIATION FROM STANDARD	20
5.1.3 TEST SETUP	20
5.1.4 EUT OPERATION CONDITIONS	20
5.1.5 EUT TEST CONDITIONS	20
5.1.6 TEST RESULTS	20

<b>Table of Contents</b>	<b>Page</b>
<b>6 . MAXIMUM OUTPUT POWER TEST</b>	<b>21</b>
<b>6.1 APPLIED PROCEDURES / LIMIT</b>	<b>21</b>
6.1.1 TEST PROCEDURE	21
6.1.2 DEVIATION FROM STANDARD	21
6.1.3 TEST SETUP	21
6.1.4 EUT OPERATION CONDITIONS	21
6.1.5 EUT TEST CONDITIONS	21
6.1.6 TEST RESULTS	21
<b>7 . ANTENNA CONDUCTED SPURIOUS EMISSION</b>	<b>22</b>
<b>7.1 APPLIED PROCEDURES / LIMIT</b>	<b>22</b>
7.1.1 TEST PROCEDURE	22
7.1.2 DEVIATION FROM STANDARD	22
7.1.3 TEST SETUP	22
7.1.4 EUT OPERATION CONDITIONS	22
7.1.5 EUT OPERATION CONDITIONS	22
7.1.6 TEST RESULTS	22
<b>8 . POWER SPECTRAL DENSITY TEST</b>	<b>23</b>
<b>8.1 APPLIED PROCEDURES / LIMIT</b>	<b>23</b>
8.1.1 TEST PROCEDURE	23
8.1.2 DEVIATION FROM STANDARD	23
8.1.3 TEST SETUP	23
8.1.4 EUT OPERATION CONDITIONS	23
8.1.5 EUT TEST CONDITIONS	23
8.1.6 TEST RESULTS	23
<b>9 . MEASUREMENT INSTRUMENTS LIST</b>	<b>24</b>
<b>ATTACHMENT A - CONDUCTED EMISSION</b>	<b>26</b>
<b>ATTACHMENT B - RADIATED EMISSION (9KHZ TO 30MHZ)</b>	<b>29</b>
<b>ATTACHMENT C - RADIATED EMISSION (30MHZ TO 1000MHZ)</b>	<b>34</b>
<b>ATTACHMENT D - RADIATED EMISSION (ABOVE 1000MHZ)</b>	<b>39</b>
<b>ATTACHMENT E - BANDWIDTH</b>	<b>56</b>
<b>ATTACHMENT F - MAXIMUM OUTPUT POWER TEST</b>	<b>59</b>
<b>ATTACHMENT G - ANTENNA CONDUCTED SPURIOUS EMISSION</b>	<b>60</b>
<b>ATTACHMENT H - POWER SPECTRAL DENSITY TEST</b>	<b>67</b>

### REPORT ISSUED HISTORY

Issued No.	Description	Issued Date
BTL-FCCP-1-1703C225	Original Issue.	Apr. 13, 2017

## 1. CERTIFICATION

Equipment : Smart Band  
Brand Name : honor  
Model Name : NYX-B10  
Applicant : Huawei Technologies Co.,Ltd.  
Manufacturer : Huawei Technologies Co.,Ltd.  
Address : Administration Building, Headquarters of Huawei Technologies Co., Ltd.,  
Bantian,Longgang District, Shenzhen, 518129, P.R.C  
Factory : Flextronics Industrial (ZhuHai) Co., Ltd.  
Address : Xin Qing Science &Technology Industrial Park, Doumen, Zhuhai, GuangDong  
Date of Test : Mar. 27, 2017 ~ Apr. 12, 2017  
Test Sample : Engineering Sample  
Standard(s) : FCC Part15, Subpart C (15.247)  
ANSI C63.10-2013

The above equipment has been tested and found compliance with the requirement of the relative standards by BTL Inc.

The test data, data evaluation, and equipment configuration contained in our test report (Ref No. BTL-FCCP-1-1703C225) were obtained utilizing the test procedures, test instruments, test sites that has been accredited by the Authority of TAF according to the ISO-17025 quality assessment standard and technical standard(s).

## 2. SUMMARY OF TEST RESULTS

Test procedures according to the technical standard(s):

Applied Standard(s): FCC Part15 (15.247) , Subpart C			
Standard(s) Section	Test Item	Judgment	Remark
15.207	Conducted Emission	PASS	
15.247(d)	Antenna conducted Spurious Emission	PASS	
15.247(a)(2)	6dB Bandwidth	PASS	
15.247(b)(3)	Peak Output Power	PASS	
15.247(e)	Power Spectral Density	PASS	
15.203	Antenna Requirement	PASS	
15.247(d)/ 15.205/ 15.209	Transmitter Radiated Emissions	PASS	

NOTE:

(1) "N/A" denotes test is not applicable to this device.

## 2.1 TEST FACILITY

The test facilities used to collect the test data in this report is at the location of No.3, Jinshagang 1st Road, Shixia, Dalang Town, Dongguan, Guangdong, China.  
 BTL's test firm number for FCC: 319330

## 2.2 MEASUREMENT UNCERTAINTY

Where relevant, the following measurement uncertainty levels have been estimated for tests performed on the EUT as specified in CISPR 16-4-2. The BTL measurement uncertainty is less than the CISPR 16-4-2  $U_{\text{CISPR}}$  requirement.

The reported uncertainty of measurement  $y \pm U$ , where expanded uncertainty  $U$  is based on a standard uncertainty multiplied by a coverage factor of  $k=2$ , providing a level of confidence of approximately 95 %.

### A. Conducted Measurement:

Test Site	Method	Measurement Frequency Range	U, (dB)
DG-C02	CISPR	150 KHz ~ 30MHz	2.32

### B. Radiated Measurement:

Test Site	Method	Measurement Frequency Range	Ant. H / V	U, (dB)
DG-CB03	CISPR	9KHz~30MHz	V	3.79
		9KHz~30MHz	H	3.57
		30MHz ~ 200MHz	V	3.82
		30MHz ~ 200MHz	H	3.78
		200MHz ~ 1,000MHz	V	4.10
		200MHz ~ 1,000MHz	H	4.06
		1GHz~18GHz	V	3.12
		1GHz~18GHz	H	3.68
		18GHz~40GHz	V	4.15
		18GHz~40GHz	H	4.14

Note: Unless specifically mentioned, the uncertainty of measurement has not been taken into account to declare the compliance or non-compliance to the specification.



### 3. GENERAL INFORMATION

#### 3.1 GENERAL DESCRIPTION OF EUT

Equipment	Smart Band	
Brand Name	honor	
Model Name	NYX-B10	
Model Difference	N/A	
Product Description	Operation Frequency	2402~2480 MHz
	Modulation Technology	GFSK(1Mbps)
	Bit Rate of Transmitter	
	Output Power (Max.)	4.84dBm (1Mbps)
	Hardware Version	EB1NYXM
	Software Version	V1.0.41
Power Source	#1 Battery supplied. Model:HB351329ECW #2 Supplied from PC USB Port.	
Power Rating	#1 DC3.82V #2 DC 5V	

Note:

1. For a more detailed features description, please refer to the manufacturer's specifications or the user's manual.

2. Channel List:

Channel	Frequency (MHz)	Channel	Frequency (MHz)
00	2402	20	2442
01	2404	21	2444
02	2406	22	2446
03	2408	23	2448
04	2410	24	2450
05	2412	25	2452
06	2414	26	2454
07	2416	27	2456
08	2418	28	2458
09	2420	29	2460
10	2422	30	2462
11	2424	31	2464
12	2426	32	2466
13	2428	33	2468
14	2430	34	2470
15	2432	35	2472
16	2434	36	2474
17	2436	37	2476
18	2438	38	2478
19	2440	39	2480

3. Table for Filed Antenna:

Ant.	Brand	Model Name	Antenna Type	Connector	Gain (dBi)
1	N/A	N/A	Integral	N/A	0.5

### 3.2 DESCRIPTION OF TEST MODES

To investigate the maximum EMI emission characteristics generated from EUT, the test system was pre-scanning tested based on the consideration of following EUT operation mode or test configuration mode which possibly have effect on EMI emission level. Each of these EUT operation mode(s) or test configuration mode(s) mentioned above was evaluated respectively.

Pretest Mode	Description
Mode 1	TX Mode <b>NOTE (1)</b>

The EUT system operated these modes were found to be the worst case during the pre-scanning test as following:

For Conducted Test	
Final Test Mode	Description
Mode 1	TX Mode

For Radiated Test	
Final Test Mode	Description
Mode 1	TX Mode <b>NOTE (1)</b>

Note:

(1) The measurements are performed at the high, middle, low available channels.

### 3.3 TABLE OF PARAMETERS OF TEST SOFTWARE SETTING

During testing channel & power controlling software provided by the customer was used to control the operating channel as well as the output power level. The RF output power selection is for the setting of RF output power expected by the customer and is going to be fixed on the firmware of the final end product power parameters of BT LE

Test Software Version	SSCOM32		
Frequency (MHz)	2402	2440	2480
BT LE	4	4	4

**3.4 BLOCK DIAGRAM SHOWING THE CONFIGURATION OF SYSTEM TESTED**

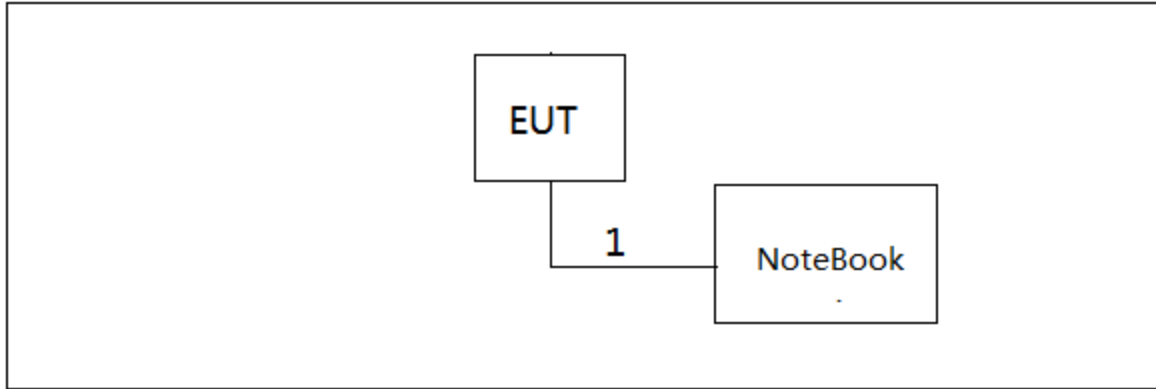

**3.5 DESCRIPTION OF SUPPORT UNITS**

The EUT has been tested as an independent unit together with other necessary accessories or support units. The following support units or accessories were used to form a representative test configuration during the tests.

Item	Equipment	Mfr/Brand	Model/Type No.	FCC ID	Series No.
A	NOTEBOOK	Dell	DCSM 745	DOC	G7K832X

Item	Shielded Type	Ferrite Core	Length	Note
1	NO	NO	0.2m	USB Cable

## 4. EMC EMISSION TEST

### 4.1 CONDUCTED EMISSION MEASUREMENT

#### 4.1.1 POWER LINE CONDUCTED EMISSION LIMITS (Frequency Range 150KHz-30MHz)

Frequency of Emission (MHz)	Conducted Limit (dBμV)	
	Quasi-peak	Average
0.15 -0.5	66 to 56*	56 to 46*
0.50 -5.0	56	46
5.0 -30.0	60	50

Note:

- (1) The limit of " \* " decreases with the logarithm of the frequency
- (2) The test result calculated as following:  
 Measurement Value = Reading Level + Correct Factor  
 Correct Factor = Insertion Loss + Cable Loss + Attenuator Factor(if use)  
 Margin Level = Measurement Value - Limit Value

The following table is the setting of the receiver

Receiver Parameters	Setting
Attenuation	10 dB
Start Frequency	0.15 MHz
Stop Frequency	30 MHz
IF Bandwidth	9 kHz

#### 4.1.2 TEST PROCEDURE

- a. The EUT was placed 0.8 meters from the horizontal ground plane with EUT being connected to the power mains through a line impedance stabilization network (LISN). All other support equipments powered from additional LISN(s). The LISN provide 50 Ohm/ 50uH of coupling impedance for the measuring instrument.
- b. Interconnecting cables that hang closer than 40 cm to the ground plane shall be folded back and forth in the center forming a bundle 30 to 40 cm long.
- c. I/O cables that are not connected to a peripheral shall be bundled in the center. The end of the cable may be terminated, if required, using the correct terminating impedance. The overall length shall not exceed 1 m.
- d. LISN at least 80 cm from nearest part of EUT chassis.
- e. For the actual test configuration, please refer to the related Item –EUT Test Photos.

#### 4.1.3 DEVIATION FROM TEST STANDARD

No deviation

#### 4.1.4 TEST SETUP

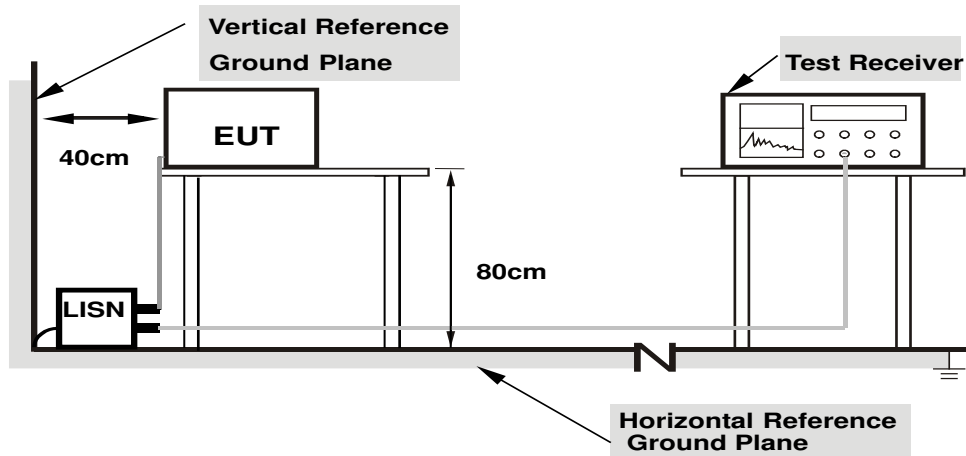

- Note:** 1.Support units were connected to second LISN.  
 2.Both of LISNs (AMN) are 80 cm from EUT and at least 80 from other units and other metal planes

#### 4.1.5 EUT OPERATING CONDITIONS

The EUT was configured for testing in a typical fashion (as a customer would normally use it). The EUT has been programmed to continuously transmit during test. This operating condition was tested and used to collect the included data.

#### 4.1.6 EUT TEST CONDITIONS

Temperature: 24°C    Relative Humidity: 60%    Test Voltage: AC 120V/60Hz

#### 4.1.7 TEST RESULTS

Please refer to the Attachment A.

Remark:

- (1) All readings are QP Mode value unless otherwise stated AVG in column of『Note』. If the QP Mode Measured value compliance with the QP Limits and lower than AVG Limits, the EUT shall be deemed to meet both QP & AVG Limits and then only QP Mode was measured, but AVG Mode didn't perform.In this case, a “ \* ” marked in AVG Mode column of Interference Voltage Measured.
- (2) Measuring frequency range from 150KHz to 30MHz.
- (3) “ N/A” denotes test is not applicable to this device.

## 4.2 RADIATED EMISSION MEASUREMENT

### 4.2.1 RADIATED EMISSION LIMITS

In case the emission fall within the restricted band specified on 15.205(a), then the 15.209(a) limit in the table below has to be followed.

#### LIMITS OF RADIATED EMISSION MEASUREMENT (9KHz-1000MHz)

Frequency (MHz)	Field Strength (microvolts/meter)	Measurement Distance (meters)
0.009~0.490	2400/F(KHz)	300
0.490~1.705	24000/F(KHz)	30
1.705~30.0	30	30
30~88	100	3
88~216	150	3
216~960	200	3
960~1000	500	3

#### LIMITS OF RADIATED EMISSION MEASUREMENT (Above 1000MHz)

Frequency (MHz)	Band edge at 3m (dBμV/m)		Harmonic at 1.5m (dBμV/m)	
	Peak	Average	Peak	Average
Above 1000	74	54	80 (Note 5)	60(Note 5)

#### Notes:

- (1) The limit for radiated test was performed according to FCC PART 15C.
- (2) The tighter limit applies at the band edges.
- (3) Emission level (dBuV/m)=20log Emission level (uV/m).
- (4) The test result calculated as following:  
 Measurement Value = Reading Level + Correct Factor  
 Correct Factor = Antenna Factor + Cable Loss - Amplifier Gain(if use)  
 Margin Level = Measurement Value - Limit Value

(5)

$$FS_{\text{limit}} = FS_{\text{max}} - 20 \log \left( \frac{d_{\text{limit}}}{d_{\text{measure}}} \right)$$

$$20 \log d_{\text{limit}}/d_{\text{measure}} = 20 \log 3/1.5 = 6 \text{dB.}$$

Spectrum Parameter	Setting
Attenuation	Auto
Start Frequency	1000 MHz
Stop Frequency	10th carrier harmonic
RBW / VBW (Emission in restricted band)	RBW 1MHz VBW 3MHz peak detector for Pk value RMS detector for AV value

Receiver Parameter	Setting
Attenuation	Auto
Start ~ Stop Frequency	9KHz~90KHz for PK/AVG detector
Start ~ Stop Frequency	90KHz~110KHz for QP detector
Start ~ Stop Frequency	110KHz~490KHz for PK/AVG detector
Start ~ Stop Frequency	490KHz~30MHz for QP detector
Start ~ Stop Frequency	30MHz~1000MHz for QP detector

#### 4.2.2 TEST PROCEDURE

- a. The measuring distance of 3 m shall be used for measurements. The EUT was placed on the top of a rotating table 0.8 meter above the ground at a 3 meter semi-anechoic chamber. The table was rotated 360 degrees to determine the position of the highest radiation.(below 1GHz)
- b. The measuring distance of 3 m or 1.5m shall be used for measurements. The EUT was placed on the top of a rotating table 1.5 meter above the ground at a 3 meter semi-anechoic chamber. The table was rotated 360 degrees to determine the position of the highest radiation.(above 1GHz)
- c. The height of the equipment or of the substitution antenna shall be 0.8m or 1.5m; the height of the test antenna shall vary between 1 m to 4 m. Both horizontal and vertical polarizations of the antenna are set to make the measurement.
- d. For each suspected emission, the EUT was arranged to its worst case and then the antenna was tuned to heights find the maximum reading (used Bore sight function).
- e. The receiver system was set to peak and average detect function and specified bandwidth with maximum hold mode when the test frequency is above 1GHz.
- f. The initial step in collecting radiated emission data is a receiver peak detector mode pre-scanning the measurement frequency range. Significant peaks are then marked and then Quasi Peak detector mode re-measured.
- g. All readings are Peak unless otherwise stated QP in column of Note. Peak denotes that the Peak reading compliance with the QP Limits and then QP Mode measurement didn't perform. (below 1GHz)
- h. All readings are Peak Mode value unless otherwise stated AVG in column of Note. If the Peak Mode Measured value compliance with the Peak Limits and lower than AVG Limits, the EUT shall be deemed to meet both Peak & AVG Limits and then only Peak Mode was measured, but AVG Mode didn't perform. (above 1GHz)
- i. For the actual test configuration, please refer to the related Item –EUT Test Photos.

#### 4.2.3 DEVIATION FROM TEST STANDARD

No deviation



#### 4.2.4 TEST SETUP

(A) Radiated Emission Test Set-Up Frequency Below 1 GHz

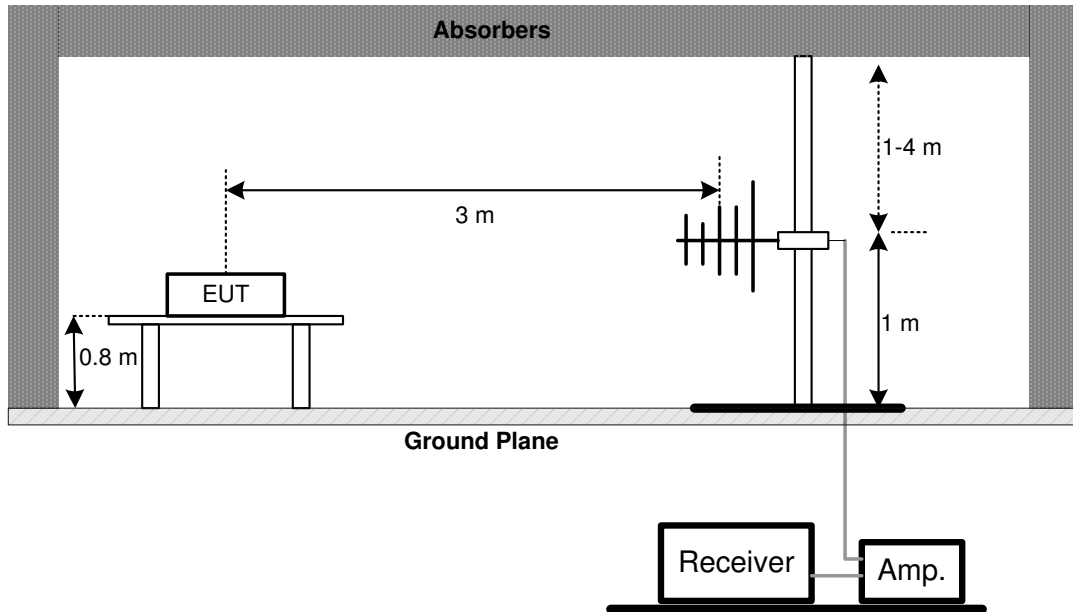

(B) Radiated Emission Test Set-Up Frequency Above 1 GHz  
 Band edge

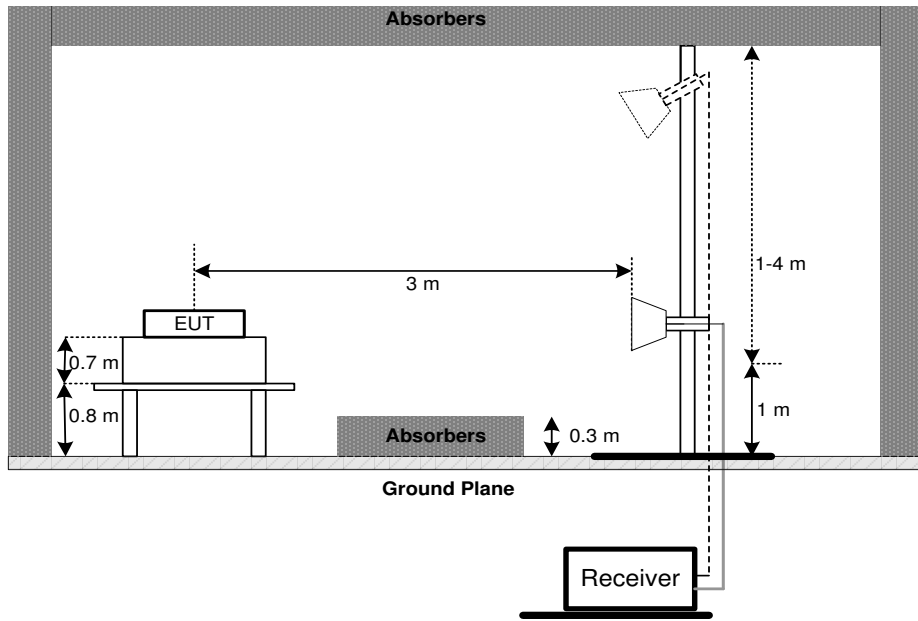

Harmonic

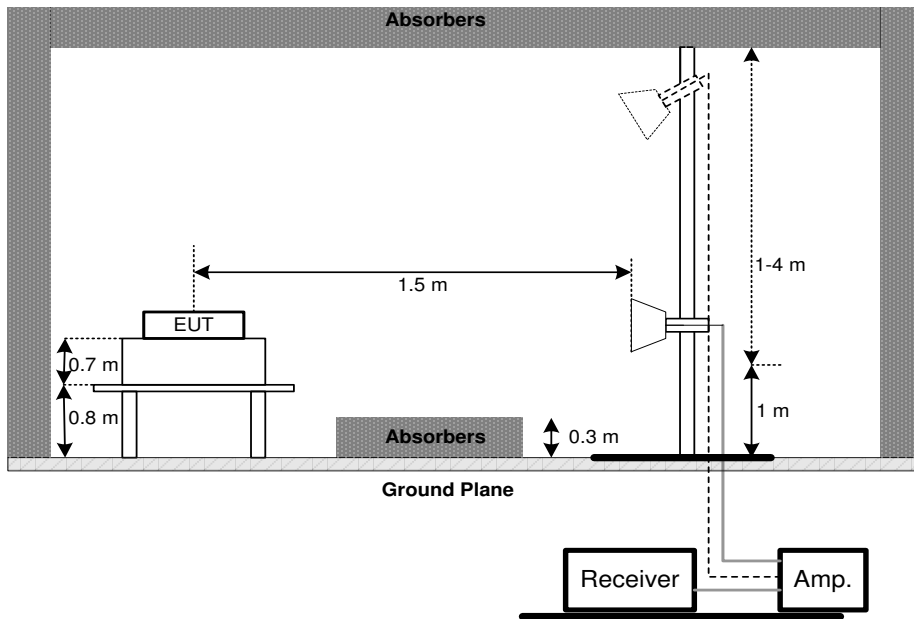

(C) For radiated emissions below 30MHz

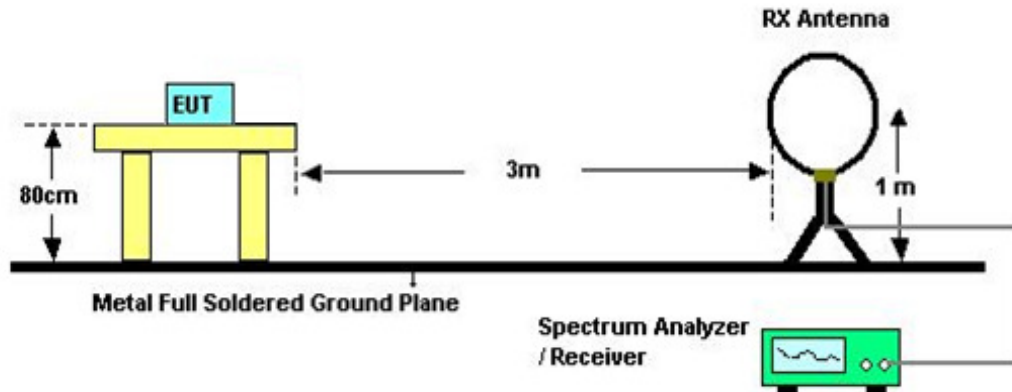

**4.2.5 EUT OPERATING CONDITIONS**

The EUT was programmed to be in continuously transmitting mode.

**4.2.6 EUT TEST CONDITIONS**

Temperature: 22°C    Relative Humidity: 56%    Test Voltage: AC 120V/60Hz

**4.2.7 TEST RESULTS (9KHZ TO 30MHZ)**

Please refer to the Attachment B

Remark:

- (1) The amplitude of spurious emissions which are attenuated by more than 20 dB below the permissible value has no need to be reported.
- (2) Distance extrapolation factor =  $40 \log(\text{specific distance} / \text{test distance})$  (dB).
- (3) Limit line = specific limits (dBuV) + distance extrapolation factor.

**4.2.8 TEST RESULTS (30MHZ TO 1000 MHZ)**

Please refer to the Attachment C.

**4.2.9 TEST RESULTS (ABOVE 1000 MHZ)**

Please refer to the Attachment D.

Remark:

- (1) No limit: This is fundamental signal, the judgment is not applicable. For fundamental signal judgment was referred to Peak output test.

## 5. BANDWIDTH TEST

### 5.1 APPLIED PROCEDURES / LIMIT

FCC Part15 (15.247) , Subpart C				
Section	Test Item	Limit	Frequency Range (MHz)	Result
15.247(a)(2)	Bandwidth	$\geq 500\text{KHz}$ (6dB bandwidth)	2400-2483.5	PASS

#### 5.1.1 TEST PROCEDURE

- a. The EUT was directly connected to the spectrum analyzer and antenna output port as show in the block diagram below,
- b. Spectrum Setting : RBW= 100KHz, VBW=300KHz, Sweep time = 2.5 ms.

#### 5.1.2 DEVIATION FROM STANDARD

No deviation.

#### 5.1.3 TEST SETUP

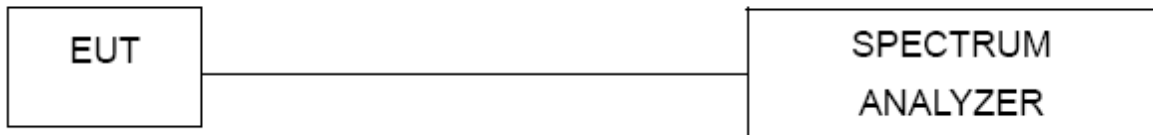

#### 5.1.4 EUT OPERATION CONDITIONS

The EUT tested system was configured as the statements of 4.1.5 unless otherwise a special operating condition is specified in the follows during the testing.

#### 5.1.5 EUT TEST CONDITIONS

Temperature: 24°C    Relative Humidity: 60%    Test Voltage: AC 120V/60Hz

#### 5.1.6 TEST RESULTS

Please refer to the Attachment E.

## 6. MAXIMUM OUTPUT POWER TEST

### 6.1 APPLIED PROCEDURES / LIMIT

FCC Part15 (15.247) , Subpart C				
Section	Test Item	Limit	Frequency Range (MHz)	Result
15.247(b)(3)	Maximum Output Power	1 watt or 30dBm	2400-2483.5	PASS

#### 6.1.1 TEST PROCEDURE

- a. The EUT was directly connected to the power meter and antenna output port as show in the block diagram below,
- b. The maximum peak conducted output power was performed in accordance with method 9.1.2 of FCC KDB 558074 D01 DTS Meas Guidance.

#### 6.1.2 DEVIATION FROM STANDARD

No deviation.

#### 6.1.3 TEST SETUP



#### 6.1.4 EUT OPERATION CONDITIONS

The EUT tested system was configured as the statements of 4.1.5 unless otherwise a special operating condition is specified in the follows during the testing.

#### 6.1.5 EUT TEST CONDITIONS

Temperature: 24°C    Relative Humidity: 60%    Test Voltage: AC 120V/60Hz

#### 6.1.6 TEST RESULTS

Please refer to the Attachment F.

## 7. ANTENNA CONDUCTED SPURIOUS EMISSION

### 7.1 APPLIED PROCEDURES / LIMIT

In any 100 kHz bandwidth outside the frequency band in which the spread spectrum or digitally modulated device is operating, the RF power that is produced shall be at least 20 dB below that in the 100 kHz bandwidth within the band that contains the highest level of the desired power, based on either an RF conducted or a radiated measurement, provided that the transmitter demonstrates compliance with the peak conducted power limits.

#### 7.1.1 TEST PROCEDURE

- a. The EUT was directly connected to the spectrum analyzer and antenna output port as show in the block diagram below,
- b. Spectrum Setting : RBW= 100KHz, VBW=300KHz, Sweep time = 10 ms.
- c. Offset=antenna gain+cable loss

#### 7.1.2 DEVIATION FROM STANDARD

No deviation.

#### 7.1.3 TEST SETUP

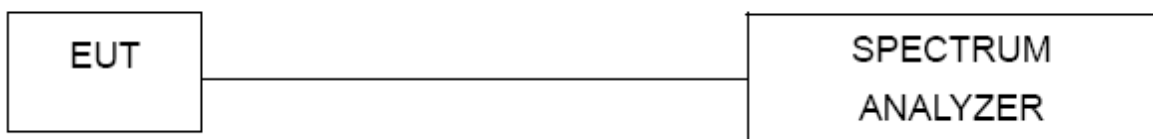

#### 7.1.4 EUT OPERATION CONDITIONS

The EUT tested system was configured as the statements of 4.1.5 unless otherwise a special operating condition is specified in the follows during the testing.

#### 7.1.5 EUT OPERATION CONDITIONS

Temperature: 24°C    Relative Humidity: 60%    Test Voltage: AC 120V/60Hz

#### 7.1.6 TEST RESULTS

Please refer to the Attachment G.

## 8. POWER SPECTRAL DENSITY TEST

### 8.1 APPLIED PROCEDURES / LIMIT

FCC Part15 (15.247) , Subpart C				
Section	Test Item	Limit	Frequency Range (MHz)	Result
15.247(e)	Power Spectral Density	8 dBm (in any 3KHz)	2400-2483.5	PASS

#### 8.1.1 TEST PROCEDURE

- a. The EUT was directly connected to the spectrum analyzer and antenna output port as show in the block diagram below,
- b. Spectrum Setting: RBW=3KHz, VBW=10 KHz, Sweep time = auto.

#### 8.1.2 DEVIATION FROM STANDARD

No deviation.

#### 8.1.3 TEST SETUP



#### 8.1.4 EUT OPERATION CONDITIONS

The EUT tested system was configured as the statements of 4.1.5 unless otherwise a special operating condition is specified in the follows during the testing.

#### 8.1.5 EUT TEST CONDITIONS

Temperature: 24°C    Relative Humidity: 60%    Test Voltage: AC 120V/60Hz

#### 8.1.6 TEST RESULTS

Please refer to the Attachment H.

## 9. MEASUREMENT INSTRUMENTS LIST

Conducted Emission Measurement					
Item	Kind of Equipment	Manufacturer	Type No.	Serial No.	Calibrated until
1	LISN	EMCO	3816/2	0052765	Mar. 26, 2018
2	LISN	R&S	ENV216	101447	Mar. 26, 2018
3	Test Cable	emci	RG223(9KHz-30M Hz)	C_17	Mar. 09, 2018
4	EMI Test Receiver	R&S	ESCI	100382	Mar. 26, 2018
5	50Ω Terminator	SHX	TF2-3G-A	08122901	Mar. 26, 2018
6	Measurement Software	Farad	EZ-EMC Ver.NB-03A1-01	N/A	N/A

Radiated Emission Measurement					
Item	Kind of Equipment	Manufacturer	Type No.	Serial No.	Calibrated until
1	Antenna	Schwarzbeck	VULB9160	9160-3232	Mar. 26, 2018
2	Amplifier	HP	8447D	2944A09673	Nov. 08, 2017
3	Receiver	AGILENT	N9038A	MY52130039	Oct. 10, 2017
4	Test Cable	emci	LMR-400(30MHz-1GHz)	C-01	Jun. 26, 2017
5	Control	CT	SC100	N/A	N/A
6	Position Control	MF	MF-7802	MF780208416	N/A
7	Antenna	ETS	3115	00075789	Mar. 27, 2017
8	Amplifier	Agilent	8449B	3008A02274	Oct. 31, 2017
9	Receiver	AGILENT	N9038A	MY52130039	Oct. 10, 2017
10	Test Cable	emci	EMC104-SM-S M-10000(1GHz – 26.5GHz)	C-68	Jun. 26, 2017
11	Controller	CT	SC100	N/A	N/A
12	Broad-Band Horn Antenna	Schwarzbeck	BBHA 9170	9170319	Apr. 23, 2017
13	Microwave Preamplifier With Adaptor	EMC INSTRUMENT	EMC2654045	980039 & HA01	Mar. 26, 2018
14	Active Loop Antenna	R&S	HFH2-Z2	830749/020	Sep. 06, 2017
15	Measurement Software	Farad	EZ-EMC Ver.NB-03A1-01	N/A	N/A



<b>6dB Bandwidth Measurement</b>					
Item	Kind of Equipment	Manufacturer	Type No.	Serial No.	Calibrated until
1	Spectrum Analyzer	R&S	FSP 40	100185	Sep. 04, 2017

<b>Peak Output Power Measurement</b>					
Item	Kind of Equipment	Manufacturer	Type No.	Serial No.	Calibrated until
1	Power Meter	ANRITSU	ML2495A	1128009	Mar. 26, 2018
2	Pulse Power Sensor	ANRITSU	MA 2411B	1027500	Mar. 26, 2018

<b>Antenna Conducted Spurious Emission Measurement</b>					
Item	Kind of Equipment	Manufacturer	Type No.	Serial No.	Calibrated until
1	Spectrum Analyzer	R&S	FSP 40	100185	Sep. 04, 2017

<b>Power Spectral Density Measurement</b>					
Item	Kind of Equipment	Manufacturer	Type No.	Serial No.	Calibrated until
1	Spectrum Analyzer	R&S	FSP 40	100185	Sep. 04, 2017

Remark: "N/A" denotes no model name, serial no. or calibration specified.  
 All calibration period of equipment list is one year.

## ATTACHMENT A - CONDUCTED EMISSION

Test Mode: TX Mode

### Line

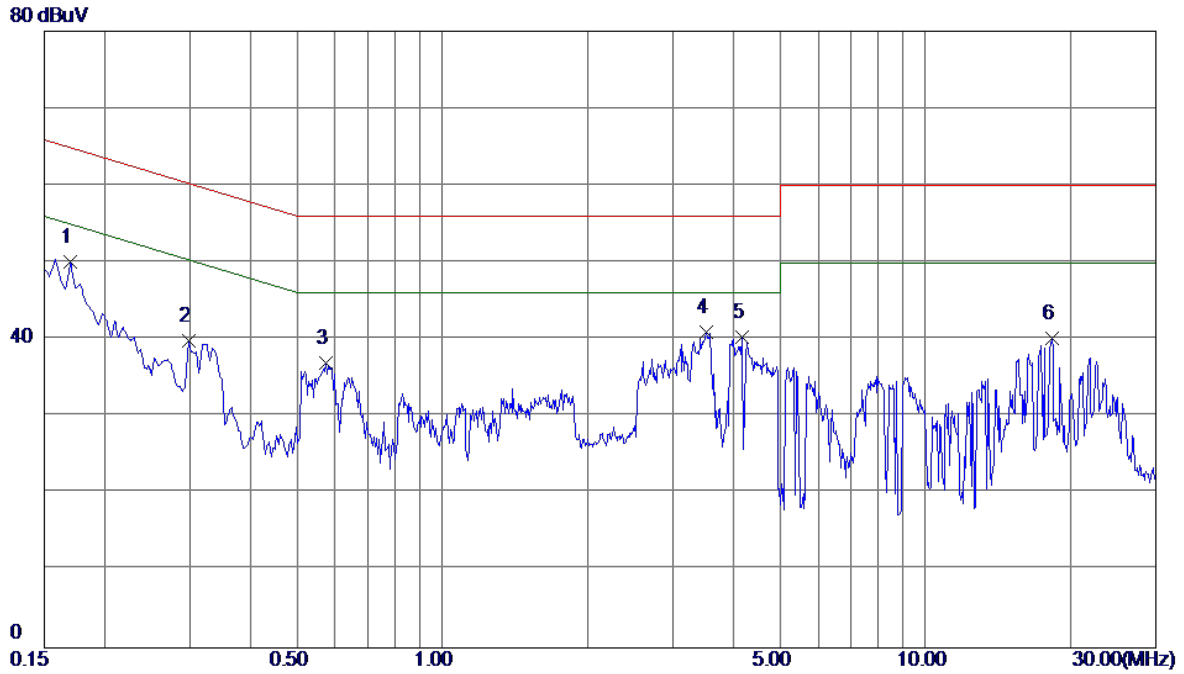

No.	Freq. MHz	Reading Level dBuV	Correct Factor dB	Measure ment dBuV	Limit dBuV	Margin dB	Detector	Comment
1 *	0.1700	40.57	9.57	50.14	64.96	-14.82	Peak	
2	0.2980	30.23	9.58	39.81	60.30	-20.49	Peak	
3	0.5740	27.24	9.70	36.94	56.00	-19.06	Peak	
4	3.5140	30.58	10.33	40.91	56.00	-15.09	Peak	
5	4.1779	29.98	10.36	40.34	56.00	-15.66	Peak	
6	18.2979	29.34	10.77	40.11	60.00	-19.89	Peak	

Test Mode: TX Mode

### Neutral

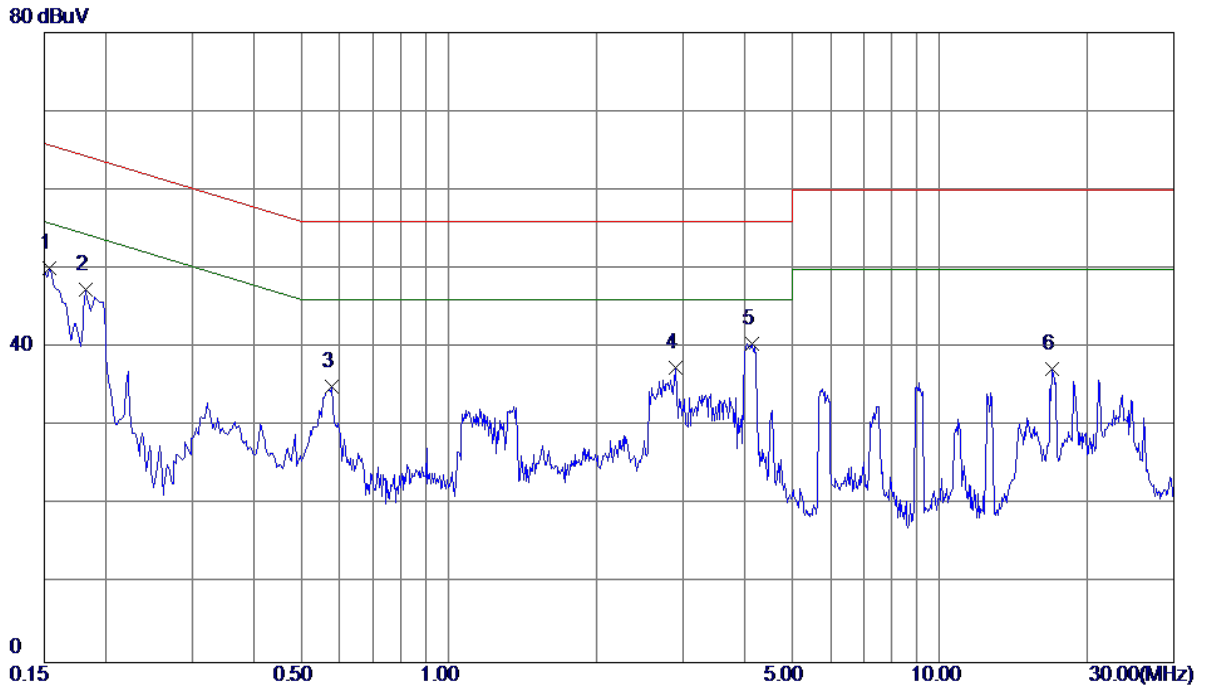

No.	Freq. MHz	Reading Level dBuV	Correct Factor dB	Measure ment dBuV	Limit dBuV	Margin dB	Detector	Comment
1	0.1539	40.58	9.55	50.13	65.79	-15.66	Peak	
2	0.1819	37.89	9.51	47.40	64.40	-17.00	Peak	
3	0.5780	25.59	9.50	35.09	56.00	-20.91	Peak	
4	2.9020	27.49	9.95	37.44	56.00	-18.56	Peak	
5 *	4.1420	30.42	10.11	40.53	56.00	-15.47	Peak	
6	16.9460	26.44	10.78	37.22	60.00	-22.78	Peak	

**ATTACHMENT B - RADIATED EMISSION (9KHZ TO 30MHZ)**

Test Mode: TX Mode

Ant 0°

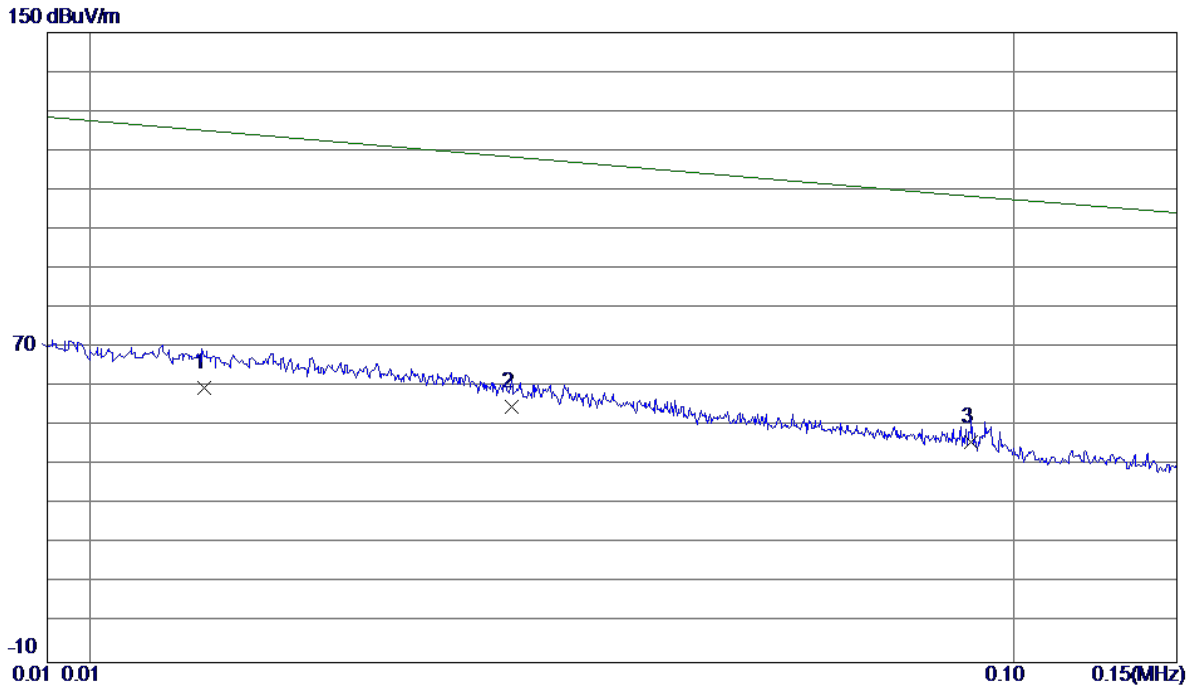

No.	Freq. MHz	Reading Level dBuV/m	Correct Factor dB	Measure ment dBuV/m	Limit dBuV/m	Margin dB	Detector	Comment
1	0.0133	35.89	23.92	59.81	127.43	-67.62	AVG	
2	0.0286	32.37	22.46	54.83	123.66	-68.83	AVG	
3 *	0.0899	27.01	18.87	45.88	108.52	-62.64	AVG	

Test Mode: TX Mode

Ant 0°

150 dBuV/m

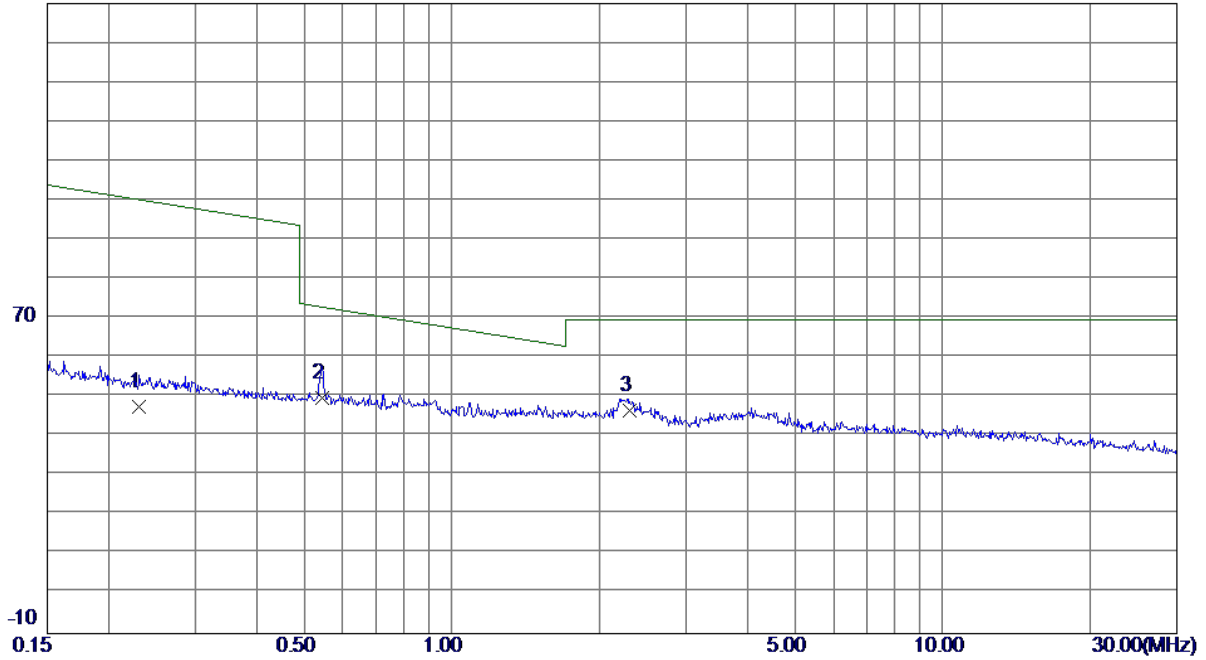

No.	Freq. MHz	Reading Level dBuV/m	Correct Factor dB	Measurement dBuV/m	Limit dBuV/m	Margin dB	Detector	Comment
1	0.2304	28.95	18.67	47.62	102.67	-55.05	AVG	
2	0.5435	31.36	18.39	49.75	73.32	-23.57	QP	
3 *	2.2968	29.08	17.53	46.61	69.54	-22.93	QP	

Test Mode: TX Mode

Ant 90°

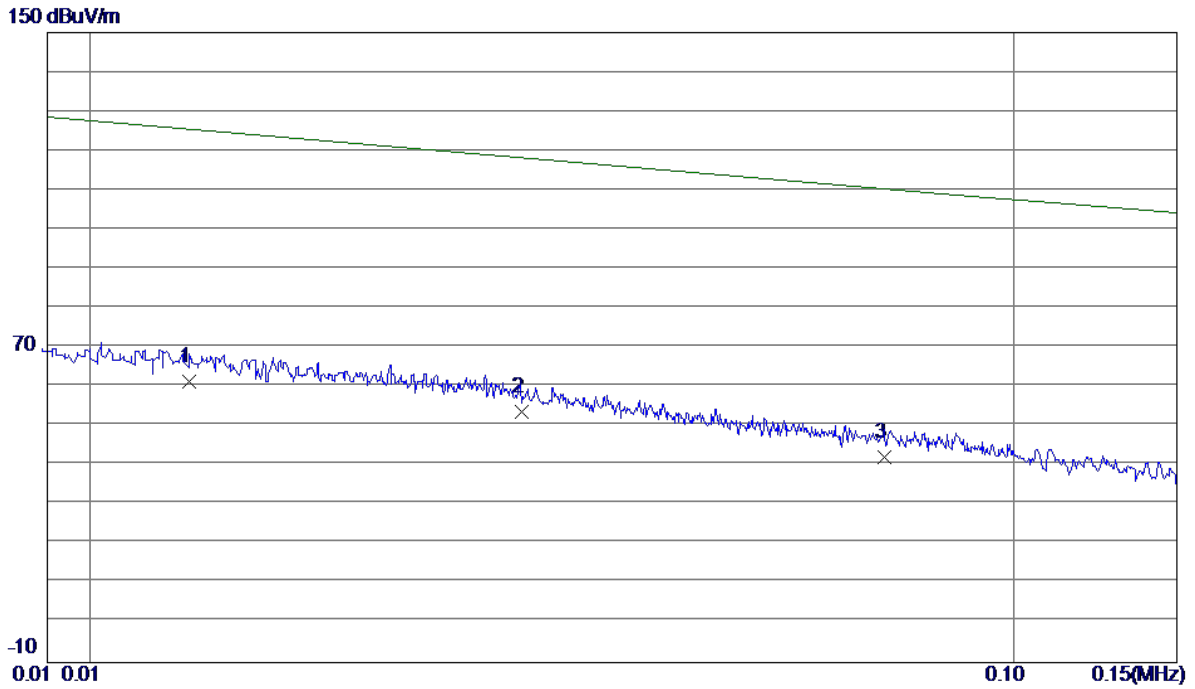

No.	Freq. MHz	Reading Level dBuV/m	Correct Factor dB	Measure ment dBuV/m	Limit dBuV/m	Margin dB	Detector	Comment
1 *	0.0128	37.47	23.95	61.42	127.56	-66.14	AVG	
2	0.0293	31.42	22.38	53.80	123.48	-69.68	AVG	
3	0.0724	22.51	19.56	42.07	112.84	-70.77	AVG	



Test Mode: TX Mode

Ant 90°

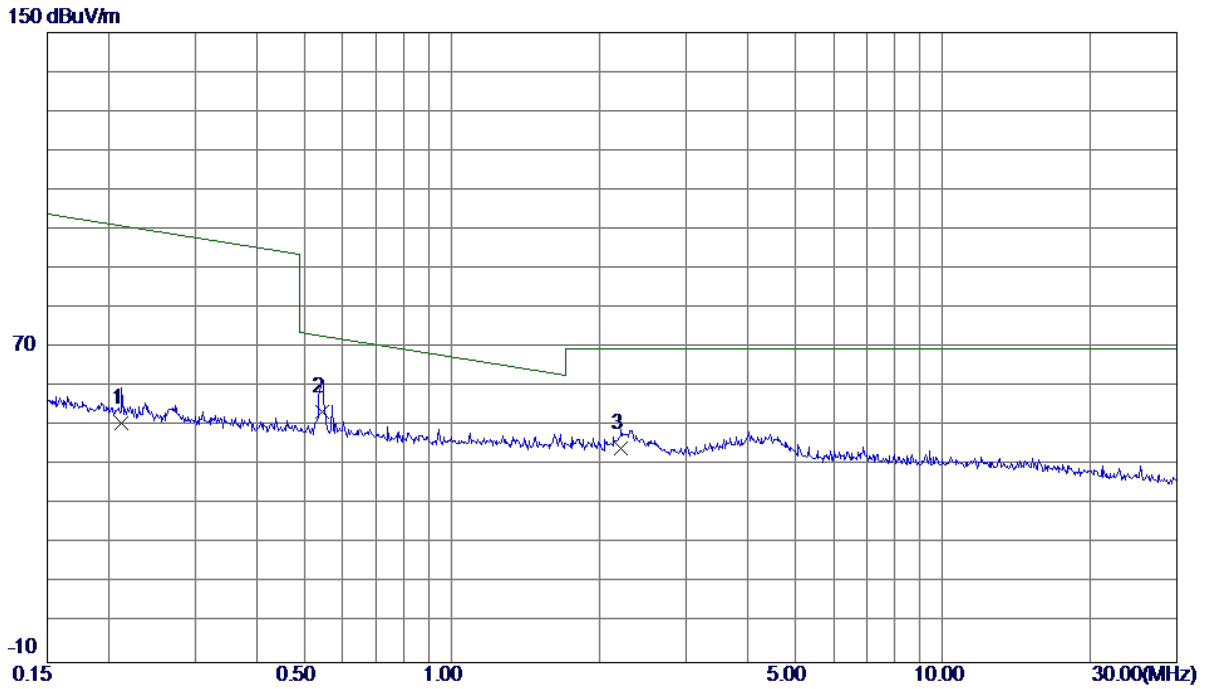

No.	Freq. MHz	Reading Level dBuV/m	Correct Factor dB	Measure ment dBuV/m	Limit dBuV/m	Margin dB	Detector	Comment
1	0.2128	32.04	18.68	50.72	103.27	-52.55	AVG	
2 *	0.5435	35.38	18.39	53.77	73.32	-19.55	QP	
3	2.2132	26.66	17.63	44.29	69.54	-25.25	QP	

**ATTACHMENT C - RADIATED EMISSION (30MHZ TO 1000MHZ)**

Test Mode: TX 2402MHz\_CH00\_1Mbps

### Vertical

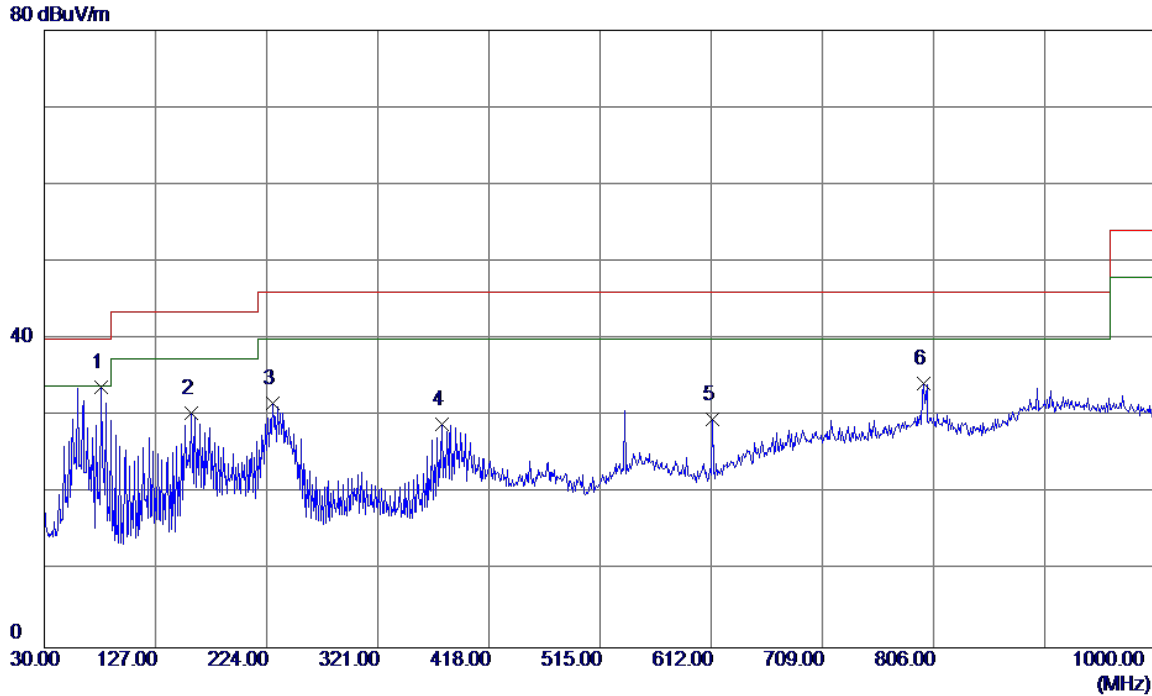

No.	Freq. MHz	Reading Level dBuV/m	Correct Factor dB	Measure ment dBuV/m	Limit dBuV/m	Margin dB	Detector	Comment
1 *	79.4700	49.81	-16.10	33.71	40.00	-6.29	Peak	
2	158.0399	42.67	-12.30	30.37	43.50	-13.13	Peak	
3	229.8200	45.02	-13.38	31.64	46.00	-14.36	Peak	
4	377.2600	38.29	-9.34	28.95	46.00	-17.05	Peak	
5	612.9699	35.93	-6.31	29.62	46.00	-16.38	Peak	
6	797.2700	34.08	0.14	34.22	46.00	-11.78	Peak	

Test Mode: TX 2402MHz\_CH00\_1Mbps

### Horizontal

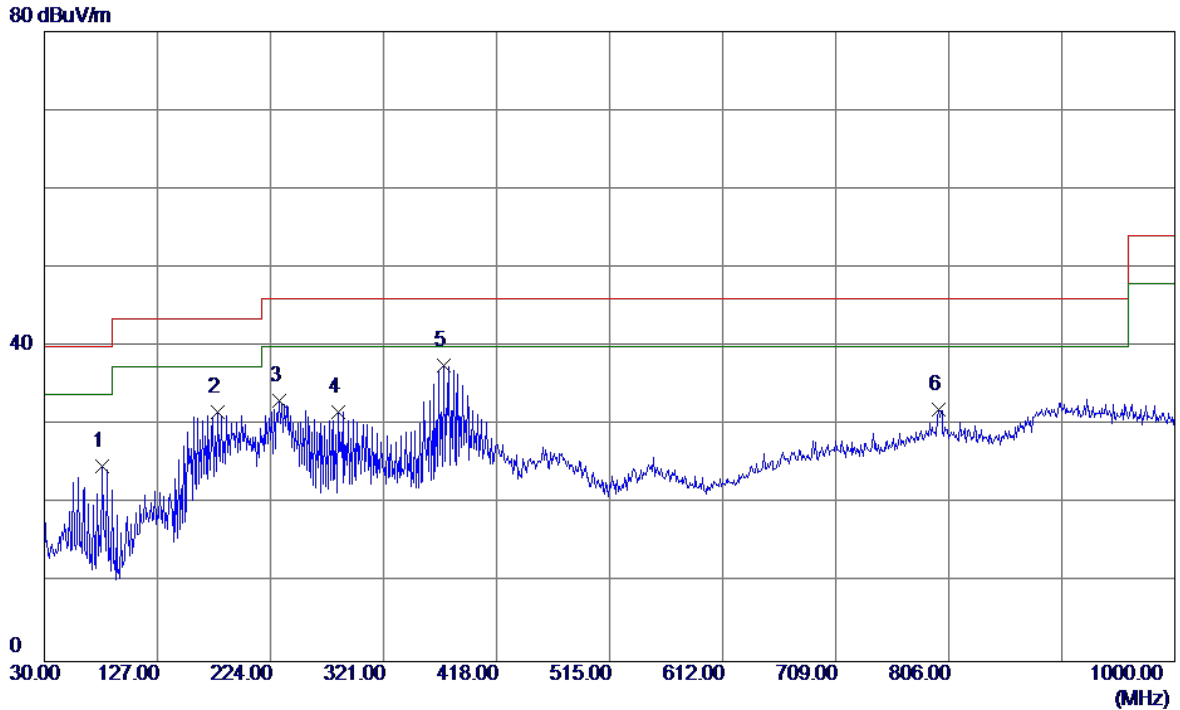

No.	Freq. MHz	Reading Level dBuV/m	Correct Factor dB	Measure ment dBuV/m	Limit dBuV/m	Margin dB	Detector	Comment
1	79.4700	40.90	-16.10	24.80	40.00	-15.20	Peak	
2	178.4100	44.48	-12.74	31.74	43.50	-11.76	Peak	
3	231.7600	46.54	-13.44	33.10	46.00	-12.90	Peak	
4	282.2000	43.61	-11.86	31.75	46.00	-14.25	Peak	
5 *	372.4100	47.28	-9.68	37.60	46.00	-8.40	Peak	
6	797.2700	31.88	0.14	32.02	46.00	-13.98	Peak	

Test Mode: TX 2480MHz \_CH39\_ 1Mbps

**Vertical**

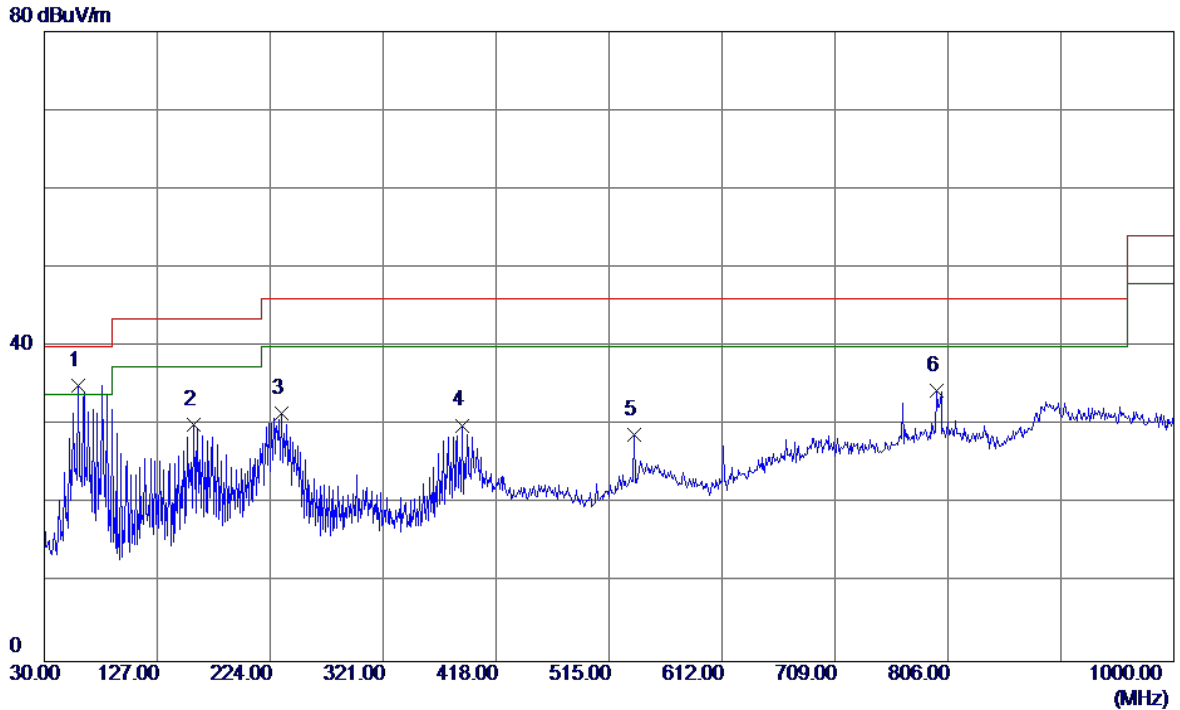

No.	Freq. MHz	Reading Level dBuV/m	Correct Factor dB	Measure ment dBuV/m	Limit dBuV/m	Margin dB	Detector	Comment
1 *	59.1000	48.83	-13.77	35.06	40.00	-4.94	Peak	
2	158.0399	42.43	-12.30	30.13	43.50	-13.37	Peak	
3	233.7000	45.05	-13.52	31.53	46.00	-14.47	Peak	
4	388.9000	38.54	-8.54	30.00	46.00	-16.00	Peak	
5	536.3400	34.70	-5.96	28.74	46.00	-17.26	Peak	
6	796.3000	34.34	0.09	34.43	46.00	-11.57	Peak	

Test Mode: TX 2480MHz \_CH39\_ 1Mbps

**Horizontal**

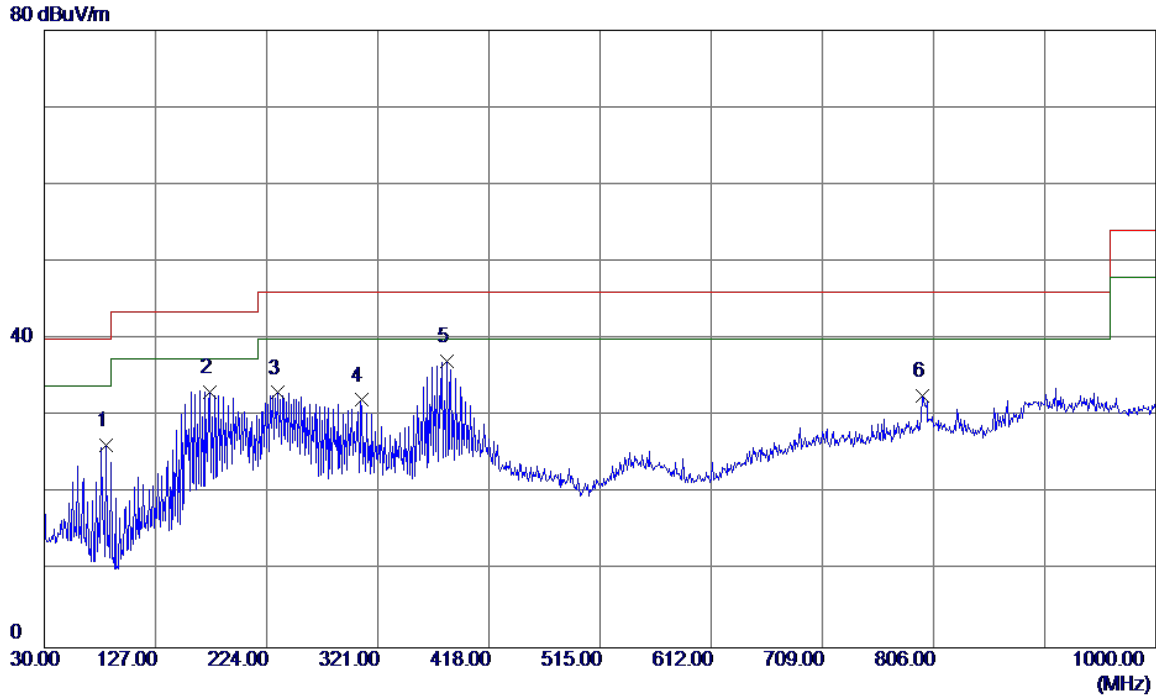

No.	Freq. MHz	Reading Level dBuV/m	Correct Factor dB	Measure ment dBuV/m	Limit dBuV/m	Margin dB	Detector	Comment
1	84.3200	43.38	-17.21	26.17	40.00	-13.83	Peak	
2	174.5300	45.68	-12.51	33.17	43.50	-10.33	Peak	
3	233.7000	46.56	-13.52	33.04	46.00	-12.96	Peak	
4	306.4500	42.38	-10.30	32.08	46.00	-13.92	Peak	
5 *	381.1400	46.22	-9.08	37.14	46.00	-8.86	Peak	
6	796.3000	32.54	0.09	32.63	46.00	-13.37	Peak	

## ATTACHMENT D - RADIATED EMISSION (ABOVE 1000MHZ)

Test Mode : TX 2402MHz \_CH00\_1Mbps

Vertical

115 dBuV/m

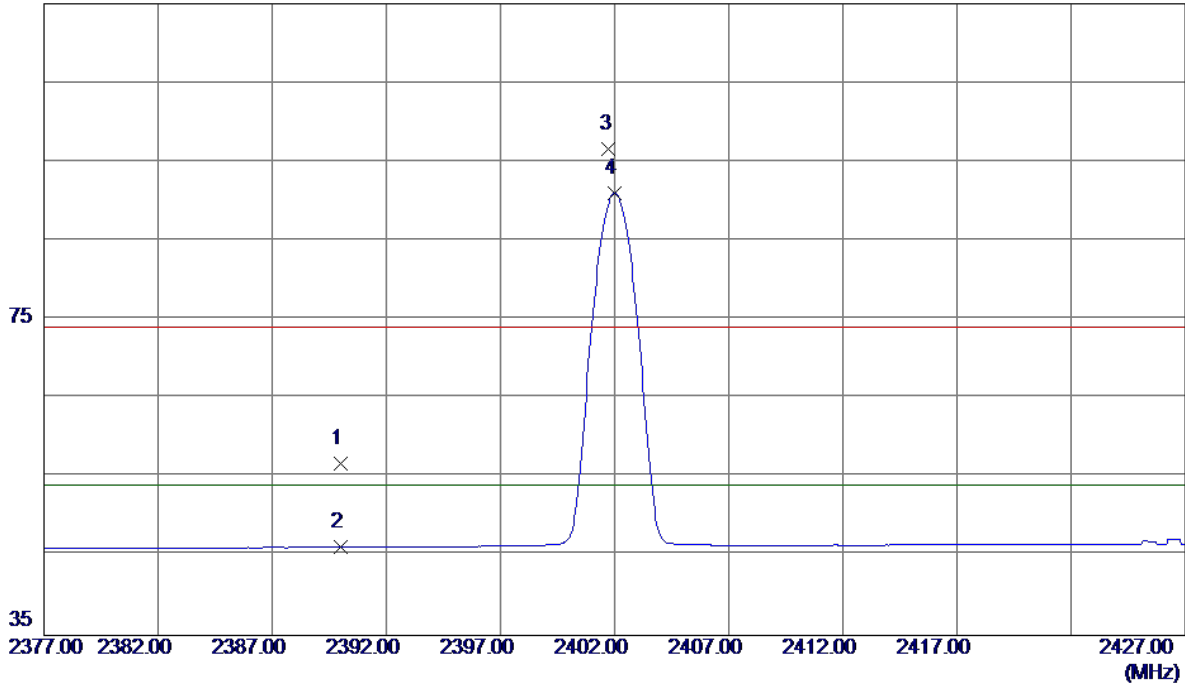

No.	Freq. MHz	Reading Level dBuV/m	Correct Factor dB	Measure ment dBuV/m	Limit dBuV/m	Margin dB	Detector	Comment
1	2390.0000	23.79	33.01	56.80	74.00	-17.20	Peak	
2	2390.0000	13.16	33.01	46.17	54.00	-7.83	AVG	
3	2401.7500	63.55	33.06	96.61	74.00	22.61	Peak	No Limit
4 *	2402.0000	57.94	33.06	91.00	54.00	37.00	AVG	No Limit



Test Mode : TX 2402MHz \_CH00\_1Mbps

Vertical

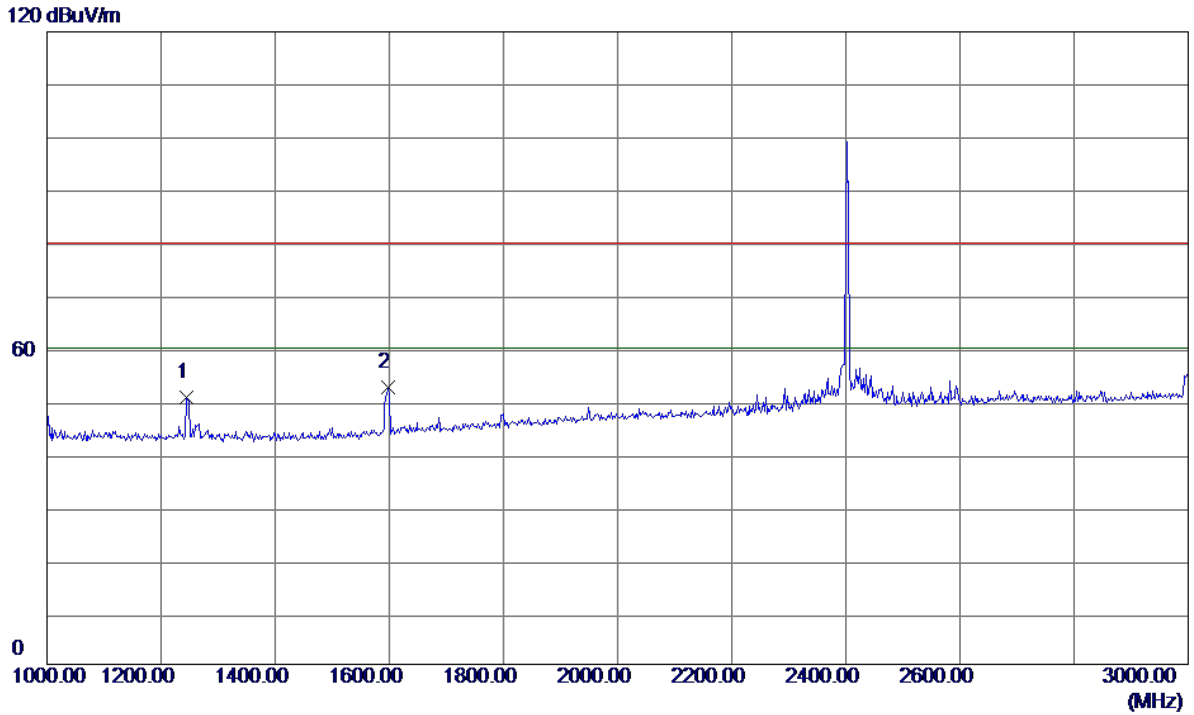

No.	Freq. MHz	Reading Level dBuV/m	Correct Factor dB	Measure ment dBuV/m	Limit dBuV/m	Margin dB	Detector	Comment
1	1244.0000	47.85	2.69	50.54	80.00	-29.46	Peak	
2 *	1598.0000	48.57	4.10	52.67	80.00	-27.33	Peak	

Test Mode : TX 2402MHz \_CH00\_1Mbps

**Vertical**

110 dBuV/m

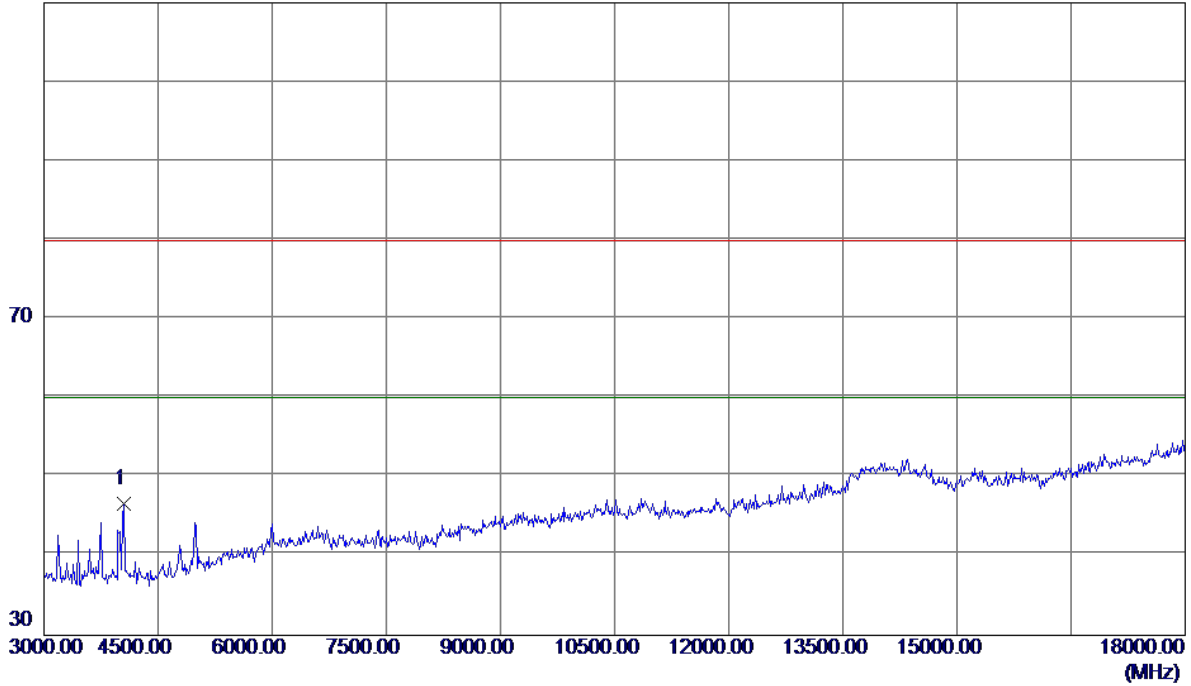

No.	Freq. MHz	Reading Level dBuV/m	Correct Factor dB	Measure ment dBuV/m	Limit dBuV/m	Margin dB	Detector	Comment
1 *	4050.0000	43.62	3.00	46.62	80.00	-33.38	Peak	

Test Mode : TX 2402MHz \_CH00\_1Mbps

**Vertical**

110 dBuV/m



No.	Freq. MHz	Reading Level dBuV/m	Correct Factor dB	Measure ment dBuV/m	Limit dBuV/m	Margin dB	Detector	Comment

Test Mode : TX 2402MHz \_CH00\_1Mbps

Horizontal

115 dBuV/m

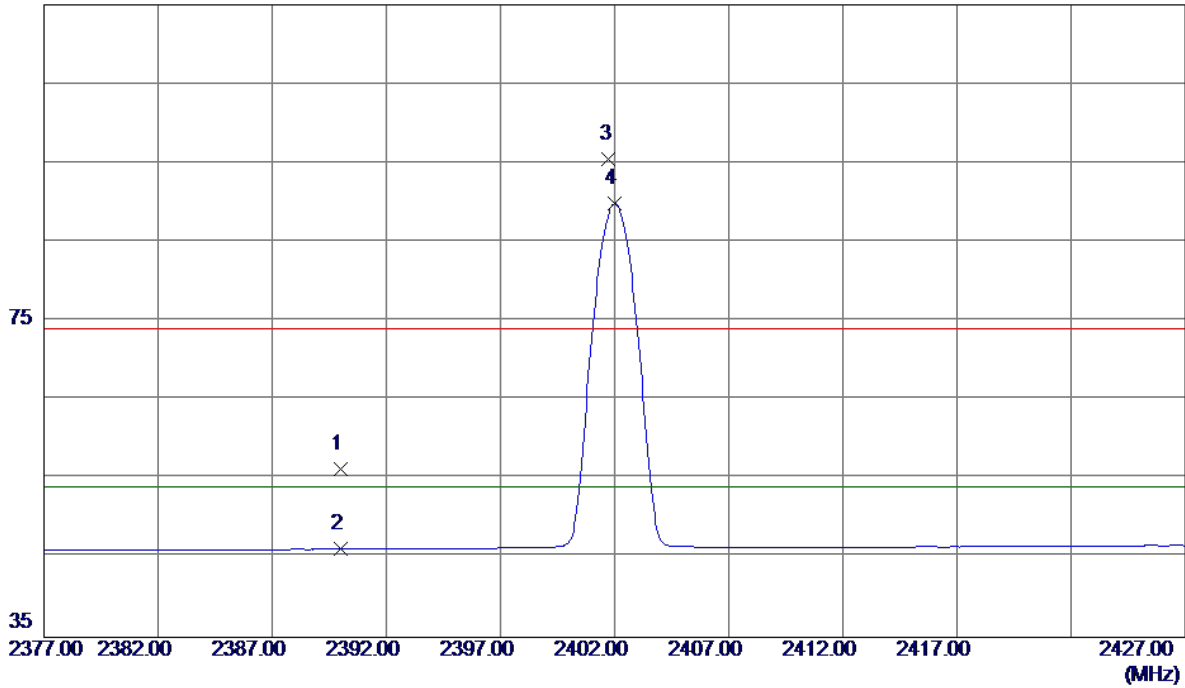

No.	Freq. MHz	Reading Level dBuV/m	Correct Factor dB	Measure ment dBuV/m	Limit dBuV/m	Margin dB	Detector	Comment
1	2390.0000	23.24	33.01	56.25	74.00	-17.75	Peak	
2	2390.0000	13.13	33.01	46.14	54.00	-7.86	AVG	
3	2401.7500	62.36	33.06	95.42	74.00	21.42	Peak	No Limit
4 *	2402.0000	56.77	33.06	89.83	54.00	35.83	AVG	No Limit

Test Mode : TX 2402MHz \_CH00\_1Mbps

Horizontal

120 dBuV/m

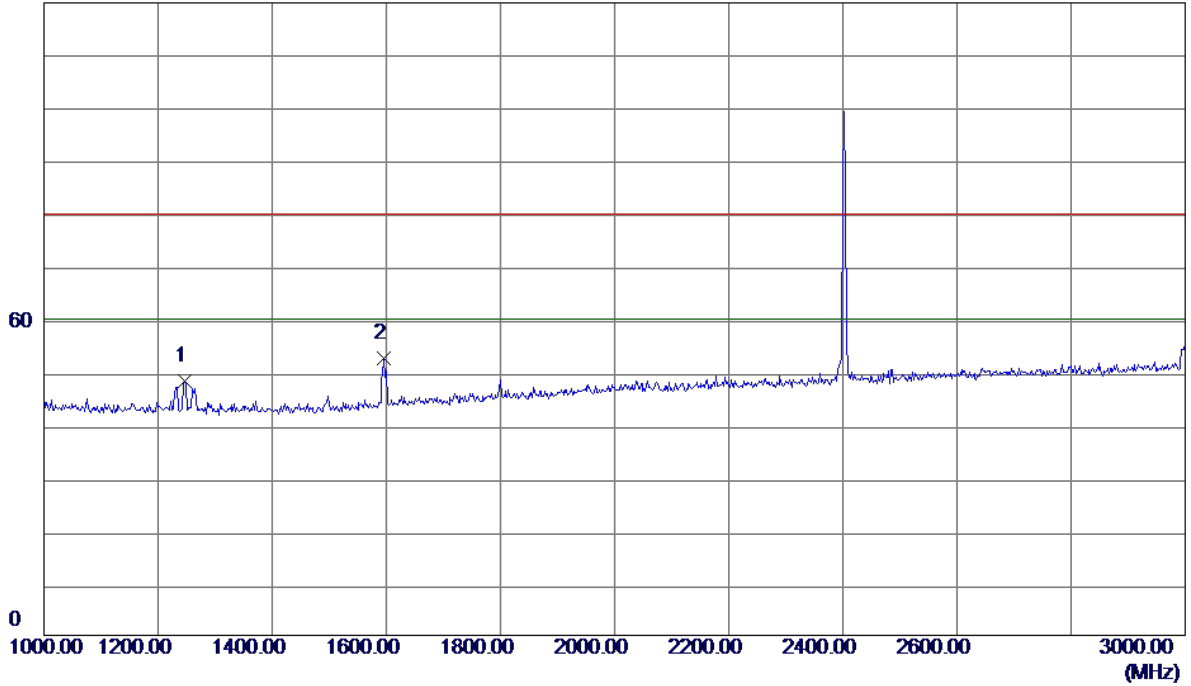

No.	Freq. MHz	Reading Level dBuV/m	Correct Factor dB	Measure ment dBuV/m	Limit dBuV/m	Margin dB	Detector	Comment
1	1246.0000	45.52	2.70	48.22	80.00	-31.78	Peak	
2 *	1596.0000	48.47	4.09	52.56	80.00	-27.44	Peak	

Test Mode : TX 2402MHz \_CH00\_1Mbps

**Horizontal**

110 dBuV/m

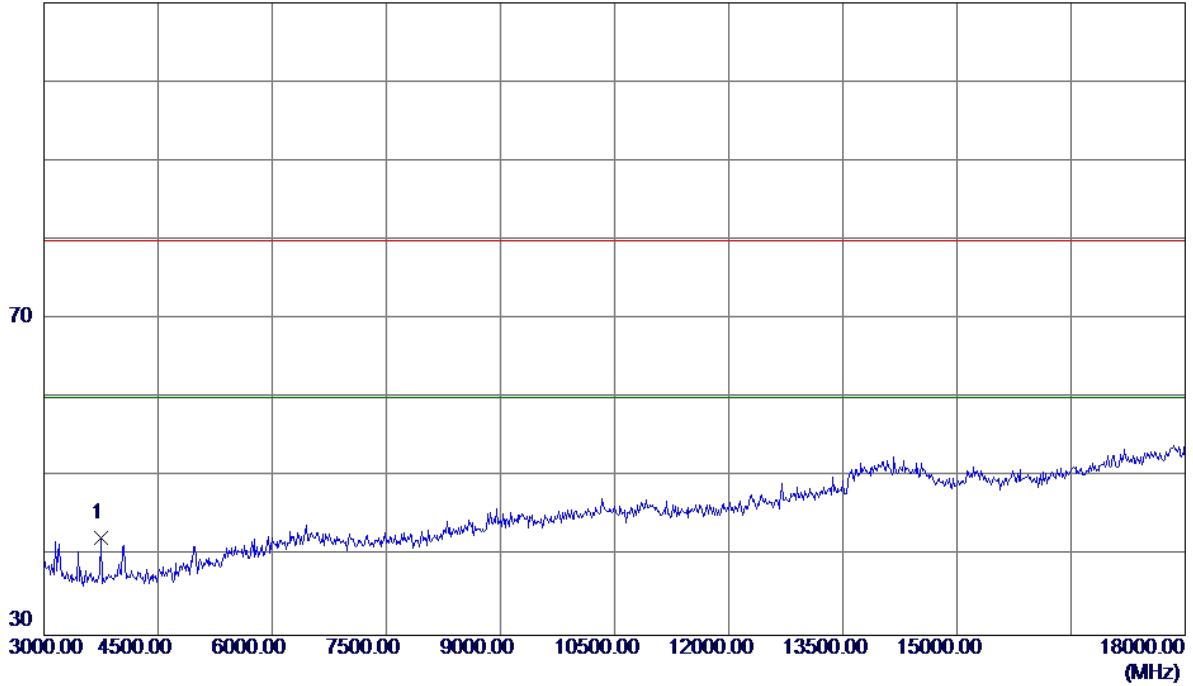

No.	Freq. MHz	Reading Level dBuV/m	Correct Factor dB	Measure ment dBuV/m	Limit dBuV/m	Margin dB	Detector	Comment
1 *	3750.0000	40.23	2.13	42.36	80.00	-37.64	Peak	

Test Mode : TX 2402MHz \_CH00\_1Mbps

**Horizontal**

110 dBuV/m

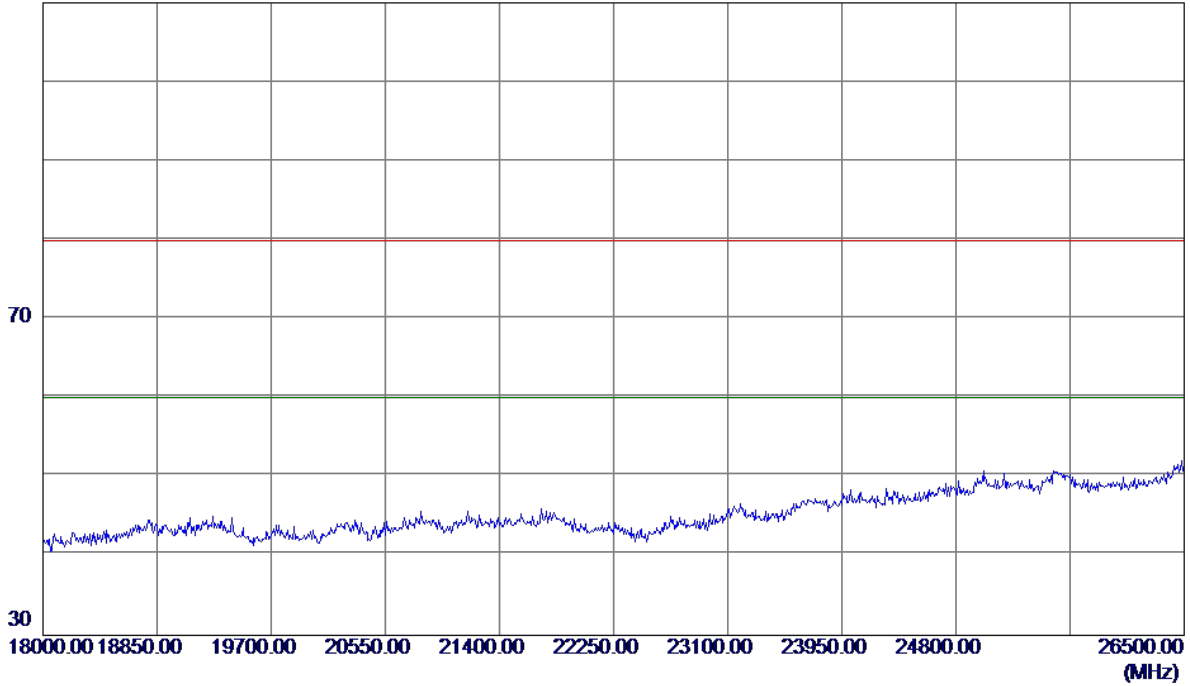

No.	Freq. MHz	Reading Level dBuV/m	Correct Factor dB	Measure ment dBuV/m	Limit dBuV/m	Margin dB	Detector	Comment

Test Mode : TX 2480MHz \_CH39\_1Mbps

Vertical

115 dBuV/m

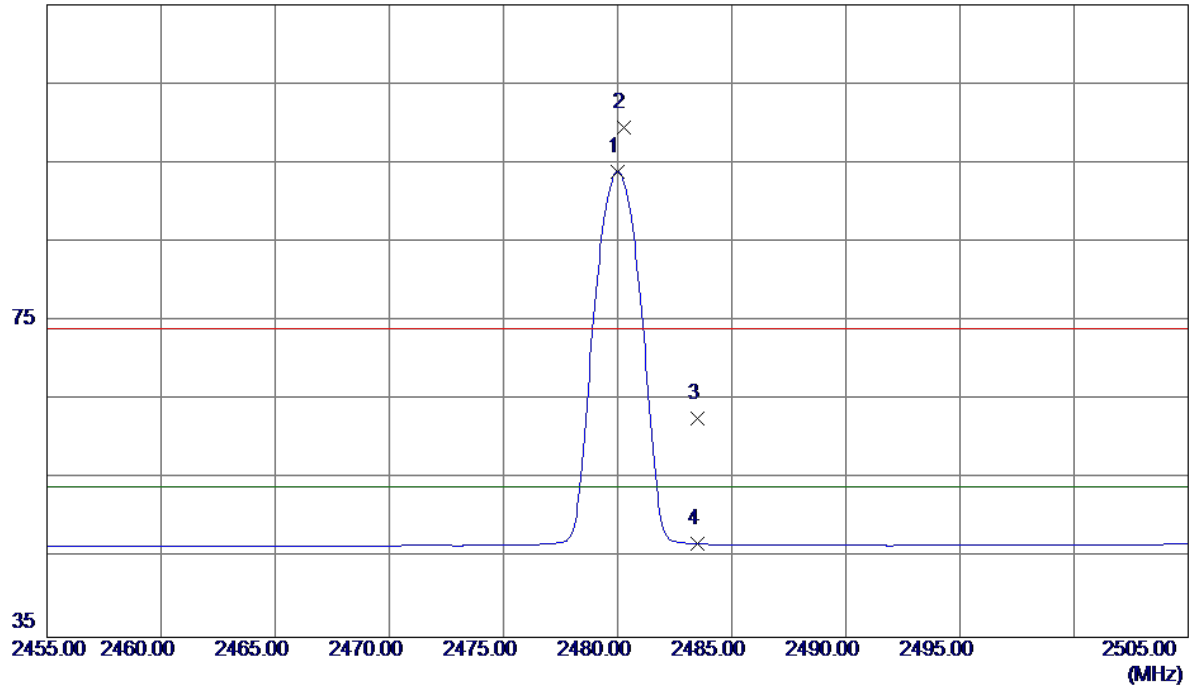

No.	Freq. MHz	Reading Level dBuV/m	Correct Factor dB	Measure ment dBuV/m	Limit dBuV/m	Margin dB	Detector	Comment
1 *	2480.0000	60.50	33.39	93.89	54.00	39.89	AVG	No Limit
2	2480.2500	66.14	33.39	99.53	74.00	25.53	Peak	No Limit
3	2483.5000	29.26	33.40	62.66	74.00	-11.34	Peak	
4	2483.5000	13.41	33.40	46.81	54.00	-7.19	AVG	



Test Mode : TX 2480MHz \_CH39\_1Mbps

**Vertical**

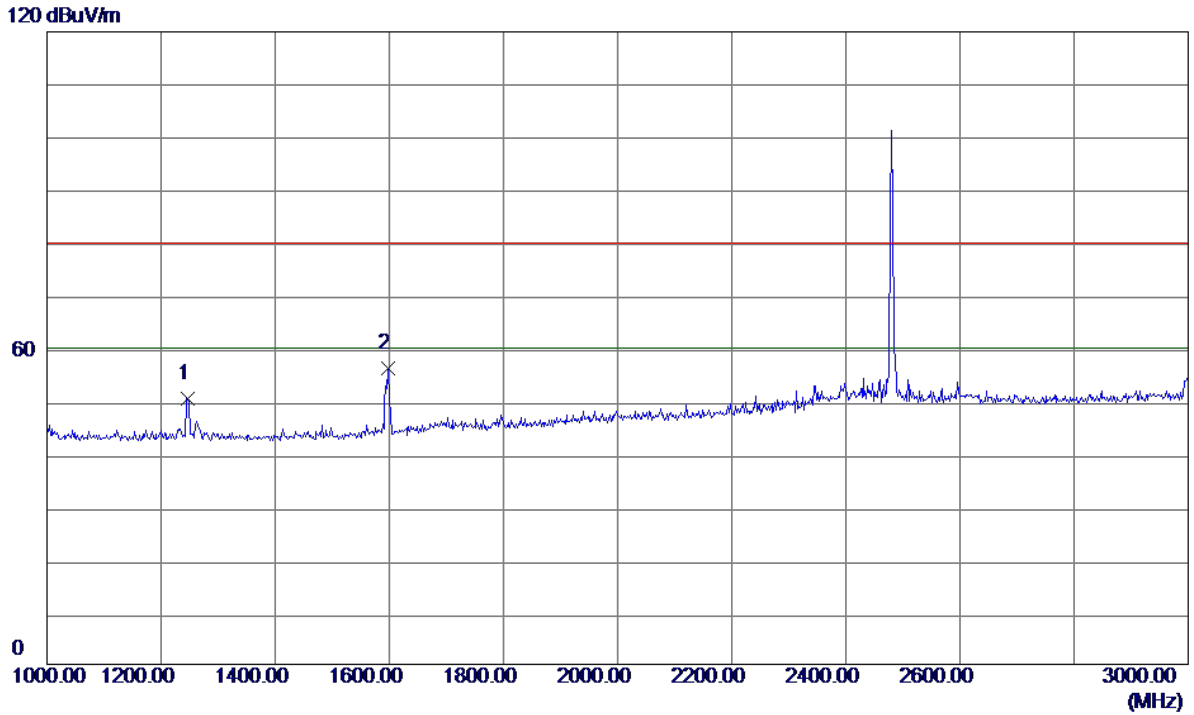

No.	Freq. MHz	Reading Level dBuV/m	Correct Factor dB	Measure ment dBuV/m	Limit dBuV/m	Margin dB	Detector	Comment
1	1246.0000	47.79	2.70	50.49	80.00	-29.51	Peak	
2 *	1598.0000	52.10	4.10	56.20	80.00	-23.80	Peak	

Test Mode : TX 2480MHz \_CH39\_1Mbps

**Vertical**

110 dBuV/m

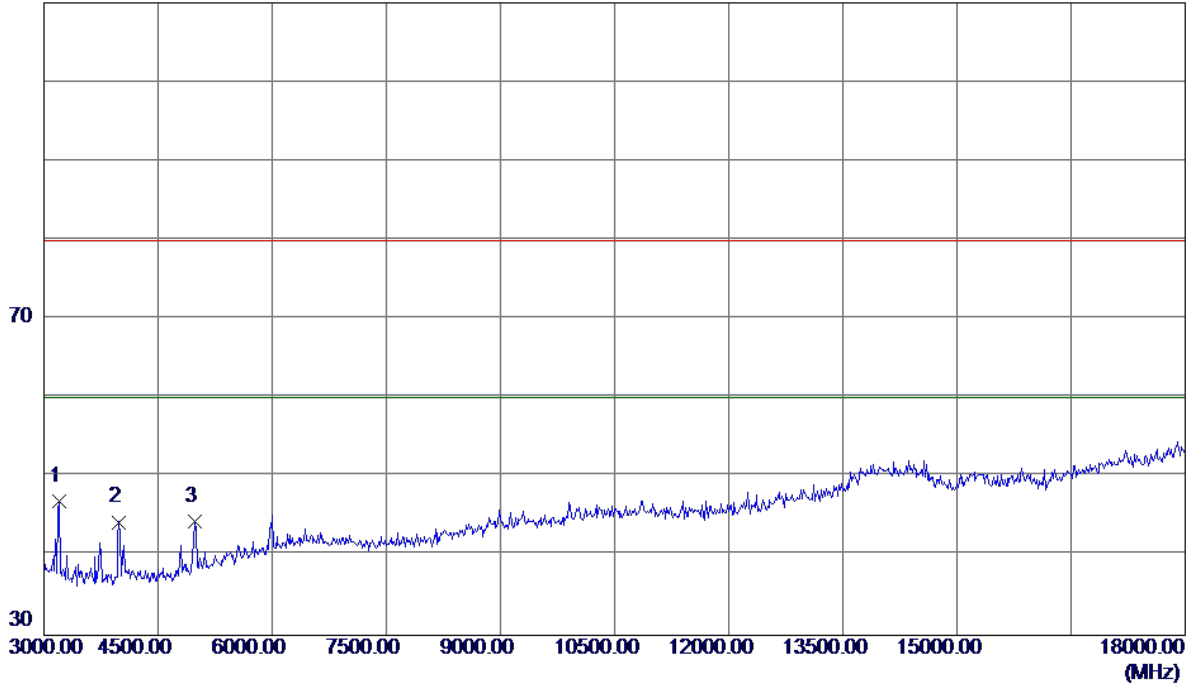

No.	Freq. MHz	Reading Level dBuV/m	Correct Factor dB	Measure ment dBuV/m	Limit dBuV/m	Margin dB	Detector	Comment
1 *	3195.0000	45.46	1.45	46.91	80.00	-33.09	Peak	
2	3990.0000	41.40	2.92	44.32	80.00	-35.68	Peak	
3	4980.0000	38.89	5.52	44.41	80.00	-35.59	Peak	

Test Mode : TX 2480MHz \_CH39\_1Mbps

**Vertical**

110 dBuV/m

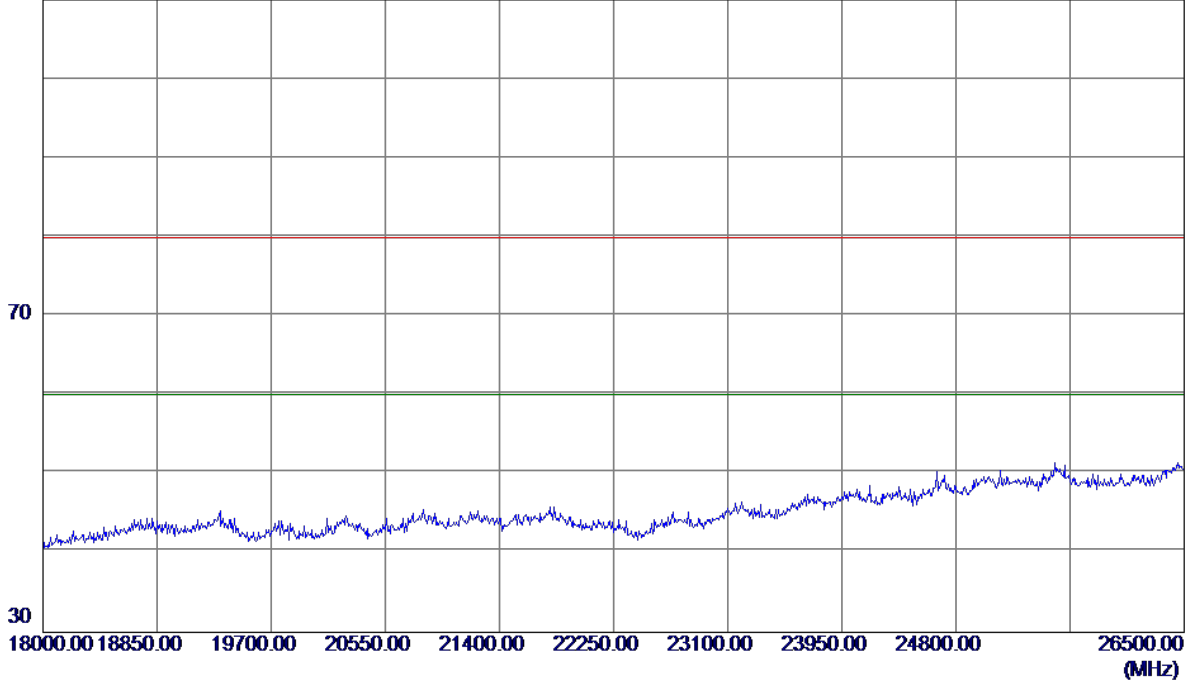

No.	Freq. MHz	Reading Level dBuV/m	Correct Factor dB	Measure ment dBuV/m	Limit dBuV/m	Margin dB	Detector	Comment

Test Mode : TX 2480MHz \_CH39\_1Mbps

Horizontal

115 dBuV/m

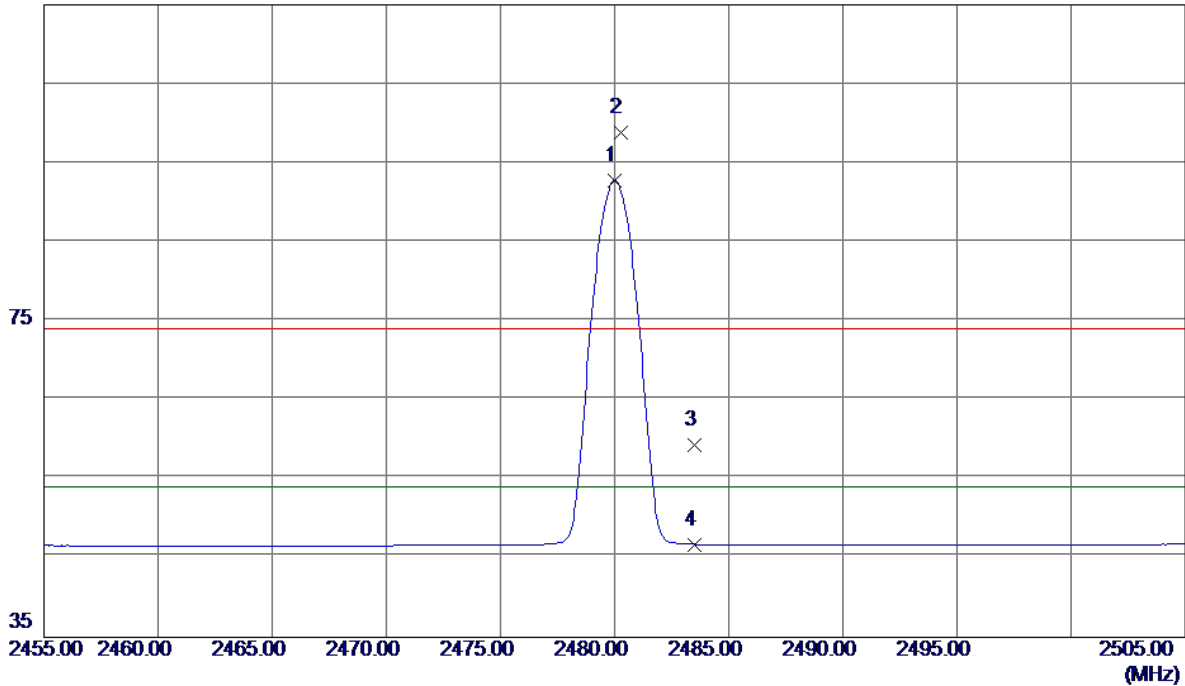

No.	Freq. MHz	Reading Level dBuV/m	Correct Factor dB	Measure ment dBuV/m	Limit dBuV/m	Margin dB	Detector	Comment
1 *	2480.0000	59.37	33.39	92.76	54.00	38.76	AVG	No Limit
2	2480.2500	65.43	33.39	98.82	74.00	24.82	Peak	No Limit
3	2483.5000	25.87	33.40	59.27	74.00	-14.73	Peak	
4	2483.5000	13.36	33.40	46.76	54.00	-7.24	AVG	

Test Mode : TX 2480MHz \_CH39\_1Mbps

**Horizontal**

120 dBuV/m

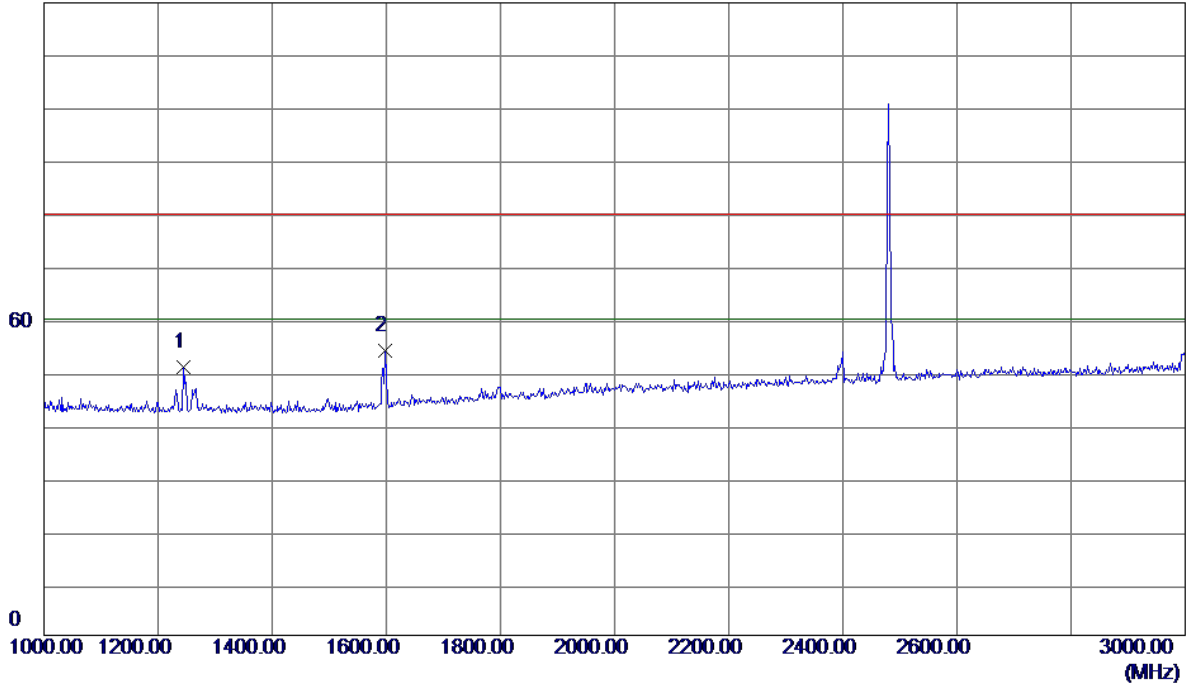

No.	Freq. MHz	Reading Level dBuV/m	Correct Factor dB	Measure ment dBuV/m	Limit dBuV/m	Margin dB	Detector	Comment
1	1244.0000	48.23	2.69	50.92	80.00	-29.08	Peak	
2 *	1598.0000	49.99	4.10	54.09	80.00	-25.91	Peak	

Test Mode : TX 2480MHz \_CH39\_1Mbps

Horizontal

110 dBuV/m

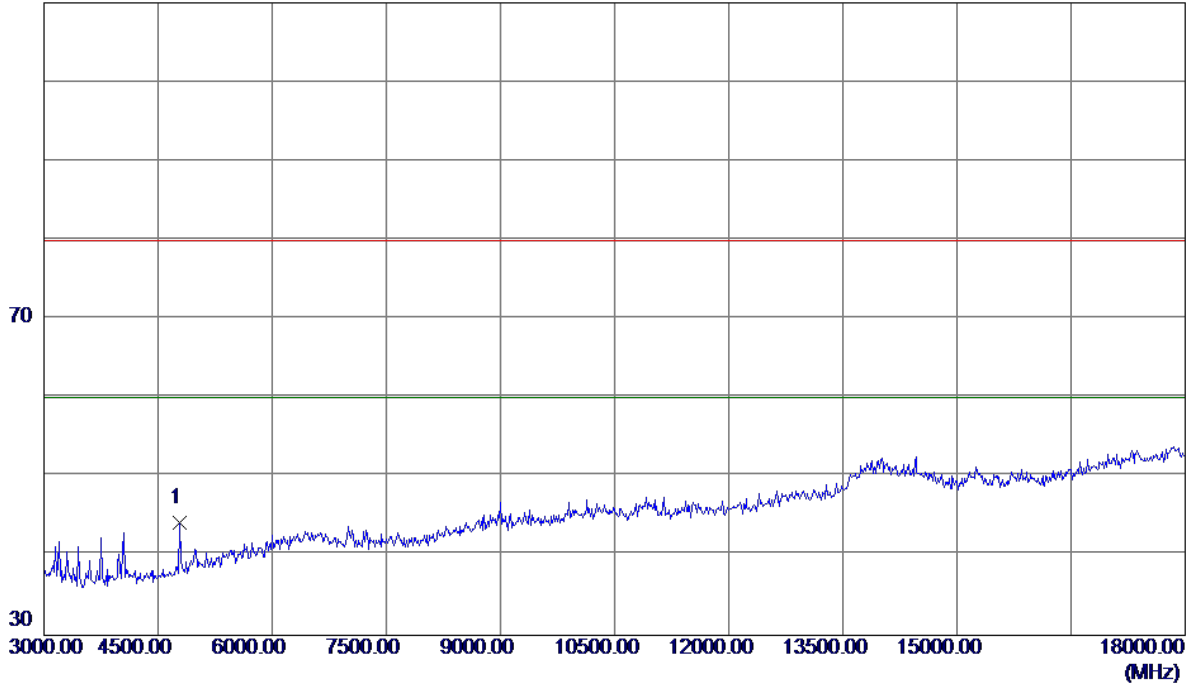

No.	Freq. MHz	Reading Level dBuV/m	Correct Factor dB	Measure ment dBuV/m	Limit dBuV/m	Margin dB	Detector	Comment
1 *	4785.0000	39.56	4.69	44.25	80.00	-35.75	Peak	

Test Mode : TX 2480MHz \_CH39\_1Mbps

**Horizontal**

110 dBuV/m



No.	Freq. MHz	Reading Level dBuV/m	Correct Factor dB	Measure ment dBuV/m	Limit dBuV/m	Margin dB	Detector	Comment

## ATTACHMENT E - BANDWIDTH



Test Mode: TX Mode

Frequency (MHz)	6dB Bandwidth (MHz)	99% Occupied BW (MHz)	Min. Limit (kHz)	Test Result
2402	0.674	1.064	500	Pass
2440	0.692	1.064	500	Pass
2480	0.690	1.068	500	Pass

### TX CH00

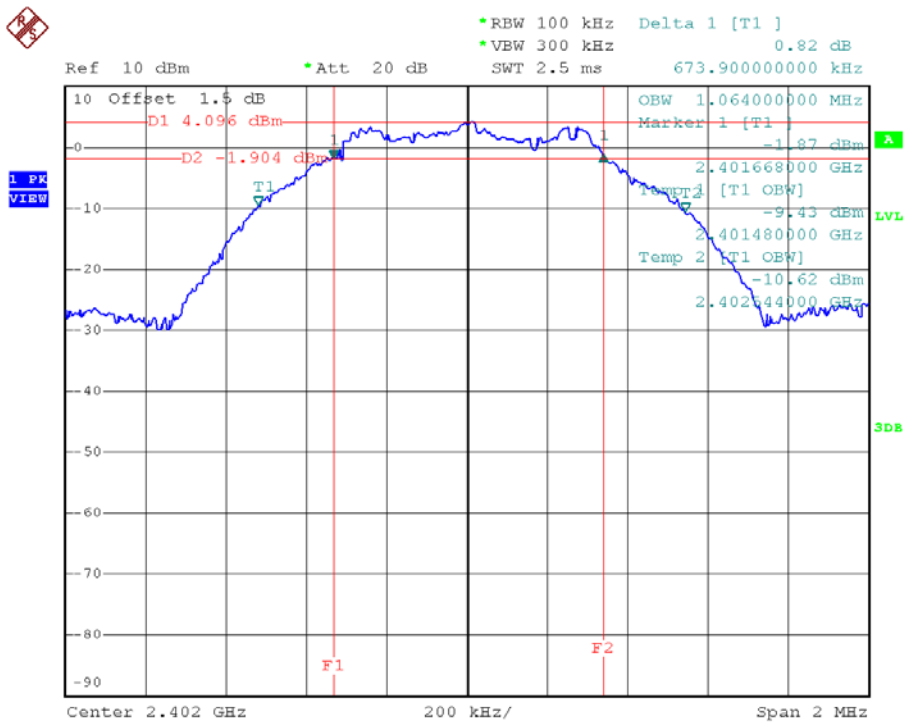

Date: 10.APR.2017 10:02:18

**TX CH19**

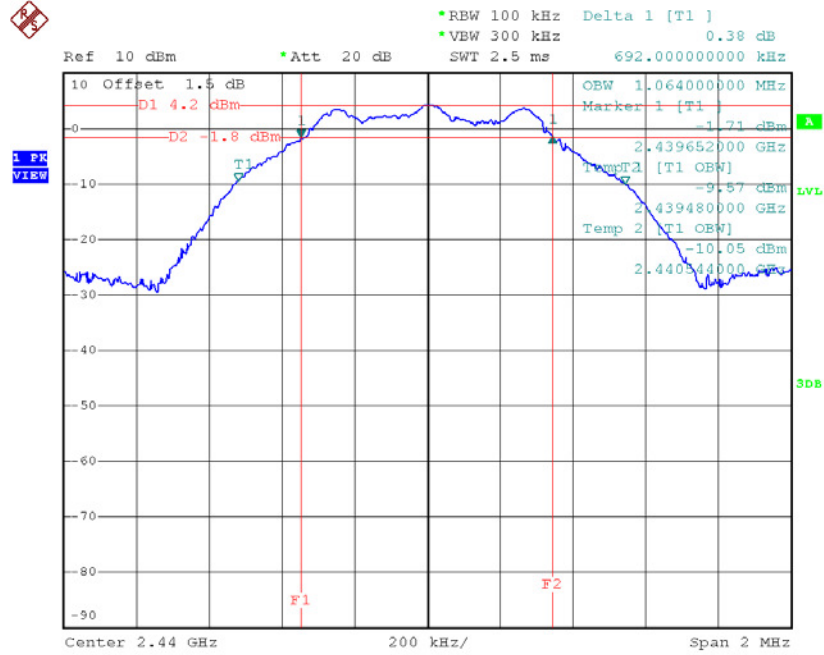

Date: 10.APR.2017 10:03:48

**TX CH39**

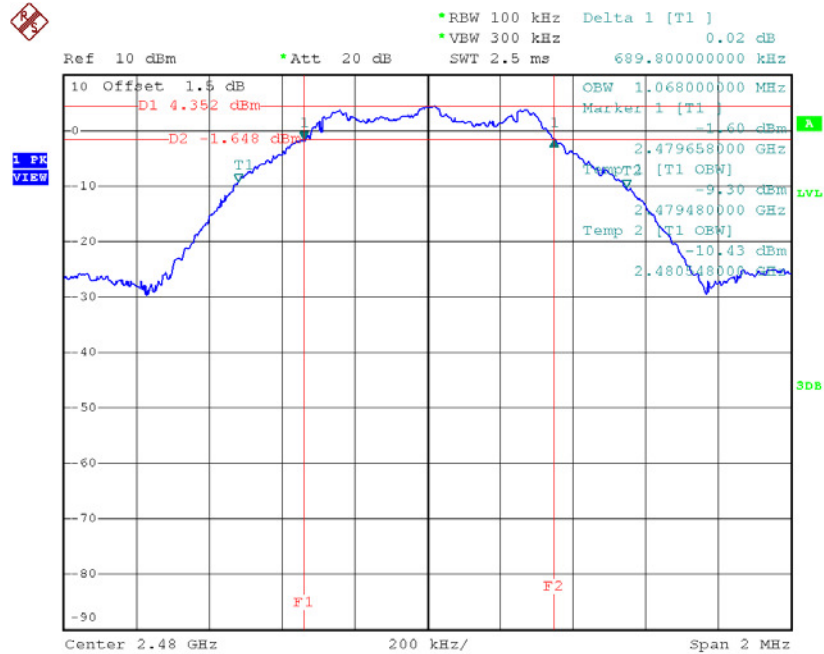

Date: 10.APR.2017 10:05:14

## ATTACHMENT F - MAXIMUM OUTPUT POWER TEST

Test Mode : CH00, CH19 , CH39 - 1Mbps

Frequency (MHz)	Conducted Power (dBm)	Conducted Power (W)	Max. Limit (dBm)	Max. Limit (W)	Test Result
2402	4.70	0.0030	30.00	1.00	Pass
2440	4.74	0.0030	30.00	1.00	Pass
2480	4.84	0.0030	30.00	1.00	Pass

**ATTACHMENT G - ANTENNA CONDUCTED SPURIOUS  
EMISSION**

Test Mode : CH00, CH19 , CH39 - 1Mbps

**CH00 (Lower) - 1Mbps**

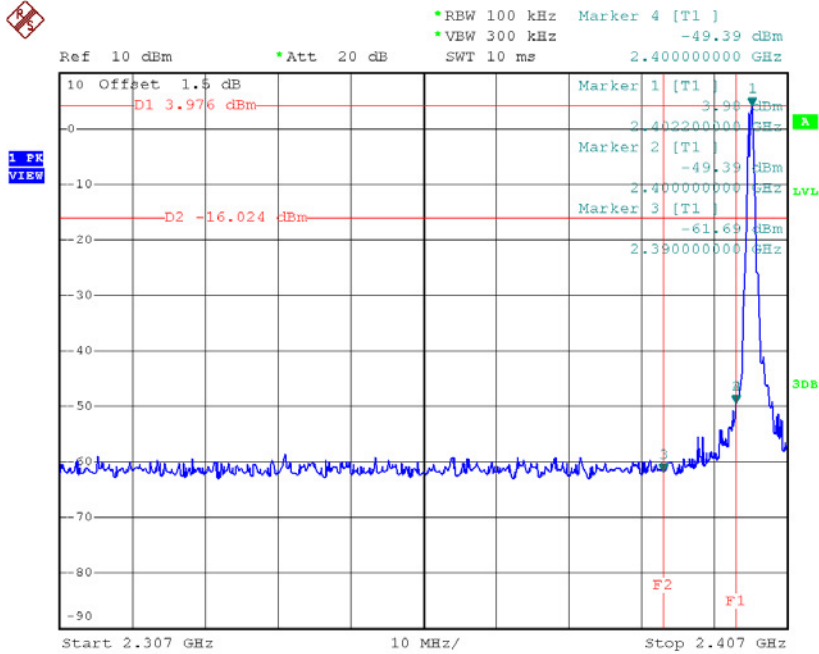

Date: 10.APR.2017 10:02:26

**CH39 (upper) - 1Mbps**

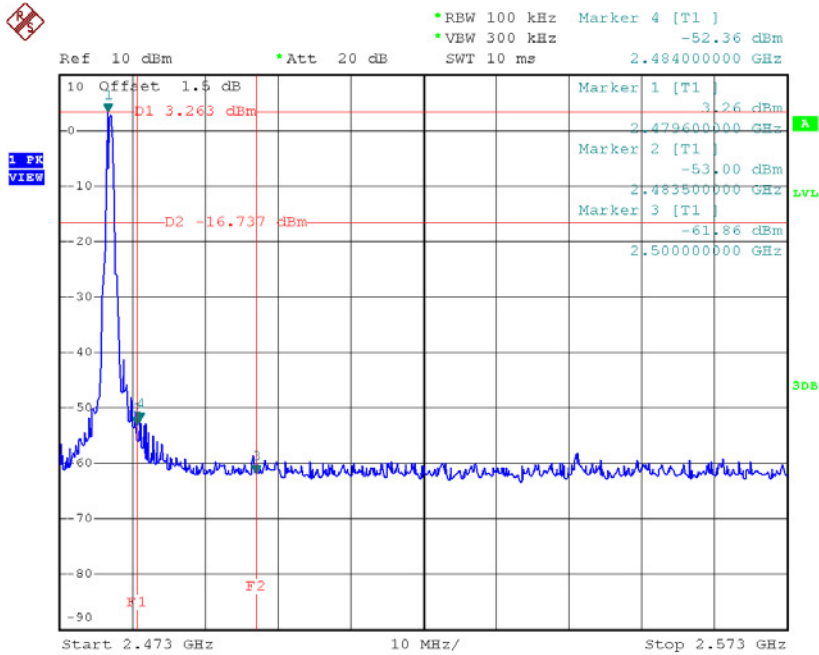

Date: 10.APR.2017 10:05:22

### CH00 (10 Harmonic of the frequency) 1

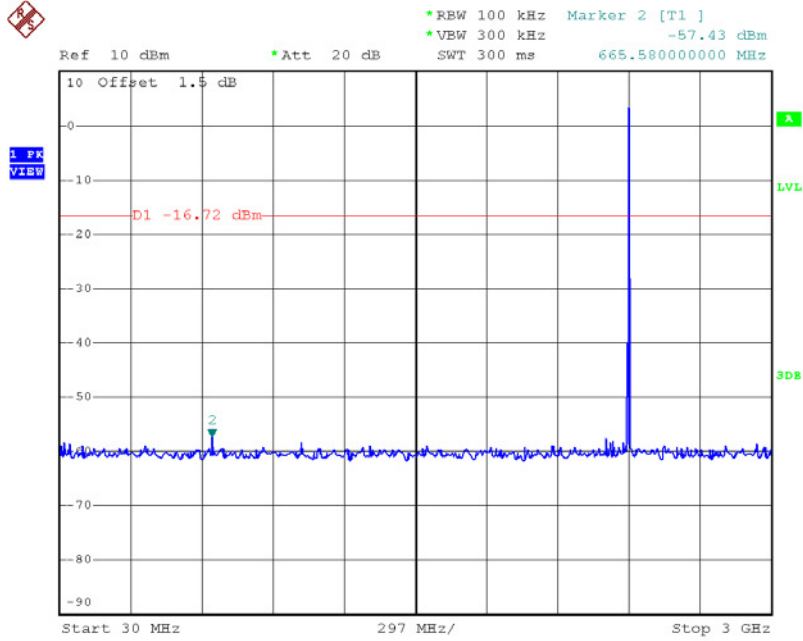

Date: 10.APR.2017 10:02:40

### CH00 (10 Harmonic of the frequency) 2

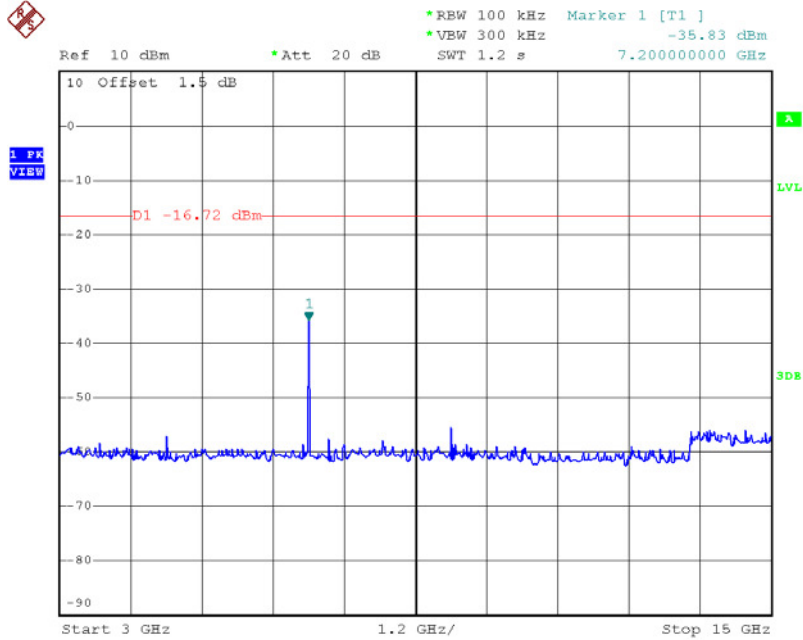

Date: 10.APR.2017 10:02:48

### CH00 (10 Harmonic of the frequency) 3

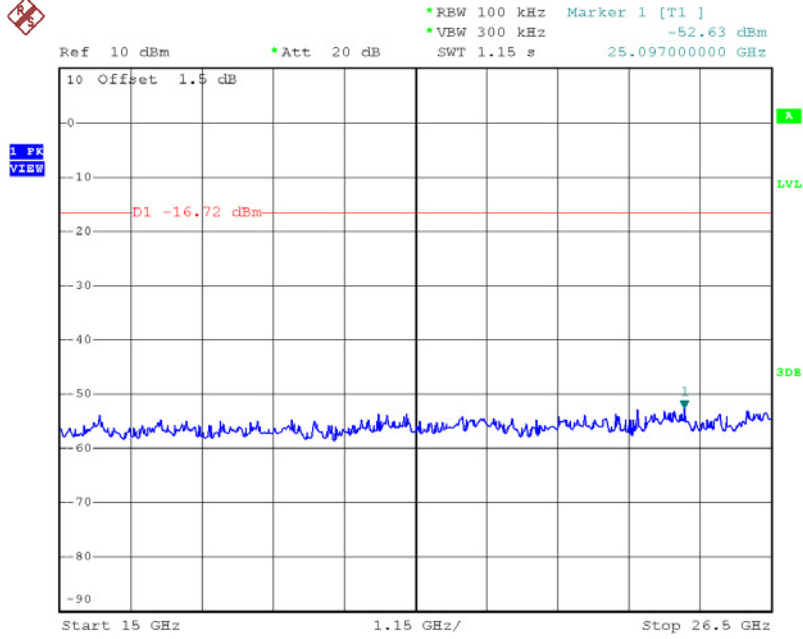

Date: 10.APR.2017 10:02:57

### CH19 (10 Harmonic of the frequency) 1

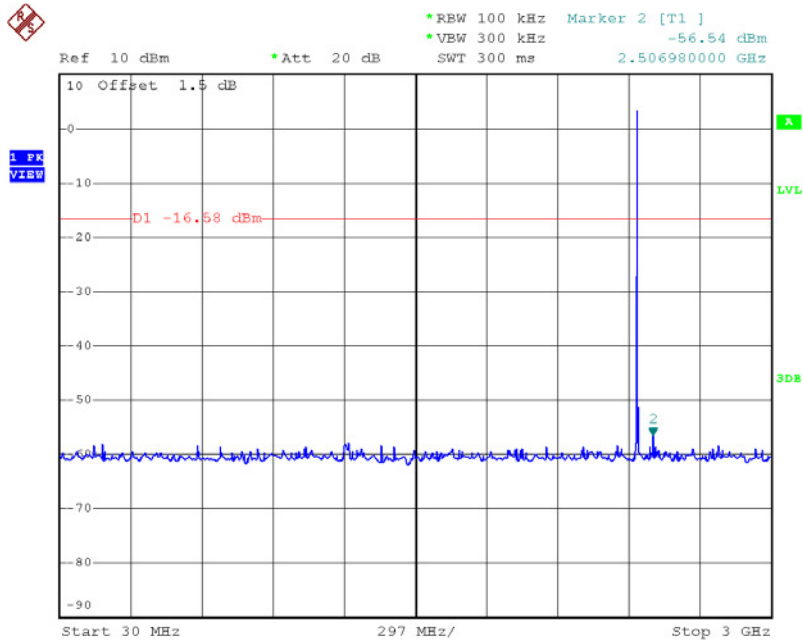

Date: 10.APR.2017 10:04:02

### CH19 (10 Harmonic of the frequency) 2

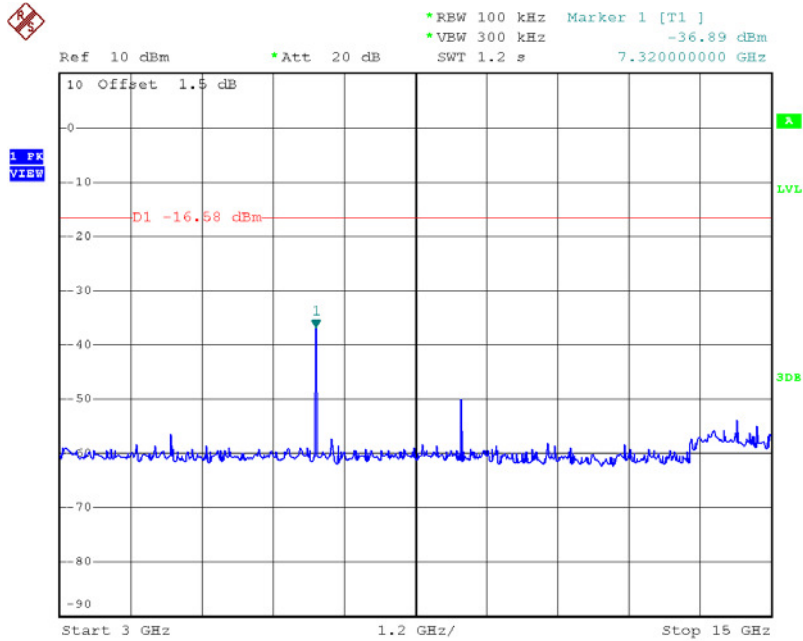

Date: 10.APR.2017 10:04:11

### CH19 (10 Harmonic of the frequency) 3

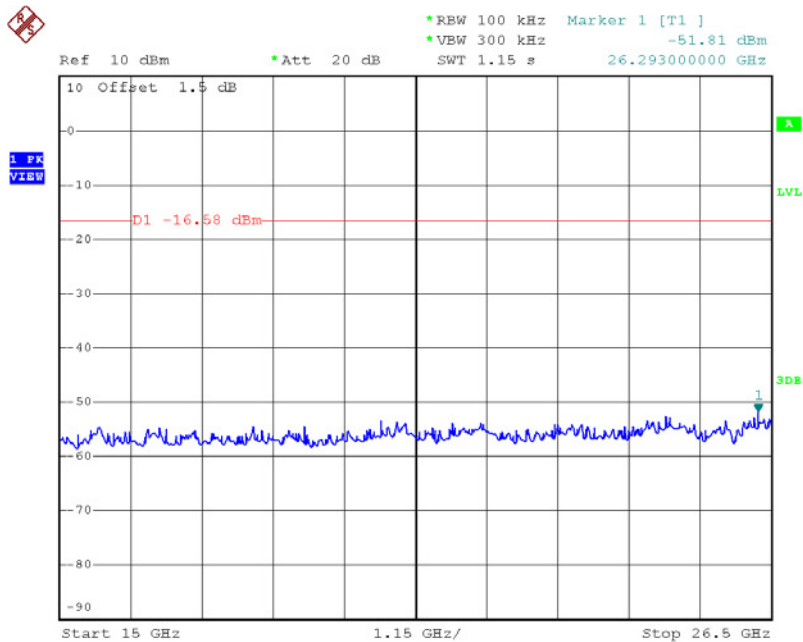

Date: 10.APR.2017 10:04:19



### CH39 (10 Harmonic of the frequency) 1

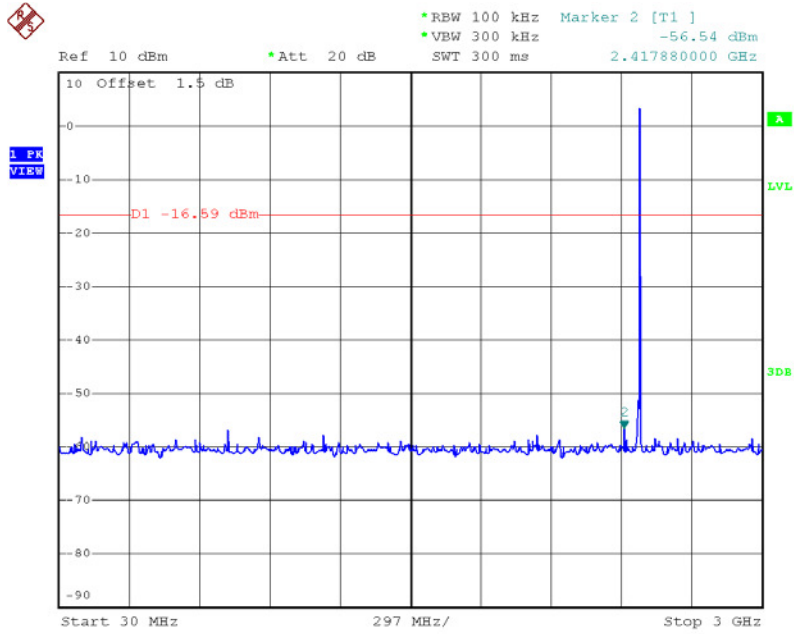

Date: 10.APR.2017 10:05:36

### CH39 (10 Harmonic of the frequency) 2

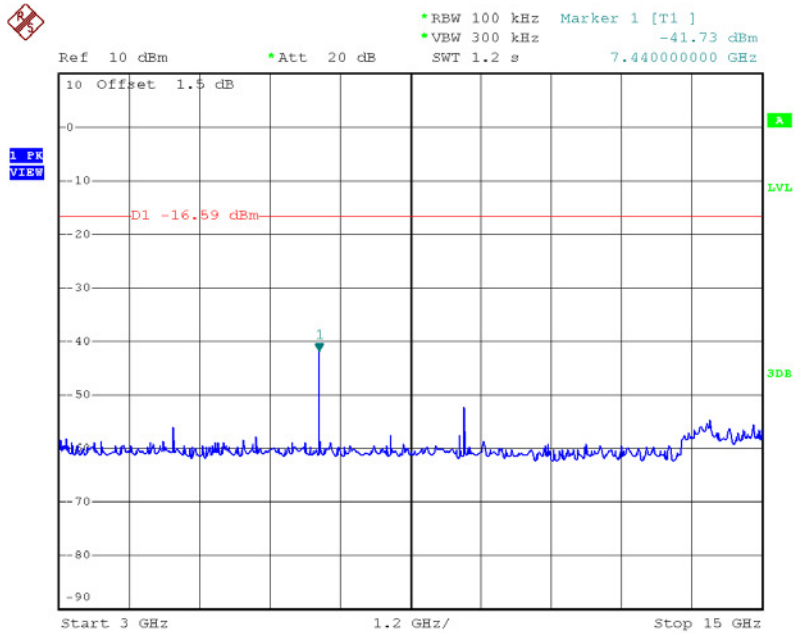

Date: 10.APR.2017 10:05:45

### CH39 (10 Harmonic of the frequency) 3

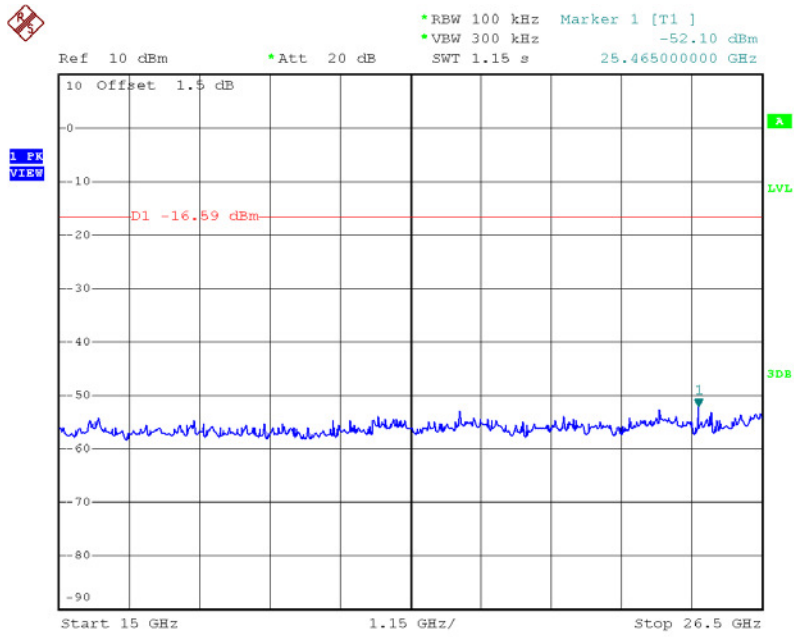

Date: 10.APR.2017 10:05:53

# ATTACHMENT H - POWER SPECTRAL DENSITY TEST

Test Mode: CH00, CH19 , CH39 - 1Mbps

Frequency (MHz)	Power Density (dBm/3kHz)	Power Density (mW/3kHz)	Max. Limit (dBm/3kHz)	Test Result
2402	-11.370	0.073	8.00	Pass
2440	-11.300	0.074	8.00	Pass
2480	-11.380	0.073	8.00	Pass

### TX CH00

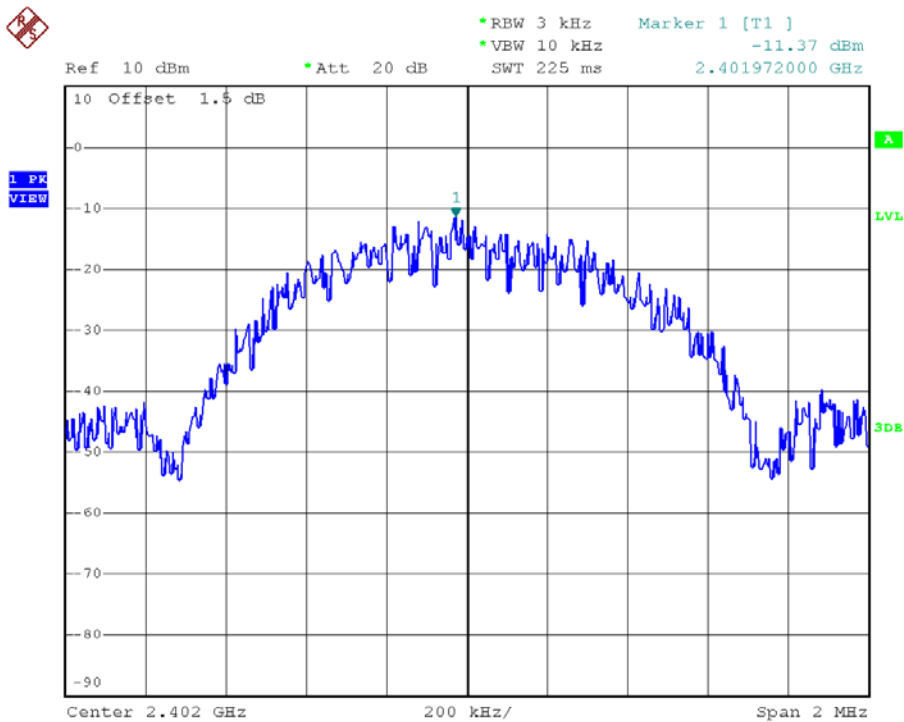

Date: 10.APR.2017 10:03:03

### TX CH19

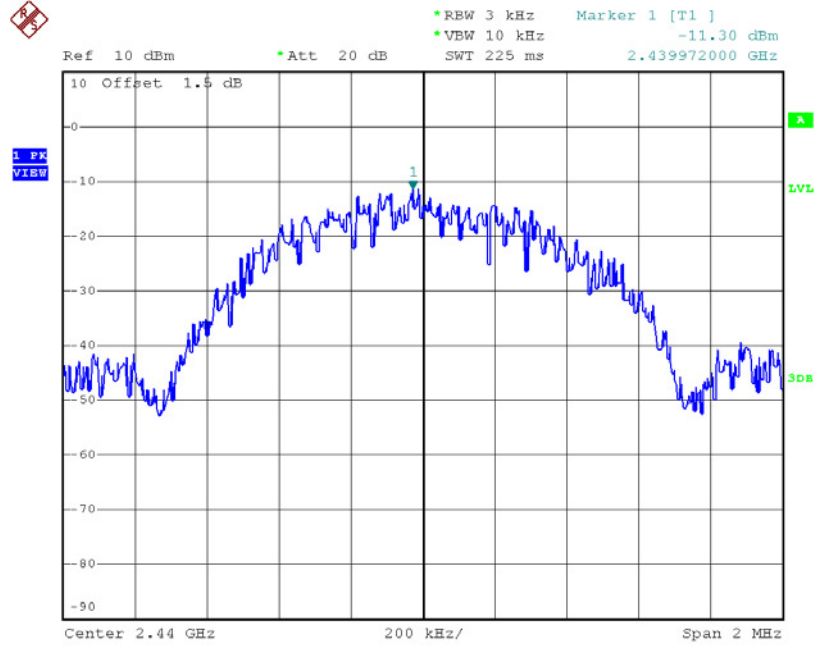

Date: 10.APR.2017 10:04:25

### TX CH39

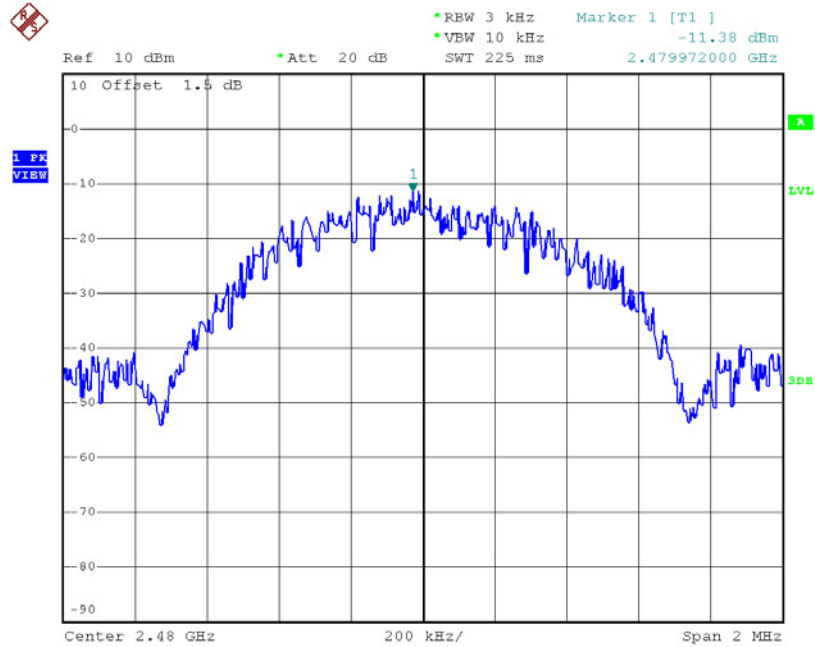

Date: 10.APR.2017 10:05:59