

FCC Radio Test Report

FCC ID: QISMS2372H-517

This report concerns (check one): Original Grant Class II Change

Project No. : 1708C331
Equipment : LTE USB Stick
Model Name : MS2372h-517
Applicant : Huawei Technologies Co., Ltd.
Address : Administration Building, Headquarters of Huawei Technologies Co., Ltd., Bantian, Longgang District, Shenzhen, 518129, P.R.C

Date of Receipt : Aug. 30, 2017
Date of Test : Aug. 30, 2017 ~ Sep. 22, 2017
Issued Date : Sep. 25, 2017
Tested by : BTL Inc.

Technical Engineer :

(Kenji Lin)

Authorized Signatory :

(Andy Chiu)

B T L I N C .

No. 68-1, Ln. 169, Sec.2, Datong Rd., Xizhi Dist., New Taipei City
221, Taiwan

TEL:+886-2-2657-3299 FAX: +886-2- 2657-3331



Declaration

BTL represents to the client that testing is done in accordance with standard procedures as applicable and that test instruments used has been calibrated with standards traceable to international standard(s) and/or national standard(s).

BTL's reports apply only to the specific samples tested under conditions. It is manufacture's responsibility to ensure that additional production units of this model are manufactured with the identical electrical and mechanical components. **BTL** shall have no liability for any declarations, inferences or generalizations drawn by the client or others from **BTL** issued reports.

BTL's report must not be used by the client to claim product certification, approval, or endorsement by NVLAP, NIST, or any agency of the Federal Government.

This report is the confidential property of the client. As a mutual protection to the clients, the public and **BTL-self**, extracts from the test report shall not be reproduced except in full with **BTL's** authorized written approval.

BTL's laboratory quality assurance procedures are in compliance with the **ISO Guide17025** requirements, and accredited by the conformity assessment authorities listed in this test report.

Limitation

For the use of the authority's logo is limited unless the Test Standard(s)/Scope(s)/Item(s) mentioned in this test report is (are) included in the conformity assessment authorities acceptance respective.

Table of Contents	Page
REPORT ISSUED HISTORY	5
1 . CERTIFICATION	6
2 . SUMMARY OF TEST RESULTS	7
2.1 TEST FACILITY	8
2.2 MEASUREMENT UNCERTAINTY	8
3 . GENERAL INFORMATION	9
3.1 GENERAL DESCRIPTION OF EUT	9
3.2 DESCRIPTION OF TEST MODES AND TEST CONDITION	11
3.3 BLOCK DIGRAM SHOWING THECONFIGURATIONOFSYSTEMTESTED FOR RADIATED	15
3.4 DESCRIPTION OF SUPPORT UNITS	15
4 . TEST RESULT	16
4.1 OUTPUT POWER MEASUREMENT	16
4.1.1 LIMIT	16
4.1.2 TEST PROCEDURE	16
4.1.3 TESTSETUP LAYOUT	16
4.1.4 TEST DEVIATION	16
4.1.5 TEST RESULTS	16
4.2 OCCUPIED BANDWIDTH MEASUREMENT	17
4.2.1 TEST PROCEDURE	17
4.2.2 TEST SETUP LAYOUT	17
4.2.3 TEST DEVIATION	17
4.2.4 TEST RESULTS	17
4.3 CONDUCTED EMISSIONS MEASUREMENT	18
4.3.1 LIMIT	18
4.3.2 TEST PROCEDURES	18
4.3.3 TESTSETUP LAYOUT	18
4.3.4 TESTDEVIATION	18
4.3.5 TEST RESULTS	18
4.4 RADIATED EMISSIONS MEASUREMENT	19
4.4.1 LIMIT	19
4.4.2 TEST PROCEDURES	19
4.4.3 TESTSETUP LAYOUT	19
4.4.4 TESTDEVIATION	19
4.4.5 TEST RESULTS	19
4.5 BAND EDGE MEASUREMENT	20
4.5.1 LIMIT	20

Table of Contents	Page
4.5.2 TEST PROCEDURES	20
4.5.3 TESTSETUP LAYOUT	20
4.5.4 TESTDEVIATION	20
4.5.5 TEST RESULTS	20
4.6 PEAK TO AVERAGE RATIO MEASUREMENT	21
4.6.1 LIMIT	21
4.6.2 TEST PROCEDURES	21
4.6.3 TESTSETUP LAYOUT	21
4.6.4 TESTDEVIATION	21
4.6.5 TEST RESULTS	21
4.7 FREQUENCY STABILITY MEASUREMENT	22
4.7.1 LIMIT	22
4.7.2 TEST PROCEDURES	22
4.7.3 TESTSETUP LAYOUT	22
4.7.4 TESTDEVIATION	22
4.7.5 TEST RESULTS	22
5. LIST OF MEASUREMENT EQUIPMENTS	23
ATTACHMENT A - OUTPUT POWER	24
ATTACHMENT B - OCCUPIED BANDWIDTH	37
ATTACHMENT C - CONDUCTED EMISSIONS	61
ATTACHMENT D - RADIATED EMISSION	75
ATTACHMENT E - BAND EDGE	144
ATTACHMENT F - PEAK TO AVERAGE RATIO	156
ATTACHMENT G - FREQUENCY STABILITY	170

REPORT ISSUED HISTORY

Issued No.	Description	Issued Date
BTL-FCCP-3-1708C331	Original Issue.	Sep. 25, 2017

1. CERTIFICATION

Equipment : LTE USB Stick
Brand Name : HUAWEI
Model Name : MS2372h-517
Applicant : Huawei Technologies Co.,Ltd.
Manufacturer: Huawei Technologies Co.,Ltd.
Address : Administration Building, Huawei Base, Bantian, Longgang District ,Shenzhen
518129, P.R.China
Factory : Huawei Technologies Co.,Ltd.
Address : Administration Building, Huawei Base, Bantian, Longgang District ,Shenzhen
518129, P.R.China
Date of Test : Aug. 30, 2017 ~ Sep. 22, 2017
Test Sample : Engineering Sample
Standard(s) : 47 CFR FCC Part 27
47 CFR FCC Part 2 & ANSI/TIA-603-D-2010

The above equipment has been tested and found compliance with the requirement of the relative standards by BTL Inc.

The test data, data evaluation, and equipment configuration contained in our test report (Ref No. BTL-FCCP-3-1708C331) were obtained utilizing the test procedures, test instruments, test sites that has been accredited by the Authority of TAF according to the ISO-17025 quality assessment standard and technical standard(s).

Test results included in this report is only for the WCDMA Band 4, LTE Band 4, 7, 12 parts.

2. SUMMARY OF TEST RESULTS

Test procedures according to the technical standard(s):

FCC Part 27 & Part 2			
Standard(s) Section	Test Item	Judgment	Tested By
2.1046 27.50(d)(4)	Radiated power	PASS	Paul Li
2.1046 27.50(d)(4)	Conducted Output Power	PASS	Paul Li
2.1049 27.53(h)	Occupied Bandwidth	PASS	Paul Li
2.1051 27.53(h)	Conducted Spurious Emissions	PASS	Paul Li
2.1053 27.53(h)	Radiated Spurious Emissions	PASS	Paul Li
27.53(h)	Band Edge Measurements	PASS	Paul Li
27.50	Peak To Average Ratio	PASS	Paul Li
2.1055 27.54	Frequency Stability	PASS	Paul Li

NOTE:

(1) "N/A" denotes test is not applicable to this device.

2.1 TEST FACILITY

The test facilities used to collect the test data in this report:

Radiated emissions Test (Below 1 GHz):

CB15: (FCC RN:674415; FCC DN:TW0659)

No. 68-1, Ln. 169, Sec.2, Datong Rd., Xizhi Dist., New Taipei City 221, Taiwan

Radiated emissions Test (Above 1 GHz):

CB15: (FCC RN:674415; FCC DN:TW0659)

No. 68-1, Ln. 169, Sec.2, Datong Rd., Xizhi Dist., New Taipei City 221, Taiwan

Conducted Test:

TR01: (FCC RN:674415; FCC DN:TW0659)

No. 68-1, Ln. 169, Sec.2, Datong Rd., Xizhi Dist., New Taipei City 221, Taiwan

2.2 MEASUREMENT UNCERTAINTY

Where relevant, the following measurement uncertainty levels have been estimated for tests performed on the EUT as specified in CISPR 16-4-2. The BTL measurement uncertainty is less than the CISPR 16-4-2 U_{CISPR} requirement.

The reported uncertainty of measurement $y \pm U$, where expanded uncertainty U is based on a standard uncertainty multiplied by a coverage factor of $k=2$, providing a level of confidence of approximately **95%**.

A. Radiated Measurement :

Test Site	Method	Measurement Frequency Range	Ant. H / V	U,(dB)
DG-CB03 (3m)	CISPR	9KHz ~ 30MHz	V	3.79
		9KHz ~ 30MHz	H	3.57
		30MHz ~ 200MHz	V	3.82
		30MHz ~ 200MHz	H	3.78
		200MHz ~ 1,000MHz	V	4.10
		200MHz ~ 1,000MHz	H	4.06

Test Site	Method	Measurement Frequency Range	Ant. H / V	U,(dB)
DG-CB03 (3m)	CISPR	1GHz ~ 18GHz	V	3.12
		1GHz ~ 18GHz	H	3.68

Test Site	Method	Measurement Frequency Range	Ant. H / V	U,(dB)
DG-CB03 (1m)	CISPR	18GHz ~ 40GHz	V	4.15
		18GHz ~ 40GHz	H	4.14

Note: Unless specifically mentioned, the uncertainty of measurement has not been taken into account to declare the compliance or non-compliance to the specification.

3. GENERAL INFORMATION

3.1 GENERAL DESCRIPTION OF EUT

Equipment	LTE USB Stick	
Brand Name	HUAWEI	
Model Name	MS2372h-517	
Model Difference	N/A	
Modulation Type	WCDMA	Uplink: BPSK Downlink: QPSK
	WCDMA(HSDPA/HSUPA/HSPA+)	16QAM
	LTE	QPSK, 16QAM
Operation Frequency	WCDMA Band 4	1712.4 ~1752.6MHz
	LTE 4 (Channel Bandwidth: 5MHz)	1712.5 ~ 1752.5 MHz
	LTE 4 (Channel Bandwidth: 10MHz)	1715.0 ~ 1750.0 MHz
	LTE 4 (Channel Bandwidth: 15MHz)	1717.5 ~ 1747.5 MHz
	LTE 4 (Channel Bandwidth: 20MHz)	1720.0 ~ 1745.0 MHz
	LTE 7 (Channel Bandwidth: 5MHz)	2502.5 ~ 2567.5 MHz
	LTE 7 (Channel Bandwidth: 10MHz)	2505.0 ~ 2565.0 MHz
	LTE 7 (Channel Bandwidth: 15MHz)	2507.5 ~ 2562.5 MHz
	LTE 7 (Channel Bandwidth: 20MHz)	2510.0 ~ 2560.0 MHz
	LTE 12 (Channel Bandwidth: 5MHz)	701.5 ~ 713.5MHz
LTE 12 (Channel Bandwidth: 10MHz)	704.0 ~ 711.0MHz	

Max. EIRP Power	WCDMA Band 4(WCDMA)	BPSK	23.64	dBm
	WCDMA Band 4(HSDPA)	16QAM	23.01	dBm
	WCDMA Band 4(HSUPA)	16QAM	22.97	dBm
	LTE 4 (Channel Bandwidth: 5MHz)	QPSK	24.46	dBm
		16QAM	23.35	dBm
	LTE 4 (Channel Bandwidth: 10MHz)	QPSK	24.42	dBm
		16QAM	23.25	dBm
	LTE 4 (Channel Bandwidth: 15MHz)	QPSK	24.53	dBm
		16QAM	23.42	dBm
	LTE 4 (Channel Bandwidth: 20MHz)	QPSK	23.91	dBm
		16QAM	23.16	dBm
	LTE 7 (Channel Bandwidth: 5MHz)	QPSK	23.83	dBm
		16QAM	23.52	dBm
	LTE 7 (Channel Bandwidth: 10MHz)	QPSK	24.61	dBm
16QAM		23.59	dBm	
LTE 7 (Channel Bandwidth: 15MHz)	QPSK	24.59	dBm	
	16QAM	23.64	dBm	
LTE 7 (Channel Bandwidth: 20MHz)	QPSK	24.50	dBm	
	16QAM	23.87	dBm	
Max. ERP Power	LTE 12 (Channel Bandwidth: 5MHz)	QPSK	22.68	dBm
		16QAM	21.89	dBm
	LTE 12 (Channel Bandwidth: 10MHz)	QPSK	22.52	dBm
		16QAM	21.76	dBm

Antenna Type	Fixed Internal Antenna		
Antenna Gain	WCDMA Band 4	3.2 dBi	
	LTE Band 4	3.3 dBi	
	LTE Band 7	3.6 dBi	
	LTE Band 12	1.0 dBi	
Hardware Version	21.328.01.03.00		
Software Version	CL1MS2372HM VER.B		
IMEI No.1	Radiated	866667030005580	
	Conducted	866667030005572	
Power Source	Supplied from AC/DC adapter.		
Power Rating	100-240V~ 5V/1.0A		

Note:

- For a more detailed features description, please refer to the manufacturer's specifications or the user's manual.

3.2 DESCRIPTION OF TEST MODES AND TEST CONDITION

Following channel(s) was (were) selected for the final test as listed below:

WCDMA BAND 4			
Test Item	Available Channel	Tested Channel	Mode
EIRP	1312 to 1513	1312, 1413, 1513	WCDMA,HSDPA, HSUPA
Frequency Stability	1312 to 1513	1413	WCDMA
Occupied Bandwidth	1312 to 1513	1312, 1413, 1513	WCDMA,HSDPA, HSUPA
Band Edge	1312 to 1513	1312, 1513	WCDMA,HSDPA, HSUPA
Peak to Average Ratio	1312 to 1513	1312, 1413, 1513	WCDMA,HSDPA, HSUPA
Condcudeted Emission	1312 to 1513	1413	WCDMA,HSDPA, HSUPA
Radiated Emission	1312 to 1513	1312	WCDMA,HSDPA, HSUPA

LTE BAND 4					
Test Item	Available Channel	Tested Channel	Channel Bandwidth	Modulation	Mode
EIRP	19975 to 20375	19975, 20175, 20375	5MHz	QPSK, 16QAM	1 RB / 0 RB Offset
	20000 to 20350	20000, 20175, 20350	10MHz	QPSK, 16QAM	1 RB / 0 RB Offset
	20025 to 20325	20025, 20175, 20325	15MHz	QPSK, 16QAM	1 RB / 0 RB Offset
	20050 to 20300	20050, 20175, 20300	20MHz	QPSK, 16QAM	1 RB / 0 RB Offset
Occupied Bandwidth	19975 to 20375	19975, 20175, 20375	5MHz	QPSK, 16QAM	25 RB / 0 RB Offset
	20000 to 20350	20000, 20175, 20350	10MHz	QPSK, 16QAM	50 RB / 0 RB Offset
	20025 to 20325	20025, 20175, 20325	15MHz	QPSK, 16QAM	75 RB / 0 RB Offset
	20050 to 20300	20050, 20175, 20300	20MHz	QPSK, 16QAM	100 RB / 0 RB Offset
Conducted Emission	19975 to 20375	20175	5MHz	QPSK	1 RB / 0 RB Offset
	20000 to 20350	20175	10MHz	QPSK	1 RB / 0 RB Offset
	20025 to 20325	20175	15MHz	QPSK	1 RB / 0 RB Offset
	20050 to 20300	20175	20MHz	QPSK	1 RB / 0 RB Offset
Radiated Emission	19975 to 20375	20375	5MHz	QPSK	1 RB / 0 RB Offset
	20050 to 20300	20300	20MHz	QPSK	1 RB / 0 RB Offset

LTE BAND 4					
Test Item	Available Channel	Tested Channel	Channel Bandwidth	Modulation	Mode
Band Edge	19975 to 20375	19975	5MHz	QPSK	1 RB / 0 RB Offset
					25 RB / 0 RB Offset
		20375	5MHz	QPSK	1 RB / 24 RB Offset
					25 RB / 0 RB Offset
	20000 to 20350	20000	10MHz	QPSK	1 RB / 0 RB Offset
					50 RB / 0 RB Offset
		20350	10MHz	QPSK	1 RB / 49 RB Offset
					50 RB / 0 RB Offset
	20025 to 20325	20025	15MHz	QPSK	1 RB / 0 RB Offset
					75 RB / 0 RB Offset
		20325	15MHz	QPSK	1 RB / 74 RB Offset
					75 RB / 0 RB Offset
20050 to 20300	20050	20MHz	QPSK	1 RB / 0 RB Offset	
				100 RB / 0 RB Offset	
	20300	20MHz	QPSK	1 RB / 99 RB Offset	
				100 RB / 0 RB Offset	
Peak To Average Ratio	19975 to 20375	19975, 20175, 20375	5MHz	QPSK, 16QAM	1 RB / 0 RB Offset
	20000 to 20350	20000, 20175, 20350	10MHz	QPSK, 16QAM	1 RB / 0 RB Offset
	20025 to 20325	20025, 20175, 20325	15MHz	QPSK, 16QAM	1 RB / 0 RB Offset
	20050 to 20300	20050, 20175, 20300	20MHz	QPSK, 16QAM	1 RB / 0 RB Offset
Frequency Stability	19975 to 20375	20175	5MHz	QPSK	1 RB / 0 RB Offset
	20000 to 20350	20175	10MHz	QPSK	1 RB / 0 RB Offset
	20025 to 20325	20175	15MHz	QPSK	1 RB / 0 RB Offset
	20050 to 20300	20175	20MHz	QPSK	1 RB / 0 RB Offset

LTE BAND 7						
Test Item	Available Channel	Tested Channel	Channel Bandwidth	Modulation	Mode	
EIRP	20775 to 21425	20775, 21100, 21425	5MHz	QPSK, 16QAM	1 RB / 0 RB Offset	
	20800 to 21400	20800, 21100, 21400	10MHz	QPSK, 16QAM	1 RB / 0 RB Offset	
	20825 to 21375	20825, 21100, 21375	15MHz	QPSK, 16QAM	1 RB / 0 RB Offset	
	20850 to 21350	20850, 21100, 21350	20MHz	QPSK, 16QAM	1 RB / 0 RB Offset	
Occupied Bandwidth	20775 to 21425	20775, 21100, 21425	5MHz	QPSK, 16QAM	25 RB / 0 RB Offset	
	20800 to 21400	20800, 21100, 21400	10MHz	QPSK, 16QAM	50 RB / 0 RB Offset	
	20825 to 21375	20825, 21100, 21375	15MHz	QPSK, 16QAM	75 RB / 0 RB Offset	
	20850 to 21350	20850, 21100, 21350	20MHz	QPSK, 16QAM	100 RB / 0 RB Offset	
Conducted Emission	20775 to 21425	21100	5MHz	QPSK	1 RB / 0 RB Offset	
	20800 to 21400	21100	10MHz	QPSK	1 RB / 0 RB Offset	
	20825 to 21375	21100	15MHz	QPSK	1 RB / 0 RB Offset	
	20850 to 21350	21100	20MHz	QPSK	1 RB / 0 RB Offset	
Radiated Emission	20775 to 21425	21425	5MHz	QPSK	1 RB / 0 RB Offset	
	20850 to 21350	21350	20MHz	QPSK	1 RB / 0 RB Offset	
Band Edge	20775 to 21425	20775	5MHz	QPSK	1 RB / 0 RB Offset 25 RB / 0 RB Offset	
		21425	5MHz	QPSK	1 RB / 24 RB Offset 25 RB / 0 RB Offset	
	20800 to 21400	20800	10MHz	QPSK	1 RB / 0 RB Offset 50 RB / 0 RB Offset	
		21400	10MHz	QPSK	1 RB / 49 RB Offset 50 RB / 0 RB Offset	
	20825 to 21375	20825	15MHz	QPSK	1 RB / 0 RB Offset 75 RB / 0 RB Offset	
		21375	15MHz	QPSK	1 RB / 74 RB Offset 75 RB / 0 RB Offset	
	20850 to 21350	20850	20MHz	QPSK	1 RB / 0 RB Offset 100 RB / 0 RB Offset	
		21350	20MHz	QPSK	1 RB / 99 RB Offset 100 RB / 0 RB Offset	
	Peak To Average Ratio	20775 to 21425	20775, 21100, 21425	5MHz	QPSK, 16QAM	1 RB / 0 RB Offset
		20800 to 21400	20800, 21100, 21400	10MHz	QPSK, 16QAM	1 RB / 0 RB Offset
		20825 to 21375	20825, 21100, 21375	15MHz	QPSK, 16QAM	1 RB / 0 RB Offset
		20850 to 21350	20850, 21100, 21350	20MHz	QPSK, 16QAM	1 RB / 0 RB Offset
Frequency Stability	20775 to 21425	21100	5MHz	QPSK	1 RB / 0 RB Offset	
	20800 to 21400	21100	10MHz	QPSK	1 RB / 0 RB Offset	
	20825 to 21375	21100	15MHz	QPSK	1 RB / 0 RB Offset	
	20850 to 21350	21100	20MHz	QPSK	1 RB / 0 RB Offset	

LTE BAND 12						
Test Item	Available Channel	Tested Channel	Channel	Modulation	Mode	
ERP	23035 to 23155	23035, 23095, 23155	5MHz	QPSK, 16QAM	1 RB / 12 RB Offset	
	23060 to 23130	23060, 23095, 23130	10MHz	QPSK, 16QAM	1 RB / 24 RB Offset	
Occupied Bandwidth	23035 to 23155	23035, 23095, 23155	5MHz	QPSK, 16QAM	25 RB / 0 RB Offset	
	23060 to 23130	23060, 23095, 23130	10MHz	QPSK, 16QAM	50 RB / 0 RB Offset	
Conducted Emission	23035 to 23155	23095	5MHz	QPSK	1 RB / 0 RB Offset	
	23060 to 23130	23095	10MHz	QPSK	1 RB / 0 RB Offset	
Radiated Emission	23035 to 23155	23095	5MHz	QPSK	1 RB / 0 RB Offset	
	23060 to 23130	23060	10MHz	QPSK	1 RB / 0 RB Offset	
Band Edge	23035 to 23155	23035	5MHz	QPSK	1 RB / 0 RB Offset 25 RB / 0 RB Offset	
		23155	5MHz	QPSK	1 RB / 24 RB Offset 25 RB / 0 RB Offset	
	23060 to 23130	23060	10MHz	QPSK	1 RB / 0 RB Offset 50 RB / 0 RB Offset	
		23130	10MHz	QPSK	1 RB / 49 RB Offset 50 RB / 0 RB Offset	
	Peak to Average Ratio	23035 to 23155	23035, 23095, 23155	5MHz	QPSK, 16QAM	1 RB / 0 RB Offset
		23060 to 23130	23060, 23095, 23130	10MHz	QPSK, 16QAM	1 RB / 0 RB Offset
Frequency Stability	23035 to 23155	23095	5MHz	QPSK	1 RB / 12 RB Offset	
	23060 to 23130	23095	10MHz	QPSK	1 RB / 24 RB Offset	

EUT TEST CONDITIONS:

Test Item	Environmental Conditions	Test Voltage
EIRP	24°C, 63%RH	DC 4.0V
Conducted Output Power	25°C, 65%RH	DC 4.0V
Occupied Bandwidth	25°C, 65%RH	DC 4.0V
Conducted Emission	25°C, 65%RH	DC 4.0V
Radiated Emission	25°C, 60%RH	AC 120V/60Hz
Band Edge	25°C, 65%RH	DC 4.0V
Peak to Average Ratio	25°C, 65%RH	DC 4.0V
Frequency Stability	25°C, 65%RH	DC 4.0V

3.3 BLOCK DIGRAM SHOWING THE CONFIGURATION OF SYSTEM TESTED FOR RADIATED

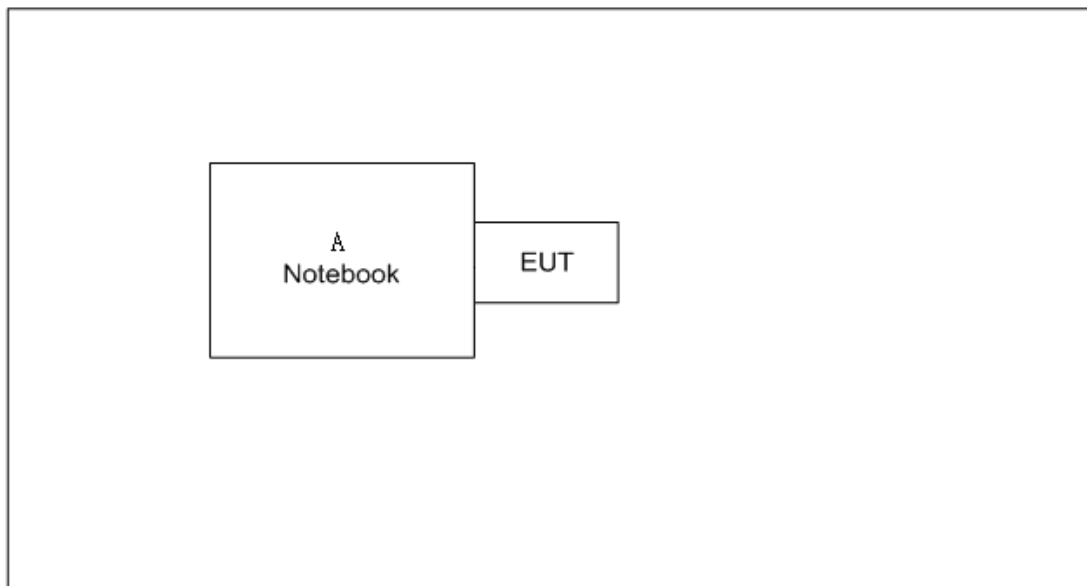

3.4 DESCRIPTION OF SUPPORT UNITS

The EUT has been tested as an independent unit together with other necessary accessories or support units. The following support units or accessories were used to form a representative test configuration during the tests.

Item	Equipment	Mfr/Brand	Model/Type No.	FCC ID	Series No.
A	Notebook	Dell 745	DCSM	DOC	G7K832X

Item	Shielded Type	Ferrite Core	Length	Note
-	-	-	-	-

4. TEST RESULT

4.1 OUTPUT POWER MEASUREMENT

4.1.1 LIMIT

Mobile / Portable station are limited to 1 watts e.i.r.p. (WCDMA Band 4 & LTE 4)

Mobile / Portable station are limited to 2 watts e.i.r.p. (LTE 7)

4.1.2 TEST PROCEDURE

EIRP/ERP:

EIRP= Conducted Power +Antenan gain

ERP power=EIPR power-2.15dBi.

Conducted Power:

The EUT was set up for the maximum power with GSM, GPRS, EDGE, WCDMA, CDMA, and LTE link data modulation and link up with simulator. Set the EUT to transmit under low, middle and high channel and record the power level shown on simulator.

4.1.3 TESTSETUP LAYOUT

Conducted Power Measurement

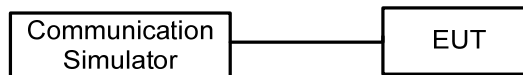

4.1.4 TEST DEVIATION

No deviation

4.1.5 TEST RESULTS

Please refer to the Attachment A.

4.2 OCCUPIED BANDWIDTH MEASUREMENT

4.2.1 TEST PROCEDURE

The EUT makes a call to the communication simulator. All measurements were done at low, middle and high operational frequency range. The communication simulator station system controlled a EUT to export maximum output power under transmission mode and specific channel frequency. Use OBW measurement function of Spectrum analyzer to measure 99 % occupied bandwidth and 26dB bandwidth.

4.2.2 TEST SETUP LAYOUT

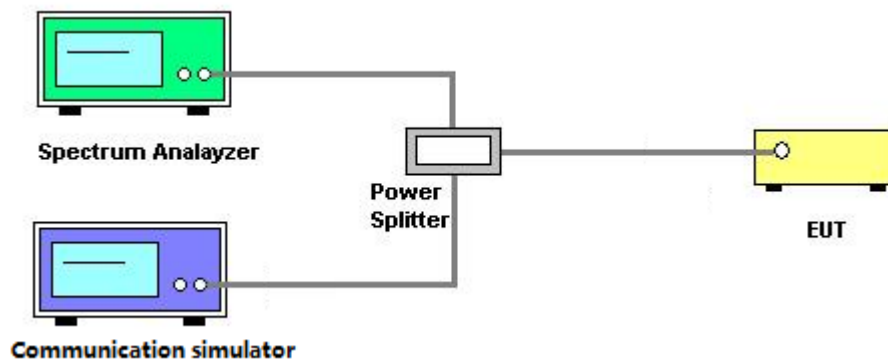

4.2.3 TEST DEVIATION

No deviation

4.2.4 TEST RESULTS

Please refer to the Attachment B.

4.3 CONDUCTED EMISSIONS MEASUREMENT

4.3.1 LIMIT

The power of any emission outside of the authorized operating frequency ranges must be attenuated below the transmitting power (P) by a factor of at least $43 + 10 \log(P)$ dB. The emission limit equal to -13dBm.

4.3.2 TEST PROCEDURES

1. The testing follows FCC KDB 971168 v02r02 Section 6.0.
2. The EUT was connected to spectrum analyzer and system simulator via a power divider.
3. The band edges of low and high channels for the highest RF powers were measured. Set $RBW \geq 1\%$ EBW in the 1MHz band immediately outside and adjacent to the band edge.
4. Set spectrum analyzer with RMS detector.
5. The RF fundamental frequency should be excluded against the limit line in the operating frequency band.
6. The limit line is derived from $43+10\log(P)$ dB below the transmitter power P(Watts)
 $=P(W)-[43+10\log(P)](dB)$
 $=[30+10\log(P)](dBm)-[43+10\log(P)](dB)$
 $=-13dBm$

4.3.3 TESTSETUP LAYOUT

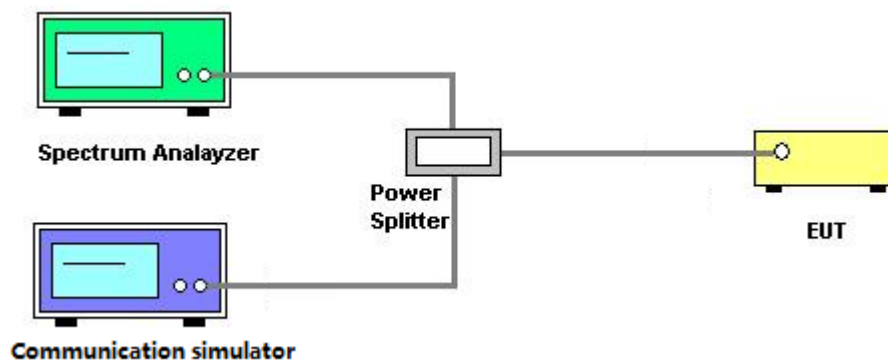

4.3.4 TESTDEVIATION

No deviation

4.3.5 TEST RESULTS

Please refer to the Attachment C.

4.4 RADIATED EMISSIONS MEASUREMENT

4.4.1 LIMIT

The power of any emission outside of the authorized operating frequency ranges must be attenuated below the transmitting power (P) by a factor of at least $43 + 10 \log(P)$ dB. The emission limit equal to -13dBm.

4.4.2 TEST PROCEDURES

1. Substitution method is used for E.I.R.P measurement. In the semi-anechoic chamber, EUT placed on the 0.8m height of Turn Table, rotated the table around 360 degrees to search the maximum radiation power and receiver antenna shall be rotated vertical and horizontal polarization and moved height from 1m to 4m to find the maximum polar radiated power. The "Read Value" is the spectrum reading the maximum power value.
2. The substitution horn antenna is substituted for EUT at the same position and signals generator export the CW signal to the substitution antenna via a TX cable. Rotated the Turn Table and moved receiving antenna to find the maximum radiation power. Adjust output power level of S.G to get a Value of spectrum reading equal to "Read Value " of step a. Record the power level of S.G
3. EIRP = Output power level of S.G – TX cable loss + Antenna gain of substitution horn.
4. E.R.P power can be calculated form E.I.R.P power by subtracting the gain of dipole, E.R.P power = E.I.P.R power - 2.15dBi.
5. The resolution bandwidth and video bandwidth of test receiver/spectrum analyzer is 1MHz/3MHz.

4.4.3 TESTSETUP LAYOUT

This test setup layout is the same as that shown in **section 4.1.3**.

4.4.4 TESTDEVIATION

No deviation

4.4.5 TEST RESULTS

Please refer to the Attachment D.

4.5 BAND EDGE MEASUREMENT

4.5.1 LIMIT

For operations in the 699-716 , 704-716 and 777-787MHz band, the power of any emission outside a licensee's frequency band(s) of operation shall be attenuated below the transmitter power (P) within the licensed band(s) of operation, measured in watts, by at least $43 + 10 \log (P)$ dB. Compliance with this provision is based on the use of measurement instrumentation employing a resolution bandwidth of 100 kilohertz or greater.

However, in the 100 kilohertz bands immediately outside and adjacent to a licensee's frequency block, a resolution bandwidth of at least 30 kHz may be employed.

For operations in the 1710–1755 MHz bands, the power of any emission outside a licensee's frequency block shall be attenuated below the transmitter power (P) by at least $43 + 10 \log_{10}(P)$ dB.

4.5.2 TEST PROCEDURES

1. All measurements were done at low and high operational frequency range.
2. The center frequency of spectrum is the band edge frequency and span is 5MHz. RB of the spectrum is 100kHz and VB of the spectrum is 300kHz (WCDMA).
3. The center frequency of spectrum is the band edge frequency and span is 1MHz. RB of the spectrum is 13kHz and VB of the spectrum is 51kHz (LTE Bandwidth 1.4MHz).
4. The center frequency of spectrum is the band edge frequency and span is 1MHz. RB of the spectrum is 30kHz and VB of the spectrum is 100kHz (LTE Bandwidth 3MHz).
5. The center frequency of spectrum is the band edge frequency and span is 1MHz. RB of the spectrum is 100kHz and VB of the spectrum is 300kHz (LTE Bandwidth 5MHz/10MHz).
6. Record the max trace plot into the test report.

4.5.3 TESTSETUP LAYOUT

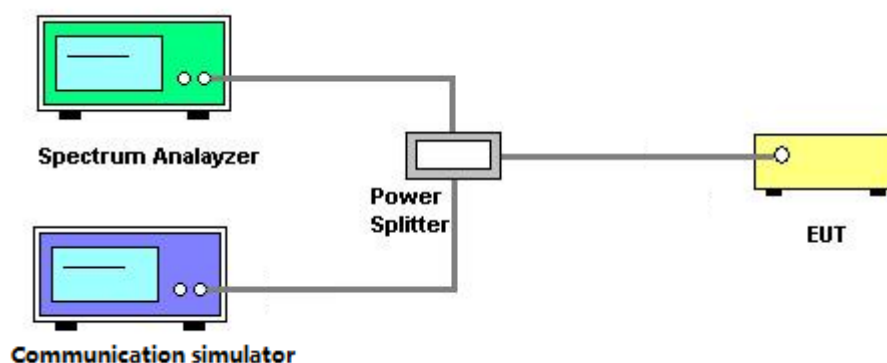

4.5.4 TESTDEVIATION

No deviation

4.5.5 TEST RESULTS

Please refer to the Attachment E.

4.6 PEAK TO AVERAGE RATIO MEASUREMENT

4.6.1 LIMIT

In measuring transmissions in this band using an average power technique, the peak to-average ratio (PAR) of the transmission may not exceed 13 dB.

4.6.2 TEST PROCEDURES

1. Set resolution/measurement bandwidth \geq signal's occupied bandwidth;
2. Set the number of counts to a value that stabilizes the measured CCDF curve;
3. Record the maximum PAPR level associated with a probability of 0.1%.

4.6.3 TESTSETUP LAYOUT

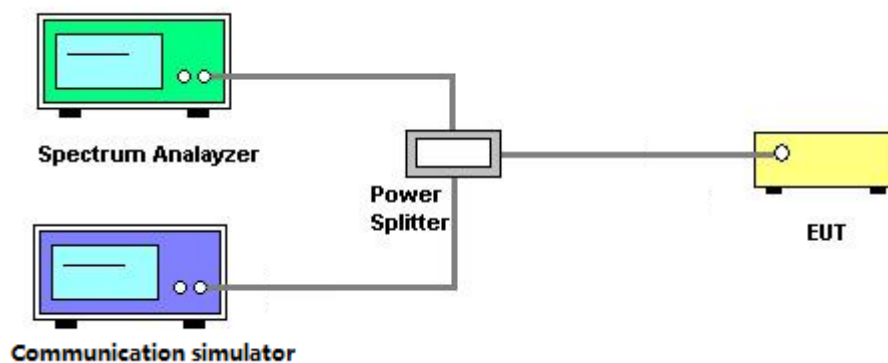

4.6.4 TESTDEVIATION

No deviation

4.6.5 TEST RESULTS

Please refer to the Attachment F.

4.7 FREQUENCY STABILITY MEASUREMENT

4.7.1 LIMIT

1.5 ppm is for base and fixed station. 2.5 ppm is for mobile station.

4.7.2 TEST PROCEDURES

1. Device is placed at the oven room. The oven room could control the temperatures and humidity. Power warm up is at least 15 min and power applied should perform before recording frequency error.
2. EUT is connected the external power supply to control the DC input power. The test voltage range is from minimum to maximum working voltage. Each step shall be record the frequency error rate.
3. The temperature range step is 10 degrees in this test items. All temperature levels shall be hold the $\pm 0.5^{\circ}\text{C}$ during the measurement testing. The each temperature step shall be at least 0.5 hours, consider the EUT could be test under the stability condition.
4. The frequency error was recorded frequency error from the communication simulator.

4.7.3 TESTSETUP LAYOUT

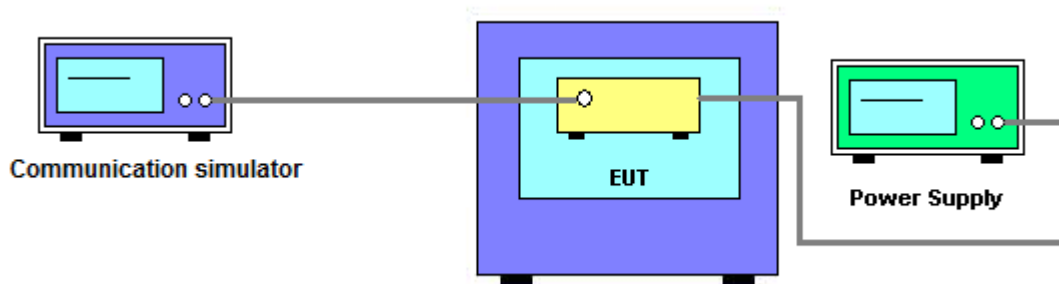

4.7.4 TESTDEVIATION

No deviation

4.7.5 TEST RESULTS

Please refer to the Attachment G.

5. LIST OF MEASUREMENT EQUIPMENTS

Radiated Emission Measurement					
Item	Kind of Equipment	Manufacturer	Type No.	Serial No.	Calibrated until
1	Preamplifier	EMCI	012645B	980267	Feb. 28, 2018
2	Preamplifier	EMCI	EMC02325	980217	Dec. 29, 2017
3	Preamplifier	EMCI	EMC2654045	980030	Feb. 14, 2018
4	Test Cable	EMCI	EMC104-SM-S M-8000	8m	Jan. 04, 2018
5	Test Cable	EMCI	EMC104-SM-S M-800	150207	Jan. 04, 2018
6	Test Cable	EMCI	EEMC104-SM-S M-3000	151205	Jan. 04, 2018
7	MXE EMI Receiver	Agilent	N9038A	MY55420127	Jan. 09, 2018
8	Signal Analyzer	Agilent	N9010A	MY52220990	Feb. 22, 2018
9	Loop Ant	EMCO	6502	42960	Nov. 24, 2017
10	Horn Ant	SCHWARZBECK	BBHA 9120D	9120D-1342	Feb. 28, 2018
11	Horn Ant	Schwarzbeck	BBHA 9170	187	Dec. 07, 2017
12	Trilog-Broadband Antenna	Schwarzbeck	VULB 9168	9168-548	Jan. 16, 2018
13	5dB Attenuator	EMCI	EMCI-N-6-05	AT-N0623	Jan. 16, 2018

Conducted Measurement					
Item	Kind of Equipment	Manufacturer	Type No.	Serial No.	Calibrated until
1	Spectrum Analyzer	Keysight	N9010A	MY54200240	Aug. 27, 2018
2	Radio Com Analyzer	Anritsu	MT8820C	6201525878	Sep. 05, 2019

Frequency Stability Measurement					
Item	Kind of Equipment	Manufacturer	Type No.	Serial No.	Calibrated until
1	Spectrum Analyzer	Keysight	N9010A	MY54200240	Aug. 27, 2018
2	Radio Com Analyzer	Anritsu	MT8820C	6201525878	Sep. 05, 2019
3	Thermal Chamber	HOLINK	CHOLINK/H-T-1F-D	BA03101701	May 14, 2018

Remark: "N/A" denotes no model name, serial no. or calibration specified.
All calibration period of equipment list is one year.

ATTACHMENT A - OUTPUT POWER

Conducted Power:

Modulation	Band	WCDMA IV		
	Tx Channel	1312 CH	1413 CH	1513 CH
	Rx Channel	1537 CH	1638 CH	1738 CH
	Frequency	1712.4	1732.6	1752.6
BPSK	RMC 12.2K	22.47	22.3	22.53
	RMC 64K	22.46	22.32	22.59
	RMC 144K	22.57	22.32	22.51
	RMC 384K	22.51	22.27	22.52
16QAM	HSDPA Subtest-1	21.92	21.74	21.94
	HSDPA Subtest-2	21.91	21.75	21.96
	HSDPA Subtest-3	21.92	21.74	21.93
	HSDPA Subtest-4	21.88	21.74	21.91
16QAM	HSUPA Subtest-1	21.87	21.72	21.92
	HSUPA Subtest-2	19.97	20.04	19.96
	HSUPA Subtest-3	19.32	19.35	19.41
	HSUPA Subtest-4	20.01	20.13	20.07
	HSUPA Subtest-5	21.09	20.99	21.29

LTE Band / BW	Modulation	RB Sizer	RB Offset	Low CH	Mid CH	High CH
				19975 CH	20175 CH	20375 CH
				1712.5 MHz	1732.5 MHz	1752.5 MHz
4 / 5M	QPSK	1	0	22.38	21.69	21.48
		1	12	23.31	22.44	21.57
		1	24	22.66	21.83	20.51
		12	0	21.67	20.83	20.48
		12	6	22.00	21.00	20.44
		12	13	21.82	21.01	20.09
		25	0	21.66	20.78	20.29
	16QAM	1	0	21.25	20.83	20.54
		1	12	22.20	21.60	20.66
		1	24	21.56	21.04	19.51
		12	0	20.68	19.96	19.52
		12	6	21.02	20.17	19.52
		12	13	20.88	20.18	19.17
		25	0	20.73	19.94	19.34

LTE Band / BW	Modulation	RB Sizer	RB Offset	Low CH	Mid CH	High CH
				20000 CH	20175 CH	20350 CH
				1715 MHz	1732.5 MHz	1750 MHz
4 / 10M	QPSK	1	0	22.50	21.99	22.59
		1	24	23.27	22.53	22.50
		1	49	22.24	21.98	20.80
		25	0	21.59	20.75	20.97
		25	12	21.62	20.85	20.80
		25	25	21.35	21.14	20.36
		50	0	21.67	21.09	20.57
	16QAM	1	0	21.38	20.79	21.31
		1	24	22.10	21.55	21.19
		1	49	21.04	21.07	19.74
		25	0	20.38	19.90	19.75
		25	12	20.41	20.00	19.63
		25	25	20.18	19.99	19.24
		50	0	20.48	19.89	19.43

LTE Band / BW	Modulation	RB Sizer	RB Offset	Low CH	Mid CH	High CH
				20025 CH	20175 CH	20325 CH
				1717.5 MHz	1732.5 MHz	1747.5 MHz
4 / 15M	QPSK	1	0	23.23	22.78	22.81
		1	37	23.38	22.88	23.01
		1	74	22.28	22.42	20.80
		36	0	22.01	22.42	21.76
		36	19	21.88	21.52	21.62
		36	39	21.24	21.61	20.76
		75	0	21.86	21.39	21.30
	16QAM	1	0	22.15	21.54	21.71
		1	37	22.27	21.81	21.81
		1	74	21.12	21.35	19.93
		36	0	21.14	21.35	20.78
		36	19	20.99	20.49	20.68
		36	39	20.37	20.62	19.91
		75	0	20.90	20.40	20.35

LTE Band / BW	Modulation	RB Sizer	RB Offset	Low CH	Mid CH	High CH
				20050 CH	20175 CH	20300 CH
				1720 MHz	1732.5 MHz	1745 MHz
4 / 20M	QPSK	1	0	22.67	22.37	22.59
		1	50	22.49	21.01	22.60
		1	99	22.20	22.76	20.94
		50	0	21.49	21.13	21.17
		50	25	21.17	21.07	21.32
		50	50	21.01	21.37	20.72
		100	0	21.26	21.27	21.02
	16QAM	1	0	22.01	21.24	21.68
		1	50	21.55	19.91	21.69
		1	99	21.14	21.56	19.98
		50	0	20.55	19.99	20.30
		50	25	20.20	19.98	20.21
		50	50	19.91	20.31	19.60
		100	0	20.28	20.19	19.89

LTE Band / BW	Modulation	RB Sizer	RB Offset	Low CH	Mid CH	High CH
				20775 CH	21100 CH	21425 CH
				2502.5 MHz	2535 MHz	2567.5 MHz
7 / 5M	QPSK	1	0	21.36	21.38	21.95
		1	12	22.08	22.38	22.37
		1	24	21.50	21.64	21.43
		12	0	21.11	21.41	22.12
		12	6	21.50	21.69	22.20
		12	13	21.43	21.74	21.84
		25	0	21.23	21.57	21.83
	16QAM	1	0	20.26	20.85	21.68
		1	12	20.96	21.71	22.07
		1	24	20.27	21.06	20.88
		12	0	19.50	19.79	20.11
		12	6	19.91	20.09	20.24
		12	13	19.82	20.14	19.98
		25	0	19.59	19.96	19.89

LTE Band / BW	Modulation	RB Sizer	RB Offset	Low CH	Mid CH	High CH
				20800 CH	21100 CH	21400 CH
				2505 MHz	2535 MHz	2565 MHz
7 / 10M	QPSK	1	0	21.44	21.58	22.34
		1	24	22.40	22.49	22.86
		1	49	21.44	21.58	21.05
		25	0	21.18	21.29	21.88
		25	12	21.62	21.69	22.07
		25	25	21.30	21.50	21.40
		50	0	21.05	21.45	21.65
	16QAM	1	0	20.74	20.96	21.10
		1	24	21.55	21.77	21.84
		1	49	20.52	20.97	20.21
		25	0	19.21	19.48	19.87
		25	12	19.64	19.87	20.17
		25	25	19.36	19.65	19.60
		50	0	19.27	19.62	19.70

LTE Band / BW	Modulation	RB Sizer	RB Offset	Low CH	Mid CH	High CH
				20825 CH	21100 CH	21375 CH
				2507.5 MHz	2535 MHz	2562.5 MHz
7 / 15M	QPSK	1	0	21.84	22.16	22.58
		1	37	22.41	22.61	22.84
		1	74	21.44	21.81	21.24
		36	0	21.36	21.59	22.30
		36	19	21.81	21.86	22.45
		36	39	21.81	21.83	21.90
		75	0	21.51	21.72	22.17
	16QAM	1	0	21.23	21.25	21.26
		1	37	21.61	21.78	21.89
		1	74	20.69	20.95	20.46
		36	0	19.67	19.79	20.11
		36	19	20.05	20.04	20.36
		36	39	19.83	19.99	20.00
		75	0	19.49	19.88	20.09

LTE Band / BW	Modulation	RB Sizer	RB Offset	Low CH	Mid CH	High CH
				20850 CH	21100 CH	21350 CH
				2510 MHz	2535 MHz	2560 MHz
7 / 20M	QPSK	1	0	22.10	22.28	22.55
		1	50	22.75	22.54	22.70
		1	99	21.87	22.12	21.35
		50	0	21.79	21.91	22.41
		50	25	22.11	22.06	22.43
		50	50	21.92	22.09	22.30
		100	0	21.78	21.95	22.36
	16QAM	1	0	21.74	21.66	21.56
		1	50	22.00	21.96	22.12
		1	99	21.66	21.77	21.89
		50	0	20.08	20.22	20.26
		50	25	20.32	20.34	20.52
		50	50	20.11	20.35	20.40
		100	0	19.95	20.22	20.34

LTE Band / BW	Modulation	RB Sizer	RB Offset	Low CH	Mid CH	High CH
				23035 CH	23095 CH	23155 CH
				701.5 MHz	707.5 MHz	713.5 MHz
12 / 5M	QPSK	1	0	23.14	23.25	23.16
		1	12	23.82	23.56	23.83
		1	24	23.31	23.19	22.49
		12	0	22.64	22.75	23.34
		12	6	23.02	22.87	23.37
		12	13	22.93	22.70	22.98
		25	0	22.79	22.65	23.04
	16QAM	1	0	22.03	22.22	21.84
		1	12	22.79	22.56	23.04
		1	24	22.21	22.14	21.61
		12	0	21.31	21.28	21.85
		12	6	21.68	21.40	22.04
		12	13	21.58	21.20	21.74
		25	0	21.38	21.13	21.63

LTE Band / BW	Modulation	RB Sizer	RB Offset	Low CH	Mid CH	High CH
				23060 CH	23095 CH	23130 CH
				704 MHz	707.5 MHz	711 MHz
12 / 10M	QPSK	1	0	23.17	23.41	23.27
		1	24	23.65	23.52	23.67
		1	49	23.28	23.33	22.34
		25	0	22.37	22.34	22.24
		25	12	22.59	22.40	22.56
		25	25	22.33	22.34	22.32
		50	0	22.36	22.35	22.22
	16QAM	1	0	22.29	22.46	22.18
		1	24	22.91	22.54	22.62
		1	49	22.06	22.28	21.63
		25	0	21.13	21.12	20.96
		25	12	21.36	21.16	21.26
		25	25	21.11	21.06	21.12
		50	0	21.11	21.05	20.94

EIRP Power:

Modulation	Band	WCDMA IV		
	Tx Channel	1312 CH	1413 CH	1513 CH
	Rx Channel	1537 CH	1638 CH	1738 CH
	Frequency	1712.4	1732.6	1752.6
	RMC 12.2K	23.52	23.35	23.58
BPSK	RMC 64K	23.51	23.37	23.64
	RMC 144K	23.62	23.37	23.56
	RMC 384K	23.56	23.32	23.57
16QAM	HSDPA Subtest-1	22.97	22.79	22.99
	HSDPA Subtest-2	22.96	22.8	23.01
	HSDPA Subtest-3	22.97	22.79	22.98
	HSDPA Subtest-4	22.93	22.79	22.96
16QAM	HSUPA Subtest-1	22.92	22.77	22.97
	HSUPA Subtest-2	21.02	21.09	21.01
	HSUPA Subtest-3	20.37	20.4	20.46
	HSUPA Subtest-4	21.06	21.18	21.12
	HSUPA Subtest-5	22.14	22.04	22.34

LTE Band / BW	Modulation	RB Sizer	RB Offset	Low CH	Mid CH	High CH
				19975 CH	20175 CH	20375 CH
				1712.5 MHz	1732.5 MHz	1752.5 MHz
4 / 5M	QPSK	1	0	23.53	22.84	22.63
		1	12	24.46	23.59	22.72
		1	24	23.81	22.98	21.66
		12	0	22.82	21.98	21.63
		12	6	23.15	22.15	21.59
		12	13	22.97	22.16	21.24
		25	0	22.81	21.93	21.44
	16QAM	1	0	22.40	21.98	21.69
		1	12	23.35	22.75	21.81
		1	24	22.71	22.19	20.66
		12	0	21.83	21.11	20.67
		12	6	22.17	21.32	20.67
		12	13	22.03	21.33	20.32
		25	0	21.88	21.09	20.49

LTE Band / BW	Modulation	RB Sizer	RB Offset	Low CH	Mid CH	High CH
				20000 CH	20175 CH	20350 CH
				1715 MHz	1732.5 MHz	1750 MHz
4 / 10M	QPSK	1	0	23.65	23.14	23.74
		1	24	24.42	23.68	23.65
		1	49	23.39	23.13	21.95
		25	0	22.74	21.90	22.12
		25	12	22.77	22.00	21.95
		25	25	22.50	22.29	21.51
		50	0	22.82	22.24	21.72
	16QAM	1	0	22.53	21.94	22.46
		1	24	23.25	22.70	22.34
		1	49	22.19	22.22	20.89
		25	0	21.53	21.05	20.90
		25	12	21.56	21.15	20.78
		25	25	21.33	21.14	20.39
		50	0	21.63	21.04	20.58

LTE Band / BW	Modulation	RB Sizer	RB Offset	Low CH	Mid CH	High CH
				20025 CH	20175 CH	20325 CH
				1717.5 MHz	1732.5 MHz	1747.5 MHz
4 / 15M	QPSK	1	0	24.38	23.93	23.96
		1	37	24.53	24.03	24.16
		1	74	23.43	23.57	21.95
		36	0	23.16	23.57	22.91
		36	19	23.03	22.67	22.77
		36	39	22.39	22.76	21.91
		75	0	23.01	22.54	22.45
	16QAM	1	0	23.30	22.69	22.86
		1	37	23.42	22.96	22.96
		1	74	22.27	22.50	21.08
		36	0	22.29	22.50	21.93
		36	19	22.14	21.64	21.83
		36	39	21.52	21.77	21.06
		75	0	22.05	21.55	21.50

LTE Band / BW	Modulation	RB Sizer	RB Offset	Low CH	Mid CH	High CH
				20050 CH	20175 CH	20300 CH
				1720 MHz	1732.5 MHz	1745 MHz
4 / 20M	QPSK	1	0	23.82	23.52	23.74
		1	50	23.64	22.16	23.75
		1	99	23.35	23.91	22.09
		50	0	22.64	22.28	22.32
		50	25	22.32	22.22	22.47
		50	50	22.16	22.52	21.87
		100	0	22.41	22.42	22.17
	16QAM	1	0	23.16	22.39	22.83
		1	50	22.70	21.06	22.84
		1	99	22.29	22.71	21.13
		50	0	21.70	21.14	21.45
		50	25	21.35	21.13	21.36
		50	50	21.06	21.46	20.75
		100	0	21.43	21.34	21.04

LTE Band / BW	Modulation	RB Sizer	RB Offset	Low CH	Mid CH	High CH
				20775 CH	21100 CH	21425 CH
				2502.5 MHz	2535 MHz	2567.5 MHz
7 / 5M	QPSK	1	0	22.81	22.83	23.40
		1	12	23.53	23.83	23.82
		1	24	22.95	23.09	22.88
		12	0	22.56	22.86	23.57
		12	6	22.95	23.14	23.65
		12	13	22.88	23.19	23.29
		25	0	22.68	23.02	23.28
	16QAM	1	0	21.71	22.30	23.13
		1	12	22.41	23.16	23.52
		1	24	21.72	22.51	22.33
		12	0	20.95	21.24	21.56
		12	6	21.36	21.54	21.69
		12	13	21.27	21.59	21.43
		25	0	21.04	21.41	21.34

LTE Band / BW	Modulation	RB Sizer	RB Offset	Low CH	Mid CH	High CH
				20800 CH	21100 CH	21400 CH
				2505 MHz	2535 MHz	2565 MHz
7 / 10M	QPSK	1	0	23.19	23.33	24.09
		1	24	24.15	24.24	24.61
		1	49	23.19	23.33	22.80
		25	0	22.93	23.04	23.63
		25	12	23.37	23.44	23.82
		25	25	23.05	23.25	23.15
		50	0	22.80	23.20	23.40
	16QAM	1	0	22.49	22.71	22.85
		1	24	23.30	23.52	23.59
		1	49	22.27	22.72	21.96
		25	0	20.96	21.23	21.62
		25	12	21.39	21.62	21.92
		25	25	21.11	21.40	21.35
		50	0	21.02	21.37	21.45

LTE Band / BW	Modulation	RB Sizer	RB Offset	Low CH	Mid CH	High CH
				20825 CH	21100 CH	21375 CH
				2507.5 MHz	2535 MHz	2562.5 MHz
7 / 15M	QPSK	1	0	23.59	23.91	24.33
		1	37	24.16	24.36	24.59
		1	74	23.19	23.56	22.99
		36	0	23.11	23.34	24.05
		36	19	23.56	23.61	24.20
		36	39	23.56	23.58	23.65
		75	0	23.26	23.47	23.92
	16QAM	1	0	22.98	23.00	23.01
		1	37	23.36	23.53	23.64
		1	74	22.44	22.70	22.21
		36	0	21.42	21.54	21.86
		36	19	21.80	21.79	22.11
		36	39	21.58	21.74	21.75
		75	0	21.24	21.63	21.84

LTE Band / BW	Modulation	RB Sizer	RB Offset	Low CH	Mid CH	High CH
				20850 CH	21100 CH	21350 CH
				2510 MHz	2535 MHz	2560 MHz
7 / 20M	QPSK	1	0	23.85	24.03	24.30
		1	50	24.50	24.29	24.45
		1	99	23.62	23.87	23.10
		50	0	23.54	23.66	24.16
		50	25	23.86	23.81	24.18
		50	50	23.67	23.84	24.05
		100	0	23.53	23.70	24.11
	16QAM	1	0	23.49	23.41	23.31
		1	50	23.75	23.71	23.87
		1	99	23.41	23.52	23.64
		50	0	21.83	21.97	22.01
		50	25	22.07	22.09	22.27
		50	50	21.86	22.10	22.15
		100	0	21.70	21.97	22.09

ERP Power:

LTE Band / BW	Modulation	RB Sizer	RB Offset	Low CH	Mid CH	High CH
				23035 CH	23095 CH	23155 CH
				701.5 MHz	707.5 MHz	713.5 MHz
12 / 5M	QPSK	1	0	21.99	22.10	22.01
		1	12	22.67	22.41	22.68
		1	24	22.16	22.04	21.34
		12	0	21.49	21.60	22.19
		12	6	21.87	21.72	22.22
		12	13	21.78	21.55	21.83
		25	0	21.64	21.50	21.89
	16QAM	1	0	20.88	21.07	20.69
		1	12	21.64	21.41	21.89
		1	24	21.06	20.99	20.46
		12	0	20.16	20.13	20.70
		12	6	20.53	20.25	20.89
		12	13	20.43	20.05	20.59
		25	0	20.23	19.98	20.48

LTE Band / BW	Modulation	RB Sizer	RB Offset	Low CH	Mid CH	High CH
				23060 CH	23095 CH	23130 CH
				704 MHz	707.5 MHz	711 MHz
12 / 10M	QPSK	1	0	22.02	22.26	22.12
		1	24	22.50	22.37	22.52
		1	49	22.13	22.18	21.19
		25	0	21.22	21.19	21.09
		25	12	21.44	21.25	21.41
		25	25	21.18	21.19	21.17
		50	0	21.21	21.20	21.07
	16QAM	1	0	21.14	21.31	21.03
		1	24	21.76	21.39	21.47
		1	49	20.91	21.13	20.48
		25	0	19.98	19.97	19.81
		25	12	20.21	20.01	20.11
		25	25	19.96	19.91	19.97
		50	0	19.96	19.90	19.79

ATTACHMENT B - OCCUPIED BANDWIDTH

WCDMA Band 4 WCDMA					
Channel	Frequency (MHz)	99% Occupied Bandwidth (MHz)	Channel	Frequency (MHz)	26dB Bandwidth (MHz)
1312	1712.4	4.1559	19957	1710.7	4.719
1413	1732.6	4.1944	20175	1732.5	4.758
1513	1752.6	4.1640	20393	1754.3	4.720

Spectrum Plot

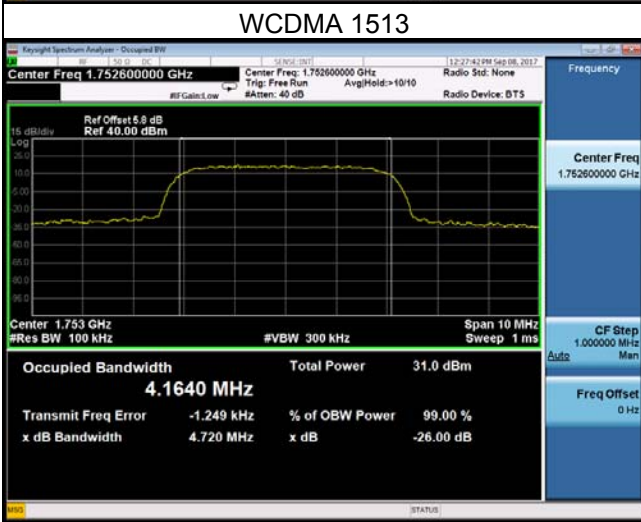

WCDMA Band 4 HSDPA					
Channel	Frequency (MHz)	99% Occupied Bandwidth (MHz)	Channel	Frequency (MHz)	26dB Bandwidth (MHz)
1312	1712.4	4.1595	19957	1710.7	4.735
1413	1732.6	4.1625	20175	1732.5	4.736
1513	1752.6	4.1609	20393	1754.3	4.719

Spectrum Plot

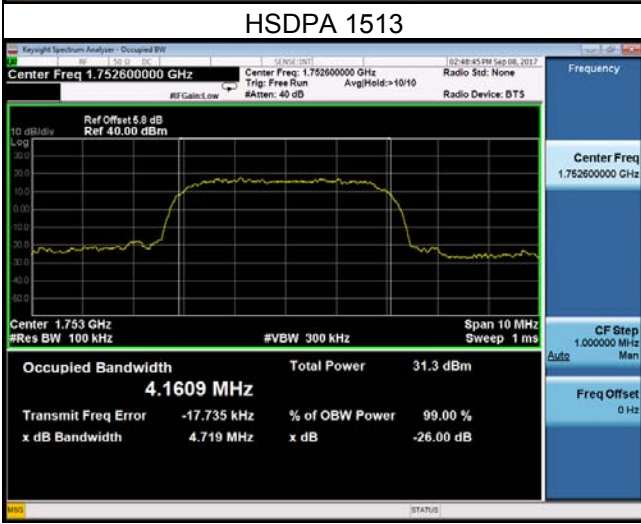

WCDMA Band 4 HSUPA					
Channel	Frequency (MHz)	99% Occupied Bandwidth (MHz)	Channel	Frequency (MHz)	26dB Bandwidth (MHz)
1312	1712.4	4.1564	19957	1710.7	4.733
1413	1732.6	4.1641	20175	1732.5	4.734
1513	1752.6	4.1577	20393	1754.3	4.721

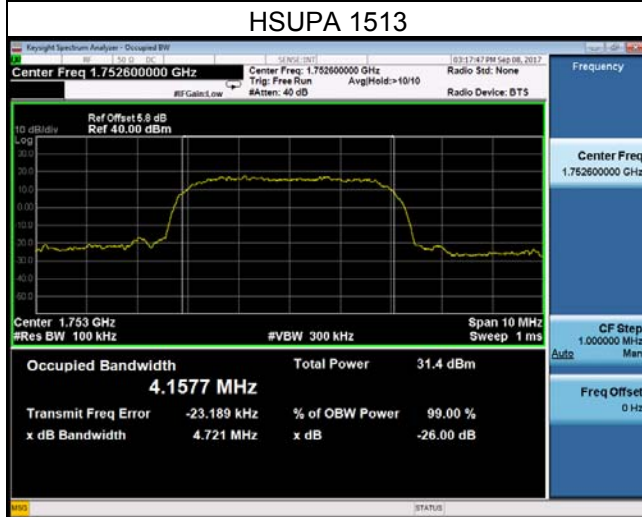
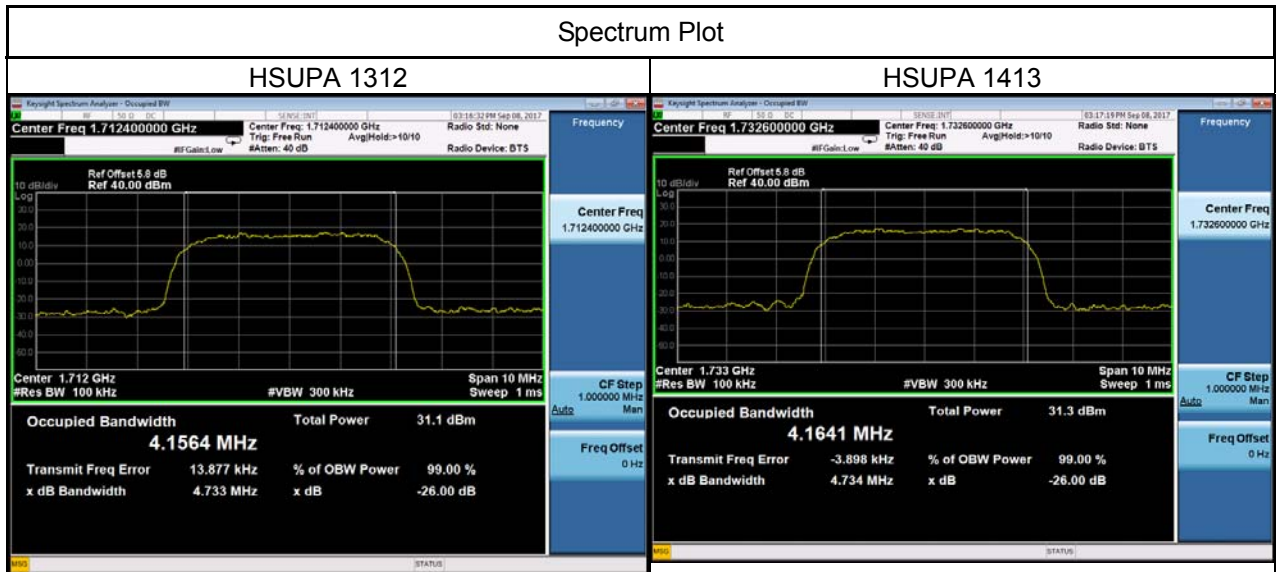

LTE Band 4_5M					
QPSK			16QAM		
Channel	Frequency (MHz)	99% Occupied Bandwidth (MHz)	Channel	Frequency (MHz)	99% Occupied Bandwidth (MHz)
19975	1712.5	4.4937	19975	1712.5	4.5053
20175	1732.5	4.4991	20175	1732.5	4.4984
20375	1752.5	4.5015	20375	1752.5	4.4986
Channel	Frequency (MHz)	26dB Bandwidth (MHz)	Channel	Frequency (MHz)	26dB Bandwidth (MHz)
19975	1712.5	4.933	19975	1712.5	4.920
20175	1732.5	4.965	20175	1732.5	4.960
20375	1752.5	4.913	20375	1752.5	4.926

Spectrum Plot

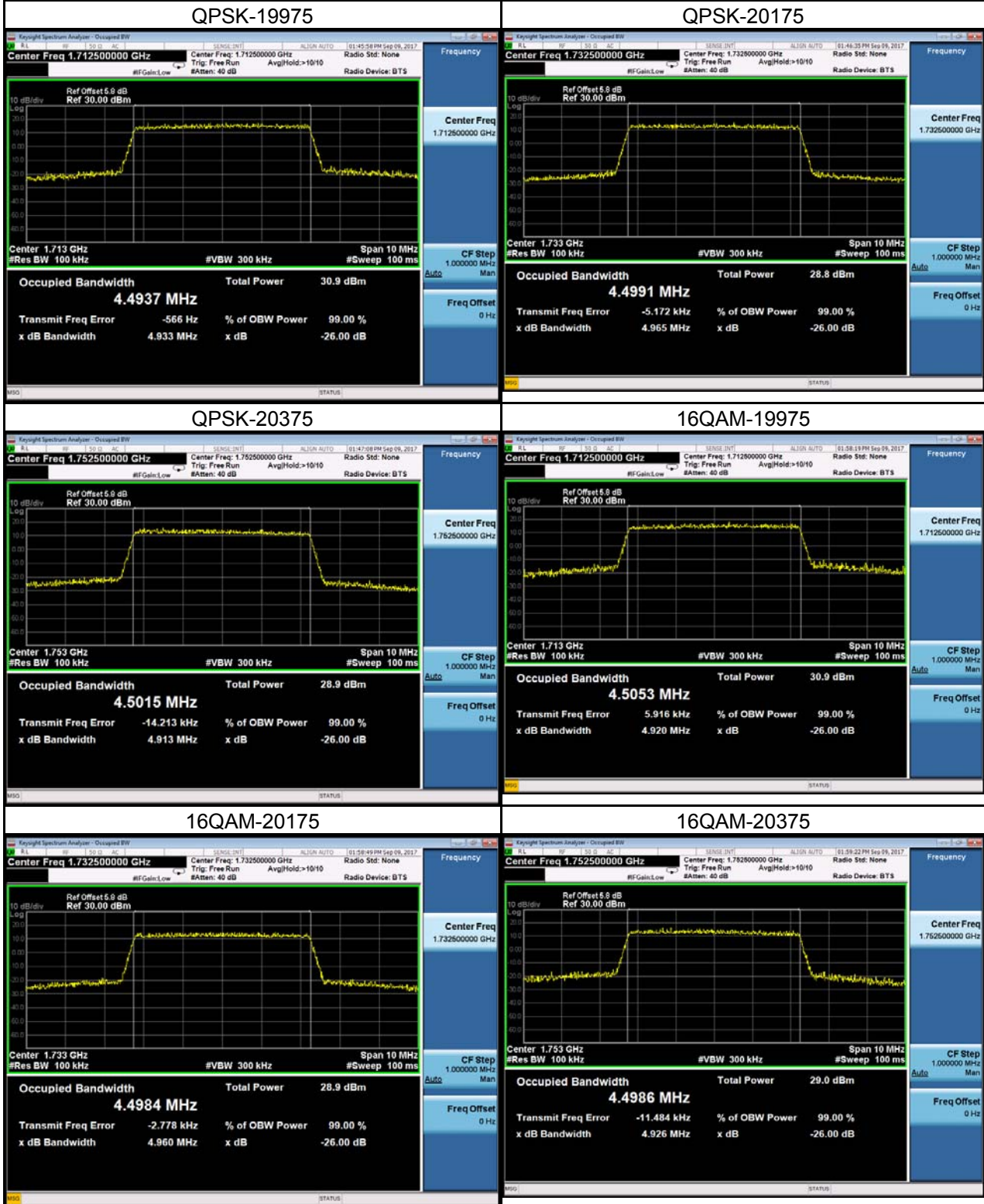

LTE Band 4_10M					
QPSK			16QAM		
Channel	Frequency (MHz)	99% Occupied Bandwidth (MHz)	Channel	Frequency (MHz)	99% Occupied Bandwidth (MHz)
20000	1715	8.9825	20000	1715	8.9854
20175	1732.5	8.9932	20175	1732.5	9.0146
20350	1750	8.9786	20350	1750	8.9889
Channel	Frequency (MHz)	26dB Bandwidth (MHz)	Channel	Frequency (MHz)	26dB Bandwidth (MHz)
20000	1715	9.828	20000	1715	9.855
20175	1732.5	9.902	20175	1732.5	9.953
20350	1750	9.925	20350	1750	9.890

Spectrum Plot



LTE Band 4_15M					
QPSK			16QAM		
Channel	Frequency (MHz)	99% Occupied Bandwidth (MHz)	Channel	Frequency (MHz)	99% Occupied Bandwidth (MHz)
20025	1717.5	13.433	20025	1717.5	13.480
20175	1732.5	13.517	20175	1732.5	13.514
20325	1747.5	13.433	20325	1747.5	13.431
Channel	Frequency (MHz)	26dB Bandwidth (MHz)	Channel	Frequency (MHz)	26dB Bandwidth (MHz)
20025	1717.5	14.87	20025	1717.5	14.91
20175	1732.5	15.08	20175	1732.5	14.98
20325	1747.5	14.86	20325	1747.5	14.80

Spectrum Plot



LTE Band 4_20M					
QPSK			16QAM		
Channel	Frequency (MHz)	99% Occupied Bandwidth (MHz)	Channel	Frequency (MHz)	99% Occupied Bandwidth (MHz)
20050	1720	17.890	20050	1720	17.954
20175	1732.5	18.018	20175	1732.5	18.008
20300	1745	17.915	20300	1745	17.908
Channel	Frequency (MHz)	26dB Bandwidth (MHz)	Channel	Frequency (MHz)	26dB Bandwidth (MHz)
20050	1720	19.63	20050	1720	19.60
20175	1732.5	19.78	20175	1732.5	19.66
20300	1745	19.60	20300	1745	19.57

Spectrum Plot

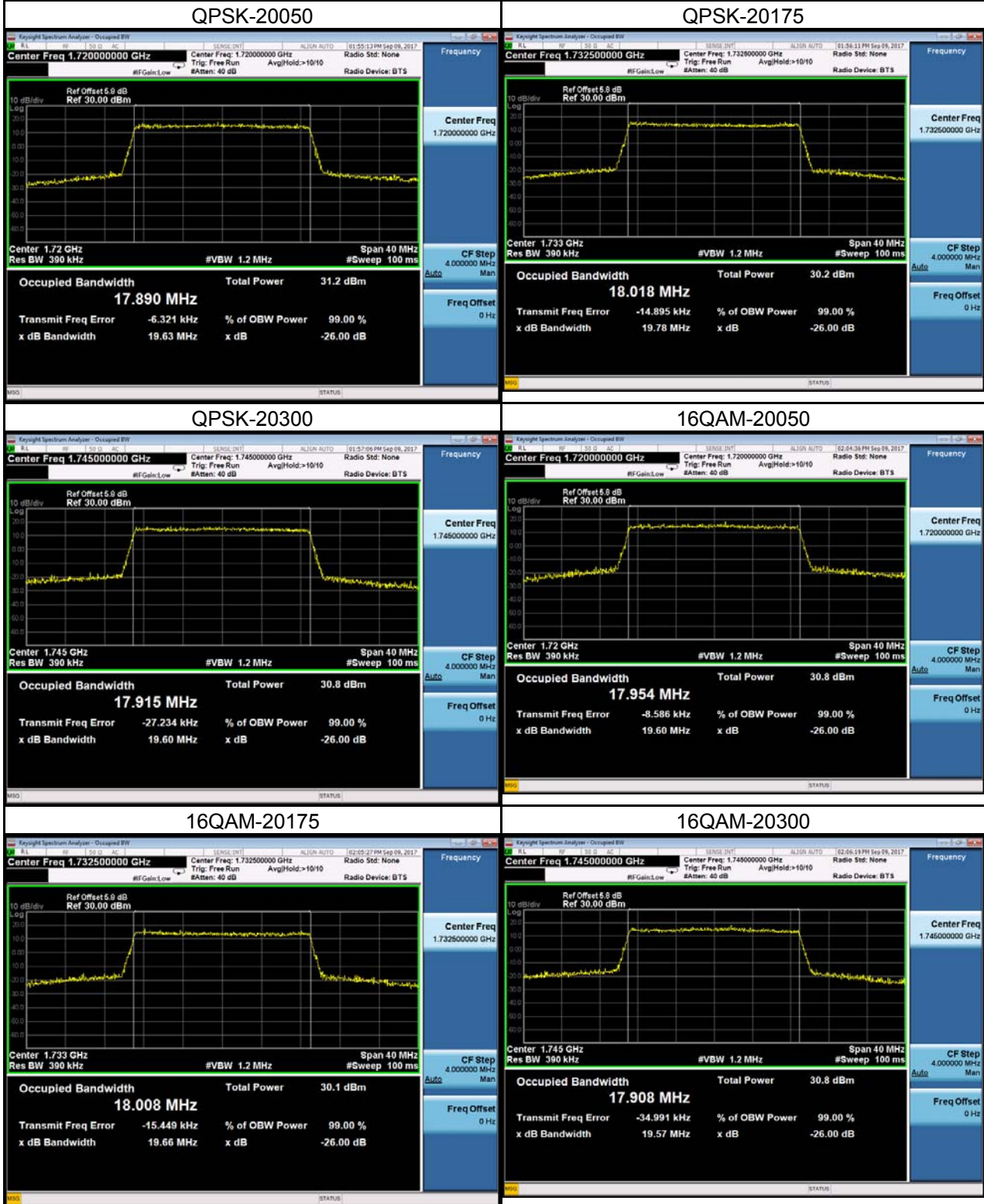

LTE Band 7_5M					
QPSK			16QAM		
Channel	Frequency (MHz)	99% Occupied Bandwidth (MHz)	Channel	Frequency (MHz)	99% Occupied Bandwidth (MHz)
20775	2502.5	4.4979	20775	2502.5	4.5017
21100	2535	4.4943	21100	2535	4.4973
21425	2567.5	4.5000	21425	2567.5	4.4961
Channel	Frequency (MHz)	26dB Bandwidth (MHz)	Channel	Frequency (MHz)	26dB Bandwidth (MHz)
20775	2502.5	4.972	20775	2502.5	4.956
21100	2535	4.932	21100	2535	4.924
21425	2567.5	4.930	21425	2567.5	4.908

Spectrum Plot

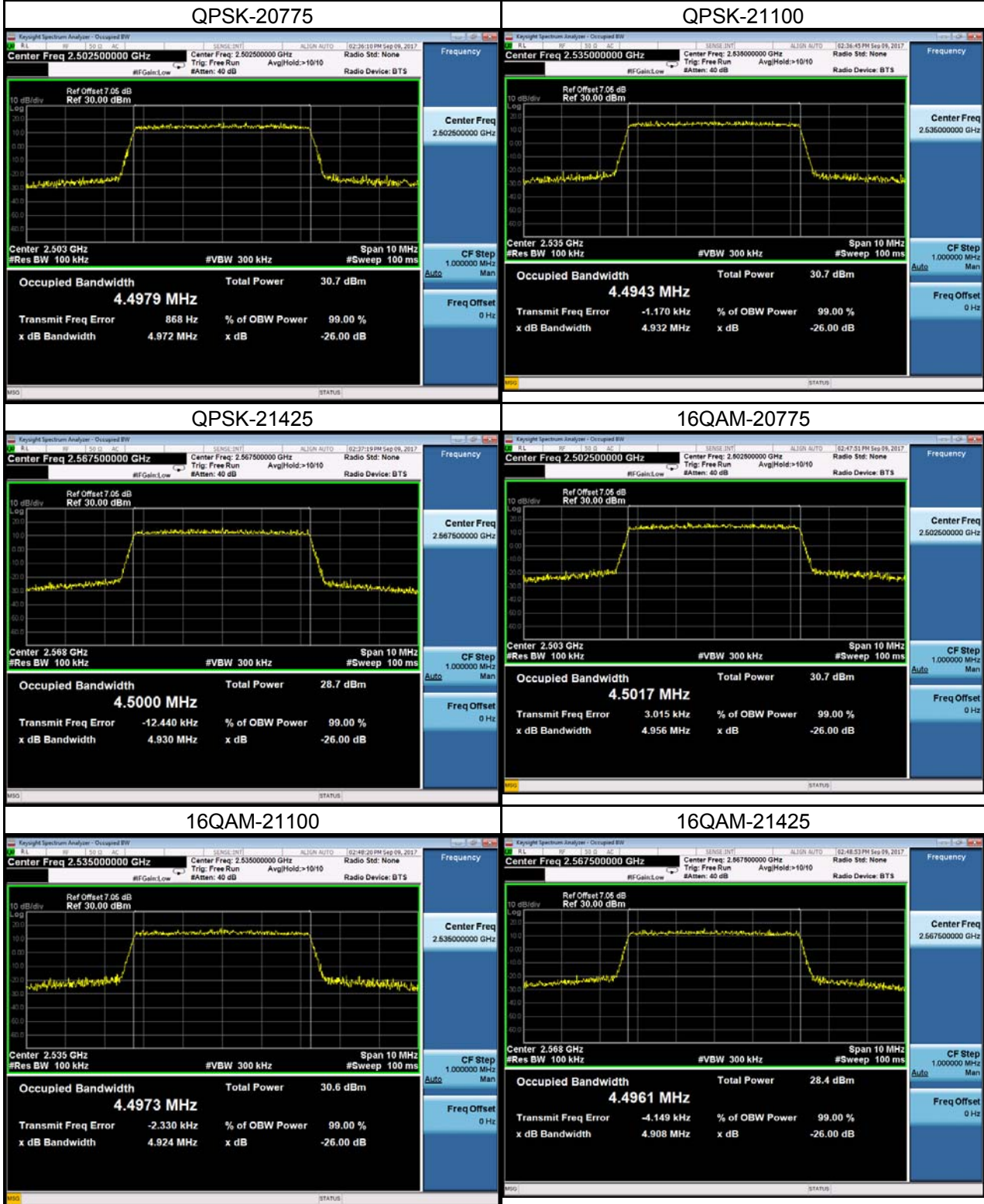

LTE Band 7_10M					
QPSK			16QAM		
Channel	Frequency (MHz)	99% Occupied Bandwidth (MHz)	Channel	Frequency (MHz)	99% Occupied Bandwidth (MHz)
20800	2505	8.9955	20800	2505	8.9841
21100	2535	8.9891	21100	2535	8.9812
21400	2565	8.9960	21400	2565	9.0173
Channel	Frequency (MHz)	26dB Bandwidth (MHz)	Channel	Frequency (MHz)	26dB Bandwidth (MHz)
20800	2505	9.842	20800	2505	9.847
21100	2535	9.808	21100	2535	9.938
21400	2565	9.902	21400	2565	9.877

Spectrum Plot

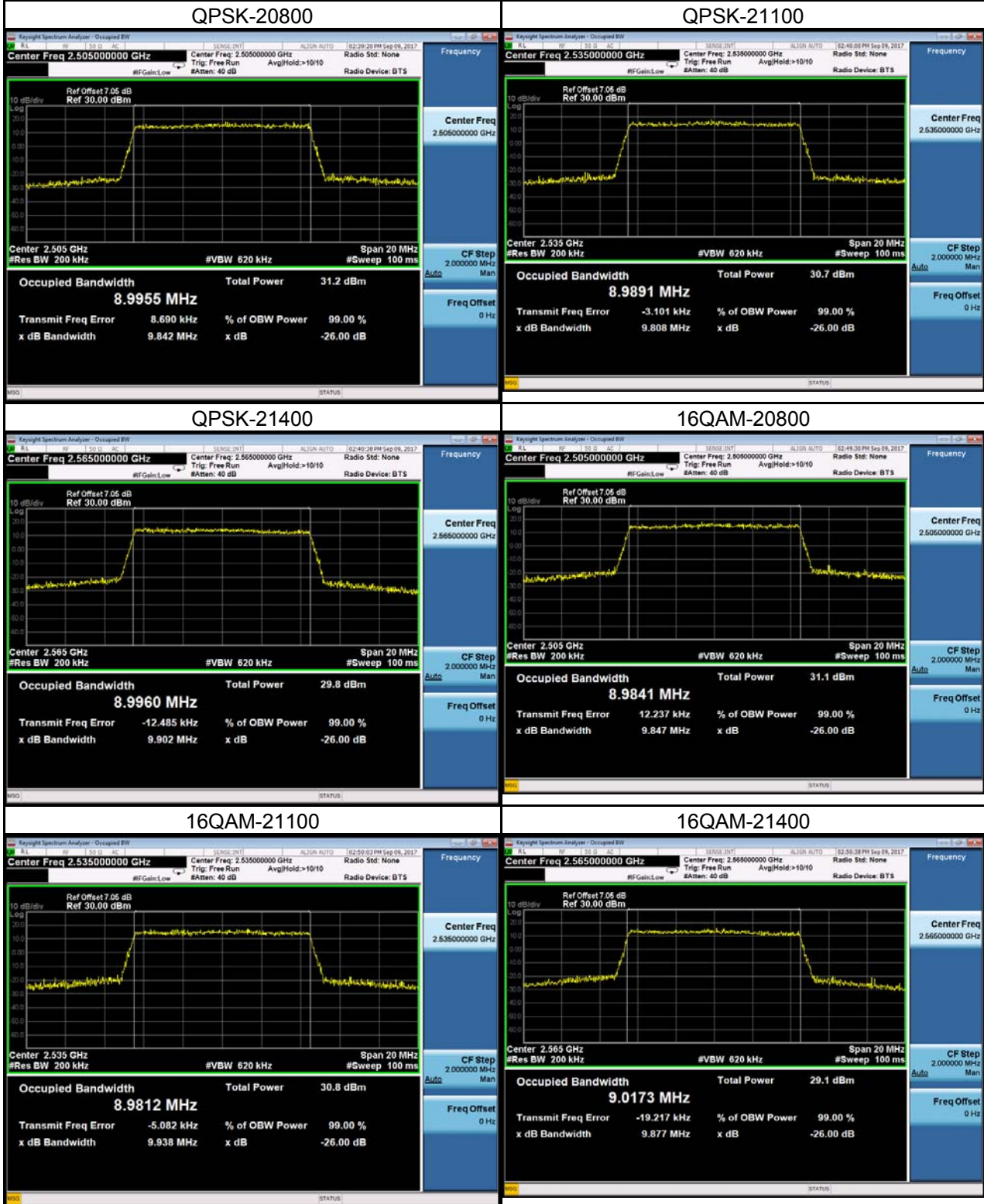

LTE Band 7_15M					
QPSK			16QAM		
Channel	Frequency (MHz)	99% Occupied Bandwidth (MHz)	Channel	Frequency (MHz)	99% Occupied Bandwidth (MHz)
20825	2507.5	13.494	20825	2507.5	13.498
21100	2535	13.494	21100	2535	13.493
21375	2562.5	13.467	21375	2562.5	13.476
Channel	Frequency (MHz)	26dB Bandwidth (MHz)	Channel	Frequency (MHz)	26dB Bandwidth (MHz)
20825	2507.5	14.99	20825	2507.5	14.88
21100	2535	14.93	21100	2535	14.95
21375	2562.5	14.89	21375	2562.5	14.84

Spectrum Plot

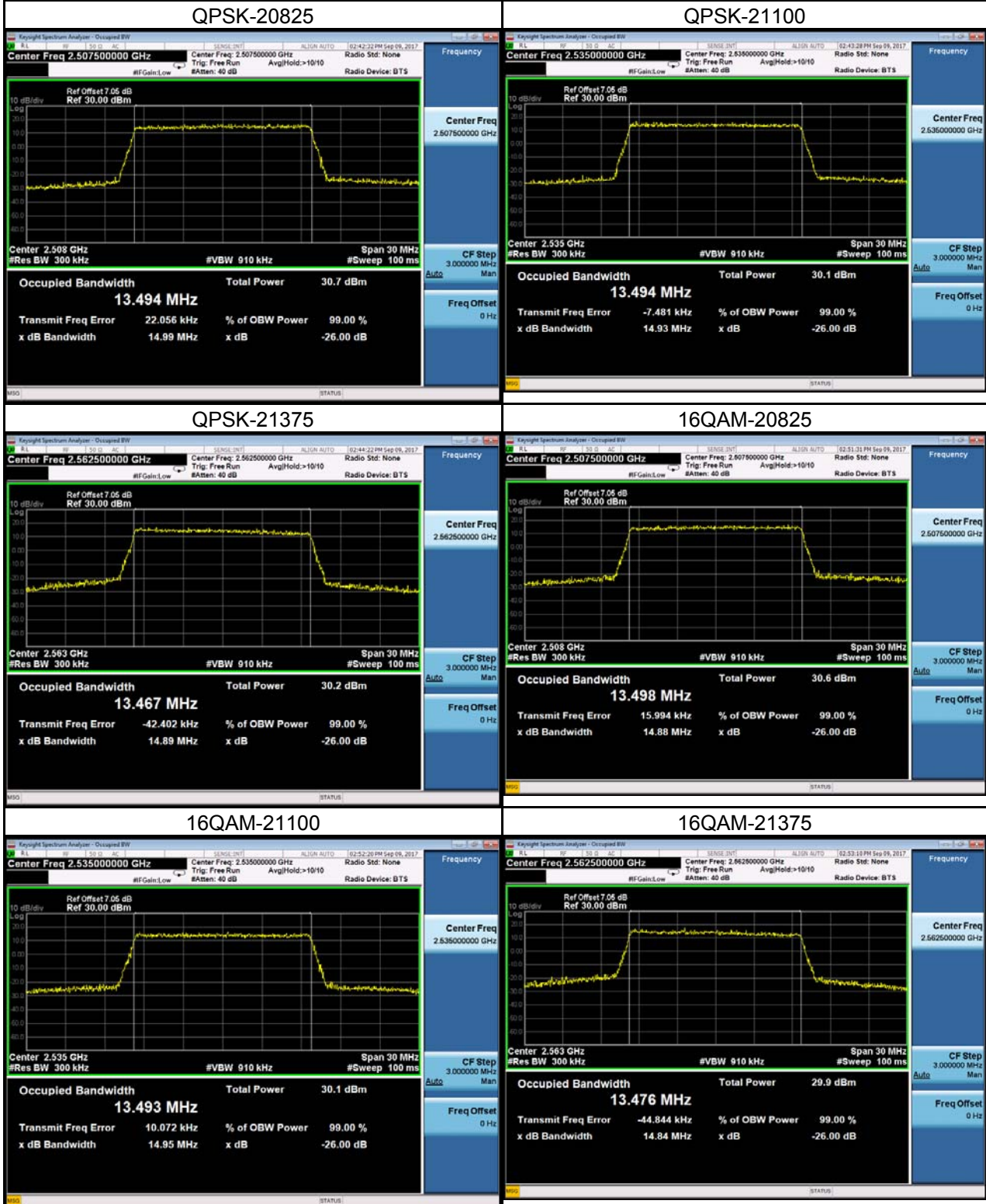

LTE Band 7_20M					
QPSK			16QAM		
Channel	Frequency (MHz)	99% Occupied Bandwidth (MHz)	Channel	Frequency (MHz)	99% Occupied Bandwidth (MHz)
20850	2510	17.960	20850	2510	17.956
21100	2535	17.986	21100	2535	18.012
21350	2560	17.926	21350	2560	17.950
Channel	Frequency (MHz)	26dB Bandwidth (MHz)	Channel	Frequency (MHz)	26dB Bandwidth (MHz)
20850	2510	19.64	20850	2510	19.67
21100	2535	19.81	21100	2535	19.73
21350	2560	19.57	21350	2560	19.50

Spectrum Plot

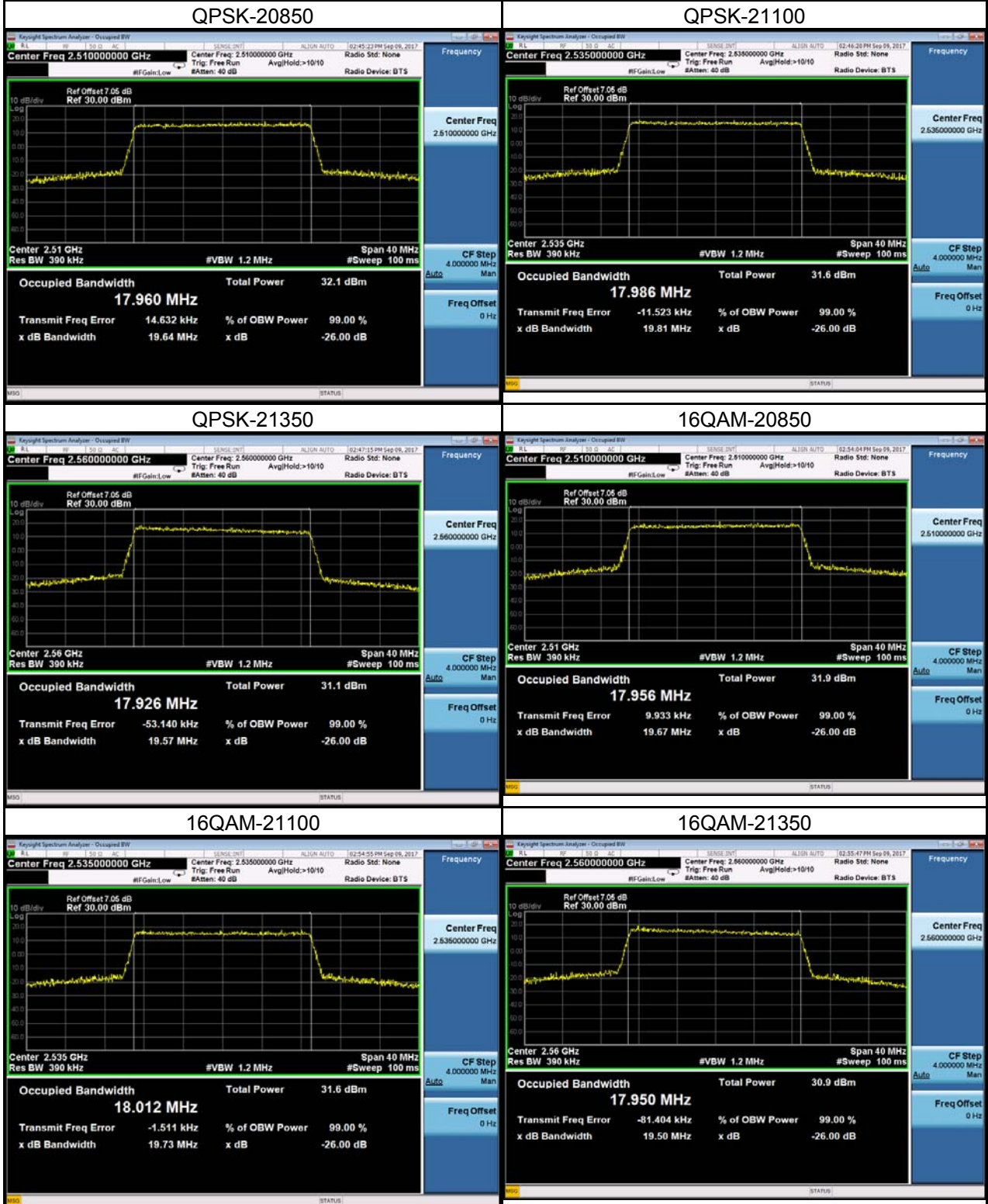

LTE Band 12_5M					
QPSK			16QAM		
Channel	Frequency (MHz)	99% Occupied Bandwidth (MHz)	Channel	Frequency (MHz)	99% Occupied Bandwidth (MHz)
23035	701.5	4.5090	23035	701.5	4.5007
23095	707.5	4.4972	23095	707.5	4.4991
23155	713.5	4.4901	23155	713.5	4.4900
Channel	Frequency (MHz)	26dB Bandwidth (MHz)	Channel	Frequency (MHz)	26dB Bandwidth (MHz)
23035	701.5	4.928	23035	701.5	4.926
23095	707.5	4.977	23095	707.5	4.954
23155	713.5	4.903	23155	713.5	4.941

Spectrum Plot



LTE Band 12_10M					
QPSK			16QAM		
Channel	Frequency (MHz)	99% Occupied Bandwidth (MHz)	Channel	Frequency (MHz)	99% Occupied Bandwidth (MHz)
23060	704.0	8.9464	23060	704.0	8.9607
23095	707.5	8.9864	23095	707.5	8.9977
23130	711.0	9.0173	23130	711.0	9.0400
Channel	Frequency (MHz)	26dB Bandwidth (MHz)	Channel	Frequency (MHz)	26dB Bandwidth (MHz)
23060	704.0	9.831	23060	704.0	9.869
23095	707.5	9.820	23095	707.5	9.851
23130	711.0	9.851	23130	711.0	9.888

Spectrum Plot



ATTACHMENT C - CONDUCTED EMISSIONS

WCDMA Band 4_WCDMA

Channel	Frequency(MHz)	Channel	Frequency(MHz)
1413	1732.6	1413	1732.6

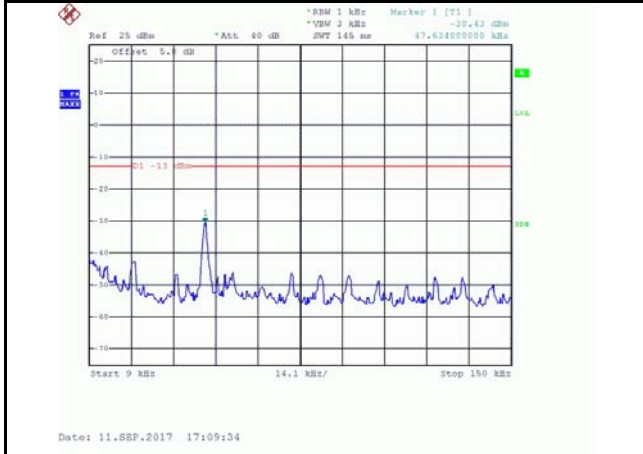

Channel	Frequency(MHz)	-	-
1413	1732.6	-	-

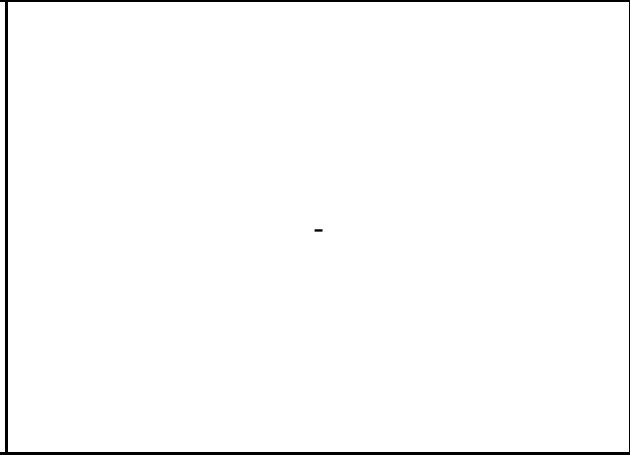

WCDMA Band 4_HSDPA			
Channel	Frequency(MHz)	Channel	Frequency(MHz)
1413	1732.6	1413	1732.6
Channel	Frequency(MHz)	-	-
1413	1732.6	-	-

WCDMA Band 4_HSUPA

Channel	Frequency(MHz)	Channel	Frequency(MHz)
1413	1732.6	1413	1732.6

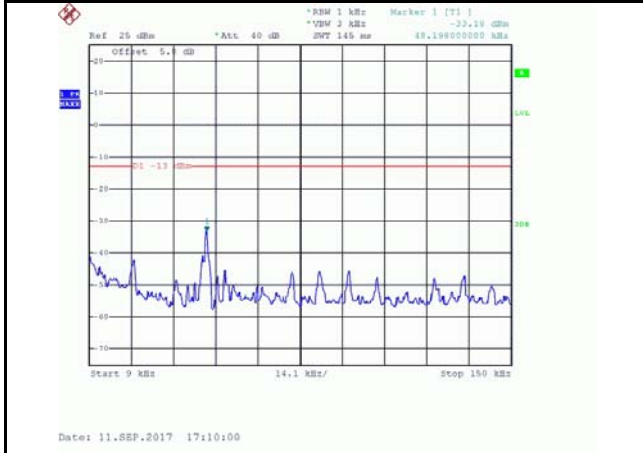

Channel	Frequency(MHz)	Channel	Frequency(MHz)
1413	1732.6	-	-

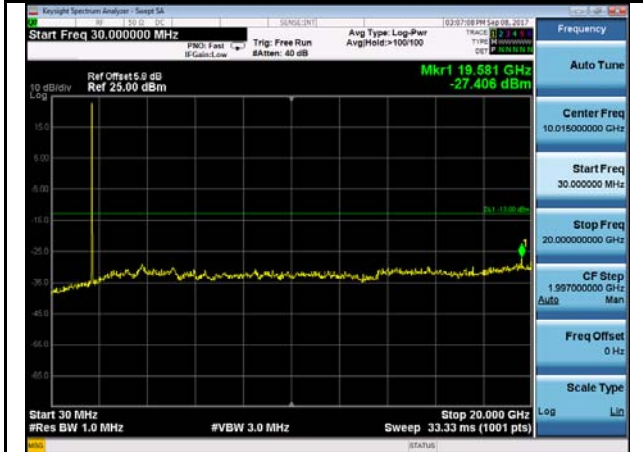

Channel	Frequency(MHz)
-	-

LTE Band 4_5M			
Channel	Frequency(MHz)	Channel	Frequency(MHz)
20175	1732.5	20175	1732.5
Date: 11.88P.2017 17:10:20		Date: 11.88P.2017 17:13:13	
Channel	Frequency(MHz)	-	-
20175	1732.5	-	-
		-	

LTE Band 4_10M			
Channel	Frequency(MHz)	Channel	Frequency(MHz)
20175	1732.5	20175	1732.5
Date: 11.88P.2017 17:10:41		Date: 11.88P.2017 17:13:34	
Channel	Frequency(MHz)	-	-
20175	1732.5	-	-

LTE Band 4_15M

Channel	Frequency(MHz)	Channel	Frequency(MHz)
20175	1732.5	20175	1732.5

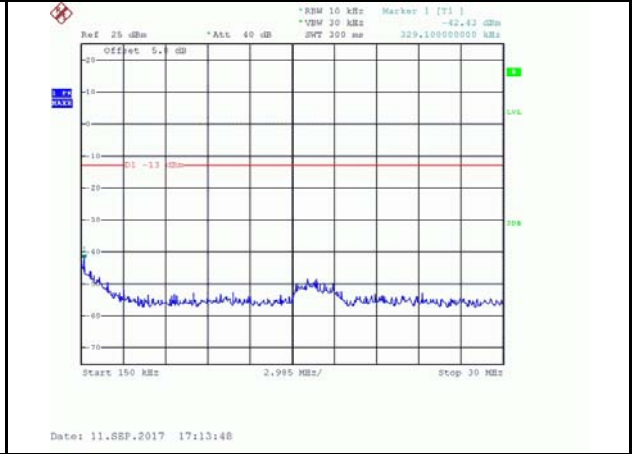
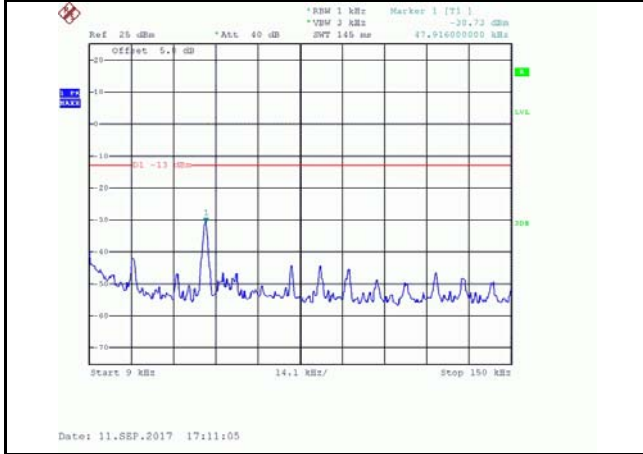

Channel	Frequency(MHz)	-	-
20175	1732.5	-	-

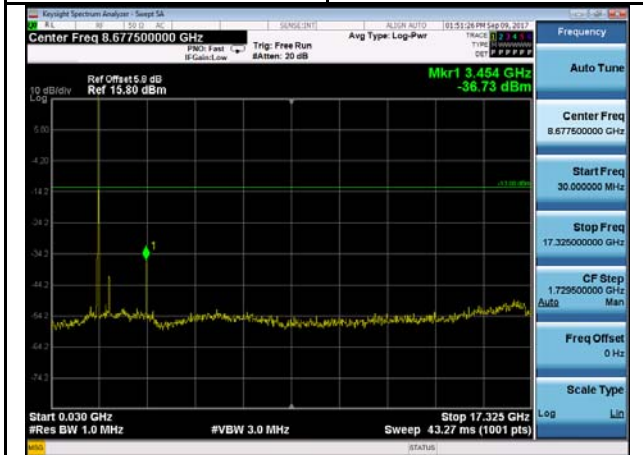

-	-
-	-

LTE Band 4_20M			
Channel	Frequency(MHz)	Channel	Frequency(MHz)
20175	1732.5	20175	1732.5
Date: 11.88P.2017 17:11:25		Date: 11.88P.2017 17:13:57	
Channel	Frequency(MHz)	-	-
20175	1732.5	-	-
		-	

LTE Band 7_5M			
Channel	Frequency(MHz)	Channel	Frequency(MHz)
21100	2535	21100	2535
Channel	Frequency(MHz)	-	-
21100	2535	-	-

LTE Band 7_10M			
Channel	Frequency(MHz)	Channel	Frequency(MHz)
21100	2535	21100	2535
Date: 11.88P.2017 17:17:11		Date: 11.88P.2017 17:15:27	
Channel	Frequency(MHz)	-	-
21100	2535	-	-

LTE Band 7_15M			
Channel	Frequency(MHz)	Channel	Frequency(MHz)
21100	2535	21100	2535
Channel	Frequency(MHz)	-	-
21100	2535	-	-

LTE Band 7_20M			
Channel	Frequency(MHz)	Channel	Frequency(MHz)
21100	2535	21100	2535
Date: 11.88P.2017 17:17:42		Date: 11.88P.2017 17:16:04	
Channel	Frequency(MHz)	-	-
21100	2535	-	-

LTE Band 12_5M			
Channel	Frequency(MHz)	Channel	Frequency(MHz)
23095	707.5	23095	707.5
Channel	Frequency(MHz)	-	-
23095	707.5	-	-
		-	

LTE Band 12_10M			
Channel	Frequency(MHz)	Channel	Frequency(MHz)
23095	707.5	23095	707.5
Channel	Frequency(MHz)	-	-
23095	707.5	-	-

ATTACHMENT D - RADIATED EMISSION

Test Mode: TX Mode

Ant 0°

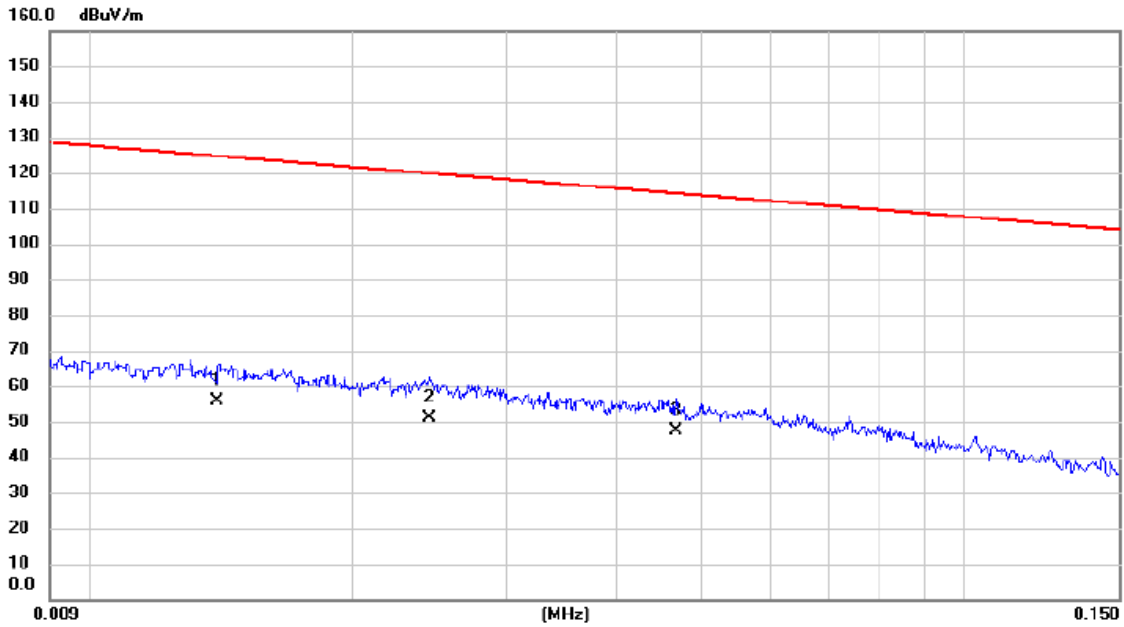

No.	Mk.	Freq. MHz	Reading Level dBuV	Correct Factor dB	Measure- ment dBuV/m	Limit dBuV/m	Margin dB	Detector	Comment
1		0.014	36.48	19.40	55.88	124.68	-68.80	AVG	
2		0.025	34.66	16.51	51.17	119.82	-68.65	AVG	
3	*	0.047	33.93	13.32	47.25	114.20	-66.95	AVG	

Test Mode: TX Mode

Ant 0°

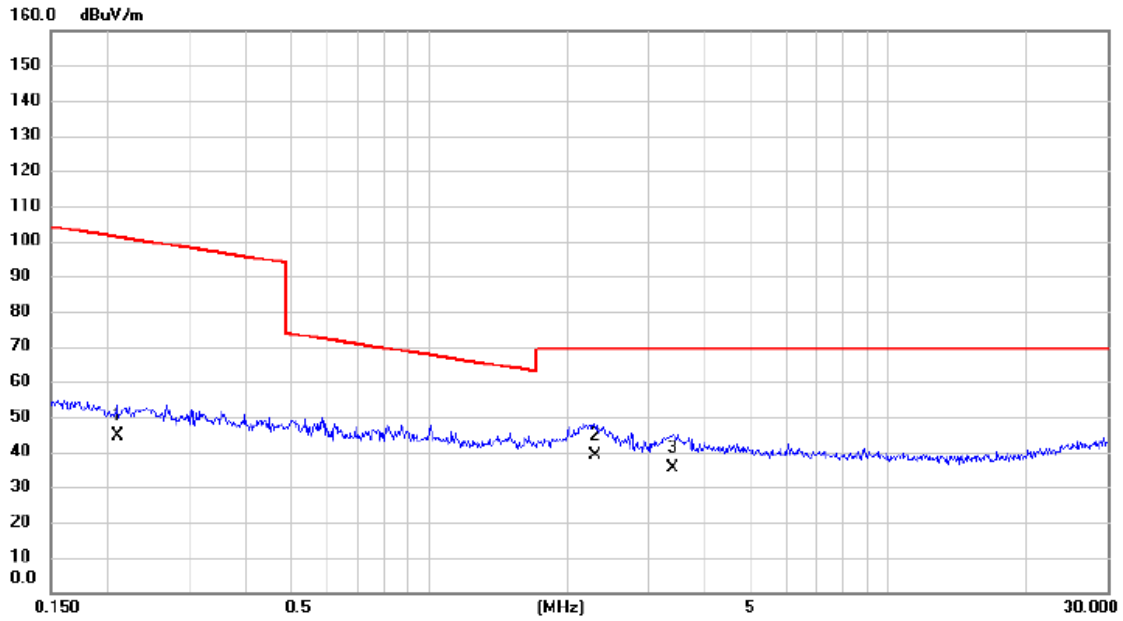

No.	Mk.	Freq. MHz	Reading Level dBuV	Correct Factor dB	Measure- ment dBuV/m	Limit dBuV/m	Margin dB	Detector	Comment
1		0.209	32.52	11.94	44.46	101.19	-56.73	AVG	
2	*	2.297	27.46	11.42	38.88	69.54	-30.66	QP	
3		3.399	24.35	11.16	35.51	69.54	-34.03	QP	

Test Mode: TX Mode

Ant 90°

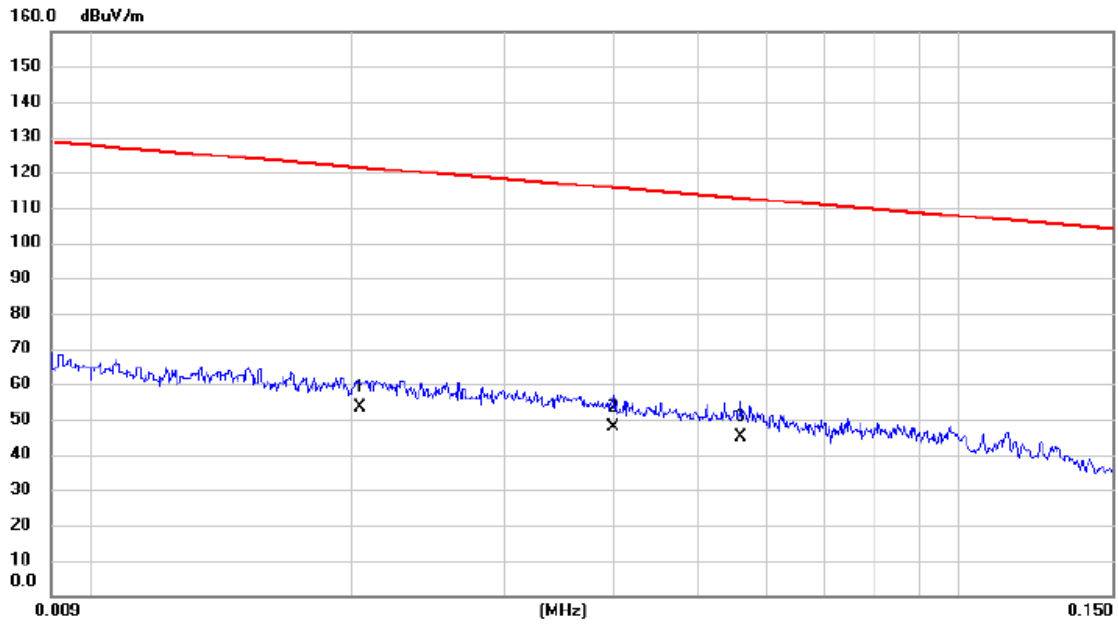

No.	Mk.	Freq. MHz	Reading Level dBuV	Correct Factor dB	Measure- ment dBuV/m	Limit dBuV/m	Margin dB	Detector	Comment
1		0.020	35.66	17.64	53.30	121.41	-68.11	AVG	
2		0.040	33.78	14.00	47.78	115.56	-67.78	AVG	
3	*	0.056	32.20	12.89	45.09	112.64	-67.55	AVG	

Test Mode: TX Mode

Ant 90°

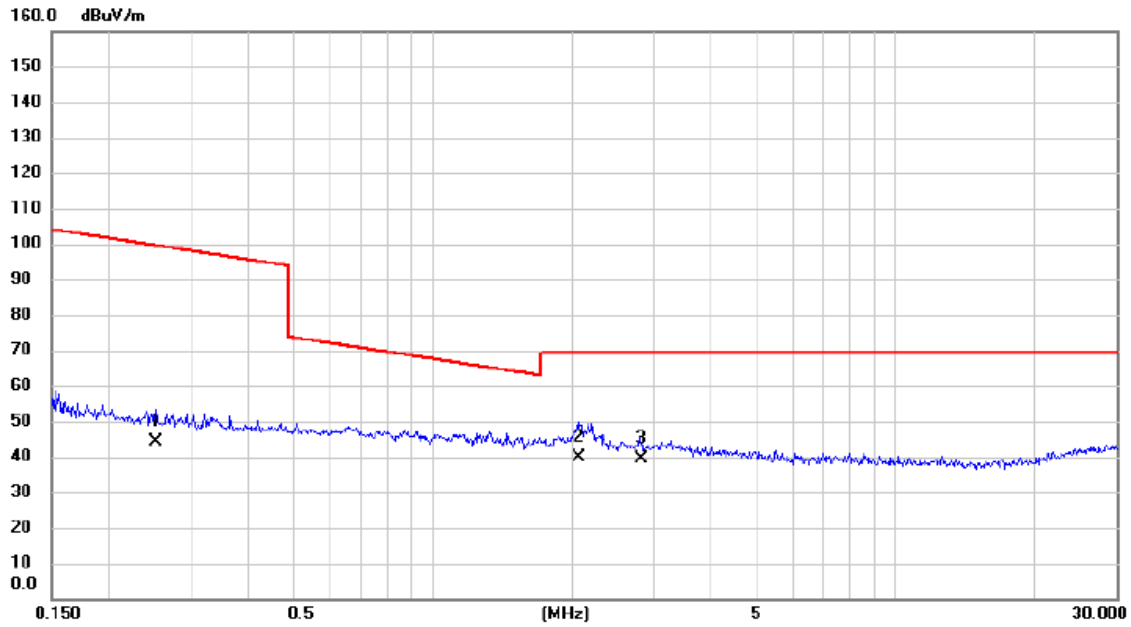

No.	Mk.	Freq. MHz	Reading Level dBuV	Correct Factor dB	Measure- ment dBuV/m	Limit dBuV/m	Margin dB	Detector	Comment
1		0.252	32.37	11.87	44.24	99.58	-55.34	AVG	
2	*	2.077	28.11	11.52	39.63	69.54	-29.91	QP	
3		2.824	28.05	11.18	39.23	69.54	-30.31	QP	

Test Mode: WCDMA Band 4_TX CH1312

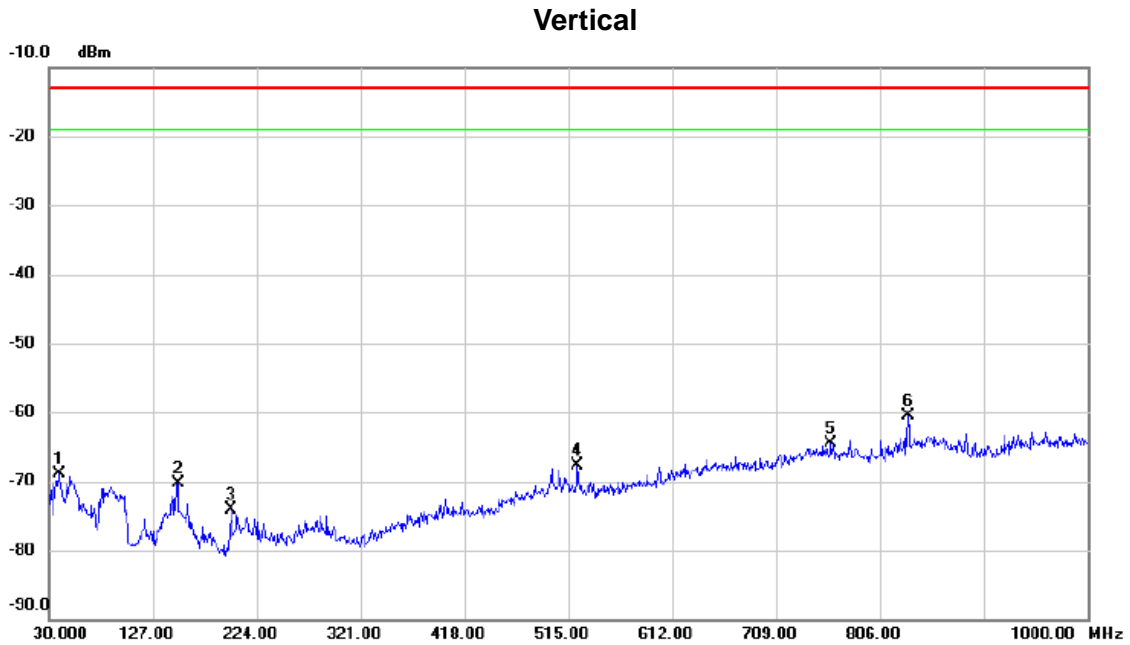

No.	Mk.	Freq. MHz	Reading Level dBm	Correct Factor dB	Measure- ment dBm	Limit dBm	Margin dB	Detector	Comment
1		39.700	-60.05	-8.93	-68.98	-13.00	-55.98	peak	
2		150.280	-70.19	-0.04	-70.23	-13.00	-57.23	peak	
3		199.750	-69.97	-4.13	-74.10	-13.00	-61.10	peak	
4		523.730	-72.44	4.65	-67.79	-13.00	-54.79	peak	
5		760.410	-73.34	8.85	-64.49	-13.00	-51.49	peak	
6	*	832.190	-70.98	10.46	-60.52	-13.00	-47.52	peak	

Test Mode: WCDMA Band 4_TX CH1312

Horizontal

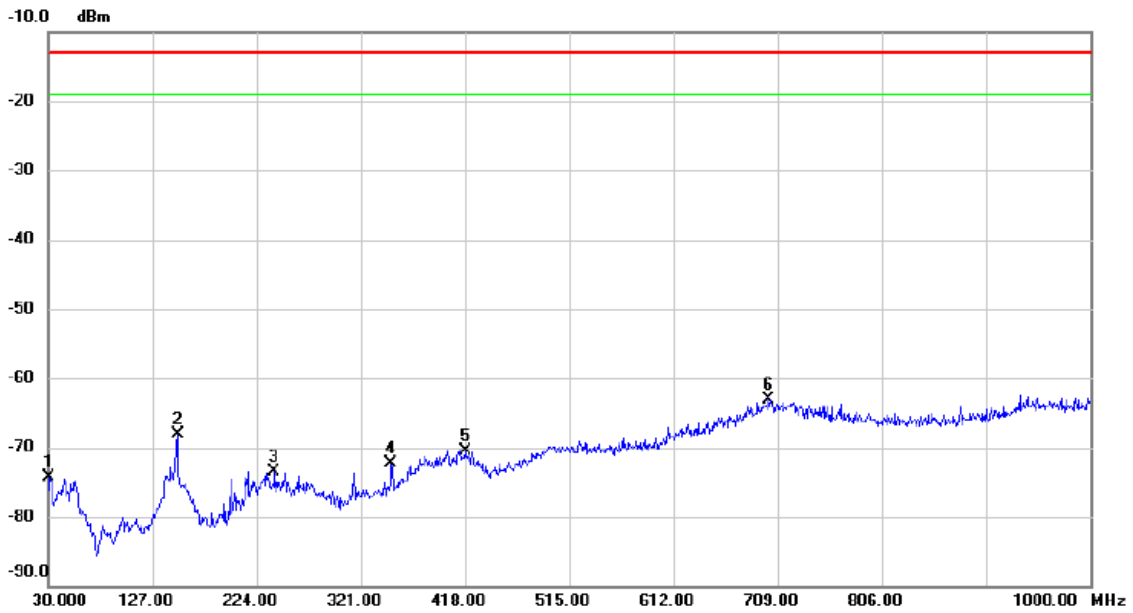

No.	Mk.	Freq. MHz	Reading Level dBm	Correct Factor dB	Measure- ment dBm	Limit dBm	Margin dB	Detector	Comment
1		30.970	-71.54	-2.77	-74.31	-13.00	-61.31	peak	
2		150.280	-68.08	-0.04	-68.12	-13.00	-55.12	peak	
3		240.490	-70.12	-3.35	-73.47	-13.00	-60.47	peak	
4		349.130	-73.18	0.87	-72.31	-13.00	-59.31	peak	
5		418.000	-74.07	3.58	-70.49	-13.00	-57.49	peak	
6	*	700.270	-70.44	7.44	-63.00	-13.00	-50.00	peak	

Test Mode: WCDMA Band 4_TX CH1312

Vertical

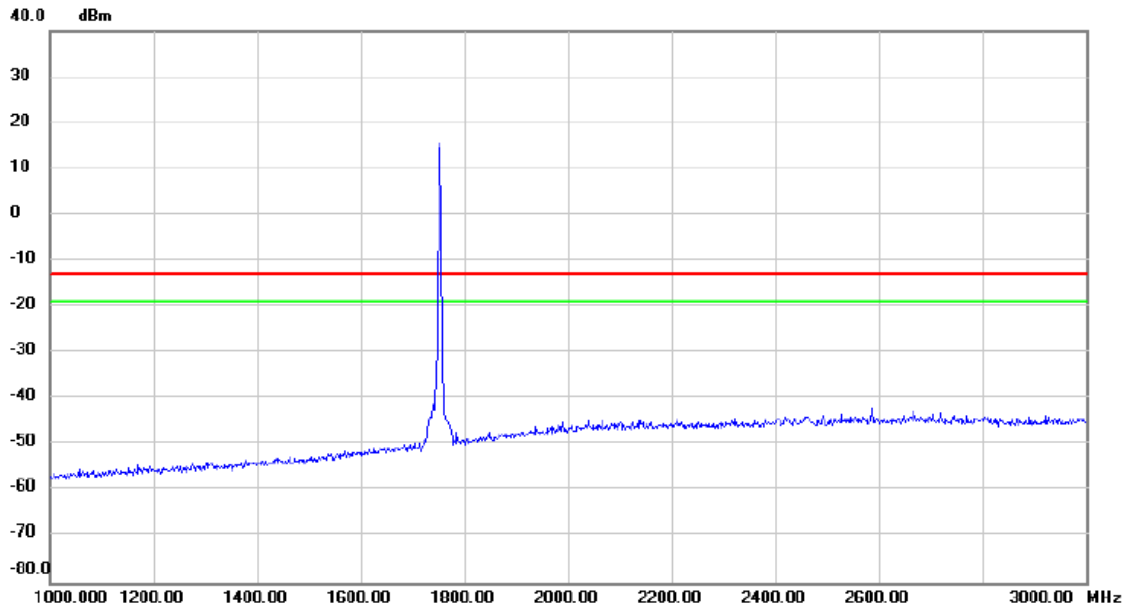

No.	Mk.	Freq.	Reading Level	Correct Factor	Measurement	Limit	Margin	Detector	Comment
		MHz	dBm	dB	dBm	dBm	dB		
		1880.000	15.0	0.0	15.0	-15.0	30.0		

Test Mode: WCDMA Band 4_TX CH1312

Horizontal

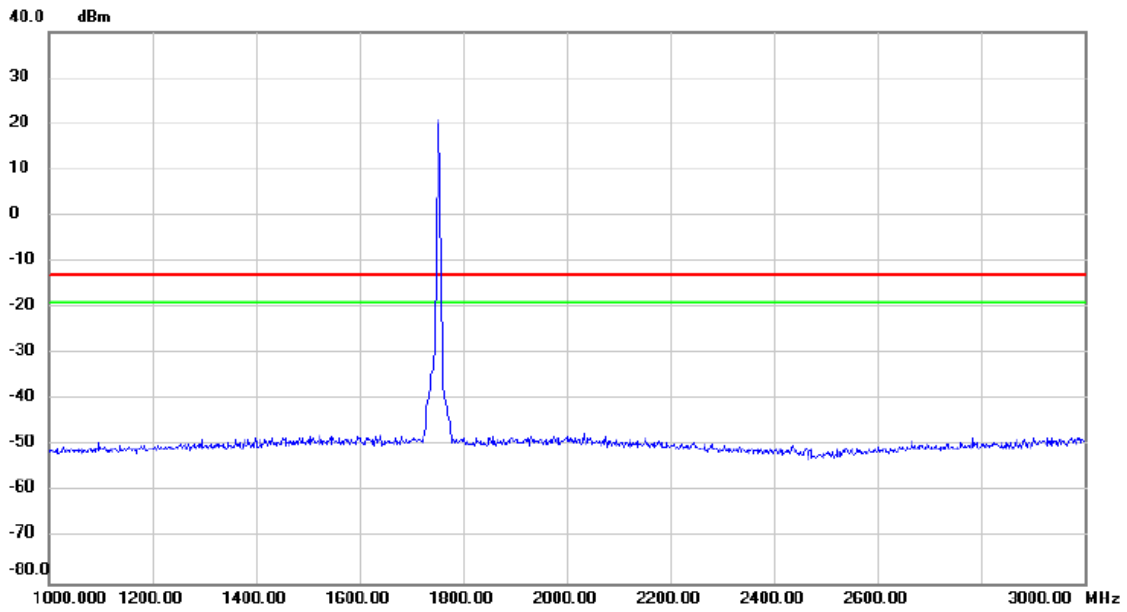

No.	Mk.	Freq.	Reading Level	Correct Factor	Measurement	Limit	Margin	Detector	Comment
		MHz	dBm	dB	dBm	dBm	dB		
		1880.00	20.00	0.00	20.00	-15.00	5.00		

Test Mode: WCDMA Band 4_TX CH1312

Vertical

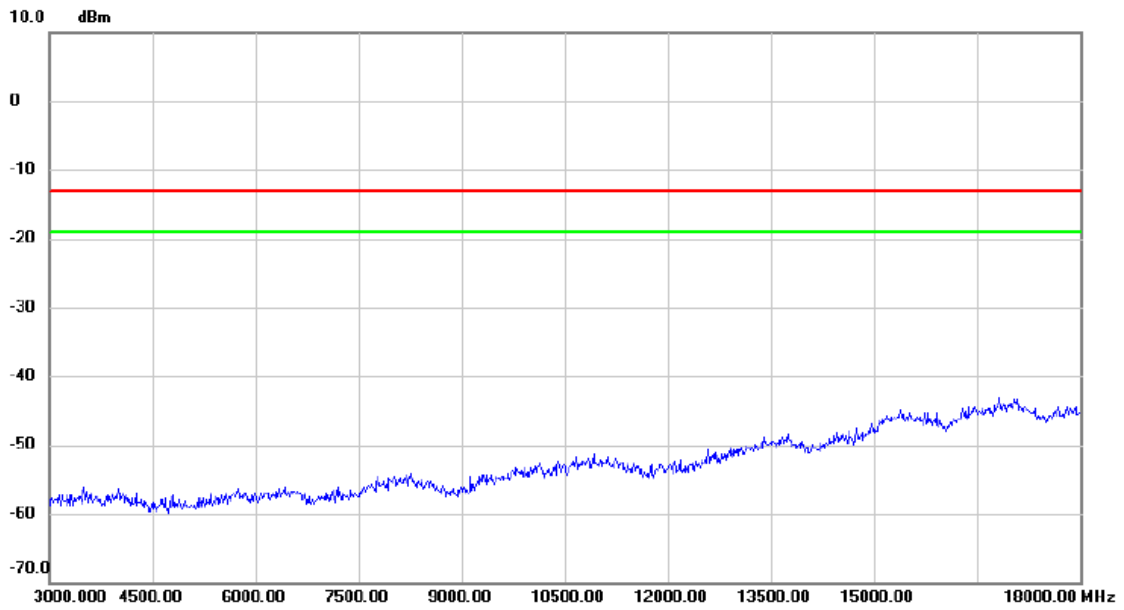

No.	Mk.	Freq. MHz	Reading Level dBm	Correct Factor dB	Measure- ment dBm	Limit dBm	Margin dB	Detector	Comment
-----	-----	--------------	-------------------------	-------------------------	-------------------------	--------------	--------------	----------	---------

Test Mode: WCDMA Band 4_TX CH1312

Horizontal

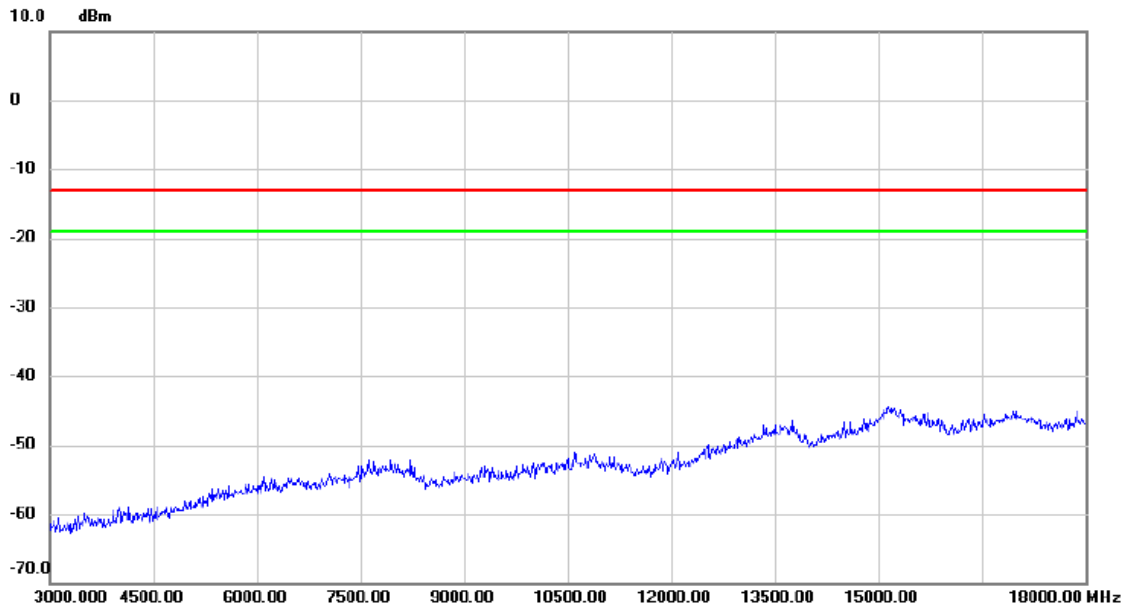

No.	Mk.	Freq.	Reading Level	Correct Factor	Measurement	Limit	Margin	Detector	Comment
		MHz	dBm	dB	dBm	dBm	dB		

Test Mode: WCDMA Band 4_TX CH1312

Vertical

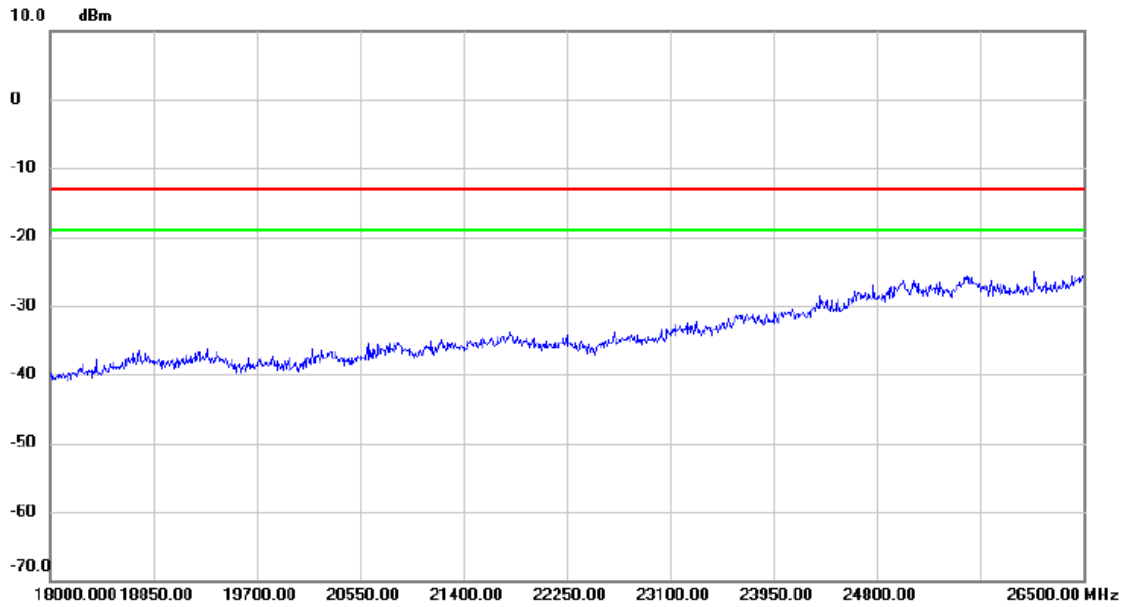

No.	Mk.	Freq.	Reading Level	Correct Factor	Measurement	Limit	Margin	Detector	Comment
		MHz	dBm	dB	dBm	dBm	dB		

Test Mode: WCDMA Band 4_TX CH1312

Horizontal

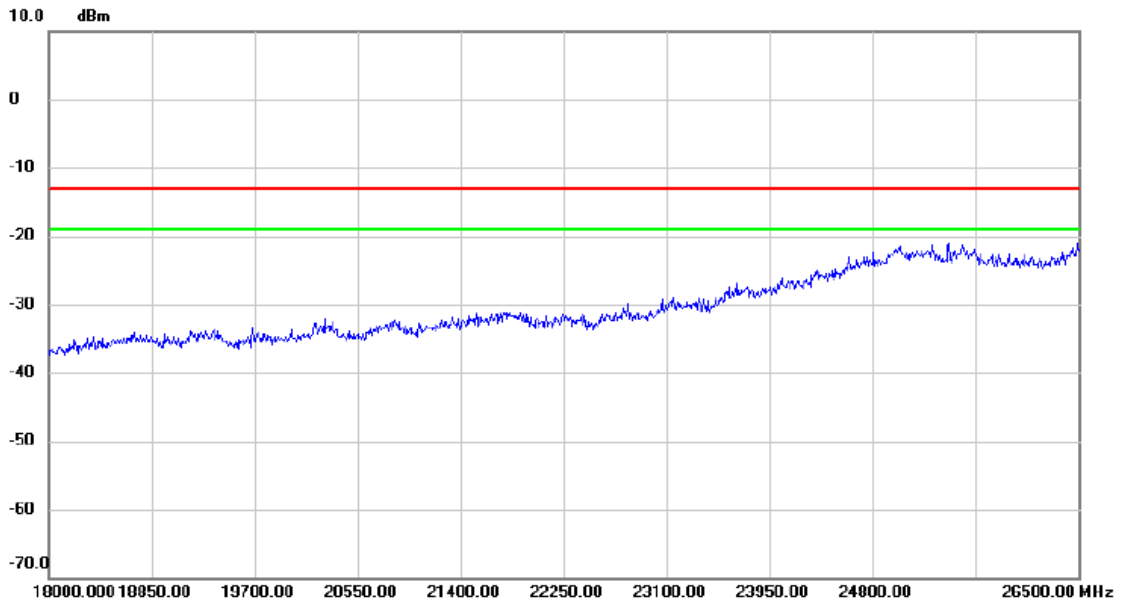

No.	Mk.	Freq.	Reading Level	Correct Factor	Measurement	Limit	Margin	Detector	Comment
		MHz	dBm	dB	dBm	dBm	dB		

Test Mode: WCDMA Band 4_TX CH1312_ HSDPA

Vertical

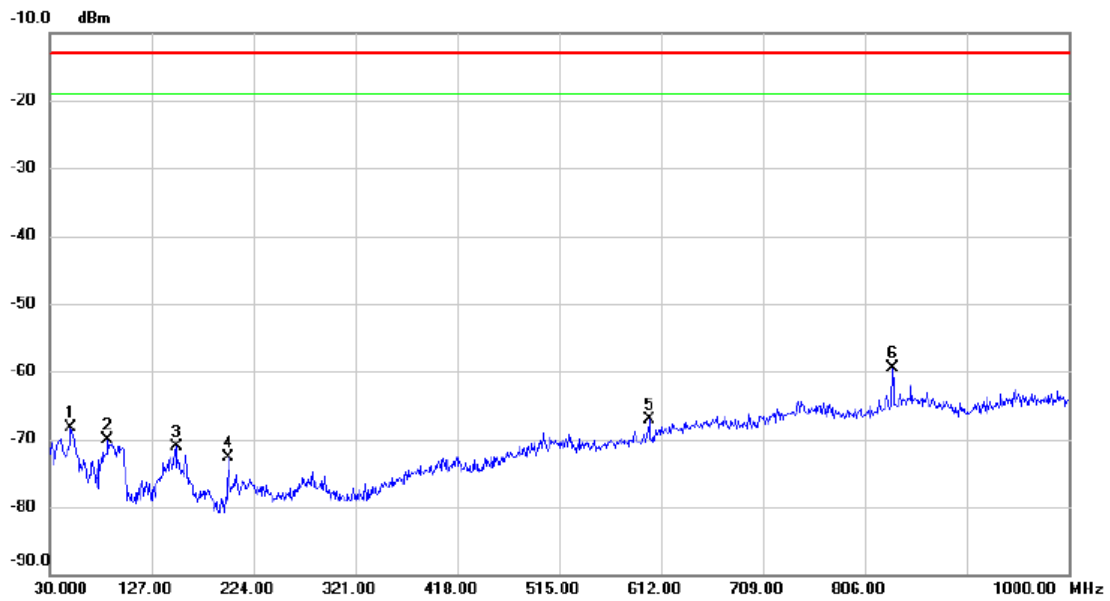

No.	Mk.	Freq. MHz	Reading Level dBm	Correct Factor dB	Measure- ment dBm	Limit dBm	Margin dB	Detector	Comment
1		50.370	-63.89	-4.49	-68.38	-13.00	-55.38	peak	
2		85.290	-68.24	-1.94	-70.18	-13.00	-57.18	peak	
3		150.280	-71.03	-0.04	-71.07	-13.00	-58.07	peak	
4		199.750	-68.50	-4.13	-72.63	-13.00	-59.63	peak	
5		600.360	-73.16	6.04	-67.12	-13.00	-54.12	peak	
6 *		832.190	-70.04	10.46	-59.58	-13.00	-46.58	peak	

Test Mode: WCDMA Band 4_TX CH1312_ HSDPA

Horizontal

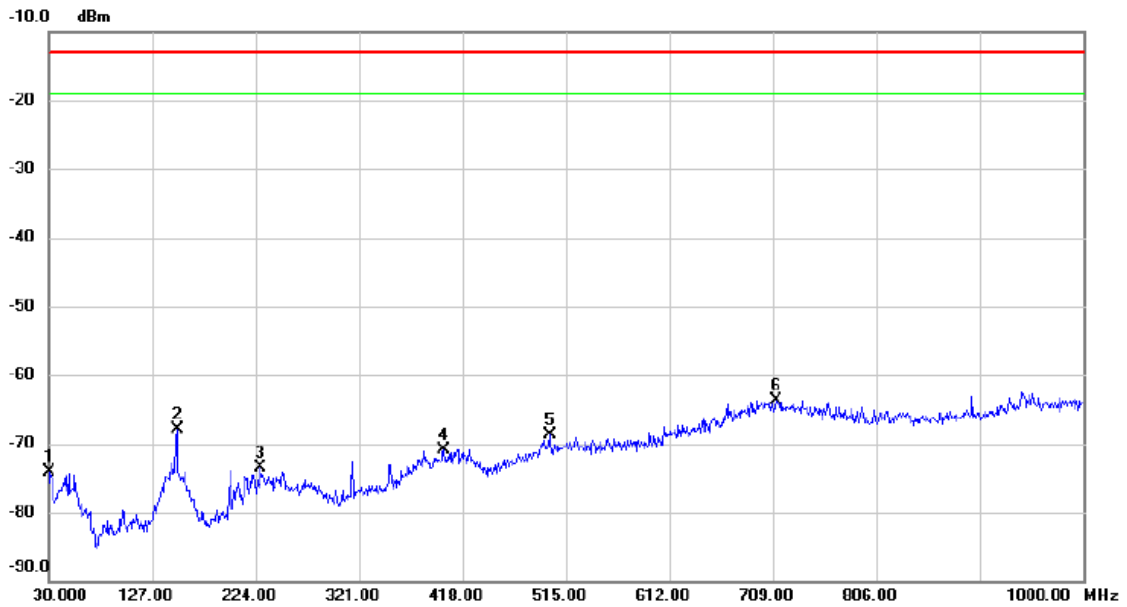

No.	Mk.	Freq. MHz	Reading Level dBm	Correct Factor dB	Measure- ment dBm	Limit dBm	Margin dB	Detector	Comment
1		30.970	-71.33	-2.77	-74.10	-13.00	-61.10	peak	
2		150.280	-67.78	-0.04	-67.82	-13.00	-54.82	peak	
3		228.850	-69.54	-3.99	-73.53	-13.00	-60.53	peak	
4		400.540	-74.17	3.36	-70.81	-13.00	-57.81	peak	
5		499.480	-73.21	4.52	-68.69	-13.00	-55.69	peak	
6	*	711.910	-71.32	7.69	-63.63	-13.00	-50.63	peak	

Test Mode: WCDMA Band 4_TX CH1312_ HSDPA

Vertical

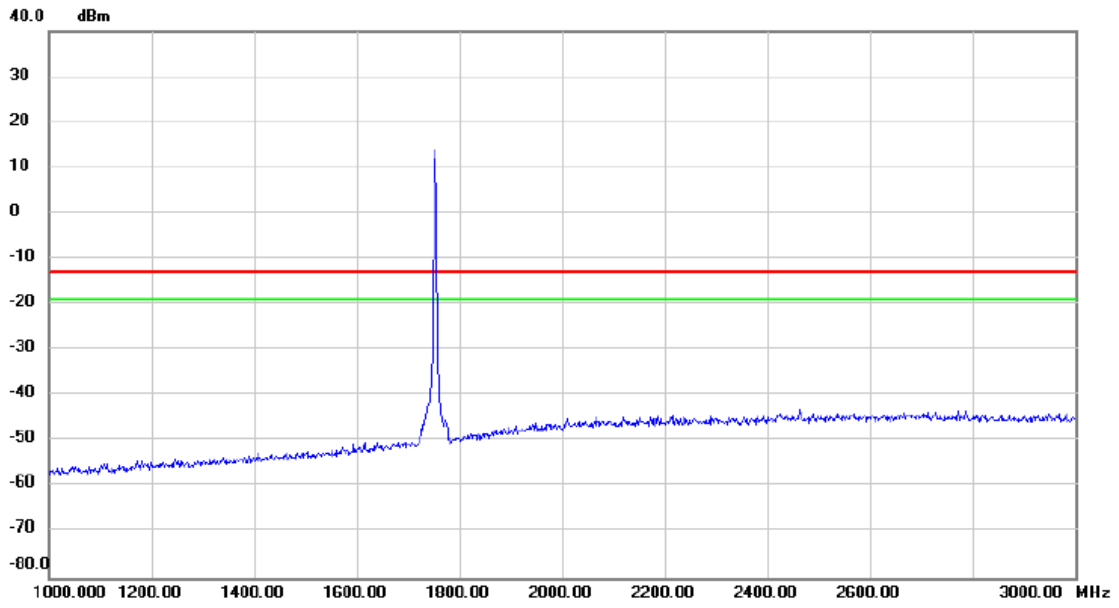

No.	Mk.	Freq.	Reading Level	Correct Factor	Measurement	Limit	Margin	Detector	Comment
		MHz	dBm	dB	dBm	dBm	dB		
		1880.00	15.00		15.00	-15.00	30.00		

Test Mode: WCDMA Band 4_TX CH1312_ HSDPA

Horizontal

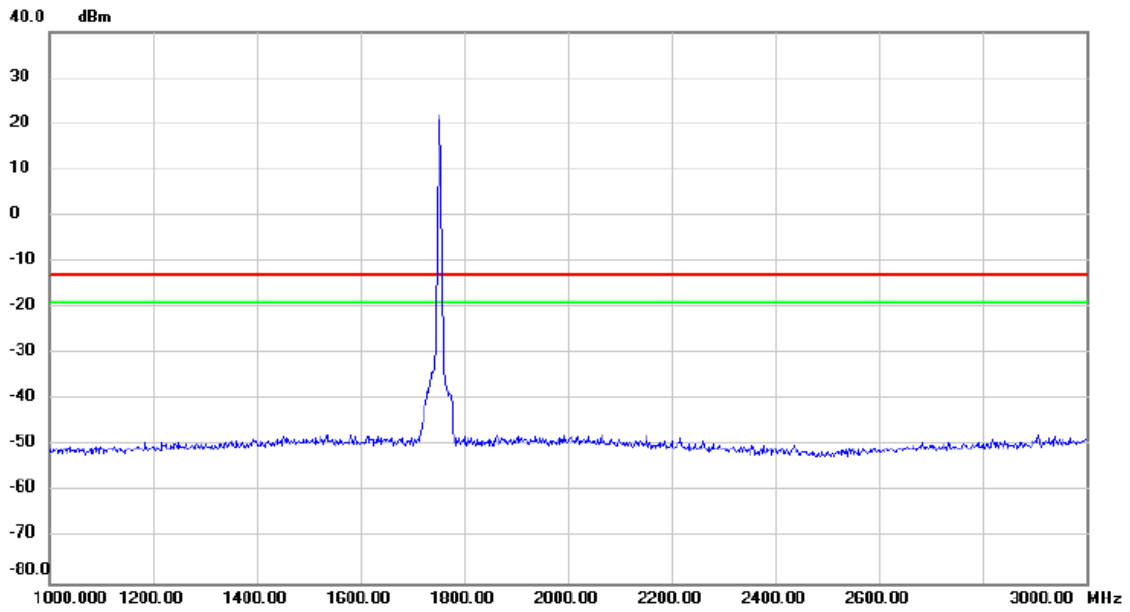

No. Mk.	Freq.	Reading Level	Correct Factor	Measurement	Limit	Margin	Detector	Comment
	MHz	dBm	dB	dBm	dBm	dB		
	1875.00	20.00	0.00	20.00	-12.00	32.00		

Test Mode: WCDMA Band 4_TX CH1312_ HSDPA

Vertical

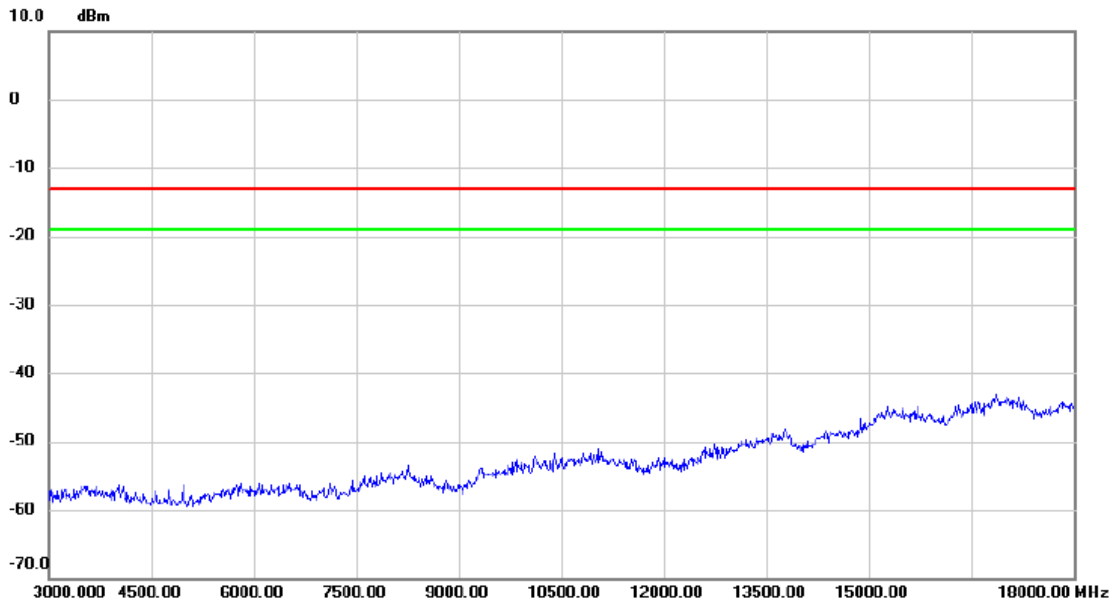

No.	Mk.	Freq.	Reading Level	Correct Factor	Measurement	Limit	Margin	Detector	Comment
		MHz	dBm	dB	dBm	dBm	dB		

Test Mode: WCDMA Band 4_TX CH1312_ HSDPA

Horizontal

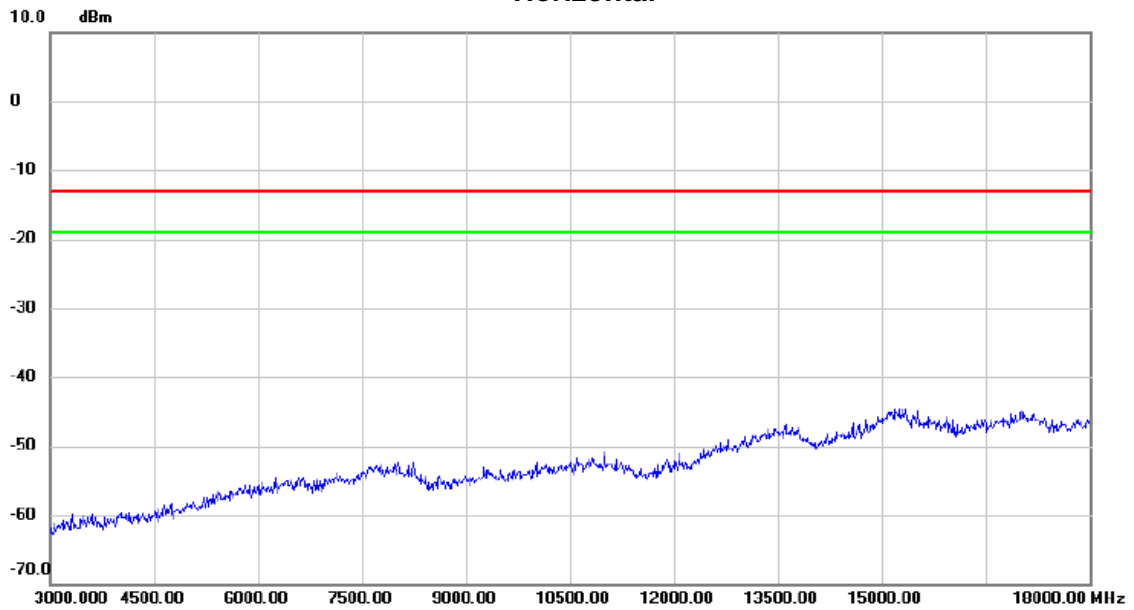

No.	Mk.	Freq.	Reading Level	Correct Factor	Measurement	Limit	Margin	Detector	Comment
		MHz	dBm	dB	dBm	dBm	dB		

Test Mode: WCDMA Band 4_TX CH1312_ HSDPA

Vertical

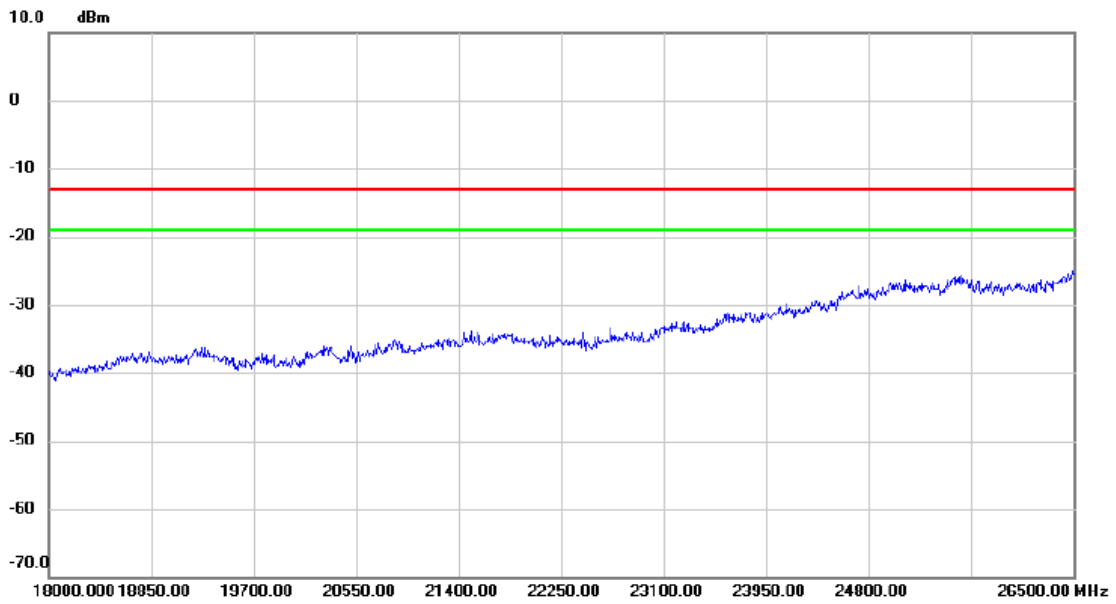

No.	Mk.	Freq. MHz	Reading Level dBm	Correct Factor dB	Measure- ment dBm	Limit dBm	Margin dB	Detector	Comment
-----	-----	--------------	-------------------------	-------------------------	-------------------------	--------------	--------------	----------	---------

Test Mode: WCDMA Band 4_TX CH1312_ HSDPA

Horizontal

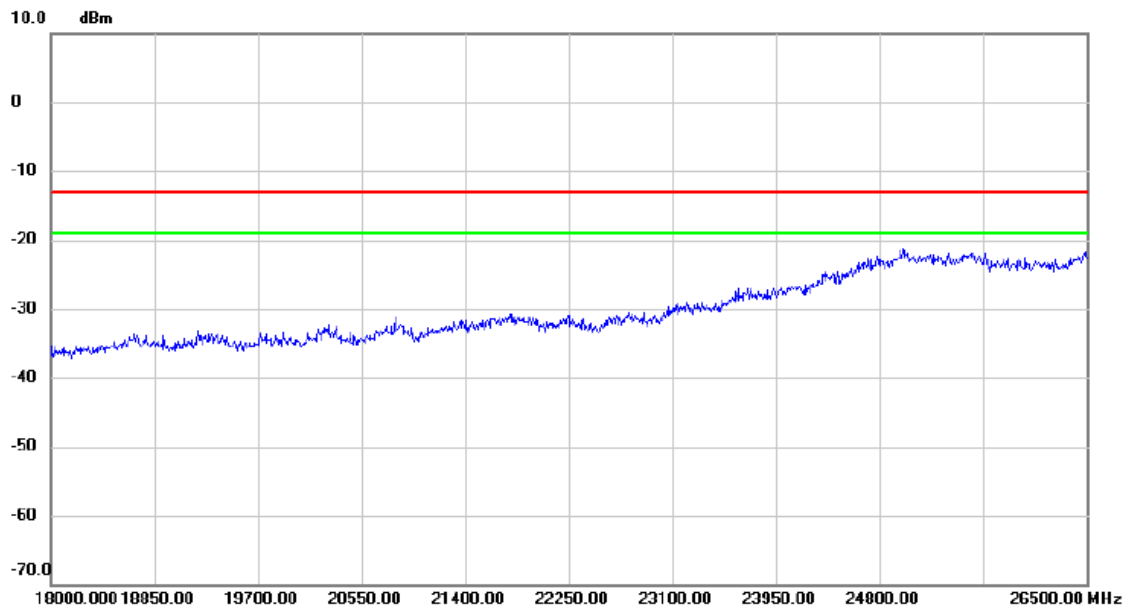

No.	Mk.	Freq.	Reading Level	Correct Factor	Measurement	Limit	Margin	Detector	Comment
		MHz	dBm	dB	dBm	dBm	dB		
		18000.000	-35		-35	-15	-20		
		18950.00	-35		-35	-15	-20		
		19700.00	-35		-35	-15	-20		
		20550.00	-35		-35	-15	-20		
		21400.00	-35		-35	-15	-20		
		22250.00	-35		-35	-15	-20		
		23100.00	-35		-35	-15	-20		
		23950.00	-30		-30	-15	-20		
		24800.00	-25		-25	-15	-20		
		26500.00	-25		-25	-15	-20		

Test Mode: WCDMA Band 4_TX CH1312_HSUPA

Vertical

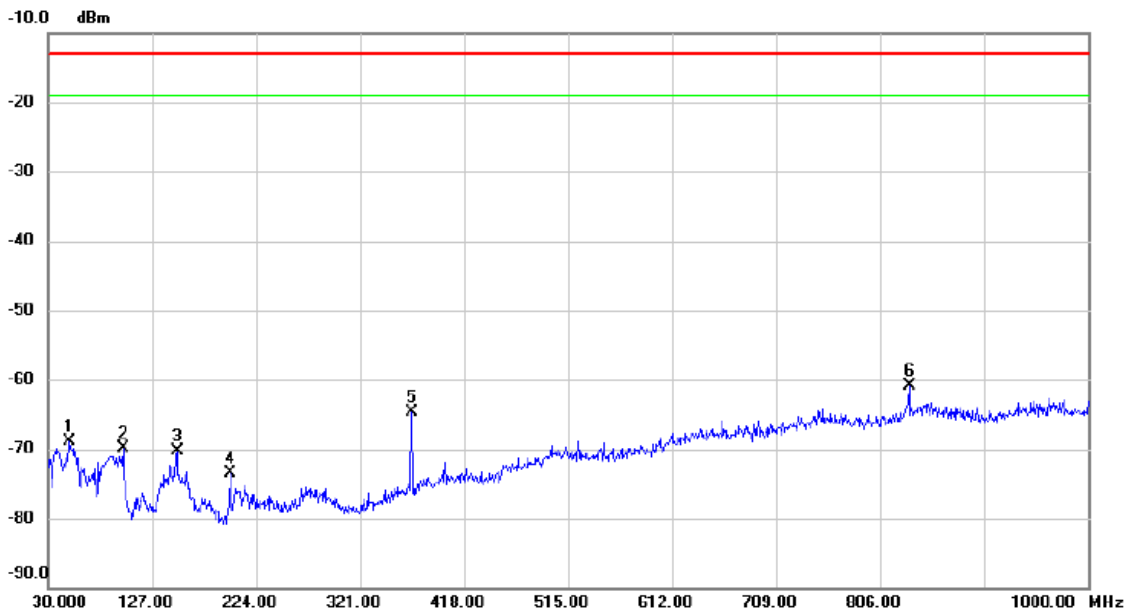

No.	Mk.	Freq. MHz	Reading Level dBm	Correct Factor dB	Measure- ment dBm	Limit dBm	Margin dB	Detector	Comment
1		50.370	-64.32	-4.49	-68.81	-13.00	-55.81	peak	
2		99.840	-66.90	-3.08	-69.98	-13.00	-56.98	peak	
3		150.280	-70.23	-0.04	-70.27	-13.00	-57.27	peak	
4		199.750	-69.33	-4.13	-73.46	-13.00	-60.46	peak	
5		369.500	-66.60	1.86	-64.74	-13.00	-51.74	peak	
6	*	833.160	-71.34	10.47	-60.87	-13.00	-47.87	peak	

Test Mode: WCDMA Band 4_TX CH1312_HSUPA

Horizontal

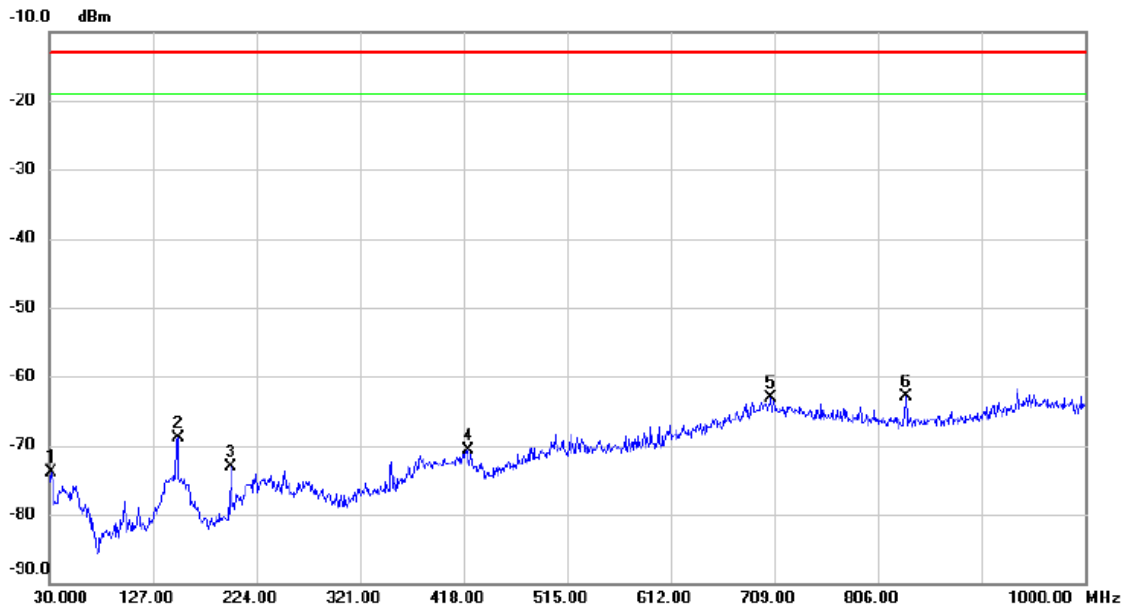

No.	Mk.	Freq. MHz	Reading Level dBm	Correct Factor dB	Measure- ment dBm	Limit dBm	Margin dB	Detector	Comment
1		31.940	-70.32	-3.65	-73.97	-13.00	-60.97	peak	
2		150.280	-68.77	-0.04	-68.81	-13.00	-55.81	peak	
3		199.750	-68.91	-4.13	-73.04	-13.00	-60.04	peak	
4		421.880	-74.41	3.63	-70.78	-13.00	-57.78	peak	
5		706.090	-70.64	7.56	-63.08	-13.00	-50.08	peak	
6	*	832.190	-73.33	10.46	-62.87	-13.00	-49.87	peak	

Test Mode: WCDMA Band 4_TX CH1312_HSUPA

Vertical

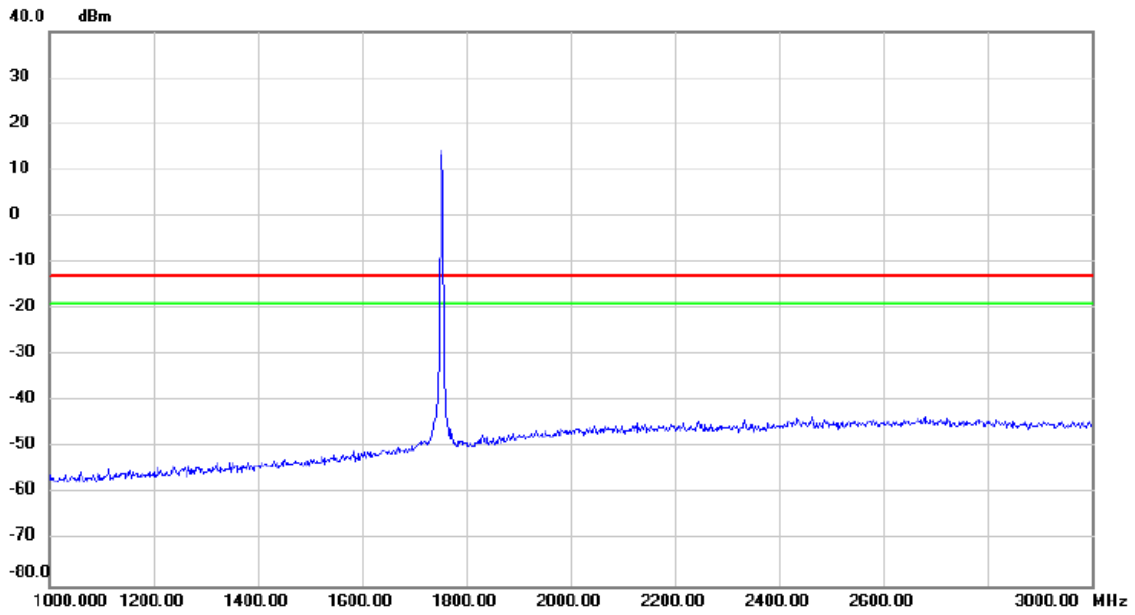

No.	Mk.	Freq.	Reading Level	Correct Factor	Measurement	Limit	Margin	Detector	Comment
		MHz	dBm	dB	dBm	dBm	dB		
		1875.00	15.00	0.00	15.00	-15.00	30.00		

Test Mode: WCDMA Band 4_TX CH1312_HSUPA

Horizontal

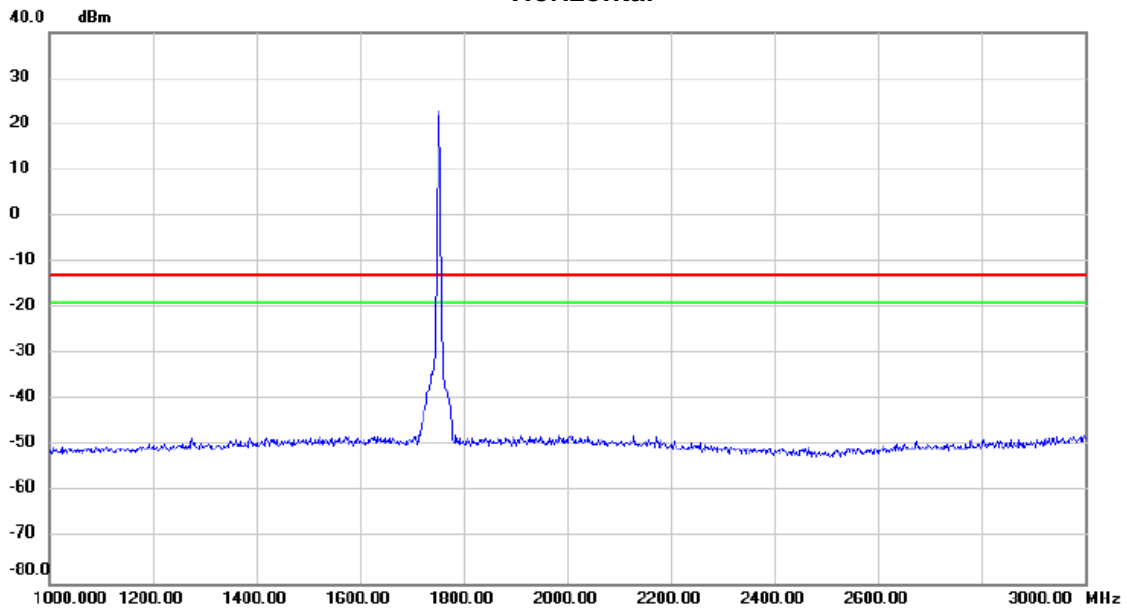

No.	Mk.	Freq.	Reading Level	Correct Factor	Measurement	Limit	Margin	Detector	Comment
		MHz	dBm	dB	dBm	dBm	dB		
		1800.000	22.0	0.0	22.0	-10.0	32.0		

Test Mode: WCDMA Band 4_TX CH1312_ HSUPA

Vertical

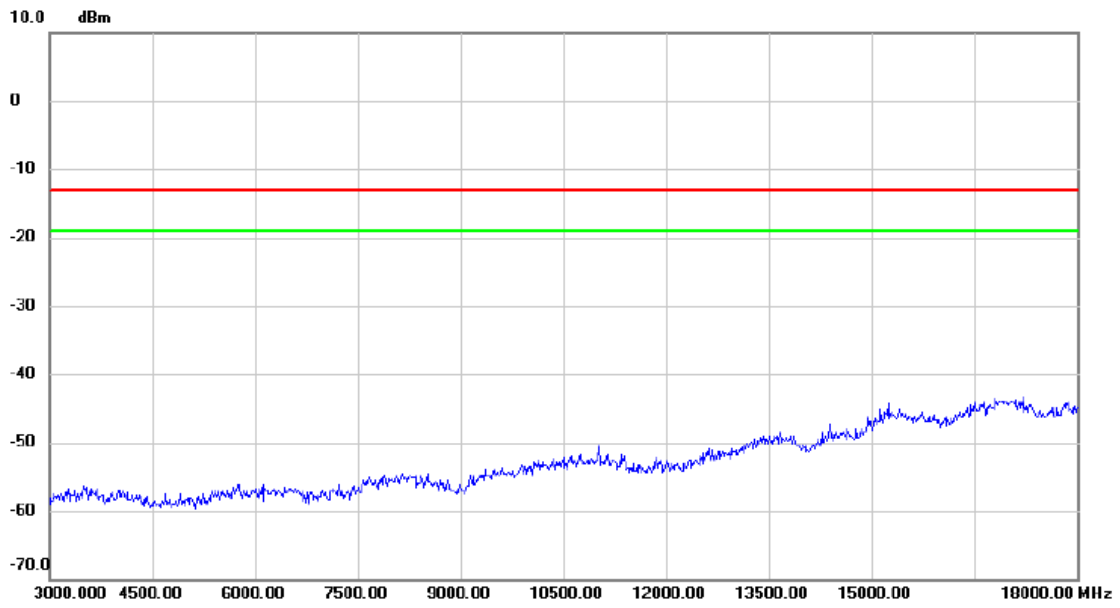

No.	Mk.	Freq.	Reading Level	Correct Factor	Measurement	Limit	Margin	Detector	Comment
		MHz	dBm	dB	dBm	dBm	dB		