

# FCC Radio Test Report

## FCC ID: QISMS2372H-517

This report concerns (check one): Original Grant Class II Change

**Project No.** : 1708C331  
**Equipment** : LTE USB Stick  
**Model Name** : MS2372h-517  
**Applicant** : Huawei Technologies Co., Ltd.  
**Address** : Administration Building, Headquarters of Huawei Technologies Co., Ltd., Bantian, Longgang District, Shenzhen, 518129, P.R.C

**Date of Receipt** : Aug. 30, 2017  
**Date of Test** : Aug. 30, 2017 ~ Sep. 22, 2017  
**Issued Date** : Sep. 25, 2017  
**Tested by** : BTL Inc.

**Technical Engineer** :   
(Kenji Lin)

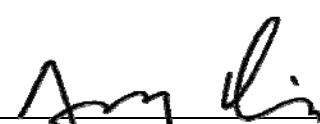
**Authorized Signatory** :   
(Andy Chiu)

# B T L I N C .

No. 68-1, Ln. 169, Sec.2, Datong Rd., Xizhi Dist., New Taipei City  
221, Taiwan

TEL:+886-2-2657-3299 FAX: +886-2- 2657-3331



### **Declaration**

**BTL** represents to the client that testing is done in accordance with standard procedures as applicable and that test instruments used has been calibrated with standards traceable to international standard(s) and/or national standard(s).

**BTL's** reports apply only to the specific samples tested under conditions. It is manufacture's responsibility to ensure that additional production units of this model are manufactured with the identical electrical and mechanical components. **BTL** shall have no liability for any declarations, inferences or generalizations drawn by the client or others from **BTL** issued reports.

**BTL's** report must not be used by the client to claim product certification, approval, or endorsement by NVLAP, NIST, or any agency of the Federal Government.

This report is the confidential property of the client. As a mutual protection to the clients, the public and **BTL-self**, extracts from the test report shall not be reproduced except in full with **BTL's** authorized written approval.

**BTL's** laboratory quality assurance procedures are in compliance with the **ISO Guide17025** requirements, and accredited by the conformity assessment authorities listed in this test report.

### **Limitation**

For the use of the authority's logo is limited unless the Test Standard(s)/Scope(s)/Item(s) mentioned in this test report is (are) included in the conformity assessment authorities acceptance respective.

<b>Table of Contents</b>	<b>Page</b>
<b>REPORT ISSUED HISTORY</b>	<b>5</b>
<b>1 . CERTIFICATION</b>	<b>6</b>
<b>2 . SUMMARY OF TEST RESULTS</b>	<b>7</b>
2.1 TEST FACILITY	8
2.2 MEASUREMENT UNCERTAINTY	8
<b>3 . GENERAL INFORMATION</b>	<b>9</b>
3.1 GENERAL DESCRIPTION OF EUT	9
3.2 DESCRIPTION OF TEST MODES AND TEST CONDITION	11
3.3 BLOCKDIAGRAMSHOWINGTHECONFIGURATIONOFSYSTEMTESTED FOR RADIATED	13
3.4 DESCRIPTION OF SUPPORT UNITS	13
<b>4 . TEST RESULT</b>	<b>14</b>
4.1 OUTPUT POWER MEASUREMENT	14
4.1.1 LIMIT	14
4.1.2 TEST PROCEDURE	14
4.1.3 TESTSETUP LAYOUT	14
4.1.4 TEST DEVIATION	14
4.1.5 TEST RESULTS	14
4.2 OCCUPIED BANDWIDTH MEASUREMENT	15
4.2.1 TEST PROCEDURE	15
4.2.2 TEST SETUP LAYOUT	15
4.2.3 TEST DEVIATION	15
4.2.4 TEST RESULTS	15
4.3 CONDUCTED EMISSIONS MEASUREMENT	16
4.3.1 LIMIT	16
4.3.2 TEST PROCEDURES	16
4.3.3 TESTSETUP LAYOUT	16
4.3.4 TESTDEVIATION	16
4.3.5 TEST RESULTS	16
4.4 RADIATED EMISSIONS MEASUREMENT	17
4.4.1 LIMIT	17
4.4.2 TEST PROCEDURES	17
4.4.3 TESTSETUP LAYOUT	17
4.4.4 TESTDEVIATION	17
4.4.5 TEST RESULTS	17
4.5 BAND EDGE MEASUREMENT	18
4.5.1 LIMIT	18

<b>Table of Contents</b>	<b>Page</b>
4.5.2 TEST PROCEDURES	18
4.5.3 TESTSETUP LAYOUT	18
4.5.4 TESTDEVIATION	18
4.5.5 TEST RESULTS	18
4.6 PEAK TO AVERAGE RATIO MEASUREMENT	19
4.6.1 LIMIT	19
4.6.2 TEST PROCEDURES	19
4.6.3 TESTSETUP LAYOUT	19
4.6.4 TESTDEVIATION	19
4.6.5 TEST RESULTS	19
4.7 FREQUENCY STABILITY MEASUREMENT	20
4.7.1 LIMIT	20
4.7.2 TEST PROCEDURES	20
4.7.3 TESTSETUP LAYOUT	20
4.7.4 TESTDEVIATION	20
4.7.5 TEST RESULTS	20
5. LIST OF MEASUREMENT EQUIPMENTS	21
ATTACHMENT A - OUTPUT POWER	22
ATTACHMENT B - OCCUPIED BANDWIDTH	29
ATTACHMENT C - CONDUCTED EMISSIONS	43
ATTACHMENT D - RADIATED EMISSION	52
ATTACHMENT E - BAND EDGE	109
ATTACHMENT F - PEAK TO AVERAGE RATIO	116
ATTACHMENT G - FREQUENCY STABILITY	125

### REPORT ISSUED HISTORY

Issued No.	Description	Issued Date
BTL-FCCP-2-1708C331	Original Issue.	Sep. 25, 2017

## 1. CERTIFICATION

Equipment : LTE USB Stick  
Brand Name : HUAWEI  
Model Name : MS2372h-517  
Applicant : Huawei Technologies Co.,Ltd.  
Manufacturer : Huawei Technologies Co.,Ltd.  
Address : Administration Building, Huawei Base, Bantian, Longgang District ,Shenzhen  
518129, P.R.China  
Factory : Huawei Technologies Co.,Ltd.  
Address : Administration Building, Huawei Base, Bantian, Longgang District ,Shenzhen  
518129, P.R.China  
Date of Test : Aug. 30, 2017 ~ Sep. 22, 2017  
Test Sample : Engineering Sample  
Standard(s) : 47 CFR FCC Part 24 Subpart E  
47 CFR FCC Part 2  
ANSI/TIA-603-D-2010  
KDB 971168 D01 Power Meas License Digital Systems v02r02

The above equipment has been tested and found compliance with the requirement of the relative standards by BTL Inc.

The test data, data evaluation, and equipment configuration contained in our test report (Ref No. BTL-FCCP-2-1708C331) were obtained utilizing the test procedures, test instruments, test sites that has been accredited by the Authority of TAF according to the ISO-17025 quality assessment standard and technical standard(s).

**Test results included in this report is only for the DCS1900, WCDMA Band 2 and LTE Band 2 part.**

## 2. SUMMARY OF TEST RESULTS

Test procedures according to the technical standard(s):

FCC Part 24 Subpart H& Part 2			
Standard(s) Section	Test Item	Judgment	Tested By
2.1046 24.232(c)	Radiated power	PASS	Paul Li
2.1046 24.232(c)	Conducted Output Power	PASS	Paul Li
2.1049 24.238(a)	Occupied Bandwidth	PASS	Paul Li
2.1051 24.238(a)	Conducted Spurious Emissions	PASS	Paul Li
2.1053 24.238(a)	Radiated Spurious Emissions	PASS	Paul Li
24.238(a)	Band Edge Measurements	PASS	Paul Li
24.232(d)	Peak To Average Ratio	PASS	Paul Li
2.1055 24.235	Frequency Stability	PASS	Paul Li

NOTE:

(1) "N/A" denotes test is not applicable to this device.

## 2.1 TEST FACILITY

The test facilities used to collect the test data in this report:

### Radiated emissions Test (Below 1 GHz):

**CB15:** (FCC RN:674415; FCC DN:TW0659)

No. 68-1, Ln. 169, Sec.2, Datong Rd., Xizhi Dist., New Taipei City 221, Taiwan

### Radiated emissions Test (Above 1 GHz):

**CB15:** (FCC RN:674415; FCC DN:TW0659)

No. 68-1, Ln. 169, Sec.2, Datong Rd., Xizhi Dist., New Taipei City 221, Taiwan

### Conducted Test:

**TR01:** (FCC RN:674415; FCC DN:TW0659)

No. 68-1, Ln. 169, Sec.2, Datong Rd., Xizhi Dist., New Taipei City 221, Taiwan

## 2.2 MEASUREMENT UNCERTAINTY

Where relevant, the following measurement uncertainty levels have been estimated for tests performed on the EUT as specified in CISPR 16-4-2. The BTL measurement uncertainty is less than the CISPR 16-4-2  $U_{cispr}$  requirement.

The reported uncertainty of measurement  $y \pm U$ , where expanded uncertainty  $U$  is based on a standard uncertainty multiplied by a coverage factor of  $k=2$ , providing a level of confidence of approximately **95%**.

### A. Radiated Measurement :

Test Site	Method	Measurement Frequency Range	Ant. H / V	U,(dB)
DG-CB03 (3m)	CISPR	9KHz ~ 30MHz	V	3.79
		9KHz ~ 30MHz	H	3.57
		30MHz ~ 200MHz	V	3.82
		30MHz ~ 200MHz	H	3.78
		200MHz ~ 1,000MHz	V	4.10
		200MHz ~ 1,000MHz	H	4.06

Test Site	Method	Measurement Frequency Range	Ant. H / V	U,(dB)
DG-CB03 (3m)	CISPR	1GHz ~ 18GHz	V	3.12
		1GHz ~ 18GHz	H	3.68

Test Site	Method	Measurement Frequency Range	Ant. H / V	U,(dB)
DG-CB03 (1m)	CISPR	18GHz ~ 40GHz	V	4.15
		18GHz ~ 40GHz	H	4.14

Note: Unless specifically mentioned, the uncertainty of measurement has not been taken into account to declare the compliance or non-compliance to the specification.



### 3. GENERAL INFORMATION

#### 3.1 GENERAL DESCRIPTION OF EUT

Equipment	LTE USB Stick			
Brand Name	HUAWEI			
Model Name	MS2372h-517			
Model Difference	N/A			
Modulation Type	GSM/GPRS	GMSK		
	EDGE	GMSK, 8PSK		
	WCDMA	Uplink: BPSK Downlink: QPSK		
	WCDMA(HSDPA/HSUPA/HSPA+)	16QAM		
	LTE	QPSK, 16QAM		
Operation Frequency	GSM /EDGE/GPRS	1850.2 ~ 1909.8 MHz		
	WCDMA Band 2	1852.4 ~ 1907.6 MHz		
	LTE 2 (Channel Bandwidth: 5MHz)	1852.5 ~ 1907.5 MHz		
	LTE 2 (Channel Bandwidth: 10MHz)	1855.0 ~ 1905.0 MHz		
	LTE 2 (Channel Bandwidth: 15MHz)	1857.5 ~ 1902.5 MHz		
	LTE 2 (Channel Bandwidth: 20MHz)	1860.0 ~ 1900.0 MHz		
Max. EIRP Power	GSM/GPRS	GMSK	30.48	dBm
	EDGE	8PSK	26.62	dBm
	WCDMA	BPSK	24.50	dBm
	WCDMA_HSDPA	16QAM	23.88	dBm
	WCDMA_HSUPA	16QAM	23.77	dBm
	LTE 2 (Channel Bandwidth: 5MHz)	QPSK	24.08	dBm
		16QAM	23.84	dBm
	LTE 2 (Channel Bandwidth: 10MHz)	QPSK	24.72	dBm
		16QAM	24.08	dBm
	LTE 2 (Channel Bandwidth: 15MHz)	QPSK	24.80	dBm
		16QAM	24.05	dBm
	LTE 2 (Channel Bandwidth: 20MHz)	QPSK	24.66	dBm
		16QAM	24.16	dBm
Antenna Type	Fixed Internal Antenna			
Antenna Gain	3.90 dBi(DCS1900),3.9 dBi(WCDMA BAND 2&LTE BAND 2)			
Hardware Version	21.328.01.03.00			
Software Version	CL1MS2372HM VER.B			
IMEI No.1	Radiated	866667030005580		
	Conducted	866667030005572		
Power Source	Supplied from AC/DC adapter.			
Power Rating	100-240V~ 5V/1.0A			

Note:

1. For a more detailed features description, please refer to the manufacturer's specifications or the user's manual.

### 3.2 DESCRIPTION OF TEST MODES AND TEST CONDITION

Following channel(s) was (were) selected for the final test as listed below:

GSM MODE			
Test Item	Available Channel	Tested Channel	Mode
EIRP	512 to 810	512, 661, 810	GSM, EDGE
Conducted Output Power	512 to 810	512, 661, 810	GSM, EDGE
Occupied Bandwidth	512 to 810	512, 661, 810	GSM, EDGE
Condcudeted Emission	512 to 810	661	GSM, EDGE
Radiated Emission	512 to 810	512	GSM, EDGE
Band Edge	512 to 810	512, 810	GSM, EDGE
Peak to Average Ratio	512 to 810	512, 661, 810	GSM, EDGE
Frequency Stability	512 to 810	661	GSM, EDGE

WCDMA MODE			
Test Item	Available Channel	Tested Channel	Mode
EIRP	9262 to 9538	9262, 9400, 9538	WCDMA, HSDPA, HSUPA
Conducted Output Power	9262 to 9538	9262, 9400, 9538	WCDMA, HSDPA, HSUPA
Condcudeted Emission	9262 to 9538	9400	WCDMA, HSDPA, HSUPA
Radiated Emission	9262 to 9538	9400	WCDMA, HSDPA, HSUPA
Band Edge	9262 to 9538	9262, 9538	WCDMA, HSDPA, HSUPA
Peak to Average Ratio	9262 to 9538	9262, 9400, 9538	WCDMA, HSDPA, HSUPA
Frequency Stability	9262 to 9538	9262	WCDMA, HSDPA, HSUPA

**Note:** This device was tested under all bandwidths, RB configurations and modulations. The worst case was found in **QPSK** modulation.

LTE BAND 2 MODE						
Test Item	Available Channel	Tested Channel	Channel Bandwidth	Modulation	Mode	
EIRP	18625 to 19175	18625, 18900, 19175	5MHz	QPSK, 16QAM	1 RB / 0 RB Offset	
	18650 to 19150	18650, 18900, 19150	10MHz	QPSK, 16QAM	1 RB / 0 RB Offset	
	18675 to 19125	18675, 18900, 19125	15MHz	QPSK, 16QAM	1 RB / 0 RB Offset	
	18700 to 19100	18700, 18900, 19100	20MHz	QPSK, 16QAM	1 RB / 0 RB Offset	
Occupied Bandwidth	18625 to 19175	18625, 18900, 19175	5MHz	QPSK, 16QAM	25 RB / 0 RB Offset	
	18650 to 19150	18650, 18900, 19150	10MHz	QPSK, 16QAM	50 RB / 0 RB Offset	
	18675 to 19125	18675, 18900, 19125	15MHz	QPSK, 16QAM	75 RB / 0 RB Offset	
	18700 to 19100	18700, 18900, 19100	20MHz	QPSK, 16QAM	100 RB / 0 RB Offset	
Conducted Emission	18625 to 19175	18900	5MHz	QPSK	1 RB / 0 RB Offset	
	18650 to 19150	18900	10MHz	QPSK	1 RB / 0 RB Offset	
	18675 to 19125	18900	15MHz	QPSK	1 RB / 0 RB Offset	
	18700 to 19100	18900	20MHz	QPSK	1 RB / 0 RB Offset	
Radiated Emission	18625 to 19175	19100	5MHz	QPSK	1 RB / 0 RB Offset	
	18700 to 19100	18900	20MHz	QPSK	1 RB / 0 RB Offset	
Band Edge	18625 to 19175	18625	5MHz	QPSK	1 RB / 0 RB Offset 25 RB / 0 RB Offset	
		19175	5MHz	QPSK	1 RB / 24 RB Offset 25 RB / 0 RB Offset	
	18650 to 19150	18650	10MHz	QPSK	1 RB / 0 RB Offset 50 RB / 0 RB Offset	
		19150	10MHz	QPSK	1 RB / 49 RB Offset 50 RB / 0 RB Offset	
	18675 to 19125	18675	15MHz	QPSK	1 RB / 0 RB Offset 75 RB / 0 RB Offset	
		19125	15MHz	QPSK	1 RB / 74 RB Offset 75 RB / 0 RB Offset	
	18700 to 19100	18700	20MHz	QPSK	1 RB / 0 RB Offset 100 RB / 0 RB Offset	
		19100	20MHz	QPSK	1 RB / 99 RB Offset 100 RB / 0 RB Offset	
	Peak To Average Ratio	18625 to 19175	18625, 18900, 19175	5MHz	QPSK, 16QAM	1 RB / 0 RB Offset
		18650 to 19150	18650, 18900, 19150	10MHz	QPSK, 16QAM	1 RB / 0 RB Offset
		18675 to 19125	18675, 18900, 19125	15MHz	QPSK, 16QAM	1 RB / 0 RB Offset
		18700 to 19100	18700, 18900, 19100	20MHz	QPSK, 16QAM	1 RB / 0 RB Offset
Frequency Stability	18625 to 19175	18900	5MHz	QPSK	1 RB / 0 RB Offset	
	18650 to 19150	18900	10MHz	QPSK	1 RB / 0 RB Offset	
	18675 to 19125	18900	15MHz	QPSK	1 RB / 0 RB Offset	
	18700 to 19100	18900	20MHz	QPSK	1 RB / 0 RB Offset	

**EUT TEST CONDITIONS:**

Test Item	Environmental Conditions	Test Voltage
EIRP	25°C, 60%RH	DC 3.8V
Conducted Output Power	25°C, 65%RH	DC 3.8V
Occupied Bandwidth	25°C, 65%RH	DC 3.8V
Conducted Emission	25°C, 65%RH	DC 3.8V
Radiated Emission	25°C, 60%RH	AC 120V/60Hz
Band Edge	25°C, 65%RH	DC 3.8V
Peak to Average Ratio	25°C, 65%RH	DC 3.8V
Frequency Stability	25°C, 65%RH	DC 3.8V

**3.3 BLOCKDIGRAMSHOWINGTHECONFIGURATIONOFSYSTEMTESTED FOR RADIATED**

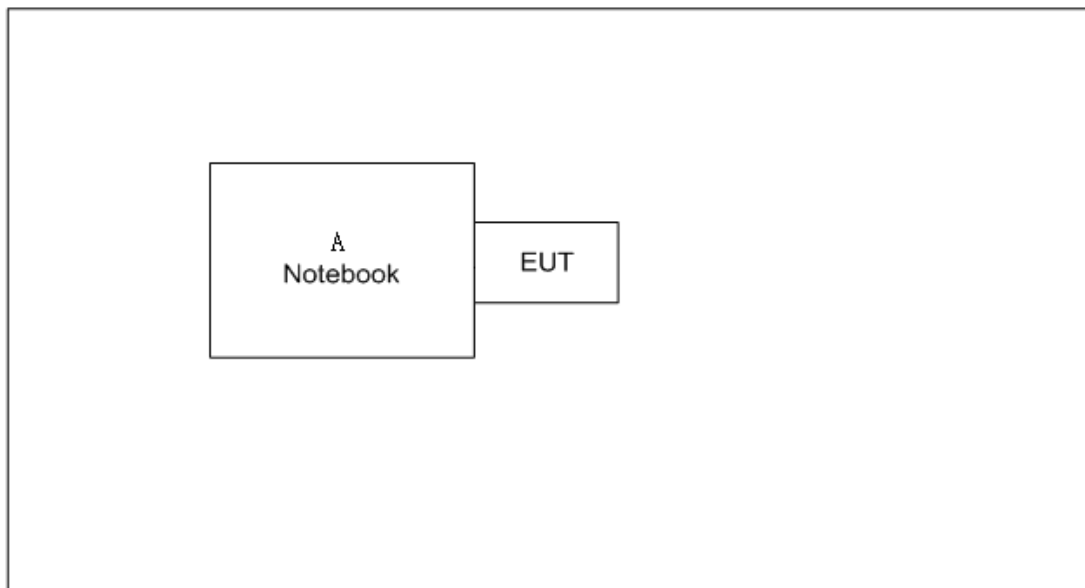

**3.4 DESCRIPTION OF SUPPORT UNITS**

The EUT has been tested as an independent unit together with other necessary accessories or support units. The following support units or accessories were used to form a representative test configuration during the tests.

Item	Equipment	Mfr/Brand	Model/Type No.	FCC ID	Series No.
A	Notebook	Dell 745	DCSM	DOC	G7K832X

Item	Shielded Type	Ferrite Core	Length	Note
-	-	-	-	-

## 4. TEST RESULT

### 4.1 OUTPUT POWER MEASUREMENT

#### 4.1.1 LIMIT

Mobile / Portable station are limited to 2 watts e.i.r.p.

#### 4.1.2 TEST PROCEDURE

##### EIRP/ERP:

EIRP= Conducted Power +Antenan gain

ERP power=EIPR power-2.15dBi.

##### Conducted Power:

The EUT was set up for the maximum power with GSM, GPRS, EDGE, WCDMA, CDMA, and LTE link data modulation and link up with simulator. Set the EUT to transmit under low, middle and high channel and record the power level shown on simulator.

#### 4.1.3 TESTSETUP LAYOUT

##### Conducted Power Measurement

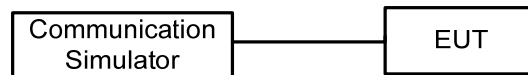

#### 4.1.4 TEST DEVIATION

No deviation

#### 4.1.5 TEST RESULTS

Please refer to the Attachment A.

## 4.2 OCCUPIED BANDWIDTH MEASUREMENT

### 4.2.1 TEST PROCEDURE

The EUT makes a call to the communication simulator. All measurements were done at low, middle and high operational frequency range. The communication simulator station system controlled a EUT to export maximum output power under transmission mode and specific channel frequency. Use OBW measurement function of Spectrum analyzer to measure 99 % occupied bandwidth and 26dB bandwidth.

### 4.2.2 TEST SETUP LAYOUT

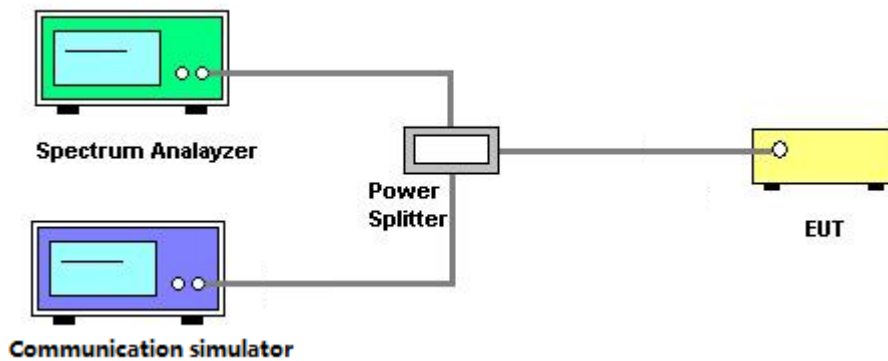

### 4.2.3 TEST DEVIATION

No deviation

### 4.2.4 TEST RESULTS

Please refer to the Attachment B.

### 4.3 CONDUCTED EMISSIONS MEASUREMENT

#### 4.3.1 LIMIT

The power of any emission outside of the authorized operating frequency ranges must be attenuated below the transmitting power (P) by a factor of at least  $43 + 10 \log(P)$  dB. The emission limit equal to  $-13\text{dBm}$ .

#### 4.3.2 TEST PROCEDURES

1. The testing follows FCC KDB 971168 v02r02 Section 6.0.
2. The EUT was connected to spectrum analyzer and system simulator via a power divider.
3. The band edges of low and high channels for the highest RF powers were measured. Set  $\text{RBW} \geq 1\%$  EBW in the 1MHz band immediately outside and adjacent to the band edge.
4. Set spectrum analyzer with RMS detector.
5. The RF fundamental frequency should be excluded against the limit line in the operating frequency band.
6. The limit line is derived from  $43+10\log(P)\text{dB}$  below the transmitter power P(Watts)  
 $=P(W)-[43+10\log(P)](\text{dB})$   
 $=[30+10\log(P)](\text{dBm})-[43+10\log(P)](\text{dB})$   
 $=-13\text{dBm}$

#### 4.3.3 TESTSETUP LAYOUT

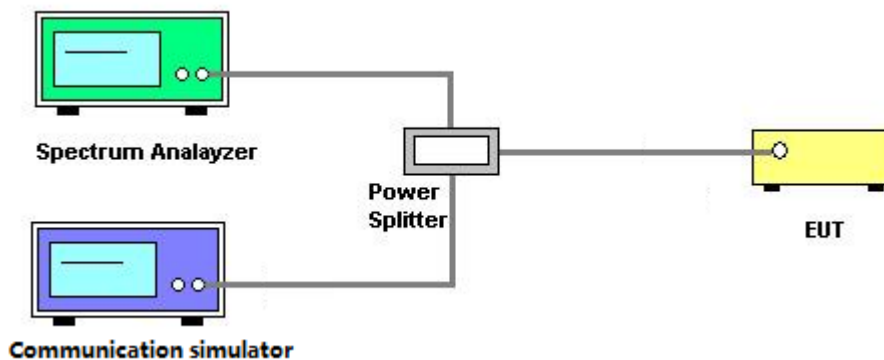

#### 4.3.4 TESTDEVIATION

No deviation

#### 4.3.5 TEST RESULTS

Please refer to the Attachment C.



## 4.4 RADIATED EMISSIONS MEASUREMENT

### 4.4.1 LIMIT

The power of any emission outside of the authorized operating frequency ranges must be attenuated below the transmitting power (P) by a factor of at least  $43 + 10 \log(P)$  dB. The emission limit equal to -13dBm.

### 4.4.2 TEST PROCEDURES

1. Substitution method is used for E.I.R.P measurement. In the semi-anechoic chamber, EUT placed on the 0.8m height of Turn Table, rotated the table around 360 degrees to search the maximum radiation power and receiver antenna shall be rotated vertical and horizontal polarization and moved height from 1m to 4m to find the maximum polar radiated power. The "Read Value" is the spectrum reading the maximum power value.
2. The substitution horn antenna is substituted for EUT at the same position and signals generator export the CW signal to the substitution antenna via a TX cable. Rotated the Turn Table and moved receiving antenna to find the maximum radiation power. Adjust output power level of S.G to get a Value of spectrum reading equal to "Read Value " of step a. Record the power level of S.G
3. EIRP = Output power level of S.G – TX cable loss + Antenna gain of substitution horn.
4. E.R.P power can be calculated form E.I.R.P power by subtracting the gain of dipole, E.R.P power = E.I.P.R power - 2.15dBi.
5. The resolution bandwidth and video bandwidth of test receiver/spectrum analyzer is 1MHz/3MHz.

### 4.4.3 TESTSETUP LAYOUT

This test setup layout is the same as that shown in **section 4.1.3**.

### 4.4.4 TESTDEVIATION

No deviation

### 4.4.5 TEST RESULTS

Please refer to the Attachment D.

## 4.5 BAND EDGE MEASUREMENT

### 4.5.1 LIMIT

A Power of any emission outside of the authorized operating frequency ranges must be attenuated below the transmitting power (P) by a factor of at least  $43 + 10 \log(P)$  dB. In the 1 MHz bands immediately outside and adjacent to the frequency block a resolution bandwidth of at least one percent of the emission bandwidth of the fundamental emission of the transmitter may be employed.

### 4.5.2 TEST PROCEDURES

1. All measurements were done at low and high operational frequency range.
2. The center frequency of spectrum is the band edge frequency and span is 1MHz. RB of the spectrum is 3kHz and VB of the spectrum is 10kHz (GSM/GPRS/EDGE).
3. The center frequency of spectrum is the band edge frequency and span is 5MHz. RB of the spectrum is 100kHz and VB of the spectrum is 300kHz (WCDMA).
4. The center frequency of spectrum is the band edge frequency and span is 1MHz. RB of the spectrum is 13kHz and VB of the spectrum is 51kHz (LTE Bandwidth 1.4MHz).
5. The center frequency of spectrum is the band edge frequency and span is 1MHz. RB of the spectrum is 30kHz and VB of the spectrum is 100kHz (LTE Bandwidth 3MHz).
6. The center frequency of spectrum is the band edge frequency and span is 1MHz. RB of the spectrum is 100kHz and VB of the spectrum is 300kHz (LTE Bandwidth 5MHz/10MHz).
7. Record the max trace plot into the test report.

### 4.5.3 TESTSETUP LAYOUT

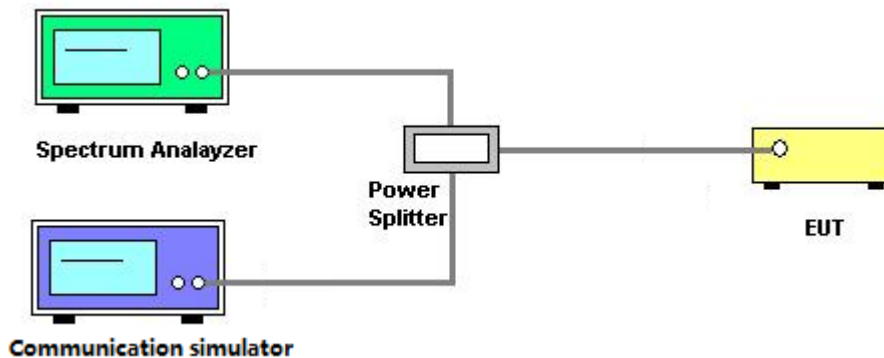

### 4.5.4 TESTDEVIATION

No deviation

### 4.5.5 TEST RESULTS

Please refer to the Attachment E.

## 4.6 PEAK TO AVERAGE RATIO MEASUREMENT

### 4.6.1 LIMIT

In measuring transmissions in this band using an average power technique, the peak to-average ratio (PAR) of the transmission may not exceed 13 dB.

### 4.6.2 TEST PROCEDURES

1. Set resolution/measurement bandwidth  $\geq$  signal's occupied bandwidth;
2. Set the number of counts to a value that stabilizes the measured CCDF curve;
3. Record the maximum PAPR level associated with a probability of 0.1%.

### 4.6.3 TESTSETUP LAYOUT

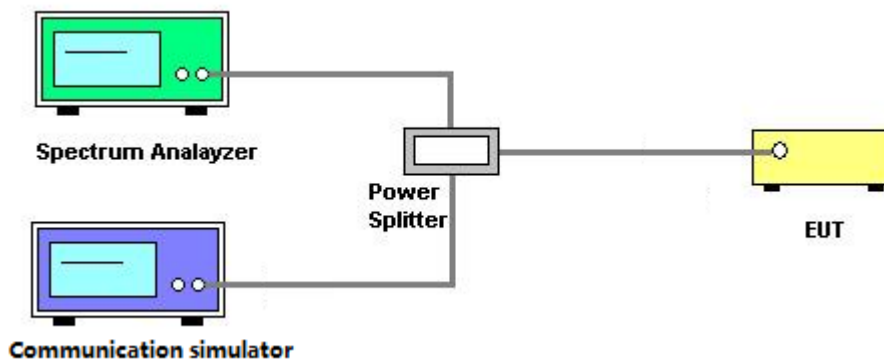

### 4.6.4 TESTDEVIATION

No deviation

### 4.6.5 TEST RESULTS

Please refer to the Attachment F.

## 4.7 FREQUENCY STABILITY MEASUREMENT

### 4.7.1 LIMIT

1.5 ppm is for base and fixed station. 2.5 ppm is for mobile station.

### 4.7.2 TEST PROCEDURES

1. Device is placed at the oven room. The oven room could control the temperatures and humidity. Power warm up is at least 15 min and power applied should perform before recording frequency error.
2. EUT is connected the external power supply to control the DC input power. The test voltage range is from minimum to maximum working voltage. Each step shall be record the frequency error rate.
3. The temperature range step is 10 degrees in this test items. All temperature levels shall be hold the  $\pm 0.5^{\circ}\text{C}$  during the measurement testing. The each temperature step shall be at least 0.5 hours, consider the EUT could be test under the stability condition.
4. The frequency error was recorded frequency error from the communication simulator.

### 4.7.3 TESTSETUP LAYOUT

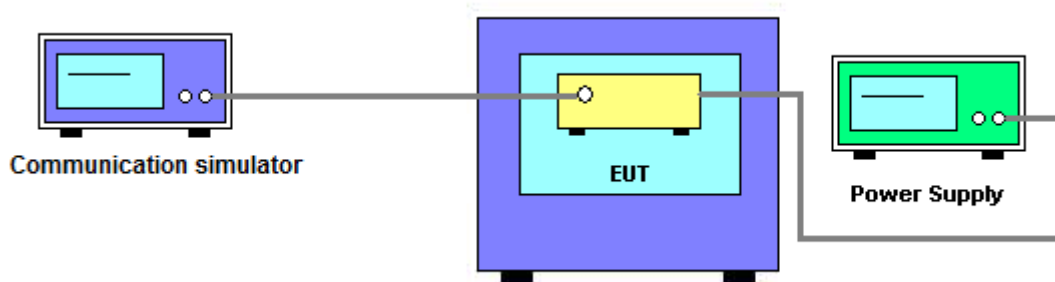

### 4.7.4 TESTDEVIATION

No deviation

### 4.7.5 TEST RESULTS

Please refer to the Attachment G.

## 5. LIST OF MEASUREMENT EQUIPMENTS

Radiated Emission Measurement					
Item	Kind of Equipment	Manufacturer	Type No.	Serial No.	Calibrated until
1	Preamplifier	EMCI	012645B	980267	Feb. 28, 2018
2	Preamplifier	EMCI	EMC02325	980217	Dec. 29, 2017
3	Preamplifier	EMCI	EMC2654045	980030	Feb. 14, 2018
4	Test Cable	EMCI	EMC104-SM-S M-8000	8m	Jan. 04, 2018
5	Test Cable	EMCI	EMC104-SM-S M-800	150207	Jan. 04, 2018
6	Test Cable	EMCI	EEMC104-SM-S M-3000	151205	Jan. 04, 2018
7	MXE EMI Receiver	Agilent	N9038A	MY55420127	Jan. 09, 2018
8	Signal Analyzer	Agilent	N9010A	MY52220990	Feb. 22, 2018
9	Loop Ant	EMCO	6502	42960	Nov. 24, 2017
10	Horn Ant	SCHWARZBECK	BBHA 9120D	9120D-1342	Feb. 28, 2018
11	Horn Ant	Schwarzbeck	BBHA 9170	187	Dec. 07, 2017
12	Trilog-Broadband Antenna	Schwarzbeck	VULB 9168	9168-548	Jan. 16, 2018
13	5dB Attenuator	EMCI	EMCI-N-6-05	AT-N0623	Jan. 16, 2018

Conducted Measurement					
Item	Kind of Equipment	Manufacturer	Type No.	Serial No.	Calibrated until
1	Spectrum Analyzer	Keysight	N9010A	MY54200240	Aug. 27, 2018
2	Radio Com Analyzer	Anritsu	MT8820C	6201525878	Sep. 05, 2019

Frequency Stability Measurement					
Item	Kind of Equipment	Manufacturer	Type No.	Serial No.	Calibrated until
1	Spectrum Analyzer	Keysight	N9010A	MY54200240	Aug. 27, 2018
2	Radio Com Analyzer	Anritsu	MT8820C	6201525878	Sep. 05, 2019
3	Thermal Chamber	HOLINK	CHOLINK/H-T- 1F-D	BA03101701	May 14, 2018

Remark: "N/A" denotes no model name, serial no. or calibration specified.  
All calibration period of equipment list is one year.

## ATTACHMENT A - OUTPUT POWER

**Conducted Power:**

DCS1900 (Capsensor Off)	Burst Conducted Power (dBm)		
	512CH	661CH	810CH
	1850.2MHz	1880MHz	1909.8MHz
GSM (CS)	28.66	28.11	28.35
GPRS/EDGE (GMSK)	28.73	28.17	28.64
	26.71	26.54	26.79
	24.58	24.37	24.71
	23.62	23.4	23.59
EDGE (8PSK)	24.85	24.87	24.81
	22.71	22.191	22.86
	20.81	20.86	20.88
	18.98	18.86	19.01

Modulation	Band	WCDMA Band 2(Capsensor Off)		
	Tx Channel	9262CH	9400CH	9538CH
	Rx Channel	9662CH	9800CH	9938CH
	Frequency	1852.4MHz	1880MHz	1907.6MHz
BPSK	RMC 12.2K	26.65	26.02	26.25
	RMC 64K	26.49	25.86	26.39
	RMC 144K	26.53	25.88	26.33
	RMC 384K	26.58	25.97	26.44
16QAM	HSDPA Subtest-1	26.03	25.44	25.81
	HSDPA Subtest-2	25.99	25.41	25.71
	HSDPA Subtest-3	26	25.32	25.76
	HSDPA Subtest-4	25.97	25.38	25.81
16QAM	HSUPA Subtest-1	25.92	25.35	25.81
	HSUPA Subtest-2	23.95	24.37	24.76
	HSUPA Subtest-3	23.79	23.48	23.62
	HSUPA Subtest-4	24.46	24.28	24.51
	HSUPA Subtest-5	25.18	24.81	25.27

LTE Band / BW	Modulation	RB Sizing	RB Offset	Low CH	Mid CH	High CH
				18625 CH	18900 CH	19175 CH
				1852.5 MHz	1880 MHz	1907.5 MHz
2 / 5M	QPSK	1	0	21.42	21.70	22.33
		1	12	22.30	22.18	22.27
		1	24	21.81	21.65	21.27
		12	0	21.00	21.28	21.39
		12	6	21.31	21.36	21.28
		12	13	21.18	21.24	21.11
		25	0	21.03	21.09	21.07
	16QAM	1	0	20.91	21.20	21.59
		1	12	21.67	22.09	21.57
		1	24	21.09	21.30	20.53
		12	0	20.14	20.50	20.58
		12	6	20.48	20.60	20.43
		12	13	20.35	20.48	20.24
		25	0	20.17	20.27	20.22

LTE Band / BW	Modulation	RB Sizing	RB Offset	Low CH	Mid CH	High CH
				18650 CH	18900 CH	19150 CH
				1855 MHz	1880 MHz	1905 MHz
2 / 10M	QPSK	1	0	21.82	22.06	22.73
		1	24	22.67	22.27	22.97
		1	49	22.14	21.46	21.33
		25	0	20.95	20.93	21.81
		25	12	21.39	20.94	21.72
		25	25	21.29	21.10	21.11
		50	0	21.01	21.27	21.21
	16QAM	1	0	21.20	21.77	22.00
		1	24	22.33	21.99	22.09
		1	49	21.84	21.12	20.40
		25	0	20.42	20.37	20.85
		25	12	20.84	20.39	20.70
		25	25	20.76	20.08	20.08
		50	0	20.49	20.26	20.25



LTE Band / BW	Modulation	RB Sizer	RB Offset	Low CH	Mid CH	High CH
				18675 CH	18900 CH	19125 CH
				1857.5 MHz	1880 MHz	1902.5 MHz
2 / 15M	QPSK	1	0	21.79	22.55	22.72
		1	37	22.42	22.20	23.05
		1	74	21.95	21.39	21.25
		36	0	20.85	21.39	21.83
		36	19	21.61	21.06	22.04
		36	39	21.58	20.77	21.22
		75	0	21.32	20.95	21.34
	16QAM	1	0	21.22	22.03	22.06
		1	37	22.17	21.67	22.30
		1	74	21.70	20.87	20.35
		36	0	20.41	20.87	20.81
		36	19	20.85	20.23	21.01
		36	39	20.81	19.96	20.19
		75	0	20.61	20.17	20.34

LTE Band / BW	Modulation	RB Sizer	RB Offset	Low CH	Mid CH	High CH
				18700 CH	18900 CH	19100 CH
				1860 MHz	1880 MHz	1900 MHz
2 / 20M	QPSK	1	0	22.12	22.66	22.47
		1	50	22.91	21.63	22.90
		1	99	22.58	22.01	21.66
		50	0	21.09	21.25	21.53
		50	25	21.55	20.97	21.69
		50	50	21.63	21.19	21.19
		100	0	21.47	21.32	21.39
	16QAM	1	0	21.58	21.94	22.01
		1	50	22.17	20.64	22.41
		1	99	22.13	21.52	21.04
		50	0	20.36	20.65	20.75
		50	25	20.67	20.11	20.92
		50	50	20.64	19.95	20.41
		100	0	20.48	20.08	20.62

**EIRP Power**

DCS1900 (Capsensor Off)	EIRP Power (dBm)		
	512CH	661CH	810CH
	1850.2MHz	1880MHz	1909.8MHz
GSM (CS)	<b>30.41</b>	29.86	30.10
GPRS/EDGE (GMSK)	<b>30.48</b>	29.92	30.39
	28.46	28.29	28.54
	26.33	26.12	26.46
	25.37	25.15	25.34
EDGE (8PSK)	26.60	<b>26.62</b>	26.56
	24.46	23.94	24.61
	22.56	22.61	22.63
	20.73	20.61	20.76

Modulation	Band	WCDMA Band 2(Capsensor Off)		
	Tx Channel	9262CH	9400CH	9538CH
	Rx Channel	9662CH	9800CH	9938CH
	Frequency	1852.4MHz	1880MHz	1907.6MHz
BPSK	RMC 12.2K	<b>24.50</b>	23.87	24.10
	RMC 64K	24.34	23.71	24.24
	RMC 144K	24.38	23.73	24.18
	RMC 384K	24.43	23.82	24.29
16QAM	HSDPA Subtest-1	<b>23.88</b>	23.29	23.66
	HSDPA Subtest-2	23.84	23.26	23.56
	HSDPA Subtest-3	23.85	23.17	23.61
	HSDPA Subtest-4	23.82	23.23	23.66
16QAM	HSUPA Subtest-1	<b>23.77</b>	23.20	23.66
	HSUPA Subtest-2	21.80	22.22	22.61
	HSUPA Subtest-3	21.64	21.33	21.47
	HSUPA Subtest-4	22.31	22.13	22.36
	HSUPA Subtest-5	23.03	22.66	23.12

LTE Band / BW	Modulation	RB Sizing	RB Offset	Low CH	Mid CH	High CH
				18625 CH	18900 CH	19175 CH
				1852.5 MHz	1880 MHz	1907.5 MHz
2 / 5M	QPSK	1	0	23.17	23.45	<b>24.08</b>
		1	12	24.05	23.93	24.02
		1	24	23.56	23.40	23.02
		12	0	22.75	23.03	23.14
		12	6	23.06	23.11	23.03
		12	13	22.93	22.99	22.86
		25	0	22.78	22.84	22.82
	16QAM	1	0	22.66	22.95	23.34
		1	12	23.42	<b>23.84</b>	23.32
		1	24	22.84	23.05	22.28
		12	0	21.89	22.25	22.33
		12	6	22.23	22.35	22.18
		12	13	22.10	22.23	21.99
		25	0	21.92	22.02	21.97

LTE Band / BW	Modulation	RB Sizing	RB Offset	Low CH	Mid CH	High CH
				18650 CH	18900 CH	19150 CH
				1855 MHz	1880 MHz	1905 MHz
2 / 10M	QPSK	1	0	23.57	23.81	24.48
		1	24	24.42	24.02	<b>24.72</b>
		1	49	23.89	23.21	23.08
		25	0	22.70	22.68	23.56
		25	12	23.14	22.69	23.47
		25	25	23.04	22.85	22.86
		50	0	22.76	23.02	22.96
	16QAM	1	0	22.95	23.52	23.75
		1	24	<b>24.08</b>	23.74	23.84
		1	49	23.59	22.87	22.15
		25	0	22.17	22.12	22.60
		25	12	22.59	22.14	22.45
		25	25	22.51	21.83	21.83
		50	0	22.24	22.01	22.00

LTE Band / BW	Modulation	RB Sizer	RB Offset	Low CH	Mid CH	High CH
				18675 CH	18900 CH	19125 CH
				1857.5 MHz	1880 MHz	1902.5 MHz
2 / 15M	QPSK	1	0	23.54	24.30	24.47
		1	37	24.17	23.95	<b>24.80</b>
		1	74	23.70	23.14	23.00
		36	0	22.60	23.14	23.58
		36	19	23.36	22.81	23.79
		36	39	23.33	22.52	22.97
		75	0	23.07	22.70	23.09
	16QAM	1	0	22.97	23.78	23.81
		1	37	23.92	23.42	<b>24.05</b>
		1	74	23.45	22.62	22.10
		36	0	22.16	22.62	22.56
		36	19	22.60	21.98	22.76
		36	39	22.56	21.71	21.94
		75	0	22.36	21.92	22.09

LTE Band / BW	Modulation	RB Sizer	RB Offset	Low CH	Mid CH	High CH
				18700 CH	18900 CH	19100 CH
				1860 MHz	1880 MHz	1900 MHz
2 / 20M	QPSK	1	0	23.87	24.41	24.22
		1	50	<b>24.66</b>	23.38	24.65
		1	99	24.33	23.76	23.41
		50	0	22.84	23.00	23.28
		50	25	23.30	22.72	23.44
		50	50	23.38	22.94	22.94
		100	0	23.22	23.07	23.14
	16QAM	1	0	23.33	23.69	23.76
		1	50	23.92	22.39	<b>24.16</b>
		1	99	23.88	23.27	22.79
		50	0	22.11	22.40	22.50
		50	25	22.42	21.86	22.67
		50	50	22.39	21.70	22.16
		100	0	22.23	21.83	22.37

## ATTACHMENT B - OCCUPIED BANDWIDTH

DCS1900					
GSM			EDGE		
CS			8PSK		
Channel	Frequency (MHz)	99% Occupied Bandwidth (kHz)	Channel	Frequency (MHz)	99% Occupied Bandwidth (kHz)
512	1850.2	244.41	512	1850.2	243.81
661	1880	241.78	661	1880	246.80
810	1909.8	239.40	810	1909.8	244.53
Channel	Frequency (MHz)	26dB Bandwidth (kHz)	Channel	Frequency (MHz)	26dB Bandwidth (kHz)
512	1850.2	316.50	512	1850.2	306.90
661	1880	313.20	661	1880	313.10
810	1909.8	313.90	810	1909.8	318.00

### Spectrum Plot

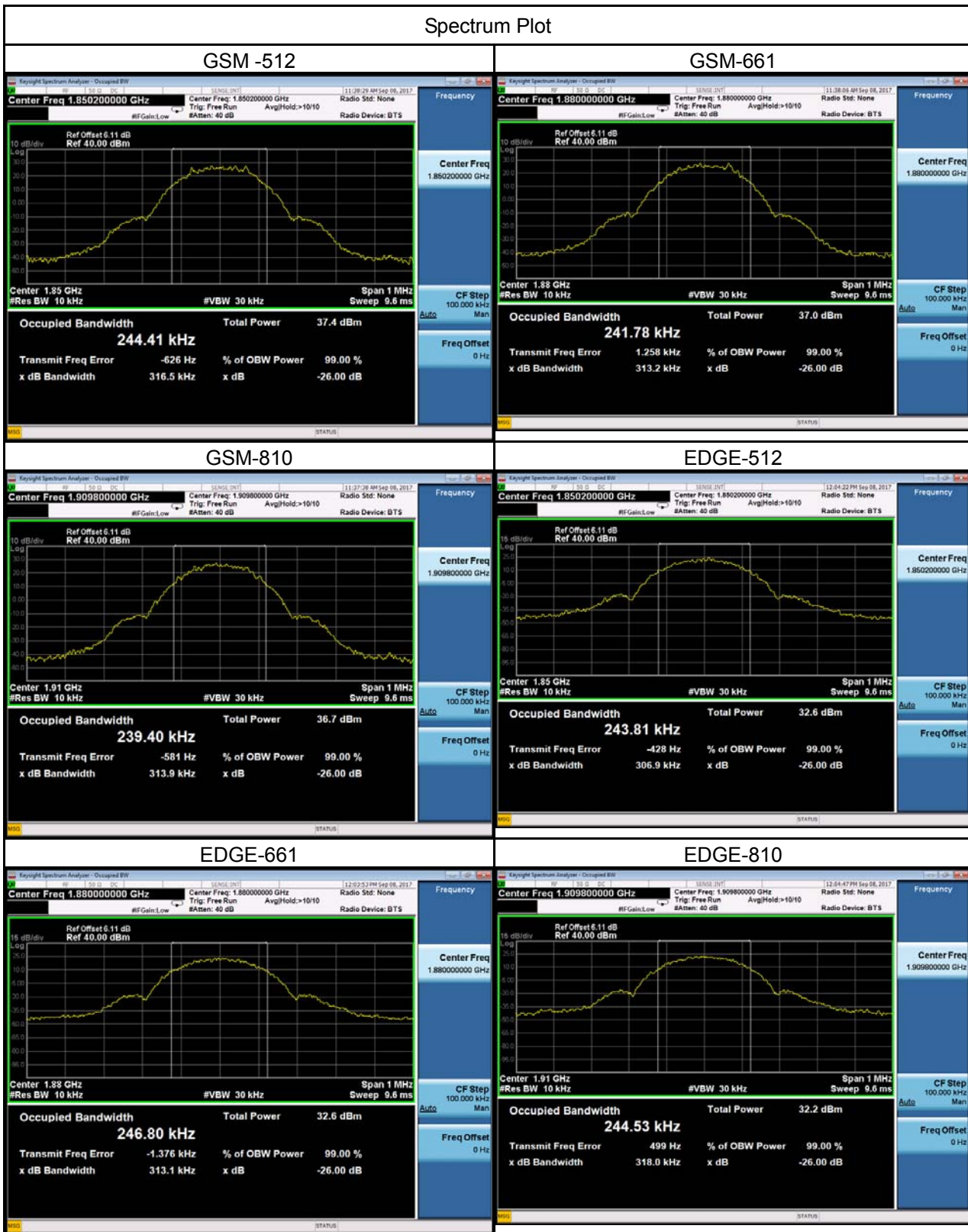

WCDMA Band 2					
BPSK					
Channel	Frequency (MHz)	99% Occupied Bandwidth (MHz)	Channel	Frequency (MHz)	26dB Bandwidth (MHz)
9262	1852.4	4.1565	9262	1852.4	4.722
9400	1880	4.1580	9400	1880	4.731
9538	1907.6	4.1545	9538	1907.6	4.730





WCDMA_HSDPA Band 2					
Channel	Frequency (MHz)	99% Occupied Bandwidth (MHz)	Channel	Frequency (MHz)	26dB Bandwidth (MHz)
9262	1852.4	4.1705	9262	1852.4	4.743
9400	1880	4.1711	9400	1880	4.748
9538	1907.6	4.1375	9538	1907.6	4.731



WCDMA_HSUPA Band 2					
Channel	Frequency (MHz)	99% Occupied Bandwidth (MHz)	Channel	Frequency (MHz)	26dB Bandwidth (MHz)
9262	1852.4	4.1664	9262	1852.4	4.744
9400	1880	4.1534	9400	1880	4.752
9538	1907.6	4.1530	9538	1907.6	4.738



LTE Band 2_5M					
QPSK			16QAM		
Channel	Frequency (MHz)	99% Occupied Bandwidth (MHz)	Channel	Frequency (MHz)	99% Occupied Bandwidth (MHz)
18625	1852.5	4.5009	18625	1852.5	4.5068
18900	1880	4.4974	18900	1880	4.4977
19175	1907.5	4.4988	19175	1907.5	4.5020
Channel	Frequency (MHz)	26dB Bandwidth (MHz)	Channel	Frequency (MHz)	26dB Bandwidth (MHz)
18625	1852.5	4.975	18625	1852.5	4.923
18900	1880	4.914	18900	1880	4.933
19175	1907.5	4.900	19175	1907.5	4.960

### Spectrum Plot



LTE Band 2_10M					
QPSK			16QAM		
Channel	Frequency (MHz)	99% Occupied Bandwidth (MHz)	Channel	Frequency (MHz)	99% Occupied Bandwidth (MHz)
18650	1855	8.9854	18650	1855	9.0026
18900	1880	8.9956	18900	1880	8.9899
19150	1905	8.9922	19150	1905	8.9896
Channel	Frequency (MHz)	26dB Bandwidth (MHz)	Channel	Frequency (MHz)	26dB Bandwidth (MHz)
18650	1855	9.860	18650	1855	9.934
18900	1880	9.916	18900	1880	9.896
19150	1905	9.907	19150	1905	9.909

### Spectrum Plot

#### QPSK-18650



#### QPSK-18900



#### QPSK-19150



#### 16QAM-18650



#### 16QAM-18900



#### 16QAM-19150



LTE Band 2_15M					
QPSK			16QAM		
Channel	Frequency (MHz)	99% Occupied Bandwidth (MHz)	Channel	Frequency (MHz)	99% Occupied Bandwidth (MHz)
18675	1857.5	13.498	18675	1857.5	13.492
18900	1880	13.476	18900	1880	13.449
19125	1902.5	13.476	19125	1902.5	13.460
Channel	Frequency (MHz)	26dB Bandwidth (MHz)	Channel	Frequency (MHz)	26dB Bandwidth (MHz)
18675	1857.5	14.83	18675	1857.5	14.98
18900	1880	14.99	18900	1880	14.89
19125	1902.5	14.93	19125	1902.5	14.88

### Spectrum Plot





LTE Band 2_20M					
QPSK			16QAM		
Channel	Frequency (MHz)	99% Occupied Bandwidth (MHz)	Channel	Frequency (MHz)	99% Occupied Bandwidth (MHz)
18700	1860	18.030	18700	1860	18.018
18900	1880	17.950	18900	1880	17.916
19100	1900	17.978	19100	1900	18.042
Channel	Frequency (MHz)	26dB Bandwidth (MHz)	Channel	Frequency (MHz)	26dB Bandwidth (MHz)
18700	1860	19.69	18700	1860	19.79
18900	1880	19.61	18900	1880	19.66
19100	1900	19.68	19100	1900	19.65

### Spectrum Plot

#### QPSK-18700



#### QPSK-18900

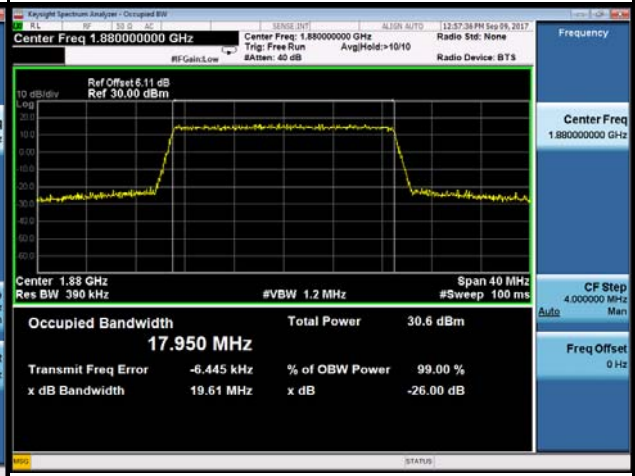

#### QPSK-19100



#### 16QAM-18700

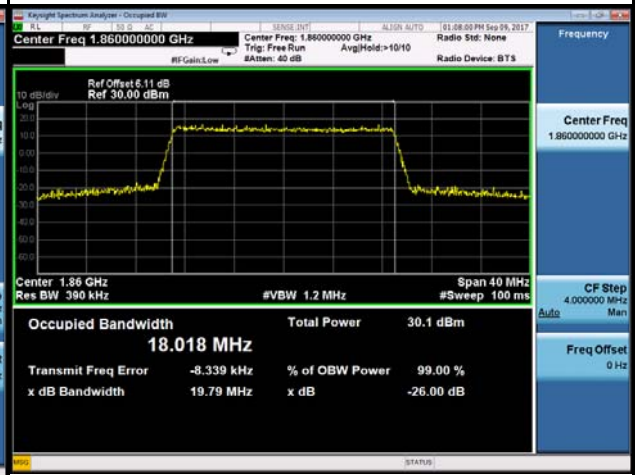

#### 16QAM-18900

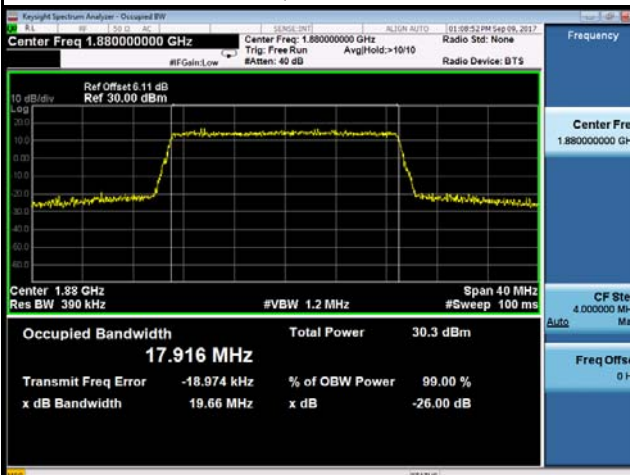

#### 16QAM-19100

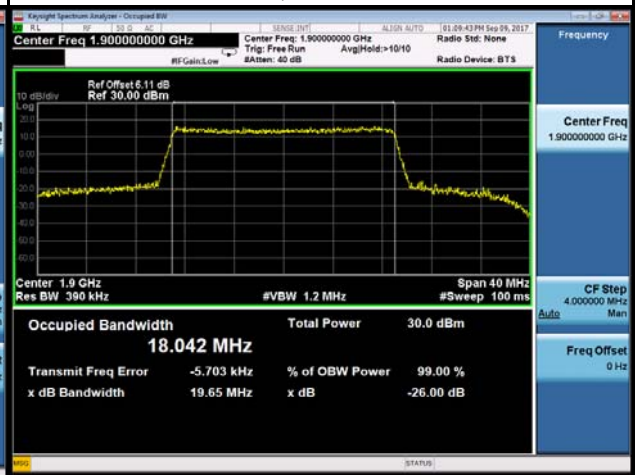

## ATTACHMENT C - CONDUCTED EMISSIONS

DCS1900			
GSM		GSM	
Channel	Frequency(MHz)	Channel	Frequency(MHz)
661	1880	661	1880
GSM		EDGE	
Channel	Frequency(MHz)	Channel	Frequency(MHz)
661	1880	661	1880
EDGE		EDGE	
Channel	Frequency(MHz)	Channel	Frequency(MHz)
661	1880	661	1880

WCDMA Band 2

Channel	Frequency(MHz)	Channel	Frequency(MHz)
9400	1880	9400	1880
Date: 11.SEP.2017 17:22:15		Date: 11.SEP.2017 17:21:10	
Channel	Frequency(MHz)	-	-
9400	1880	-	-

WCDMA\_HSDPA Band 2

Channel	Frequency(MHz)	Channel	Frequency(MHz)
9400	1880	9400	1880

Date: 11.SEP.2017 17:21:44

Date: 11.SEP.2017 17:20:43

Channel	Frequency(MHz)		
9400	1880	-	-

Start 30 MHz, #Res BW 1.0 MHz, #VBW 3.0 MHz, Stop 20.000 GHz, Sweep 33.33 ms (1001 pts)

Frequency

Auto Tune

Center Freq 10.015000000 GHz

Start Freq 30.000000 MHz

Stop Freq 20.000000000 GHz

CF Step 1.997000000 GHz

Freq Offset 0 Hz

Scale Type Log

### WCDMA\_HSUPA Band 2

Channel	Frequency(MHz)	Channel	Frequency(MHz)
9400	1880	9400	1880
Date: 11.SEP.2017 17:21:58		Date: 11.SEP.2017 17:20:55	
Channel	Frequency(MHz)	-	-
9400	1880	-	-

LTE Band 2\_5M

Channel	Frequency(MHz)	Channel	Frequency(MHz)
18900	1880	18900	1880
Date: 11.SEP.2017 17:06:52		Date: 11.SEP.2017 17:01:04	
Channel	Frequency(MHz)	-	-
18900	1880	-	-



LTE Band 2\_10M

Channel	Frequency(MHz)	Channel	Frequency(MHz)
18900	1880	18900	1880
Channel	Frequency(MHz)	-	-
18900	1880	-	-

LTE Band 2\_15M

Channel	Frequency(MHz)	Channel	Frequency(MHz)
18900	1880	18900	1880
Channel	Frequency(MHz)	-	-
18900	1880	-	-

LTE Band 2\_20M

Channel	Frequency(MHz)	Channel	Frequency(MHz)
18900	1880	18900	1880
Channel	Frequency(MHz)	-	-
18900	1880	-	-

## ATTACHMENT D - RADIATED EMISSION

Test Mode: TX Mode

Ant 0°

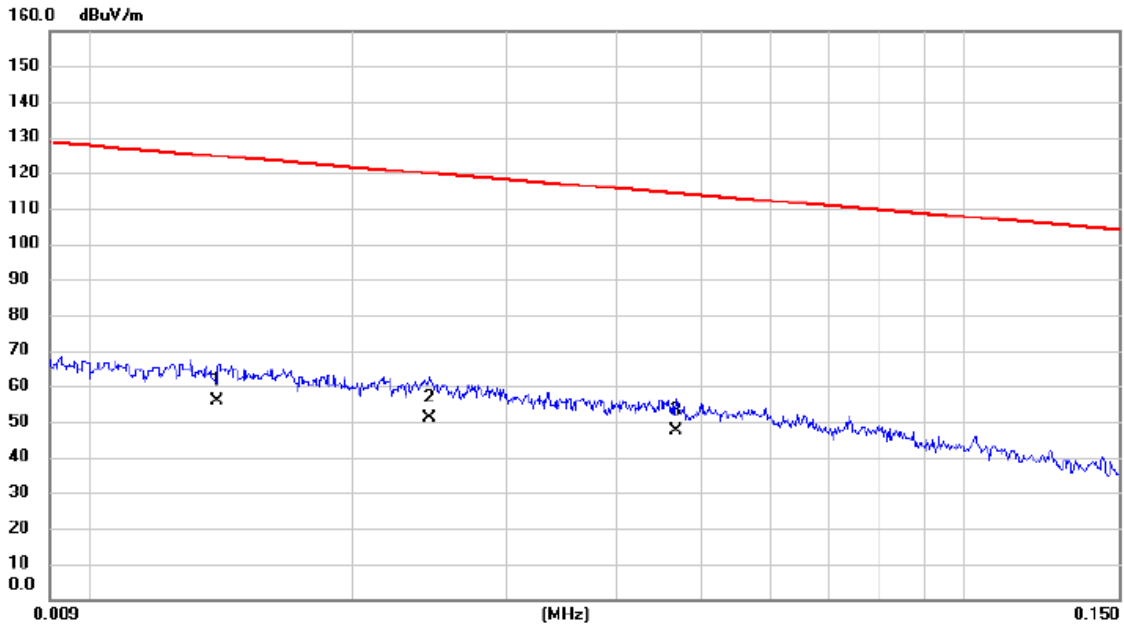

No.	Mk.	Freq. MHz	Reading Level dBuV	Correct Factor dB	Measure- ment dBuV/m	Limit dBuV/m	Margin dB	Detector	Comment
1		0.014	36.48	19.40	55.88	124.68	-68.80	AVG	
2		0.025	34.66	16.51	51.17	119.82	-68.65	AVG	
3	*	0.047	33.93	13.32	47.25	114.20	-66.95	AVG	

Test Mode: TX Mode

Ant 0°

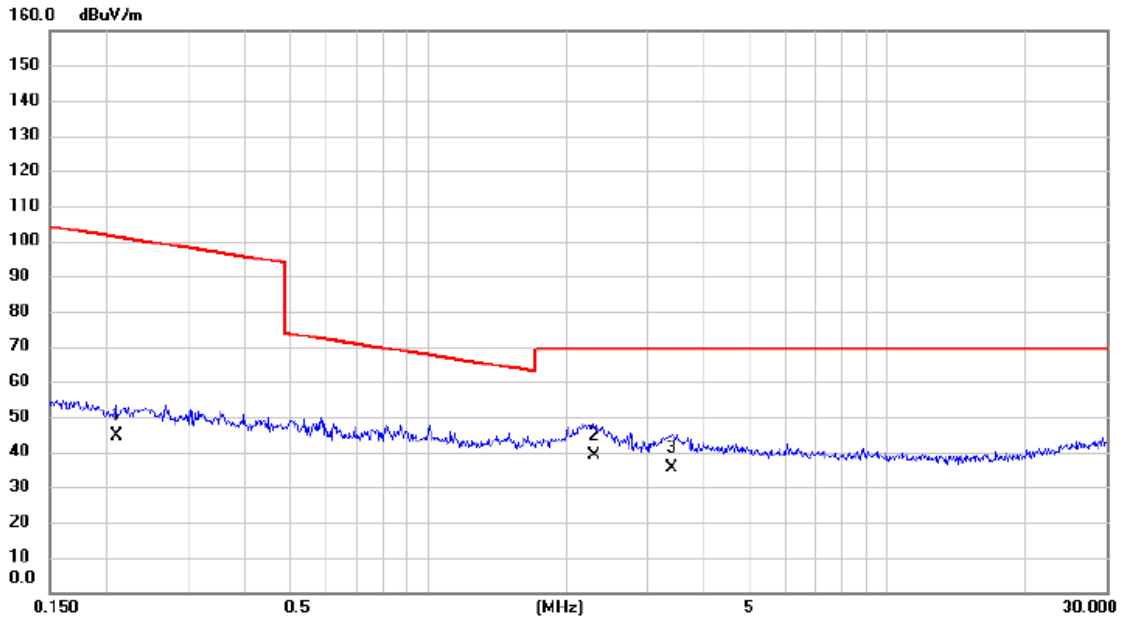

No.	Mk.	Freq.	Reading Level	Correct Factor	Measurement	Limit	Margin		
		MHz	dBuV	dB	dBuV/m	dBuV/m	dB	Detector	Comment
1		0.209	32.52	11.94	44.46	101.19	-56.73	AVG	
2	*	2.297	27.46	11.42	38.88	69.54	-30.66	QP	
3		3.399	24.35	11.16	35.51	69.54	-34.03	QP	

Test Mode: TX Mode

Ant 90°

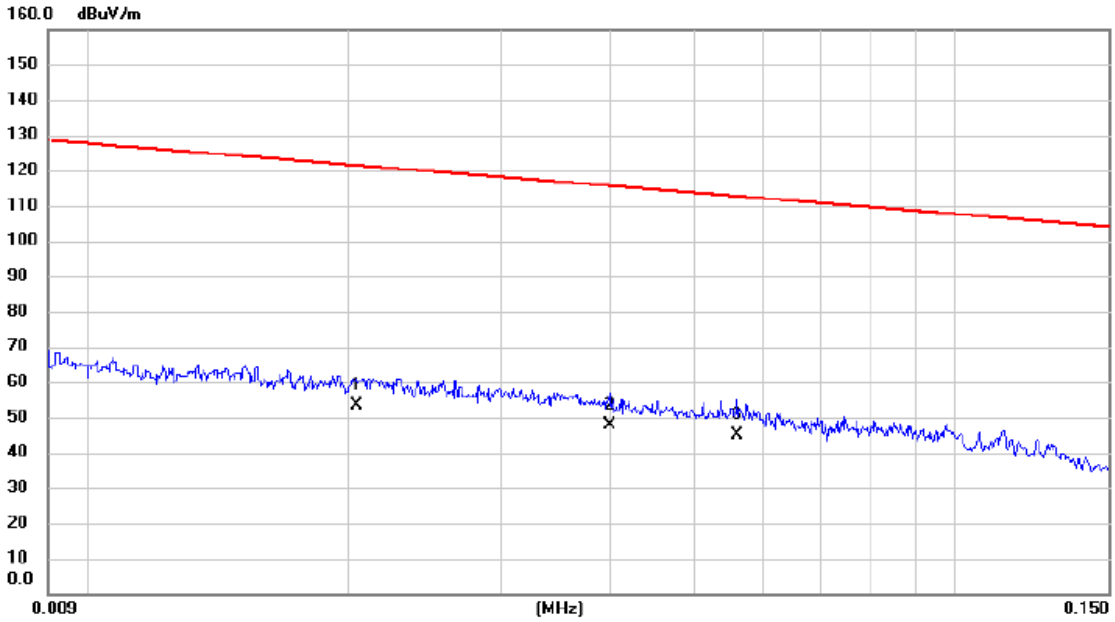

No.	Mk.	Freq. MHz	Reading Level dBuV	Correct Factor dB	Measure- ment dBuV/m	Limit dBuV/m	Margin dB	Detector	Comment
1		0.020	35.66	17.64	53.30	121.41	-68.11	AVG	
2		0.040	33.78	14.00	47.78	115.56	-67.78	AVG	
3	*	0.056	32.20	12.89	45.09	112.64	-67.55	AVG	

Test Mode: TX Mode

Ant 90°

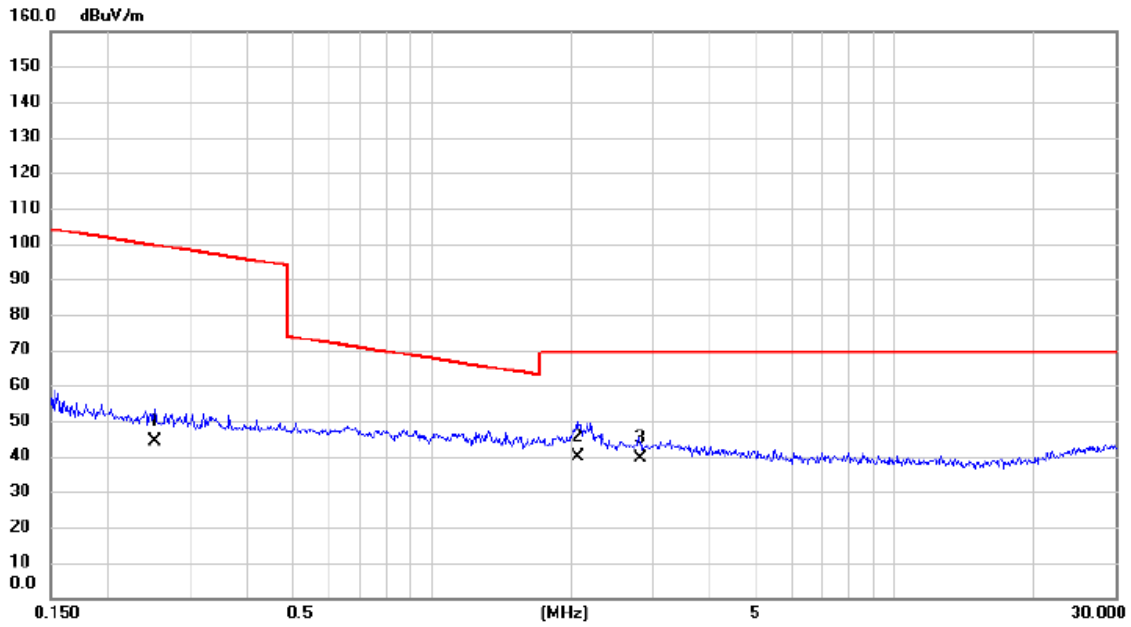

No. Mk.	Freq. MHz	Reading Level dBuV	Correct Factor dB	Measure- ment dBuV/m	Limit dBuV/m	Margin dB	Detector	Comment
1	0.252	32.37	11.87	44.24	99.58	-55.34	AVG	
2 *	2.077	28.11	11.52	39.63	69.54	-29.91	QP	
3	2.824	28.05	11.18	39.23	69.54	-30.31	QP	



Test Mode: DCS1900\_TX CH512\_GSM

Vertical

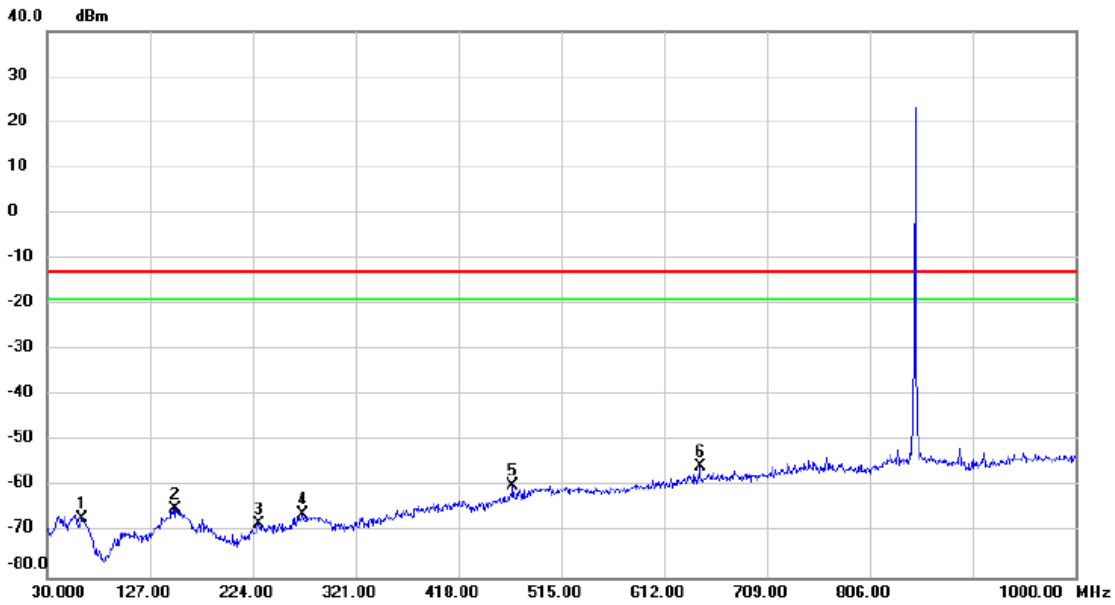

No.	Mk.	Freq. MHz	Reading Level dBm	Correct Factor dB	Measure- ment dBm	Limit dBm	Margin dB	Detector	Comment
1		62.980	-72.00	5.00	-67.00	-13.00	-54.00	peak	
2		151.250	-74.73	9.89	-64.84	-13.00	-51.84	peak	
3		229.820	-74.16	6.08	-68.08	-13.00	-55.08	peak	
4		271.530	-74.15	7.97	-66.18	-13.00	-53.18	peak	
5		469.410	-73.92	14.19	-59.73	-13.00	-46.73	peak	
6	*	645.950	-72.30	16.73	-55.57	-13.00	-42.57	peak	

Test Mode: DCS1900\_TX CH512\_GSM

### Horizontal

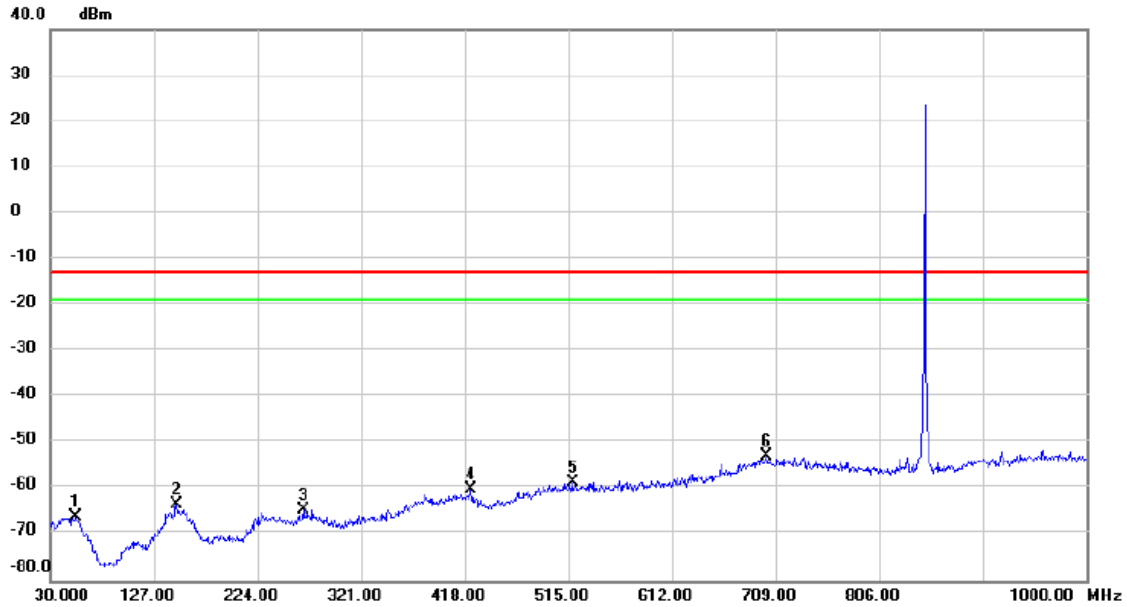

No. Mk.	Freq. MHz	Reading Level dBm	Correct Factor dB	Measure- ment dBm	Limit dBm	Margin dB	Detector	Comment
1	53.280	-71.01	4.95	-66.06	-13.00	-53.06	peak	
2	148.340	-73.34	10.02	-63.32	-13.00	-50.32	peak	
3	266.680	-72.19	7.66	-64.53	-13.00	-51.53	peak	
4	423.820	-73.80	13.65	-60.15	-13.00	-47.15	peak	
5	518.880	-73.30	14.62	-58.68	-13.00	-45.68	peak	
6 *	700.270	-70.39	17.44	-52.95	-13.00	-39.95	peak	

Test Mode: DCS1900\_TX CH512\_GSM

Vertical

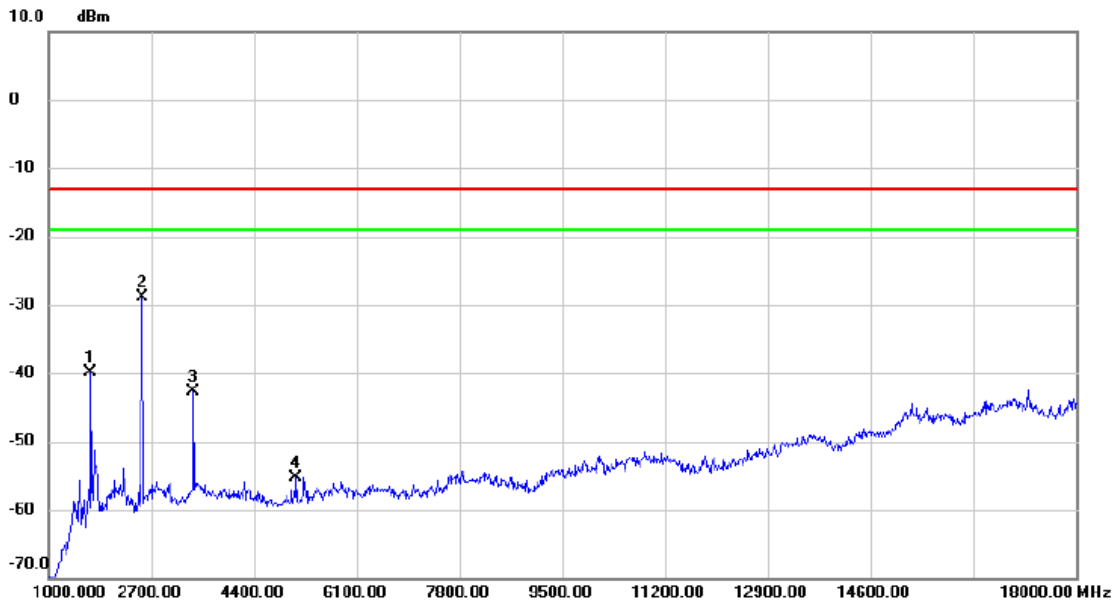

No.	Mk.	Freq. MHz	Reading Level dBm	Correct Factor dB	Measure- ment dBm	Limit dBm	Margin dB	Detector	Comment
1		1697.000	-30.92	-9.00	-39.92	-13.00	-26.92	peak	
2	*	2547.000	-23.52	-5.35	-28.87	-13.00	-15.87	peak	
3		3397.000	-38.87	-3.81	-42.68	-13.00	-29.68	peak	
4		5097.000	-58.40	3.05	-55.35	-13.00	-42.35	peak	

Test Mode: DCS1900\_TX CH512\_GSM

Horizontal

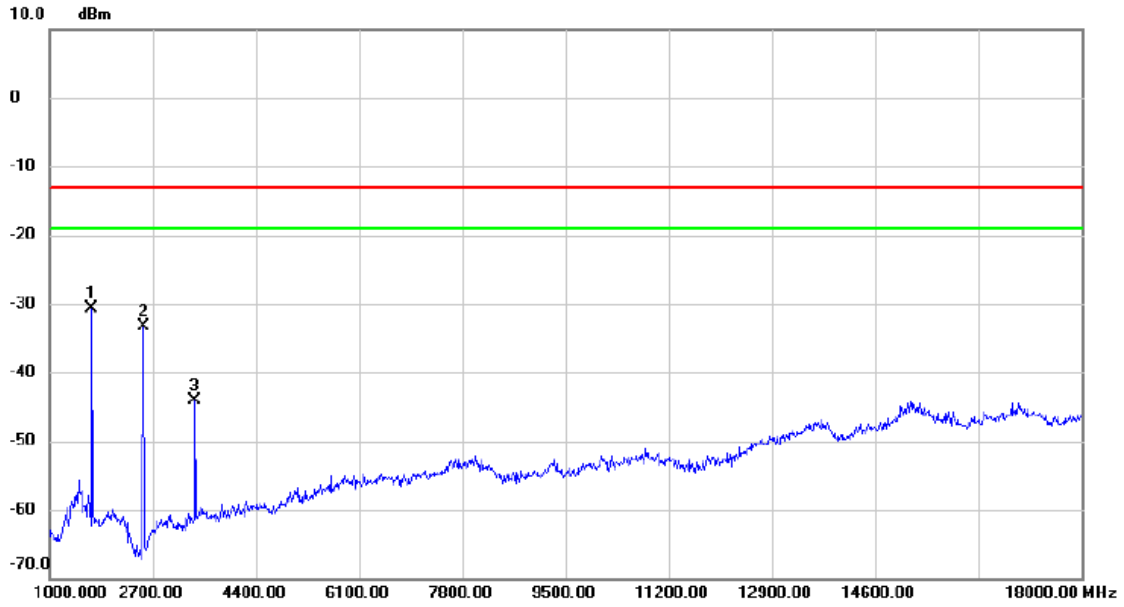

No.	Mk.	Freq. MHz	Reading Level dBm	Correct Factor dB	Measure- ment dBm	Limit dBm	Margin dB	Detector	Comment
1	*	1697.000	-21.71	-9.00	-30.71	-13.00	-17.71	peak	
2		2547.000	-27.97	-5.35	-33.32	-13.00	-20.32	peak	
3		3397.000	-40.31	-3.81	-44.12	-13.00	-31.12	peak	

Test Mode: DCS1900\_TX CH512\_EDGE

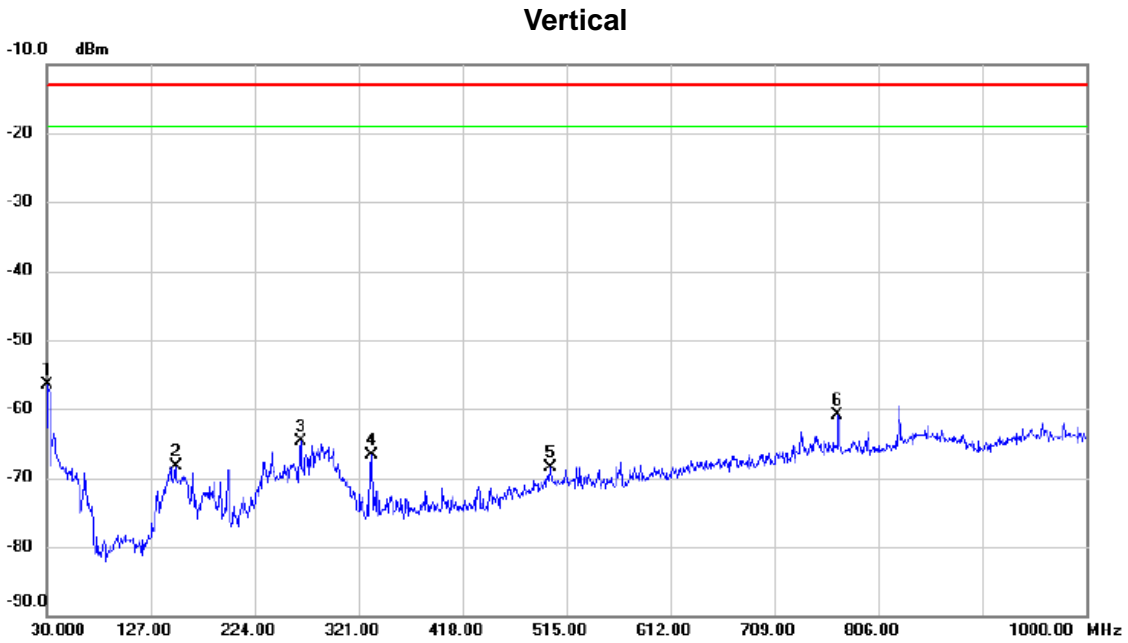

No.	Mk.	Freq. MHz	Reading Level dBm	Correct Factor dB	Measure- ment dBm	Limit dBm	Margin dB	Detector	Comment
1	*	30.970	-53.76	-2.77	-56.53	-13.00	-43.53	peak	
2		150.280	-68.28	-0.04	-68.32	-13.00	-55.32	peak	
3		266.680	-62.34	-2.34	-64.68	-13.00	-51.68	peak	
4		333.610	-66.96	0.25	-66.71	-13.00	-53.71	peak	
5		499.480	-72.94	4.52	-68.42	-13.00	-55.42	peak	
6		768.170	-69.99	9.09	-60.90	-13.00	-47.90	peak	

Test Mode: DCS1900\_TX CH512\_EDGE

Horizontal

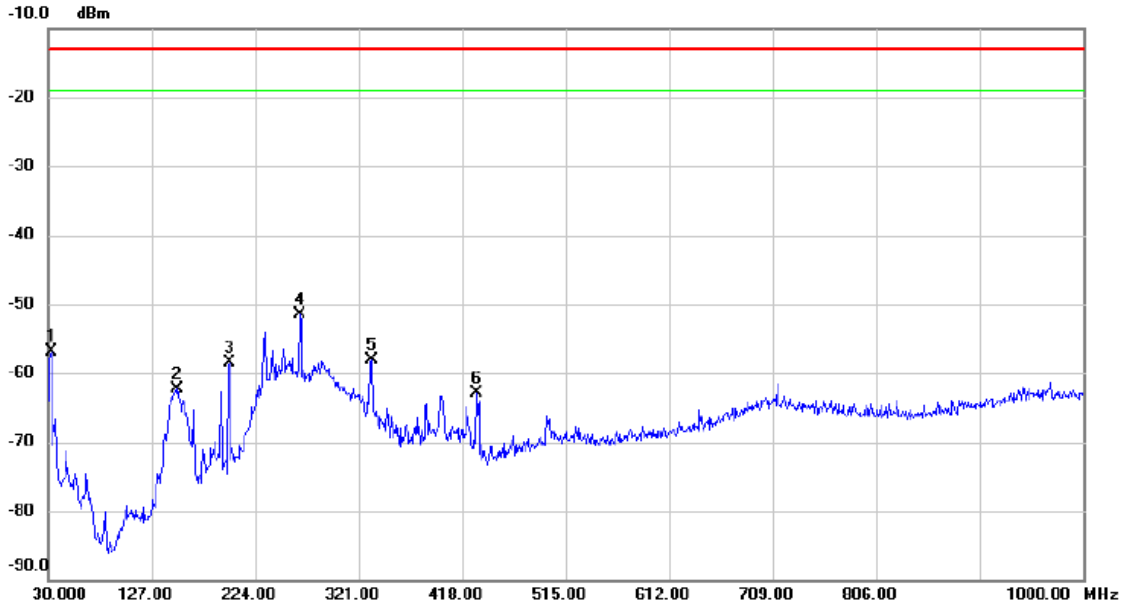

No.	Mk.	Freq. MHz	Reading Level dBm	Correct Factor dB	Measure- ment dBm	Limit dBm	Margin dB	Detector	Comment
1		32.910	-52.39	-4.53	-56.92	-13.00	-43.92	peak	
2		151.250	-62.19	-0.11	-62.30	-13.00	-49.30	peak	
3		199.750	-54.43	-4.13	-58.56	-13.00	-45.56	peak	
4	*	265.710	-49.07	-2.39	-51.46	-13.00	-38.46	peak	
5		333.610	-58.31	0.25	-58.06	-13.00	-45.06	peak	
6		431.580	-66.59	3.75	-62.84	-13.00	-49.84	peak	

Test Mode: DCS1900\_TX CH512\_EDGE

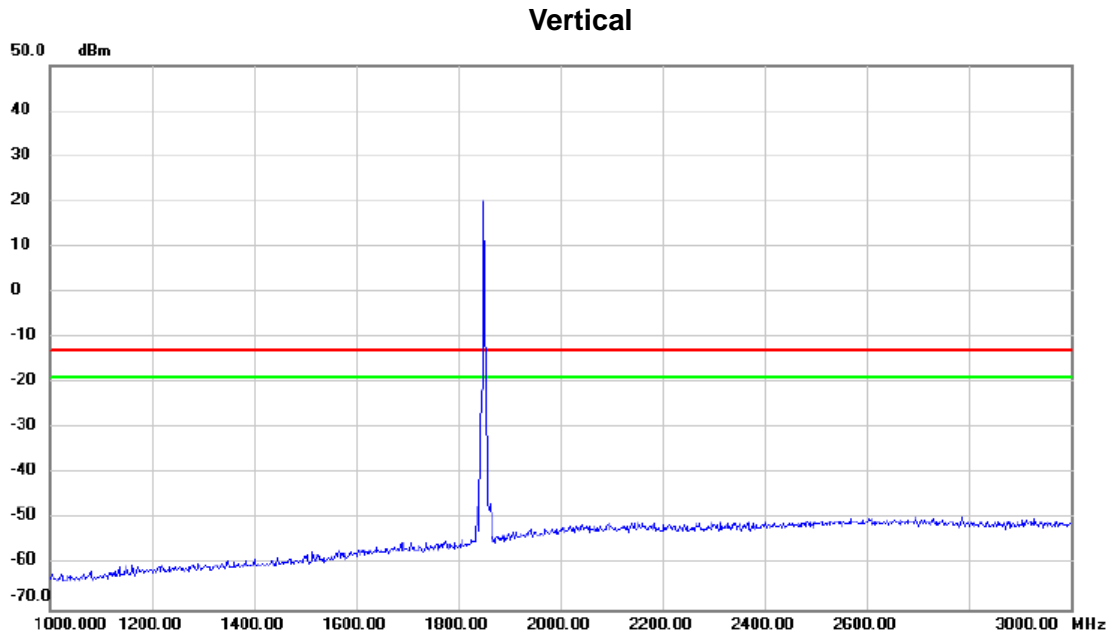

No.	Mk.	Freq.	Reading Level	Correct Factor	Measurement	Limit	Margin	Detector	Comment
		MHz	dBm	dB	dBm	dBm	dB		
		1880.00	20.0		20.0	-15.0	5.0		

Test Mode: DCS1900\_TX CH512\_EDGE

Horizontal

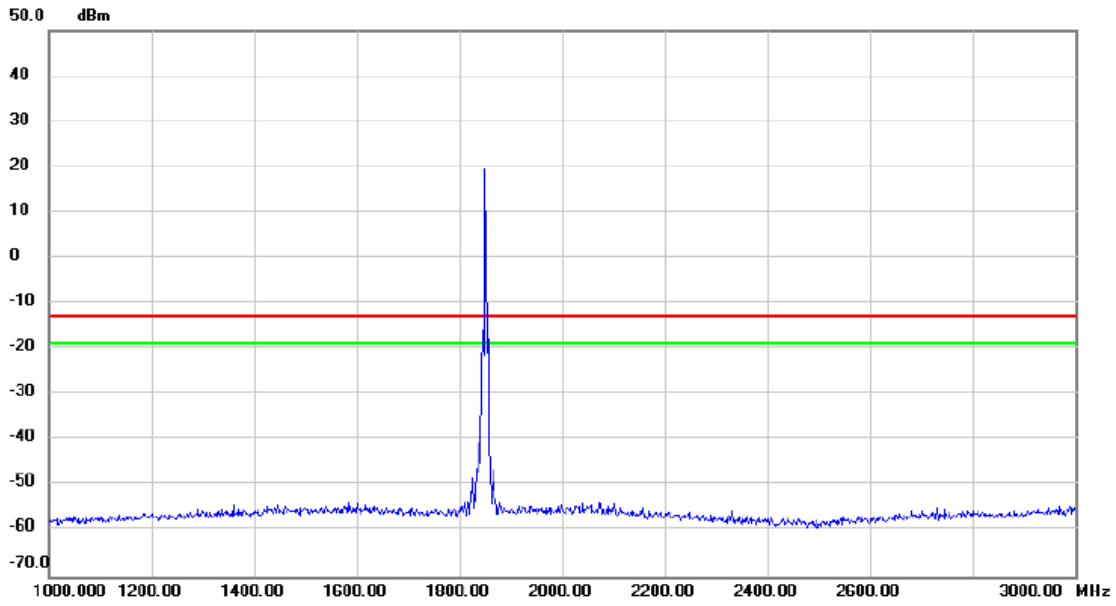

No.	Mk.	Freq.	Reading Level	Correct Factor	Measurement	Limit	Margin	Detector	Comment
		MHz	dBm	dB	dBm	dBm	dB		
		1750.00	20.00		20.00	-15.00	35.00		



Test Mode: DCS1900\_TX CH512\_EDGE

Vertical

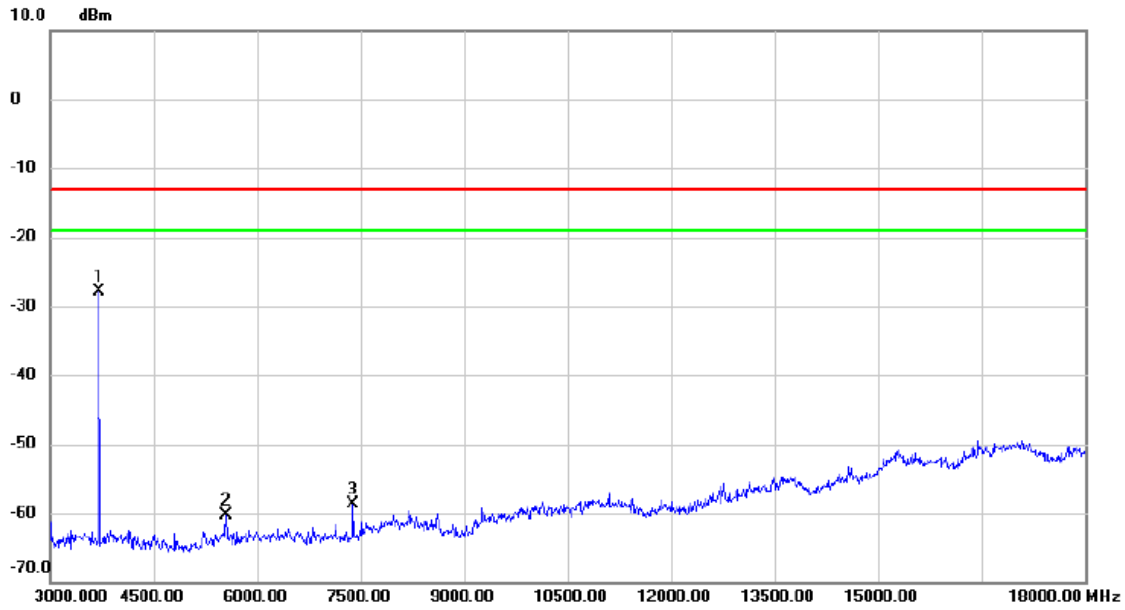

No.	Mk.	Freq. MHz	Reading Level dBm	Correct Factor dB	Measure- ment dBm	Limit dBm	Margin dB	Detector	Comment
1	*	3705.000	-25.80	-2.11	-27.91	-13.00	-14.91	peak	
2		5550.000	-64.25	4.00	-60.25	-13.00	-47.25	peak	
3		7395.000	-68.49	9.70	-58.79	-13.00	-45.79	peak	

Test Mode: DCS1900\_TX CH512\_EDGE

Horizontal

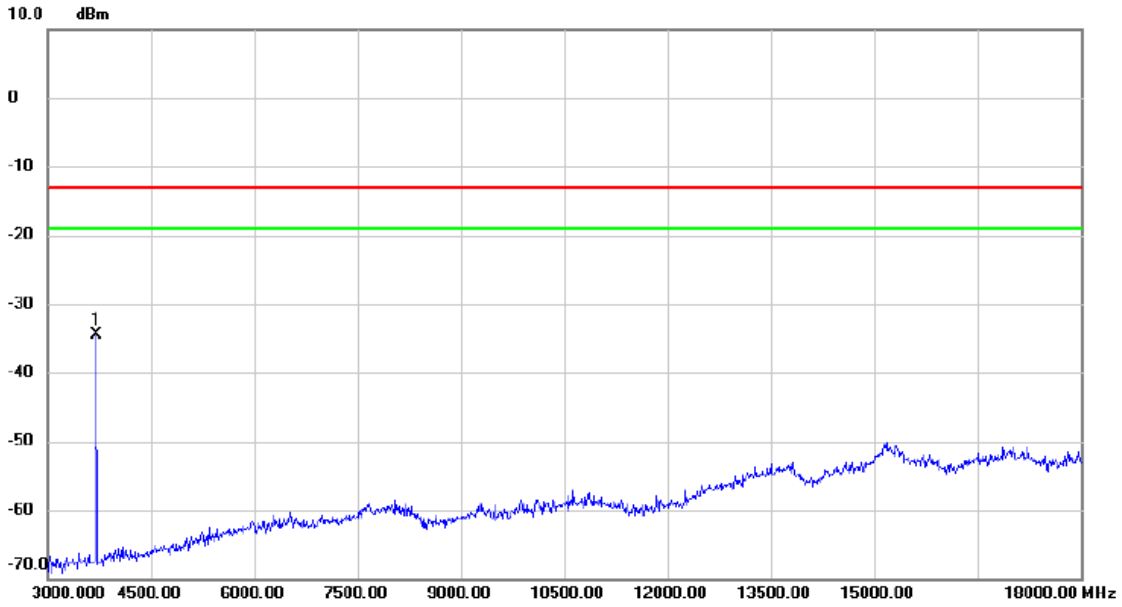

No.	Mk.	Freq. MHz	Reading Level dBm	Correct Factor dB	Measure- ment dBm	Limit dBm	Margin dB	Detector	Comment
1	*	3705.000	-32.37	-2.11	-34.48	-13.00	-21.48	peak	

Test Mode: DCS1900\_TX CH512\_EDGE

Vertical

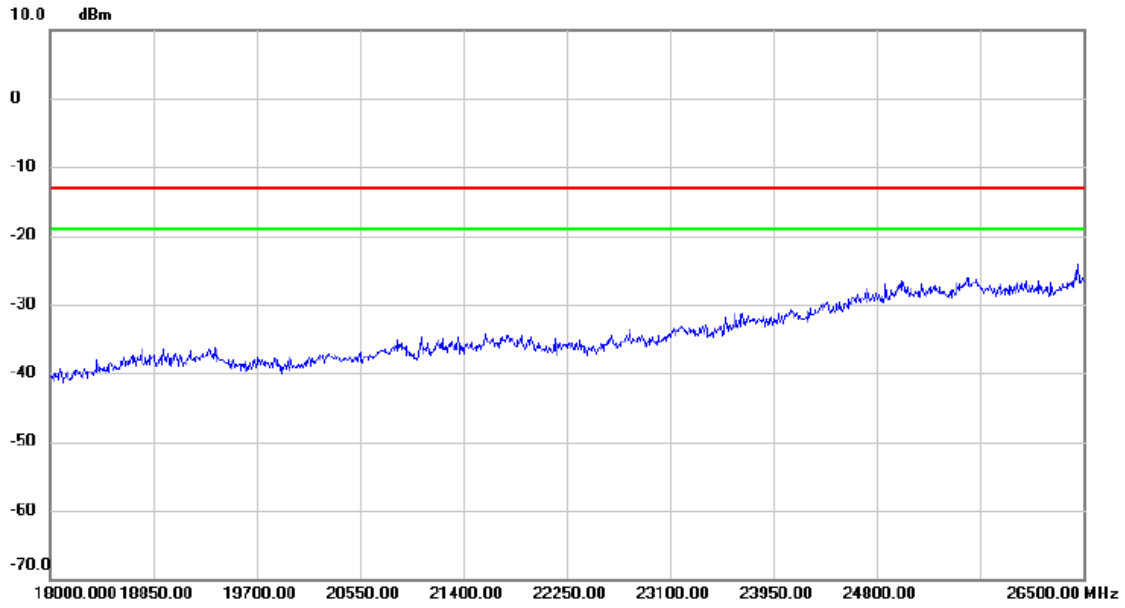

No.	Mk.	Freq. MHz	Reading Level dBm	Correct Factor dB	Measure- ment dBm	Limit dBm	Margin dB	Detector	Comment

Test Mode: DCS1900\_TX CH512\_EDGE

Horizontal

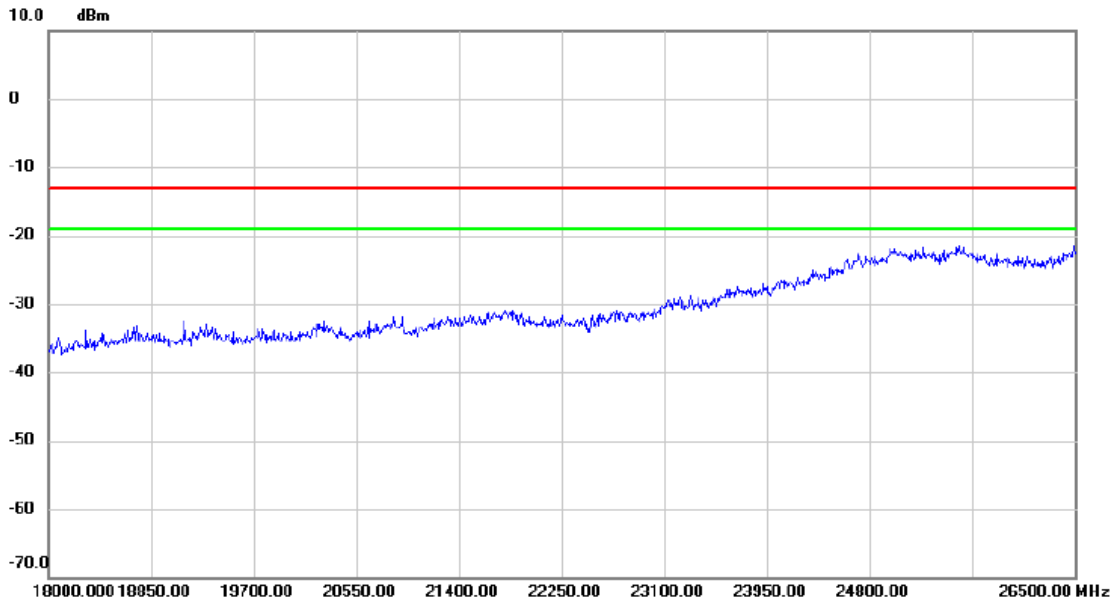

No.	Mk.	Freq.	Reading Level	Correct Factor	Measurement	Limit	Margin	Detector	Comment
		MHz	dBm	dB	dBm	dBm	dB		

Test Mode: WCDMA Band II\_TX CH9400

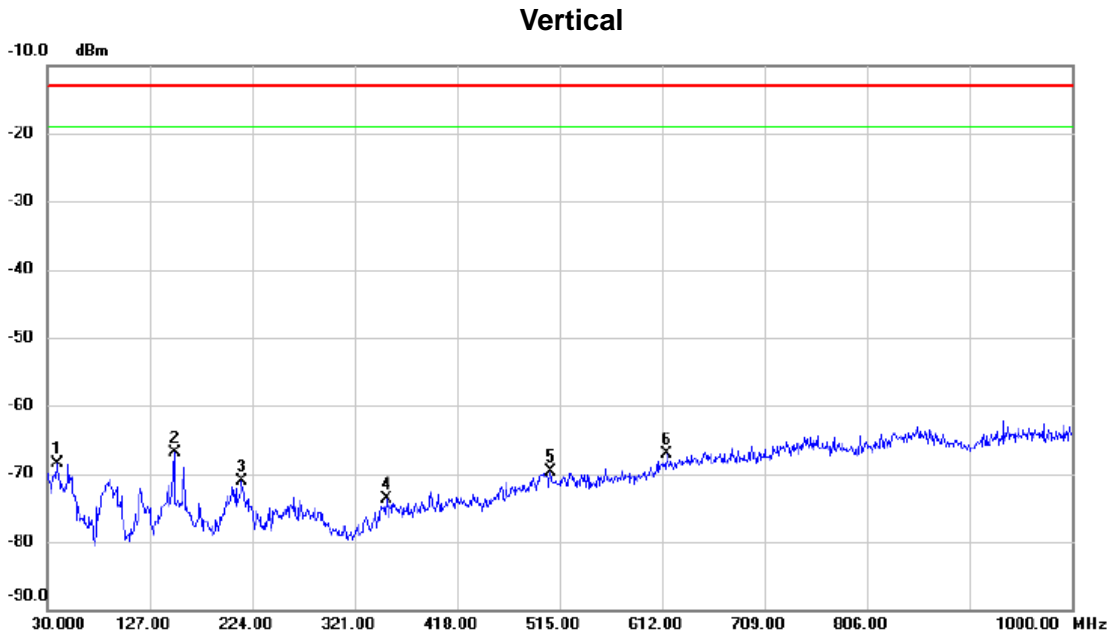

No.	Mk.	Freq. MHz	Reading Level dBm	Correct Factor dB	Measure- ment dBm	Limit dBm	Margin dB	Detector	Comment
1		39.700	-59.54	-8.93	-68.47	-13.00	-55.47	peak	
2	*	150.280	-66.84	-0.04	-66.88	-13.00	-53.88	peak	
3		214.300	-65.95	-5.06	-71.01	-13.00	-58.01	peak	
4		351.070	-74.73	0.95	-73.78	-13.00	-60.78	peak	
5		506.270	-74.34	4.56	-69.78	-13.00	-56.78	peak	
6		615.880	-73.34	6.27	-67.07	-13.00	-54.07	peak	

Test Mode: WCDMA Band II\_TX CH9400

### Horizontal

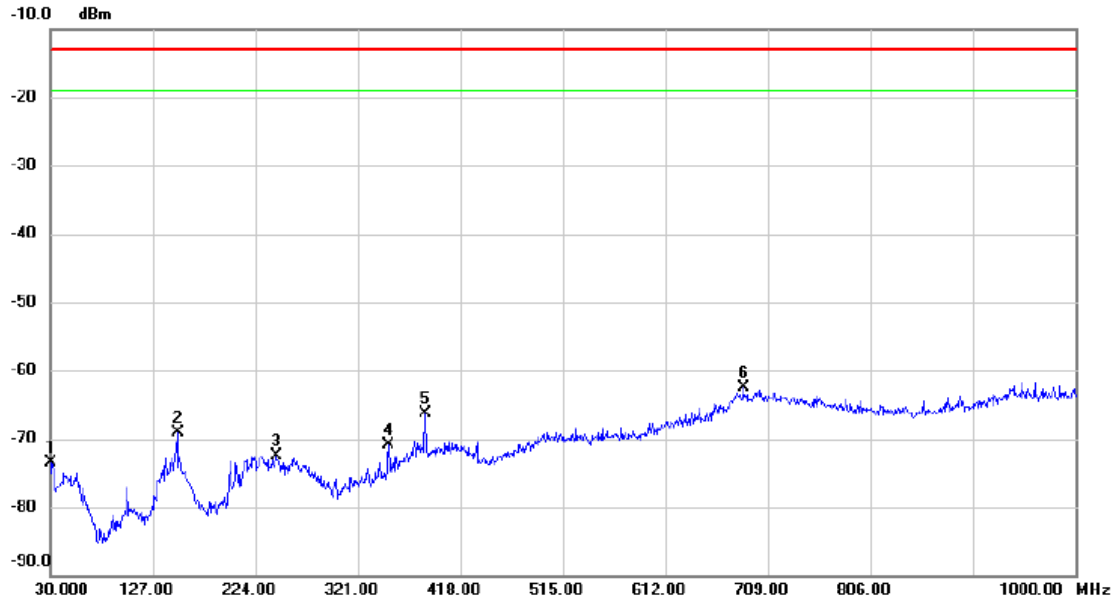

No.	Mk.	Freq. MHz	Reading Level dBm	Correct Factor dB	Measure- ment dBm	Limit dBm	Margin dB	Detector	Comment
1		30.970	-70.77	-2.77	-73.54	-13.00	-60.54	peak	
2		150.280	-69.09	-0.04	-69.13	-13.00	-56.13	peak	
3		243.400	-69.40	-3.17	-72.57	-13.00	-59.57	peak	
4		350.100	-71.71	0.90	-70.81	-13.00	-57.81	peak	
5		385.020	-68.91	2.62	-66.29	-13.00	-53.29	peak	
6 *		685.720	-69.72	7.25	-62.47	-13.00	-49.47	peak	

Test Mode: WCDMA Band II\_TX CH9400

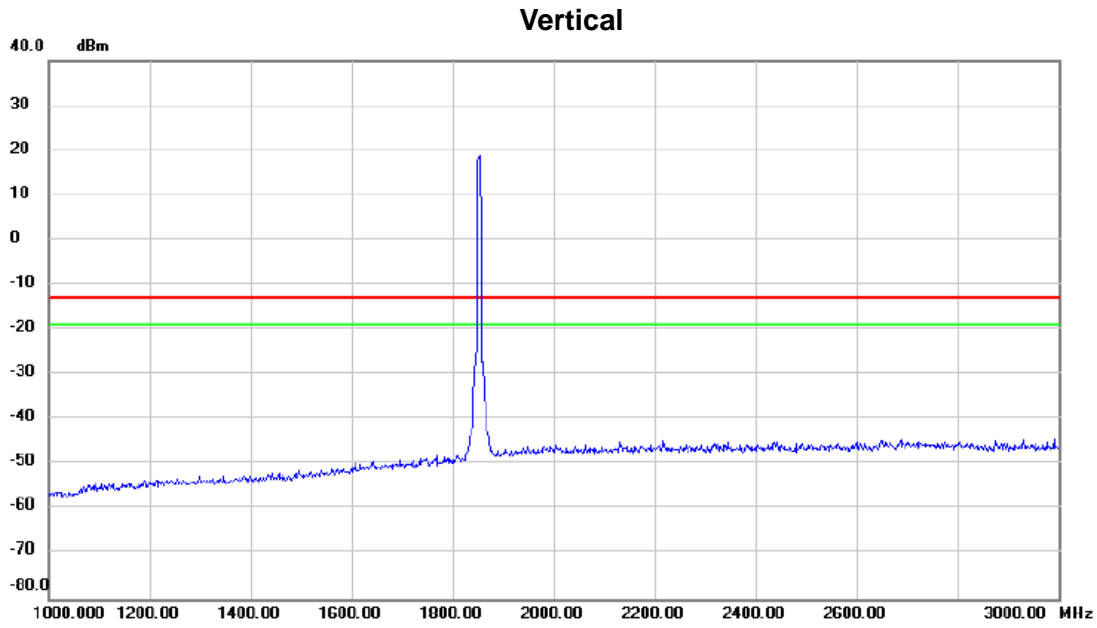

No.	Mk.	Freq.	Reading Level	Correct Factor	Measurement	Limit	Margin	Detector	Comment
		MHz	dBm	dB	dBm	dBm	dB		
		1800.00	18.00	0.00	18.00	-15.00	33.00		

Test Mode: WCDMA Band II\_TX CH9400

Horizontal

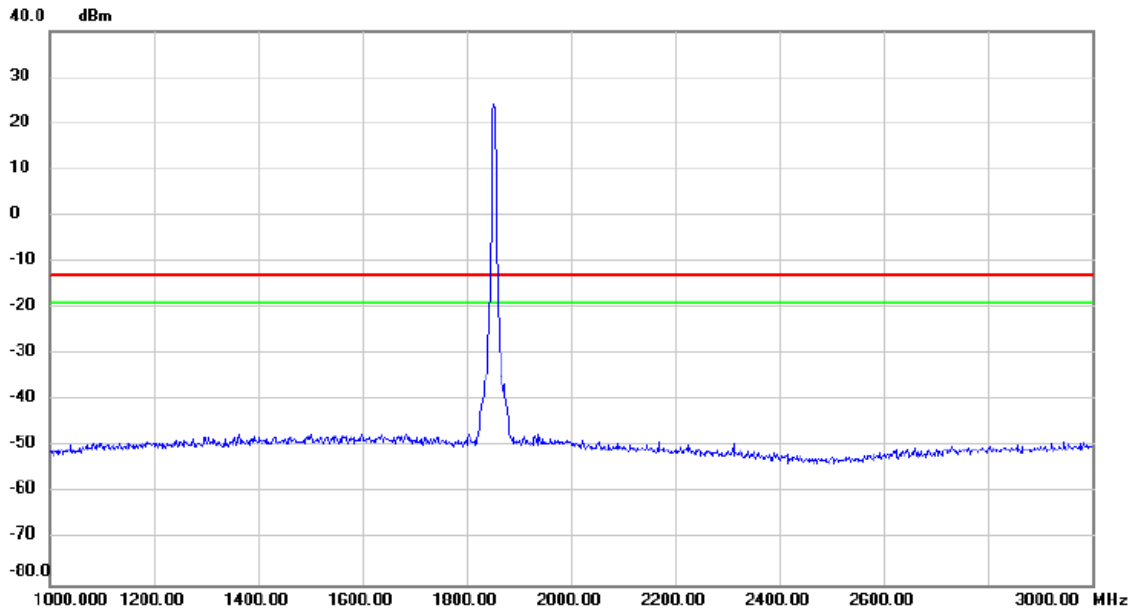

No.	Mk.	Freq.	Reading Level	Correct Factor	Measurement	Limit	Margin	Detector	Comment
		MHz	dBm	dB	dBm	dBm	dB		
		1900.00	25.00	0.00	25.00	-15.00	40.00		



Test Mode: WCDMA Band II\_TX CH9400

Vertical

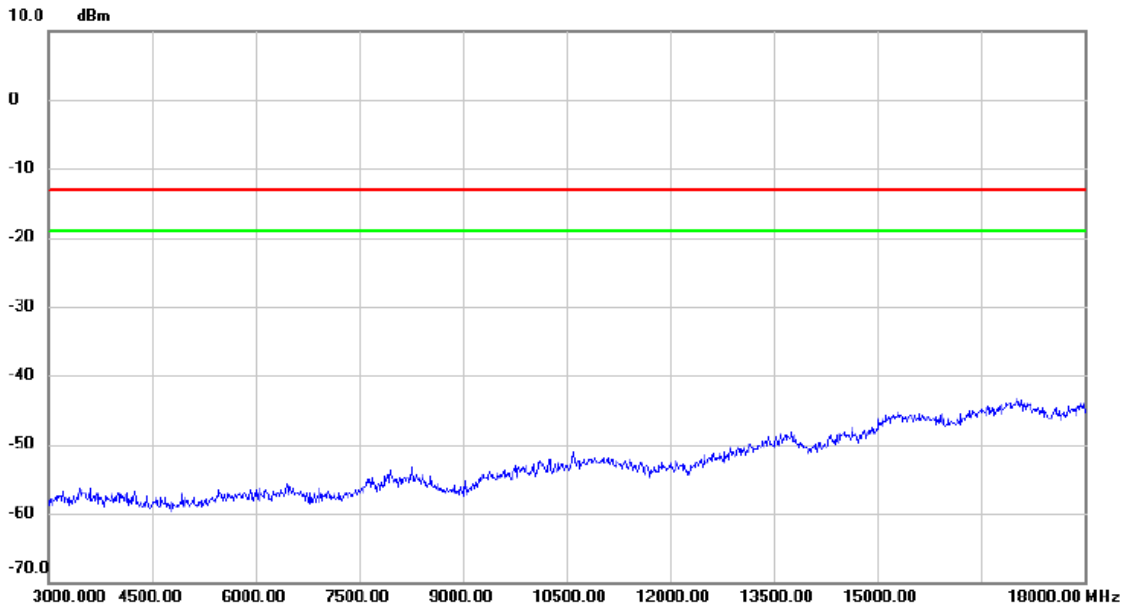

No.	Mk.	Freq.	Reading Level	Correct Factor	Measurement	Limit	Margin	Detector	Comment
		MHz	dBm	dB	dBm	dBm	dB		

Test Mode: WCDMA Band II\_TX CH9400

Horizontal

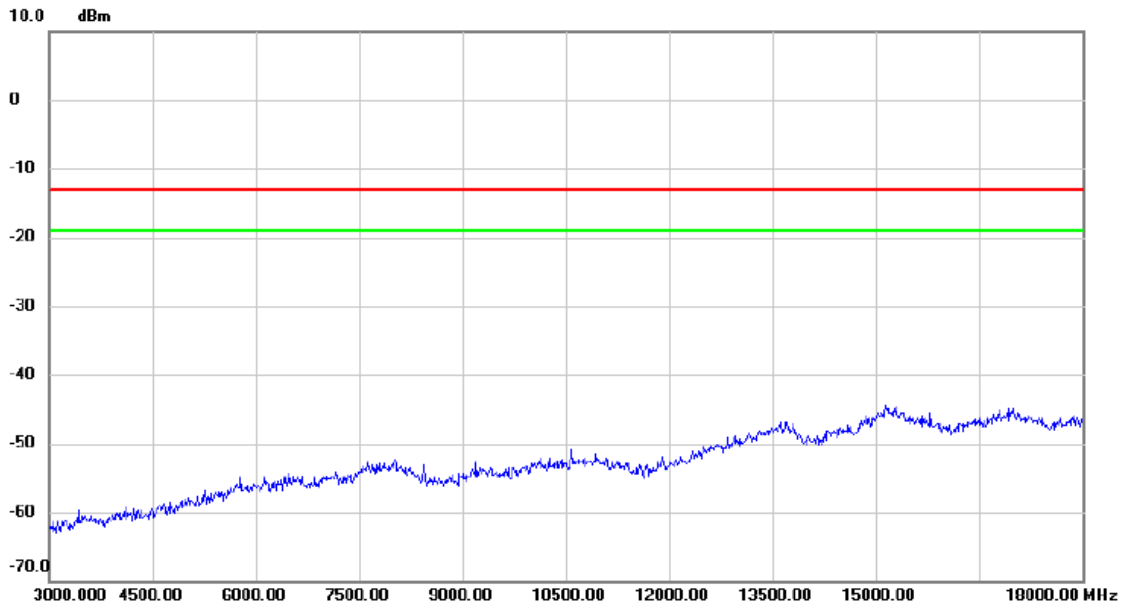

No.	Mk.	Freq.	Reading Level	Correct Factor	Measurement	Limit	Margin	Detector	Comment
		MHz	dBm	dB	dBm	dBm	dB		

Test Mode: WCDMA Band II\_TX CH9400

Vertical

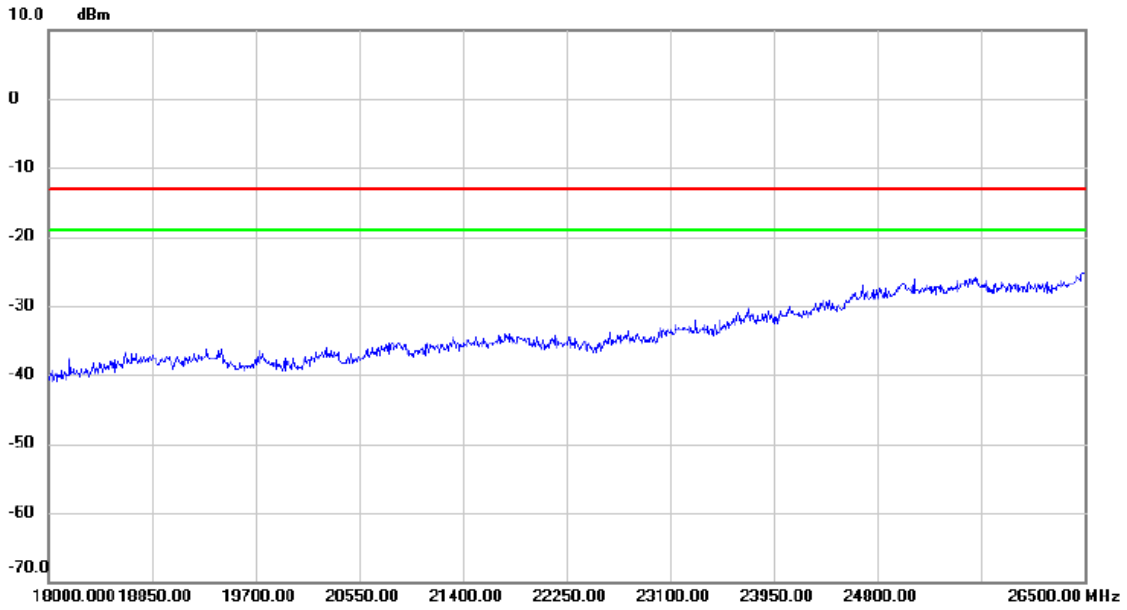

No.	Mk.	Freq.	Reading Level	Correct Factor	Measurement	Limit	Margin	Detector	Comment
		MHz	dBm	dB	dBm	dBm	dB		

Test Mode: WCDMA Band II\_TX CH9400

Horizontal

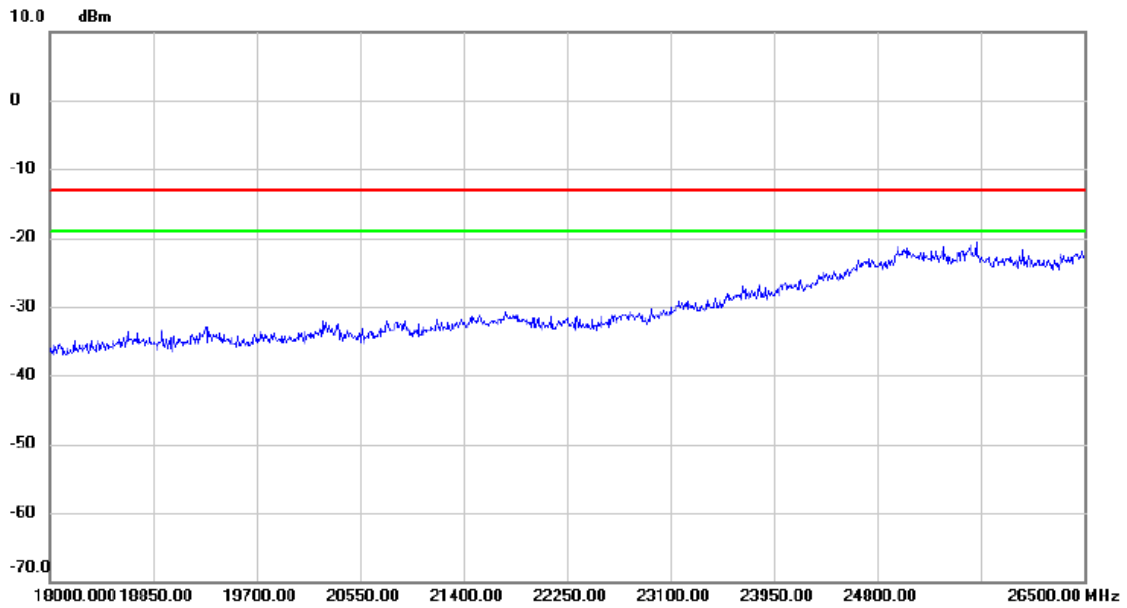

No.	Mk.	Freq.	Reading Level	Correct Factor	Measurement	Limit	Margin	Detector	Comment
		MHz	dBm	dB	dBm	dBm	dB		

Test Mode: WCDMA Band II\_HSDPA\_TX CH9400

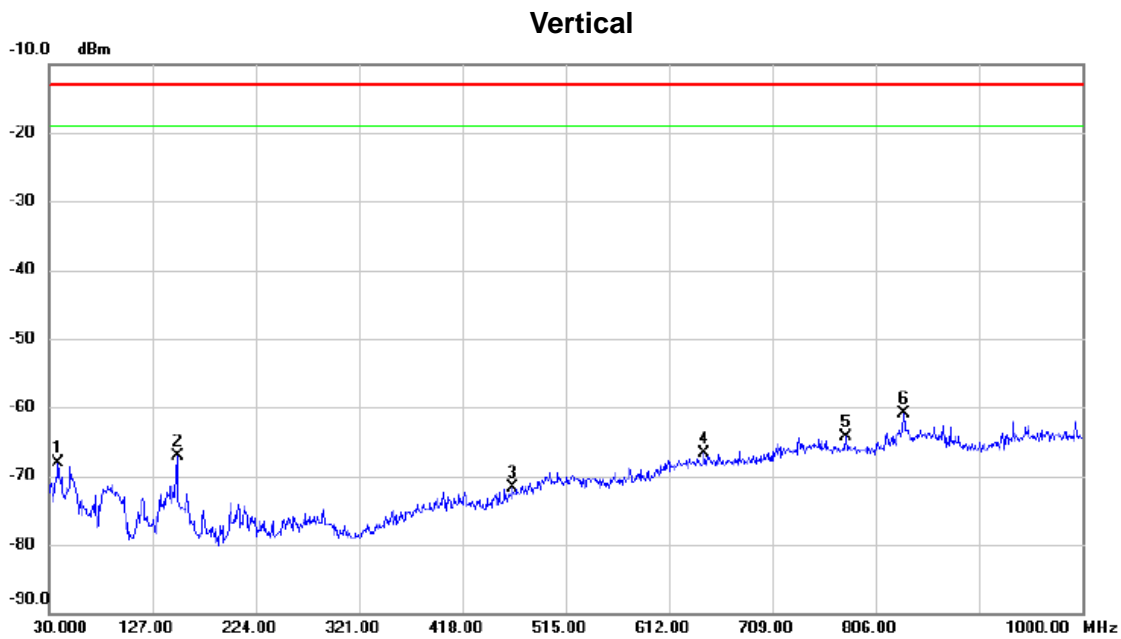

No.	Mk.	Freq. MHz	Reading Level dBm	Correct Factor dB	Measure- ment dBm	Limit dBm	Margin dB	Detector	Comment
1		38.730	-59.74	-8.41	-68.15	-13.00	-55.15	peak	
2		150.280	-67.01	-0.04	-67.05	-13.00	-54.05	peak	
3		464.560	-75.93	4.14	-71.79	-13.00	-58.79	peak	
4		644.980	-73.41	6.71	-66.70	-13.00	-53.70	peak	
5		777.870	-73.70	9.38	-64.32	-13.00	-51.32	peak	
6	*	832.190	-71.32	10.46	-60.86	-13.00	-47.86	peak	

Test Mode: WCDMA Band II\_HSDPA\_TX CH9400

### Horizontal

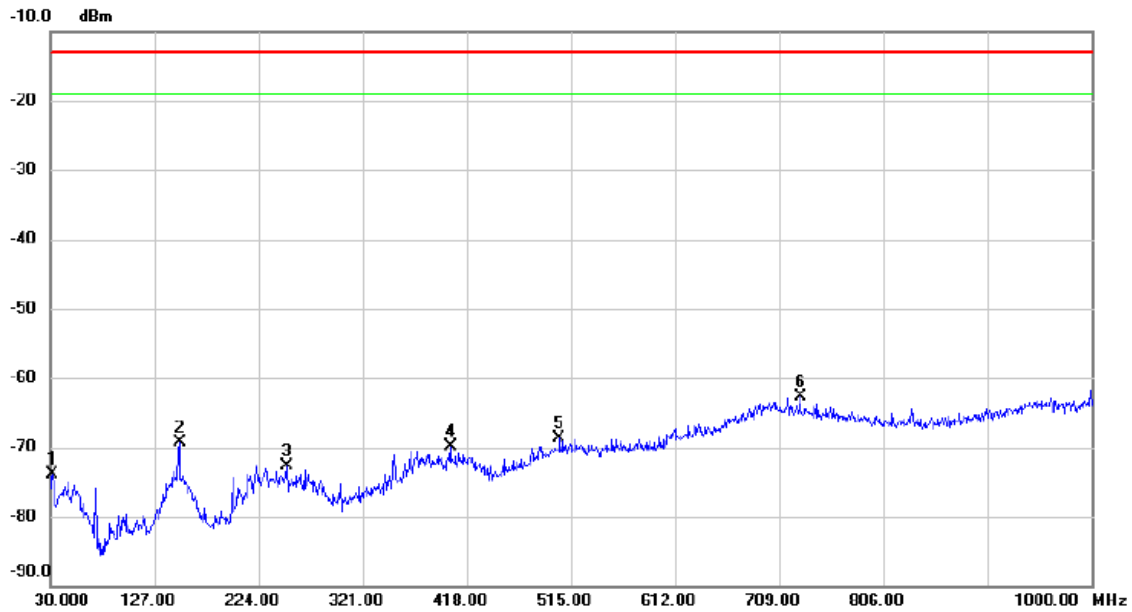

No.	Mk.	Freq. MHz	Reading Level dBm	Correct Factor dB	Measure- ment dBm	Limit dBm	Margin dB	Detector	Comment
1		31.940	-70.31	-3.65	-73.96	-13.00	-60.96	peak	
2		150.280	-69.33	-0.04	-69.37	-13.00	-56.37	peak	
3		250.190	-69.98	-2.76	-72.74	-13.00	-59.74	peak	
4		402.480	-73.22	3.38	-69.84	-13.00	-56.84	peak	
5		504.330	-73.24	4.55	-68.69	-13.00	-55.69	peak	
6	*	728.400	-70.80	8.05	-62.75	-13.00	-49.75	peak	

Test Mode: WCDMA Band II\_HSDPA\_TX CH9400

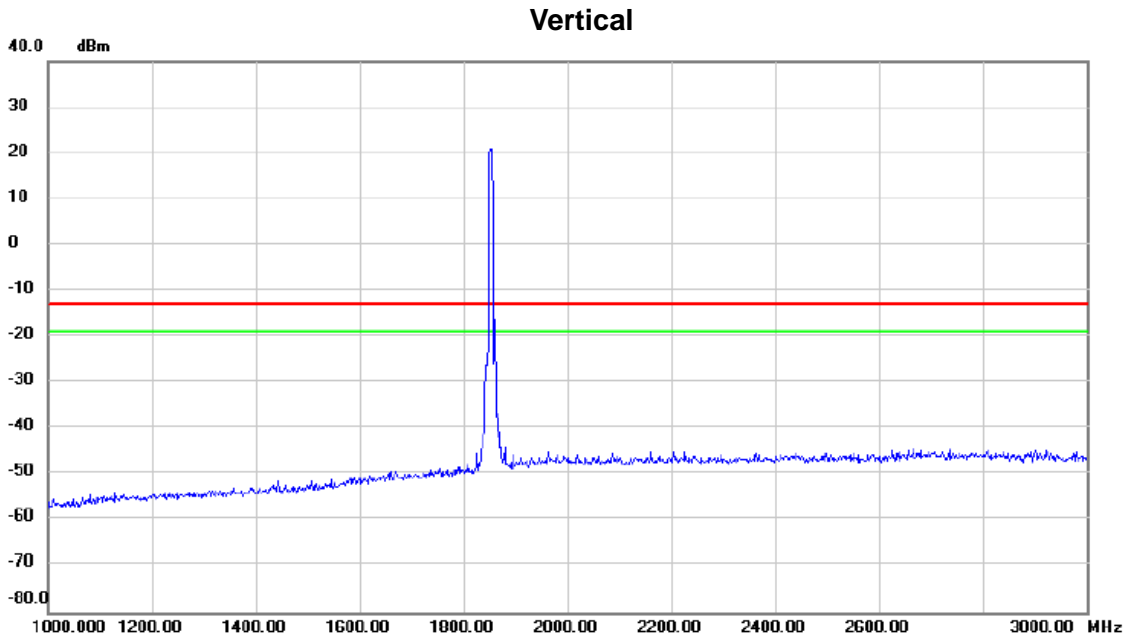

No.	Mk.	Freq. MHz	Reading Level dBm	Correct Factor dB	Measure- ment dBm	Limit dBm	Margin dB	Detector	Comment

Test Mode: WCDMA Band II\_HSDPA\_TX CH9400

**Horizontal**

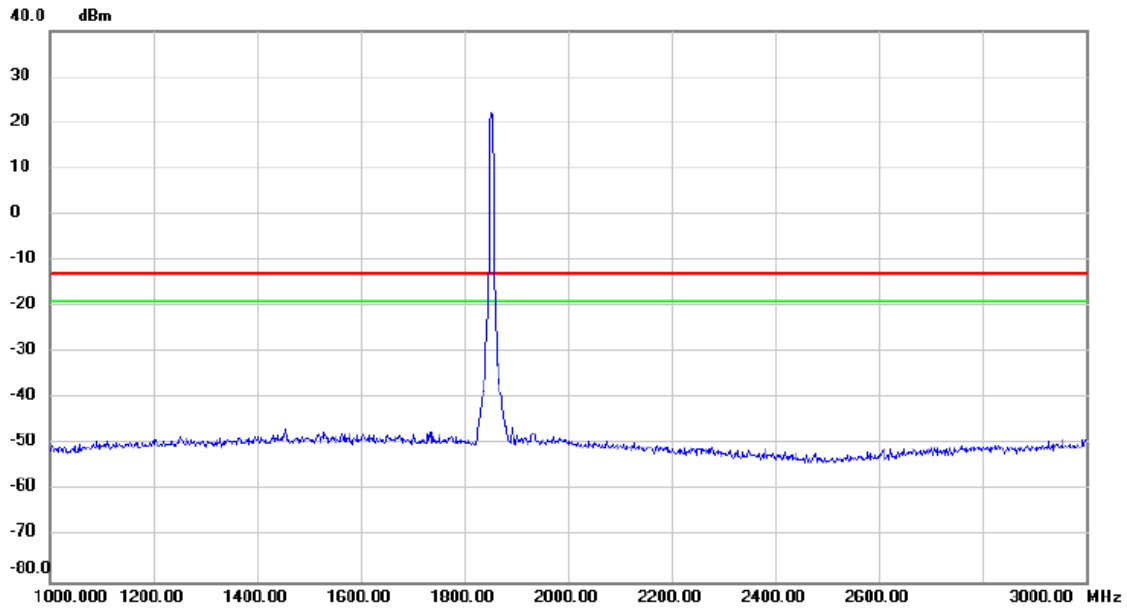

No.	Mk.	Freq.	Reading Level	Correct Factor	Measurement	Limit	Margin	Detector	Comment
		MHz	dBm	dB	dBm	dBm	dB		
		1880.00	20.00	0.00	20.00	-15.00	35.00		



Test Mode: WCDMA Band II\_HSDPA\_TX CH9400

Vertical

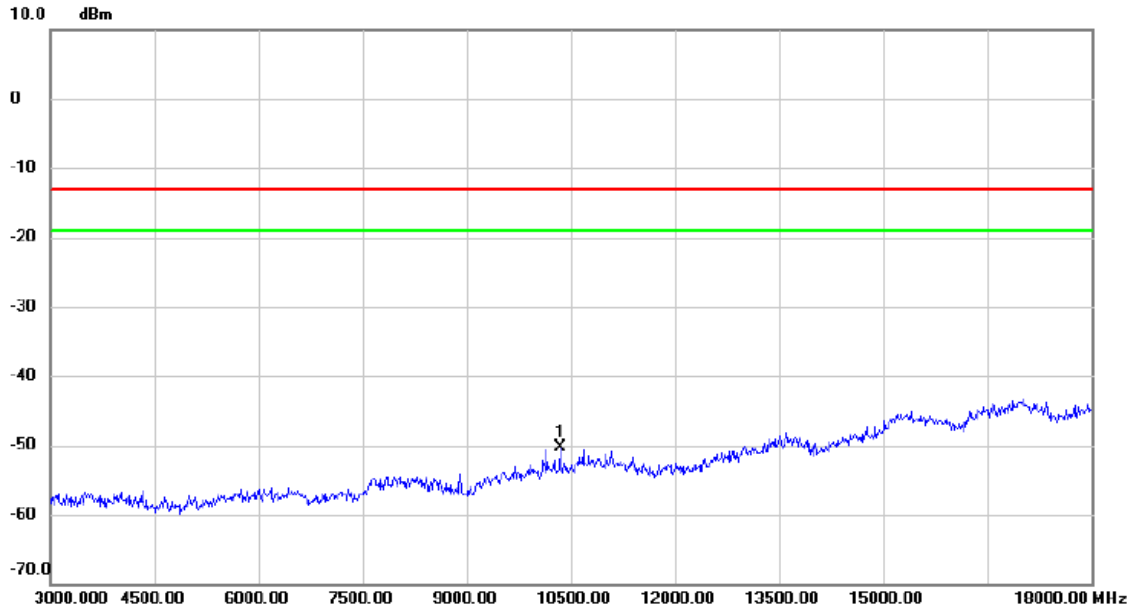

No. Mk.	Freq. MHz	Reading Level dBm	Correct Factor dB	Measure- ment dBm	Limit dBm	Margin dB	Detector	Comment
1 *	10350.000	-67.84	17.51	-50.33	-13.00	-37.33	peak	

Test Mode: WCDMA Band II\_HSDPA\_TX CH9400

Horizontal

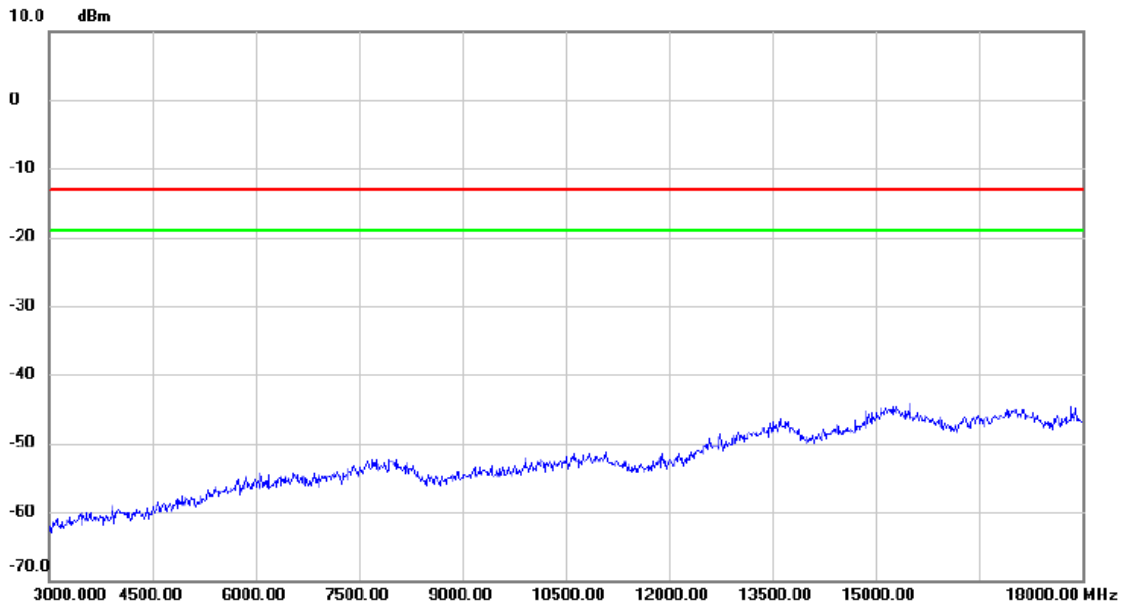

No.	Mk.	Freq. MHz	Reading Level dBm	Correct Factor dB	Measure- ment dBm	Limit dBm	Margin dB	Detector	Comment

Test Mode: WCDMA Band II\_HSDPA\_TX CH9400

Vertical

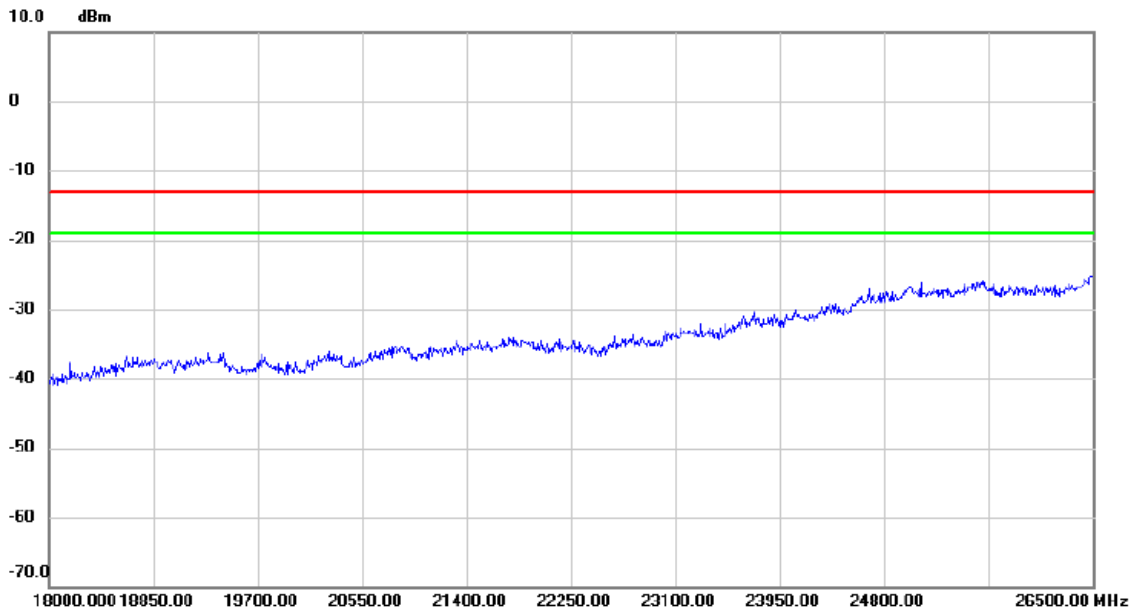

No.	Mk.	Freq. MHz	Reading Level dBm	Correct Factor dB	Measure- ment dBm	Limit dBm	Margin dB	Detector	Comment
-----	-----	--------------	-------------------------	-------------------------	-------------------------	--------------	--------------	----------	---------

Test Mode: WCDMA Band II\_HSDPA\_TX CH9400

**Horizontal**

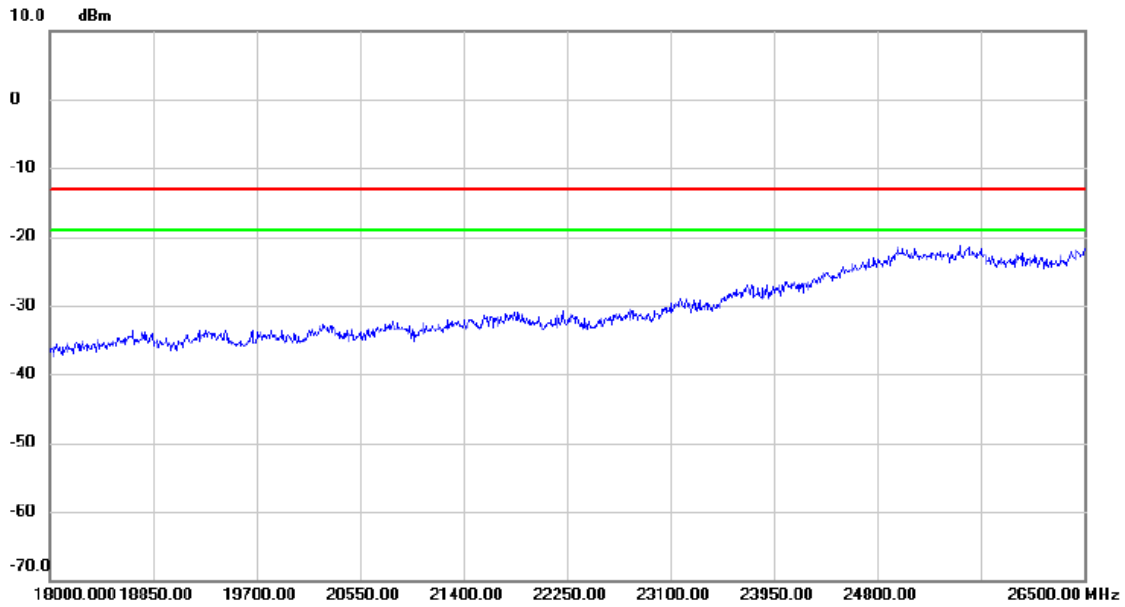

No.	Mk.	Freq.	Reading Level	Correct Factor	Measurement	Limit	Margin	Detector	Comment
		MHz	dBm	dB	dBm	dBm	dB		

Test Mode: WCDMA Band II\_HSUPA\_TX CH9400

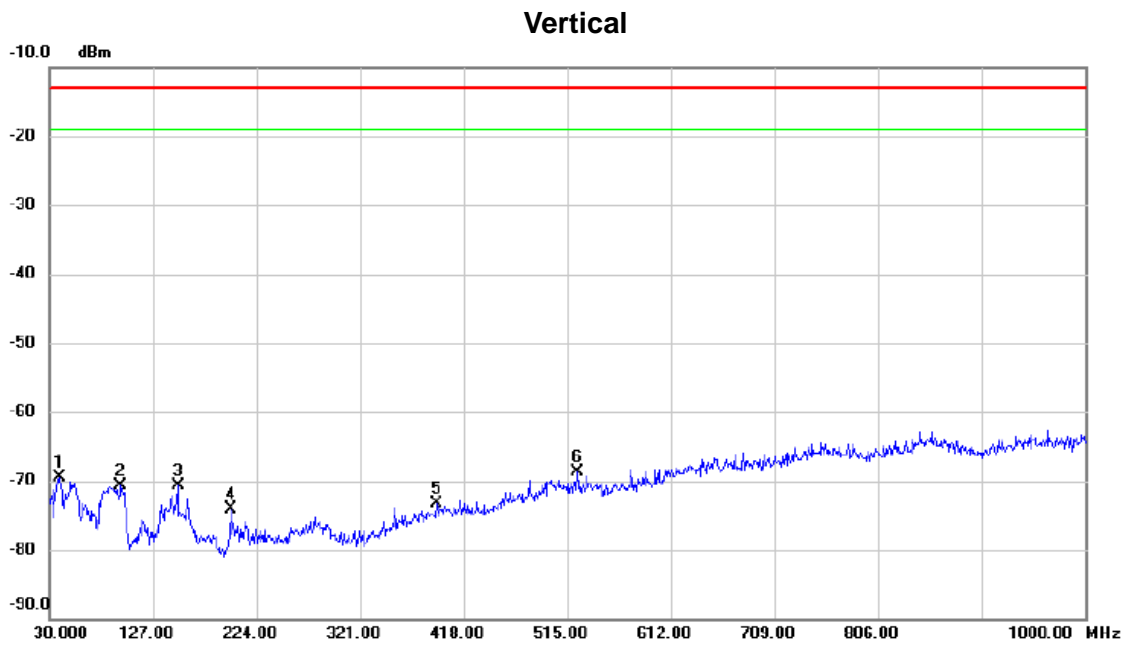

No.	Mk.	Freq. MHz	Reading Level dBm	Correct Factor dB	Measure- ment dBm	Limit dBm	Margin dB	Detector	Comment
1		39.700	-60.65	-8.93	-69.58	-13.00	-56.58	peak	
2		96.930	-67.91	-2.73	-70.64	-13.00	-57.64	peak	
3		150.280	-70.76	-0.04	-70.80	-13.00	-57.80	peak	
4		199.750	-69.88	-4.13	-74.01	-13.00	-61.01	peak	
5		392.780	-76.21	3.00	-73.21	-13.00	-60.21	peak	
6	*	524.700	-73.33	4.65	-68.68	-13.00	-55.68	peak	

Test Mode: WCDMA Band II\_HSUPA\_TX CH9400

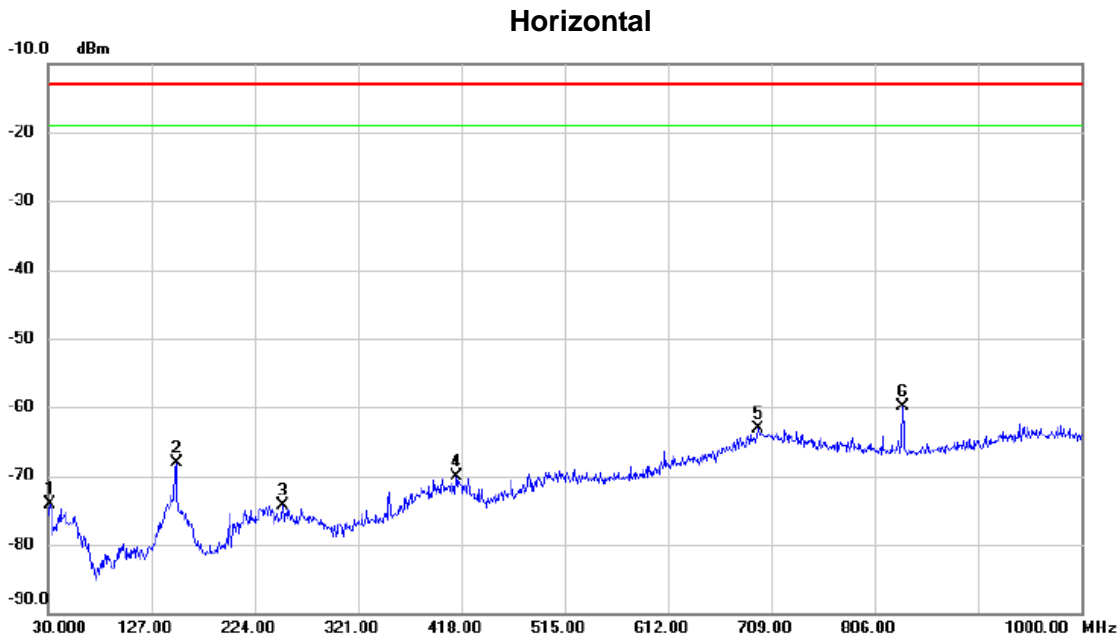

No. Mk.	Freq. MHz	Reading Level dBm	Correct Factor dB	Measure- ment dBm	Limit dBm	Margin dB	Detector	Comment
1	31.940	-70.52	-3.65	-74.17	-13.00	-61.17	peak	
2	150.280	-68.12	-0.04	-68.16	-13.00	-55.16	peak	
3	250.190	-71.44	-2.76	-74.20	-13.00	-61.20	peak	
4	413.150	-73.53	3.52	-70.01	-13.00	-57.01	peak	
5	696.390	-70.38	7.38	-63.00	-13.00	-50.00	peak	
6 *	832.190	-70.41	10.46	-59.95	-13.00	-46.95	peak	

Test Mode: WCDMA Band II\_HSUPA\_TX CH9400

**Vertical**

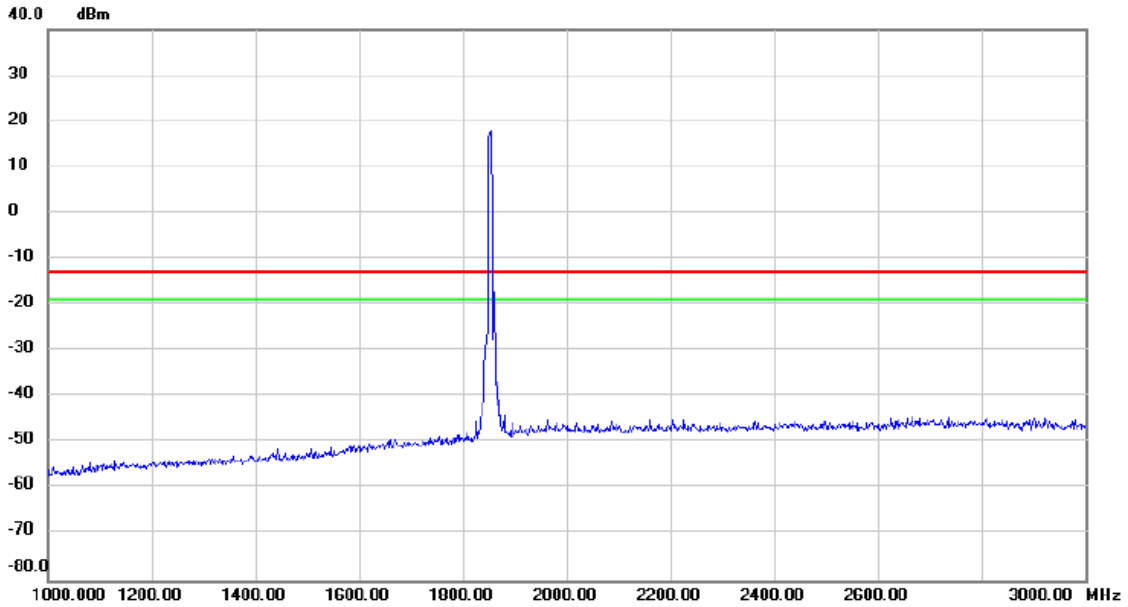

No.	Mk.	Freq. MHz	Reading Level dBm	Correct Factor dB	Measure- ment dBm	Limit dBm	Margin dB	Detector	Comment

Test Mode: WCDMA Band II\_HSUPA\_TX CH9400

**Horizontal**

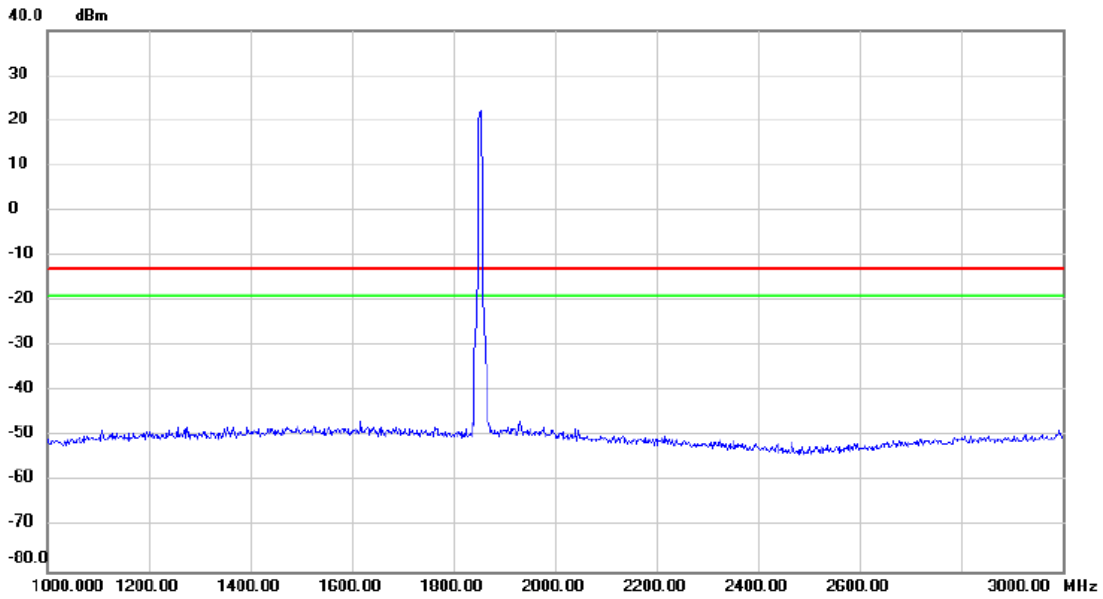

No.	Mk.	Freq.	Reading Level	Correct Factor	Measurement	Limit	Margin	Detector	Comment
		MHz	dBm	dB	dBm	dBm	dB		
		1920.00	22.00		22.00	-15.00	37.00		



Test Mode: WCDMA Band II\_HSUPA\_TX CH9400

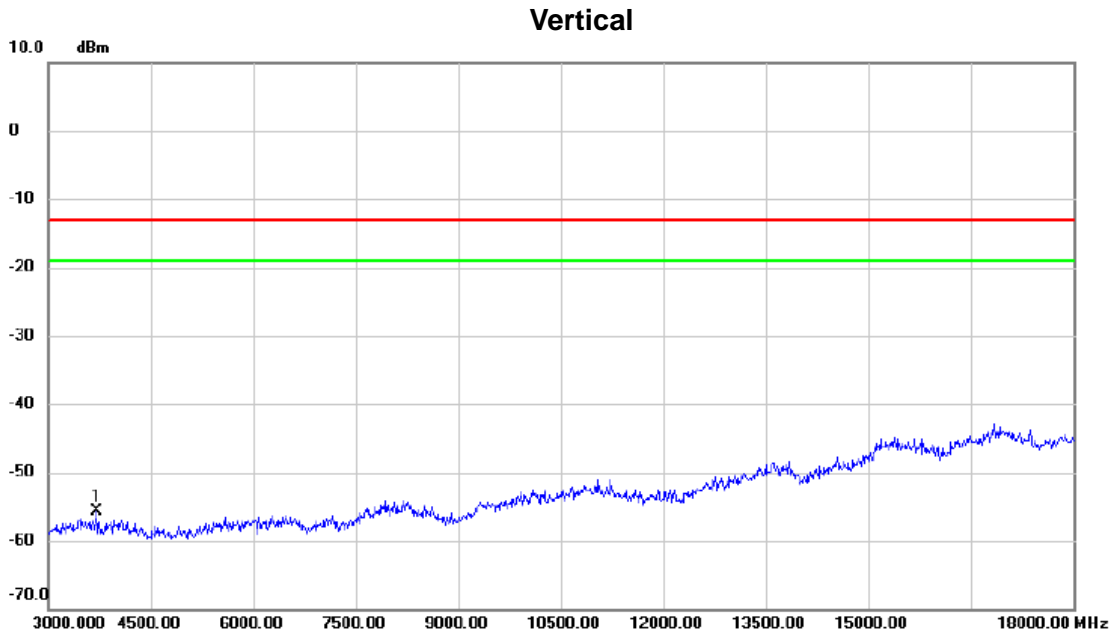

No.	Mk.	Freq.	Reading Level	Correct Factor	Measurement	Limit	Margin	Detector	Comment
		MHz	dBm	dB	dBm	dBm	dB		
1	*	3705.000	-53.59	-2.11	-55.70	-13.00	-42.70	peak	

Test Mode: WCDMA Band II\_HSUPA\_TX CH9400

Horizontal

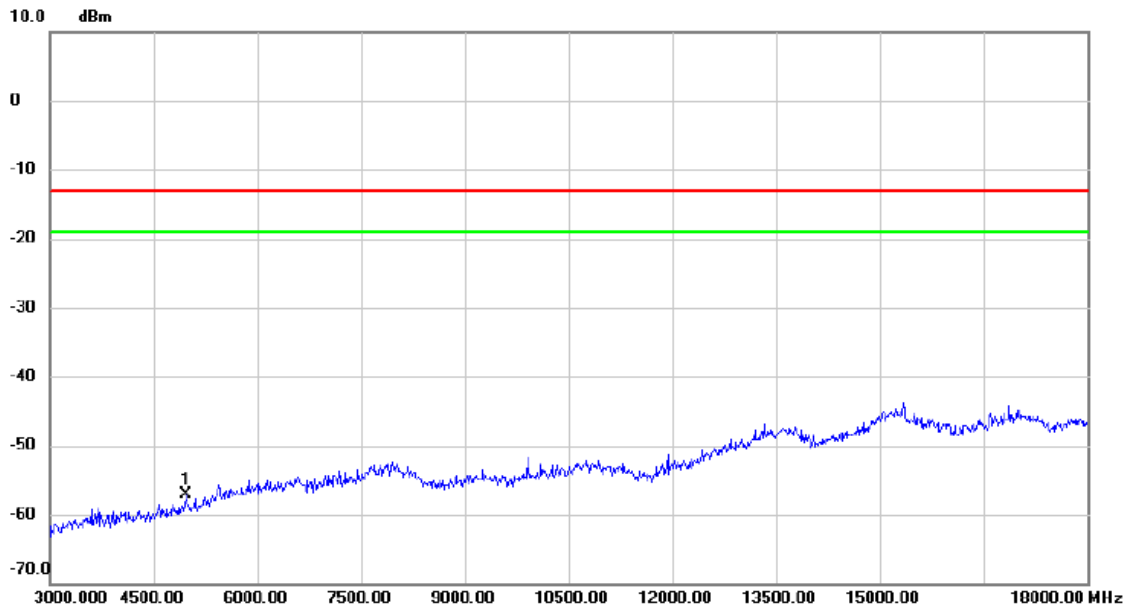

No.	Mk.	Freq. MHz	Reading Level dBm	Correct Factor dB	Measure- ment dBm	Limit dBm	Margin dB	Detector	Comment
1	*	4965.000	-59.95	2.76	-57.19	-13.00	-44.19	peak	

Test Mode: WCDMA Band II\_HSUPA\_TX CH9400

Vertical

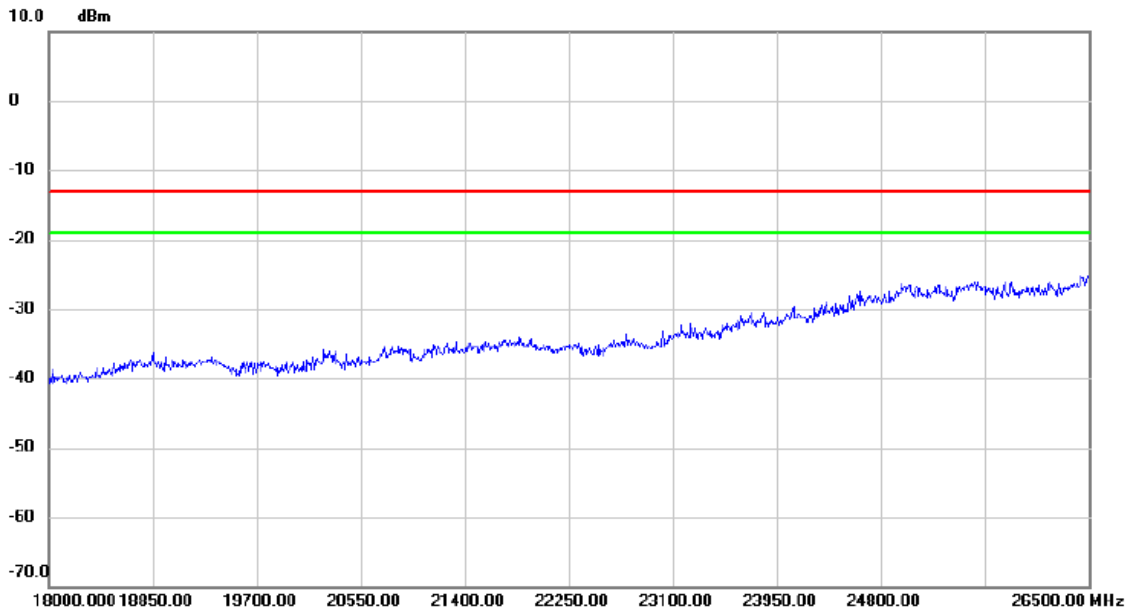

No.	Mk.	Freq.	Reading Level	Correct Factor	Measurement	Limit	Margin	Detector	Comment
		MHz	dBm	dB	dBm	dBm	dB		

Test Mode: WCDMA Band II\_HSUPA\_TX CH9400

Horizontal

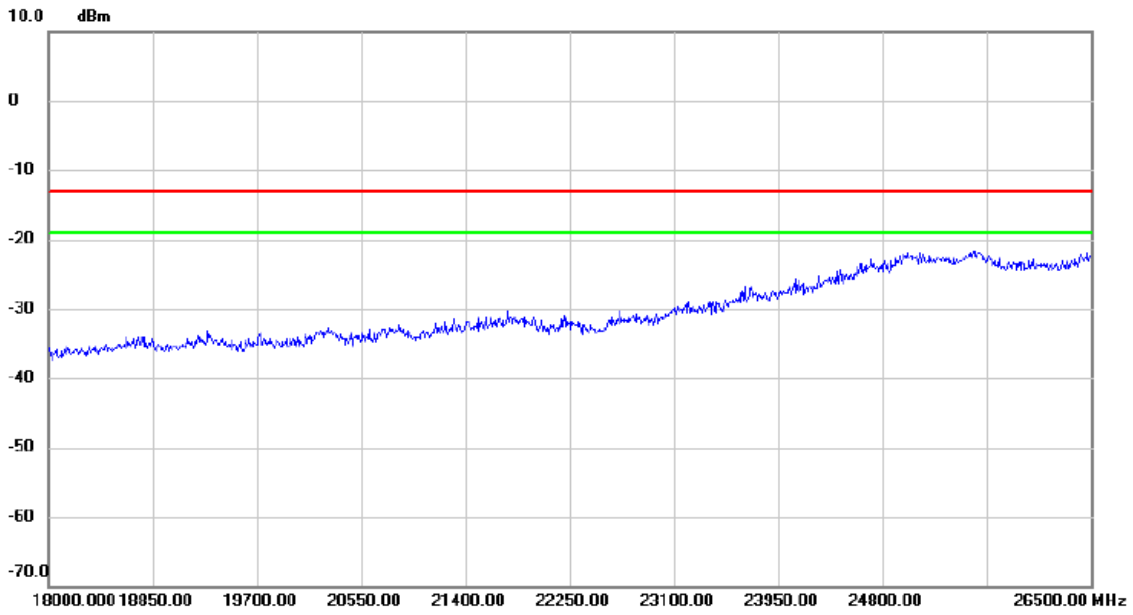

No.	Mk.	Freq. MHz	Reading Level dBm	Correct Factor dB	Measure- ment dBm	Limit dBm	Margin dB	Detector	Comment
-----	-----	--------------	-------------------------	-------------------------	-------------------------	--------------	--------------	----------	---------

Test Mode: LTE Band 2\_TX CH19100\_5M

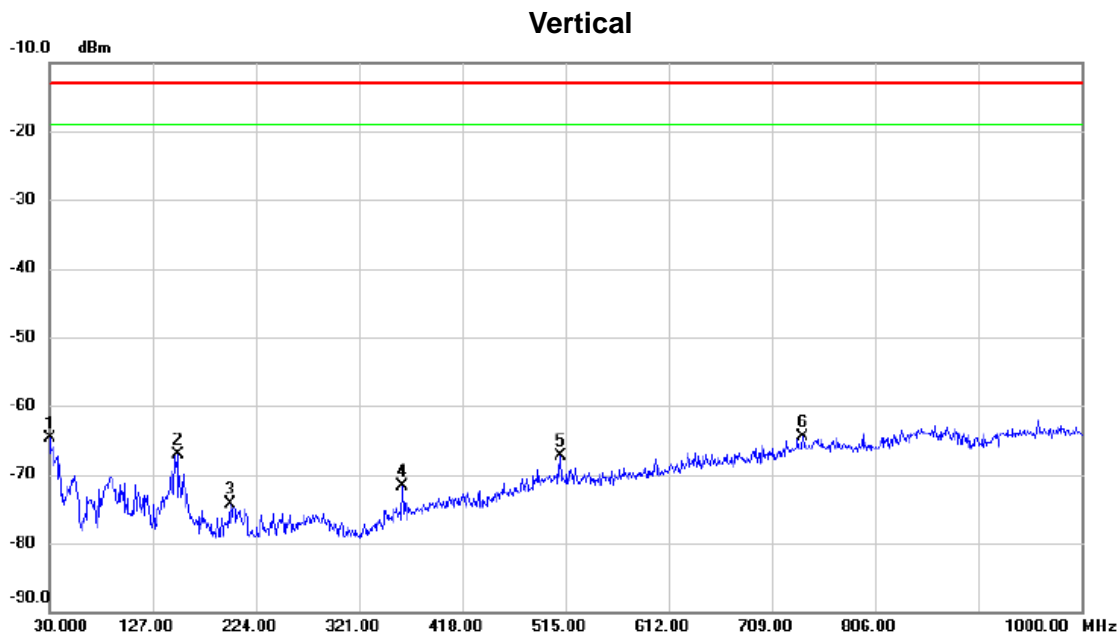

No.	Mk.	Freq. MHz	Reading Level dBm	Correct Factor dB	Measure- ment dBm	Limit dBm	Margin dB	Detector	Comment
1		30.000	-62.86	-1.89	-64.75	-13.00	-51.75	peak	
2		150.280	-67.09	-0.04	-67.13	-13.00	-54.13	peak	
3		199.750	-70.18	-4.13	-74.31	-13.00	-61.31	peak	
4		361.740	-73.09	1.48	-71.61	-13.00	-58.61	peak	
5		510.150	-71.95	4.58	-67.37	-13.00	-54.37	peak	
6	*	738.100	-72.85	8.27	-64.58	-13.00	-51.58	peak	

Test Mode: LTE Band 2\_TX CH19100\_5M

Horizontal

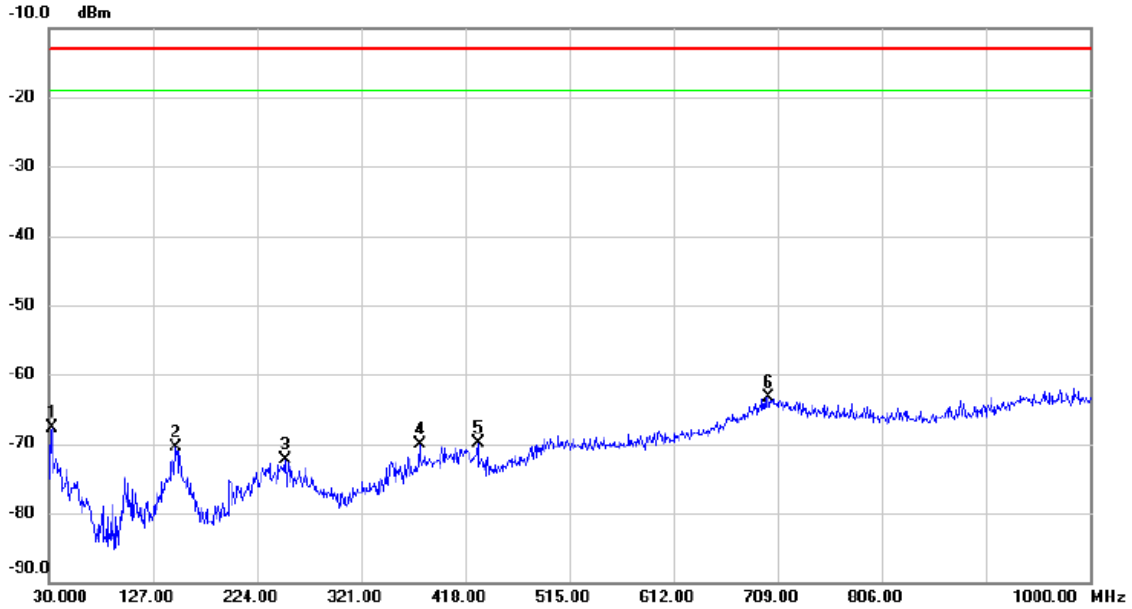

No.	Mk.	Freq. MHz	Reading Level dBm	Correct Factor dB	Measure- ment dBm	Limit dBm	Margin dB	Detector	Comment
1		32.910	-63.20	-4.53	-67.73	-13.00	-54.73	peak	
2		148.340	-70.56	0.02	-70.54	-13.00	-57.54	peak	
3		250.190	-69.50	-2.76	-72.26	-13.00	-59.26	peak	
4		375.320	-72.22	2.14	-70.08	-13.00	-57.08	peak	
5		429.640	-73.61	3.72	-69.89	-13.00	-56.89	peak	
6	*	700.270	-70.82	7.44	-63.38	-13.00	-50.38	peak	

Test Mode: LTE Band 2\_TX CH19100\_5M

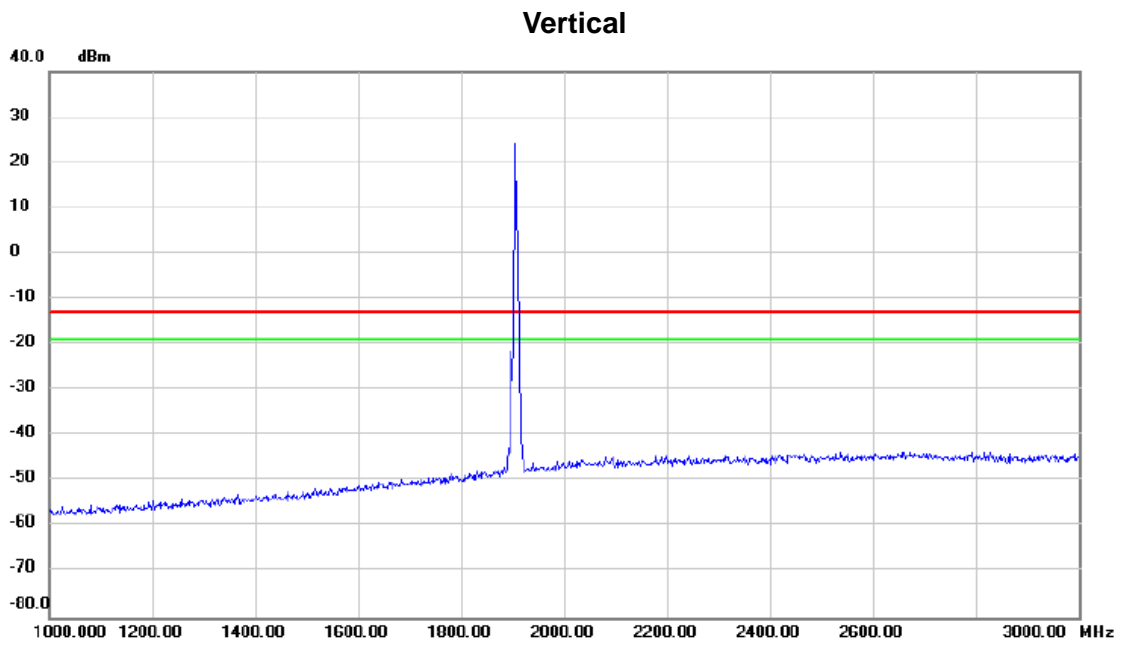

No.	Mk.	Freq.	Reading Level	Correct Factor	Measurement	Limit	Margin	Detector	Comment
		MHz	dBm	dB	dBm	dBm	dB		
		1910.00	25.00	0.00	25.00	-15.00	40.00		

Test Mode: LTE Band 2\_TX CH19100\_5M

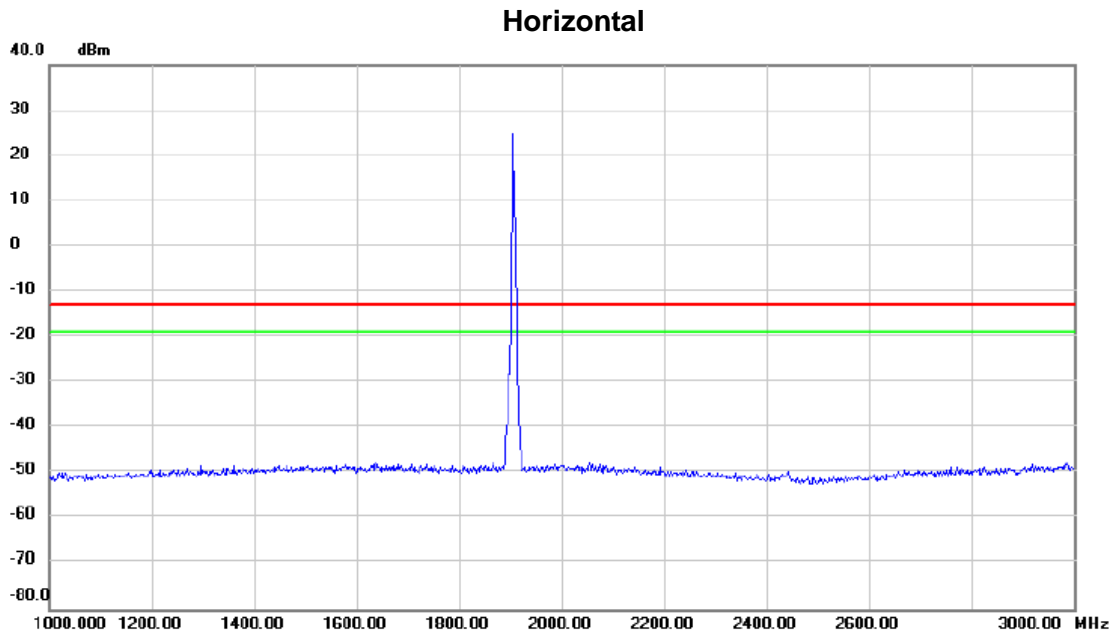

No.	Mk.	Freq.	Reading Level	Correct Factor	Measurement	Limit	Margin	Detector	Comment
		MHz	dBm	dB	dBm	dBm	dB		
		1910.00	25.00	0.00	25.00	-13.00	38.00		



Test Mode: LTE Band 2\_TX CH19100\_5M

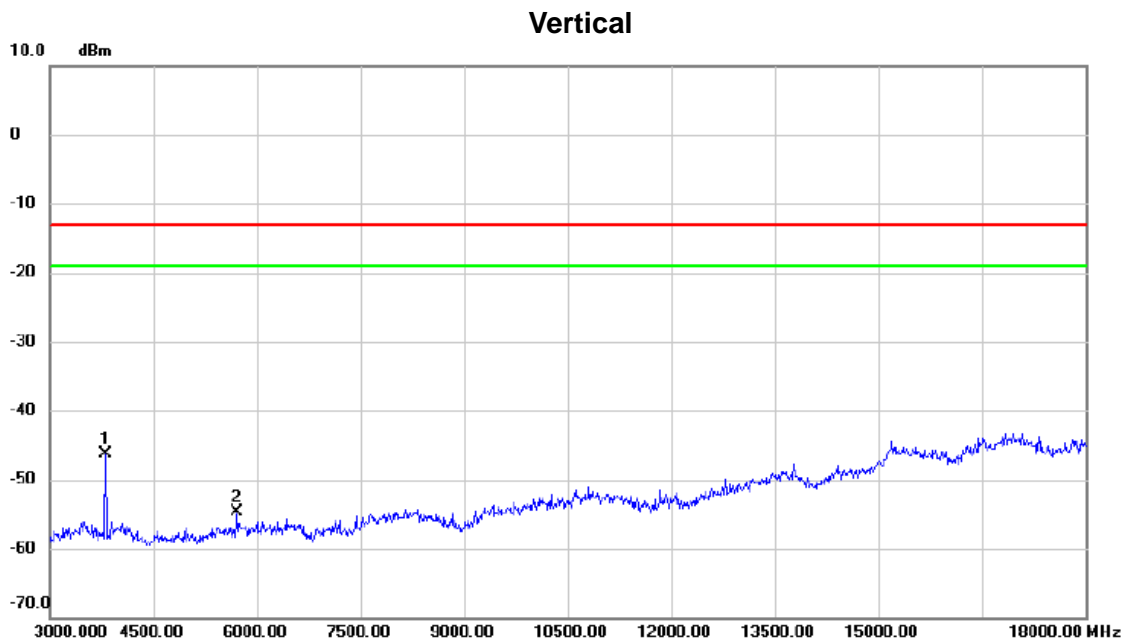

No.	Mk.	Freq. MHz	Reading Level dBm	Correct Factor dB	Measure- ment dBm	Limit dBm	Margin dB	Detector	Comment
1	*	3810.000	-44.89	-1.32	-46.21	-13.00	-33.21	peak	
2		5715.000	-59.30	4.50	-54.80	-13.00	-41.80	peak	

Test Mode: LTE Band 2\_TX CH19100\_5M

Horizontal

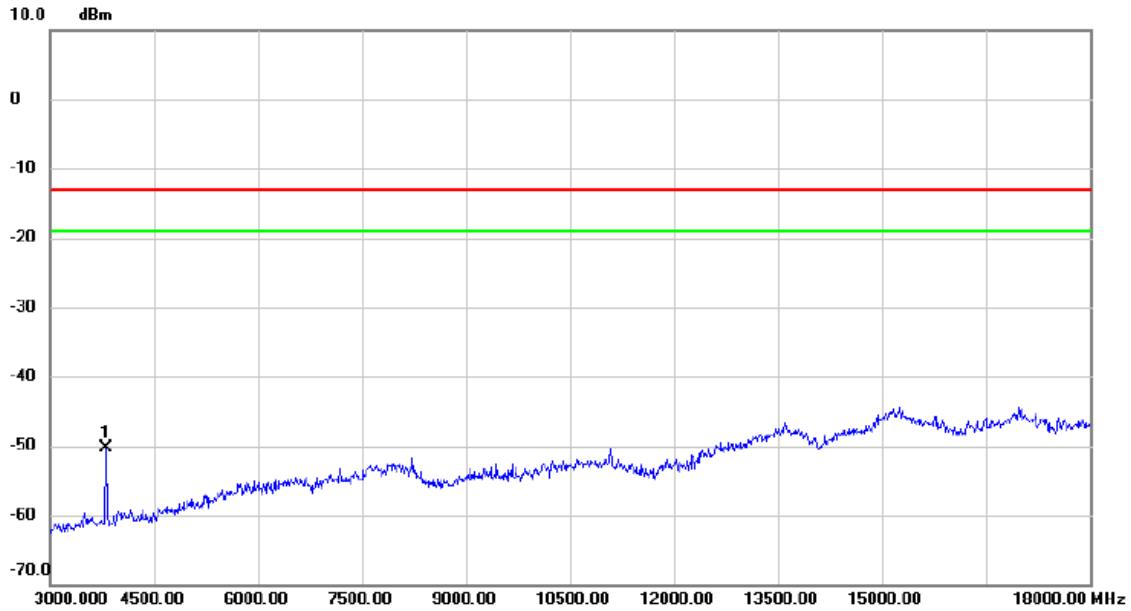

No.	Mk.	Freq. MHz	Reading Level dBm	Correct Factor dB	Measure- ment dBm	Limit dBm	Margin dB	Detector	Comment
1	*	3810.000	-48.89	-1.32	-50.21	-13.00	-37.21	peak	

Test Mode: LTE Band 2\_TX CH19100\_5M

Vertical

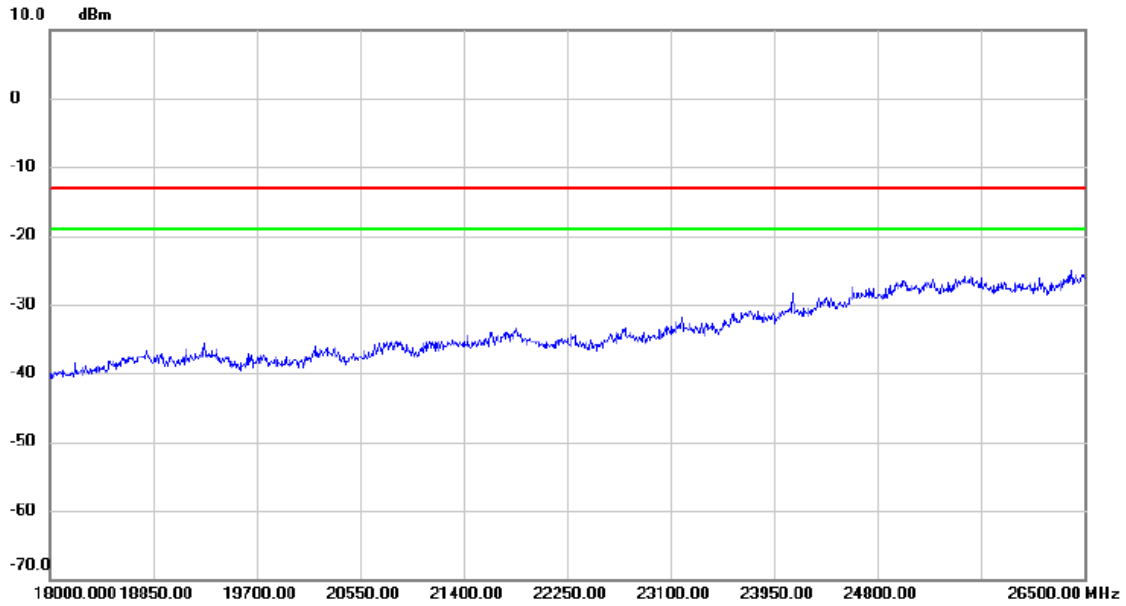

No.	Mk.	Freq.	Reading Level	Correct Factor	Measurement	Limit	Margin	Detector	Comment
		MHz	dBm	dB	dBm	dBm	dB		

Test Mode: LTE Band 2\_TX CH19100\_5M

Horizontal

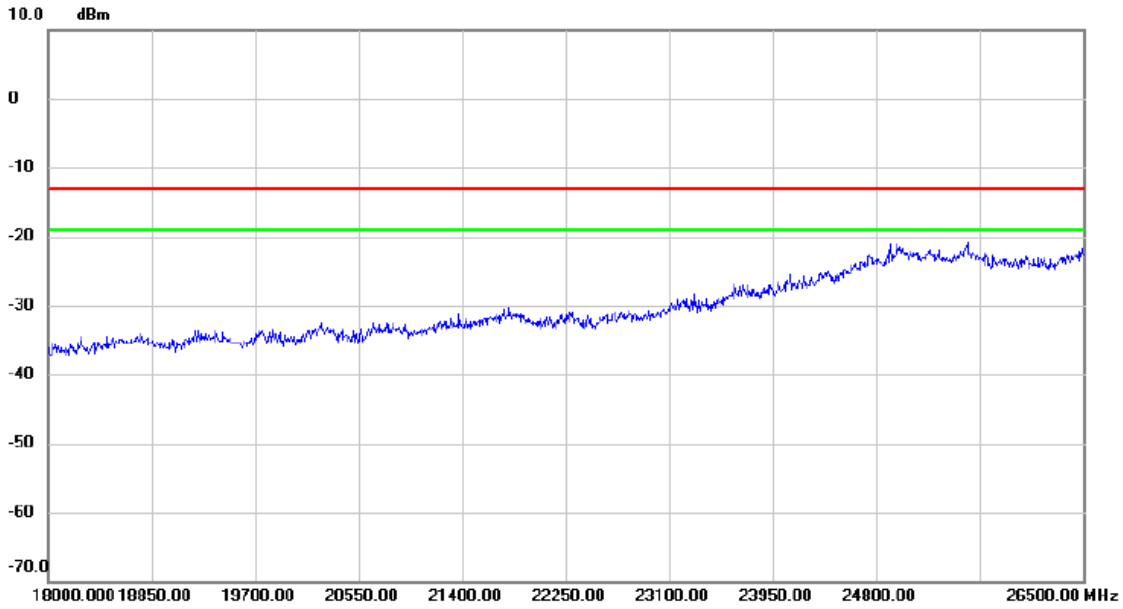

No.	Mk.	Freq. MHz	Reading Level dBm	Correct Factor dB	Measure- ment dBm	Limit dBm	Margin dB	Detector	Comment

Test Mode: LTE Band 2\_TX CH18900\_20M

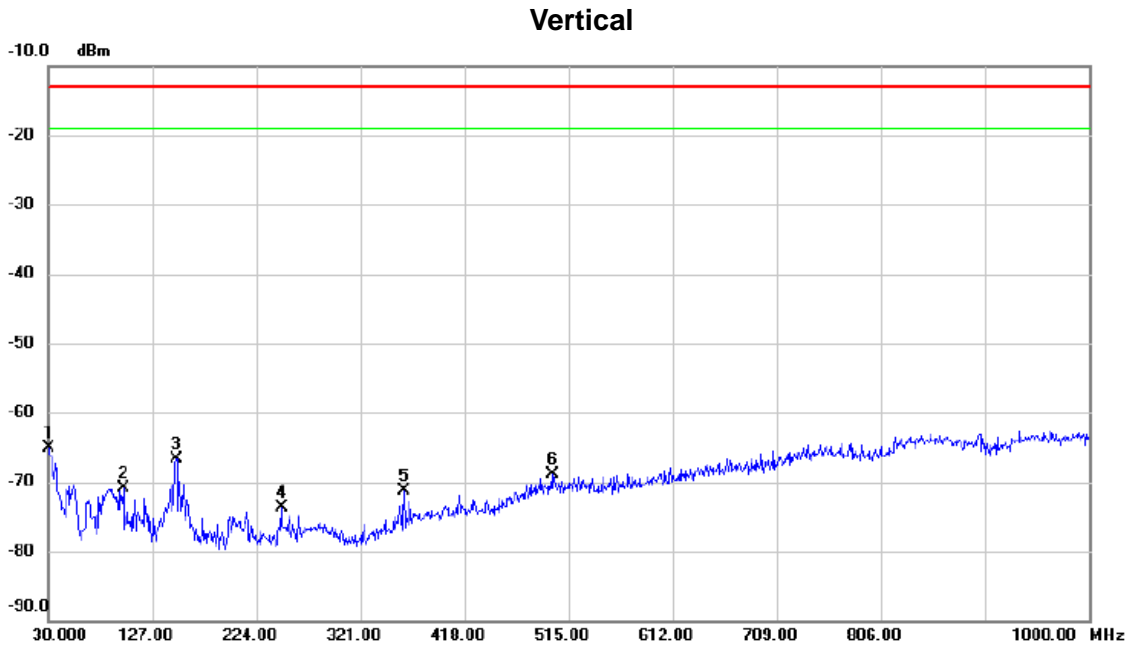

No.	Mk.	Freq. MHz	Reading Level dBm	Correct Factor dB	Measure- ment dBm	Limit dBm	Margin dB	Detector	Comment
1	*	30.000	-63.18	-1.89	-65.07	-13.00	-52.07	peak	
2		99.840	-67.81	-3.08	-70.89	-13.00	-57.89	peak	
3		149.310	-66.74	0.00	-66.74	-13.00	-53.74	peak	
4		247.280	-70.80	-2.93	-73.73	-13.00	-60.73	peak	
5		361.740	-72.83	1.48	-71.35	-13.00	-58.35	peak	
6		499.480	-73.48	4.52	-68.96	-13.00	-55.96	peak	

Test Mode: LTE Band 2\_TX CH18900\_20M

Horizontal

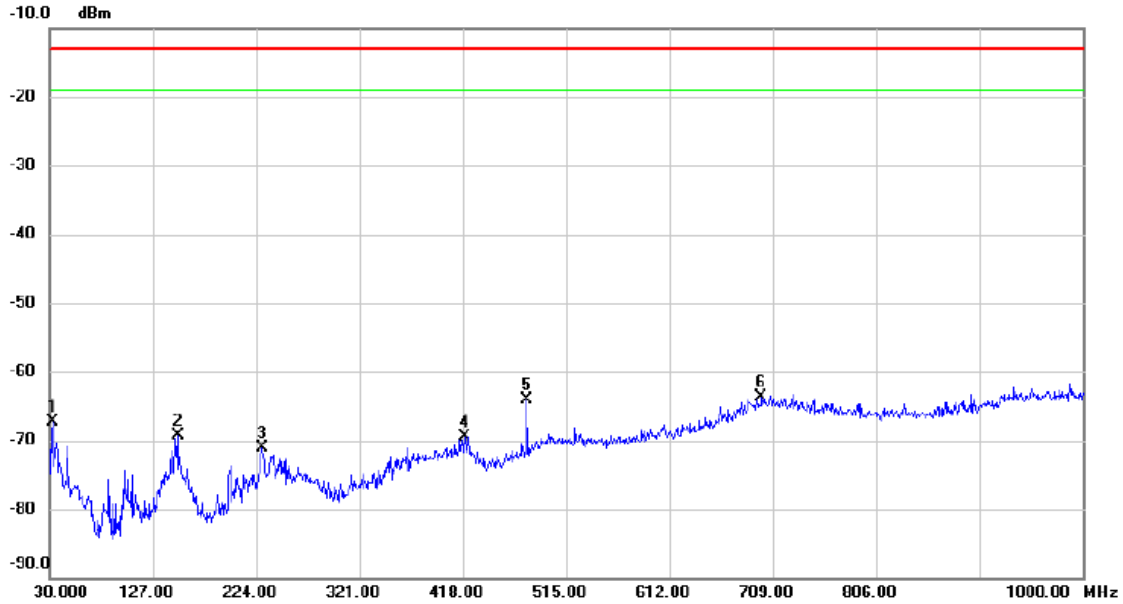

No. Mk.	Freq. MHz	Reading Level dBm	Correct Factor dB	Measure- ment dBm	Limit dBm	Margin dB	Detector	Comment
1	32.910	-62.79	-4.53	-67.32	-13.00	-54.32	peak	
2	150.280	-69.33	-0.04	-69.37	-13.00	-56.37	peak	
3	229.820	-67.27	-3.92	-71.19	-13.00	-58.19	peak	
4	419.940	-73.06	3.60	-69.46	-13.00	-56.46	peak	
5	478.140	-68.38	4.29	-64.09	-13.00	-51.09	peak	
6 *	698.330	-71.15	7.41	-63.74	-13.00	-50.74	peak	

Test Mode: LTE Band 2\_TX CH18900\_20M

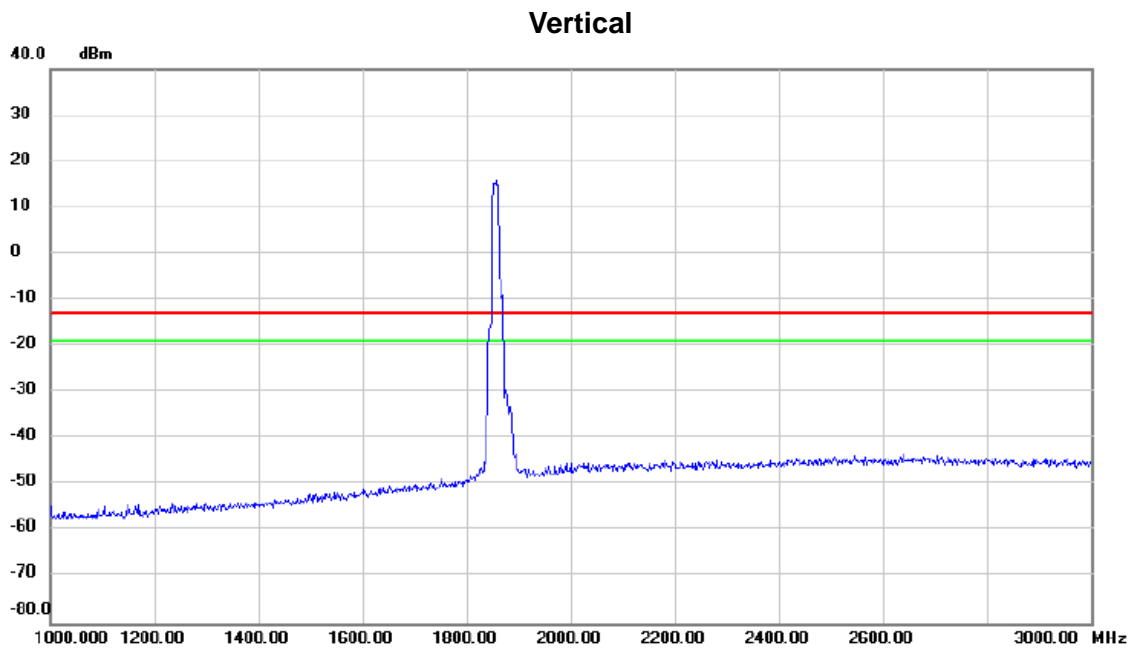

No.	Mk.	Freq.	Reading Level	Correct Factor	Measurement	Limit	Margin	Detector	Comment
		MHz	dBm	dB	dBm	dBm	dB		
		1890.00	15.00	0.00	15.00	-15.00	30.00		

Test Mode: LTE Band 2\_TX CH18900\_20M

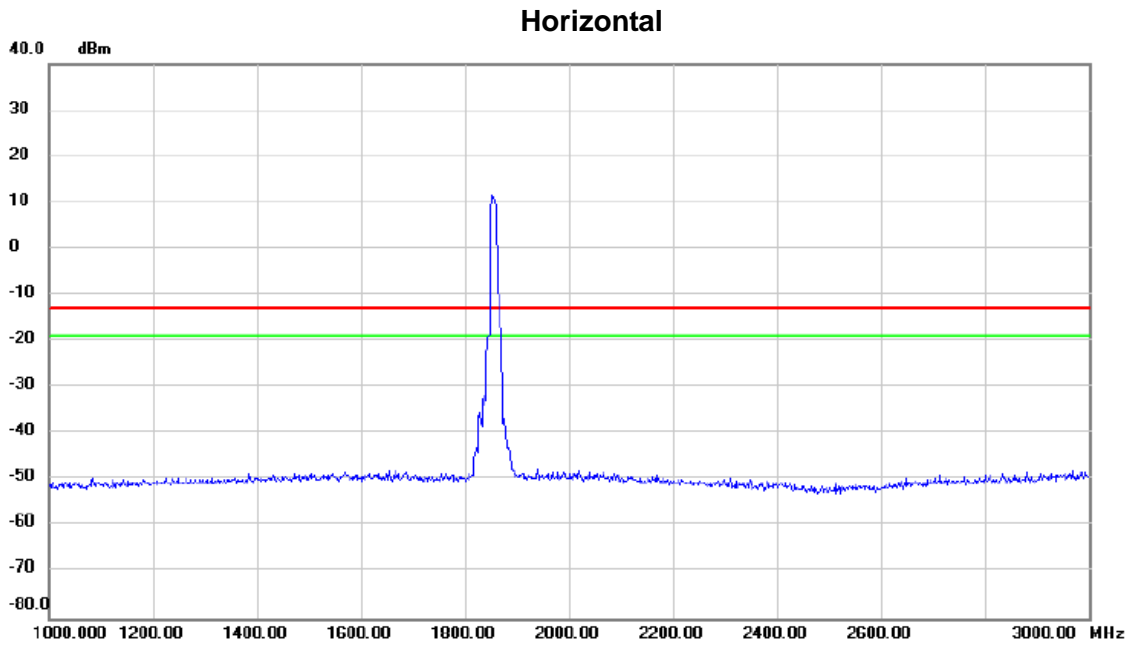

No.	Mk.	Freq.	Reading Level	Correct Factor	Measurement	Limit	Margin	Detector	Comment
		MHz	dBm	dB	dBm	dBm	dB		



Test Mode: LTE Band 2\_TX CH18900\_20M

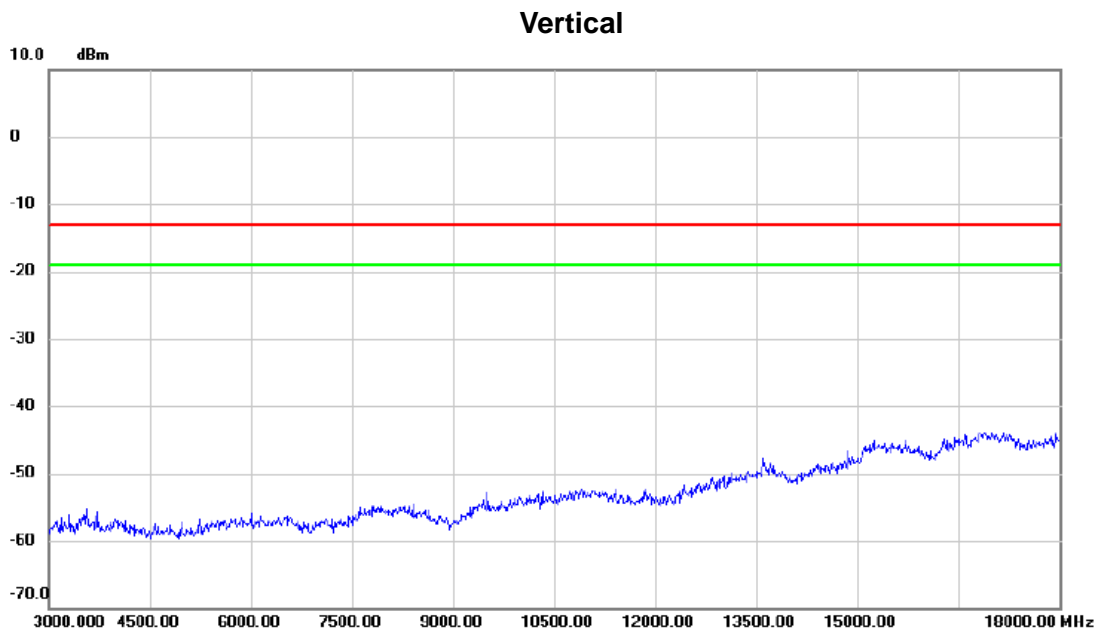

No.	Mk.	Freq. MHz	Reading Level dBm	Correct Factor dB	Measure- ment dBm	Limit dBm	Margin dB	Detector	Comment

Test Mode: LTE Band 2\_TX CH18900\_20M

Horizontal

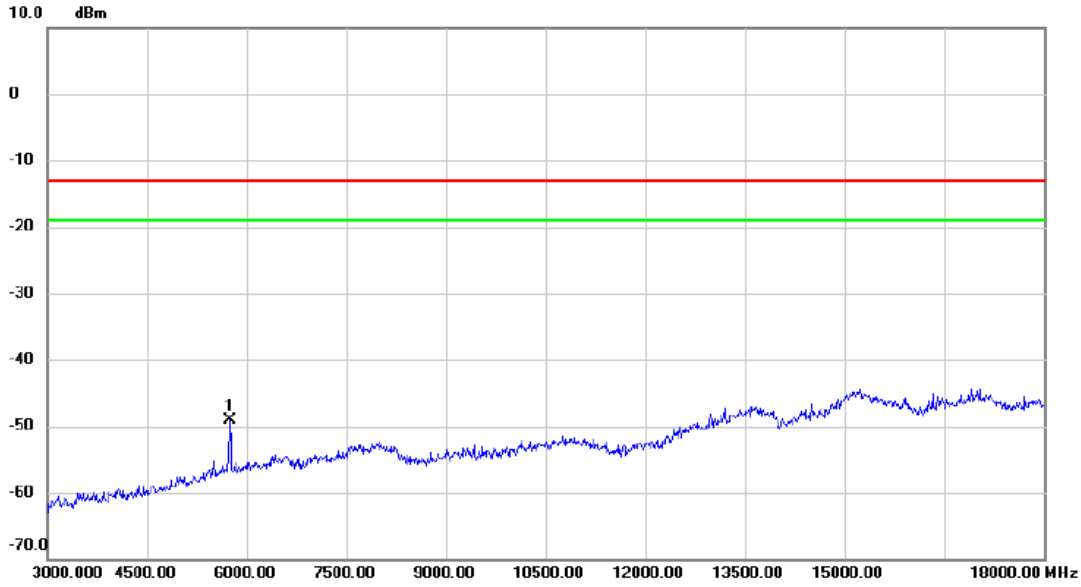

No.	Mk.	Freq. MHz	Reading Level dBm	Correct Factor dB	Measure- ment dBm	Limit dBm	Margin dB	Detector	Comment
1	*	5745.000	-53.71	4.59	-49.12	-13.00	-36.12	peak	

Test Mode: LTE Band 2\_TX CH18900\_20M

Vertical

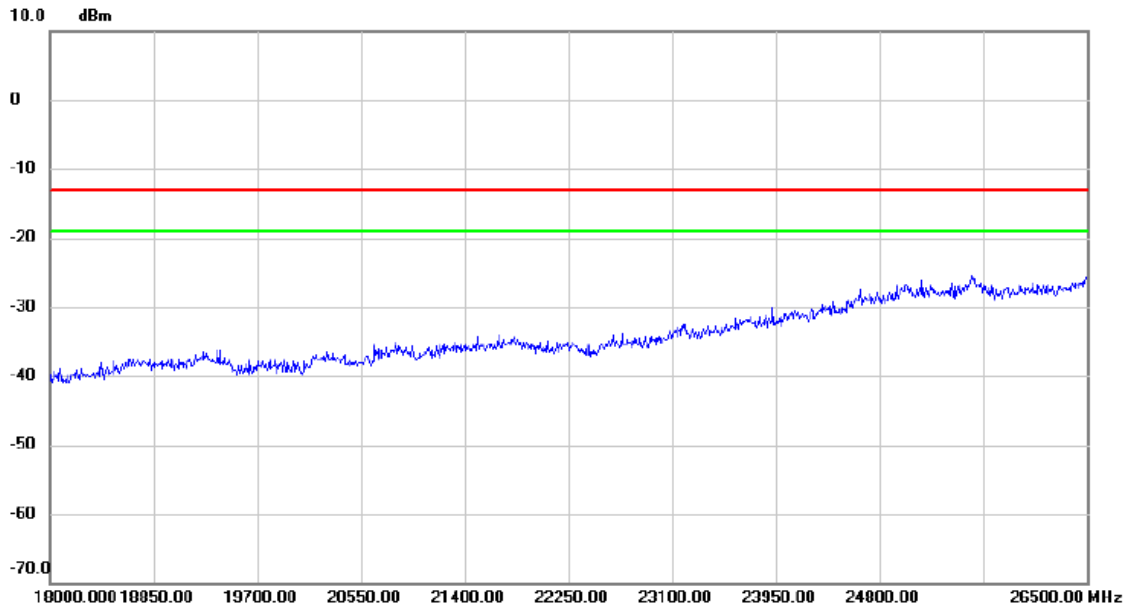

No.	Mk.	Freq.	Reading Level	Correct Factor	Measurement	Limit	Margin	Detector	Comment
		MHz	dBm	dB	dBm	dBm	dB		
		18000.00	-40						
		18950.00	-40						
		19700.00	-40						
		20550.00	-40						
		21400.00	-40						
		22250.00	-40						
		23100.00	-40						
		23950.00	-40						
		24800.00	-40						
		26500.00	-40						

Test Mode: LTE Band 2\_TX CH18900\_20M

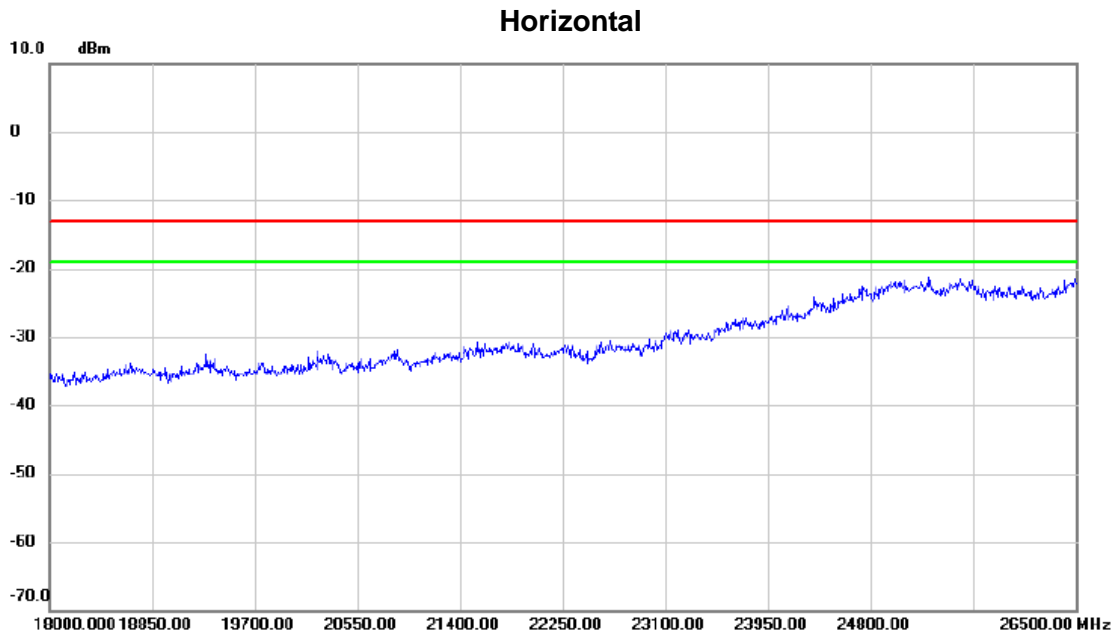

No.	Mk.	Freq. MHz	Reading Level dBm	Correct Factor dB	Measure- ment dBm	Limit dBm	Margin dB	Detector	Comment

## ATTACHMENT E - BAND EDGE

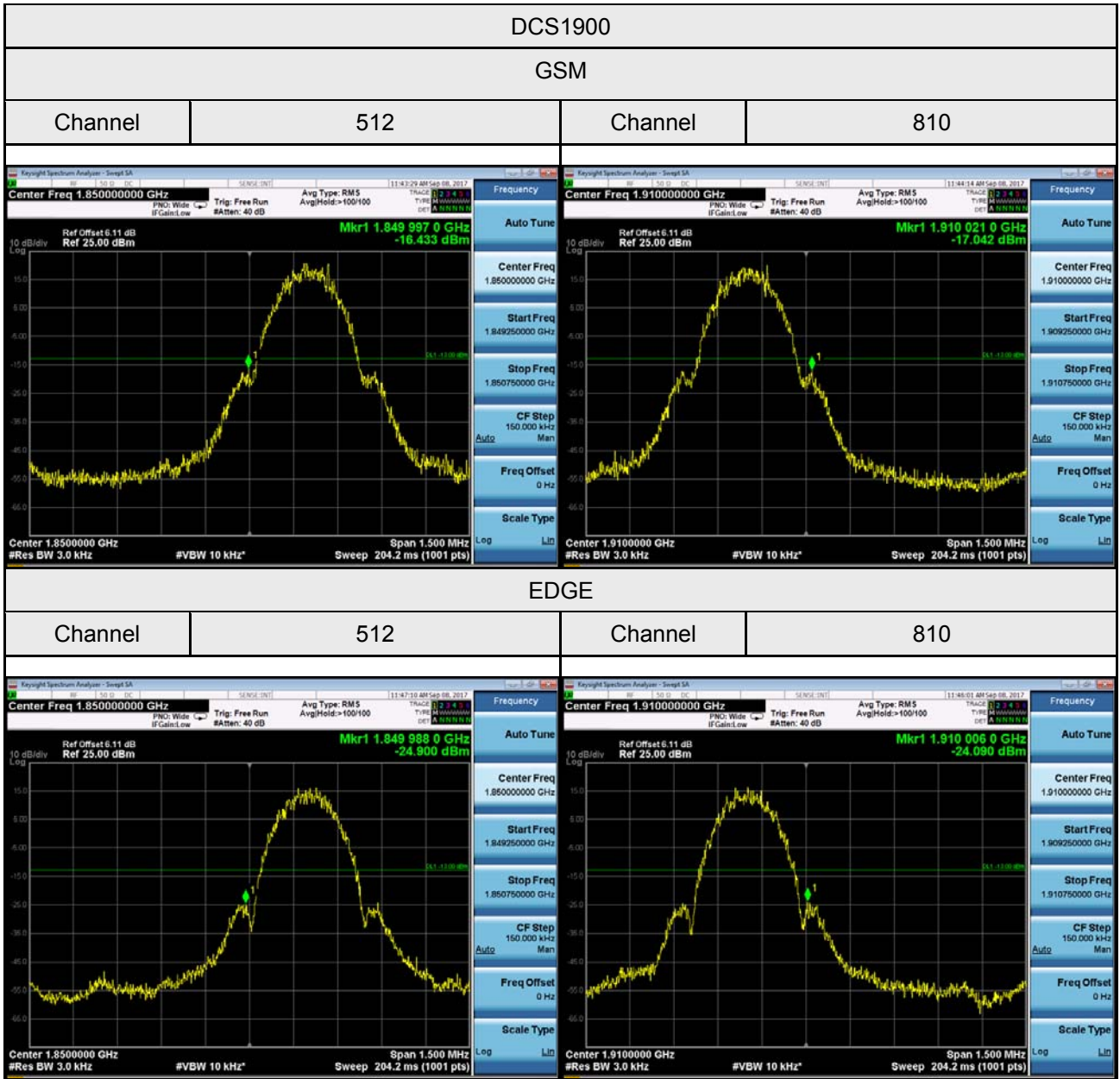

### WCDMA Band 2

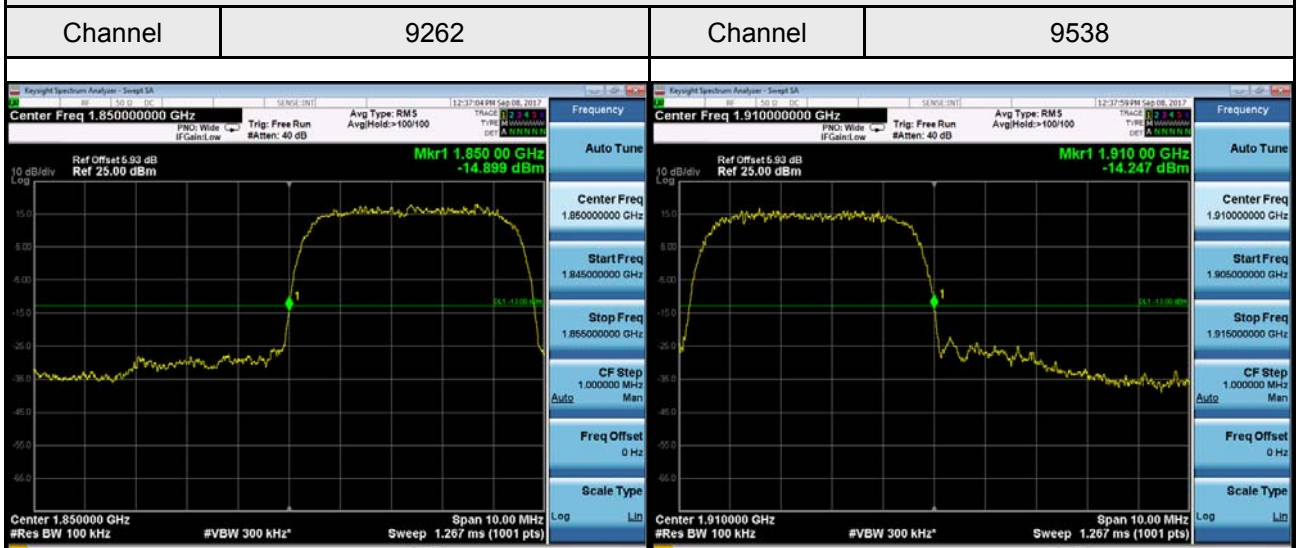

### WCDMA\_HSDPA Band 2

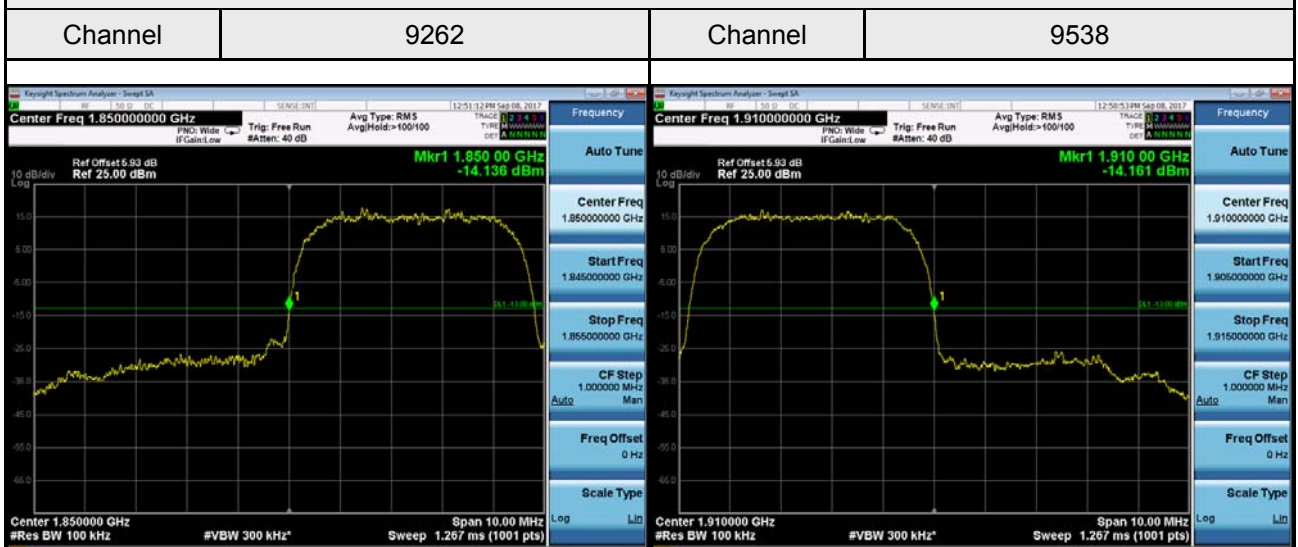

### WCDMA\_HSUPA Band 2

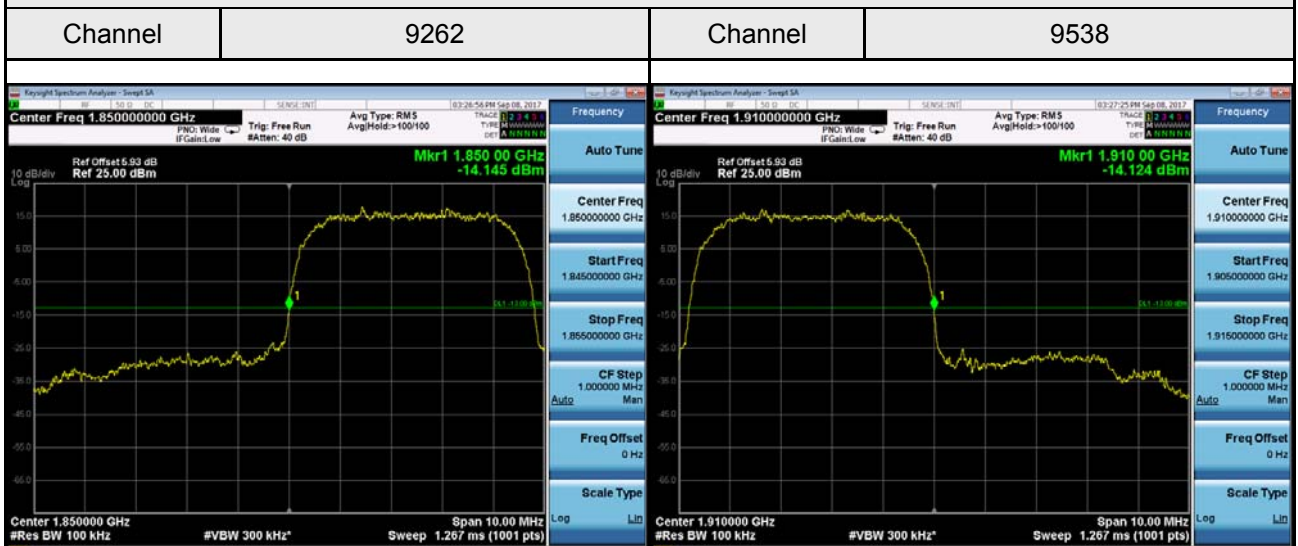

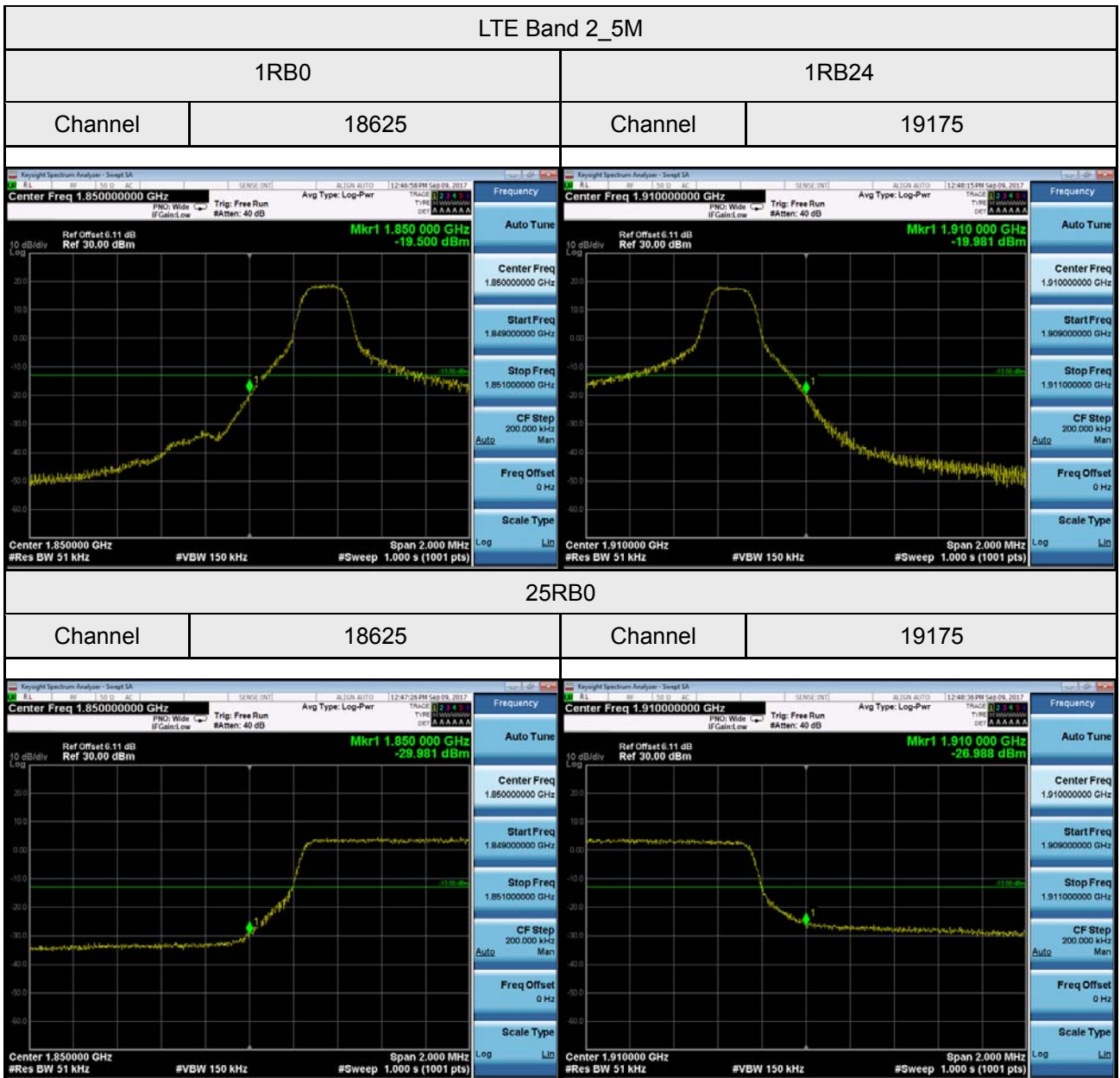



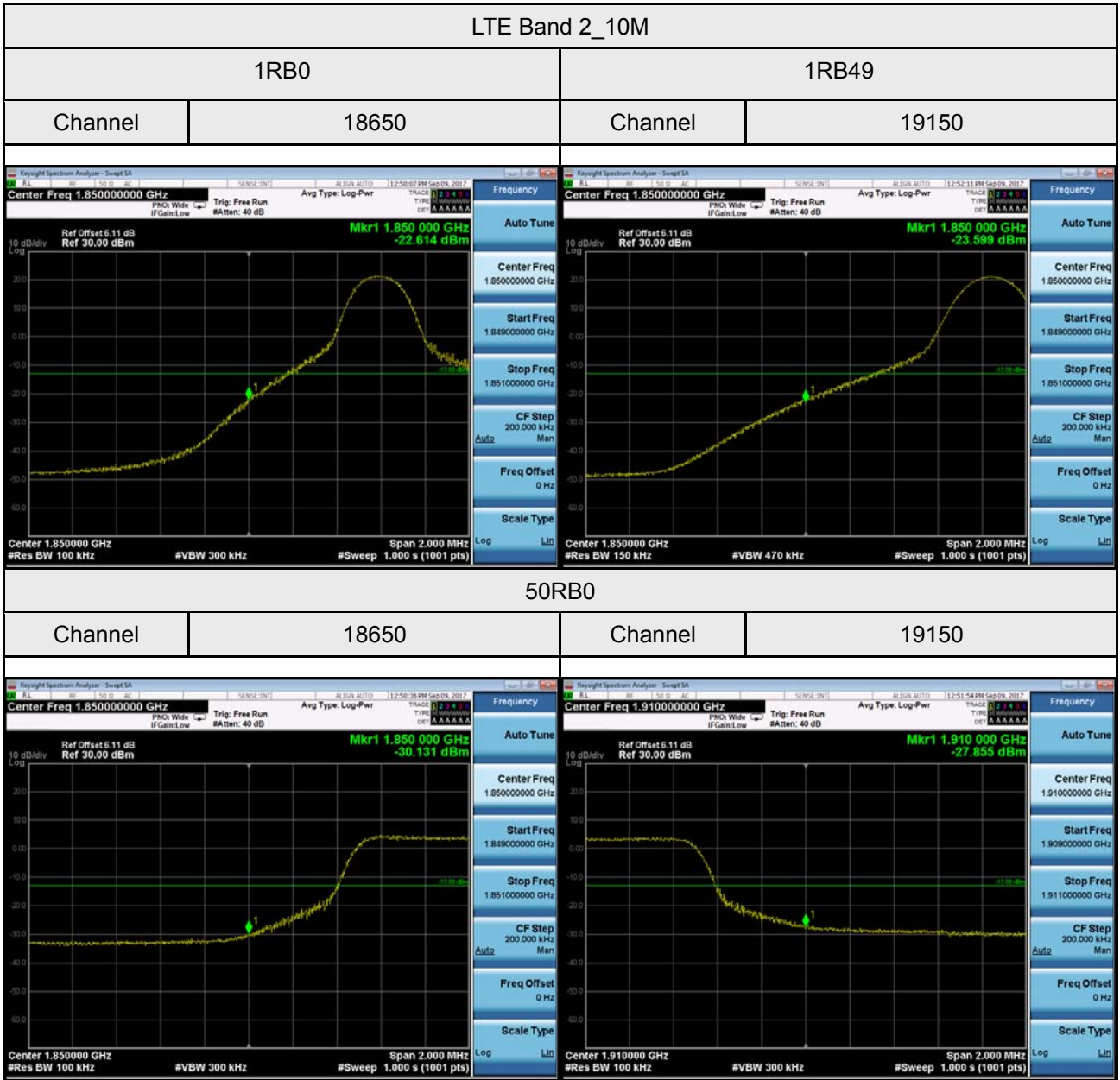

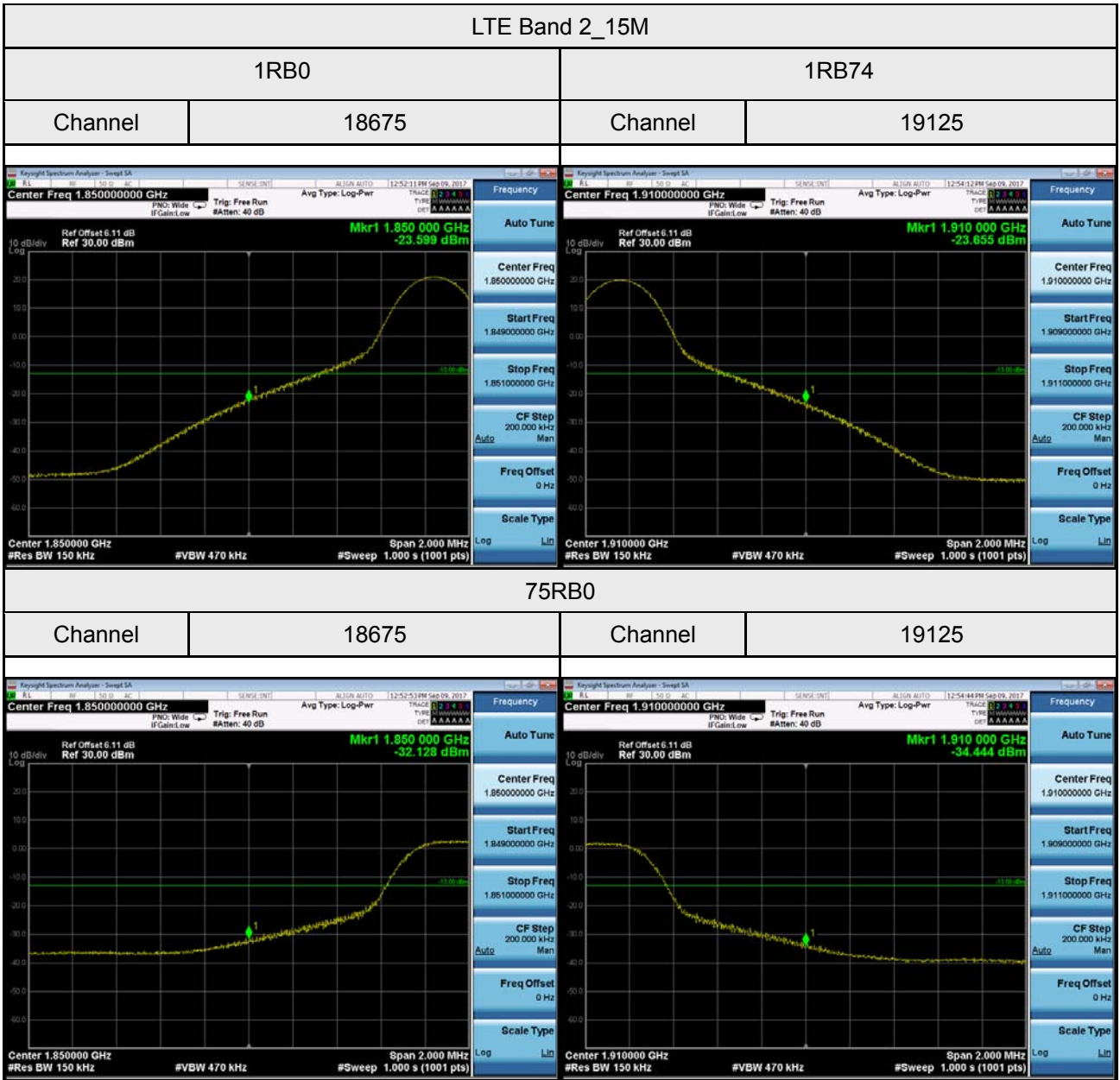

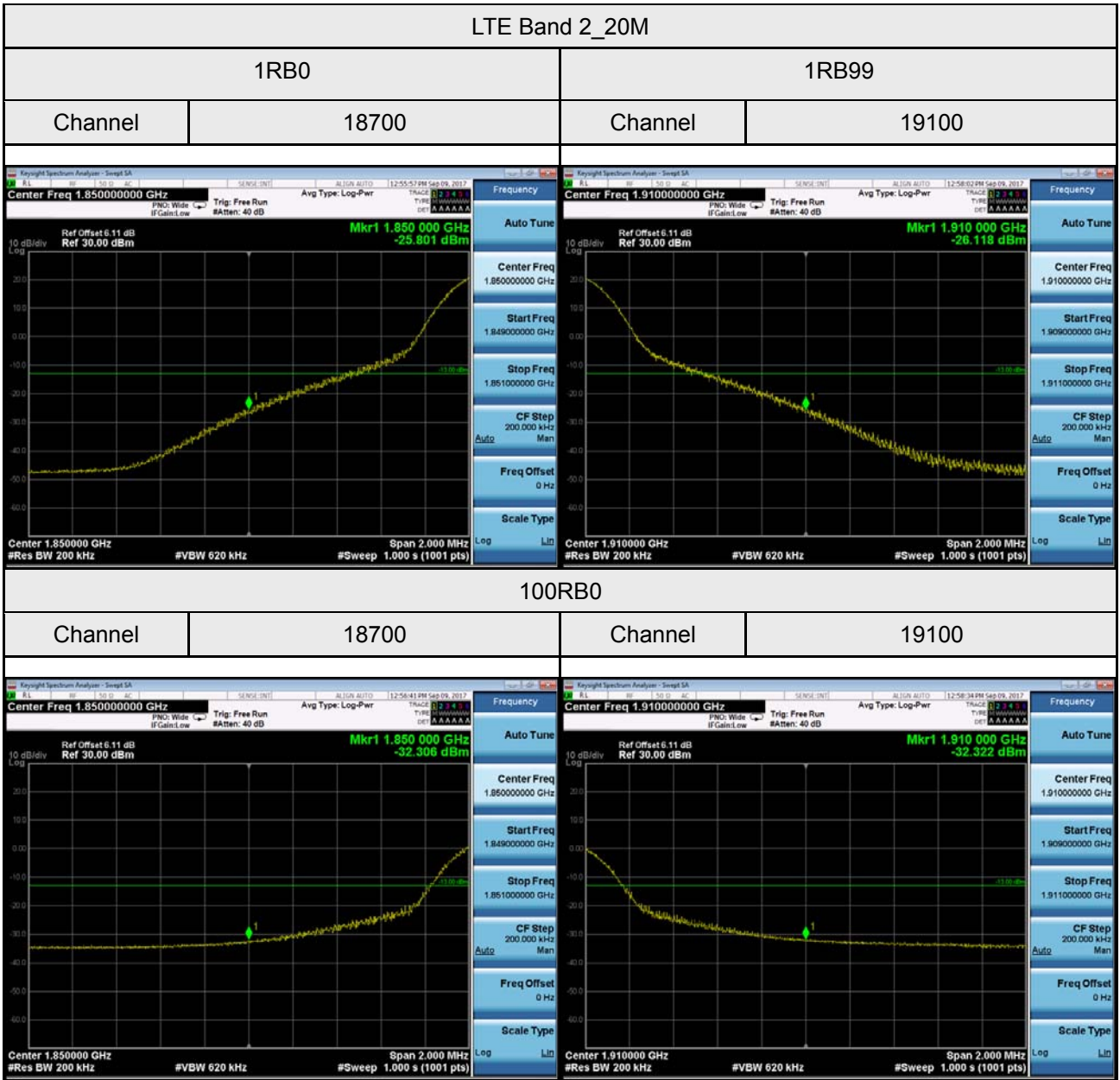

## ATTACHMENT F - PEAK TO AVERAGE RATIO

### DCS1900 Spectrum Plot



### WCDMA Band 2 Spectrum Plot

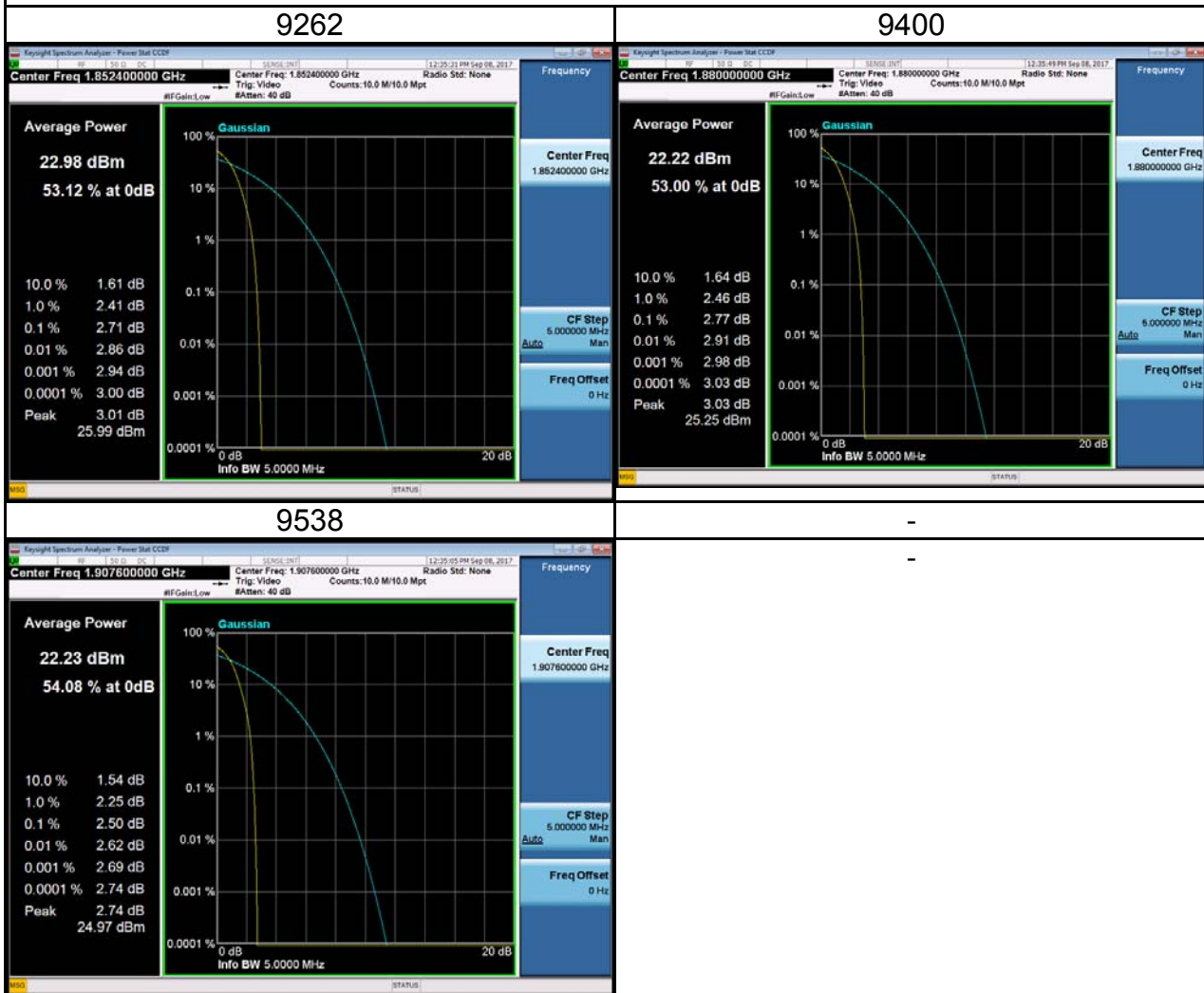

### WCDMA\_HSDPA Band 2 Spectrum Plot

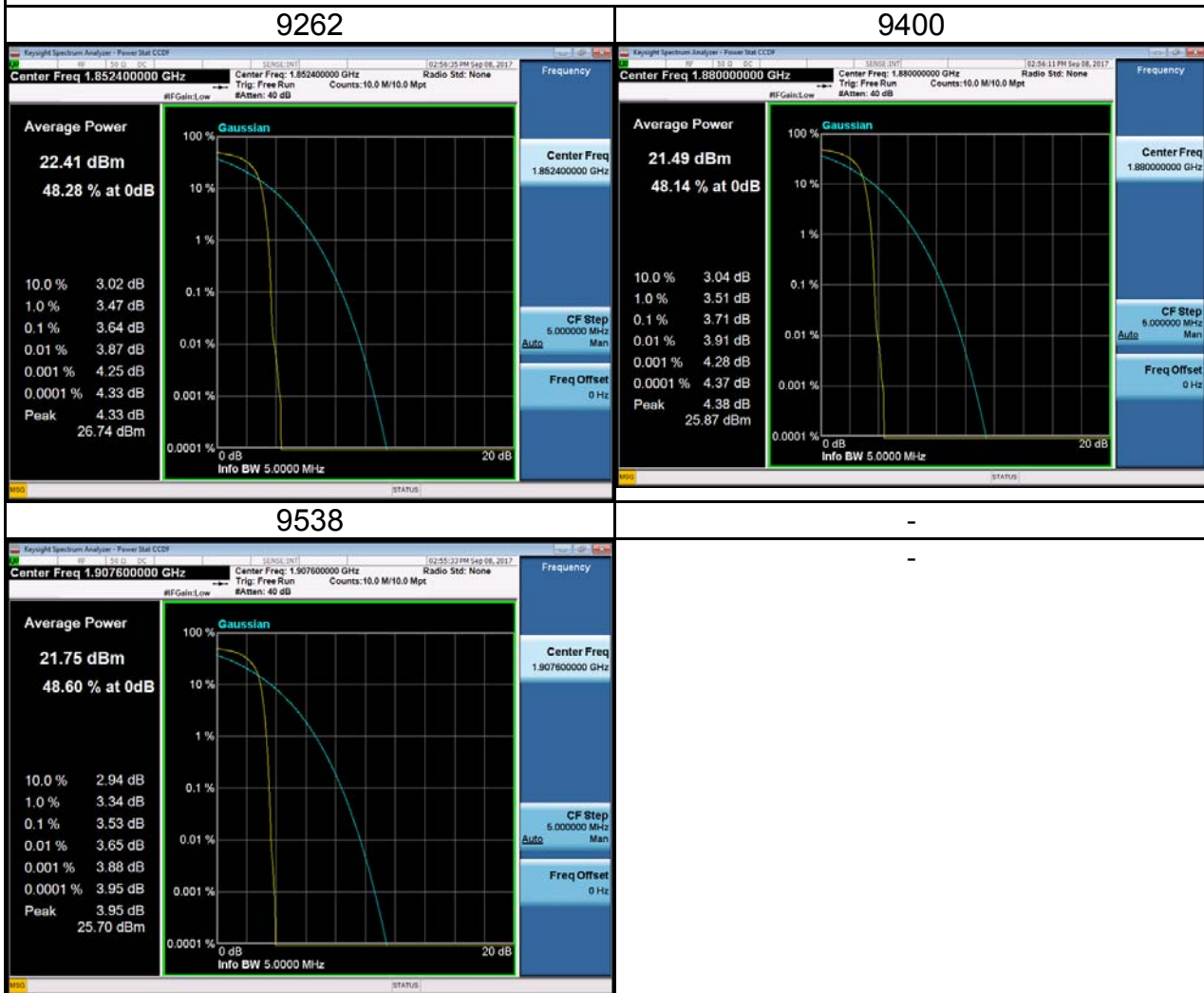

### WCDMA\_HSUPA Band 2 Spectrum Plot

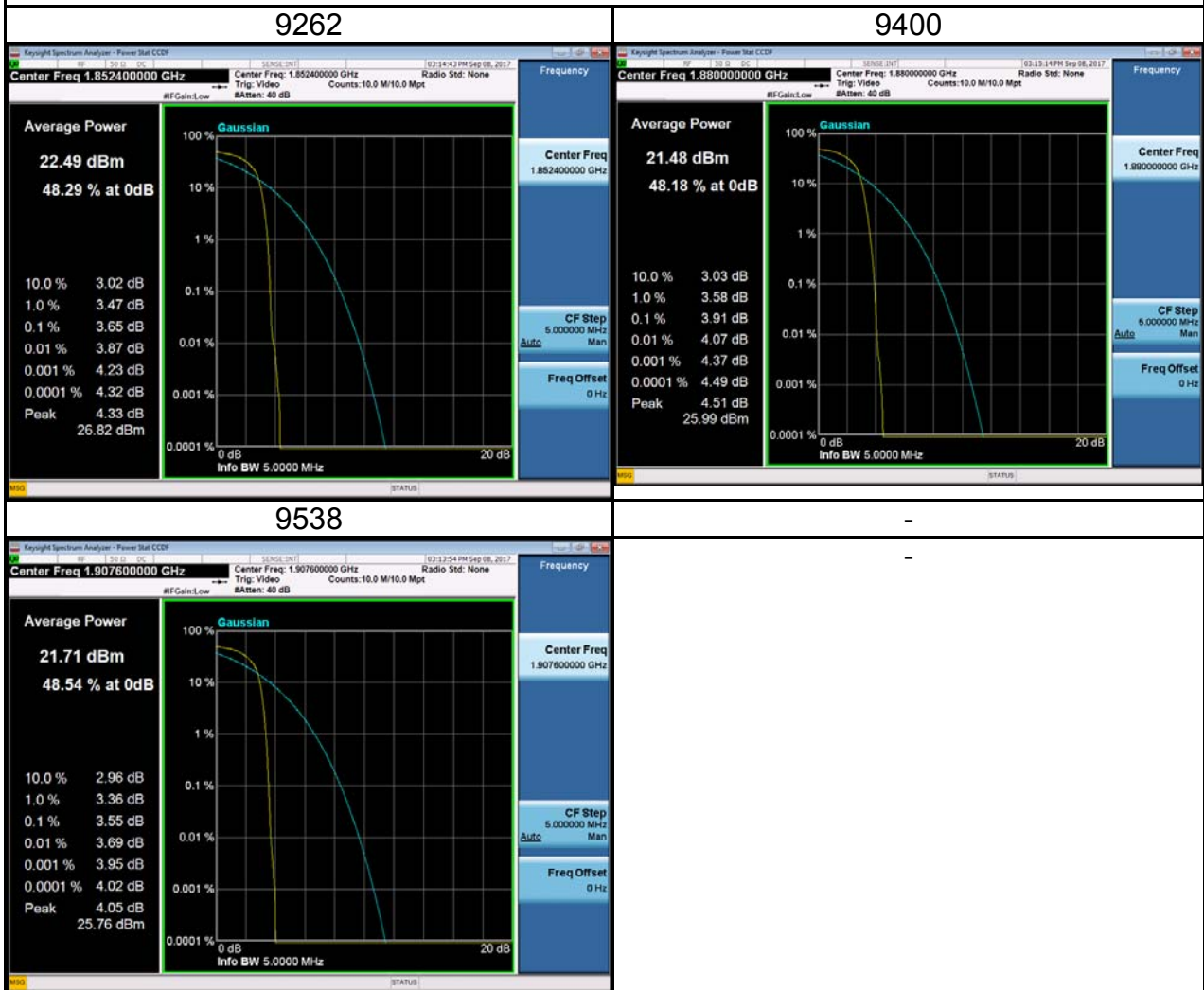



### LTE Band 2 Spectrum Plot\_5M

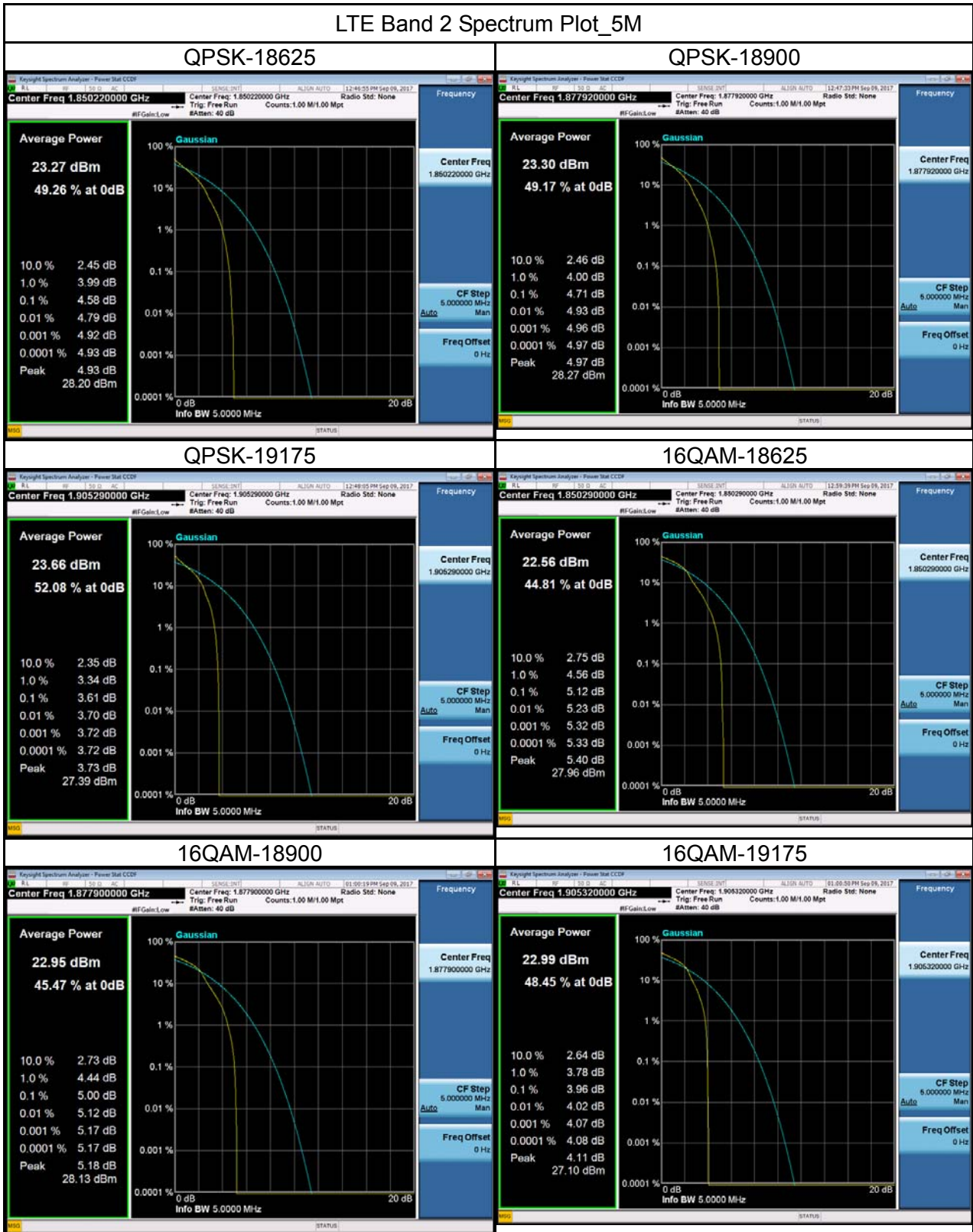

### LTE Band 2 Spectrum Plot\_10M

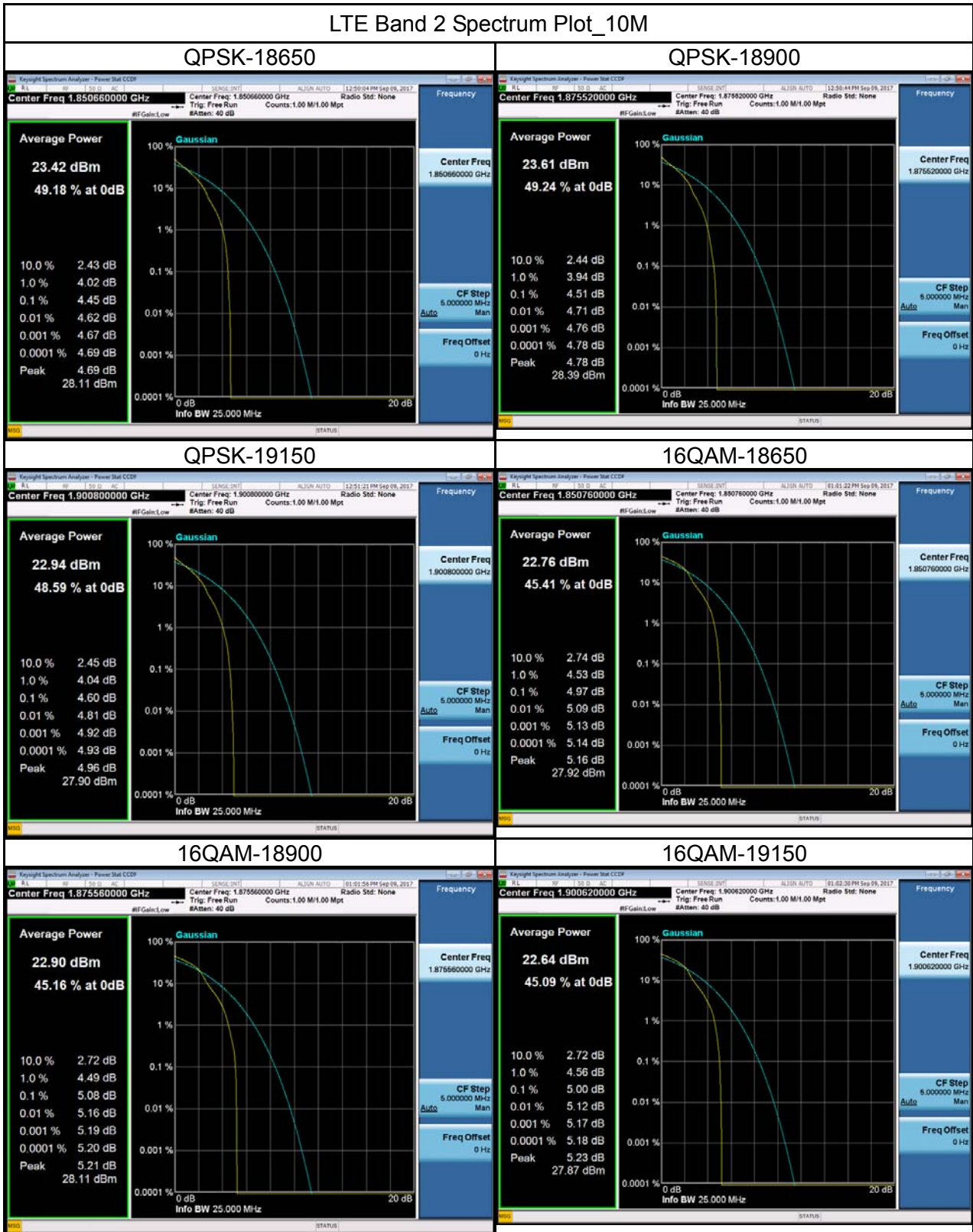

### LTE Band 2 Spectrum Plot\_15M

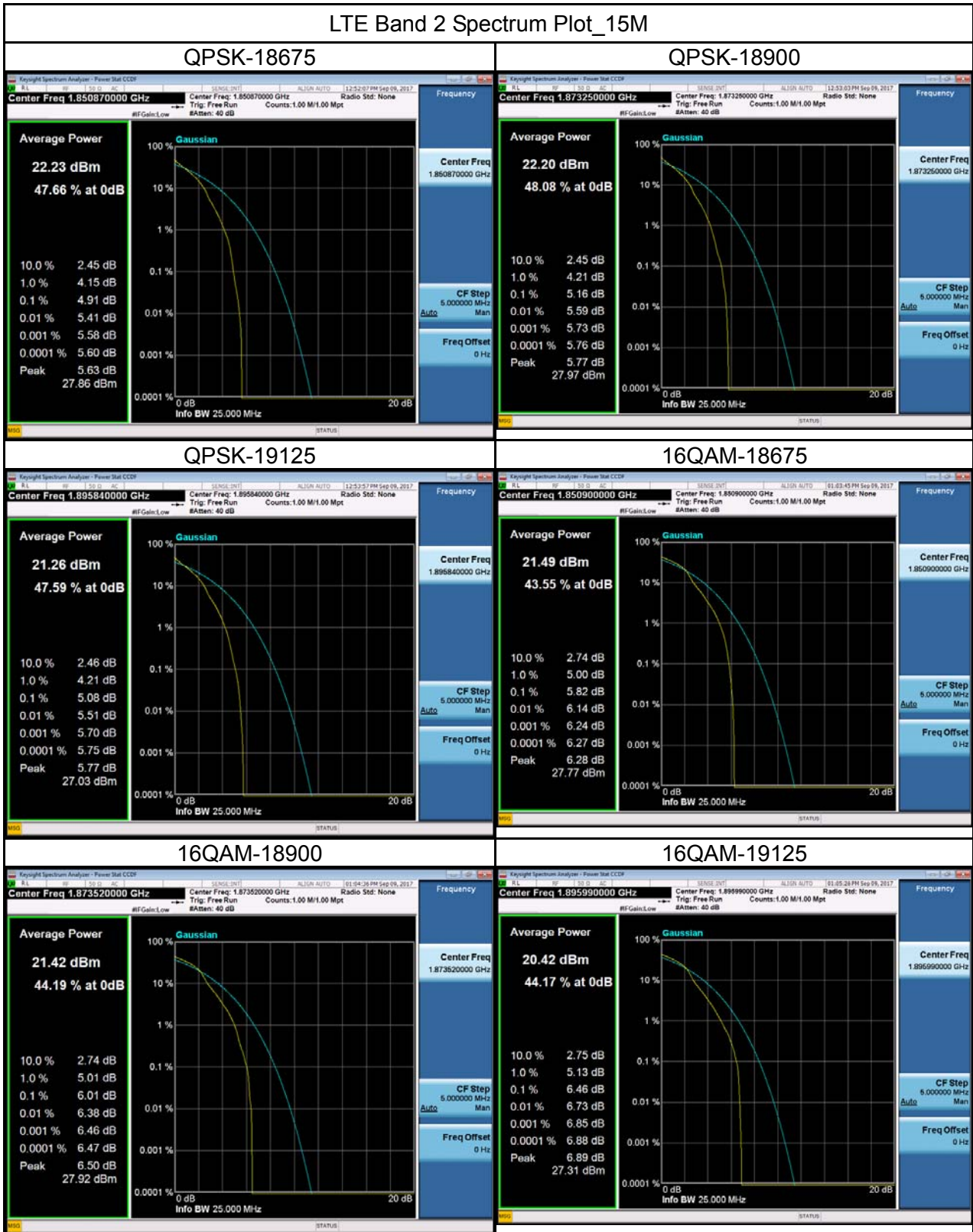

### LTE Band 2 Spectrum Plot\_20M

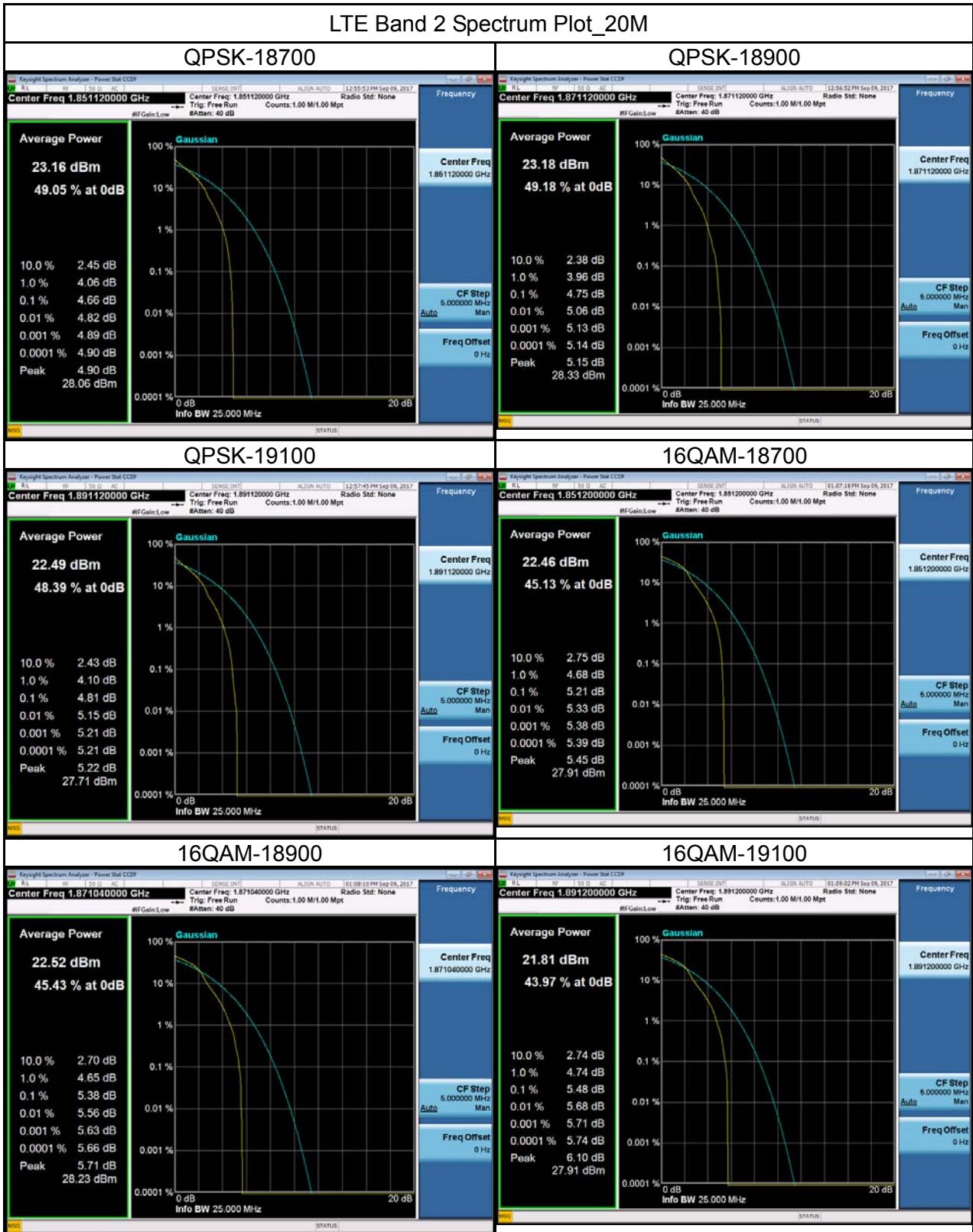

## ATTACHMENT G - FREQUENCY STABILITY

Test Mode:	DCS1900_CH661
------------	---------------

**Temperature vs. Frequency Stability**

Temperature(°C)	Frequency Error (Hz)	Frequency Error (ppm)	Limit(ppm)
-30	4.98	0.002691601	2.5
-20	5.64	0.003048319	2.5
-10	7.25	0.003918495	2.5
0	6.54	0.003534753	2.5
10	5.18	0.002799697	2.5
20	6.39	0.003453681	2.5
30	7.12	0.003848233	2.5
40	5.18	0.002799697	2.5
50	5.69	0.003075343	2.5
Max. Deviation (ppm)	<b>7.25</b>	<b>0.003918495</b>	2.5

**Voltage vs. Frequency Stability**

Voltage(Volts)	Frequency Error (Hz)	Frequency Error (ppm)	Limit(ppm)
4.5	5.13	0.002772673	2.5
5	4.73	0.00255648	2.5
5.5	5.06	0.002734839	2.5
Max. Deviation (ppm)	<b>5.13</b>	<b>0.002772673</b>	2.5

Test Mode:	WCDMA Band 2_CH9400
------------	---------------------

### Temperature vs. Frequency Stability

Temperature(°C)	Frequency Error (Hz)	Frequency Error (ppm)	Limit(ppm)
-30	8.81	0.00468617	2.5
-20	6.23	0.00331383	2.5
-10	5.48	0.002914894	2.5
0	7.64	0.00406383	2.5
10	7.21	0.003835106	2.5
20	8.08	0.004297872	2.5
30	6.55	0.003484043	2.5
40	7.32	0.003893617	2.5
50	5.87	0.00312234	2.5
Max. Deviation (ppm)	<b>8.81</b>	<b>0.00468617</b>	2.5

### Voltage vs. Frequency Stability

Voltage(Volts)	Frequency Error (Hz)	Frequency Error (ppm)	Limit(ppm)
4.5	6.33	0.003367021	2.5
5	7.95	0.004228723	2.5
5.5	8.02	0.004265957	2.5
Max. Deviation (ppm)	<b>8.02</b>	<b>0.004265957</b>	2.5

Test Mode:	LTE Band 2_CH18900_5M
------------	-----------------------

### Temperature vs. Frequency Stability

Temperature(°C)	Frequency Error (Hz)	Frequency Error (ppm)	Limit(ppm)
-30	3.66	0.001946809	2.5
-20	4.28	0.002276596	2.5
-10	-3.75	0.001994681	2.5
0	-3.19	0.001696809	2.5
10	2.67	0.001420213	2.5
20	2.24	0.001191489	2.5
30	-1.99	0.001058511	2.5
40	2.87	0.001526596	2.5
50	3.42	0.001819149	2.5
Max. Deviation (ppm)	4.28	0.002276596	2.5

### Voltage vs. Frequency Stability

Voltage(Volts)	Frequency Error (Hz)	Frequency Error (ppm)	Limit(ppm)
4.5	2.64	0.001404255	2.5
5	-3.75	0.001994681	2.5
5.5	2.49	0.001324468	2.5
Max. Deviation (ppm)	3.75	0.001994681	2.5



Test Mode:	LTE Band 2_CH18900_10M
------------	------------------------

### Temperature vs. Frequency Stability

Temperature(°C)	Frequency Error (Hz)	Frequency Error (ppm)	Limit(ppm)
-30	3.13	0.001664894	2.5
-20	-2.46	0.001308511	2.5
-10	-3.57	0.001898936	2.5
0	-2.68	0.001425532	2.5
10	1.58	0.000840426	2.5
20	2.19	0.001164894	2.5
30	3.77	0.002005319	2.5
40	4.08	0.002170213	2.5
50	-3.05	0.00162234	2.5
Max. Deviation (ppm)	<b>4.08</b>	<b>0.002170213</b>	2.5

### Voltage vs. Frequency Stability

Voltage(Volts)	Frequency Error (Hz)	Frequency Error (ppm)	Limit(ppm)
4.5	1.81	0.000962766	2.5
5	2.33	0.001239362	2.5
5.5	2.34	0.001244681	2.5
Max. Deviation (ppm)	2.34	<b>0.001244681</b>	2.5

Test Mode:	LTE Band 2_CH18900_15M
------------	------------------------

**Temperature vs. Frequency Stability**

Temperature(°C)	Frequency Error (Hz)	Frequency Error (ppm)	Limit(ppm)
-30	1.18	0.00062766	2.5
-20	2.31	0.001228723	2.5
-10	-2.31	0.001228723	2.5
0	1.87	0.000994681	2.5
10	3.14	0.001670213	2.5
20	-1.94	0.001031915	2.5
30	2.56	0.001361702	2.5
40	3.61	0.001920213	2.5
50	2.11	0.00112234	2.5
Max. Deviation (ppm)	<b>3.61</b>	<b>0.001920213</b>	2.5

**Voltage vs. Frequency Stability**

Voltage(Volts)	Frequency Error (Hz)	Frequency Error (ppm)	Limit(ppm)
4.5	2.58	0.00137234	2.5
5	-3.17	0.00168617	2.5
5.5	-2.88	0.001531915	2.5
Max. Deviation (ppm)	<b>3.17</b>	<b>0.00168617</b>	2.5

Test Mode:	LTE Band 2_CH18900_20M
------------	------------------------

### Temperature vs. Frequency Stability

Temperature(°C)	Frequency Error (Hz)	Frequency Error (ppm)	Limit(ppm)
-30	-2.08	0.001106383	2.5
-20	-3.38	0.001797872	2.5
-10	2.24	0.001191489	2.5
0	2.59	0.00137766	2.5
10	-3.09	0.001643617	2.5
20	3.27	0.001739362	2.5
30	2.61	0.001388298	2.5
40	1.95	0.001037234	2.5
50	4.14	0.002202128	2.5
Max. Deviation (ppm)	<b>4.14</b>	<b>0.002202128</b>	2.5

### Voltage vs. Frequency Stability

Voltage(Volts)	Frequency Error (Hz)	Frequency Error (ppm)	Limit(ppm)
4.5	-1.99	0.001058511	2.5
5	2.07	0.001101064	2.5
5.5	2.54	0.001351064	2.5
Max. Deviation (ppm)	<b>2.54</b>	<b>0.001351064</b>	2.5