

10575-AAA	IEEE 802.11g WiFi 2.4 GHz (DSSS-OFDM, 6 Mbps, 90pc duty cycle)	X	4.35	66.71	16.26	0.46	130.0	± 9.6 %
		Y	4.30	66.33	16.09		130.0	
		Z	4.43	66.70	16.37		130.0	
10576-AAA	IEEE 802.11g WiFi 2.4 GHz (DSSS-OFDM, 9 Mbps, 90pc duty cycle)	X	4.39	66.95	16.37	0.46	130.0	± 9.6 %
		Y	4.33	66.56	16.19		130.0	
		Z	4.46	66.91	16.46		130.0	
10577-AAA	IEEE 802.11g WiFi 2.4 GHz (DSSS-OFDM, 12 Mbps, 90pc duty cycle)	X	4.53	67.16	16.51	0.46	130.0	± 9.6 %
		Y	4.48	66.78	16.33		130.0	
		Z	4.62	67.14	16.60		130.0	
10578-AAA	IEEE 802.11g WiFi 2.4 GHz (DSSS-OFDM, 18 Mbps, 90pc duty cycle)	X	4.45	67.33	16.63	0.46	130.0	± 9.6 %
		Y	4.39	66.92	16.44		130.0	
		Z	4.52	67.28	16.71		130.0	
10579-AAA	IEEE 802.11g WiFi 2.4 GHz (DSSS-OFDM, 24 Mbps, 90pc duty cycle)	X	4.18	66.40	15.81	0.46	130.0	± 9.6 %
		Y	4.14	66.03	15.63		130.0	
		Z	4.28	66.46	15.95		130.0	
10580-AAA	IEEE 802.11g WiFi 2.4 GHz (DSSS-OFDM, 36 Mbps, 90pc duty cycle)	X	4.20	66.40	15.80	0.46	130.0	± 9.6 %
		Y	4.16	66.06	15.64		130.0	
		Z	4.31	66.50	15.97		130.0	
10581-AAA	IEEE 802.11g WiFi 2.4 GHz (DSSS-OFDM, 48 Mbps, 90pc duty cycle)	X	4.37	67.44	16.63	0.46	130.0	± 9.6 %
		Y	4.30	67.01	16.42		130.0	
		Z	4.44	67.38	16.70		130.0	
10582-AAA	IEEE 802.11g WiFi 2.4 GHz (DSSS-OFDM, 54 Mbps, 90pc duty cycle)	X	4.10	66.14	15.57	0.46	130.0	± 9.6 %
		Y	4.06	65.79	15.40		130.0	
		Z	4.20	66.22	15.73		130.0	
10583-AAB	IEEE 802.11a/h WiFi 5 GHz (OFDM, 6 Mbps, 90pc duty cycle)	X	4.35	66.71	16.26	0.46	130.0	± 9.6 %
		Y	4.30	66.33	16.09		130.0	
		Z	4.43	66.70	16.37		130.0	
10584-AAB	IEEE 802.11a/h WiFi 5 GHz (OFDM, 9 Mbps, 90pc duty cycle)	X	4.39	66.95	16.37	0.46	130.0	± 9.6 %
		Y	4.33	66.56	16.19		130.0	
		Z	4.46	66.91	16.46		130.0	
10585-AAB	IEEE 802.11a/h WiFi 5 GHz (OFDM, 12 Mbps, 90pc duty cycle)	X	4.53	67.16	16.51	0.46	130.0	± 9.6 %
		Y	4.48	66.78	16.33		130.0	
		Z	4.62	67.14	16.60		130.0	
10586-AAB	IEEE 802.11a/h WiFi 5 GHz (OFDM, 18 Mbps, 90pc duty cycle)	X	4.45	67.33	16.63	0.46	130.0	± 9.6 %
		Y	4.39	66.92	16.44		130.0	
		Z	4.52	67.28	16.71		130.0	
10587-AAB	IEEE 802.11a/h WiFi 5 GHz (OFDM, 24 Mbps, 90pc duty cycle)	X	4.18	66.40	15.81	0.46	130.0	± 9.6 %
		Y	4.14	66.03	15.63		130.0	
		Z	4.28	66.46	15.95		130.0	
10588-AAB	IEEE 802.11a/h WiFi 5 GHz (OFDM, 36 Mbps, 90pc duty cycle)	X	4.20	66.40	15.80	0.46	130.0	± 9.6 %
		Y	4.16	66.06	15.64		130.0	
		Z	4.31	66.50	15.97		130.0	
10589-AAB	IEEE 802.11a/h WiFi 5 GHz (OFDM, 48 Mbps, 90pc duty cycle)	X	4.37	67.44	16.63	0.46	130.0	± 9.6 %
		Y	4.30	67.01	16.42		130.0	
		Z	4.44	67.38	16.70		130.0	
10590-AAB	IEEE 802.11a/h WiFi 5 GHz (OFDM, 54 Mbps, 90pc duty cycle)	X	4.10	66.14	15.57	0.46	130.0	± 9.6 %
		Y	4.06	65.79	15.40		130.0	
		Z	4.20	66.22	15.73		130.0	

10591-AAB	IEEE 802.11n (HT Mixed, 20MHz, MCS0, 90pc duty cycle)	X	4.52	66.84	16.41	0.46	130.0	± 9.6 %
		Y	4.46	66.46	16.24		130.0	
		Z	4.59	66.79	16.49		130.0	
10592-AAB	IEEE 802.11n (HT Mixed, 20MHz, MCS1, 90pc duty cycle)	X	4.62	67.09	16.52	0.46	130.0	± 9.6 %
		Y	4.57	66.73	16.36		130.0	
		Z	4.70	67.07	16.61		130.0	
10593-AAB	IEEE 802.11n (HT Mixed, 20MHz, MCS2, 90pc duty cycle)	X	4.54	66.96	16.37	0.46	130.0	± 9.6 %
		Y	4.48	66.59	16.20		130.0	
		Z	4.62	66.95	16.47		130.0	
10594-AAB	IEEE 802.11n (HT Mixed, 20MHz, MCS3, 90pc duty cycle)	X	4.59	67.15	16.55	0.46	130.0	± 9.6 %
		Y	4.54	66.78	16.38		130.0	
		Z	4.68	67.13	16.64		130.0	
10595-AAB	IEEE 802.11n (HT Mixed, 20MHz, MCS4, 90pc duty cycle)	X	4.55	67.13	16.46	0.46	130.0	± 9.6 %
		Y	4.50	66.75	16.29		130.0	
		Z	4.64	67.11	16.55		130.0	
10596-AAB	IEEE 802.11n (HT Mixed, 20MHz, MCS5, 90pc duty cycle)	X	4.48	67.05	16.43	0.46	130.0	± 9.6 %
		Y	4.43	66.69	16.26		130.0	
		Z	4.57	67.07	16.54		130.0	
10597-AAB	IEEE 802.11n (HT Mixed, 20MHz, MCS6, 90pc duty cycle)	X	4.43	66.92	16.28	0.46	130.0	± 9.6 %
		Y	4.38	66.55	16.10		130.0	
		Z	4.52	66.94	16.39		130.0	
10598-AAB	IEEE 802.11n (HT Mixed, 20MHz, MCS7, 90pc duty cycle)	X	4.44	67.20	16.58	0.46	130.0	± 9.6 %
		Y	4.38	66.80	16.39		130.0	
		Z	4.52	67.17	16.66		130.0	
10599-AAB	IEEE 802.11n (HT Mixed, 40MHz, MCS0, 90pc duty cycle)	X	5.20	67.24	16.67	0.46	130.0	± 9.6 %
		Y	5.18	67.00	16.58		130.0	
		Z	5.27	67.24	16.74		130.0	
10600-AAB	IEEE 802.11n (HT Mixed, 40MHz, MCS1, 90pc duty cycle)	X	5.26	67.48	16.76	0.46	130.0	± 9.6 %
		Y	5.28	67.39	16.75		130.0	
		Z	5.36	67.57	16.88		130.0	
10601-AAB	IEEE 802.11n (HT Mixed, 40MHz, MCS2, 90pc duty cycle)	X	5.22	67.44	16.76	0.46	130.0	± 9.6 %
		Y	5.19	67.20	16.67		130.0	
		Z	5.27	67.38	16.80		130.0	
10602-AAB	IEEE 802.11n (HT Mixed, 40MHz, MCS3, 90pc duty cycle)	X	5.25	67.28	16.59	0.46	130.0	± 9.6 %
		Y	5.26	67.13	16.55		130.0	
		Z	5.35	67.37	16.71		130.0	
10603-AAB	IEEE 802.11n (HT Mixed, 40MHz, MCS4, 90pc duty cycle)	X	5.31	67.54	16.87	0.46	130.0	± 9.6 %
		Y	5.31	67.39	16.83		130.0	
		Z	5.42	67.67	17.00		130.0	
10604-AAB	IEEE 802.11n (HT Mixed, 40MHz, MCS5, 90pc duty cycle)	X	5.18	67.09	16.61	0.46	130.0	± 9.6 %
		Y	5.17	66.89	16.55		130.0	
		Z	5.30	67.26	16.77		130.0	
10605-AAB	IEEE 802.11n (HT Mixed, 40MHz, MCS6, 90pc duty cycle)	X	5.25	67.33	16.73	0.46	130.0	± 9.6 %
		Y	5.25	67.17	16.69		130.0	
		Z	5.35	67.43	16.86		130.0	
10606-AAB	IEEE 802.11n (HT Mixed, 40MHz, MCS7, 90pc duty cycle)	X	5.07	66.89	16.36	0.46	130.0	± 9.6 %
		Y	5.06	66.68	16.29		130.0	
		Z	5.15	66.91	16.45		130.0	

10607-AAB	IEEE 802.11ac WiFi (20MHz, MCS0, 90pc duty cycle)	X	4.37	66.21	16.07	0.46	130.0	± 9.6 %
		Y	4.31	65.78	15.88		130.0	
		Z	4.44	66.16	16.15		130.0	
10608-AAB	IEEE 802.11ac WiFi (20MHz, MCS1, 90pc duty cycle)	X	4.48	66.49	16.20	0.46	130.0	± 9.6 %
		Y	4.43	66.08	16.01		130.0	
		Z	4.57	66.48	16.29		130.0	
10609-AAB	IEEE 802.11ac WiFi (20MHz, MCS2, 90pc duty cycle)	X	4.38	66.32	16.02	0.46	130.0	± 9.6 %
		Y	4.33	65.90	15.82		130.0	
		Z	4.47	66.31	16.11		130.0	
10610-AAB	IEEE 802.11ac WiFi (20MHz, MCS3, 90pc duty cycle)	X	4.44	66.50	16.20	0.46	130.0	± 9.6 %
		Y	4.38	66.09	16.00		130.0	
		Z	4.52	66.48	16.28		130.0	
10611-AAB	IEEE 802.11ac WiFi (20MHz, MCS4, 90pc duty cycle)	X	4.35	66.27	16.03	0.46	130.0	± 9.6 %
		Y	4.29	65.86	15.83		130.0	
		Z	4.43	66.28	16.13		130.0	
10612-AAB	IEEE 802.11ac WiFi (20MHz, MCS5, 90pc duty cycle)	X	4.32	66.35	16.04	0.46	130.0	± 9.6 %
		Y	4.27	65.96	15.85		130.0	
		Z	4.42	66.40	16.16		130.0	
10613-AAB	IEEE 802.11ac WiFi (20MHz, MCS6, 90pc duty cycle)	X	4.32	66.16	15.88	0.46	130.0	± 9.6 %
		Y	4.27	65.77	15.69		130.0	
		Z	4.42	66.21	16.00		130.0	
10614-AAB	IEEE 802.11ac WiFi (20MHz, MCS7, 90pc duty cycle)	X	4.31	66.45	16.17	0.46	130.0	± 9.6 %
		Y	4.25	66.02	15.97		130.0	
		Z	4.39	66.45	16.26		130.0	
10615-AAB	IEEE 802.11ac WiFi (20MHz, MCS8, 90pc duty cycle)	X	4.33	66.09	15.77	0.46	130.0	± 9.6 %
		Y	4.28	65.68	15.58		130.0	
		Z	4.43	66.11	15.90		130.0	
10616-AAB	IEEE 802.11ac WiFi (40MHz, MCS0, 90pc duty cycle)	X	5.00	66.41	16.24	0.46	130.0	± 9.6 %
		Y	4.96	66.09	16.11		130.0	
		Z	5.08	66.43	16.32		130.0	
10617-AAB	IEEE 802.11ac WiFi (40MHz, MCS1, 90pc duty cycle)	X	5.02	66.47	16.25	0.46	130.0	± 9.6 %
		Y	4.99	66.20	16.14		130.0	
		Z	5.11	66.54	16.35		130.0	
10618-AAB	IEEE 802.11ac WiFi (40MHz, MCS2, 90pc duty cycle)	X	4.94	66.56	16.31	0.46	130.0	± 9.6 %
		Y	4.90	66.23	16.17		130.0	
		Z	5.03	66.61	16.40		130.0	
10619-AAB	IEEE 802.11ac WiFi (40MHz, MCS3, 90pc duty cycle)	X	4.98	66.45	16.18	0.46	130.0	± 9.6 %
		Y	4.95	66.17	16.07		130.0	
		Z	5.05	66.46	16.26		130.0	
10620-AAB	IEEE 802.11ac WiFi (40MHz, MCS4, 90pc duty cycle)	X	5.02	66.37	16.19	0.46	130.0	± 9.6 %
		Y	5.00	66.10	16.08		130.0	
		Z	5.11	66.43	16.29		130.0	
10621-AAB	IEEE 802.11ac WiFi (40MHz, MCS5, 90pc duty cycle)	X	5.05	66.54	16.40	0.46	130.0	± 9.6 %
		Y	5.01	66.21	16.27		130.0	
		Z	5.12	66.55	16.47		130.0	
10622-AAB	IEEE 802.11ac WiFi (40MHz, MCS6, 90pc duty cycle)	X	5.03	66.60	16.43	0.46	130.0	± 9.6 %
		Y	4.99	66.30	16.31		130.0	
		Z	5.11	66.63	16.51		130.0	

10623-AAB	IEEE 802.11ac WiFi (40MHz, MCS7, 90pc duty cycle)	X	4.93	66.19	16.08	0.46	130.0	± 9.6 %
		Y	4.89	65.86	15.94		130.0	
		Z	5.01	66.20	16.16		130.0	
10624-AAB	IEEE 802.11ac WiFi (40MHz, MCS8, 90pc duty cycle)	X	5.12	66.43	16.27	0.46	130.0	± 9.6 %
		Y	5.08	66.13	16.15		130.0	
		Z	5.20	66.46	16.35		130.0	
10625-AAB	IEEE 802.11ac WiFi (40MHz, MCS9, 90pc duty cycle)	X	5.22	66.64	16.44	0.46	130.0	± 9.6 %
		Y	5.19	66.35	16.33		130.0	
		Z	5.28	66.57	16.47		130.0	
10626-AAB	IEEE 802.11ac WiFi (80MHz, MCS0, 90pc duty cycle)	X	5.35	66.41	16.19	0.46	130.0	± 9.6 %
		Y	5.31	66.11	16.07		130.0	
		Z	5.41	66.44	16.27		130.0	
10627-AAB	IEEE 802.11ac WiFi (80MHz, MCS1, 90pc duty cycle)	X	5.55	66.98	16.45	0.46	130.0	± 9.6 %
		Y	5.55	66.80	16.40		130.0	
		Z	5.63	67.04	16.54		130.0	
10628-AAB	IEEE 802.11ac WiFi (80MHz, MCS2, 90pc duty cycle)	X	5.33	66.36	16.06	0.46	130.0	± 9.6 %
		Y	5.29	66.07	15.96		130.0	
		Z	5.40	66.42	16.16		130.0	
10629-AAB	IEEE 802.11ac WiFi (80MHz, MCS3, 90pc duty cycle)	X	5.45	66.63	16.20	0.46	130.0	± 9.6 %
		Y	5.44	66.42	16.13		130.0	
		Z	5.51	66.62	16.26		130.0	
10630-AAB	IEEE 802.11ac WiFi (80MHz, MCS4, 90pc duty cycle)	X	5.58	67.21	16.50	0.46	130.0	± 9.6 %
		Y	5.62	67.16	16.51		130.0	
		Z	5.72	67.46	16.68		130.0	
10631-AAB	IEEE 802.11ac WiFi (80MHz, MCS5, 90pc duty cycle)	X	5.60	67.42	16.80	0.46	130.0	± 9.6 %
		Y	5.59	67.20	16.72		130.0	
		Z	5.70	67.52	16.90		130.0	
10632-AAB	IEEE 802.11ac WiFi (80MHz, MCS6, 90pc duty cycle)	X	5.58	67.27	16.74	0.46	130.0	± 9.6 %
		Y	5.58	67.08	16.68		130.0	
		Z	5.64	67.24	16.78		130.0	
10633-AAB	IEEE 802.11ac WiFi (80MHz, MCS7, 90pc duty cycle)	X	5.35	66.43	16.14	0.46	130.0	± 9.6 %
		Y	5.31	66.13	16.03		130.0	
		Z	5.43	66.50	16.23		130.0	
10634-AAB	IEEE 802.11ac WiFi (80MHz, MCS8, 90pc duty cycle)	X	5.39	66.68	16.32	0.46	130.0	± 9.6 %
		Y	5.35	66.35	16.19		130.0	
		Z	5.46	66.70	16.38		130.0	
10635-AAB	IEEE 802.11ac WiFi (80MHz, MCS9, 90pc duty cycle)	X	5.23	65.85	15.61	0.46	130.0	± 9.6 %
		Y	5.20	65.57	15.51		130.0	
		Z	5.31	65.95	15.74		130.0	
10636-AAC	IEEE 802.11ac WiFi (160MHz, MCS0, 90pc duty cycle)	X	5.79	66.75	16.27	0.46	130.0	± 9.6 %
		Y	5.75	66.48	16.18		130.0	
		Z	5.85	66.79	16.35		130.0	
10637-AAC	IEEE 802.11ac WiFi (160MHz, MCS1, 90pc duty cycle)	X	5.87	66.98	16.38	0.46	130.0	± 9.6 %
		Y	5.87	66.78	16.32		130.0	
		Z	5.96	67.08	16.48		130.0	
10638-AAC	IEEE 802.11ac WiFi (160MHz, MCS2, 90pc duty cycle)	X	5.93	67.13	16.43	0.46	130.0	± 9.6 %
		Y	5.90	66.89	16.35		130.0	
		Z	5.99	67.17	16.50		130.0	

10639-AAC	IEEE 802.11ac WiFi (160MHz, MCS3, 90pc duty cycle)	X	5.87	66.97	16.39	0.46	130.0	± 9.6 %
		Y	5.84	66.71	16.30		130.0	
		Z	5.94	67.03	16.47		130.0	
10640-AAC	IEEE 802.11ac WiFi (160MHz, MCS4, 90pc duty cycle)	X	5.80	66.76	16.23	0.46	130.0	± 9.6 %
		Y	5.78	66.52	16.15		130.0	
		Z	5.89	66.90	16.36		130.0	
10641-AAC	IEEE 802.11ac WiFi (160MHz, MCS5, 90pc duty cycle)	X	5.92	66.91	16.32	0.46	130.0	± 9.6 %
		Y	5.92	66.73	16.28		130.0	
		Z	6.00	67.00	16.43		130.0	
10642-AAC	IEEE 802.11ac WiFi (160MHz, MCS6, 90pc duty cycle)	X	5.94	67.12	16.60	0.46	130.0	± 9.6 %
		Y	5.91	66.86	16.51		130.0	
		Z	6.02	67.19	16.68		130.0	
10643-AAC	IEEE 802.11ac WiFi (160MHz, MCS7, 90pc duty cycle)	X	5.78	66.77	16.31	0.46	130.0	± 9.6 %
		Y	5.76	66.54	16.24		130.0	
		Z	5.87	66.88	16.43		130.0	
10644-AAC	IEEE 802.11ac WiFi (160MHz, MCS8, 90pc duty cycle)	X	5.83	66.93	16.41	0.46	130.0	± 9.6 %
		Y	5.81	66.68	16.33		130.0	
		Z	5.92	67.05	16.53		130.0	
10645-AAC	IEEE 802.11ac WiFi (160MHz, MCS9, 90pc duty cycle)	X	5.96	67.02	16.42	0.46	130.0	± 9.6 %
		Y	5.95	66.81	16.36		130.0	
		Z	6.04	67.10	16.52		130.0	
10646-AAD	LTE-TDD (SC-FDMA, 1 RB, 5 MHz, QPSK, UL Subframe=2,7)	X	5.44	86.39	29.87	9.30	60.0	± 9.6 %
		Y	5.81	87.60	30.48		60.0	
		Z	8.19	97.49	34.99		60.0	
10647-AAC	LTE-TDD (SC-FDMA, 1 RB, 20 MHz, QPSK, UL Subframe=2,7)	X	4.80	83.95	29.04	9.30	60.0	± 9.6 %
		Y	5.16	85.32	29.73		60.0	
		Z	6.96	93.94	33.85		60.0	
10648-AAA	CDMA2000 (1x Advanced)	X	0.46	61.39	7.82	0.00	150.0	± 9.6 %
		Y	0.37	60.00	5.96		150.0	
		Z	0.50	61.65	8.29		150.0	
10652-AAB	LTE-TDD (OFDMA, 5 MHz, E-TM 3.1, Clipping 44%)	X	3.12	66.28	15.70	2.23	80.0	± 9.6 %
		Y	3.02	65.66	15.43		80.0	
		Z	3.33	67.03	16.40		80.0	
10653-AAB	LTE-TDD (OFDMA, 10 MHz, E-TM 3.1, Clipping 44%)	X	3.68	65.65	16.11	2.23	80.0	± 9.6 %
		Y	3.61	65.21	15.95		80.0	
		Z	3.84	66.09	16.56		80.0	
10654-AAB	LTE-TDD (OFDMA, 15 MHz, E-TM 3.1, Clipping 44%)	X	3.72	65.26	16.17	2.23	80.0	± 9.6 %
		Y	3.65	64.85	16.03		80.0	
		Z	3.85	65.65	16.58		80.0	
10655-AAB	LTE-TDD (OFDMA, 20 MHz, E-TM 3.1, Clipping 44%)	X	3.80	65.15	16.21	2.23	80.0	± 9.6 %
		Y	3.73	64.76	16.08		80.0	
		Z	3.92	65.55	16.60		80.0	
10658-AAA	Pulse Waveform (200Hz, 10%)	X	4.75	72.59	13.37	10.00	50.0	± 9.6 %
		Y	4.19	71.13	12.85		50.0	
		Z	100.00	107.57	23.92		50.0	
10659-AAA	Pulse Waveform (200Hz, 20%)	X	22.00	88.58	17.14	6.99	60.0	± 9.6 %
		Y	3.94	73.01	12.37		60.0	
		Z	100.00	108.47	23.27		60.0	

10660-AAA	Pulse Waveform (200Hz, 40%)	X	100.00	102.05	19.10	3.98	80.0	± 9.6 %
		Y	1.41	67.41	8.85		80.0	
		Z	100.00	113.17	24.00		80.0	
10661-AAA	Pulse Waveform (200Hz, 60%)	X	100.00	106.07	19.76	2.22	100.0	± 9.6 %
		Y	0.27	60.00	4.29		100.0	
		Z	100.00	121.09	26.01		100.0	
10662-AAA	Pulse Waveform (200Hz, 80%)	X	100.00	125.21	25.72	0.97	120.0	± 9.6 %
		Y	8.44	216.63	6.72		120.0	
		Z	100.00	139.04	31.03		120.0	

^E Uncertainty is determined using the max. deviation from linear response applying rectangular distribution and is expressed for the square of the field value.



Accredited by the Swiss Accreditation Service (SAS)
The Swiss Accreditation Service is one of the signatories to the EA
Multilateral Agreement for the recognition of calibration certificates

Accreditation No.: **SCS 0108**

Client **Huawei-SZ (Auden)**

Certificate No: **EX3-3744_Jul18**

CALIBRATION CERTIFICATE

Object **EX3DV4 - SN:3744**

Calibration procedure(s) **QA CAL-01.v9, QA CAL-23.v5, QA CAL-25.v6
Calibration procedure for dosimetric E-field probes**

Calibration date: **July 25, 2018**

This calibration certificate documents the traceability to national standards, which realize the physical units of measurements (SI).
The measurements and the uncertainties with confidence probability are given on the following pages and are part of the certificate.

All calibrations have been conducted in the closed laboratory facility: environment temperature (22 ± 3)°C and humidity < 70%.

Calibration Equipment used (M&TE critical for calibration)

Primary Standards	ID	Cal Date (Certificate No.)	Scheduled Calibration
Power meter NRP	SN: 104778	04-Apr-18 (No. 217-02672/02673)	Apr-19
Power sensor NRP-Z91	SN: 103244	04-Apr-18 (No. 217-02672)	Apr-19
Power sensor NRP-Z91	SN: 103245	04-Apr-18 (No. 217-02673)	Apr-19
Reference 20 dB Attenuator	SN: S5277 (20x)	04-Apr-18 (No. 217-02682)	Apr-19
Reference Probe ES3DV2	SN: 3013	30-Dec-17 (No. ES3-3013_Dec17)	Dec-18
DAE4	SN: 660	21-Dec-17 (No. DAE4-660_Dec17)	Dec-18
Secondary Standards	ID	Check Date (in house)	Scheduled Check
Power meter E4419B	SN: GB41293874	06-Apr-16 (in house check Jun-18)	In house check: Jun-20
Power sensor E4412A	SN: MY41498087	06-Apr-16 (in house check Jun-18)	In house check: Jun-20
Power sensor E4412A	SN: 000110210	06-Apr-16 (in house check Jun-18)	In house check: Jun-20
RF generator HP 8648C	SN: US3642U01700	04-Aug-99 (in house check Jun-18)	In house check: Jun-20
Network Analyzer E8358A	SN: US41080477	31-Mar-14 (in house check Oct-17)	In house check: Oct-18

	Name	Function	Signature
Calibrated by:	Claudio Leubler	Laboratory Technician	
Approved by:	Katja Pokovic	Technical Manager	

Issued: July 28, 2018

This calibration certificate shall not be reproduced except in full without written approval of the laboratory.



Accredited by the Swiss Accreditation Service (SAS)
The Swiss Accreditation Service is one of the signatories to the EA
Multilateral Agreement for the recognition of calibration certificates

Accreditation No.: **SCS 0108**

Glossary:

TSL	tissue simulating liquid
NORM _{x,y,z}	sensitivity in free space
ConvF	sensitivity in TSL / NORM _{x,y,z}
DCP	diode compression point
CF	crest factor (1/duty_cycle) of the RF signal
A, B, C, D	modulation dependent linearization parameters
Polarization φ	φ rotation around probe axis
Polarization ϑ	ϑ rotation around an axis that is in the plane normal to probe axis (at measurement center), i.e., $\vartheta = 0$ is normal to probe axis
Connector Angle	information used in DASY system to align probe sensor X to the robot coordinate system

Calibration is Performed According to the Following Standards:

- IEEE Std 1528-2013, "IEEE Recommended Practice for Determining the Peak Spatial-Averaged Specific Absorption Rate (SAR) in the Human Head from Wireless Communications Devices: Measurement Techniques", June 2013
- IEC 62209-1, "Measurement procedure for the assessment of Specific Absorption Rate (SAR) from hand-held and body-mounted devices used next to the ear (frequency range of 300 MHz to 6 GHz)", July 2016
- IEC 62209-2, "Procedure to determine the Specific Absorption Rate (SAR) for wireless communication devices used in close proximity to the human body (frequency range of 30 MHz to 6 GHz)", March 2010
- KDB 865664, "SAR Measurement Requirements for 100 MHz to 6 GHz"

Methods Applied and Interpretation of Parameters:

- NORM_{x,y,z}**: Assessed for E-field polarization $\vartheta = 0$ ($f \leq 900$ MHz in TEM-cell; $f > 1800$ MHz: R22 waveguide). NORM_{x,y,z} are only intermediate values, i.e., the uncertainties of NORM_{x,y,z} does not affect the E²-field uncertainty inside TSL (see below *ConvF*).
- NORM(f)_{x,y,z}** = NORM_{x,y,z} * *frequency_response* (see Frequency Response Chart). This linearization is implemented in DASY4 software versions later than 4.2. The uncertainty of the frequency response is included in the stated uncertainty of *ConvF*.
- DCP_{x,y,z}**: DCP are numerical linearization parameters assessed based on the data of power sweep with CW signal (no uncertainty required). DCP does not depend on frequency nor media.
- PAR**: PAR is the Peak to Average Ratio that is not calibrated but determined based on the signal characteristics
- A_{x,y,z}; B_{x,y,z}; C_{x,y,z}; D_{x,y,z}; VR_{x,y,z}**: A, B, C, D are numerical linearization parameters assessed based on the data of power sweep for specific modulation signal. The parameters do not depend on frequency nor media. VR is the maximum calibration range expressed in RMS voltage across the diode.
- ConvF and Boundary Effect Parameters**: Assessed in flat phantom using E-field (or Temperature Transfer Standard for $f \leq 800$ MHz) and inside waveguide using analytical field distributions based on power measurements for $f > 800$ MHz. The same setups are used for assessment of the parameters applied for boundary compensation (alpha, depth) of which typical uncertainty values are given. These parameters are used in DASY4 software to improve probe accuracy close to the boundary. The sensitivity in TSL corresponds to NORM_{x,y,z} * *ConvF* whereby the uncertainty corresponds to that given for *ConvF*. A frequency dependent *ConvF* is used in DASY version 4.4 and higher which allows extending the validity from ± 50 MHz to ± 100 MHz.
- Spherical isotropy (3D deviation from isotropy)**: in a field of low gradients realized using a flat phantom exposed by a patch antenna.
- Sensor Offset**: The sensor offset corresponds to the offset of virtual measurement center from the probe tip (on probe axis). No tolerance required.
- Connector Angle**: The angle is assessed using the information gained by determining the NORM_x (no uncertainty required).

Probe EX3DV4

SN:3744

Manufactured: March 26, 2010
Calibrated: July 25, 2018

Calibrated for DASY/EASY Systems
(Note: non-compatible with DASY2 system!)

DASY/EASY - Parameters of Probe: EX3DV4 - SN:3744

Basic Calibration Parameters

	Sensor X	Sensor Y	Sensor Z	Unc (k=2)
Norm ($\mu\text{V}/(\text{V}/\text{m})^2$) ^A	0.47	0.48	0.40	$\pm 10.1\%$
DCP (mV) ^B	97.6	99.6	113.8	

Modulation Calibration Parameters

UID	Communication System Name		A dB	B dB $\sqrt{\mu\text{V}}$	C	D dB	VR mV	Unc ^E (k=2)
0	CW	X	0.0	0.0	1.0	0.00	156.2	$\pm 3.0\%$
		Y	0.0	0.0	1.0		156.0	
		Z	0.0	0.0	1.0		170.2	

The reported uncertainty of measurement is stated as the standard uncertainty of measurement multiplied by the coverage factor k=2, which for a normal distribution corresponds to a coverage probability of approximately 95%.

^A The uncertainties of Norm X,Y,Z do not affect the E²-field uncertainty inside TSL (see Pages 5 and 6).

^B Numerical linearization parameter: uncertainty not required.

^E Uncertainty is determined using the max. deviation from linear response applying rectangular distribution and is expressed for the square of the field value.

DASY/EASY - Parameters of Probe: EX3DV4 - SN:3744

Calibration Parameter Determined in Head Tissue Simulating Media

f (MHz) ^C	Relative Permittivity ^F	Conductivity (S/m) ^F	ConvF X	ConvF Y	ConvF Z	Alpha ^G	Depth ^G (mm)	Unc (k=2)
750	41.9	0.89	9.40	9.40	9.40	0.54	0.80	± 12.0 %
850	41.5	0.92	8.96	8.96	8.96	0.49	0.84	± 12.0 %
1750	40.1	1.37	8.27	8.27	8.27	0.10	1.12	± 12.0 %
1900	40.0	1.40	7.99	7.99	7.99	0.10	0.83	± 12.0 %
2000	40.0	1.40	7.78	7.78	7.78	0.10	0.80	± 12.0 %
2300	39.5	1.67	7.74	7.74	7.74	0.30	0.90	± 12.0 %
2450	39.2	1.80	7.24	7.24	7.24	0.30	0.95	± 12.0 %
2600	39.0	1.96	6.90	6.90	6.90	0.30	0.95	± 12.0 %

^C Frequency validity above 300 MHz of ± 100 MHz only applies for DASY v4.4 and higher (see Page 2), else it is restricted to ± 50 MHz. The uncertainty is the RSS of the ConvF uncertainty at calibration frequency and the uncertainty for the indicated frequency band. Frequency validity below 300 MHz is ± 10, 25, 40, 50 and 70 MHz for ConvF assessments at 30, 64, 128, 150 and 220 MHz respectively. Above 5 GHz frequency validity can be extended to ± 110 MHz.

^F At frequencies below 3 GHz, the validity of tissue parameters (ϵ and σ) can be relaxed to ± 10% if liquid compensation formula is applied to measured SAR values. At frequencies above 3 GHz, the validity of tissue parameters (ϵ and σ) is restricted to ± 5%. The uncertainty is the RSS of the ConvF uncertainty for indicated target tissue parameters.

^G Alpha/Depth are determined during calibration. SPEAG warrants that the remaining deviation due to the boundary effect after compensation is always less than ± 1% for frequencies below 3 GHz and below ± 2% for frequencies between 3-6 GHz at any distance larger than half the probe tip diameter from the boundary.

DASY/EASY - Parameters of Probe: EX3DV4 - SN:3744

Calibration Parameter Determined in Body Tissue Simulating Media

f (MHz) ^C	Relative Permittivity ^F	Conductivity (S/m) ^F	ConvF X	ConvF Y	ConvF Z	Alpha ^G	Depth ^G (mm)	Unc (k=2)
750	55.5	0.96	9.54	9.54	9.54	0.49	0.80	± 12.0 %
850	55.2	0.99	9.12	9.12	9.12	0.53	0.80	± 12.0 %
1750	53.4	1.49	7.74	7.74	7.74	0.45	0.80	± 12.0 %
1900	53.3	1.52	7.60	7.60	7.60	0.40	0.84	± 12.0 %
2300	52.9	1.81	7.56	7.56	7.56	0.45	0.85	± 12.0 %
2450	52.7	1.95	7.39	7.39	7.39	0.35	0.85	± 12.0 %
2600	52.5	2.16	7.35	7.35	7.35	0.30	0.99	± 12.0 %

^C Frequency validity above 300 MHz of ± 100 MHz only applies for DASY v4.4 and higher (see Page 2), else it is restricted to ± 50 MHz. The uncertainty is the RSS of the ConvF uncertainty at calibration frequency and the uncertainty for the indicated frequency band. Frequency validity below 300 MHz is ± 10, 25, 40, 50 and 70 MHz for ConvF assessments at 30, 64, 128, 150 and 220 MHz respectively. Above 5 GHz frequency validity can be extended to ± 110 MHz.

^F At frequencies below 3 GHz, the validity of tissue parameters (ϵ and σ) can be relaxed to ± 10% if liquid compensation formula is applied to measured SAR values. At frequencies above 3 GHz, the validity of tissue parameters (ϵ and σ) is restricted to ± 5%. The uncertainty is the RSS of the ConvF uncertainty for indicated target tissue parameters.

^G Alpha/Depth are determined during calibration. SPEAG warrants that the remaining deviation due to the boundary effect after compensation is always less than ± 1% for frequencies below 3 GHz and below ± 2% for frequencies between 3-6 GHz at any distance larger than half the probe tip diameter from the boundary.

Frequency Response of E-Field (TEM-Cell:ifi110 EXX, Waveguide: R22)

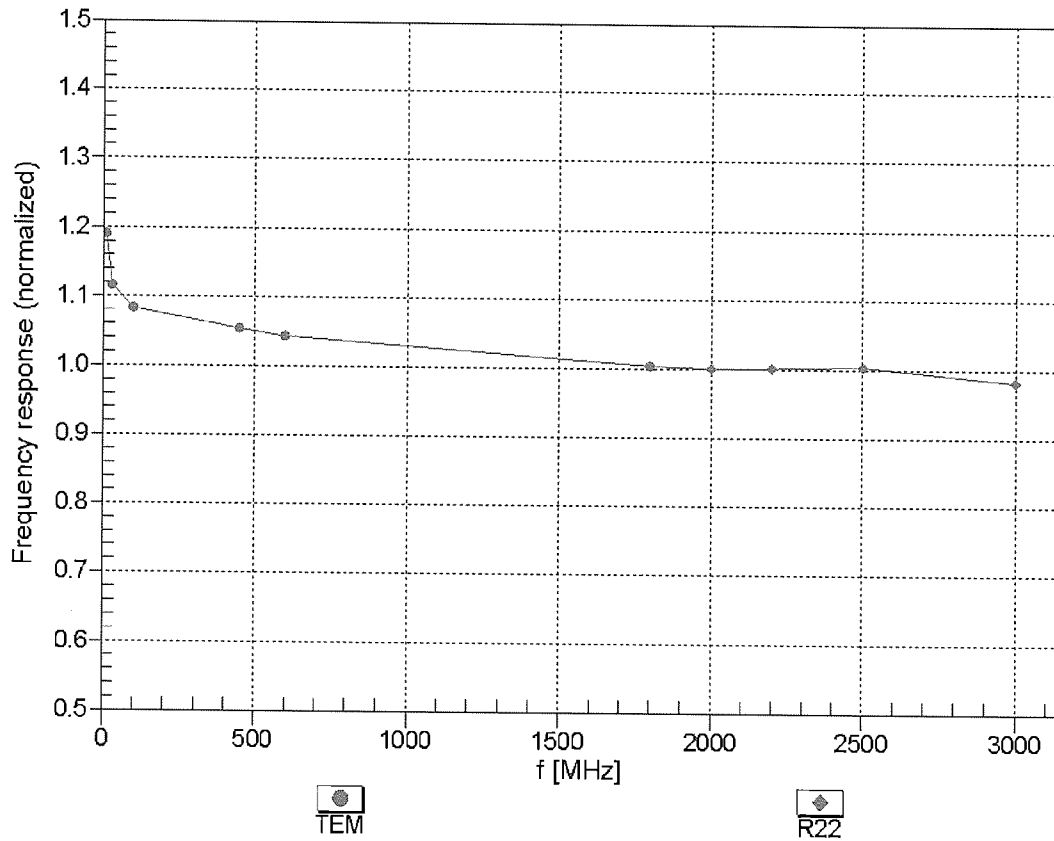

Uncertainty of Frequency Response of E-field: $\pm 6.3\%$ (k=2)

Receiving Pattern (ϕ), $\theta = 0^\circ$

f=600 MHz,TEM

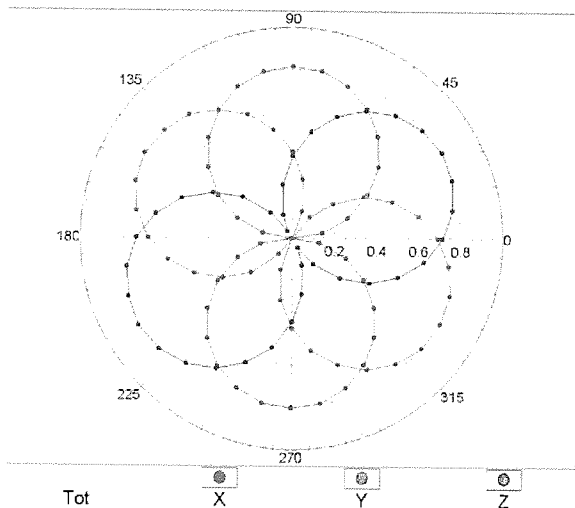

f=1800 MHz,R22

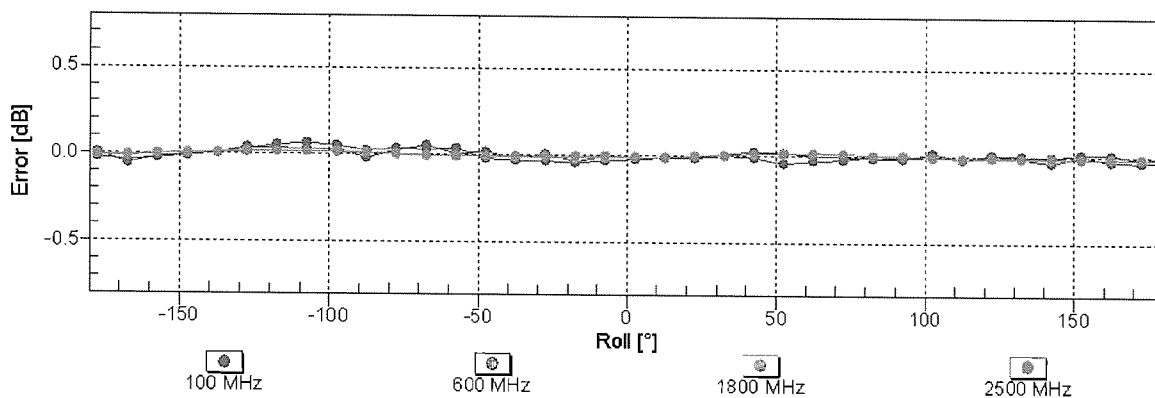
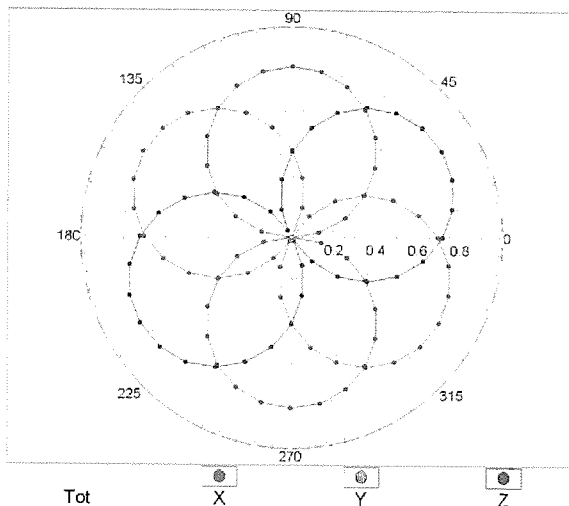

Uncertainty of Axial Isotropy Assessment: $\pm 0.5\%$ (k=2)

Dynamic Range $f(SAR_{head})$ (TEM cell , $f_{eval}= 1900$ MHz)

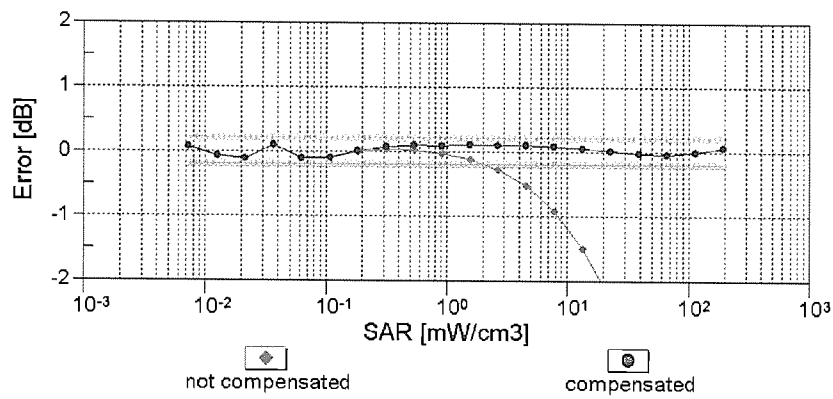
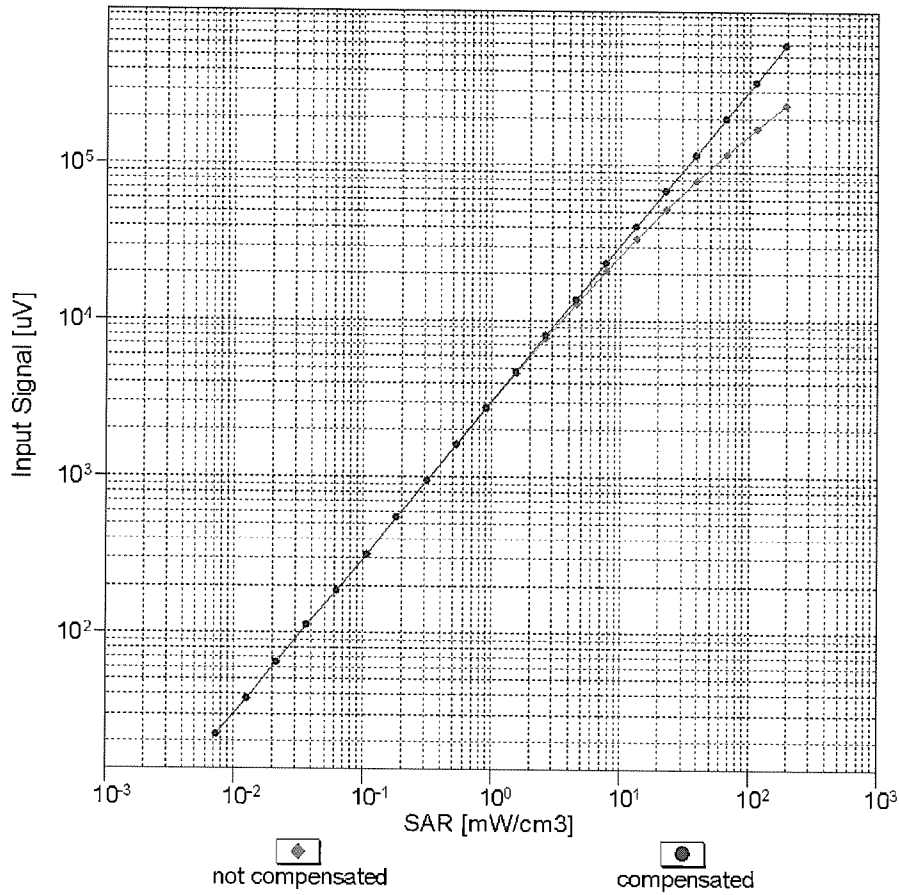

Uncertainty of Linearity Assessment: $\pm 0.6\%$ (k=2)

Conversion Factor Assessment

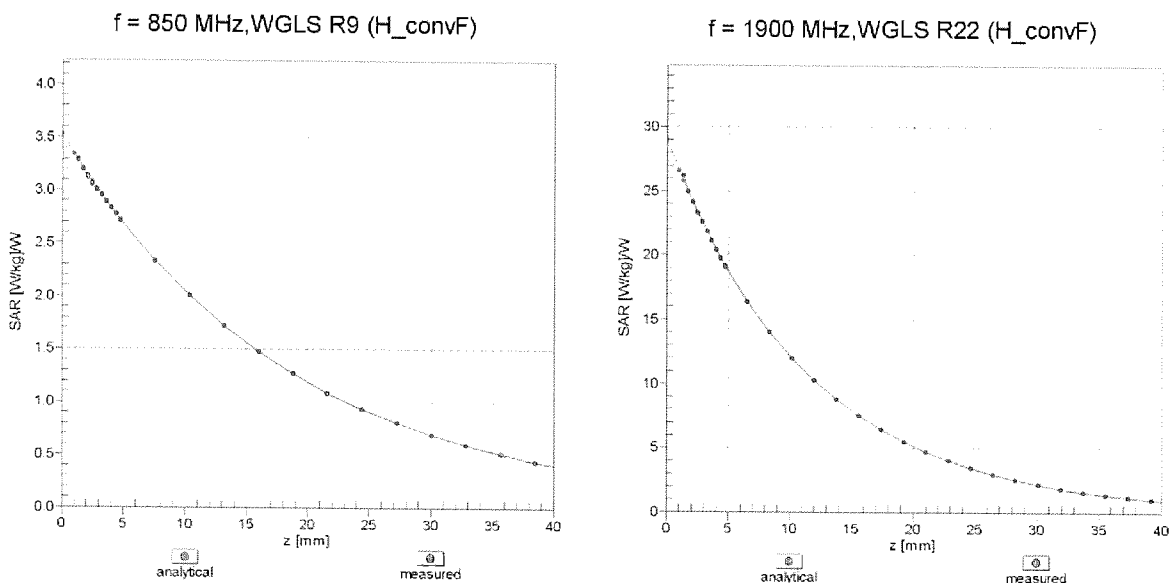

Deviation from Isotropy in Liquid Error (ϕ, θ), f = 900 MHz

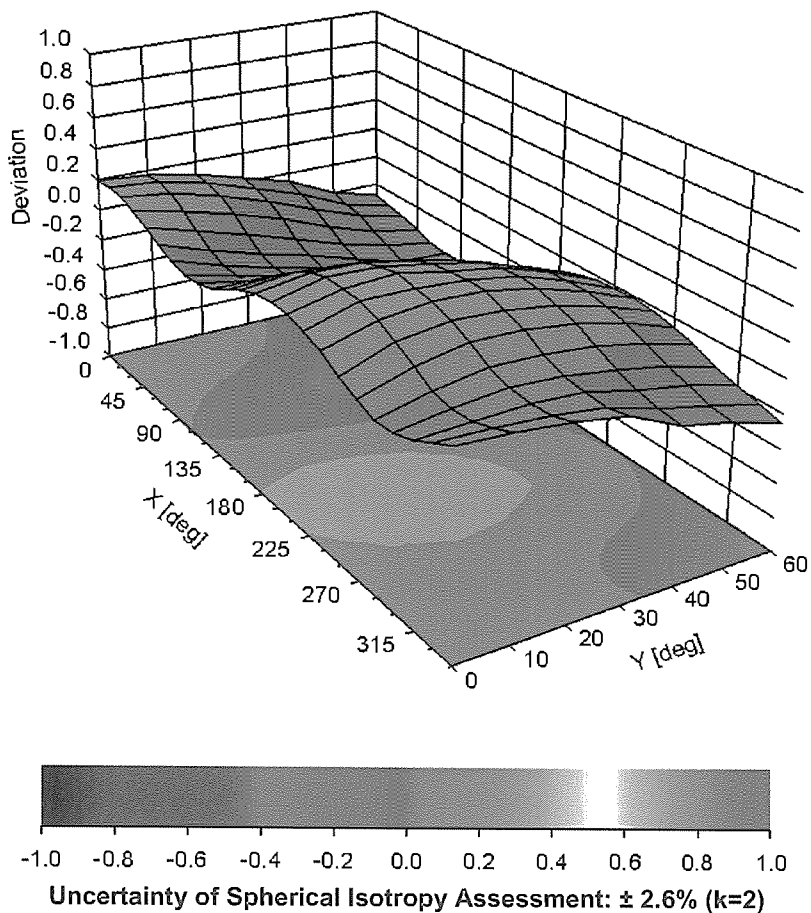

DASY/EASY - Parameters of Probe: EX3DV4 - SN:3744

Other Probe Parameters

Sensor Arrangement	Triangular
Connector Angle (°)	72.5
Mechanical Surface Detection Mode	enabled
Optical Surface Detection Mode	disabled
Probe Overall Length	337 mm
Probe Body Diameter	10 mm
Tip Length	9 mm
Tip Diameter	2.5 mm
Probe Tip to Sensor X Calibration Point	1 mm
Probe Tip to Sensor Y Calibration Point	1 mm
Probe Tip to Sensor Z Calibration Point	1 mm
Recommended Measurement Distance from Surface	1.4 mm



Accredited by the Swiss Accreditation Service (SAS)
The Swiss Accreditation Service is one of the signatories to the EA
Multilateral Agreement for the recognition of calibration certificates

Accreditation No.: **SCS 0108**

Client **Huawei-SZ (Auden)**

Certificate No: **DAE4-1236_Jul18**

CALIBRATION CERTIFICATE

Object **DAE4 - SD 000 D04 BM - SN: 1236**

Calibration procedure(s) **QA CAL-06.v29
Calibration procedure for the data acquisition electronics (DAE)**

Calibration date: **July 18, 2018**

This calibration certificate documents the traceability to national standards, which realize the physical units of measurements (SI).
The measurements and the uncertainties with confidence probability are given on the following pages and are part of the certificate.
All calibrations have been conducted in the closed laboratory facility: environment temperature (22 ± 3)°C and humidity < 70%.

Calibration Equipment used (M&TE critical for calibration)

Primary Standards	ID #	Cal Date (Certificate No.)	Scheduled Calibration
Keithley Multimeter Type 2001	SN: 0810278	31-Aug-17 (No:21092)	Aug-18
Secondary Standards	ID #	Check Date (in house)	Scheduled Check
Auto DAE Calibration Unit	SE UWS 053 AA 1001	04-Jan-18 (in house check)	In house check: Jan-19
Calibrator Box V2.1	SE UMS 006 AA 1002	04-Jan-18 (in house check)	In house check: Jan-19

	Name	Function	Signature
Calibrated by:	Dominique Steffen	Laboratory Technician	
Approved by:	Sven Kühn	Deputy Manager	

Issued: July 18, 2018

This calibration certificate shall not be reproduced except in full without written approval of the laboratory.



Accredited by the Swiss Accreditation Service (SAS)

The Swiss Accreditation Service is one of the signatories to the EA
Multilateral Agreement for the recognition of calibration certificates

Accreditation No.: **SCS 0108**

Glossary

DAE	data acquisition electronics
Connector angle	information used in DASY system to align probe sensor X to the robot coordinate system.

Methods Applied and Interpretation of Parameters

- *DC Voltage Measurement:* Calibration Factor assessed for use in DASY system by comparison with a calibrated instrument traceable to national standards. The figure given corresponds to the full scale range of the voltmeter in the respective range.
- *Connector angle:* The angle of the connector is assessed measuring the angle mechanically by a tool inserted. Uncertainty is not required.
- The following parameters as documented in the Appendix contain technical information as a result from the performance test and require no uncertainty.
 - *DC Voltage Measurement Linearity:* Verification of the Linearity at +10% and -10% of the nominal calibration voltage. Influence of offset voltage is included in this measurement.
 - *Common mode sensitivity:* Influence of a positive or negative common mode voltage on the differential measurement.
 - *Channel separation:* Influence of a voltage on the neighbor channels not subject to an input voltage.
 - *AD Converter Values with inputs shorted:* Values on the internal AD converter corresponding to zero input voltage
 - *Input Offset Measurement:* Output voltage and statistical results over a large number of zero voltage measurements.
 - *Input Offset Current:* Typical value for information; Maximum channel input offset current, not considering the input resistance.
 - *Input resistance:* Typical value for information: DAE input resistance at the connector, during internal auto-zeroing and during measurement.
 - *Low Battery Alarm Voltage:* Typical value for information. Below this voltage, a battery alarm signal is generated.
 - *Power consumption:* Typical value for information. Supply currents in various operating modes.

DC Voltage Measurement

A/D - Converter Resolution nominal

High Range: 1LSB = 6.1 μ V, full range = -100...+300 mV

Low Range: 1LSB = 61nV, full range = -1.....+3mV

DASY measurement parameters: Auto Zero Time: 3 sec; Measuring time: 3 sec

Calibration Factors	X	Y	Z
High Range	404.914 \pm 0.02% (k=2)	404.828 \pm 0.02% (k=2)	405.811 \pm 0.02% (k=2)
Low Range	3.99625 \pm 1.50% (k=2)	3.95391 \pm 1.50% (k=2)	3.99611 \pm 1.50% (k=2)

Connector Angle

Connector Angle to be used in DASY system	45.5 $^{\circ}$ \pm 1 $^{\circ}$
---	------------------------------------

Appendix (Additional assessments outside the scope of SCS0108)

1. DC Voltage Linearity

High Range	Reading (μV)	Difference (μV)	Error (%)
Channel X + Input	199996.45	0.25	0.00
Channel X + Input	20001.70	-0.30	-0.00
Channel X - Input	-19998.70	2.36	-0.01
Channel Y + Input	199995.67	-0.95	-0.00
Channel Y + Input	20001.49	-0.43	-0.00
Channel Y - Input	-20002.28	-1.16	0.01
Channel Z + Input	199993.44	-3.24	-0.00
Channel Z + Input	19998.00	-3.84	-0.02
Channel Z - Input	-20001.60	-0.42	0.00

Low Range	Reading (μV)	Difference (μV)	Error (%)
Channel X + Input	2001.23	-0.07	-0.00
Channel X + Input	201.94	0.22	0.11
Channel X - Input	-197.23	0.90	-0.45
Channel Y + Input	2002.45	1.14	0.06
Channel Y + Input	200.73	-0.94	-0.46
Channel Y - Input	-199.20	-0.99	0.50
Channel Z + Input	2000.56	-0.57	-0.03
Channel Z + Input	201.26	-0.26	-0.13
Channel Z - Input	-199.66	-1.36	0.68

2. Common mode sensitivity

DASY measurement parameters: Auto Zero Time: 3 sec; Measuring time: 3 sec

	Common mode Input Voltage (mV)	High Range Average Reading (μV)	Low Range Average Reading (μV)
Channel X	200	16.66	14.50
	- 200	-15.19	-16.53
Channel Y	200	-15.44	-15.62
	- 200	14.55	14.28
Channel Z	200	-12.89	-13.20
	- 200	11.49	11.23

3. Channel separation

DASY measurement parameters: Auto Zero Time: 3 sec; Measuring time: 3 sec

	Input Voltage (mV)	Channel X (μV)	Channel Y (μV)	Channel Z (μV)
Channel X	200	-	3.82	-3.41
Channel Y	200	8.64	-	5.14
Channel Z	200	9.45	6.60	-

4. AD-Converter Values with inputs shorted

DASY measurement parameters: Auto Zero Time: 3 sec; Measuring time: 3 sec

	High Range (LSB)	Low Range (LSB)
Channel X	15768	16195
Channel Y	16027	16704
Channel Z	16313	16381

5. Input Offset Measurement

DASY measurement parameters: Auto Zero Time: 3 sec; Measuring time: 3 sec

Input 10M Ω

	Average (μ V)	min. Offset (μ V)	max. Offset (μ V)	Std. Deviation (μ V)
Channel X	0.11	-1.54	1.92	0.70
Channel Y	-0.13	-1.45	1.36	0.65
Channel Z	0.44	-1.71	2.34	0.52

6. Input Offset Current

Nominal Input circuitry offset current on all channels: <25fA

7. Input Resistance (Typical values for information)

	Zeroing (kOhm)	Measuring (MOhm)
Channel X	200	200
Channel Y	200	200
Channel Z	200	200

8. Low Battery Alarm Voltage (Typical values for information)

Typical values	Alarm Level (VDC)
Supply (+ Vcc)	+7.9
Supply (- Vcc)	-7.6

9. Power Consumption (Typical values for information)

Typical values	Switched off (mA)	Stand by (mA)	Transmitting (mA)
Supply (+ Vcc)	+0.01	+6	+14
Supply (- Vcc)	-0.01	-8	-9

IMPORTANT NOTICE

USAGE OF THE DAE 4

The DAE unit is a delicate, high precision instrument and requires careful treatment by the user. There are no serviceable parts inside the DAE. Special attention shall be given to the following points:

Battery Exchange: The battery cover of the DAE4 unit is closed using a screw, over tightening the screw may cause the threads inside the DAE to wear out.

Shipping of the DAE: Before shipping the DAE to SPEAG for calibration, remove the batteries and pack the DAE in an antistatic bag. This antistatic bag shall then be packed into a larger box or container which protects the DAE from impacts during transportation. The package shall be marked to indicate that a fragile instrument is inside.

E-Stop Failures: Touch detection may be malfunctioning due to broken magnets in the E-stop. Rough handling of the E-stop may lead to damage of these magnets. Touch and collision errors are often caused by dust and dirt accumulated in the E-stop. To prevent E-stop failure, the customer shall always mount the probe to the DAE carefully and keep the DAE unit in a non-dusty environment if not used for measurements.

Repair: Minor repairs are performed at no extra cost during the annual calibration. However, SPEAG reserves the right to charge for any repair especially if rough unprofessional handling caused the defect.

DASY Configuration Files: Since the exact values of the DAE input resistances, as measured during the calibration procedure of a DAE unit, are not used by the DASY software, a nominal value of 200 MOhm is given in the corresponding configuration file.

Important Note:

Warranty and calibration is void if the DAE unit is disassembled partly or fully by the Customer.

Important Note:

Never attempt to grease or oil the E-stop assembly. Cleaning and readjusting of the E-stop assembly is allowed by certified SPEAG personnel only and is part of the annual calibration procedure.

Important Note:

To prevent damage of the DAE probe connector pins, use great care when installing the probe to the DAE. Carefully connect the probe with the connector notch oriented in the mating position. Avoid any rotational movement of the probe body versus the DAE while turning the locking nut of the connector. The same care shall be used when disconnecting the probe from the DAE.



Accredited by the Swiss Accreditation Service (SAS)
The Swiss Accreditation Service is one of the signatories to the EA
Multilateral Agreement for the recognition of calibration certificates

Accreditation No.: **SCS 0108**

Client **Huawei-SZ (Auden)**

Certificate No: **DAE4-852_Apr18**

CALIBRATION CERTIFICATE

Object **DAE4 - SD 000 D04 BJ - SN: 852**

Calibration procedure(s) **QA CAL-06.v29
Calibration procedure for the data acquisition electronics (DAE)**

Calibration date: **April 23, 2018**

This calibration certificate documents the traceability to national standards, which realize the physical units of measurements (SI).
The measurements and the uncertainties with confidence probability are given on the following pages and are part of the certificate.

All calibrations have been conducted in the closed laboratory facility: environment temperature (22 ± 3)°C and humidity < 70%.

Calibration Equipment used (M&TE critical for calibration)

Primary Standards	ID #	Cal Date (Certificate No.)	Scheduled Calibration
Keithley Multimeter Type 2001	SN: 0810278	31-Aug-17 (No:21092)	Aug-18
Secondary Standards	ID #	Check Date (in house)	Scheduled Check
Auto DAE Calibration Unit	SE UWS 053 AA 1001	04-Jan-18 (in house check)	In house check: Jan-19
Calibrator Box V2.1	SE UMS 006 AA 1002	04-Jan-18 (in house check)	In house check: Jan-19

Calibrated by:	Name	Function	Signature
	Eric Hainfeld	Laboratory Technician	
Approved by:	Name	Function	Signature
	Sven Kühn	Deputy Manager	

Issued: April 23, 2018

This calibration certificate shall not be reproduced except in full without written approval of the laboratory.



Accredited by the Swiss Accreditation Service (SAS)

The Swiss Accreditation Service is one of the signatories to the EA
Multilateral Agreement for the recognition of calibration certificates

Accreditation No.: **SCS 0108**

Glossary

DAE	data acquisition electronics
Connector angle	information used in DASY system to align probe sensor X to the robot coordinate system.

Methods Applied and Interpretation of Parameters

- *DC Voltage Measurement:* Calibration Factor assessed for use in DASY system by comparison with a calibrated instrument traceable to national standards. The figure given corresponds to the full scale range of the voltmeter in the respective range.
- *Connector angle:* The angle of the connector is assessed measuring the angle mechanically by a tool inserted. Uncertainty is not required.
- The following parameters as documented in the Appendix contain technical information as a result from the performance test and require no uncertainty.
 - *DC Voltage Measurement Linearity:* Verification of the Linearity at +10% and -10% of the nominal calibration voltage. Influence of offset voltage is included in this measurement.
 - *Common mode sensitivity:* Influence of a positive or negative common mode voltage on the differential measurement.
 - *Channel separation:* Influence of a voltage on the neighbor channels not subject to an input voltage.
 - *AD Converter Values with inputs shorted:* Values on the internal AD converter corresponding to zero input voltage
 - *Input Offset Measurement:* Output voltage and statistical results over a large number of zero voltage measurements.
 - *Input Offset Current:* Typical value for information; Maximum channel input offset current, not considering the input resistance.
 - *Input resistance:* Typical value for information: DAE input resistance at the connector, during internal auto-zeroing and during measurement.
 - *Low Battery Alarm Voltage:* Typical value for information. Below this voltage, a battery alarm signal is generated.
 - *Power consumption:* Typical value for information. Supply currents in various operating modes.

DC Voltage Measurement

A/D - Converter Resolution nominal

High Range: 1LSB = 6.1 μ V, full range = -100...+300 mV

Low Range: 1LSB = 61nV, full range = -1.....+3mV

DASY measurement parameters: Auto Zero Time: 3 sec; Measuring time: 3 sec

Calibration Factors	X	Y	Z
High Range	404.856 \pm 0.02% (k=2)	404.205 \pm 0.02% (k=2)	404.418 \pm 0.02% (k=2)
Low Range	3.98700 \pm 1.50% (k=2)	3.96218 \pm 1.50% (k=2)	3.95808 \pm 1.50% (k=2)

Connector Angle

Connector Angle to be used in DASY system	179.5 \pm 1 $^{\circ}$
---	--------------------------

Appendix (Additional assessments outside the scope of SCS0108)

1. DC Voltage Linearity

High Range		Reading (μV)	Difference (μV)	Error (%)
Channel X	+ Input	199991.58	-1.48	-0.00
Channel X	+ Input	20003.49	2.02	0.01
Channel X	- Input	-19998.39	2.56	-0.01
Channel Y	+ Input	199993.37	-0.01	-0.00
Channel Y	+ Input	20001.56	0.10	0.00
Channel Y	- Input	-20001.78	-0.85	0.00
Channel Z	+ Input	199991.17	-1.93	-0.00
Channel Z	+ Input	19999.04	-2.18	-0.01
Channel Z	- Input	-20003.62	-2.44	0.01

Low Range		Reading (μV)	Difference (μV)	Error (%)
Channel X	+ Input	2000.93	-0.06	-0.00
Channel X	+ Input	201.66	0.31	0.15
Channel X	- Input	-197.30	1.13	-0.57
Channel Y	+ Input	2000.78	-0.21	-0.01
Channel Y	+ Input	200.86	-0.62	-0.31
Channel Y	- Input	-198.26	0.10	-0.05
Channel Z	+ Input	2001.64	0.74	0.04
Channel Z	+ Input	200.34	-0.96	-0.48
Channel Z	- Input	-199.44	-0.95	0.48

2. Common mode sensitivity

DASY measurement parameters: Auto Zero Time: 3 sec; Measuring time: 3 sec

	Common mode Input Voltage (mV)	High Range Average Reading (μV)	Low Range Average Reading (μV)
Channel X	200	6.24	4.19
	- 200	-3.39	-5.24
Channel Y	200	-1.24	-1.33
	- 200	1.17	0.73
Channel Z	200	-2.15	-2.12
	- 200	0.03	-0.02

3. Channel separation

DASY measurement parameters: Auto Zero Time: 3 sec; Measuring time: 3 sec

	Input Voltage (mV)	Channel X (μV)	Channel Y (μV)	Channel Z (μV)
Channel X	200	-	0.54	-1.79
Channel Y	200	6.89	-	1.32
Channel Z	200	9.83	3.81	-

4. AD-Converter Values with inputs shorted

DASY measurement parameters: Auto Zero Time: 3 sec; Measuring time: 3 sec

	High Range (LSB)	Low Range (LSB)
Channel X	16484	17116
Channel Y	15703	14955
Channel Z	16768	14462

5. Input Offset Measurement

DASY measurement parameters: Auto Zero Time: 3 sec; Measuring time: 3 sec

Input 10M Ω

	Average (μ V)	min. Offset (μ V)	max. Offset (μ V)	Std. Deviation (μ V)
Channel X	0.10	-1.61	1.66	0.55
Channel Y	-0.22	-2.36	0.85	0.45
Channel Z	-0.72	-2.20	1.36	0.58

6. Input Offset Current

Nominal Input circuitry offset current on all channels: <25fA

7. Input Resistance (Typical values for information)

	Zeroing (kOhm)	Measuring (MOhm)
Channel X	200	200
Channel Y	200	200
Channel Z	200	200

8. Low Battery Alarm Voltage (Typical values for information)

Typical values	Alarm Level (VDC)
Supply (+ Vcc)	+7.9
Supply (- Vcc)	-7.6

9. Power Consumption (Typical values for information)

Typical values	Switched off (mA)	Stand by (mA)	Transmitting (mA)
Supply (+ Vcc)	+0.01	+6	+14
Supply (- Vcc)	-0.01	-8	-9



In Collaboration with
s p e a g
CALIBRATION LABORATORY



中国认可
国际互认
校准
CALIBRATION
CNAS L0570

Add: No.51 Xueyuan Road, Haidian District, Beijing, 100191, China
Tel: +86-10-62304633-2512 Fax: +86-10-62304633-2504
E-mail: cttl@chinattl.com [Http://www.chinattl.cn](http://www.chinattl.cn)

Client : **Auden**

Certificate No: **Z18-60290**

CALIBRATION CERTIFICATE

Object: **DAE3 - SN: 393**

Calibration Procedure(s): **FF-Z11-002-01**
Calibration Procedure for the Data Acquisition Electronics (DAEx)

Calibration date: **August 14, 2018**

This calibration Certificate documents the traceability to national standards, which realize the physical units of measurements(SI). The measurements and the uncertainties with confidence probability are given on the following pages and are part of the certificate.

All calibrations have been conducted in the closed laboratory facility: environment temperature(22±3)°C and humidity<70%.

Calibration Equipment used (M&TE critical for calibration)

Primary Standards	ID #	Cal Date(Calibrated by, Certificate No.)	Scheduled Calibration
Process Calibrator 753	1971018	20-Jun-18 (CTTL, No.J18X05034)	June-19

	Name	Function	Signature
Calibrated by:	Yu Zongying	SAR Test Engineer	
Reviewed by:	Lin Hao	SAR Test Engineer	
Approved by:	Qi Dianyuan	SAR Project Leader	

Issued: August 15, 2018

This calibration certificate shall not be reproduced except in full without written approval of the laboratory.



In Collaboration with

s p e a g
CALIBRATION LABORATORY

Add: No.51 Xueyuan Road, Haidian District, Beijing, 100191, China

Tel: +86-10-62304633-2512

Fax: +86-10-62304633-2504

E-mail: cttl@chinattl.com

Http://www.chinattl.cn

Glossary:

DAE data acquisition electronics
Connector angle information used in DASY system to align probe sensor X
to the robot coordinate system.

Methods Applied and Interpretation of Parameters:

- *DC Voltage Measurement:* Calibration Factor assessed for use in DASY system by comparison with a calibrated instrument traceable to national standards. The figure given corresponds to the full scale range of the voltmeter in the respective range.
- *Connector angle:* The angle of the connector is assessed measuring the angle mechanically by a tool inserted. Uncertainty is not required.
- The report provide only calibration results for DAE, it does not contain other performance test results.



Add: No.51 Xueyuan Road, Haidian District, Beijing, 100191, China
 Tel: +86-10-62304633-2512 Fax: +86-10-62304633-2504
 E-mail: cttl@chinattl.com Http://www.chinattl.cn

DC Voltage Measurement

A/D - Converter Resolution nominal

High Range: 1LSB = 6.1 μ V, full range = -100...+300 mV
 Low Range: 1LSB = 61nV, full range = -1.....+3mV

DASY measurement parameters: Auto Zero Time: 3 sec; Measuring time: 3 sec

Calibration Factors	X	Y	Z
High Range	403.890 \pm 0.15% (k=2)	404.114 \pm 0.15% (k=2)	403.987 \pm 0.15% (k=2)
Low Range	3.96967 \pm 0.7% (k=2)	3.96032 \pm 0.7% (k=2)	3.95474 \pm 0.7% (k=2)

Connector Angle

Connector Angle to be used in DASY system	104.5 $^{\circ}$ \pm 1 $^{\circ}$
---	-------------------------------------



Accredited by the Swiss Accreditation Service (SAS)
The Swiss Accreditation Service is one of the signatories to the EA
Multilateral Agreement for the recognition of calibration certificates

Accreditation No.: **SCS 0108**

Client **Huawei-SZ (Auden)**

Certificate No: **D750V3-1044_Sep18**

CALIBRATION CERTIFICATE

Object **D750V3 - SN:1044**

Calibration procedure(s) **QA CAL-05.v10
Calibration procedure for dipole validation kits above 700 MHz**

Calibration date: **September 18, 2018**

This calibration certificate documents the traceability to national standards, which realize the physical units of measurements (SI).
The measurements and the uncertainties with confidence probability are given on the following pages and are part of the certificate.

All calibrations have been conducted in the closed laboratory facility: environment temperature $(22 \pm 3)^\circ\text{C}$ and humidity $< 70\%$.

Calibration Equipment used (M&TE critical for calibration)

Primary Standards	ID #	Cal Date (Certificate No.)	Scheduled Calibration
Power meter NRP	SN: 104778	04-Apr-18 (No. 217-02672/02673)	Apr-19
Power sensor NRP-Z91	SN: 103244	04-Apr-18 (No. 217-02672)	Apr-19
Power sensor NRP-Z91	SN: 103245	04-Apr-18 (No. 217-02673)	Apr-19
Reference 20 dB Attenuator	SN: 5058 (20k)	04-Apr-18 (No. 217-02682)	Apr-19
Type-N mismatch combination	SN: 5047.2 / 06327	04-Apr-18 (No. 217-02683)	Apr-19
Reference Probe EX3DV4	SN: 7349	30-Dec-17 (No. EX3-7349_Dec17)	Dec-18
DAE4	SN: 601	26-Oct-17 (No. DAE4-601_Oct17)	Oct-18

Secondary Standards	ID #	Check Date (in house)	Scheduled Check
Power meter EPM-442A	SN: GB37480704	07-Oct-15 (in house check Oct-16)	In house check: Oct-18
Power sensor HP 8481A	SN: US37292783	07-Oct-15 (in house check Oct-16)	In house check: Oct-18
Power sensor HP 8481A	SN: MY41092317	07-Oct-15 (in house check Oct-16)	In house check: Oct-18
RF generator R&S SMT-06	SN: 100972	15-Jun-15 (in house check Oct-16)	In house check: Oct-18
Network Analyzer Agilent E8358A	SN: US41080477	31-Mar-14 (in house check Oct-17)	In house check: Oct-18

Calibrated by: **Jeton Kastrati** Name Function
Laboratory Technician

Approved by: **Katja Pokovic** Name Function
Technical Manager

Signature

Issued: September 20, 2018

This calibration certificate shall not be reproduced except in full without written approval of the laboratory.



Accredited by the Swiss Accreditation Service (SAS)

The Swiss Accreditation Service is one of the signatories to the EA
Multilateral Agreement for the recognition of calibration certificates

Accreditation No.: **SCS 0108**

Glossary:

TSL	tissue simulating liquid
ConvF	sensitivity in TSL / NORM x,y,z
N/A	not applicable or not measured

Calibration is Performed According to the Following Standards:

- IEEE Std 1528-2013, "IEEE Recommended Practice for Determining the Peak Spatial-Averaged Specific Absorption Rate (SAR) in the Human Head from Wireless Communications Devices: Measurement Techniques", June 2013
- IEC 62209-1, "Measurement procedure for the assessment of Specific Absorption Rate (SAR) from hand-held and body-mounted devices used next to the ear (frequency range of 300 MHz to 6 GHz)", July 2016
- IEC 62209-2, "Procedure to determine the Specific Absorption Rate (SAR) for wireless communication devices used in close proximity to the human body (frequency range of 30 MHz to 6 GHz)", March 2010
- KDB 865664, "SAR Measurement Requirements for 100 MHz to 6 GHz"

Additional Documentation:

- DASY4/5 System Handbook

Methods Applied and Interpretation of Parameters:

- Measurement Conditions:* Further details are available from the Validation Report at the end of the certificate. All figures stated in the certificate are valid at the frequency indicated.
- Antenna Parameters with TSL:* The dipole is mounted with the spacer to position its feed point exactly below the center marking of the flat phantom section, with the arms oriented parallel to the body axis.
- Feed Point Impedance and Return Loss:* These parameters are measured with the dipole positioned under the liquid filled phantom. The impedance stated is transformed from the measurement at the SMA connector to the feed point. The Return Loss ensures low reflected power. No uncertainty required.
- Electrical Delay:* One-way delay between the SMA connector and the antenna feed point. No uncertainty required.
- SAR measured:* SAR measured at the stated antenna input power.
- SAR normalized:* SAR as measured, normalized to an input power of 1 W at the antenna connector.
- SAR for nominal TSL parameters:* The measured TSL parameters are used to calculate the nominal SAR result.

The reported uncertainty of measurement is stated as the standard uncertainty of measurement multiplied by the coverage factor $k=2$, which for a normal distribution corresponds to a coverage probability of approximately 95%.

Measurement Conditions

DASY system configuration, as far as not given on page 1.

DASY Version	DASY5	V52.10.1
Extrapolation	Advanced Extrapolation	
Phantom	Modular Flat Phantom	
Distance Dipole Center - TSL	15 mm	with Spacer
Zoom Scan Resolution	dx, dy, dz = 5 mm	
Frequency	750 MHz ± 1 MHz	

Head TSL parameters

The following parameters and calculations were applied.

	Temperature	Permittivity	Conductivity
Nominal Head TSL parameters	22.0 °C	41.9	0.89 mho/m
Measured Head TSL parameters	(22.0 ± 0.2) °C	40.9 ± 6 %	0.89 mho/m ± 6 %
Head TSL temperature change during test	< 0.5 °C	----	----

SAR result with Head TSL

SAR averaged over 1 cm ³ (1 g) of Head TSL	Condition	
SAR measured	250 mW input power	2.07 W/kg
SAR for nominal Head TSL parameters	normalized to 1W	8.24 W/kg ± 17.0 % (k=2)

SAR averaged over 10 cm ³ (10 g) of Head TSL	condition	
SAR measured	250 mW input power	1.34 W/kg
SAR for nominal Head TSL parameters	normalized to 1W	5.34 W/kg ± 16.5 % (k=2)

Body TSL parameters

The following parameters and calculations were applied.

	Temperature	Permittivity	Conductivity
Nominal Body TSL parameters	22.0 °C	55.5	0.96 mho/m
Measured Body TSL parameters	(22.0 ± 0.2) °C	55.6 ± 6 %	0.97 mho/m ± 6 %
Body TSL temperature change during test	< 0.5 °C	----	----

SAR result with Body TSL

SAR averaged over 1 cm ³ (1 g) of Body TSL	Condition	
SAR measured	250 mW input power	2.15 W/kg
SAR for nominal Body TSL parameters	normalized to 1W	8.54 W/kg ± 17.0 % (k=2)

SAR averaged over 10 cm ³ (10 g) of Body TSL	condition	
SAR measured	250 mW input power	1.41 W/kg
SAR for nominal Body TSL parameters	normalized to 1W	5.61 W/kg ± 16.5 % (k=2)

Appendix (Additional assessments outside the scope of SCS 0108)

Antenna Parameters with Head TSL

Impedance, transformed to feed point	54.7 Ω + 0.1 j Ω
Return Loss	- 27.0 dB

Antenna Parameters with Body TSL

Impedance, transformed to feed point	49.8 Ω - 3.8 j Ω
Return Loss	- 28.5 dB

General Antenna Parameters and Design

Electrical Delay (one direction)	1.038 ns
----------------------------------	----------

After long term use with 100W radiated power, only a slight warming of the dipole near the feedpoint can be measured.

The dipole is made of standard semirigid coaxial cable. The center conductor of the feeding line is directly connected to the second arm of the dipole. The antenna is therefore short-circuited for DC-signals. On some of the dipoles, small end caps are added to the dipole arms in order to improve matching when loaded according to the position as explained in the "Measurement Conditions" paragraph. The SAR data are not affected by this change. The overall dipole length is still according to the Standard.

No excessive force must be applied to the dipole arms, because they might bend or the soldered connections near the feedpoint may be damaged.

Additional EUT Data

Manufactured by	SPEAG
Manufactured on	September 02, 2011

DASY5 Validation Report for Head TSL

Date: 18.09.2018

Test Laboratory: SPEAG, Zurich, Switzerland

DUT: Dipole 750 MHz; Type: D750V3; Serial: D750V3 - SN:1044

Communication System: UID 0 - CW; Frequency: 750 MHz

Medium parameters used: $f = 750$ MHz; $\sigma = 0.89$ S/m; $\epsilon_r = 40.9$; $\rho = 1000$ kg/m³

Phantom section: Flat Section

Measurement Standard: DASY5 (IEEE/IEC/ANSI C63.19-2011)

DASY52 Configuration:

- Probe: EX3DV4 - SN7349; ConvF(10.22, 10.22, 10.22) @ 750 MHz; Calibrated: 30.12.2017
- Sensor-Surface: 1.4mm (Mechanical Surface Detection)
- Electronics: DAE4 Sn601; Calibrated: 26.10.2017
- Phantom: Flat Phantom 4.9 (front); Type: QD 00L P49 AA; Serial: 1001
- DASY52 52.10.1(1476); SEMCAD X 14.6.11(7439)

Dipole Calibration for Head Tissue/Pin=250 mW, d=15mm/Zoom Scan (7x7x7)/Cube 0:

Measurement grid: dx=5mm, dy=5mm, dz=5mm

Reference Value = 59.50 V/m; Power Drift = -0.03 dB

Peak SAR (extrapolated) = 3.16 W/kg

SAR(1 g) = 2.07 W/kg; SAR(10 g) = 1.34 W/kg

Maximum value of SAR (measured) = 2.79 W/kg

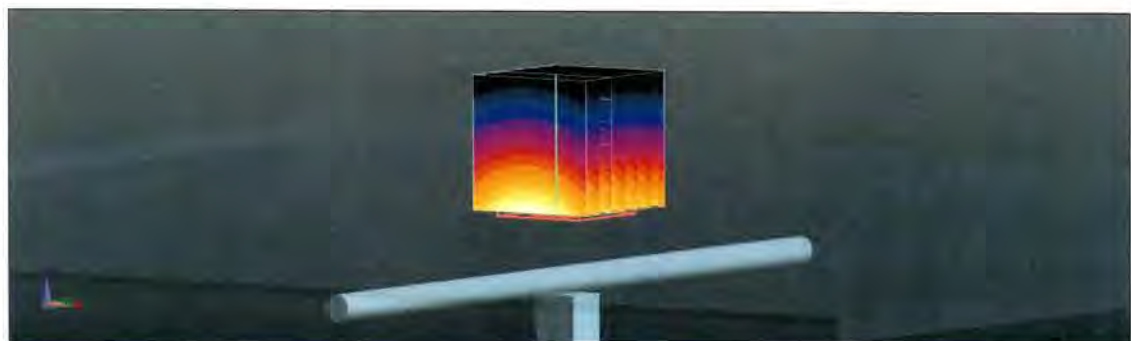
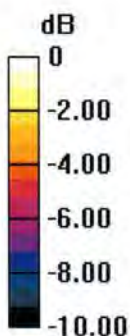

0 dB = 2.79 W/kg = 4.46 dBW/kg

Impedance Measurement Plot for Head TSL

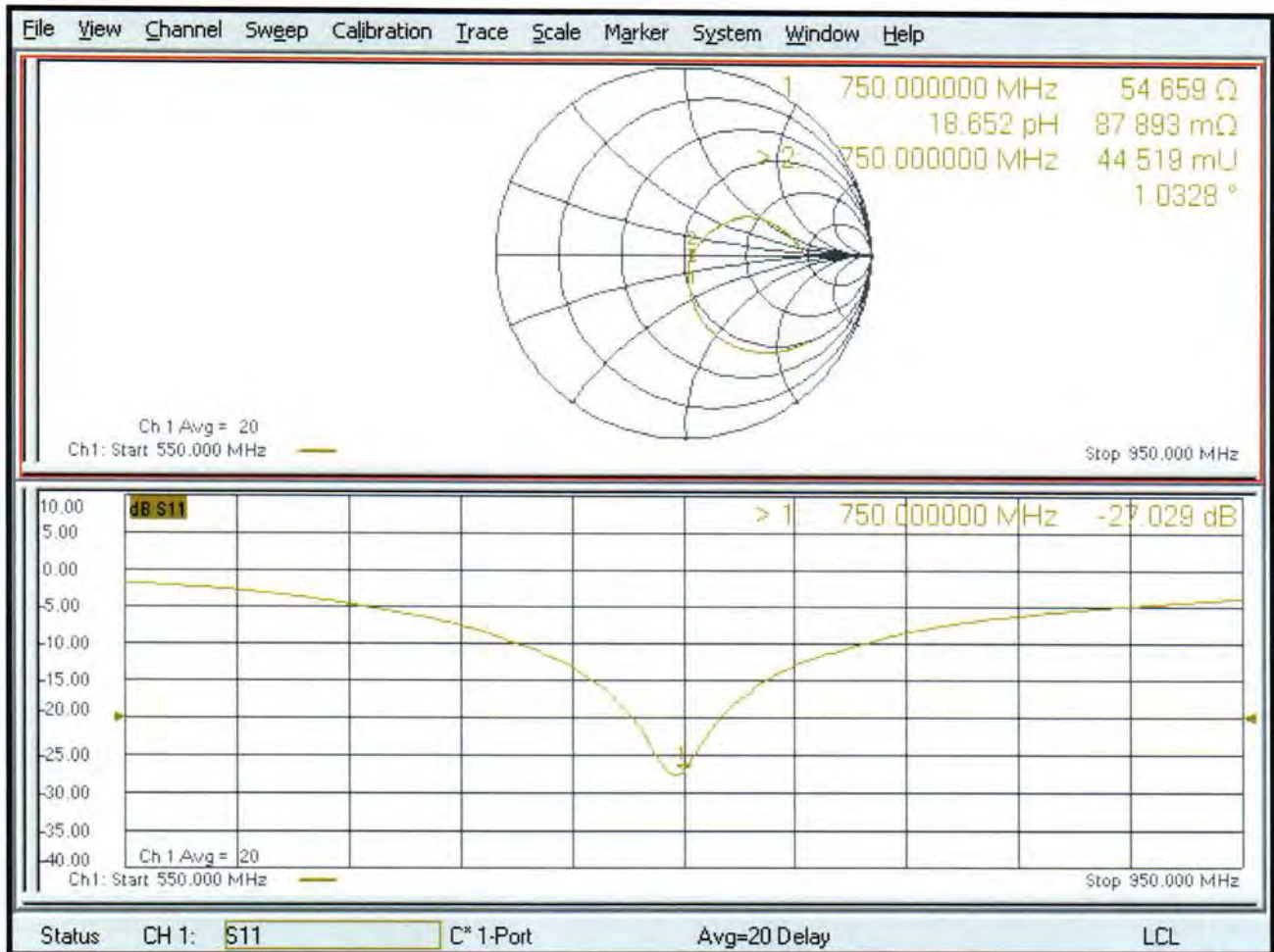

DASY5 Validation Report for Body TSL

Date: 18.09.2018

Test Laboratory: SPEAG, Zurich, Switzerland

DUT: Dipole 750 MHz; Type: D750V3; Serial: D750V3 - SN:1044

Communication System: UID 0 - CW; Frequency: 750 MHz

Medium parameters used: $f = 750$ MHz; $\sigma = 0.97$ S/m; $\epsilon_r = 55.6$; $\rho = 1000$ kg/m³

Phantom section: Flat Section

Measurement Standard: DASY5 (IEEE/IEC/ANSI C63.19-2011)

DASY52 Configuration:

- Probe: EX3DV4 - SN7349; ConvF(10.19, 10.19, 10.19) @ 750 MHz; Calibrated: 30.12.2017
- Sensor-Surface: 1.4mm (Mechanical Surface Detection)
- Electronics: DAE4 Sn601; Calibrated: 26.10.2017
- Phantom: Flat Phantom 4.9 (Back); Type: QD 00R P49 AA; Serial: 1005
- DASY52 52.10.1(1476); SEMCAD X 14.6.11(7439)

Dipole Calibration for Body Tissue/Pin=250 mW, d=15mm/Zoom Scan (7x7x7)/Cube 0:

Measurement grid: dx=5mm, dy=5mm, dz=5mm

Reference Value = 57.85 V/m; Power Drift = -0.03 dB

Peak SAR (extrapolated) = 3.23 W/kg

SAR(1 g) = 2.15 W/kg; SAR(10 g) = 1.41 W/kg

Maximum value of SAR (measured) = 2.88 W/kg

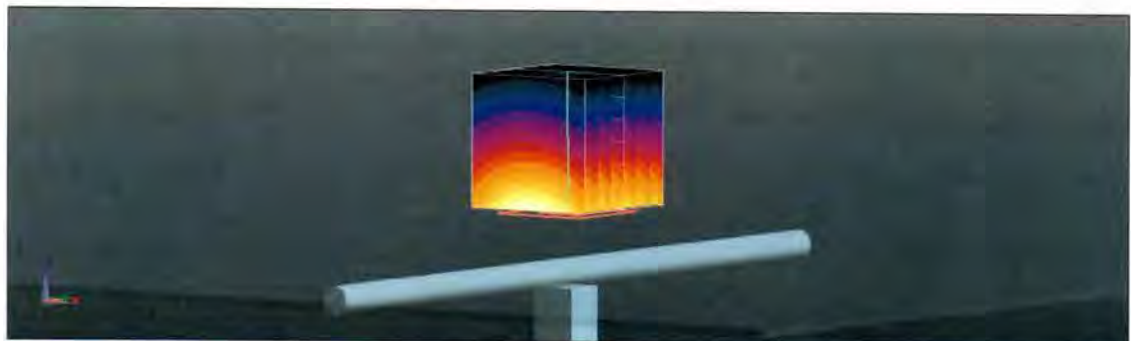
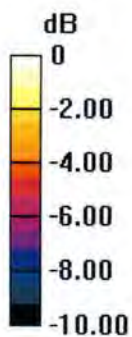

0 dB = 2.88 W/kg = 4.59 dBW/kg

Impedance Measurement Plot for Body TSL

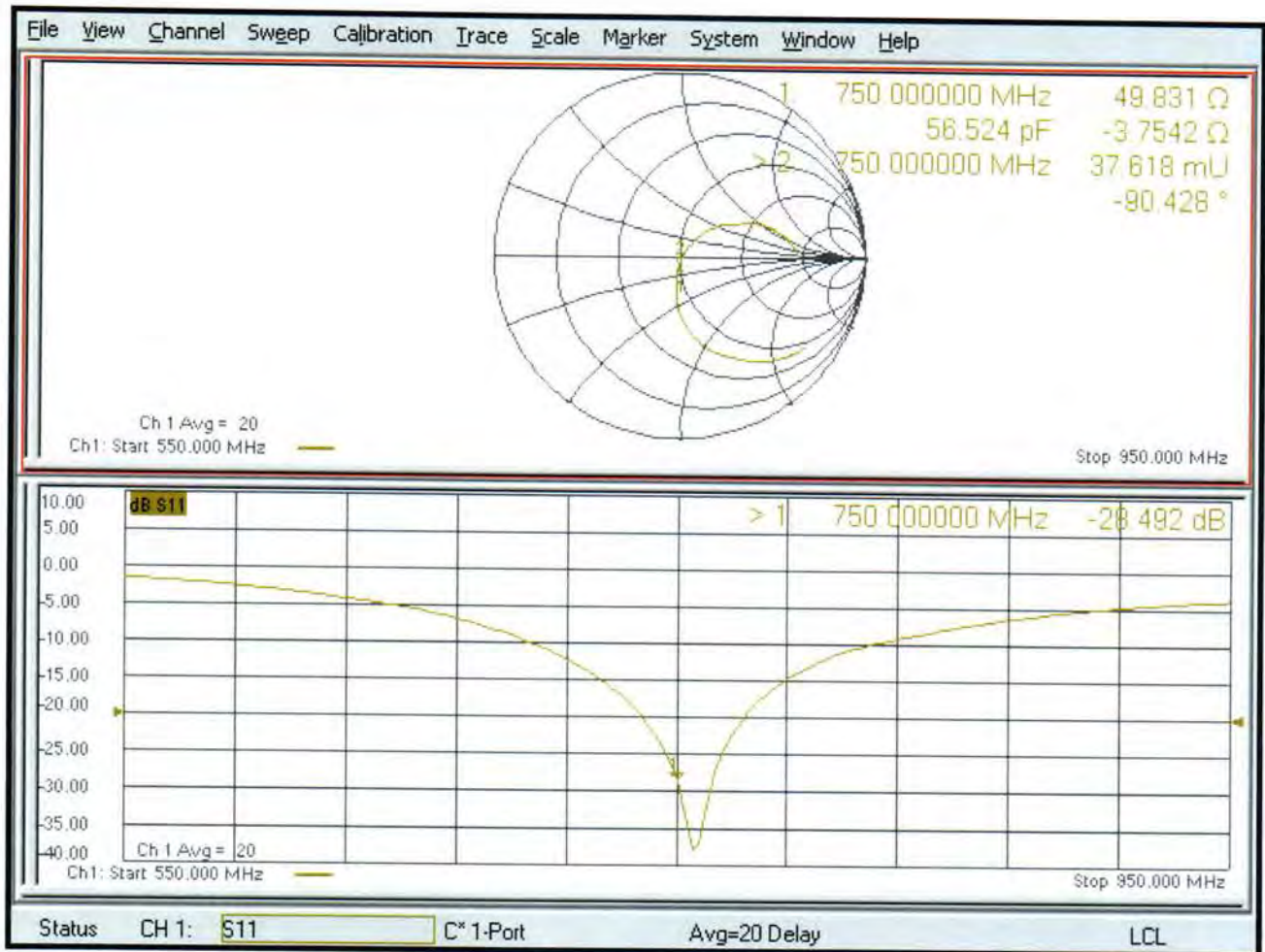



Accredited by the Swiss Accreditation Service (SAS)
The Swiss Accreditation Service is one of the signatories to the EA
Multilateral Agreement for the recognition of calibration certificates

Accreditation No.: **SCS 0108**

Client **Huawei-SZ (Auden)**

Certificate No: **D835V2-4d059_Apr16**

CALIBRATION CERTIFICATE

Object **D835V2 - SN:4d059**

Calibration procedure(s) **QA CAL-05.v9
Calibration procedure for dipole validation kits above 700 MHz**

Calibration date: **April 20, 2016**

This calibration certificate documents the traceability to national standards, which realize the physical units of measurements (SI).
The measurements and the uncertainties with confidence probability are given on the following pages and are part of the certificate.

All calibrations have been conducted in the closed laboratory facility: environment temperature (22 ± 3)°C and humidity < 70%.

Calibration Equipment used (M&TE critical for calibration)

Primary Standards	ID #	Cal Date (Certificate No.)	Scheduled Calibration
Power meter NRP	SN: 104778	06-Apr-16 (No. 217-02288/02289)	Apr-17
Power sensor NRP-Z91	SN: 103244	06-Apr-16 (No. 217-02288)	Apr-17
Power sensor NRP-Z91	SN: 103245	06-Apr-16 (No. 217-02289)	Apr-17
Reference 20 dB Attenuator	SN: 5058 (20k)	05-Apr-16 (No. 217-02292)	Apr-17
Type-N mismatch combination	SN: 5047.2 / 06327	05-Apr-16 (No. 217-02295)	Apr-17
Reference Probe EX3DV4	SN: 7349	31-Dec-15 (No. EX3-7349_Dec15)	Dec-16
DAE4	SN: 601	30-Dec-15 (No. DAE4-601_Dec15)	Dec-16

Secondary Standards	ID #	Check Date (in house)	Scheduled Check
Power meter EPM-442A	SN: GB37480704	07-Oct-15 (No. 217-02222)	In house check: Oct-16
Power sensor HP 8481A	SN: US37292783	07-Oct-15 (No. 217-02222)	In house check: Oct-16
Power sensor HP 8481A	SN: MY41092317	07-Oct-15 (No. 217-02223)	In house check: Oct-16
RF generator R&S SMT-06	SN: 100972	15-Jun-15 (in house check Jun-15)	In house check: Oct-16
Network Analyzer HP 8753E	SN: US37390585	18-Oct-01 (in house check Oct-15)	In house check: Oct-16

Calibrated by: **Jeton Kastrioti** Function: **Laboratory Technician** Signature:

Approved by: **Katja Pokovic** Technical Manager

Issued: April 20, 2016

This calibration certificate shall not be reproduced except in full without written approval of the laboratory.



Accredited by the Swiss Accreditation Service (SAS)

The Swiss Accreditation Service is one of the signatories to the EA
Multilateral Agreement for the recognition of calibration certificates

Accreditation No.: **SCS 0108**

Glossary:

TSL	tissue simulating liquid
ConvF	sensitivity in TSL / NORM x,y,z
N/A	not applicable or not measured

Calibration is Performed According to the Following Standards:

- IEEE Std 1528-2013, "IEEE Recommended Practice for Determining the Peak Spatial-Averaged Specific Absorption Rate (SAR) in the Human Head from Wireless Communications Devices: Measurement Techniques", June 2013
- IEC 62209-1, "Procedure to measure the Specific Absorption Rate (SAR) for hand-held devices used in close proximity to the ear (frequency range of 300 MHz to 3 GHz)", February 2005
- IEC 62209-2, "Procedure to determine the Specific Absorption Rate (SAR) for wireless communication devices used in close proximity to the human body (frequency range of 30 MHz to 6 GHz)", March 2010
- KDB 865664, "SAR Measurement Requirements for 100 MHz to 6 GHz"

Additional Documentation:

- DASY4/5 System Handbook

Methods Applied and Interpretation of Parameters:

- Measurement Conditions:** Further details are available from the Validation Report at the end of the certificate. All figures stated in the certificate are valid at the frequency indicated.
- Antenna Parameters with TSL:** The dipole is mounted with the spacer to position its feed point exactly below the center marking of the flat phantom section, with the arms oriented parallel to the body axis.
- Feed Point Impedance and Return Loss:** These parameters are measured with the dipole positioned under the liquid filled phantom. The impedance stated is transformed from the measurement at the SMA connector to the feed point. The Return Loss ensures low reflected power. No uncertainty required.
- Electrical Delay:** One-way delay between the SMA connector and the antenna feed point. No uncertainty required.
- SAR measured:** SAR measured at the stated antenna input power.
- SAR normalized:** SAR as measured, normalized to an input power of 1 W at the antenna connector.
- SAR for nominal TSL parameters:** The measured TSL parameters are used to calculate the nominal SAR result.

The reported uncertainty of measurement is stated as the standard uncertainty of measurement multiplied by the coverage factor $k=2$, which for a normal distribution corresponds to a coverage probability of approximately 95%.

Measurement Conditions

DASY system configuration, as far as not given on page 1.

DASY Version	DASY5	V52.8.8
Extrapolation	Advanced Extrapolation	
Phantom	Modular Flat Phantom	
Distance Dipole Center - TSL	15 mm	with Spacer
Zoom Scan Resolution	dx, dy, dz = 5 mm	
Frequency	835 MHz \pm 1 MHz	

Head TSL parameters

The following parameters and calculations were applied.

	Temperature	Permittivity	Conductivity
Nominal Head TSL parameters	22.0 °C	41.5	0.90 mho/m
Measured Head TSL parameters	(22.0 \pm 0.2) °C	41.7 \pm 6 %	0.93 mho/m \pm 6 %
Head TSL temperature change during test	< 0.5 °C	---	---

SAR result with Head TSL

SAR averaged over 1 cm ³ (1 g) of Head TSL	Condition	
SAR measured	250 mW input power	2.38 W/kg
SAR for nominal Head TSL parameters	normalized to 1W	9.30 W/kg \pm 17.0 % (k=2)

SAR averaged over 10 cm ³ (10 g) of Head TSL	condition	
SAR measured	250 mW input power	1.54 W/kg
SAR for nominal Head TSL parameters	normalized to 1W	6.05 W/kg \pm 16.5 % (k=2)

Body TSL parameters

The following parameters and calculations were applied.

	Temperature	Permittivity	Conductivity
Nominal Body TSL parameters	22.0 °C	55.2	0.97 mho/m
Measured Body TSL parameters	(22.0 \pm 0.2) °C	54.4 \pm 6 %	1.02 mho/m \pm 6 %
Body TSL temperature change during test	< 0.5 °C	---	---

SAR result with Body TSL

SAR averaged over 1 cm ³ (1 g) of Body TSL	Condition	
SAR measured	250 mW input power	2.45 W/kg
SAR for nominal Body TSL parameters	normalized to 1W	9.41 W/kg \pm 17.0 % (k=2)

SAR averaged over 10 cm ³ (10 g) of Body TSL	condition	
SAR measured	250 mW input power	1.60 W/kg
SAR for nominal Body TSL parameters	normalized to 1W	6.20 W/kg \pm 16.5 % (k=2)

Appendix (Additional assessments outside the scope of SCS 0108)

Antenna Parameters with Head TSL

Impedance, transformed to feed point	52.0 Ω - 1.8 $j\Omega$
Return Loss	- 31.4 dB

Antenna Parameters with Body TSL

Impedance, transformed to feed point	48.7 Ω - 4.2 $j\Omega$
Return Loss	- 27.1 dB

General Antenna Parameters and Design

Electrical Delay (one direction)	1.389 ns
----------------------------------	----------

After long term use with 100W radiated power, only a slight warming of the dipole near the feedpoint can be measured.

The dipole is made of standard semirigid coaxial cable. The center conductor of the feeding line is directly connected to the second arm of the dipole. The antenna is therefore short-circuited for DC-signals. On some of the dipoles, small end caps are added to the dipole arms in order to improve matching when loaded according to the position as explained in the "Measurement Conditions" paragraph. The SAR data are not affected by this change. The overall dipole length is still according to the Standard.

No excessive force must be applied to the dipole arms, because they might bend or the soldered connections near the feedpoint may be damaged.

Additional EUT Data

Manufactured by	SPEAG
Manufactured on	November 27, 2006

DASY5 Validation Report for Head TSL

Date: 20.04.2016

Test Laboratory: SPEAG, Zurich, Switzerland

DUT: Dipole 835 MHz; Type: D835V2; Serial: D835V2 - SN:4d059

Communication System: UID 0 - CW; Frequency: 835 MHz

Medium parameters used: $f = 835$ MHz; $\sigma = 0.93$ S/m; $\epsilon_r = 41.7$; $\rho = 1000$ kg/m³

Phantom section: Flat Section

Measurement Standard: DASY5 (IEEE/IEC/ANSI C63.19-2011)

DASY52 Configuration:

- Probe: EX3DV4 - SN7349; ConvF(9.83, 9.83, 9.83); Calibrated: 31.12.2015;
- Sensor-Surface: 1.4mm (Mechanical Surface Detection)
- Electronics: DAE4 Sn601; Calibrated: 30.12.2015
- Phantom: Flat Phantom 4.9L; Type: QD000P49AA; Serial: 1001
- DASY52 52.8.8(1258); SEMCAD X 14.6.10(7372)

Dipole Calibration for Head Tissue/Pin=250 mW, d=15mm/Zoom Scan (7x7x7)/Cube 0:

Measurement grid: dx=5mm, dy=5mm, dz=5mm

Reference Value = 61.59 V/m; Power Drift = 0.02 dB

Peak SAR (extrapolated) = 3.59 W/kg

SAR(1 g) = 2.38 W/kg; SAR(10 g) = 1.54 W/kg

Maximum value of SAR (measured) = 3.18 W/kg

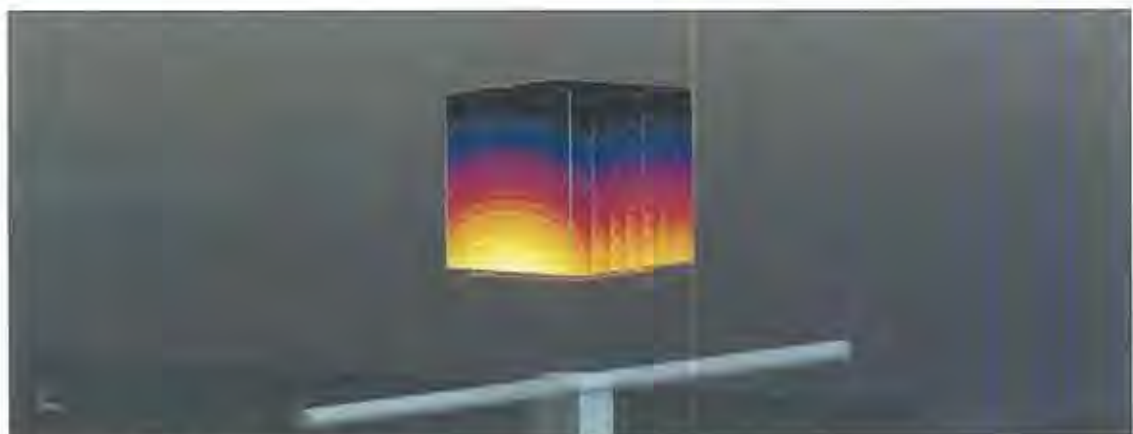
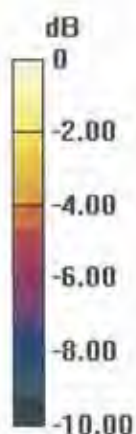

0 dB = 3.18 W/kg = 5.02 dBW/kg

Impedance Measurement Plot for Head TSL

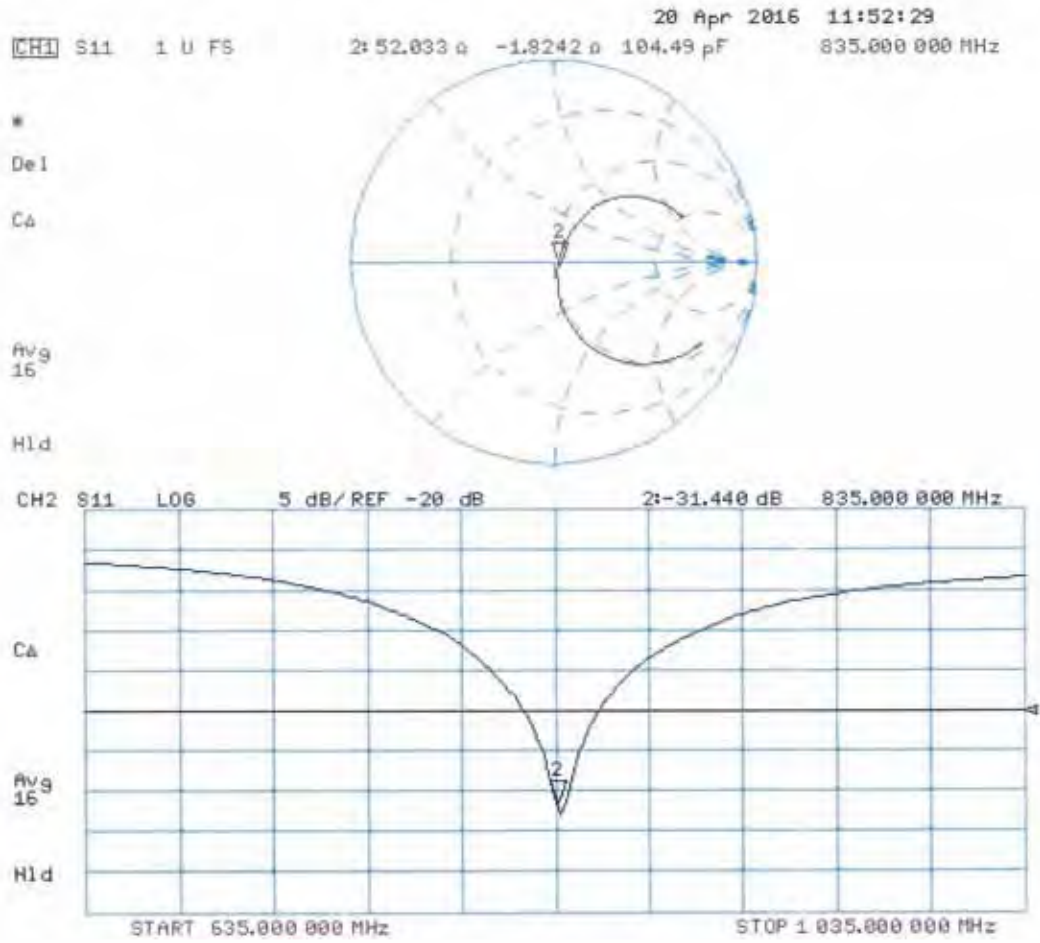

DASY5 Validation Report for Body TSL

Date: 20.04.2016

Test Laboratory: SPEAG, Zurich, Switzerland

DUT: Dipole 835 MHz; Type: D835V2; Serial: D835V2 - SN:4d059

Communication System: UID 0 - CW; Frequency: 835 MHz

Medium parameters used: $f = 835$ MHz; $\sigma = 1.02$ S/m; $\epsilon_r = 54.4$; $\rho = 1000$ kg/m³

Phantom section: Flat Section

Measurement Standard: DASY5 (IEEE/IEC/ANSI C63.19-2011)

DASY52 Configuration:

- Probe: EX3DV4 - SN7349; ConvF(9.73, 9.73, 9.73); Calibrated: 31.12.2015;
- Sensor-Surface: 1.4mm (Mechanical Surface Detection)
- Electronics: DAE4 Sn601; Calibrated: 30.12.2015
- Phantom: Flat Phantom 4.9L; Type: QD000P49AA; Serial: 1001
- DASY52 52.8.8(1258); SEMCAD X 14.6.10(7372)

Dipole Calibration for Body Tissue/Pin=250 mW, d=15mm/Zoom Scan (7x7x7)/Cube 0:

Measurement grid: dx=5mm, dy=5mm, dz=5mm

Reference Value = 59.34 V/m; Power Drift = -0.01 dB

Peak SAR (extrapolated) = 3.57 W/kg

SAR(1 g) = 2.45 W/kg; SAR(10 g) = 1.6 W/kg

Maximum value of SAR (measured) = 3.21 W/kg

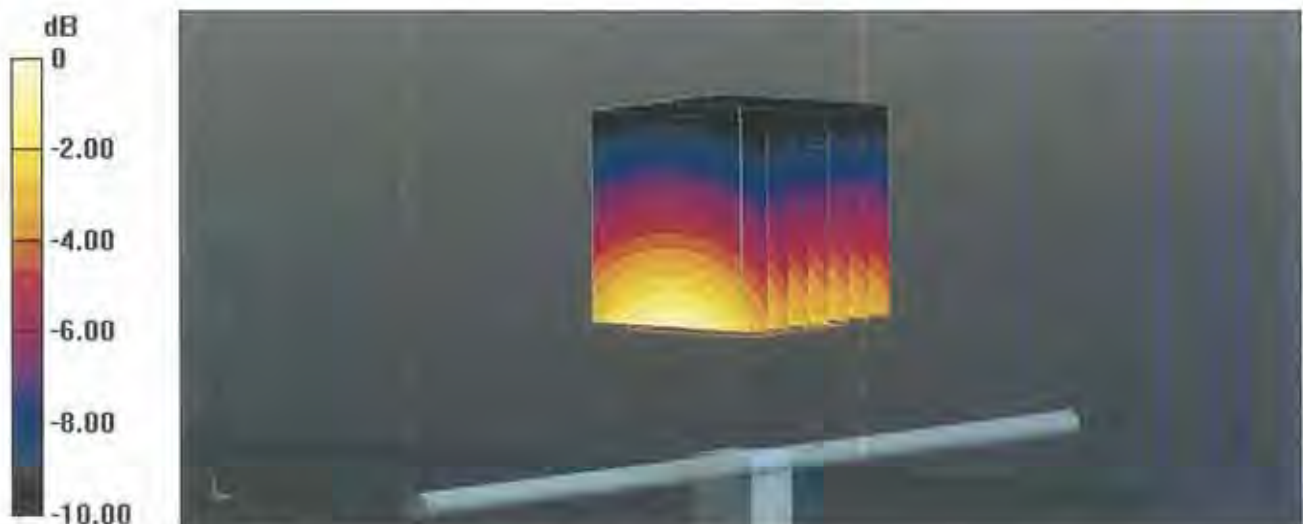

Impedance Measurement Plot for Body TSL

20 Apr 2016 09:59:09
CH1 S11 1 U FS 2: 48.658 Ω -4.1543 Ω 45.881 pF 835.000 000 MHz

*
De1

Ca

Avg
16

H1 d

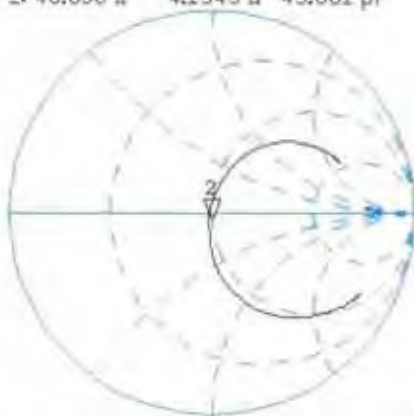

CH2 S11 LOG 5 dB/REF -20 dB 2:-27.091 dB 835.000 000 MHz

Ca

Avg
16

H1 d

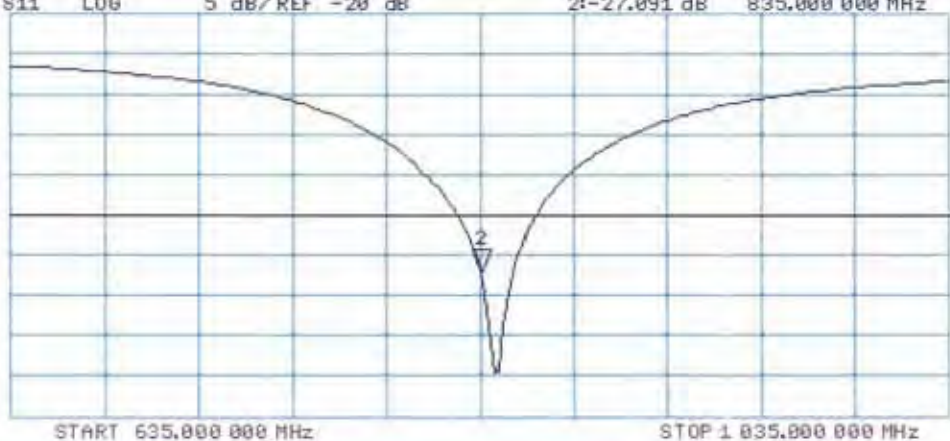

START 635.000 000 MHz

STOP 1 835.000 000 MHz

Justification of the extended calibration of Dipole D835V2 SN:4d059

Per KDB 865664, we have measured the Impedance and Return Loss as below.

- 1) The most recent return-loss result, measured at least annually, deviates by no more than 20% from the previous measurement.
- 2) The most recent measurement of the real or imaginary parts of the impedance, measured at least annually is within 5 ohm from the previous measurement.

Dipole 835 Head TST	Target Value	Measured Value	Difference
Impedance transformed to feed point	52.0Ω-1.8j Ω	52.2Ω-2.83j Ω	R=0.2Ω,X=-1.03Ω
Return Loss	-31.4dB	-32.32 dB	-2.92%
Dipole 835 Body TST	Target Value	Measured Value	Difference
Impedance transformed to feed point	48.7Ω-4.2j Ω	48.07Ω-4.87j Ω	R=-0.63Ω,X=-0.67Ω
Return Loss	-27.1 dB	-29.58 dB	-9.15%
Measured Date	2016-04-20	2018-04-15	-----

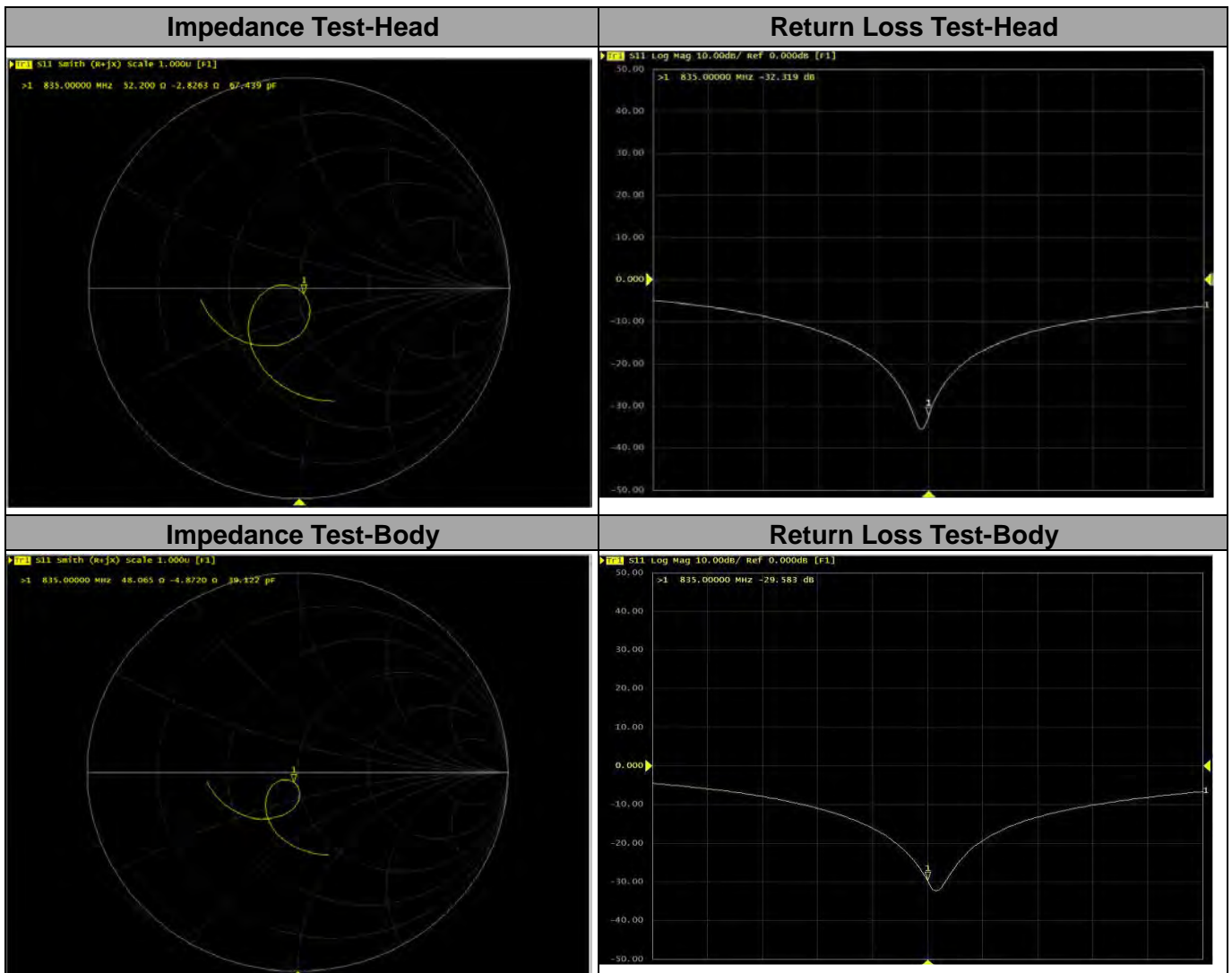



Accredited by the Swiss Accreditation Service (SAS)
The Swiss Accreditation Service is one of the signatories to the EA
Multilateral Agreement for the recognition of calibration certificates

Accreditation No.: **SCS 0108**

Client **Huawei-SZ (Auden)**

Certificate No: **D835V2-4d126_Jul18**

CALIBRATION CERTIFICATE

Object **D835V2 - SN:4d126**

Calibration procedure(s) **QA CAL-05.v10
Calibration procedure for dipole validation kits above 700 MHz**

Calibration date: **July 24, 2018**

This calibration certificate documents the traceability to national standards, which realize the physical units of measurements (SI).
The measurements and the uncertainties with confidence probability are given on the following pages and are part of the certificate.

All calibrations have been conducted in the closed laboratory facility: environment temperature (22 ± 3)°C and humidity < 70%.

Calibration Equipment used (M&TE critical for calibration)

Primary Standards	ID #	Cal Date (Certificate No.)	Scheduled Calibration
Power meter NRP	SN: 104778	04-Apr-18 (No. 217-02672/02673)	Apr-19
Power sensor NRP-Z91	SN: 103244	04-Apr-18 (No. 217-02672)	Apr-19
Power sensor NRP-Z91	SN: 103245	04-Apr-18 (No. 217-02673)	Apr-19
Reference 20 dB Attenuator	SN: 5058 (20k)	04-Apr-18 (No. 217-02682)	Apr-19
Type-N mismatch combination	SN: 5047.2 / 06327	04-Apr-18 (No. 217-02683)	Apr-19
Reference Probe EX3DV4	SN: 7349	30-Dec-17 (No. EX3-7349_Dec17)	Dec-18
DAE4	SN: 601	26-Oct-17 (No. DAE4-601_Oct17)	Oct-18

Secondary Standards	ID #	Check Date (in house)	Scheduled Check
Power meter EPM-442A	SN: GB37480704	07-Oct-15 (in house check Oct-16)	In house check: Oct-18
Power sensor HP 8481A	SN: US37292783	07-Oct-15 (in house check Oct-16)	In house check: Oct-18
Power sensor HP 8481A	SN: MY41092317	07-Oct-15 (in house check Oct-16)	In house check: Oct-18
RF generator R&S SMT-06	SN: 100972	15-Jun-15 (in house check Oct-16)	In house check: Oct-18
Network Analyzer Agilent E8358A	SN: US41080477	31-Mar-14 (in house check Oct-17)	In house check: Oct-18

Calibrated by: **Manu Seitz** **Manu Seitz** **Laboratory Technician**

Approved by: **Katja Pokovic** **Katja Pokovic** **Technical Manager**

Issued: July 24, 2018

This calibration certificate shall not be reproduced except in full without written approval of the laboratory.



Accredited by the Swiss Accreditation Service (SAS)
The Swiss Accreditation Service is one of the signatories to the EA
Multilateral Agreement for the recognition of calibration certificates

Glossary:

TSL	tissue simulating liquid
ConvF	sensitivity in TSL / NORM x,y,z
N/A	not applicable or not measured

Calibration is Performed According to the Following Standards:

- a) IEEE Std 1528-2013, "IEEE Recommended Practice for Determining the Peak Spatial-Averaged Specific Absorption Rate (SAR) in the Human Head from Wireless Communications Devices: Measurement Techniques", June 2013
- b) IEC 62209-1, "Measurement procedure for the assessment of Specific Absorption Rate (SAR) from hand-held and body-mounted devices used next to the ear (frequency range of 300 MHz to 6 GHz)", July 2016
- c) IEC 62209-2, "Procedure to determine the Specific Absorption Rate (SAR) for wireless communication devices used in close proximity to the human body (frequency range of 30 MHz to 6 GHz)", March 2010
- d) KDB 865664, "SAR Measurement Requirements for 100 MHz to 6 GHz"

Additional Documentation:

- e) DASY4/5 System Handbook

Methods Applied and Interpretation of Parameters:

- *Measurement Conditions:* Further details are available from the Validation Report at the end of the certificate. All figures stated in the certificate are valid at the frequency indicated.
- *Antenna Parameters with TSL:* The dipole is mounted with the spacer to position its feed point exactly below the center marking of the flat phantom section, with the arms oriented parallel to the body axis.
- *Feed Point Impedance and Return Loss:* These parameters are measured with the dipole positioned under the liquid filled phantom. The impedance stated is transformed from the measurement at the SMA connector to the feed point. The Return Loss ensures low reflected power. No uncertainty required.
- *Electrical Delay:* One-way delay between the SMA connector and the antenna feed point. No uncertainty required.
- *SAR measured:* SAR measured at the stated antenna input power.
- *SAR normalized:* SAR as measured, normalized to an input power of 1 W at the antenna connector.
- *SAR for nominal TSL parameters:* The measured TSL parameters are used to calculate the nominal SAR result.

The reported uncertainty of measurement is stated as the standard uncertainty of measurement multiplied by the coverage factor $k=2$, which for a normal distribution corresponds to a coverage probability of approximately 95%.

Measurement Conditions

DASY system configuration, as far as not given on page 1.

DASY Version	DASY5	V52.10.1
Extrapolation	Advanced Extrapolation	
Phantom	Modular Flat Phantom	
Distance Dipole Center - TSL	15 mm	with Spacer
Zoom Scan Resolution	dx, dy, dz = 5 mm	
Frequency	835 MHz \pm 1 MHz	

Head TSL parameters

The following parameters and calculations were applied.

	Temperature	Permittivity	Conductivity
Nominal Head TSL parameters	22.0 °C	41.5	0.90 mho/m
Measured Head TSL parameters	(22.0 \pm 0.2) °C	40.7 \pm 6 %	0.92 mho/m \pm 6 %
Head TSL temperature change during test	< 0.5 °C	----	----

SAR result with Head TSL

SAR averaged over 1 cm³ (1 g) of Head TSL	Condition	
SAR measured	250 mW input power	2.41 W/kg
SAR for nominal Head TSL parameters	normalized to 1W	9.44 W/kg \pm 17.0 % (k=2)

SAR averaged over 10 cm³ (10 g) of Head TSL	condition	
SAR measured	250 mW input power	1.54 W/kg
SAR for nominal Head TSL parameters	normalized to 1W	6.06 W/kg \pm 16.5 % (k=2)

Body TSL parameters

The following parameters and calculations were applied.

	Temperature	Permittivity	Conductivity
Nominal Body TSL parameters	22.0 °C	55.2	0.97 mho/m
Measured Body TSL parameters	(22.0 \pm 0.2) °C	55.2 \pm 6 %	0.99 mho/m \pm 6 %
Body TSL temperature change during test	< 0.5 °C	----	----

SAR result with Body TSL

SAR averaged over 1 cm³ (1 g) of Body TSL	Condition	
SAR measured	250 mW input power	2.45 W/kg
SAR for nominal Body TSL parameters	normalized to 1W	9.65 W/kg \pm 17.0 % (k=2)

SAR averaged over 10 cm³ (10 g) of Body TSL	condition	
SAR measured	250 mW input power	1.60 W/kg
SAR for nominal Body TSL parameters	normalized to 1W	6.32 W/kg \pm 16.5 % (k=2)

Appendix (Additional assessments outside the scope of SCS 0108)

Antenna Parameters with Head TSL

Impedance, transformed to feed point	49.5 Ω - 1.9 j Ω
Return Loss	- 34.3 dB

Antenna Parameters with Body TSL

Impedance, transformed to feed point	45.4 Ω - 0.4 j Ω
Return Loss	- 26.3 dB

General Antenna Parameters and Design

Electrical Delay (one direction)	1.395 ns
----------------------------------	----------

After long term use with 100W radiated power, only a slight warming of the dipole near the feedpoint can be measured.

The dipole is made of standard semirigid coaxial cable. The center conductor of the feeding line is directly connected to the second arm of the dipole. The antenna is therefore short-circuited for DC-signals. On some of the dipoles, small end caps are added to the dipole arms in order to improve matching when loaded according to the position as explained in the "Measurement Conditions" paragraph. The SAR data are not affected by this change. The overall dipole length is still according to the Standard.

No excessive force must be applied to the dipole arms, because they might bend or the soldered connections near the feedpoint may be damaged.

Additional EUT Data

Manufactured by	SPEAG
Manufactured on	June 29, 2010

DASY5 Validation Report for Head TSL

Date: 24.07.2018

Test Laboratory: SPEAG, Zurich, Switzerland

DUT: Dipole 835 MHz; Type: D835V2; Serial: D835V2 - SN:4d126

Communication System: UID 0 - CW; Frequency: 835 MHz

Medium parameters used: $f = 835$ MHz; $\sigma = 0.92$ S/m; $\epsilon_r = 40.7$; $\rho = 1000$ kg/m³

Phantom section: Flat Section

Measurement Standard: DASY5 (IEEE/IEC/ANSI C63.19-2011)

DASY52 Configuration:

- Probe: EX3DV4 - SN7349; ConvF(9.9, 9.9, 9.9) @ 835 MHz; Calibrated: 30.12.2017
- Sensor-Surface: 1.4mm (Mechanical Surface Detection)
- Electronics: DAE4 Sn601; Calibrated: 26.10.2017
- Phantom: Flat Phantom 4.9 (front); Type: QD 00L P49 AA; Serial: 1001
- DASY52 52.10.1(1476); SEMCAD X 14.6.11(7439)

Dipole Calibration for Head Tissue/Pin=250 mW, d=15mm/Zoom Scan (7x7x7)/Cube 0:

Measurement grid: dx=5mm, dy=5mm, dz=5mm

Reference Value = 62.67 V/m; Power Drift = -0.00 dB

Peak SAR (extrapolated) = 3.74 W/kg

SAR(1 g) = 2.41 W/kg; SAR(10 g) = 1.54 W/kg

Maximum value of SAR (measured) = 3.29 W/kg

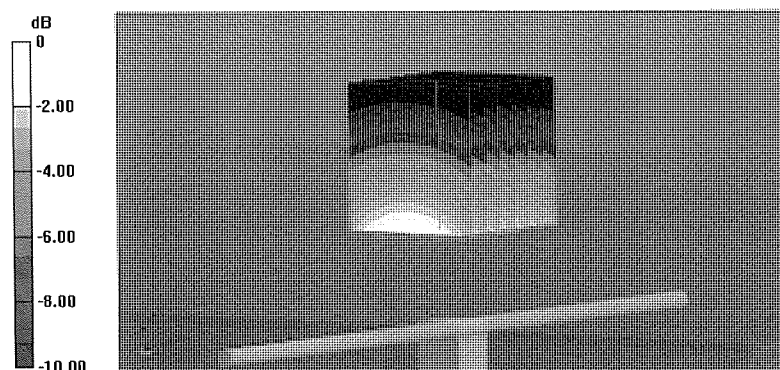

0 dB = 3.29 W/kg = 5.17 dBW/kg

Impedance Measurement Plot for Head TSL

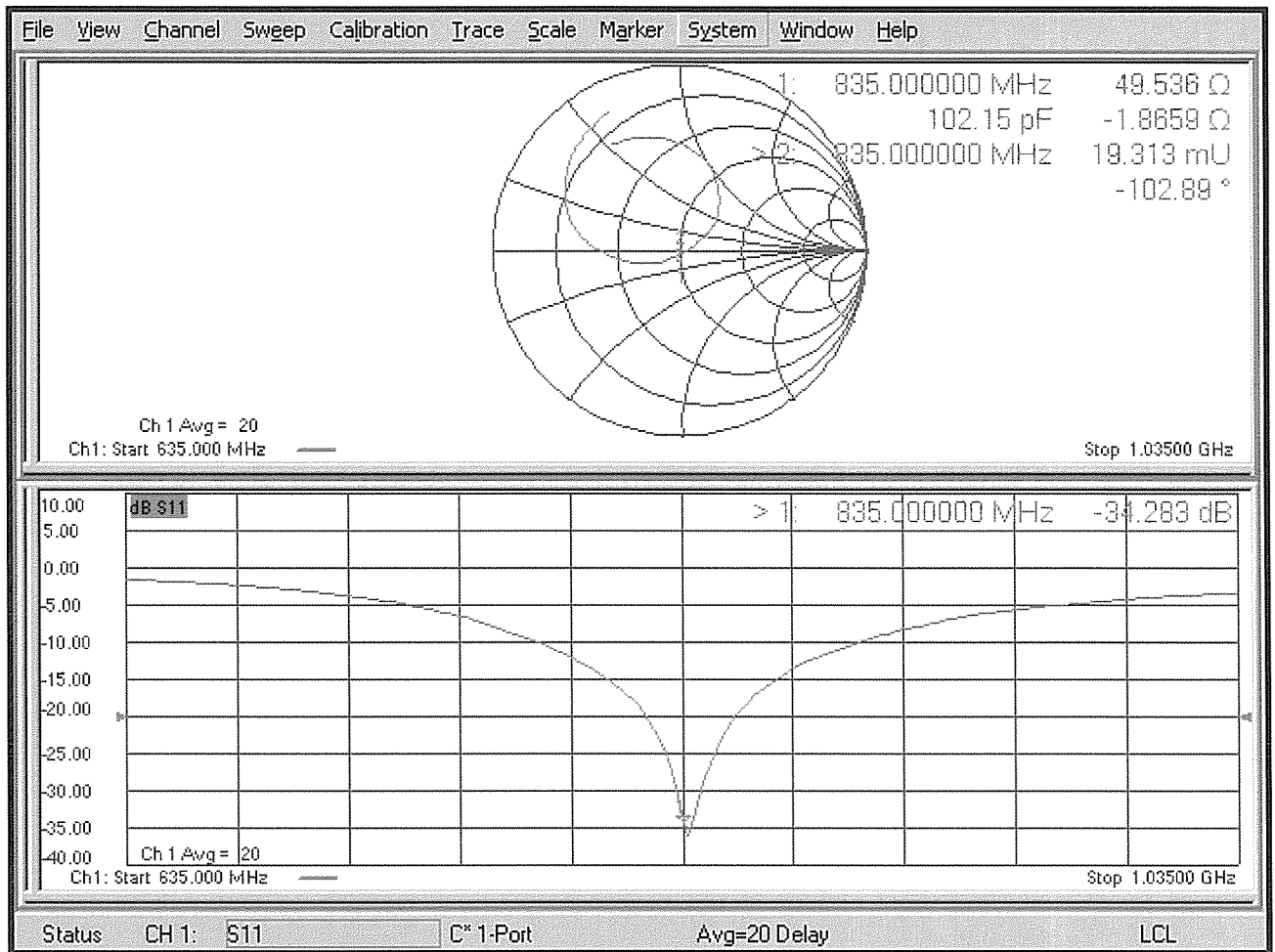

DASY5 Validation Report for Body TSL

Date: 23.07.2018

Test Laboratory: SPEAG, Zurich, Switzerland

DUT: Dipole 835 MHz; Type: D835V2; Serial: D835V2 - SN:4d126

Communication System: UID 0 - CW; Frequency: 835 MHz

Medium parameters used: $f = 835$ MHz; $\sigma = 0.99$ S/m; $\epsilon_r = 55.2$; $\rho = 1000$ kg/m³

Phantom section: Flat Section

Measurement Standard: DASY5 (IEEE/IEC/ANSI C63.19-2011)

DASY52 Configuration:

- Probe: EX3DV4 - SN7349; ConvF(10.05, 10.05, 10.05) @ 835 MHz; Calibrated: 30.12.2017
- Sensor-Surface: 1.4mm (Mechanical Surface Detection)
- Electronics: DAE4 Sn601; Calibrated: 26.10.2017
- Phantom: Flat Phantom 4.9 (Back); Type: QD 00R P49 AA; Serial: 1005
- DASY52 52.10.1(1476); SEMCAD X 14.6.11(7439)

Dipole Calibration for Body Tissue/Pin=250 mW, d=15mm/Zoom Scan (7x7x7)/Cube 0:

Measurement grid: dx=5mm, dy=5mm, dz=5mm

Reference Value = 61.39 V/m; Power Drift = -0.07 dB

Peak SAR (extrapolated) = 3.66 W/kg

SAR(1 g) = 2.45 W/kg; SAR(10 g) = 1.6 W/kg

Maximum value of SAR (measured) = 3.26 W/kg

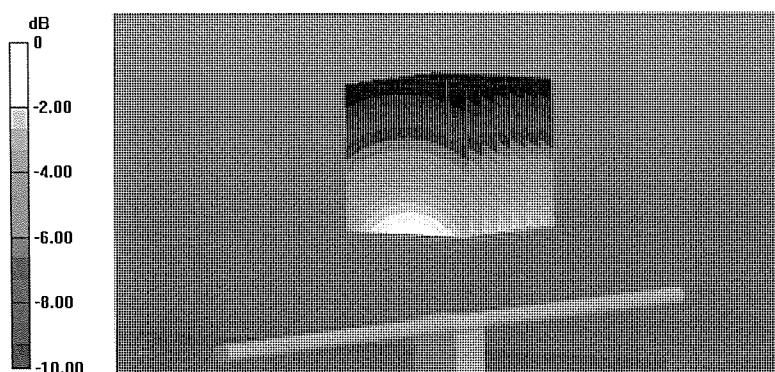

0 dB = 3.26 W/kg = 5.13 dBW/kg

Impedance Measurement Plot for Body TSL

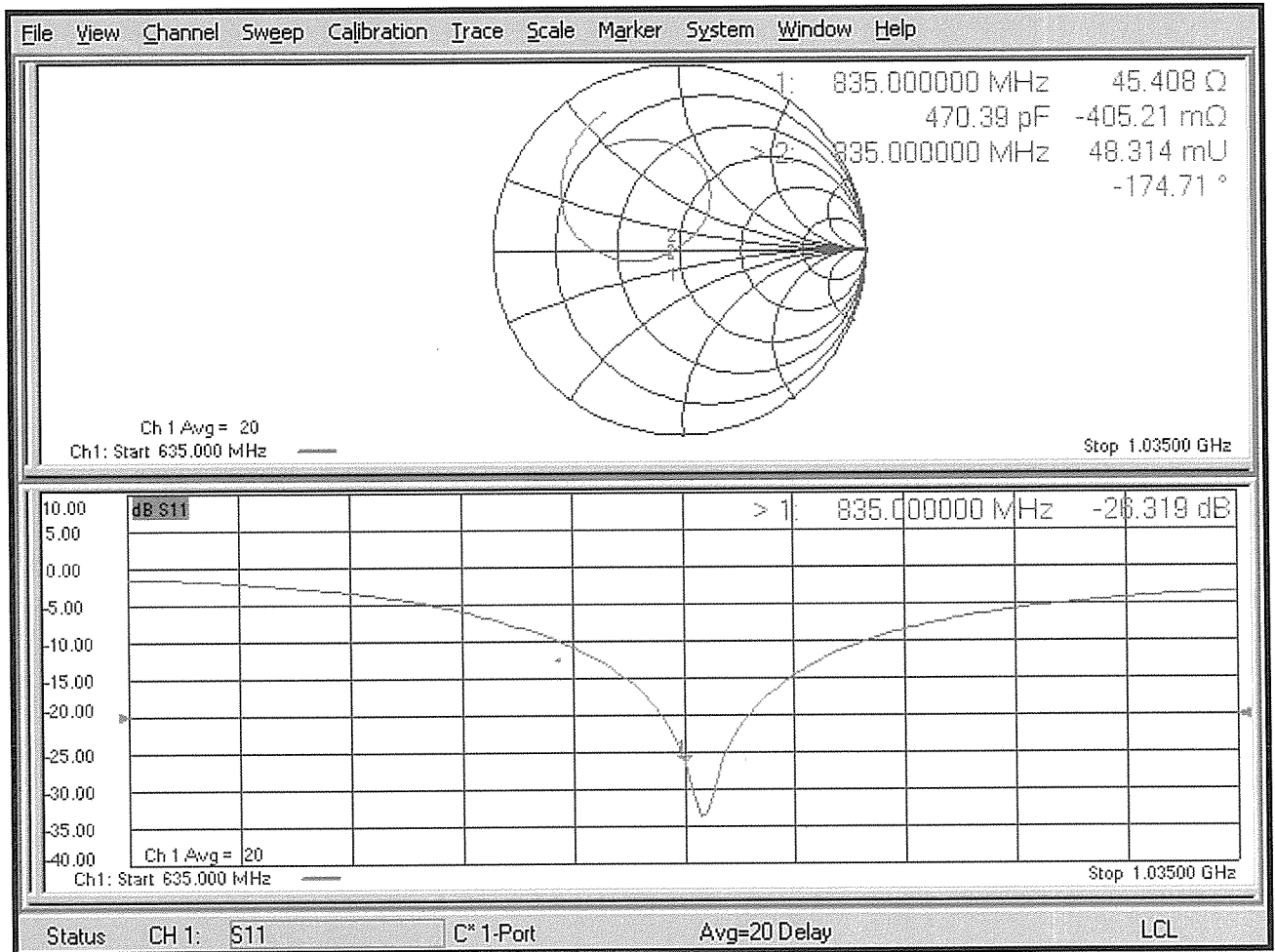



Accredited by the Swiss Accreditation Service (SAS)
The Swiss Accreditation Service is one of the signatories to the EA
Multilateral Agreement for the recognition of calibration certificates

Accreditation No.: **SCS 0108**

Client **Huawei-SZ (Auden)**

Certificate No: **D1750V2-1123_Jul17**

CALIBRATION CERTIFICATE

Object **D1750V2 - SN:1123**

Calibration procedure(s) **QA CAL-05.v9
Calibration procedure for dipole validation kits above 700 MHz**

Calibration date: **July 27, 2017**

This calibration certificate documents the traceability to national standards, which realize the physical units of measurements (SI).
The measurements and the uncertainties with confidence probability are given on the following pages and are part of the certificate.

All calibrations have been conducted in the closed laboratory facility: environment temperature (22 ± 3)°C and humidity < 70%.

Calibration Equipment used (M&TE critical for calibration)

Primary Standards	ID #	Cal Date (Certificate No.)	Scheduled Calibration
Power meter NRP	SN: 104778	04-Apr-17 (No. 217-02521/02522)	Apr-18
Power sensor NRP-Z91	SN: 103244	04-Apr-17 (No. 217-02521)	Apr-18
Power sensor NRP-Z91	SN: 103245	04-Apr-17 (No. 217-02522)	Apr-18
Reference 20 dB Attenuator	SN: 5058 (20k)	07-Apr-17 (No. 217-02528)	Apr-18
Type-N mismatch combination	SN: 5047.2 / 06327	07-Apr-17 (No. 217-02529)	Apr-18
Reference Probe EX3DV4	SN: 7349	31-May-17 (No. EX3-7349_May17)	May-18
DAE4	SN: 601	28-Mar-17 (No. DAE4-601_Mar17)	Mar-18
Secondary Standards	ID #	Check Date (in house)	Scheduled Check
Power meter EPM-442A	SN: GB37480704	07-Oct-15 (in house check Oct-16)	In house check: Oct-18
Power sensor HP 8481A	SN: US37292783	07-Oct-15 (in house check Oct-16)	In house check: Oct-18
Power sensor HP 8481A	SN: MY41092317	07-Oct-15 (in house check Oct-16)	In house check: Oct-18
RF generator R&S SMT-06	SN: 100972	15-Jun-15 (in house check Oct-16)	In house check: Oct-18
Network Analyzer HP 8753E	SN: US37390585	18-Oct-01 (in house check Oct-16)	In house check: Oct-17

Calibrated by: **Michael Weber** Name: Michael Weber Function: Laboratory Technician

Signature

Approved by: **Katja Pokovic** Name: Katja Pokovic Function: Technical Manager

Issued: July 27, 2017

This calibration certificate shall not be reproduced except in full without written approval of the laboratory.



Accredited by the Swiss Accreditation Service (SAS)

The Swiss Accreditation Service is one of the signatories to the EA Multilateral Agreement for the recognition of calibration certificates

Accreditation No.: **SCS 0108**

Glossary:

TSL	tissue simulating liquid
ConvF	sensitivity in TSL / NORM x,y,z
N/A	not applicable or not measured

Calibration is Performed According to the Following Standards:

- IEEE Std 1528-2013, "IEEE Recommended Practice for Determining the Peak Spatial-Averaged Specific Absorption Rate (SAR) in the Human Head from Wireless Communications Devices: Measurement Techniques", June 2013
- IEC 62209-1, "Measurement procedure for the assessment of Specific Absorption Rate (SAR) from hand-held and body-mounted devices used next to the ear (frequency range of 300 MHz to 6 GHz)", July 2016
- IEC 62209-2, "Procedure to determine the Specific Absorption Rate (SAR) for wireless communication devices used in close proximity to the human body (frequency range of 30 MHz to 6 GHz)", March 2010
- KDB 865664, "SAR Measurement Requirements for 100 MHz to 6 GHz"

Additional Documentation:

- DASY4/5 System Handbook

Methods Applied and Interpretation of Parameters:

- Measurement Conditions:** Further details are available from the Validation Report at the end of the certificate. All figures stated in the certificate are valid at the frequency indicated.
- Antenna Parameters with TSL:** The dipole is mounted with the spacer to position its feed point exactly below the center marking of the flat phantom section, with the arms oriented parallel to the body axis.
- Feed Point Impedance and Return Loss:** These parameters are measured with the dipole positioned under the liquid filled phantom. The impedance stated is transformed from the measurement at the SMA connector to the feed point. The Return Loss ensures low reflected power. No uncertainty required.
- Electrical Delay:** One-way delay between the SMA connector and the antenna feed point. No uncertainty required.
- SAR measured:** SAR measured at the stated antenna input power.
- SAR normalized:** SAR as measured, normalized to an input power of 1 W at the antenna connector.
- SAR for nominal TSL parameters:** The measured TSL parameters are used to calculate the nominal SAR result.

The reported uncertainty of measurement is stated as the standard uncertainty of measurement multiplied by the coverage factor $k=2$, which for a normal distribution corresponds to a coverage probability of approximately 95%.

Measurement Conditions

DASY system configuration, as far as not given on page 1.

DASY Version	DASY5	V52.10.0
Extrapolation	Advanced Extrapolation	
Phantom	Modular Flat Phantom	
Distance Dipole Center - TSL	10 mm	with Spacer
Zoom Scan Resolution	dx, dy, dz = 5 mm	
Frequency	1750 MHz \pm 1 MHz	

Head TSL parameters

The following parameters and calculations were applied.

	Temperature	Permittivity	Conductivity
Nominal Head TSL parameters	22.0 °C	40.1	1.37 mho/m
Measured Head TSL parameters	(22.0 \pm 0.2) °C	39.0 \pm 6 %	1.35 mho/m \pm 6 %
Head TSL temperature change during test	< 0.5 °C	----	----

SAR result with Head TSL

SAR averaged over 1 cm³ (1 g) of Head TSL	Condition	
SAR measured	250 mW input power	9.13 W/kg
SAR for nominal Head TSL parameters	normalized to 1W	36.6 W/kg \pm 17.0 % (k=2)

SAR averaged over 10 cm³ (10 g) of Head TSL	condition	
SAR measured	250 mW input power	4.83 W/kg
SAR for nominal Head TSL parameters	normalized to 1W	19.4 W/kg \pm 16.5 % (k=2)

Body TSL parameters

The following parameters and calculations were applied.

	Temperature	Permittivity	Conductivity
Nominal Body TSL parameters	22.0 °C	53.4	1.49 mho/m
Measured Body TSL parameters	(22.0 \pm 0.2) °C	53.3 \pm 6 %	1.49 mho/m \pm 6 %
Body TSL temperature change during test	< 0.5 °C	----	----

SAR result with Body TSL

SAR averaged over 1 cm³ (1 g) of Body TSL	Condition	
SAR measured	250 mW input power	9.11 W/kg
SAR for nominal Body TSL parameters	normalized to 1W	36.4 W/kg \pm 17.0 % (k=2)

SAR averaged over 10 cm³ (10 g) of Body TSL	condition	
SAR measured	250 mW input power	4.86 W/kg
SAR for nominal Body TSL parameters	normalized to 1W	19.4 W/kg \pm 16.5 % (k=2)

Appendix (Additional assessments outside the scope of SCS 0108)

Antenna Parameters with Head TSL

Impedance, transformed to feed point	50.6 Ω - 0.8 j Ω
Return Loss	- 40.2 dB

Antenna Parameters with Body TSL

Impedance, transformed to feed point	46.9 Ω - 1.0 j Ω
Return Loss	- 29.5 dB

General Antenna Parameters and Design

Electrical Delay (one direction)	1.220 ns
----------------------------------	----------

After long term use with 100W radiated power, only a slight warming of the dipole near the feedpoint can be measured.

The dipole is made of standard semirigid coaxial cable. The center conductor of the feeding line is directly connected to the second arm of the dipole. The antenna is therefore short-circuited for DC-signals. On some of the dipoles, small end caps are added to the dipole arms in order to improve matching when loaded according to the position as explained in the "Measurement Conditions" paragraph. The SAR data are not affected by this change. The overall dipole length is still according to the Standard.

No excessive force must be applied to the dipole arms, because they might bend or the soldered connections near the feedpoint may be damaged.

Additional EUT Data

Manufactured by	SPEAG
Manufactured on	June 03, 2014

DASY5 Validation Report for Head TSL

Date: 21.07.2017

Test Laboratory: SPEAG, Zurich, Switzerland

DUT: Dipole 1750 MHz; Type: D1750V2; Serial: D1750V2 - SN:1123

Communication System: UID 0 - CW; Frequency: 1750 MHz

Medium parameters used: $f = 1750$ MHz; $\sigma = 1.35$ S/m; $\epsilon_r = 39$; $\rho = 1000$ kg/m³

Phantom section: Flat Section

Measurement Standard: DASY5 (IEEE/IEC/ANSI C63.19-2011)

DASY52 Configuration:

- Probe: EX3DV4 - SN7349; ConvF(8.73, 8.73, 8.73); Calibrated: 31.05.2017;
- Sensor-Surface: 1.4mm (Mechanical Surface Detection)
- Electronics: DAE4 Sn601; Calibrated: 28.03.2017
- Phantom: Flat Phantom 5.0 (front); Type: QD 000 P50 AA; Serial: 1001
- DASY52 52.10.0(1446); SEMCAD X 14.6.10(7417)

Dipole Calibration for Head Tissue/Pin=250 mW, d=10mm/Zoom Scan (7x7x7)/Cube 0:

Measurement grid: dx=5mm, dy=5mm, dz=5mm

Reference Value = 104.2 V/m; Power Drift = -0.05 dB

Peak SAR (extrapolated) = 17.0 W/kg

SAR(1 g) = 9.13 W/kg; SAR(10 g) = 4.83 W/kg

Maximum value of SAR (measured) = 14.0 W/kg

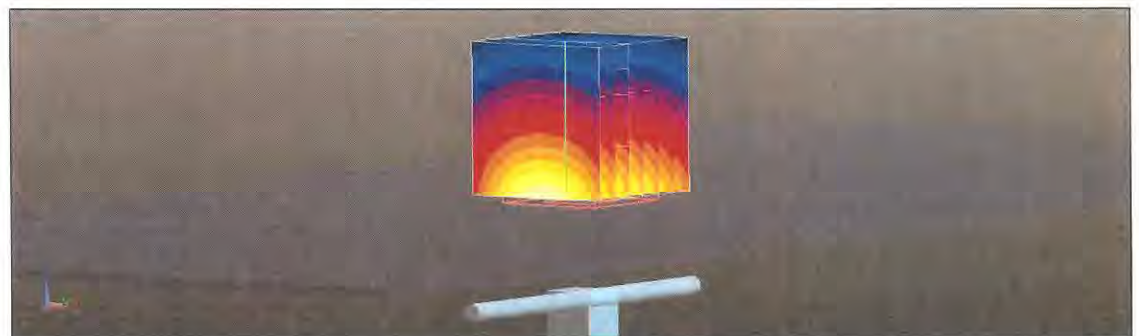
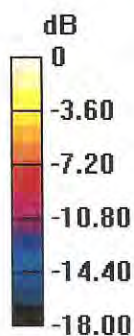

0 dB = 14.0 W/kg = 11.46 dBW/kg

Impedance Measurement Plot for Head TSL

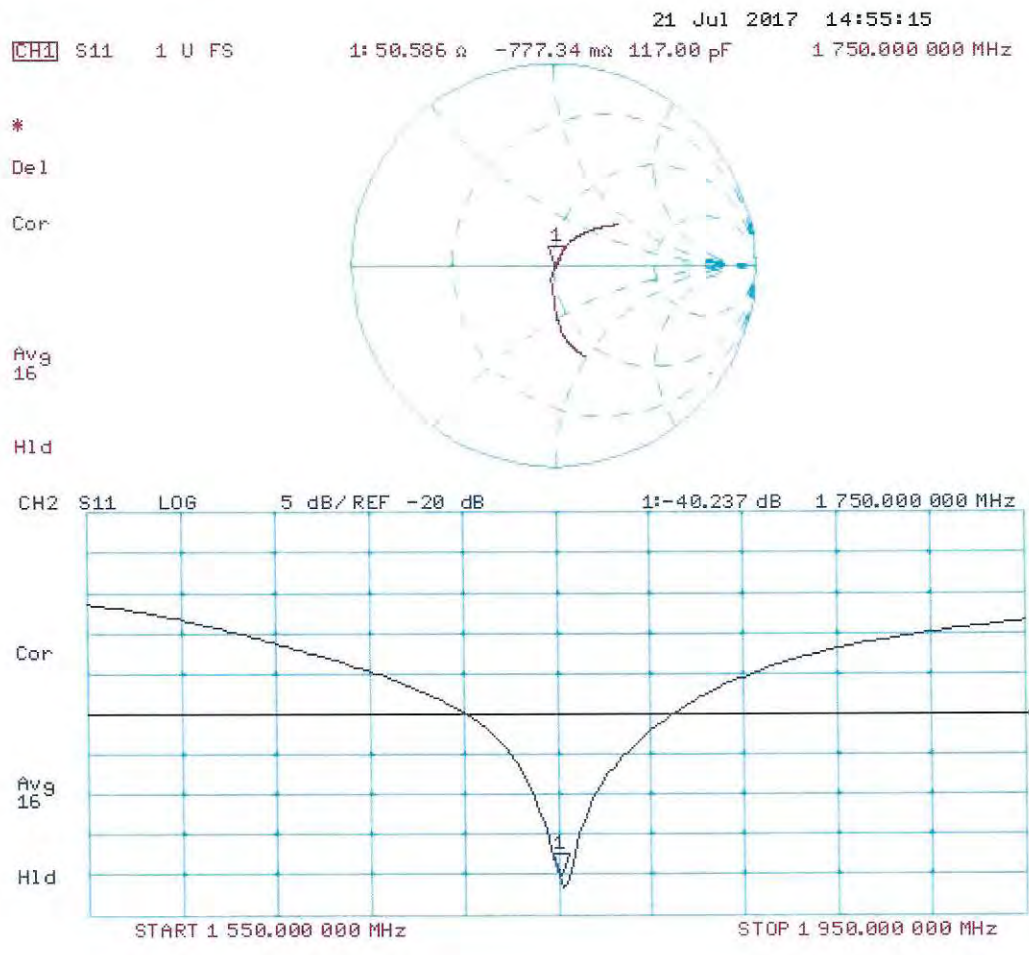

DASY5 Validation Report for Body TSL

Date: 27.07.2017

Test Laboratory: SPEAG, Zurich, Switzerland

DUT: Dipole 1750 MHz; Type: D1750V2; Serial: D1750V2 - SN:1123

Communication System: UID 0 - CW; Frequency: 1750 MHz

Medium parameters used: $f = 1750$ MHz; $\sigma = 1.49$ S/m; $\epsilon_r = 53.3$; $\rho = 1000$ kg/m³

Phantom section: Flat Section

Measurement Standard: DASY5 (IEEE/IEC/ANSI C63.19-2011)

DASY52 Configuration:

- Probe: EX3DV4 - SN7349; ConvF(8.46, 8.46, 8.46); Calibrated: 31.05.2017;
- Sensor-Surface: 1.4mm (Mechanical Surface Detection)
- Electronics: DAE4 Sn601; Calibrated: 28.03.2017
- Phantom: Flat Phantom 5.0 (back); Type: QD 000 P50 AA; Serial: 1002
- DASY52 52.10.0(1446); SEMCAD X 14.6.10(7417)

Dipole Calibration for Body Tissue/Pin=250 mW, d=10mm/Zoom Scan (7x7x7)/Cube 0:

Measurement grid: dx=5mm, dy=5mm, dz=5mm

Reference Value = 97.09 V/m; Power Drift = -0.02 dB

Peak SAR (extrapolated) = 15.9 W/kg

SAR(1 g) = 9.11 W/kg; SAR(10 g) = 4.86 W/kg

Maximum value of SAR (measured) = 13.1 W/kg



0 dB = 13.1 W/kg = 11.17 dBW/kg

Impedance Measurement Plot for Body TSL

26 Jul 2017 08:47:09

CH1 S11 1 U FS 1: 46.902 Ω -1.0352 Ω 87.857 pF 1 750.000 000 MHz

*

De1

CA

Avg
10

H1d

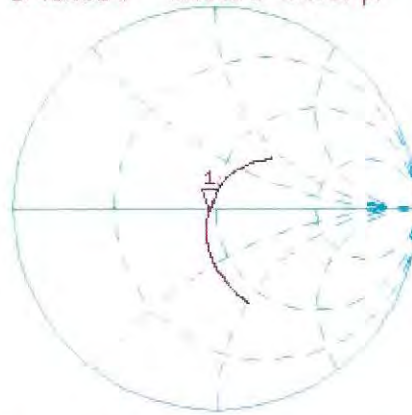

CH2 S11 LOG 5 dB/REF -20 dB 1:-29.458 dB 1 750.000 000 MHz

CA

Avg
10

H1d

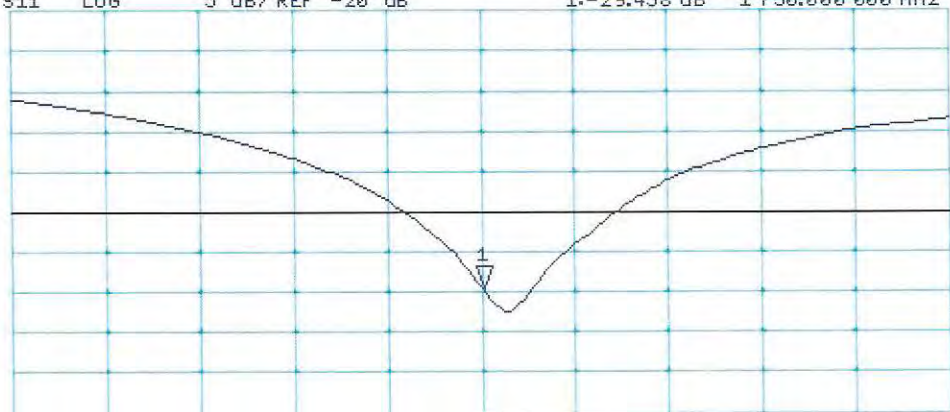

START 1 550.000 000 MHz

STOP 1 950.000 000 MHz