

FCC Radio Test Report

FCC ID: QISME919BS-567AB

This report concerns: Original Grant

Project No. : 1907C127
Equipment : LTE Module
Test Model : ME919Bs-567ab
Series Model : N/A
Applicant : Huawei Technologies Co., Ltd.
Address : Administration Building, Headquarters of Huawei Technologies Co., Ltd., Bantian, Longgang District, Shenzhen, 518129, China

Date of Receipt : Jul. 16, 2019
Date of Test : Jul. 17, 2019 ~ Aug. 01, 2019
Issued Date : Aug. 06, 2019
Tested by : BTL Inc.

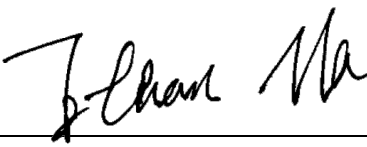
Technical Manager : 
(Ethan Ma)

Authorized Signatory : 
(Steven Lu)

B T L I N C .

No.3, Jinshagang 1st Road, Shixia, Dalang Town, Dongguan, Guangdong, China.

TEL: +86-769-8318-3000 FAX: +86-769-8319-6000



Certificate #5123.02

Declaration

BTL represents to the client that testing is done in accordance with standard procedures as applicable and that test instruments used has been calibrated with standards traceable to international standard(s) and/or national standard(s).

BTL's reports apply only to the specific samples tested under conditions. It is manufacture's responsibility to ensure that additional production units of this model are manufactured with the identical electrical and mechanical components. **BTL** shall have no liability for any declarations, inferences or generalizations drawn by the client or others from **BTL** issued reports.

The report must not be used by the client to claim product certification, approval, or endorsement by NIST, A2LA, or any agency of the U.S. Government.

This report is the confidential property of the client. As a mutual protection to the clients, the public and ourselves, the test report shall not be reproduced, except in full, without our written approval.

BTL's laboratory quality assurance procedures are in compliance with the **ISO/IEC 17025** requirements, and accredited by the conformity assessment authorities listed in this test report.

BTL is not responsible for the sampling stage, so the results only apply to the sample as received.

The information, data and test plan are provided by manufacturer which may affect the validity of results, so it is manufacturer's responsibility to ensure that the apparatus meets the essential requirements of applied standards and in all the possible configurations as representative of its intended use.

Limitation

For the use of the authority's logo is limited unless the Test Standard(s)/Scope(s)/Item(s) mentioned in this test report is (are) included in the conformity assessment authorities acceptance respective.

Please note that the measurement uncertainty is provided for informational purpose only and is not use in determining the Pass/Fail results.

Table of Contents	Page
REPORT ISSUED HISTORY	5
1 . GENERAL SUMMARY	6
2 . SUMMARY OF TEST RESULTS	7
2.1 TEST FACILITY	8
2.2 MEASUREMENT UNCERTAINTY	8
3 . GENERAL INFORMATION	9
3.1 GENERAL DESCRIPTION OF EUT	9
3.2 DESCRIPTION OF TEST MODES AND TEST CONDITION	11
3.3 BLOCK DIGRAM SHOWING THE CONFIGURATIONOFSYSTEMTESTED	14
3.4 DESCRIPTION OF SUPPORT UNITS	14
4 . TEST RESULT	15
4.1 OUTPUT POWER MEASUREMENT	15
4.1.1 LIMIT	15
4.1.2 TEST PROCEDURE	15
4.1.3 TEST SETUP LAYOUT	15
4.1.4 TEST DEVIATION	15
4.1.5 TEST RESULTS	15
4.2 OCCUPIED BANDWIDTH MEASUREMENT	16
4.2.1 TEST PROCEDURE	16
4.2.2 TEST SETUP LAYOUT	16
4.2.3 TEST DEVIATION	16
4.2.4 TEST RESULTS	16
4.3 CONDUCTED EMISSIONS MEASUREMENT	17
4.3.1 LIMIT	17
4.3.2 TEST PROCEDURES	17
4.3.3 TEST SETUP LAYOUT	17
4.3.4 TEST DEVIATION	17
4.3.5 TEST RESULTS	17
4.4 RADIATED EMISSIONS MEASUREMENT	18
4.4.1 LIMIT	18
4.4.2 TEST PROCEDURES	18
4.4.3 TEST SETUP LAYOUT	19
4.4.4 TEST DEVIATION	21
4.4.5 TEST RESULTS (9KHZ TO 30MHZ)	21
4.4.6 TEST RESULTS (30MHZ TO 1000MHZ)	21
4.4.7 TEST RESULTS (ABOVE 1000MHZ)	21
4.5 BAND EDGE MEASUREMENT	22
4.5.1 LIMIT	22

Table of Contents	Page
4.5.2 TEST PROCEDURES	22
4.5.3 TEST SETUP LAYOUT	22
4.5.4 TEST DEVIATION	22
4.5.5 TEST RESULTS	22
4.6 PEAK TO AVERAGE RATIO MEASUREMENT	23
4.6.1 LIMIT	23
4.6.2 TEST PROCEDURES	23
4.6.3 TEST SETUP LAYOUT	23
4.6.4 TEST DEVIATION	23
4.6.5 TEST RESULTS	23
4.7 FREQUENCY STABILITY MEASUREMENT	24
4.7.1 LIMIT	24
4.7.2 TEST PROCEDURES	24
4.7.3 TEST SETUP LAYOUT	24
4.7.4 TEST DEVIATION	24
4.7.5 TEST RESULTS	24
5. LIST OF MEASUREMENT EQUIPMENTS	25
APPENDIX A - OUTPUT POWER	27
APPENDIX B - OCCUPIED BANDWIDTH	34
APPENDIX C - CONDUCTED EMISSIONS	48
APPENDIX D - RADIATED EMISSION (9KHZ TO 30MHZ)	54
APPENDIX E - RADIATED EMISSION (30MHZ TO 1GHZ)	59
APPENDIX F - RADIATED EMISSION (ABOVE 1GHZ)	72
APPENDIX G - BAND EDGE	85
APPENDIX H - PEAK TO AVERAGE RATIO	92
APPENDIX I - FREQUENCY STABILITY	101

REPORT ISSUED HISTORY

Report Version	Description	Issued Date
R00	Original Issue.	Aug. 06, 2019

1. GENERAL SUMMARY

Equipment : LTE Module
Brand Name : HUAWEI
Test Model : ME919Bs-567ab
Series Model : N/A
Applicant : Huawei Technologies Co., Ltd.
Manufacturer : Huawei Technologies Co., Ltd.
Address : Administration Building, Headquarters of Huawei Technologies Co., Ltd.,
Bantian, Longgang District, Shenzhen, 518129, China
Factory : Huawei Technologies Co., Ltd.
Address : Administration Building, Headquarters of Huawei Technologies Co., Ltd.,
Bantian, Longgang District, Shenzhen, 518129, China
Date of Test : Jul. 17, 2019 ~ Aug. 01, 2019
Test Sample : Engineering Sample No.: DG19071638 for conducted, DG19071639 for
radiated.
Standard(s) : 47 CFR FCC Part 22 Subpart H
47 CFR FCC Part 2
ANSI/TIA/EIA-603-E-2016
FCC KDB 971168 D01 Power Meas License Digital Systems v03r01

The above equipment has been tested and found compliance with the requirement of the relative standards by BTL Inc.

The test data, data evaluation, and equipment configuration contained in our test report (Ref No. BTL-FCCP-1-1907C127) were obtained utilizing the test procedures, test instruments, test sites that has been accredited by the Authority of A2LA according to the ISO/IEC 17025 quality assessment standard and technical standard(s).

Test results included in this report are only for the GSM850, WCDMA Band V and LTE Band 5 part.

2. SUMMARY OF TEST RESULTS

Test procedures according to the technical standard(s):

FCC Part 22 Subpart H & Part 2			
Standard(s) Section	Test Item	Verdict	Tested By
2.1046 22.913(a)	Effective Radiated Power	PASS	Treyy Chen
2.1049	Occupied Bandwidth	PASS	Treyy Chen
2.1051 22.917(a)	Conducted Spurious Emissions	PASS	Treyy Chen
2.1053 22.917(a)	Radiated Spurious Emissions	PASS	Treyy Chen
22.917(a)	Band Edge Measurements	PASS	Treyy Chen
-	Peak To Average Ratio	PASS	Treyy Chen
2.1055 22.355	Frequency Stability	PASS	Treyy Chen

2.1 TEST FACILITY

The test facilities used to collect the test data in this report is at the location of No.3, Jinshagang 1st Road, Shixia, Dalang Town, Dongguan, Guangdong, China.

BTL's Test Firm Registration Number for FCC: 357015

BTL's Designation Number for FCC: CN1240

2.2 MEASUREMENT UNCERTAINTY

The measurement uncertainty figures shall be calculated according the methods described in the ETSI TR 100 028 and shall correspond to an expansion factor (coverage factor) $k=1.96$ or $k=2$ (which provide confidence levels of respectively 90% and 95.45% in the case where the distributions characterizing the actual measurement uncertainties are normal (Gaussian)).

Measurement Uncertainty for a Level of Confidence of 95 %, $U=2xUc(y)$.

The BTL measurement uncertainty as below table:

A. Radiated Measurement :

Test Site	Method	Measurement Frequency Range	Ant. H / V	U,(dB)
DG-CB03 (3m)	CISPR	9KHz ~ 30MHz	V	3.79
		9KHz ~ 30MHz	H	3.57
		30MHz ~ 200MHz	V	4.88
		30MHz ~ 200MHz	H	4.14
		200MHz ~ 1,000MHz	V	4.62
		200MHz ~ 1,000MHz	H	4.80

Test Site	Method	Measurement Frequency Range	U,(dB)
DG-CB03 (3m)	CISPR	1GHz ~ 6GHz	4.58
		6GHz ~ 18GHz	5.18

Test Site	Method	Measurement Frequency Range	U,(dB)
DG-CB03 (1m)	CISPR	18 ~ 26.5 GHz	3.80
		26.5 ~ 40 GHz	4.30

Note: Unless specifically mentioned, the uncertainty of measurement has not been taken into account to declare the compliance or non-compliance to the specification.

3. GENERAL INFORMATION

3.1 GENERAL DESCRIPTION OF EUT

Equipment	LTE Module	
Brand Name	HUAWEI	
Test Model	ME919Bs-567ab	
Series Model	N/A	
Model Difference(s)	N/A	
Hardware Version	RM3ME919BSM31	
Software Version	11.790.01.05.1419	
Antenna Type	Internal Antenna	
Antenna Gain	GSM850	2.5 dBi
	WCDMA V	
	LTE Band 5	
Modulation Type	GSM/GPRS	GMSK
	EDGE	GMSK, 8PSK
	WCDMA	UL: QPSK DL: QPSK, 16QAM
	WCDMA(HSDPA/HSUPA)	16QAM
	LTE	UL: QPSK, 16QAM DL: QPSK, 16QAM, 64QAM
Operation Frequency	GSM /EDGE/GPRS	824.2MHz ~ 848.8MHz
	WCDMA Band V	826.4MHz ~ 846.6MHz
	LTE Band 5 (Channel Bandwidth: 1.4MHz)	824.7 MHz ~ 848.3 MHz
	LTE Band 5 (Channel Bandwidth: 3MHz)	825.5 MHz ~ 847.5 MHz
	LTE Band 5 (Channel Bandwidth: 5MHz)	826.5 MHz ~ 846.5 MHz
	LTE Band 5 (Channel Bandwidth: 10MHz)	829.0 MHz ~ 844.0 MHz

Max. ERP Power	GSM/GPRS	GMSK	32.38	dBm
	EDGE	8PSK	27.06	dBm
	WCDMA	QPSK	23.77	dBm
	WCDMA_HSDPA	16QAM	23.83	dBm
	WCDMA_HSUPA	16QAM	23.91	dBm
	LTE Band 5 (Channel Bandwidth: 1.4MHz)	QPSK	23.34	dBm
		16QAM	22.62	dBm
	LTE Band 5 (Channel Bandwidth: 3MHz)	QPSK	23.38	dBm
		16QAM	22.76	dBm
	LTE Band 5 (Channel Bandwidth: 5MHz)	QPSK	23.67	dBm
		16QAM	23.08	dBm
	LTE Band 5 (Channel Bandwidth: 10MHz)	QPSK	23.70	dBm
16QAM		23.18	dBm	
Power Source	DC Voltage supplied from AC/DC adapter (support unit).			
Power Rating	I/P: 100-240V ~50/60Hz O/P: 12V === 2A EUT: 4V ===			

Note:

1. For a more detailed features description, please refer to the manufacturer's specifications or the user's manual.

3.2 DESCRIPTION OF TEST MODES AND TEST CONDITION

Pre-Scan has been conducted to determine the worst-case mode from all possible combinations between available modulations, data rates, XYZ axis and antenna ports
 The worst case was found when positioned on X-plane for EIRP and X-axis for radiated emission.
 Following channel(s) was (were) selected for the final test as listed below:

GSM MODE			
Test Item	Available Channel	Tested Channel	Mode
ERP	128 to 251	128, 190, 251	GSM, GPRS, EDGE
Output Power	128 to 251	128, 190, 251	GSM, GPRS, EDGE
Occupied Bandwidth	128 to 251	128, 190, 251	GSM, EDGE
Conducuted Emission	128 to 251	190	GSM, EDGE
Radiated Emission	128 to 251	190	GSM, EDGE
Band Edge	128 to 251	128, 251	GSM, EDGE
Peak to Average Ratio	128 to 251	128, 190, 251	GSM, EDGE
Frequency Stability	128 to 251	190	GSM

WCDMA MODE			
Test Item	Available Channel	Tested Channel	Mode
ERP	4132 to 4233	4132, 4182, 4233	WCDMA, HSDPA, HSUPA
Output Power	4132 to 4233	4132, 4182, 4233	WCDMA, HSDPA, HSUPA
Conducted Emission	4132 to 4233	4182	WCDMA
Radiated Emission	4132 to 4233	4182	WCDMA
Band Edge	4132 to 4233	4132, 4233	WCDMA, HSDPA, HSUPA
Peak to Average Ratio	4132 to 4233	4132, 4182, 4233	WCDMA, HSDPA, HSUPA
Frequency Stability	4132 to 4233	4182	WCDMA

LTE BAND 5						
Test Item	Available Channel	Tested Channel	Channel Bandwidth	Modulation	Mode	
Output Power & ERP	20407 to 20643	20407, 20525, 20643	1.4MHz	QPSK, 16QAM	1RB/3RB/6RB	
	20415 to 20635	20415, 20525, 20635	3MHz	QPSK, 16QAM	1RB/8RB/15RB	
	20425 to 20625	20425, 20525, 20625	5MHz	QPSK, 16QAM	1RB/12RB/25RB	
	20450 to 20600	20450, 20525, 20600	10MHz	QPSK, 16QAM	1RB/25RB/50RB	
Occupied Bandwidth	20407 to 20643	20407, 20525, 20643	1.4MHz	QPSK, 16QAM	6 RB	
	20415 to 20635	20415, 20525, 20635	3MHz	QPSK, 16QAM	15 RB	
	20425 to 20625	20425, 20525, 20625	5MHz	QPSK, 16QAM	25 RB	
	20450 to 20600	20450, 20525, 20600	10MHz	QPSK, 16QAM	50 RB	
Conducted Emission	20407 to 20643	20525	1.4MHz	QPSK	1 RB	
	20425 to 20625	20525	5MHz	QPSK	1 RB	
	20450 to 20600	20525	10MHz	QPSK	1 RB	
Radiated Emission	20407 to 20643	20525	1.4MHz	QPSK	1 RB	
	20425 to 20625	20525	5MHz	QPSK	1 RB	
	20450 to 20600	20525	10MHz	QPSK	1 RB	
Band Edge	20407 to 20643	20407	1.4MHz	QPSK	1 RB	
		20643	1.4MHz	QPSK	6 RB	
	20415 to 20635	20415	3MHz	QPSK	1 RB	
		20635	3MHz	QPSK	15 RB	
	20425 to 20625	20425	5MHz	QPSK	1 RB	
		20625	5MHz	QPSK	25 RB	
	20450 to 20600	20450	10MHz	QPSK	1 RB	
		20600	10MHz	QPSK	50 RB	
	Peak To Average Ratio	20407 to 20643	20407, 20525, 20643	1.4MHz	QPSK, 16QAM	1 RB
		20415 to 20635	20415, 20525, 20635	3MHz	QPSK, 16QAM	1 RB
		20425 to 20625	20425, 20525, 20625	5MHz	QPSK, 16QAM	1 RB
		20450 to 20600	20450, 20525, 20600	10MHz	QPSK, 16QAM	1 RB
Frequency Stability	20407 to 20643	20525	1.4MHz	QPSK	1 RB	
	20415 to 20635	20525	3MHz	QPSK	1 RB	
	20425 to 20625	20525	5MHz	QPSK	1 RB	
	20450 to 20600	20525	10MHz	QPSK	1 RB	

EUT TEST CONDITIONS:

Test Item	Environmental Conditions	Test Voltage
ERP	24.5°C, 53%RH	DC 4.0V
Output Power	24.5°C, 53%RH	DC 4.0V
Occupied Bandwidth	24.5°C, 53%RH	DC 4.0V
Conducted Emission	24.5°C, 53%RH	DC 4.0V
Radiated Emission	24°C, 68%RH	AC 120V/60Hz
Band Edge	24.5°C, 53%RH	DC 4.0V
Peak to Average Ratio	24.5°C, 53%RH	DC 4.0V
Frequency Stability	Normal and Extreme	Normal and Extreme

3.3 BLOCK DIGRAM SHOWING THE CONFIGURATIONOFSYSTEMTESTED

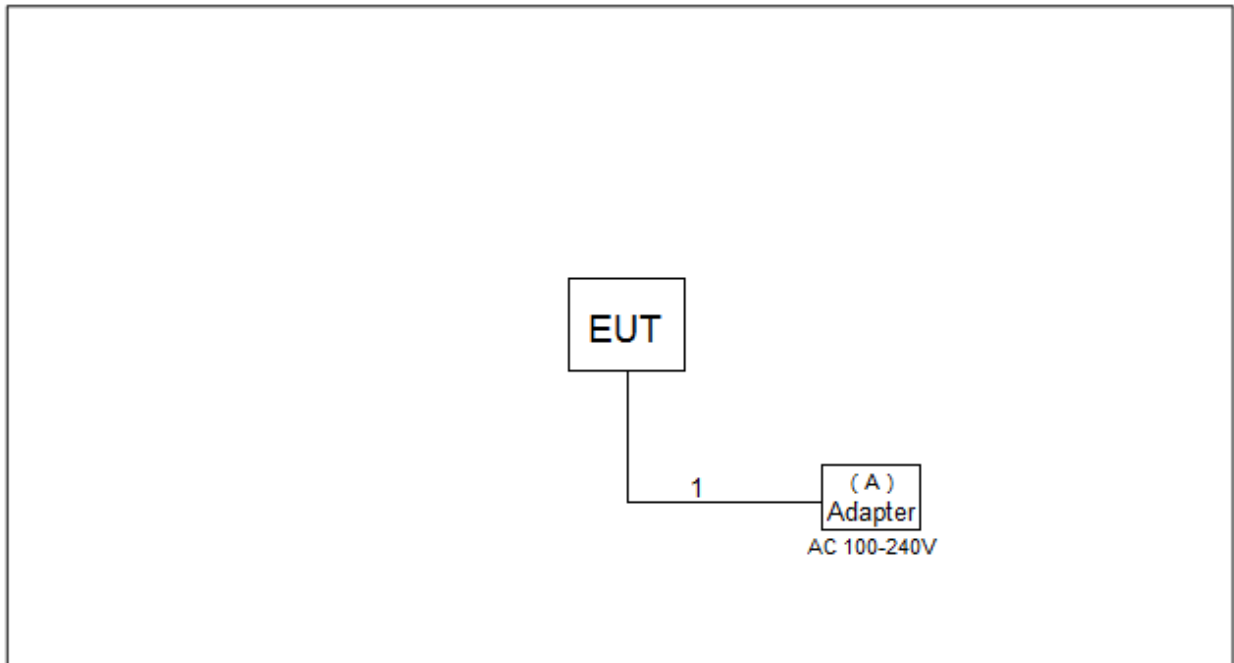

3.4 DESCRIPTION OF SUPPORT UNITS

The EUT has been tested as an independent unit together with other necessary accessories or support units. The following support units or accessories were used to form a representative test configuration during the tests.

Item	Equipment	Mfr/Brand	Model/Type No.	Series No.
-	-	-	-	-

Item	Cable Type	Shielded Type	Ferrite Core	Length
A	DC Cable	NO	NO	1.5m

4. TEST RESULT

4.1 OUTPUT POWER MEASUREMENT

4.1.1 LIMIT

Mobile / Portable station are limited to 7 watts e.r.p.

4.1.2 TEST PROCEDURE

EIRP/ ERP:

1. EIRP= Output Power +Antenan gain
ERP power= EIPR power-2.15dBi.

Output Power:

The EUT was set up for the maximum power with GSM, GPRS, EDGE, WCDMA and LTE link data modulation and link up with simulator. Set the EUT to transmit under low, middle and high channel and record the power level shown on simulator.

4.1.3 TEST SETUP LAYOUT

Output Power Measurement

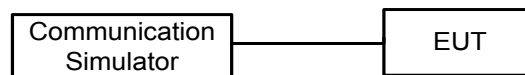

4.1.4 TEST DEVIATION

No deviation

4.1.5 TEST RESULTS

Please refer to the Appendix A.

4.2 OCCUPIED BANDWIDTH MEASUREMENT

4.2.1 TEST PROCEDURE

The EUT makes a call to the communication simulator. All measurements were done at low, middle and high operational frequency range. The communication simulator station system controlled a EUT to export maximum output power under transmission mode and specific channel frequency. Use OBW measurement function of Spectrum analyzer to measure 99 % occupied bandwidth and 26dB bandwidth.

4.2.2 TEST SETUP LAYOUT

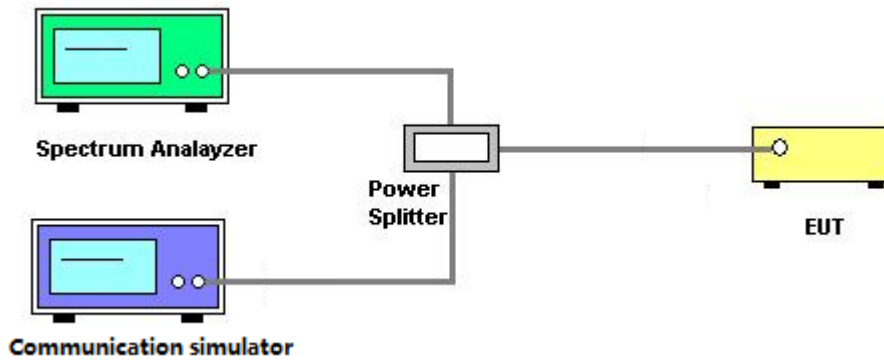

4.2.3 TEST DEVIATION

No deviation

4.2.4 TEST RESULTS

Please refer to the Appendix B.

4.3 CONDUCTED EMISSIONS MEASUREMENT

4.3.1 LIMIT

The power of any emission outside of the authorized operating frequency ranges must be attenuated below the transmitting power (P) by a factor of at least $43 + 10 \log(P)$ dB. The emission limit equal to -13dBm .

4.3.2 TEST PROCEDURES

1. The testing follows FCC KDB 971168 v03r01 Section 6.0.
2. The EUT was connected to spectrum analyzer and system simulator via a power divider.
3. The band edges of low and high channels for the highest RF powers were measured. Set $\text{RBW} \geq 1\%$ EBW in the 1MHz band immediately outside and adjacent to the band edge.
4. Set spectrum analyzer with RMS detector.
5. The RF fundamental frequency should be excluded against the limit line in the operating frequency band.

4.3.3 TEST SETUP LAYOUT

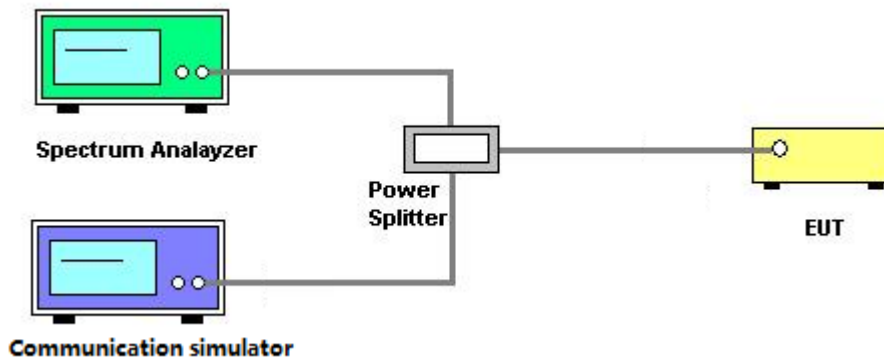

4.3.4 TEST DEVIATION

No deviation

4.3.5 TEST RESULTS

Please refer to the Appendix C.

4.4 RADIATED EMISSIONS MEASUREMENT

4.4.1 LIMIT

The power of any emission outside of the authorized operating frequency ranges must be attenuated below the transmitting power (P) by a factor of at least $43 + 10 \log(P)$ dB. The emission limit equal to -13dBm.

4.4.2 TEST PROCEDURES

1. Substitution method is used for E.I.R.P measurement. In the semi-anechoic chamber, EUT placed on the 0.8m height of Turn Table, rotated the table around 360 degrees to search the maximum radiation power and receiver antenna shall be rotated vertical and horizontal polarization and moved height from 1m to 4m to find the maximum polar radiated power. The "Read Value" is the spectrum reading the maximum power value.
2. The substitution horn antenna is substituted for EUT at the same position and signals generator export the CW signal to the substitution antenna via a TX cable. Rotated the Turn Table and moved receiving antenna to find the maximum radiation power. Adjust output power level of S.G to get a Value of spectrum reading equal to "Read Value " of step a. Record the power level of S.G
3. EIRP = Output power level of S.G – TX cable loss + Antenna gain of substitution horn.
4. E.R.P power can be calculated form E.I.R.P power by subtracting the gain of dipole, E.R.P power = E.I.P.R power - 2.15dBi.
5. The resolution bandwidth and video bandwidth of test receiver/spectrum analyzer is 1MHz/3MHz.

4.4.3 TEST SETUP LAYOUT

Below 30MHz

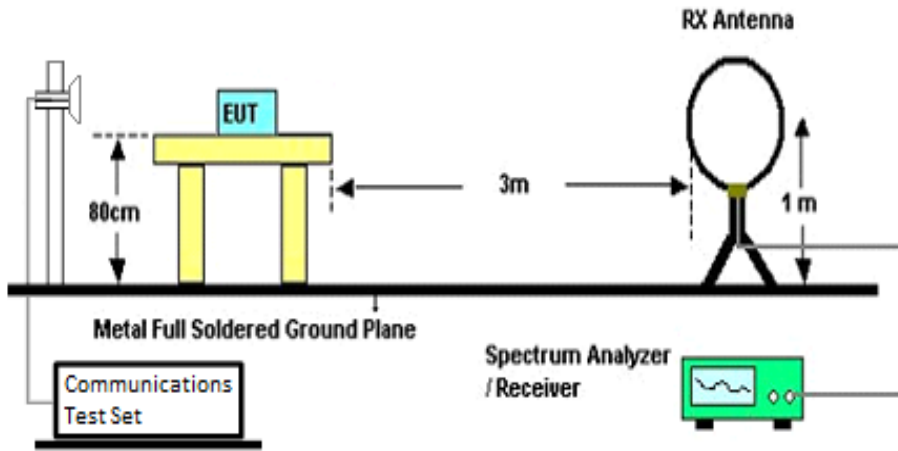

30MHz to 1GHz

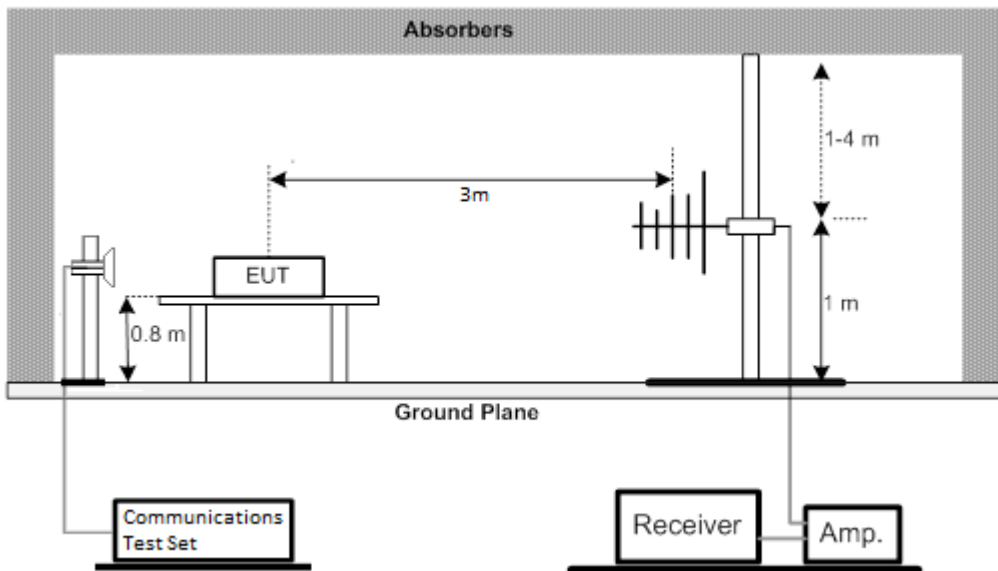

1GHz to 18GHz

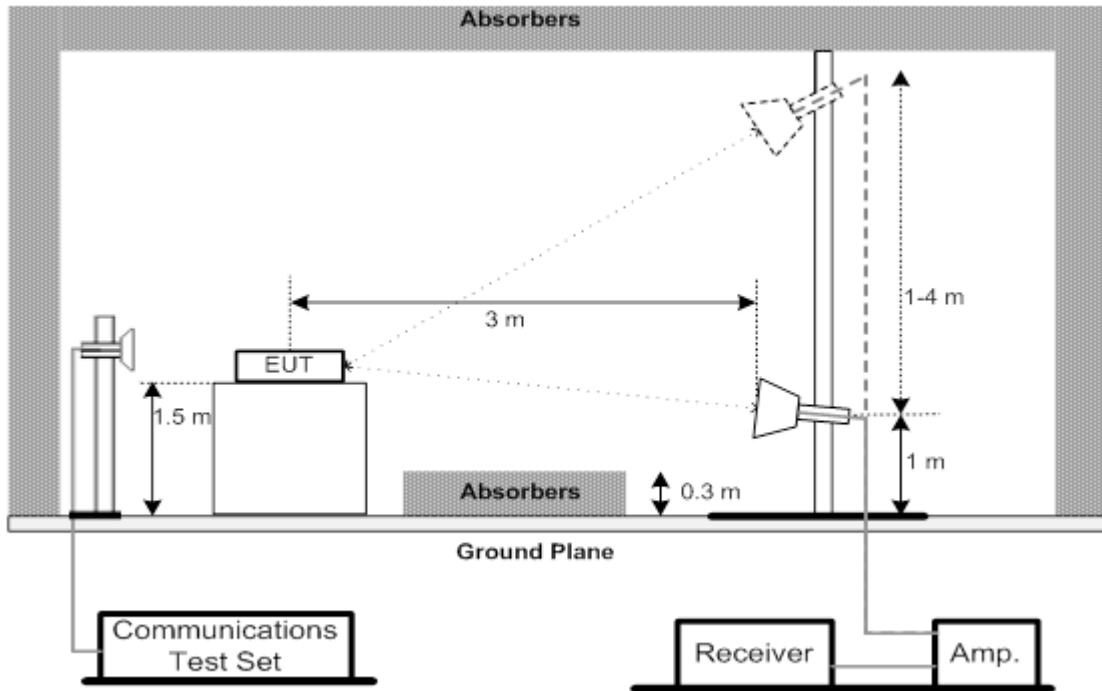

Above 18GHz

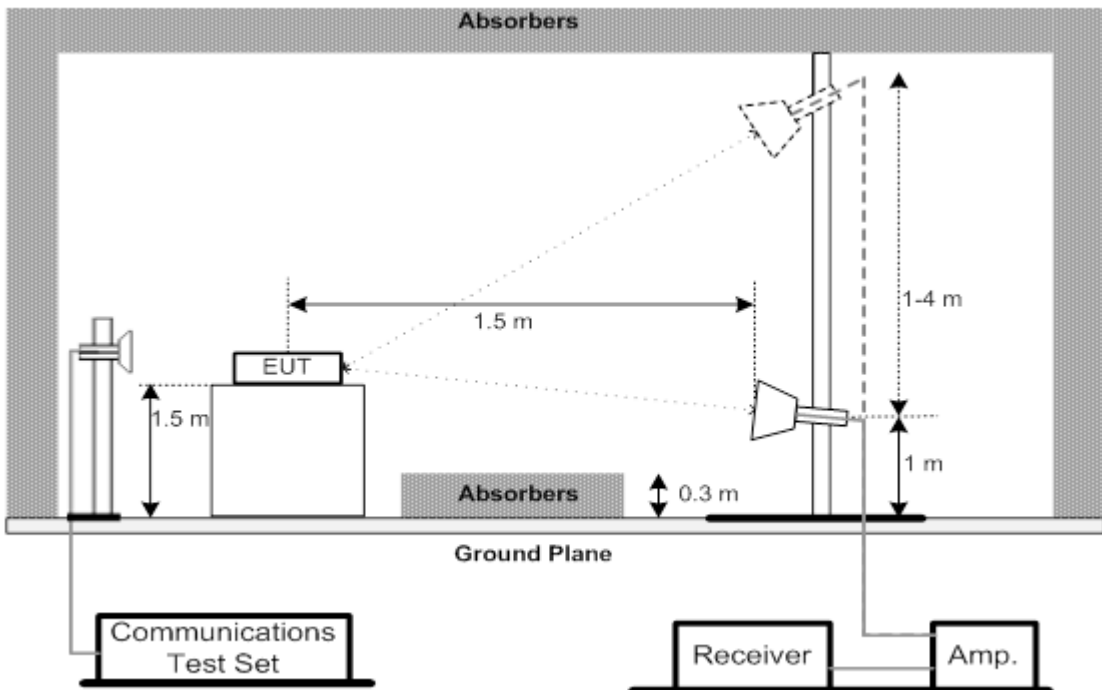

4.4.4 TEST DEVIATION

No deviation

4.4.5 TEST RESULTS (9KHZ TO 30MHZ)

Please refer to the Appendix D.

4.4.6 TEST RESULTS (30MHZ TO 1000MHZ)

Please refer to the Appendix E.

4.4.7 TEST RESULTS (ABOVE 1000MHZ)

Please refer to the Appendix F.

4.5 BAND EDGE MEASUREMENT

4.5.1 LIMIT

A Power of any emission outside of the authorized operating frequency ranges must be attenuated below the transmitting power (P) by a factor of at least $43 + 10 \log(P)$ dB. In the 1 MHz bands immediately outside and adjacent to the frequency block a resolution bandwidth of at least one percent of the emission bandwidth of the fundamental emission of the transmitter may be employed.

4.5.2 TEST PROCEDURES

1. All measurements were done at low and high operational frequency range.
2. The center frequency of spectrum is the band edge frequency and span is 1.5MHz. RB of the spectrum is 3kHz and VB of the spectrum is 10kHz (GSM/GPRS/EDGE).
3. The center frequency of spectrum is the band edge frequency and span is 10MHz. RB of the spectrum is 100kHz and VB of the spectrum is 300kHz (WCDMA).
4. The center frequency of spectrum is the band edge frequency and span is 2MHz. RB of the spectrum is 15kHz and VB of the spectrum is 43kHz (LTE Bandwidth 1.4MHz).
5. The center frequency of spectrum is the band edge frequency and span is 2MHz. RB of the spectrum is 30kHz and VB of the spectrum is 91kHz (LTE Bandwidth 3MHz).
6. The center frequency of spectrum is the band edge frequency and span is 2MHz. RB of the spectrum is 51kHz and VB of the spectrum is 150kHz (LTE Bandwidth 5MHz).
7. The center frequency of spectrum is the band edge frequency and span is 2MHz. RB of the spectrum is 100kHz and VB of the spectrum is 300kHz (LTE Bandwidth 10MHz).
8. The center frequency of spectrum is the band edge frequency and span is 2MHz. RB of the spectrum is 150kHz and VB of the spectrum is 470kHz (LTE Bandwidth 15MHz).
9. The center frequency of spectrum is the band edge frequency and span is 2MHz. RB of the spectrum is 200kHz and VB of the spectrum is 620kHz (LTE Bandwidth 20MHz).

4.5.3 TEST SETUP LAYOUT

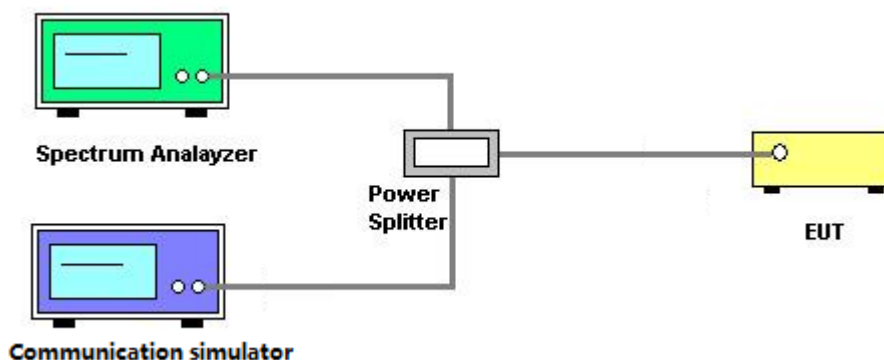

4.5.4 TEST DEVIATION

No deviation

4.5.5 TEST RESULTS

Please refer to the Appendix G.

4.6 PEAK TO AVERAGE RATIO MEASUREMENT

4.6.1 LIMIT

In measuring transmissions in this band using an average power technique, the peak to-average ratio (PAR) of the transmission may not exceed 13 dB.

4.6.2 TEST PROCEDURES

1. Set resolution/measurement bandwidth \geq signal's occupied bandwidth;
2. Set the number of counts to a value that stabilizes the measured CCDF curve;
3. Record the maximum PAPR level associated with a probability of 0.1%.

4.6.3 TEST SETUP LAYOUT

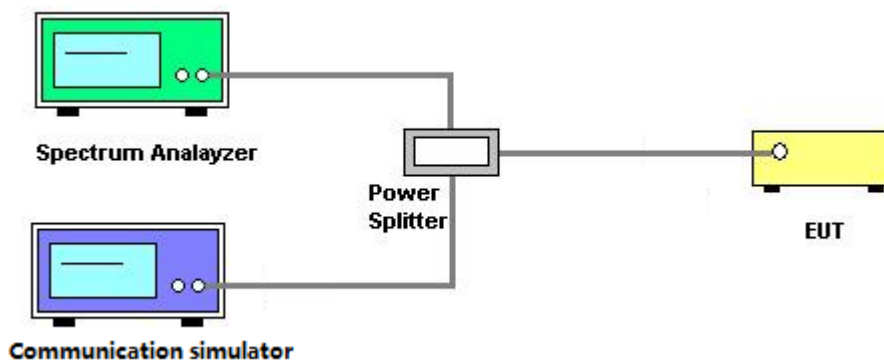

4.6.4 TEST DEVIATION

No deviation

4.6.5 TEST RESULTS

Please refer to the Appendix H.

4.7 FREQUENCY STABILITY MEASUREMENT

4.7.1 LIMIT

± 1.5 ppm is for base and fixed station. ± 2.5 ppm is for mobile station.

4.7.2 TEST PROCEDURES

1. Device is placed at the oven room. The oven room could control the temperatures and humidity. Power warm up is at least 15 min and power applied should perform before recording frequency error.
2. EUT is connected the external power supply to control the DC input power. The test voltage range is from minimum to maximum working voltage. Each step shall be record the frequency error rate.
3. The temperature range step is 10 degrees in this test items. All temperature levels shall be hold the $\pm 0.5^{\circ}\text{C}$ during the measurement testing. The each temperature step shall be at least 0.5 hours, consider the EUT could be test under the stability condition.
4. The frequency error was recorded frequency error from the communication simulator.

4.7.3 TEST SETUP LAYOUT

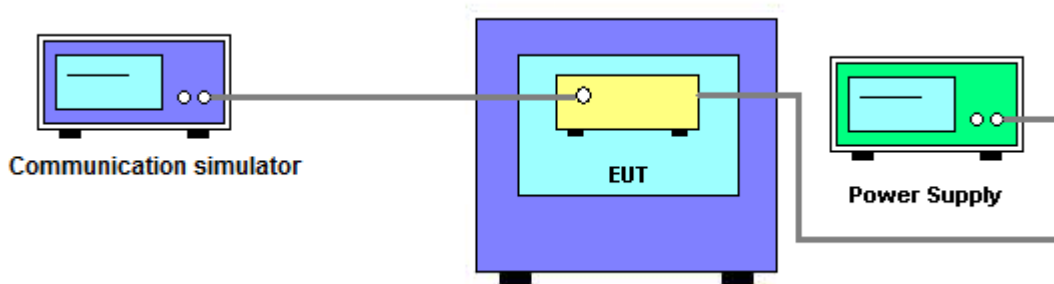

4.7.4 TEST DEVIATION

No deviation

4.7.5 TEST RESULTS

Please refer to the Appendix I.

5. LIST OF MEASUREMENT EQUIPMENTS

Radiated Emission Measurement					
Item	Kind of Equipment	Manufacturer	Type No.	Serial No.	Calibrated until
1	Antenna	Schwarzbeck	VULB9160	9160-3232	Mar. 09, 2020
2	Amplifier	Agilent	8449B	3008A02274	Mar. 10, 2020
3	Amplifier	HP	8447D	2944A09673	Aug. 11, 2019
4	HighPass Filter	Wairwright Instruments Gmbh	WHK 1.5/15G-10ST	11	Mar. 10, 2020
5	Band Reject Filter	Wairwright Instruments Gmbh	WRCG 1710/1785-1690/180 5-60/12SS	38	Mar. 10, 2020
6	Band Reject Filter	Wairwright Instruments Gmbh	WRCG 824/849-810/863-60/ 9SS	7	Mar. 10, 2020
7	Band Reject Filter	Wairwright Instruments Gmbh	WRCG 880/915-860/935-60/ 9SS	14	Mar. 10, 2020
8	Band Reject Filter	Wairwright Instruments Gmbh	WRCG 1850/1910-1830/193 0-60/10SS	17	Mar. 10, 2020
9	HighPass Filter	Wairwright Instruments Gmbh	WHK3.1/18G-10SS	24	Mar. 10, 2020
10	Wireless Communication Test SET	Agilent	E5515C	MY48364183	Mar. 10, 2020
11	Microwave Preamplifier With Adaptor	EMC INSTRUMENT	EMC2654045	980039 & HA01	Mar. 10, 2020
12	Receiver	Agilent	N9038A	MY52130039	Aug. 11, 2019
13	wideband radio communication tester	R&S	CMW500	152372	Mar. 10, 2020
14	High pass filter	KANGMAIWEI	ZHPF-M3-12.75G-38 69	B2015073763	Feb. 12, 2020
15	High pass filter	KANGMAIWEI	ZHPF-M1000-4000-1	B2015073762	Feb. 12, 2020
16	High pass filter	KANGMAIWEI	ZHPF-M6-186-1727	B2015073764	Feb. 12, 2020
17	Cable	emci	LMR-400(30MHz-1G Hz)(8m+5m)	N/A	May 24, 2020
18	Cable	mitron	B10-01-01-12M	18072744	Jun. 29, 2020
19	Controller	ETS-Lindgren	2090	N/A	N/A
20	Measurement Software	Farad	EZ-EMC Ver.NB-03A1-01	N/A	N/A
21	Loop Antenna	EM	EM-6876-1	230	Jan. 15, 2020
22	Double Ridged Guide Antenna	ETS	3115	75789	Mar. 09, 2020
23	Broad-Band Horn Antenna	Schwarzbeck	BBHA 9170	9170319	Jun. 23, 2020

Conducted Emission & Band Edge & Occupied Bandwidth Measurement

Item	Kind of Equipment	Manufacturer	Type No.	Serial No.	Calibrated until
1	Wireless Communication Test SET	Agilent	E5515C	MY48364183	Mar. 10, 2020
2	EXA Spectrum Analyzer	Agilent	N9010A	MY50520044	Mar. 10, 2020
3	POWER SPLITTER	Mini-Circuits	ZFRSC-123-S+	331000910-1	Mar. 10, 2020
4	wideband radio communication tester	R&S	CMW500	152372	Mar. 10, 2020
5	Spectrum Analyzer	R&S	FSP40	100185	Aug. 11, 2019

Frequency Stability Measurement

Item	Kind of Equipment	Manufacturer	Type No.	Serial No.	Calibrated until
1	Wireless Communication Test SET	Agilent	E5515C	MY48364183	Mar. 10, 2020
2*	Multi-output DC Power Supply	GW Instek	GPC-3030DN	EK880675	Sep. 26, 2020
3	POWER SPLITTER	Mini-Circuits	ZFRSC-123-S+	331000910-1	Mar. 10, 2020
4	wideband radio communication tester	R&S	CMW500	152372	Mar. 10, 2020
5	Const Temp, & Humidity Chamber	Bell	BTH-50C	20170306001	Mar. 10, 2020

Remark: "N/A" denotes no model name, serial no. or calibration specified.

All calibration period of equipment list is one year.

* All calibration period of equipment list is three year.

APPENDIX A - OUTPUT POWER

Output Power (dBm):

GSM850		Burst Output Power		
		128CH	190CH	251CH
		824.2MHz	836.6MHz	848.8MHz
GSM (CS)		31.85	31.94	32.00
GPRS/EDGE (GMSK)	1 Tx Slot	31.85	31.98	32.03
	2 Tx Slot	29.44	29.63	29.65
	3 Tx Slot	28.42	28.46	28.57
	4 Tx Slot	26.37	26.40	26.41
EDGE (8PSK)	1 Tx Slot	26.57	26.65	26.71
	2 Tx Slot	24.31	24.55	24.81
	3 Tx Slot	23.69	23.87	23.98
	4 Tx Slot	21.33	21.70	21.88

Modulation	Band	WCDMA V		
	Tx Channel	4132CH	4182CH	4233CH
	Frequency	826.4MHz	836.4MHz	846.6MHz
QPSK	RMC 12.2K	23.33	23.42	23.38
	RMC 64K	23.32	23.38	23.37
	RMC 144K	23.25	23.36	23.33
	RMC 384K	23.29	23.37	23.3
16QAM	HSDPA Subtest-1	23.25	23.36	23.35
	HSDPA Subtest-2	23.33	23.48	23.43
	HSDPA Subtest-3	22.75	22.88	22.81
	HSDPA Subtest-4	22.79	22.87	22.87
	HSUPA Subtest-1	21.36	21.64	21.74
	HSUPA Subtest-2	20.45	20.4	20.77
	HSUPA Subtest-3	20.82	20.95	20.97
	HSUPA Subtest-4	20.19	20.59	20.18
	HSUPA Subtest-5	23.42	23.56	23.51

LTE Band / BW	Modulation	RB Size	RB Offset	Low CH	Mid CH	High CH
				20407CH	20525CH	20643CH
				824.7MHz	836.5MHz	848.3MHz
5 / 1.4M	QPSK	1	0	22.88	22.57	22.83
		1	2	22.99	22.68	22.83
		1	5	22.90	22.76	22.54
		3	0	22.86	22.62	22.80
		3	1	22.98	22.64	22.77
		3	2	22.95	22.79	22.74
		6	0	22.55	22.38	22.40
	16QAM	1	0	22.06	21.99	22.10
		1	2	22.15	22.15	22.08
		1	5	22.05	22.14	21.84
		3	0	22.19	21.90	22.15
		3	1	22.27	21.88	22.08
		3	2	22.23	21.99	22.09
		6	0	21.83	21.66	21.72

LTE Band / BW	Modulation	RB Size	RB Offset	Low CH	Mid CH	High CH
				20415CH	20525CH	20635CH
				825.5MHz	836.5MHz	847.5MHz
5 / 3M	QPSK	1	0	22.69	22.45	22.76
		1	7	23.03	22.93	22.96
		1	14	22.69	22.71	22.31
		8	0	22.55	22.25	22.38
		8	4	22.73	22.39	22.48
		8	7	22.55	22.40	22.37
		15	0	22.58	22.35	22.44
	16QAM	1	0	22.05	21.78	21.88
		1	7	22.41	22.26	22.10
		1	14	22.03	21.98	21.47
		8	0	21.79	21.51	21.70
		8	4	21.91	21.71	21.76
		8	7	21.80	21.72	21.59
		15	0	21.80	21.65	21.67

LTE Band / BW	Modulation	RB Size	RB Offset	Low CH	Mid CH	High CH
				20425CH	20525CH	20625CH
				826.5MHz	836.5MHz	846.5MHz
5 / 5M	QPSK	1	0	23.11	22.75	23.32
		1	13	22.92	22.80	22.91
		1	24	23.00	23.16	22.85
		12	0	22.50	22.20	22.50
		12	6	22.60	22.27	22.51
		12	11	22.56	22.35	22.47
		25	0	22.57	22.24	22.45
	16QAM	1	0	22.43	22.26	22.73
		1	13	22.30	22.23	22.36
		1	24	22.37	22.62	22.24
		12	0	21.77	21.49	21.79
		12	6	21.84	21.56	21.80
		12	11	21.76	21.70	21.70
		25	0	21.69	21.59	21.64

LTE Band / BW	Modulation	RB Size	RB Offset	Low CH	Mid CH	High CH
				20450CH	20525CH	20600CH
				829.0MHz	836.5MHz	844.0MHz
5 / 10M	QPSK	1	0	23.00	22.63	23.03
		1	25	22.83	22.84	23.22
		1	49	22.62	23.35	22.81
		25	0	22.43	22.06	22.57
		25	13	22.30	22.24	22.50
		25	25	22.03	22.18	22.30
		50	0	22.24	22.21	22.31
	16QAM	1	0	22.43	22.26	22.28
		1	25	22.04	22.34	22.34
		1	49	21.97	22.83	21.89
		25	0	21.56	21.36	21.71
		25	13	21.49	21.59	21.73
		25	25	21.22	21.50	21.53
		50	0	21.39	21.48	21.48

ERP Power (dBm):

GSM850		ERP Power		
		128CH	190CH	251CH
		824.2MHz	836.6MHz	848.8MHz
GSM (CS)		32.20	32.29	32.35
GPRS/EDGE (GMSK)	1 Tx Slot	32.20	32.33	32.38
	2 Tx Slot	29.79	29.98	30.00
	3 Tx Slot	28.77	28.81	28.92
	4 Tx Slot	26.72	26.75	26.76
EDGE (8PSK)	1 Tx Slot	26.92	27.00	27.06
	2 Tx Slot	24.66	24.90	25.16
	3 Tx Slot	24.04	24.22	24.33
	4 Tx Slot	21.68	22.05	22.23

Modulation	Band	WCDMA V		
	Tx Channel	4132CH	4182CH	4233CH
	Frequency	826.4MHz	836.4MHz	846.6MHz
QPSK	RMC 12.2K	23.68	23.77	23.73
	RMC 64K	23.67	23.73	23.72
	RMC 144K	23.60	23.71	23.68
	RMC 384K	23.64	23.72	23.65
16QAM	HSDPA Subtest-1	23.60	23.71	23.70
	HSDPA Subtest-2	23.68	23.83	23.78
	HSDPA Subtest-3	23.10	23.23	23.16
	HSDPA Subtest-4	23.14	23.22	23.22
	HSUPA Subtest-1	21.71	21.99	22.09
	HSUPA Subtest-2	20.80	20.75	21.12
	HSUPA Subtest-3	21.17	21.30	21.32
	HSUPA Subtest-4	20.54	20.94	20.53
HSUPA Subtest-5	23.77	23.91	23.86	

LTE Band / BW	Modulation	RB Size	RB Offset	Low CH	Mid CH	High CH
				20407CH	20525CH	20643CH
				824.7MHz	836.5MHz	848.3MHz
5 / 1.4M	QPSK	1	0	23.23	22.92	23.18
		1	2	23.34	23.03	23.18
		1	5	23.25	23.11	22.89
		3	0	23.21	22.97	23.15
		3	1	23.33	22.99	23.12
		3	2	23.30	23.14	23.09
		6	0	22.90	22.73	22.75
	16QAM	1	0	22.41	22.34	22.45
		1	2	22.50	22.50	22.43
		1	5	22.40	22.49	22.19
		3	0	22.54	22.25	22.50
		3	1	22.62	22.23	22.43
		3	2	22.58	22.34	22.44
		6	0	22.18	22.01	22.07

LTE Band / BW	Modulation	RB Size	RB Offset	Low CH	Mid CH	High CH
				20415CH	20525CH	20635CH
				825.5MHz	836.5MHz	847.5MHz
5 / 3M	QPSK	1	0	23.04	22.80	23.11
		1	7	23.38	23.28	23.31
		1	14	23.04	23.06	22.66
		8	0	22.90	22.60	22.73
		8	4	23.08	22.74	22.83
		8	7	22.90	22.75	22.72
		15	0	22.93	22.70	22.79
	16QAM	1	0	22.40	22.13	22.23
		1	7	22.76	22.61	22.45
		1	14	22.38	22.33	21.82
		8	0	22.14	21.86	22.05
		8	4	22.26	22.06	22.11
		8	7	22.15	22.07	21.94
		15	0	22.15	22.00	22.02

LTE Band / BW	Modulation	RB Size	RB Offset	Low CH	Mid CH	High CH
				20425CH	20525CH	20625CH
				826.5MHz	836.5MHz	846.5MHz
5 / 5M	QPSK	1	0	23.46	23.10	23.67
		1	13	23.27	23.15	23.26
		1	24	23.35	23.51	23.20
		12	0	22.85	22.55	22.85
		12	6	22.95	22.62	22.86
		12	11	22.91	22.70	22.82
		25	0	22.92	22.59	22.80
	16QAM	1	0	22.78	22.61	23.08
		1	13	22.65	22.58	22.71
		1	24	22.72	22.97	22.59
		12	0	22.12	21.84	22.14
		12	6	22.19	21.91	22.15
		12	11	22.11	22.05	22.05
		25	0	22.04	21.94	21.99

LTE Band / BW	Modulation	RB Size	RB Offset	Low CH	Mid CH	High CH
				20450CH	20525CH	20600CH
				829.0MHz	836.5MHz	844.0MHz
5 / 10M	QPSK	1	0	23.35	22.98	23.38
		1	25	23.18	23.19	23.57
		1	49	22.97	23.70	23.16
		25	0	22.78	22.41	22.92
		25	13	22.65	22.59	22.85
		25	25	22.38	22.53	22.65
		50	0	22.59	22.56	22.66
	16QAM	1	0	22.78	22.61	22.63
		1	25	22.39	22.69	22.69
		1	49	22.32	23.18	22.24
		25	0	21.91	21.71	22.06
		25	13	21.84	21.94	22.08
		25	25	21.57	21.85	21.88
		50	0	21.74	21.83	21.83

APPENDIX B - OCCUPIED BANDWIDTH

GSM850					
GSM			EDGE		
CS			8PSK		
Channel	Frequency (MHz)	99% Occupied Bandwidth (MHz)	Channel	Frequency (MHz)	99% Occupied Bandwidth (MHz)
128	824.2	0.2447	128	824.2	0.2506
190	836.6	0.2462	190	836.6	0.2521
251	848.8	0.2423	251	848.8	0.2509
Channel	Frequency (MHz)	26dB Bandwidth (MHz)	Channel	Frequency (MHz)	26dB Bandwidth (MHz)
128	824.2	0.3178	128	824.2	0.3169
190	836.6	0.3195	190	836.6	0.3099
251	848.8	0.3132	251	848.8	0.3214

Spectrum Plot

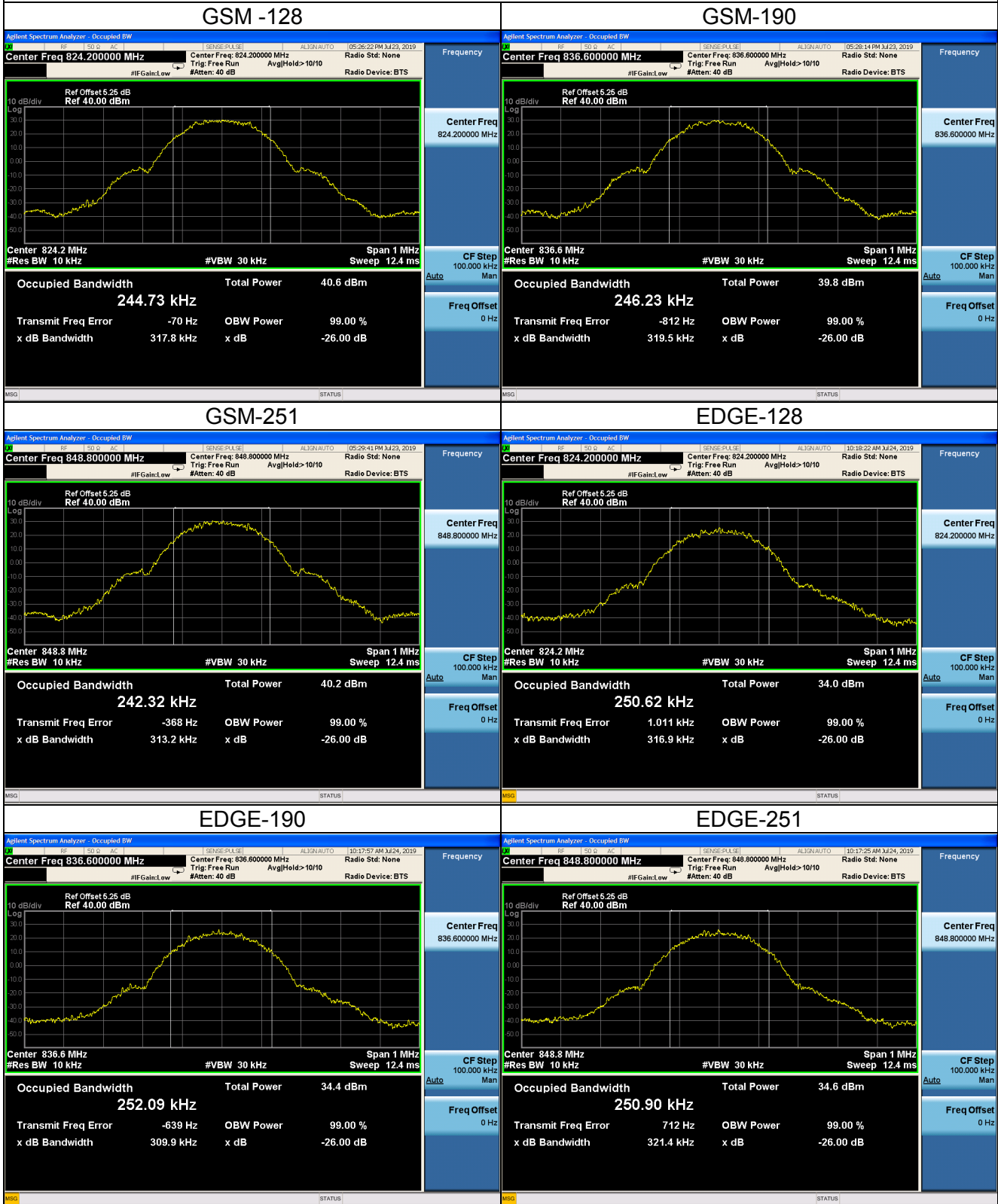

WCDMA Band V

QPSK

Channel	Frequency (MHz)	99% Occupied Bandwidth (MHz)	Channel	Frequency (MHz)	26dB Bandwidth (MHz)
4132	826.4	4.1346	4132	826.4	4.7020
4182	836.4	4.1564	4182	836.4	4.7080
4233	846.6	4.1324	4233	846.6	4.6970

Spectrum Plot

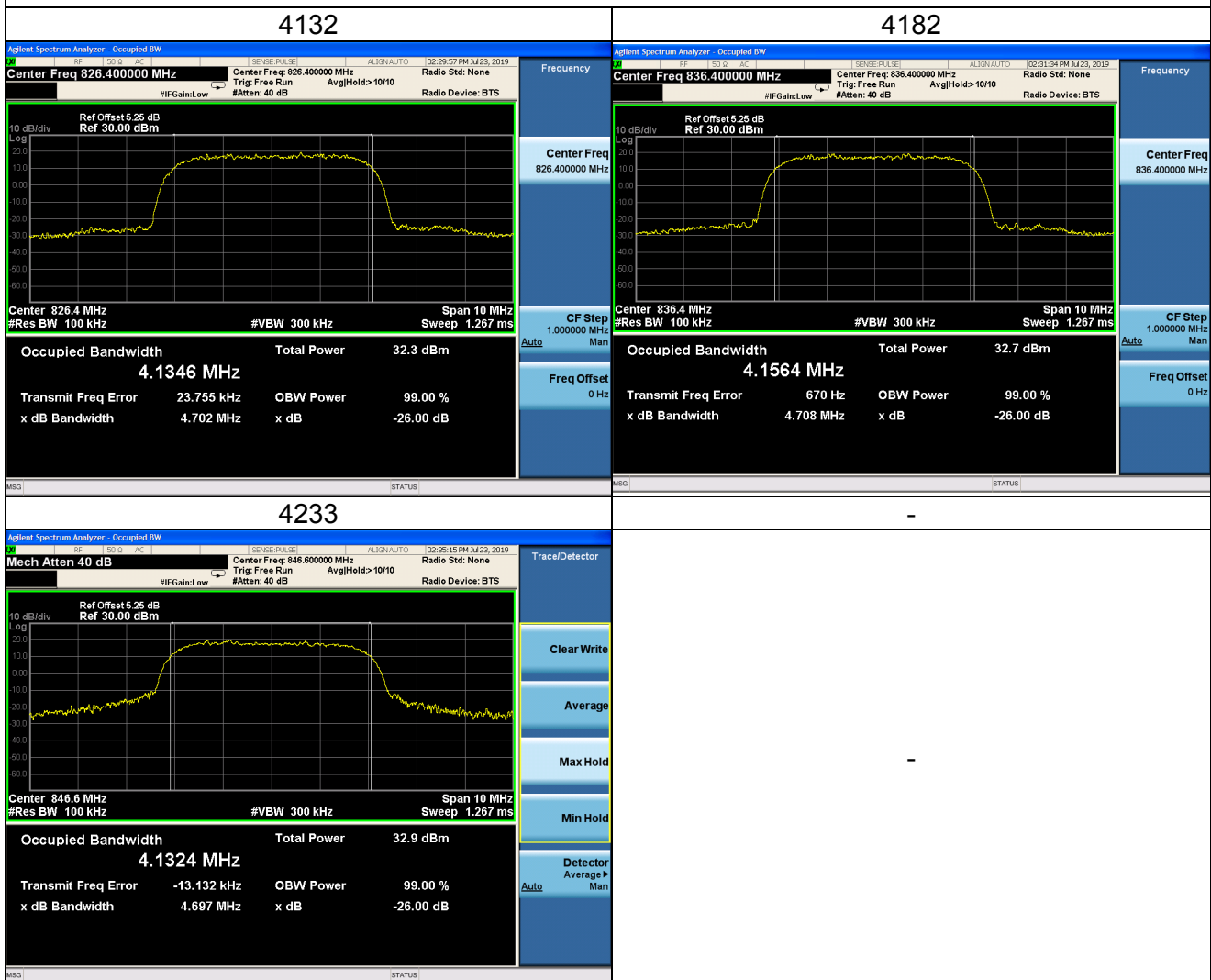

WCDMA_HSDPA Band V

16QAM

Channel	Frequency (MHz)	99% Occupied Bandwidth (MHz)	Channel	Frequency (MHz)	26dB Bandwidth (MHz)
4132	826.4	4.1301	4132	826.4	4.7080
4182	836.4	4.1509	4182	836.4	4.7150
4233	846.6	4.1292	4233	846.6	4.7030

Spectrum Plot

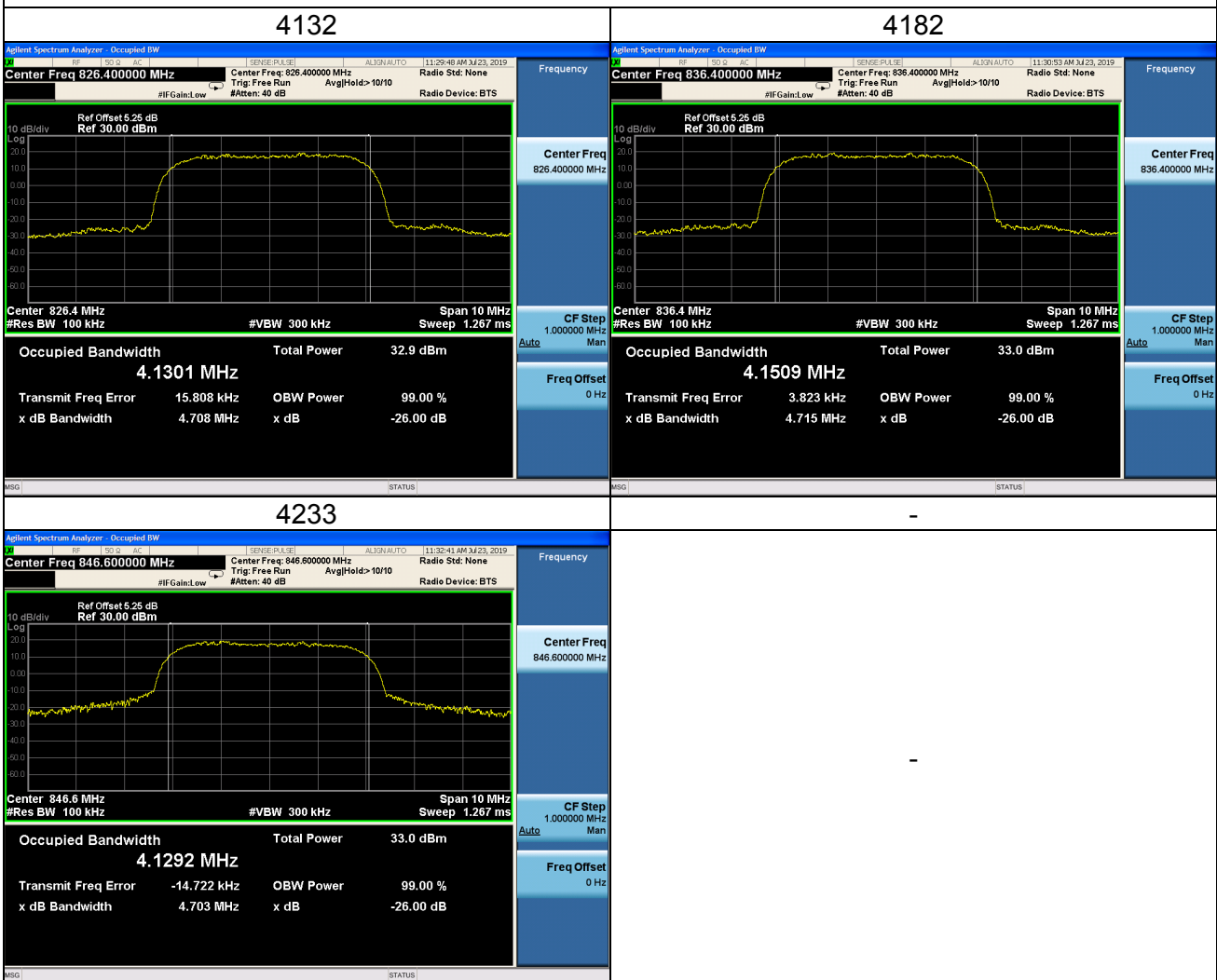

WCDMA_HSUPA Band V

16QAM

Channel	Frequency (MHz)	99% Occupied Bandwidth (MHz)	Channel	Frequency (MHz)	26dB Bandwidth (MHz)
4132	826.4	4.1267	4132	826.4	4.7070
4182	836.4	4.1699	4182	836.4	4.7190
4233	846.6	4.1207	4233	846.6	4.6860

Spectrum Plot

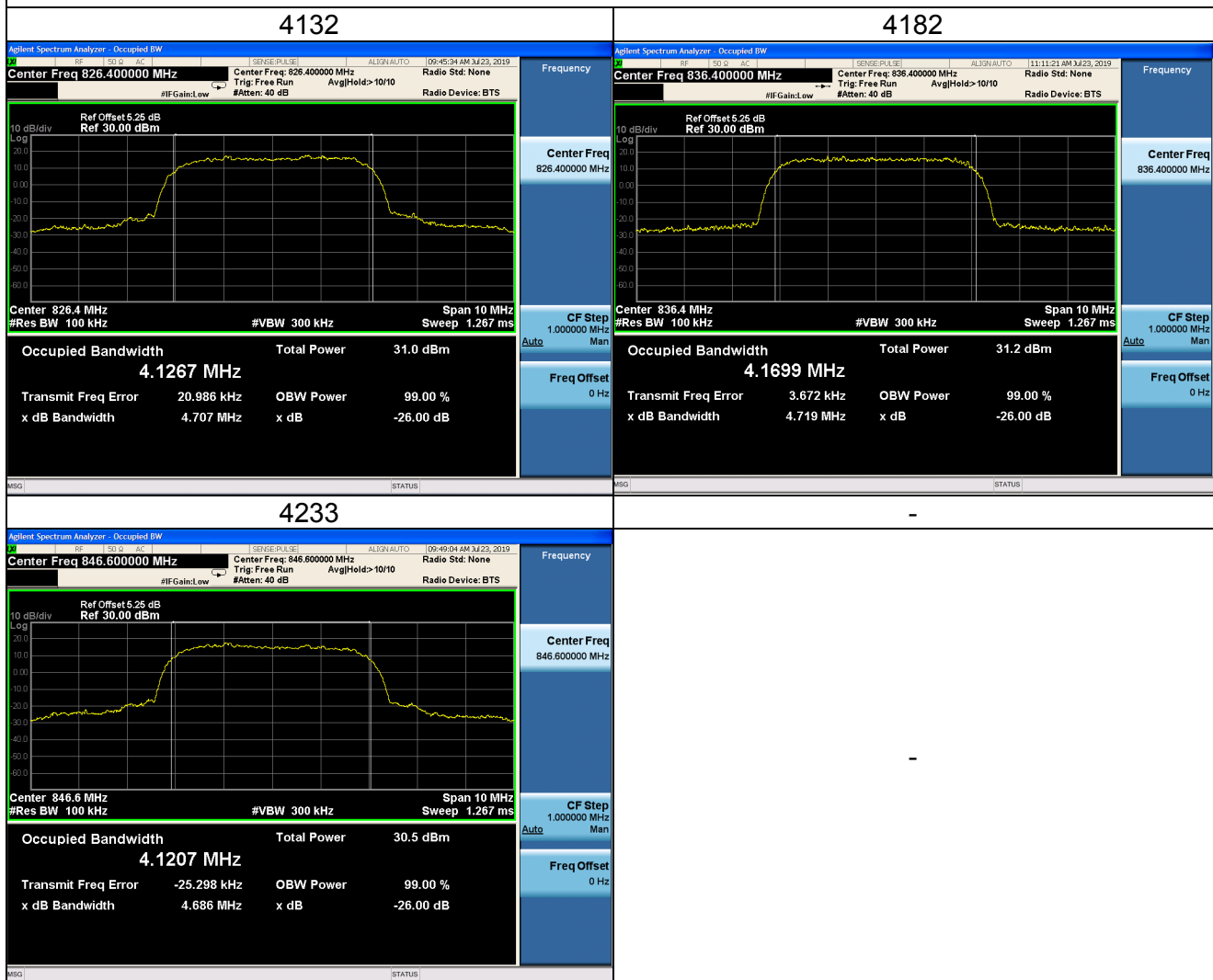

LTE Band 5_1.4M					
QPSK			16QAM		
Channel	Frequency (MHz)	99% Occupied Bandwidth (MHz)	Channel	Frequency (MHz)	99% Occupied Bandwidth (MHz)
20407	824.7	1.0910	20407	824.7	1.0899
20525	836.5	1.0906	20525	836.5	1.0899
20643	848.3	1.0916	20643	848.3	1.0901
Channel	Frequency (MHz)	26dB Bandwidth (MHz)	Channel	Frequency (MHz)	26dB Bandwidth (MHz)
20407	824.7	1.2340	20407	824.7	1.2330
20525	836.5	1.2290	20525	836.5	1.2260
20643	848.3	1.2370	20643	848.3	1.2380

Spectrum Plot

QPSK-20407

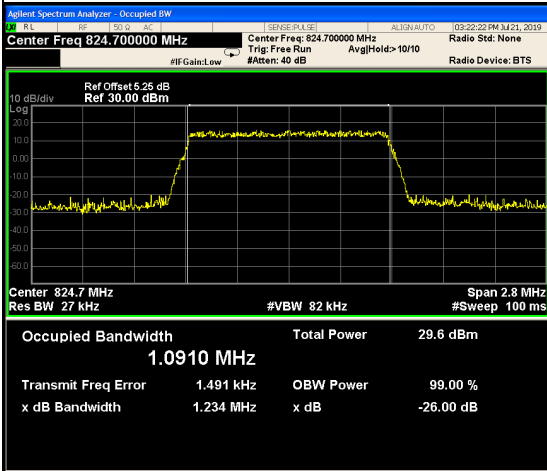

QPSK-20525

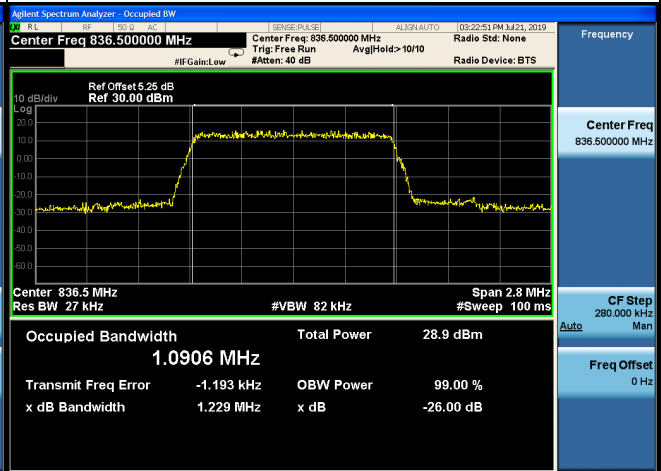

QPSK-20643

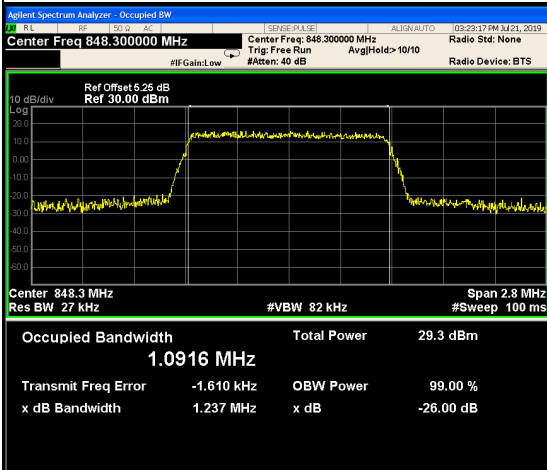

16QAM-20407

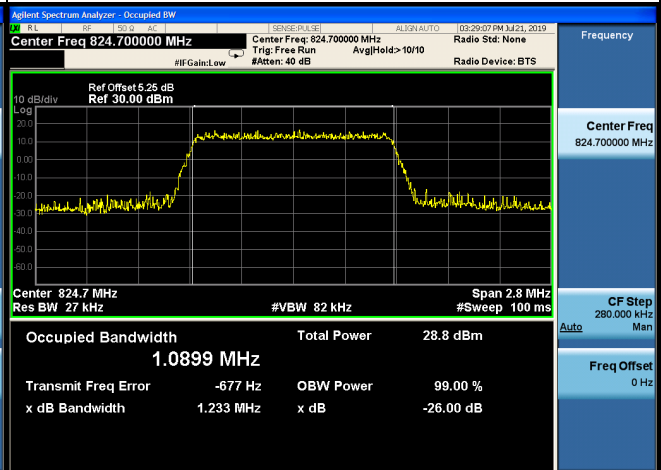

16QAM-20525

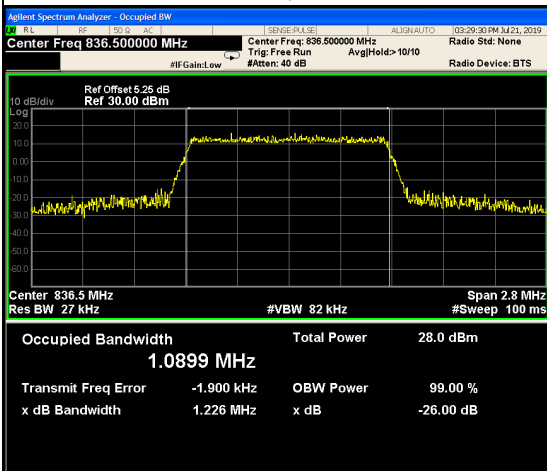

16QAM-20643

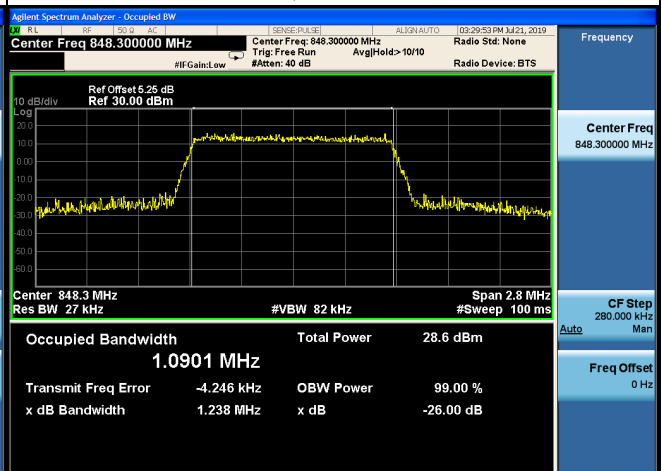

LTE Band 5_3M					
QPSK			16QAM		
Channel	Frequency (MHz)	99% Occupied Bandwidth (MHz)	Channel	Frequency (MHz)	99% Occupied Bandwidth (MHz)
20415	825.5	2.6978	20415	825.5	2.6957
20525	836.5	2.6989	20525	836.5	2.7029
20635	847.5	2.7006	20635	847.5	2.6968
Channel	Frequency (MHz)	26dB Bandwidth (MHz)	Channel	Frequency (MHz)	26dB Bandwidth (MHz)
20415	825.5	2.9530	20415	825.5	2.9770
20525	836.5	2.9490	20525	836.5	2.9570
20635	847.5	2.9440	20635	847.5	2.9520

Spectrum Plot

QPSK-20415

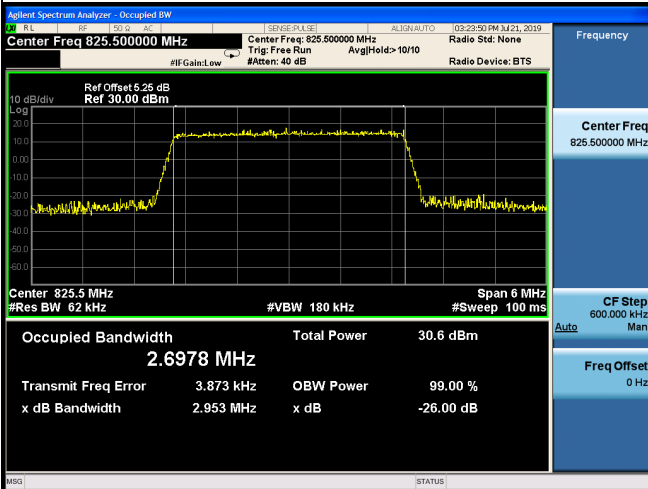

QPSK-20525

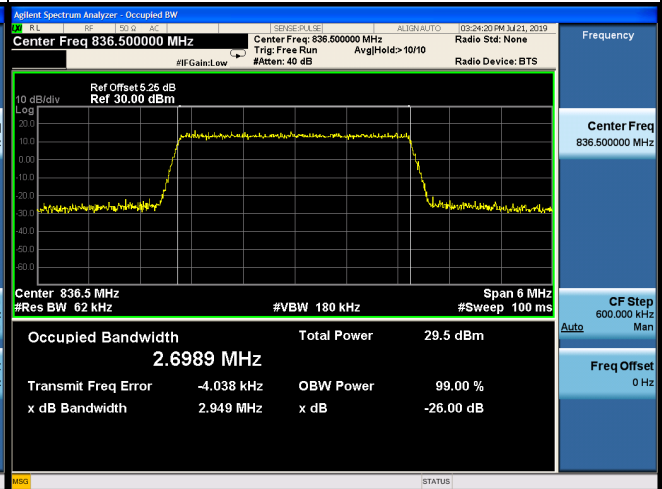

QPSK-20635

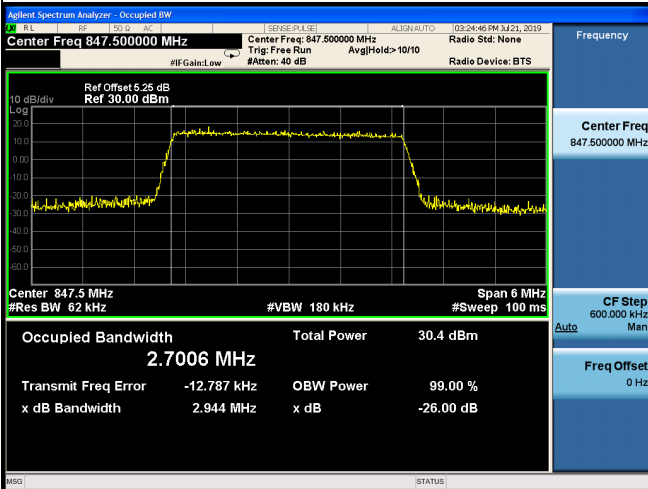

16QAM-20415

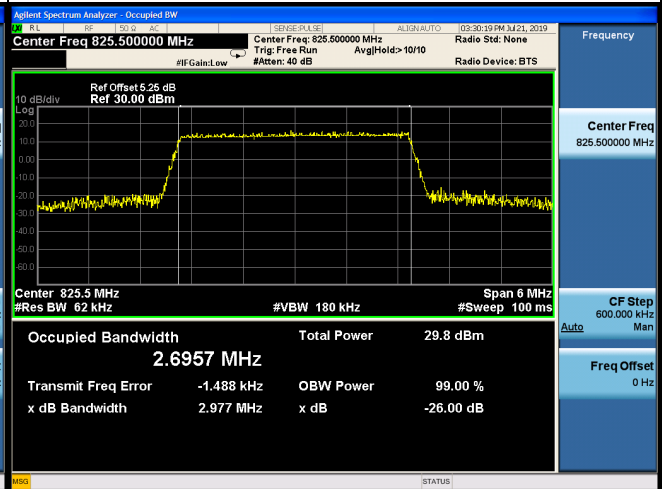

16QAM-20525

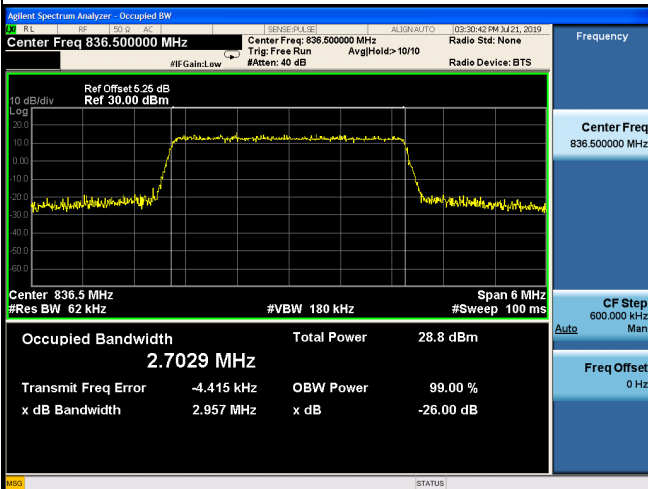

16QAM-20635

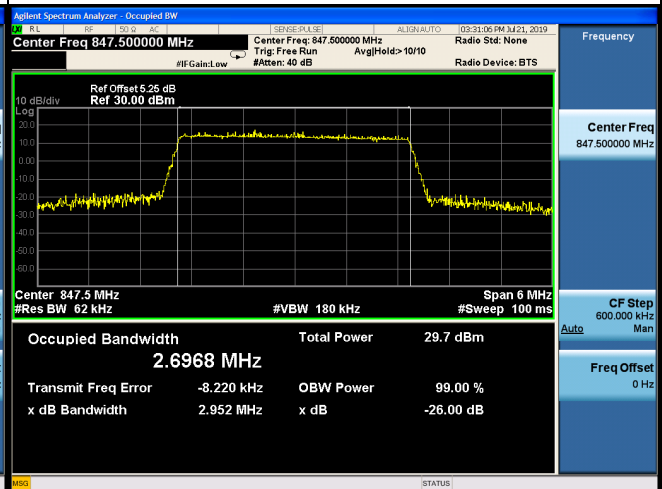

LTE Band 5_5M					
QPSK			16QAM		
Channel	Frequency (MHz)	99% Occupied Bandwidth (MHz)	Channel	Frequency (MHz)	99% Occupied Bandwidth (MHz)
20425	826.5	4.5044	20425	826.5	4.4869
20525	836.5	4.5111	20525	836.5	4.5030
20625	846.5	4.4864	20625	846.5	4.5005
Channel	Frequency (MHz)	26dB Bandwidth (MHz)	Channel	Frequency (MHz)	26dB Bandwidth (MHz)
20425	826.5	4.9180	20425	826.5	4.9260
20525	836.5	4.9400	20525	836.5	4.9520
20625	846.5	4.9230	20625	846.5	4.9280

Spectrum Plot

QPSK-20425

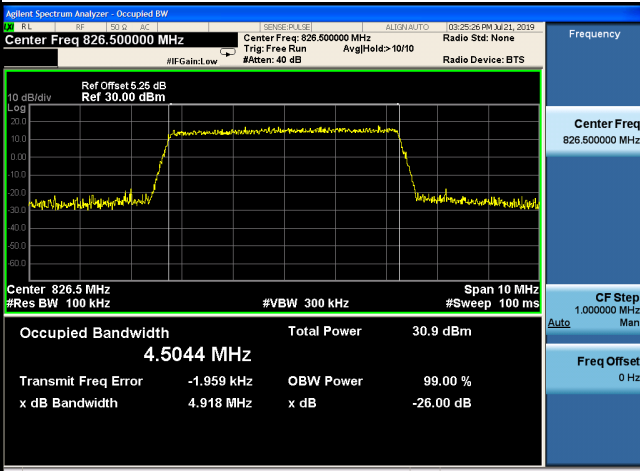

QPSK-20525

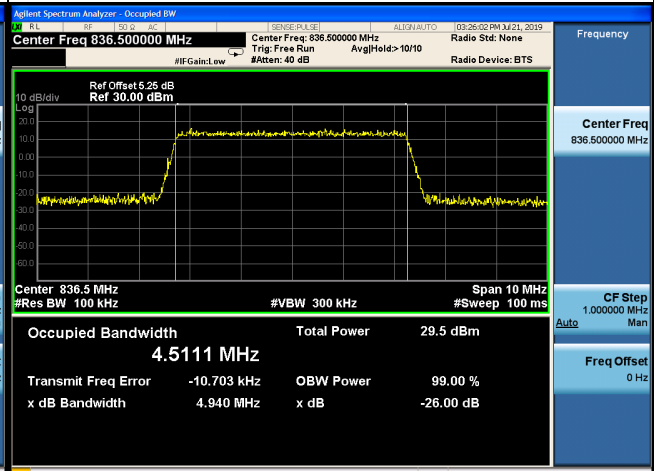

QPSK-20625

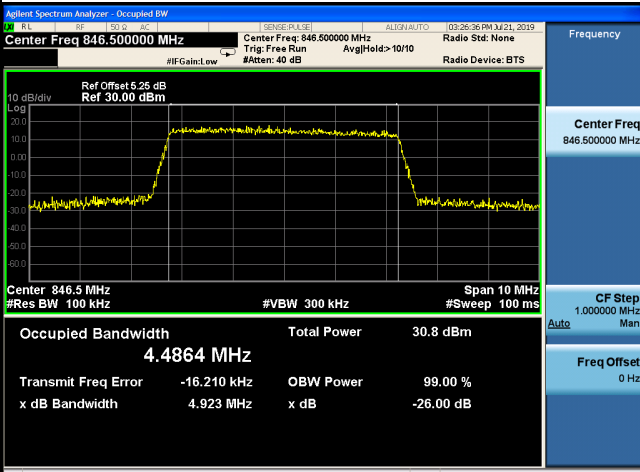

16QAM-20425

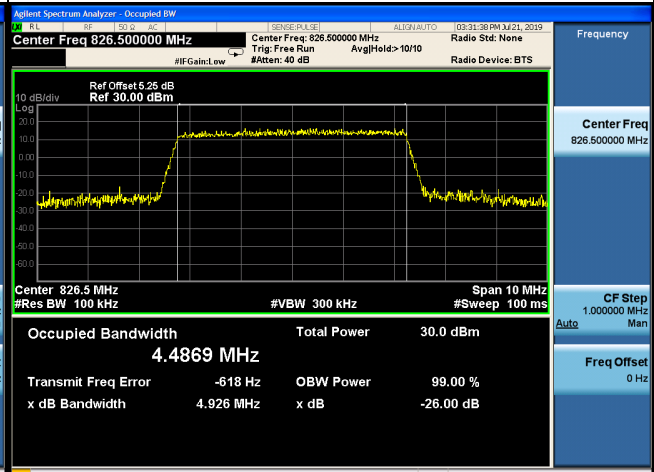

16QAM-20525

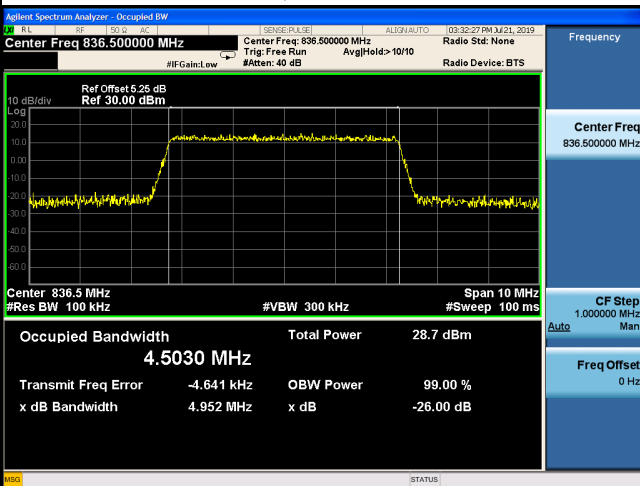

16QAM-20625

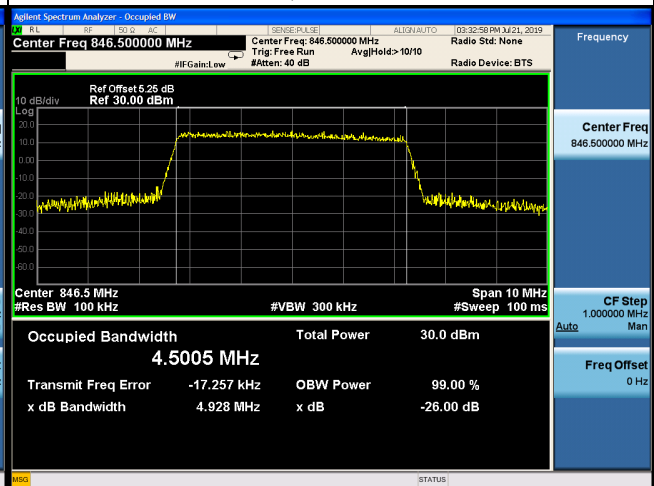

LTE Band 5_10M					
QPSK			16QAM		
Channel	Frequency (MHz)	99% Occupied Bandwidth (MHz)	Channel	Frequency (MHz)	99% Occupied Bandwidth (MHz)
20450	829.0	8.9103	20450	829.0	8.9136
20525	836.5	9.0277	20525	836.5	9.0158
20600	844.0	8.9113	20600	844.0	8.9227
Channel	Frequency (MHz)	26dB Bandwidth (MHz)	Channel	Frequency (MHz)	26dB Bandwidth (MHz)
20450	829.0	9.7510	20450	829.0	9.8240
20525	836.5	9.8410	20525	836.5	9.9360
20600	844.0	9.8440	20600	844.0	9.7670

Spectrum Plot

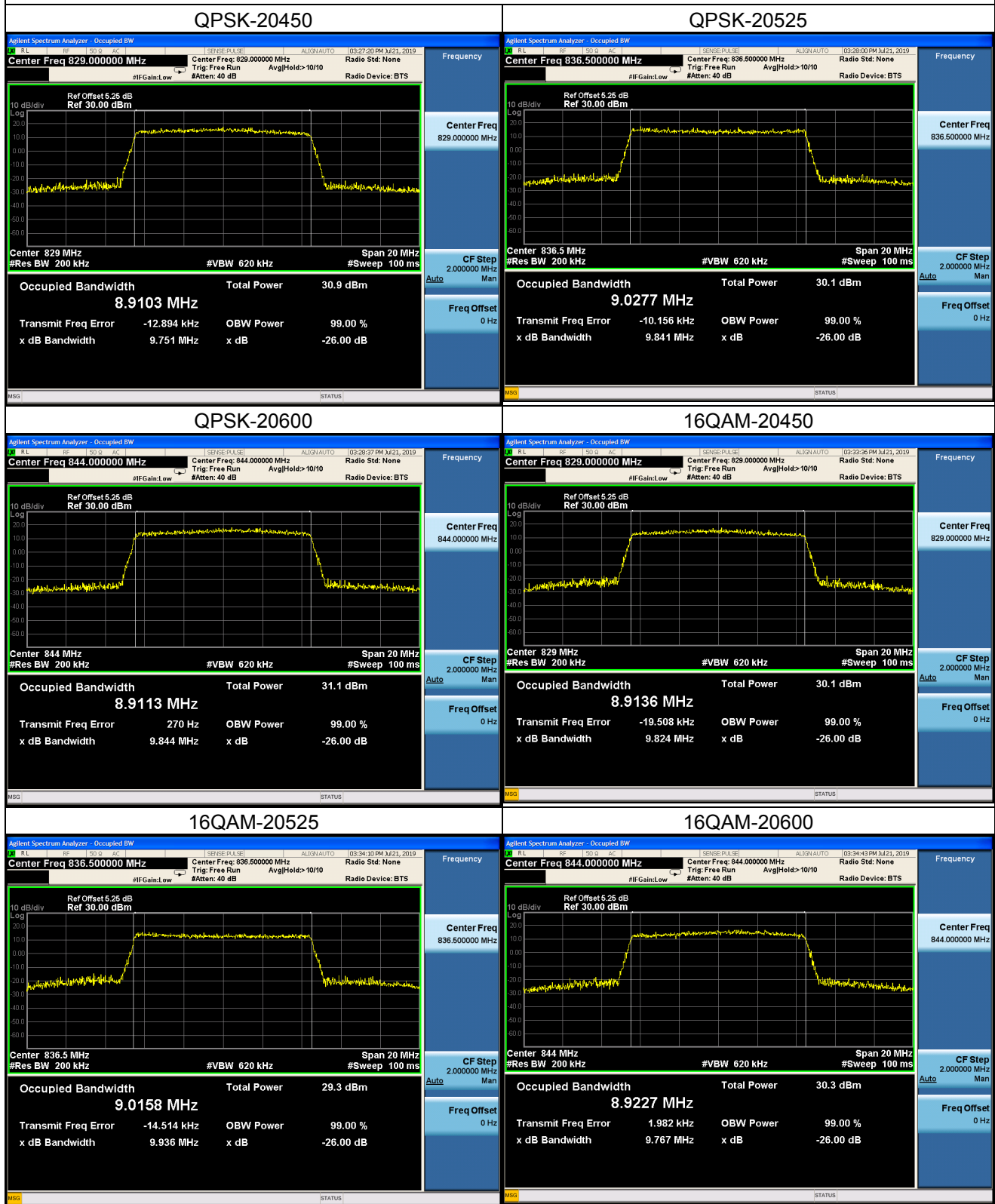

APPENDIX C - CONDUCTED EMISSIONS

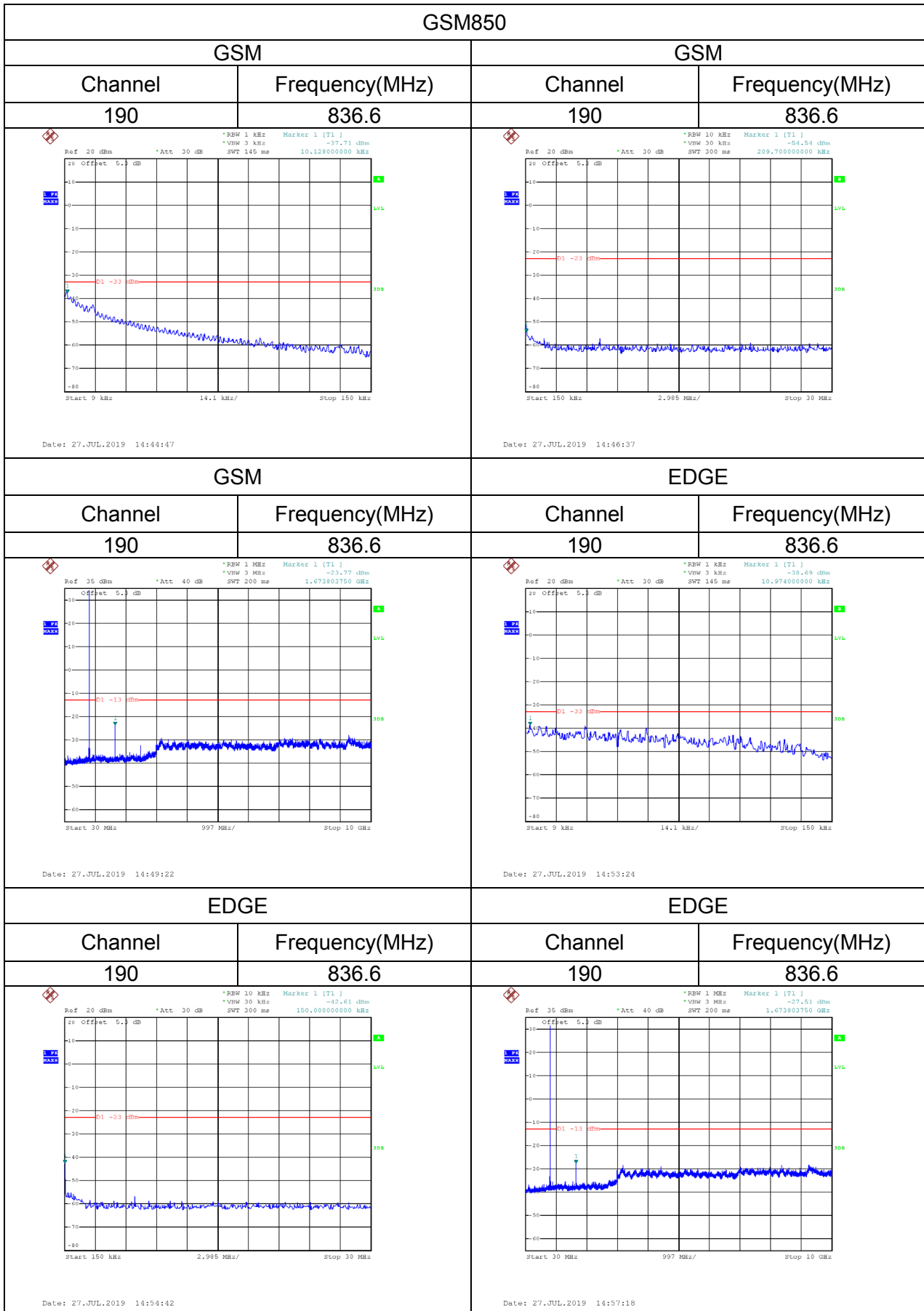

WCDMA Band V

Channel	Frequency(MHz)	Channel	Frequency(MHz)
4182	836.4	4182	836.4
Date: 27.JUL.2019 15:39:04		Date: 27.JUL.2019 15:36:09	
Channel	Frequency(MHz)	-	-
4182	836.4	-	-
Date: 27.JUL.2019 15:39:13			

LTE Band 5_1.4M

Channel	Frequency(MHz)	Channel	Frequency(MHz)
20525	836.5	20525	836.5
<p>Date: 27.JUL.2019 16:50:13</p>		<p>Date: 27.JUL.2019 16:47:02</p>	
Channel	Frequency(MHz)	-	-
20525	836.5	-	-
<p>Date: 29.JUL.2019 17:56:40</p>			

LTE Band 5_5M

Channel	Frequency(MHz)	Channel	Frequency(MHz)
20525	836.5	20525	836.5
Date: 27.JUL.2019 16:54:45		Date: 27.JUL.2019 16:57:01	
Channel	Frequency(MHz)	-	-
20525	836.5	-	-
		-	
Date: 29.JUL.2019 17:58:05			

LTE Band 5_10M

Channel	Frequency(MHz)	Channel	Frequency(MHz)
20525	836.5	20525	836.5
<p>Date: 27.JUL.2019 17:00:00</p>		<p>Date: 27.JUL.2019 17:01:07</p>	
Channel	Frequency(MHz)	-	-
20525	836.5	-	-
<p>Date: 29.JUL.2019 17:59:24</p>		-	

APPENDIX D - RADIATED EMISSION (9KHZ TO 30MHZ)

Test Mode: TX Mode

Ant 0°

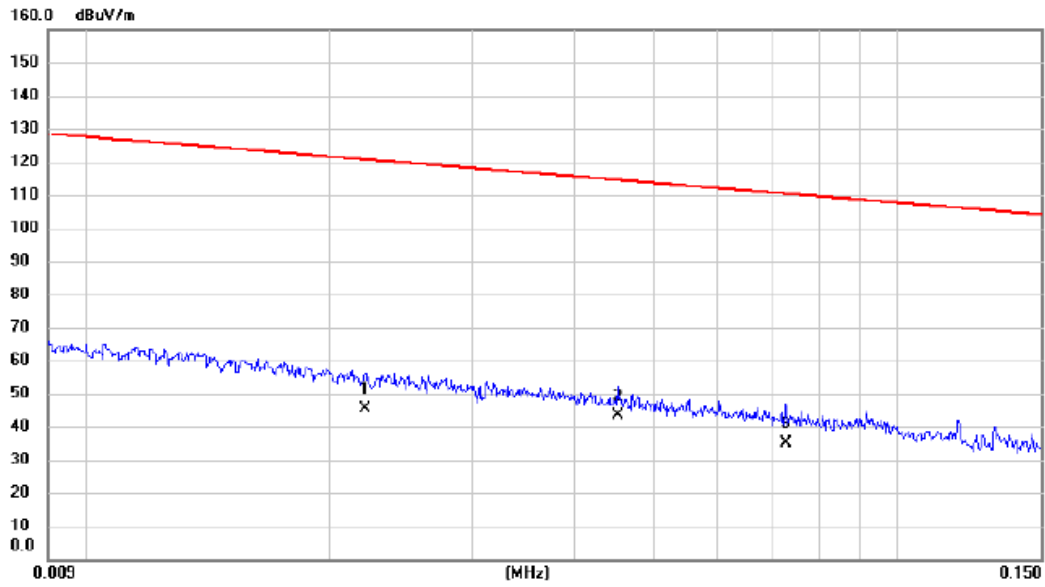

No.	Mk.	Freq. MHz	Reading Level dBuV	Correct Factor dB	Measure- ment dBuV/m	Limit dBuV/m	Margin dB	Detector	Comment
1		0.0221	31.58	13.83	45.41	120.72	-75.31	AVG	
2	*	0.0452	29.56	13.91	43.47	114.50	-71.03	AVG	
3		0.0728	21.39	13.57	34.96	110.36	-75.40	AVG	

Test Mode: TX Mode

Ant 0°

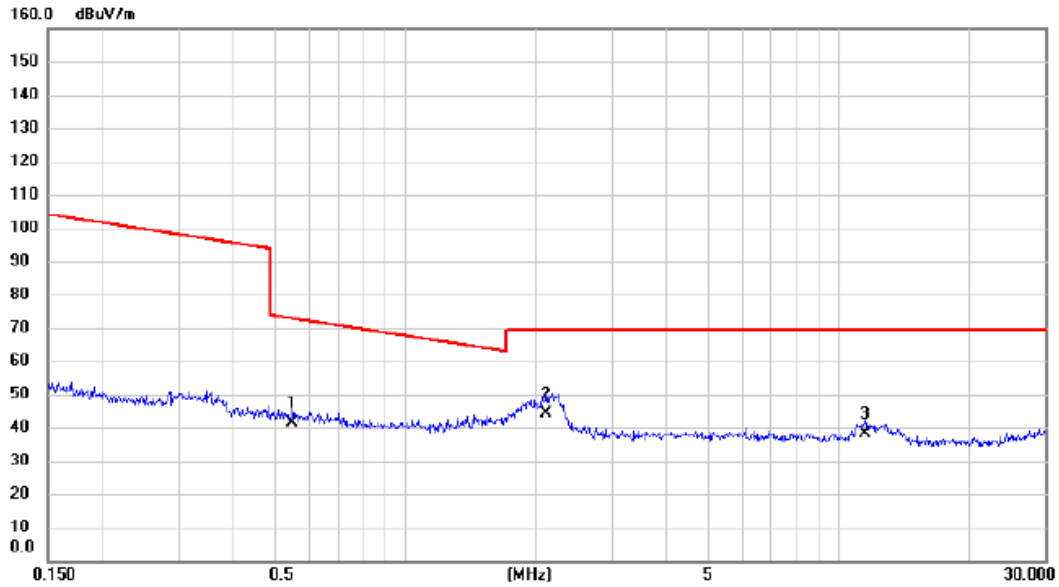

No.	Mk.	Freq. MHz	Reading Level dBuV	Correct Factor dB	Measure- ment dBuV/m	Limit dBuV/m	Margin dB	Detector	Comment
1		0.5493	28.39	12.96	41.35	72.81	-31.46	QP	
2	*	2.1213	32.56	11.75	44.31	69.54	-25.23	QP	
3		11.5594	26.47	11.61	38.08	69.54	-31.46	QP	

Test Mode: TX Mode

Ant 90°

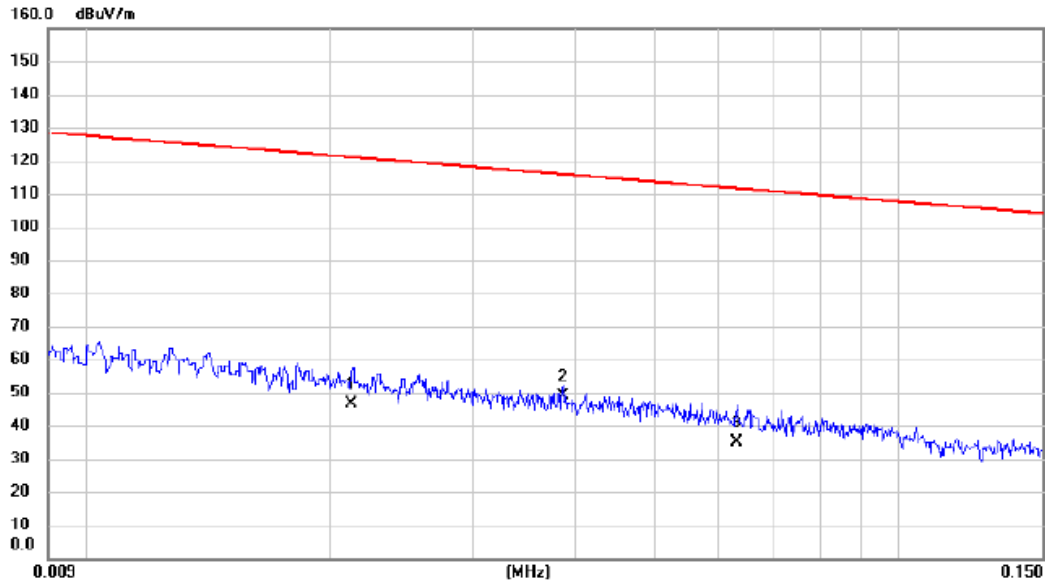

No.	Mk.	Freq.	Reading Level	Correct Factor	Measurement	Limit	Margin	Detector	Comment
		MHz	dBuV	dB	dBuV/m	dBuV/m	dB		
1		0.0212	32.76	13.82	46.58	121.08	-74.50	AVG	
2	*	0.0387	35.14	13.89	49.03	115.85	-66.82	AVG	
3		0.0632	21.31	13.72	35.03	111.59	-76.56	AVG	

Test Mode: TX Mode

Ant 90°

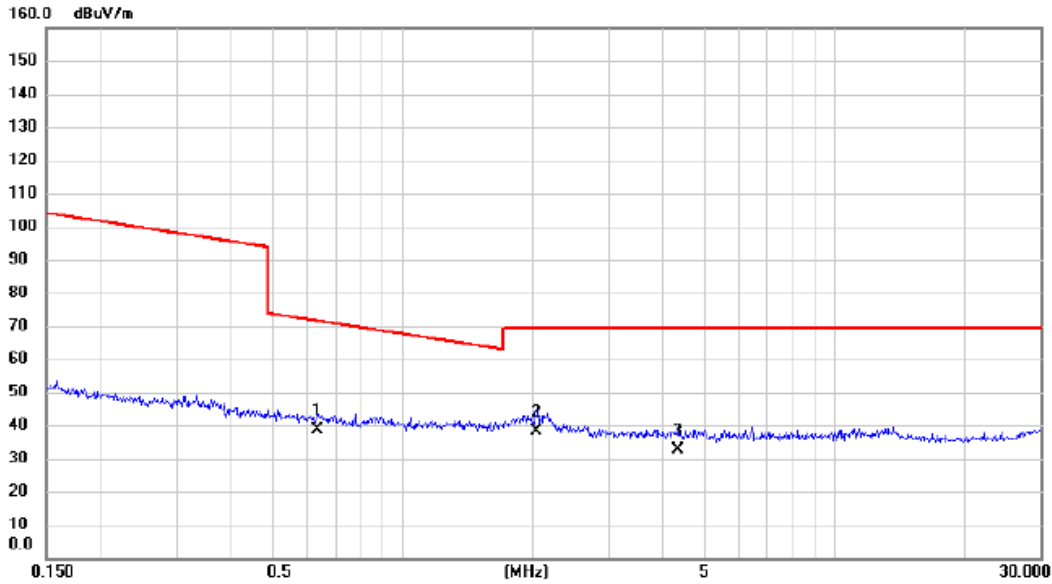

No. Mk.	Freq. MHz	Reading Level dBuV	Correct Factor dB	Measurement dBuV/m	Limit dBuV/m	Margin dB	Detector	Comment
1	0.6372	25.64	12.80	38.44	71.52	-33.08	QP	
2 *	2.0441	26.31	11.79	38.10	69.54	-31.44	QP	
3	4.3606	21.69	10.91	32.60	69.54	-36.94	QP	

APPENDIX E - RADIATED EMISSION (30MHZ TO 1GHZ)

Test Mode: GSM850_TX CH190_GSM

Vertical

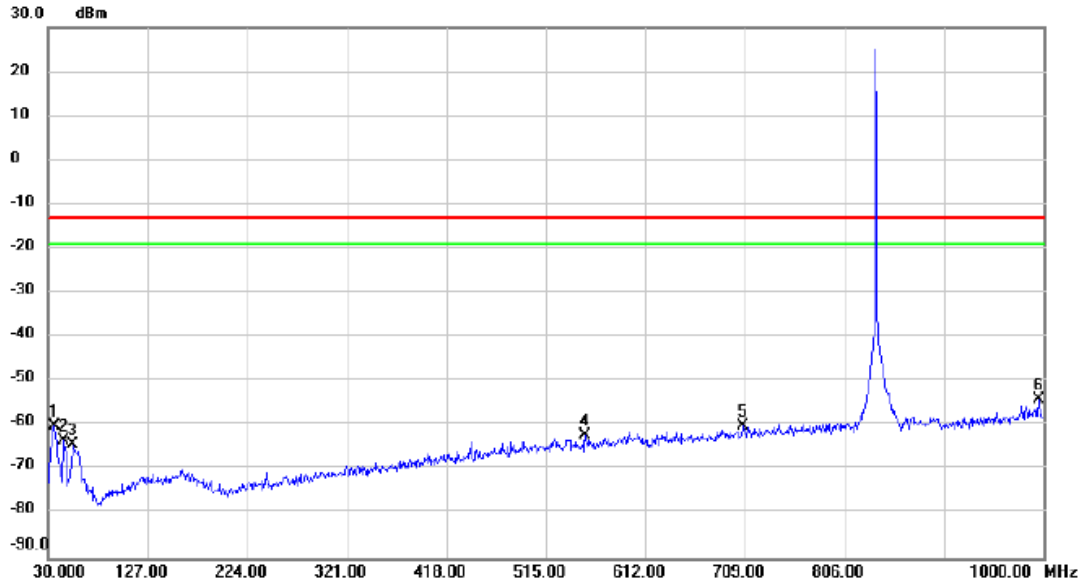

No.	Mk.	Freq. MHz	Reading Level dBm	Correct Factor dB	Measure- ment dBm	Limit dBm	Margin dB	Detector	Comment
1		35.8200	-65.06	4.92	-60.14	-13.00	-47.14	peak	
2		45.0350	-68.64	5.15	-63.49	-13.00	-50.49	peak	
3		53.7650	-70.02	5.69	-64.33	-13.00	-51.33	peak	
4		552.8300	-74.86	12.46	-62.40	-13.00	-49.40	peak	
5		707.0600	-75.86	15.64	-60.22	-13.00	-47.22	peak	
6	*	995.1500	-73.77	19.57	-54.20	-13.00	-41.20	peak	

Test Mode: GSM850_TX CH190_GSM

Horizontal

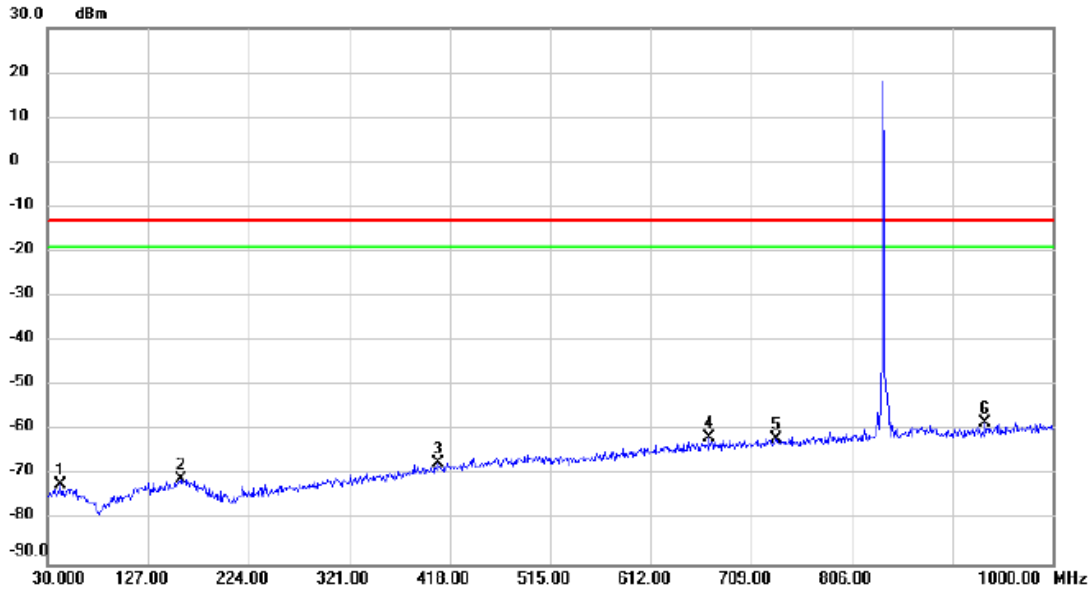

No.	Mk.	Freq. MHz	Reading Level dBm	Correct Factor dB	Measure- ment dBm	Limit dBm	Margin dB	Detector	Comment
1		42.1250	-77.24	5.15	-72.09	-13.00	-59.09	peak	
2		159.0100	-79.39	8.46	-70.93	-13.00	-57.93	peak	
3		406.8450	-77.70	10.31	-67.39	-13.00	-54.39	peak	
4		668.2600	-76.89	15.16	-61.73	-13.00	-48.73	peak	
5		732.2800	-77.88	15.81	-62.07	-13.00	-49.07	peak	
6	*	935.0100	-76.69	18.47	-58.22	-13.00	-45.22	peak	

Test Mode: GSM850_TX CH190_EDGE

Vertical

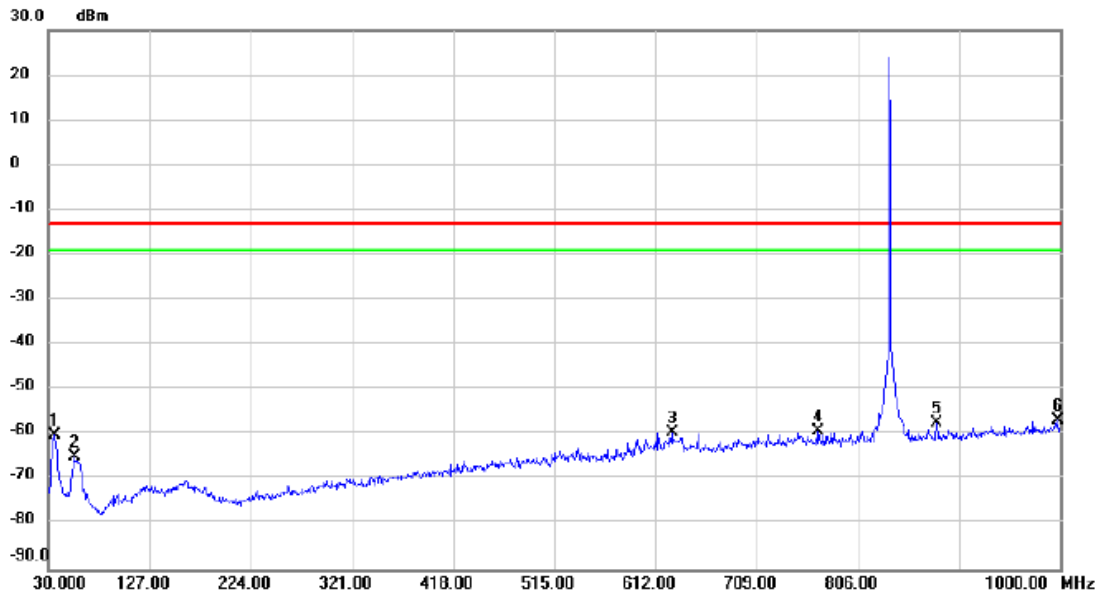

No.	Mk.	Freq. MHz	Reading Level dBm	Correct Factor dB	Measure- ment dBm	Limit dBm	Margin dB	Detector	Comment
1		35.8200	-64.93	4.92	-60.01	-13.00	-47.01	peak	
2		54.7350	-70.69	5.64	-65.05	-13.00	-52.05	peak	
3		628.0050	-73.90	14.45	-59.45	-13.00	-46.45	peak	
4		768.1700	-75.45	16.18	-59.27	-13.00	-46.27	peak	
5		881.6600	-74.98	17.51	-57.47	-13.00	-44.47	peak	
6	*	997.5750	-76.48	19.62	-56.86	-13.00	-43.86	peak	

Test Mode: GSM850_TX CH190_EDGE

Horizontal

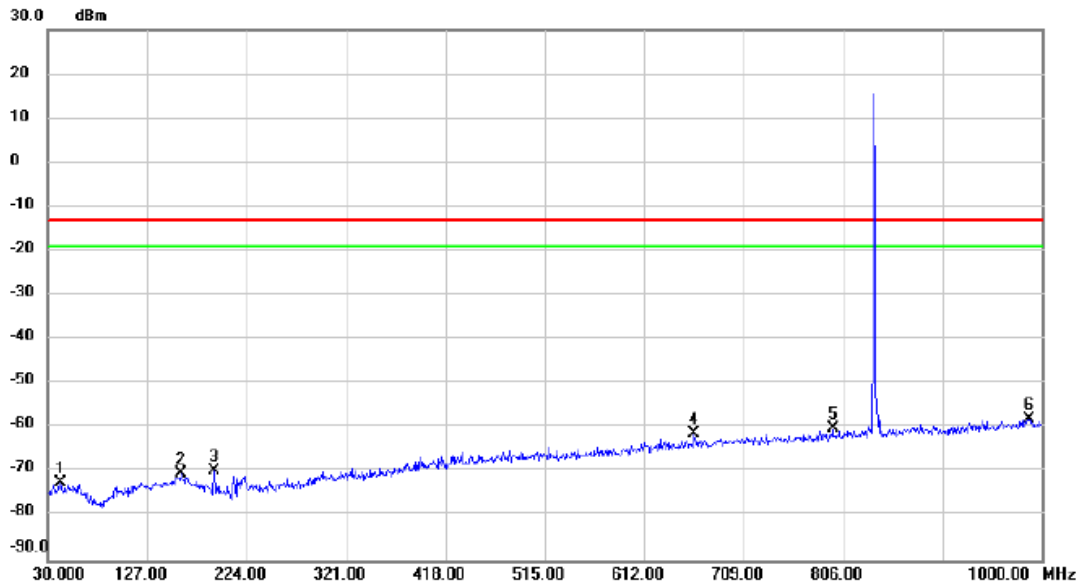

No.	Mk.	Freq. MHz	Reading Level dBm	Correct Factor dB	Measure- ment dBm	Limit dBm	Margin dB	Detector	Comment
1		42.6100	-77.68	5.10	-72.58	-13.00	-59.58	peak	
2		159.9800	-78.99	8.59	-70.40	-13.00	-57.40	peak	
3		191.9900	-74.62	4.99	-69.63	-13.00	-56.63	peak	
4		660.9850	-76.26	15.06	-61.20	-13.00	-48.20	peak	
5		795.8150	-76.83	16.53	-60.30	-13.00	-47.30	peak	
6	*	987.3900	-77.51	19.45	-58.06	-13.00	-45.06	peak	

Test Mode: WCDMA Band V_TX CH4182

Vertical

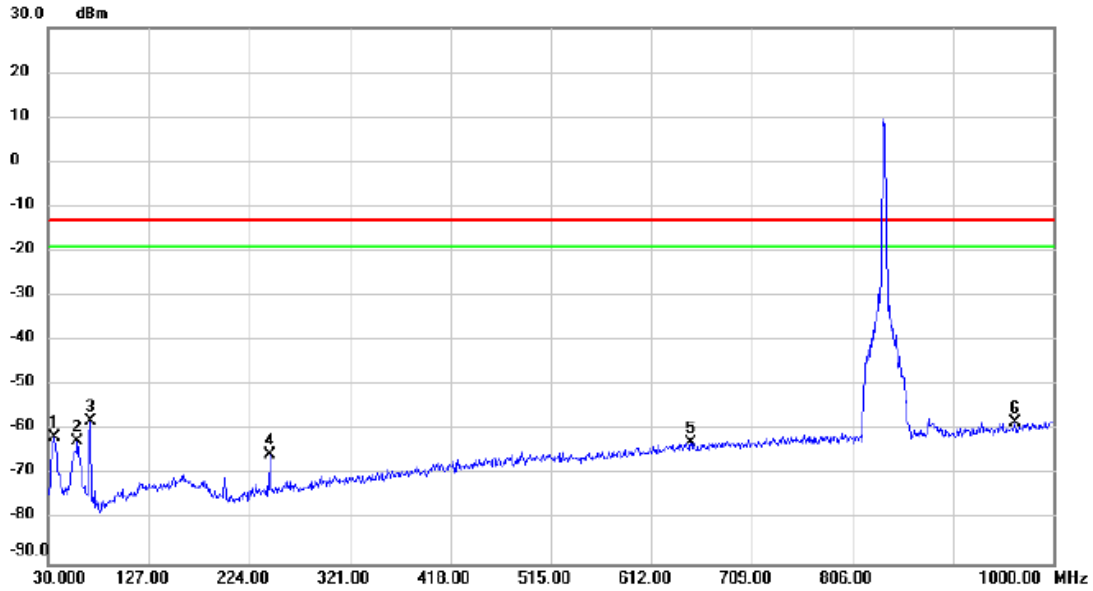

No.	Mk.	Freq. MHz	Reading Level dBm	Correct Factor dB	Measure- ment dBm	Limit dBm	Margin dB	Detector	Comment
1		35.3350	-66.54	4.79	-61.75	-13.00	-48.75	peak	
2		58.1300	-67.47	4.93	-62.54	-13.00	-49.54	peak	
3	*	70.2550	-61.45	3.33	-58.12	-13.00	-45.12	peak	
4		243.8850	-71.39	5.70	-65.69	-13.00	-52.69	peak	
5		649.8300	-77.77	14.92	-62.85	-13.00	-49.85	peak	
6		963.6250	-77.34	19.05	-58.29	-13.00	-45.29	peak	

Test Mode: WCDMA Band V_TX CH4182

Horizontal

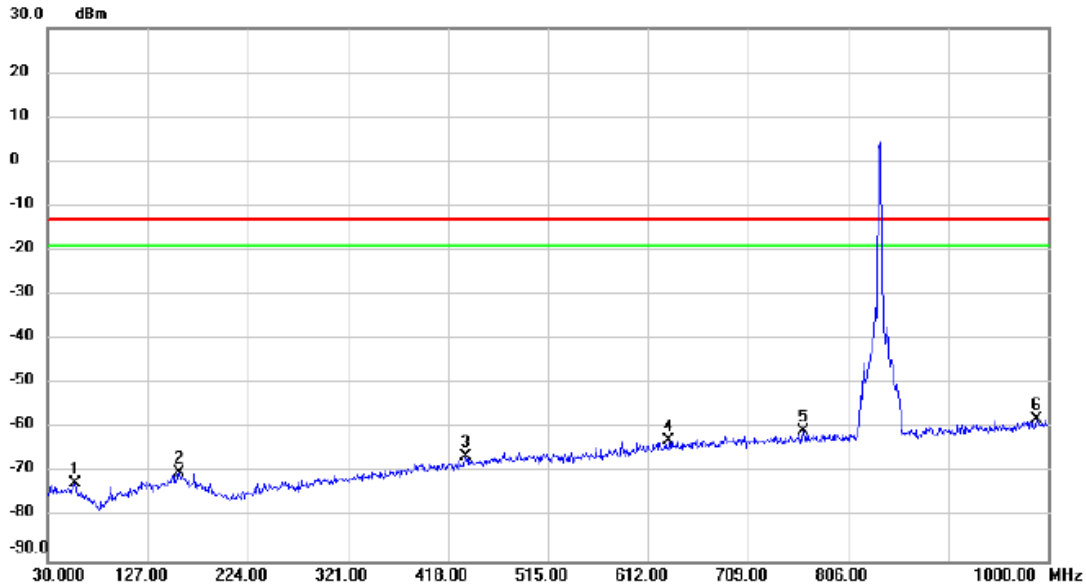

No.	Mk.	Freq. MHz	Reading Level dBm	Correct Factor dB	Measure- ment dBm	Limit dBm	Margin dB	Detector	Comment
1		56.1900	-78.00	5.46	-72.54	-13.00	-59.54	peak	
2		157.5550	-78.19	8.28	-69.91	-13.00	-56.91	peak	
3		435.4600	-77.61	11.11	-66.50	-13.00	-53.50	peak	
4		632.3700	-77.50	14.53	-62.97	-13.00	-49.97	peak	
5		762.3500	-76.89	16.09	-60.80	-13.00	-47.80	peak	
6	*	988.3600	-77.58	19.47	-58.11	-13.00	-45.11	peak	

Test Mode: LTE Band 5_TX CH20525_1.4M

Vertical

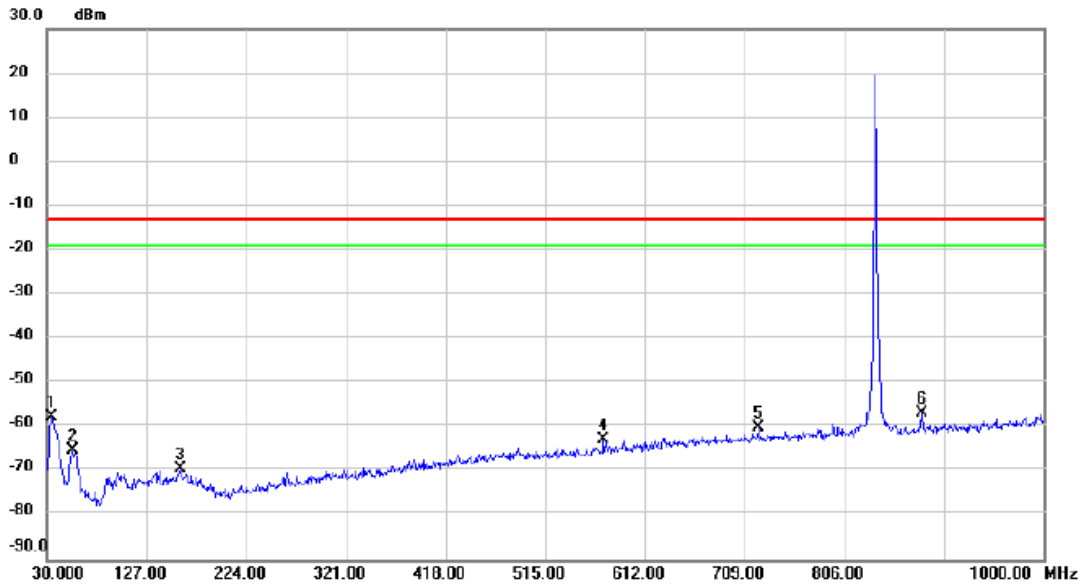

No.	Mk.	Freq. MHz	Reading Level dBm	Correct Factor dB	Measurement dBm	Limit dBm	Margin dB	Detector	Comment
1		34.3650	-62.39	4.54	-57.85	-13.00	-44.85	peak	
2		55.2200	-70.92	5.59	-65.33	-13.00	-52.33	peak	
3		159.4950	-78.08	8.53	-69.55	-13.00	-56.55	peak	
4		571.7450	-76.01	13.02	-62.99	-13.00	-49.99	peak	
5		723.0650	-75.97	15.74	-60.23	-13.00	-47.23	peak	
6	*	881.1750	-74.47	17.51	-56.96	-13.00	-43.96	peak	

Test Mode: LTE Band 5_TX CH20525_1.4M

Horizontal

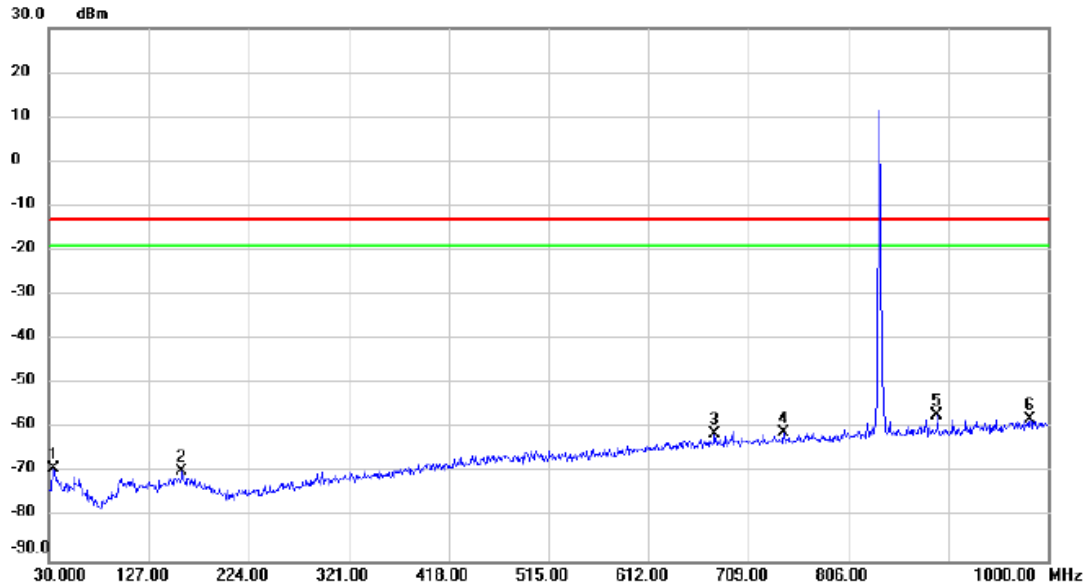

No.	Mk.	Freq. MHz	Reading Level dBm	Correct Factor dB	Measure- ment dBm	Limit dBm	Margin dB	Detector	Comment
1		34.8500	-73.68	4.67	-69.01	-13.00	-56.01	peak	
2		159.0100	-78.29	8.46	-69.83	-13.00	-56.83	peak	
3		676.5050	-76.76	15.27	-61.49	-13.00	-48.49	peak	
4		742.9500	-76.85	15.88	-60.97	-13.00	-47.97	peak	
5	*	892.3300	-74.78	17.60	-57.18	-13.00	-44.18	peak	
6		983.0250	-77.52	19.37	-58.15	-13.00	-45.15	peak	

Test Mode: LTE Band 5_TX CH20525_5M

Vertical

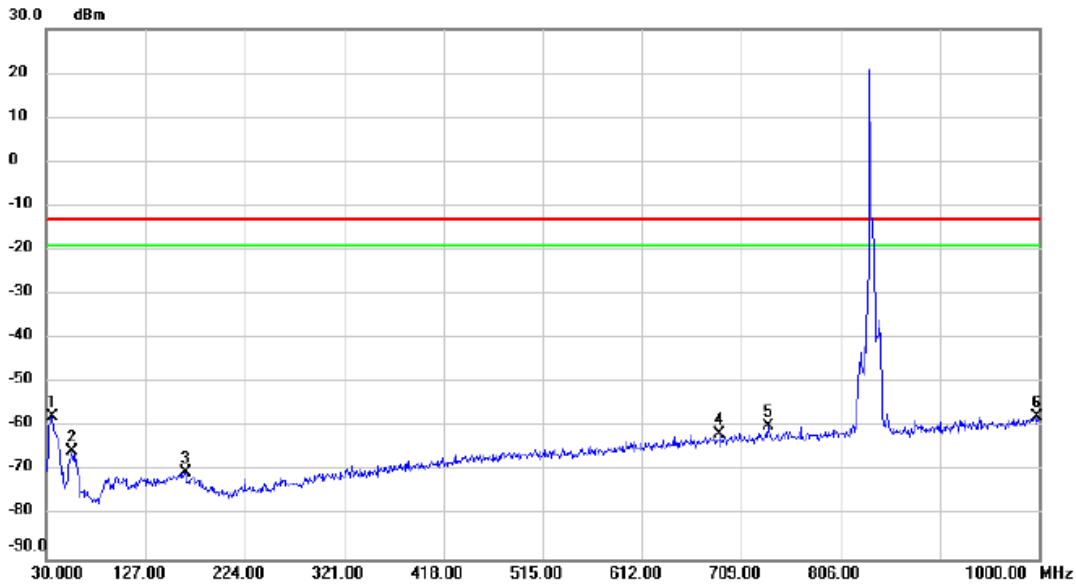

No.	Mk.	Freq. MHz	Reading Level dBm	Correct Factor dB	Measure- ment dBm	Limit dBm	Margin dB	Detector	Comment
1	*	35.8200	-62.59	4.92	-57.67	-13.00	-44.67	peak	
2		54.7350	-71.27	5.64	-65.63	-13.00	-52.63	peak	
3		165.8000	-78.02	7.77	-70.25	-13.00	-57.25	peak	
4		687.6600	-77.04	15.42	-61.62	-13.00	-48.62	peak	
5		735.1900	-75.56	15.83	-59.73	-13.00	-46.73	peak	
6		998.5450	-77.48	19.64	-57.84	-13.00	-44.84	peak	

Test Mode: LTE Band 5_TX CH20525_5M

Horizontal

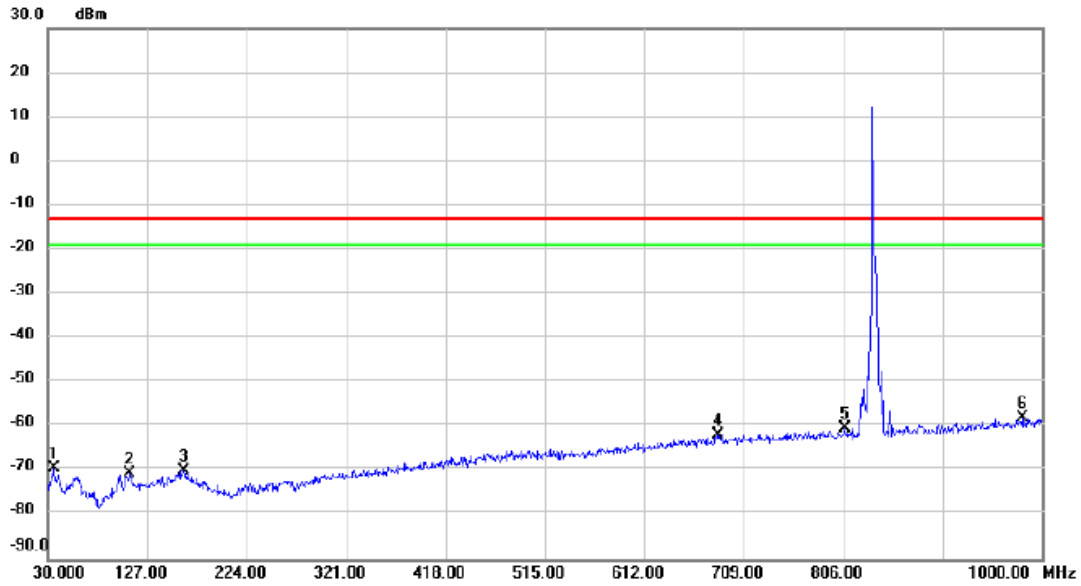

No.	Mk.	Freq. MHz	Reading Level dBm	Correct Factor dB	Measure- ment dBm	Limit dBm	Margin dB	Detector	Comment
1		35.3350	-74.20	4.79	-69.41	-13.00	-56.41	peak	
2		110.0250	-75.67	5.07	-70.60	-13.00	-57.60	peak	
3		162.4050	-78.22	8.25	-69.97	-13.00	-56.97	peak	
4		684.2650	-77.18	15.37	-61.81	-13.00	-48.81	peak	
5		807.4550	-77.28	16.69	-60.59	-13.00	-47.59	peak	
6	*	981.5700	-77.40	19.35	-58.05	-13.00	-45.05	peak	

Test Mode: LTE Band 5_TX CH20525_10M

Vertical

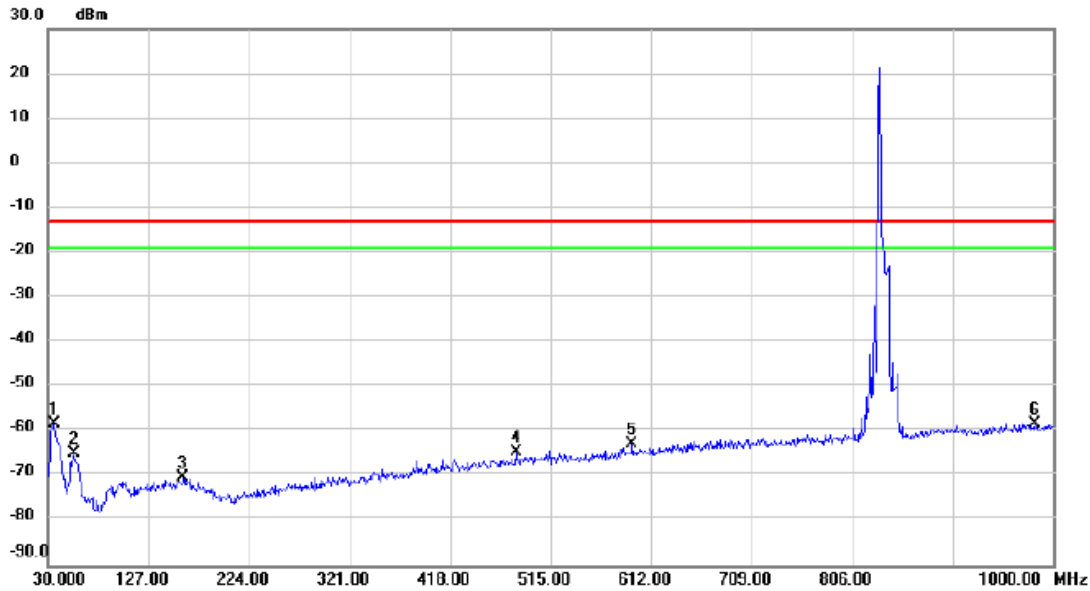

No.	Mk.	Freq. MHz	Reading Level dBm	Correct Factor dB	Measure- ment dBm	Limit dBm	Margin dB	Detector	Comment
1	*	35.8200	-63.24	4.92	-58.32	-13.00	-45.32	peak	
2		55.7050	-70.60	5.55	-65.05	-13.00	-52.05	peak	
3		159.9800	-79.05	8.59	-70.46	-13.00	-57.46	peak	
4		481.5350	-76.48	11.76	-64.72	-13.00	-51.72	peak	
5		593.5700	-76.38	13.66	-62.72	-13.00	-49.72	peak	
6		983.0250	-77.73	19.37	-58.36	-13.00	-45.36	peak	

Test Mode: LTE Band 5_TX CH20525_10M

Horizontal

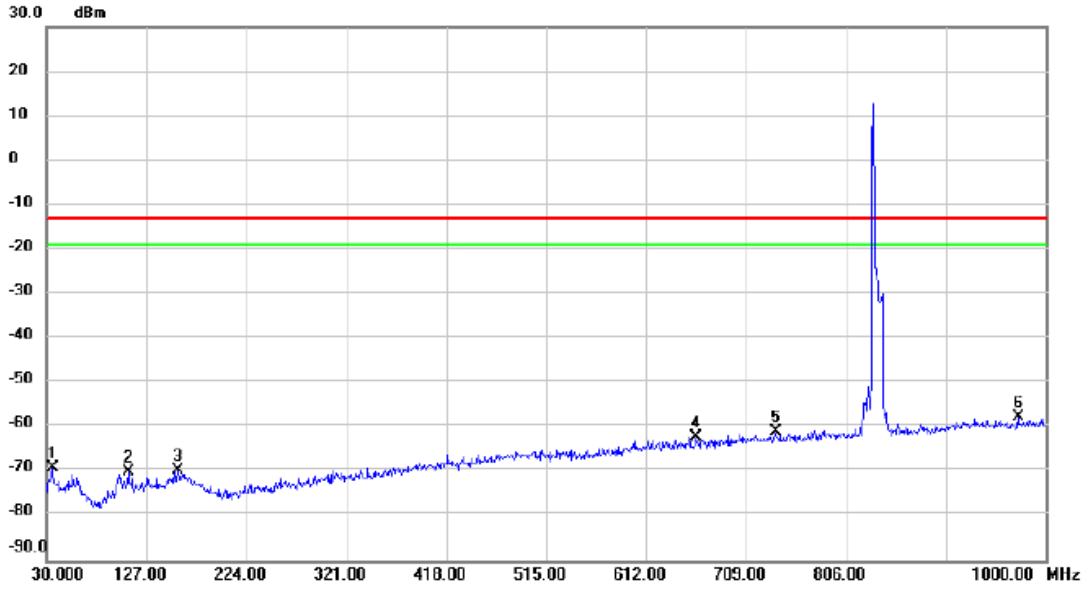

No.	Mk.	Freq. MHz	Reading Level dBm	Correct Factor dB	Measure- ment dBm	Limit dBm	Margin dB	Detector	Comment
1		35.3350	-74.04	4.79	-69.25	-13.00	-56.25	peak	
2		109.0550	-75.13	4.99	-70.14	-13.00	-57.14	peak	
3		157.0700	-77.94	8.22	-69.72	-13.00	-56.72	peak	
4		660.5000	-77.31	15.05	-62.26	-13.00	-49.26	peak	
5		737.6150	-76.88	15.85	-61.03	-13.00	-48.03	peak	
6	*	973.3250	-76.81	19.21	-57.60	-13.00	-44.60	peak	