

# FCC Radio Test Report

## FCC ID: QISME309-562

This report concerns (check one): Original Grant Class I Change Class II Change

**Project No.** : 1712C196  
**Equipment** : eMTC Module  
**Test Model** : ME309-562  
**Series Model** : N/A  
**Applicant** : Huawei Technologies Co.,Ltd.  
**Address** : Administration Building, Headquarters of Huawei Technologies Co., Ltd., Bantian, Longgang District, Shenzhen, 518129, P.R.C

**Date of Receipt** : Dec. 29, 2017  
**Date of Test** : Dec. 29, 2017 ~ Jan. 26, 2018  
**Issued Date** : Feb. 06, 2018  
**Tested by** : BTL Inc.

**Technical Engineer** : Shawn Xiao  
(Shawn Xiao)

**Authorized Signatory** : Steven Lu  
(Steven Lu)

# **B T L I N C .**

No.3,Jinshagang 1st Road, Shixia,Dalang Town, Dongguan, Guangdong, China.

TEL: +86-769-8318-3000 FAX: +86-769-8319-6000



### **Declaration**

**BTL** represents to the client that testing is done in accordance with standard procedures as applicable and that test instruments used has been calibrated with standards traceable to international standard(s) and/or national standard(s).

**BTL's** reports apply only to the specific samples tested under conditions. It is manufacture's responsibility to ensure that additional production units of this model are manufactured with the identical electrical and mechanical components. **BTL** shall have no liability for any declarations, inferences or generalizations drawn by the client or others from **BTL** issued reports.

**BTL's** report must not be used by the client to claim product certification, approval, or endorsement by NVLAP, NIST, or any agency of the Federal Government.

This report is the confidential property of the client. As a mutual protection to the clients, the public and **BTL-self**, extracts from the test report shall not be reproduced except in full with **BTL's** authorized written approval.

**BTL's** laboratory quality assurance procedures are in compliance with the **ISO Guide17025** requirements, and accredited by the conformity assessment authorities listed in this test report.

### **Limitation**

For the use of the authority's logo is limited unless the Test Standard(s)/Scope(s)/Item(s) mentioned in this test report is (are) included in the conformity assessment authorities acceptance respective.

**Table of Contents**

**Page**

<b>REPORT ISSUED HISTORY</b>	<b>5</b>
<b>1 . CERTIFICATION</b>	<b>6</b>
<b>2 . SUMMARY OF TEST RESULTS</b>	<b>7</b>
2.1 TEST FACILITY	8
2.2 MEASUREMENT UNCERTAINTY	8
<b>3 . GENERAL INFORMATION</b>	<b>9</b>
3.1 GENERAL DESCRIPTION OF EUT	9
3.2 DESCRIPTION OF TEST MODES AND TEST CONDITION	10
3.3 BLOCK DIGRAM SHOWING THE CONFIGURATION OF SYSTEMTESTED FOR RADIATED	11
3.4 DESCRIPTION OF SUPPORT UNITS	11
<b>4 . TEST RESULT</b>	<b>12</b>
4.1 OUTPUT POWER MEASUREMENT	12
4.1.1 LIMIT	12
4.1.2 TEST PROCEDURE	12
4.1.3 TESTSETUP LAYOUT	12
4.1.4 TEST DEVIATION	12
4.1.5 TEST RESULTS	12
4.2 OCCUPIED BANDWIDTH MEASUREMENT	13
4.2.1 TEST PROCEDURE	13
4.2.2 TEST SETUP LAYOUT	13
4.2.3 TEST DEVIATION	13
4.2.4 TEST RESULTS	13
4.3 CONDUCTED EMISSIONS MEASUREMENT	14
4.3.1 LIMIT	14
4.3.2 TEST PROCEDURES	14
4.3.3 TESTSETUP LAYOUT	14
4.3.4 TESTDEVIATION	14
4.3.5 TEST RESULTS	14
4.4 RADIATED EMISSIONS MEASUREMENT	15
4.4.1 LIMIT	15
4.4.2 TEST PROCEDURES	15
4.4.3 TESTSETUP LAYOUT	15
4.4.4 TESTDEVIATION	16
4.4.5 TEST RESULTS	16
4.5 BAND EDGE MEASUREMENT	17
4.5.1 LIMIT	17
4.5.2 TEST PROCEDURES	17

<b>Table of Contents</b>	<b>Page</b>
4.5.3 TESTSETUP LAYOUT	17
4.5.4 TESTDEVIATION	17
4.5.5 TEST RESULTS	17
4.6 PEAK TO AVERAGE RATIO MEASUREMENT	18
4.6.1 LIMIT	18
4.6.2 TEST PROCEDURES	18
4.6.3 TESTSETUP LAYOUT	18
4.6.4 TESTDEVIATION	18
4.6.5 TEST RESULTS	18
4.7 FREQUENCY STABILITY MEASUREMENT	19
4.7.1 LIMIT	19
4.7.2 TEST PROCEDURES	19
4.7.3 TESTSETUP LAYOUT	19
4.7.4 TESTDEVIATION	19
4.7.5 TEST RESULTS	19
5. LIST OF MEASUREMENT EQUIPMENTS	20
APPENDIX A - OUTPUT POWER	22
APPENDIX B - OCCUPIED BANDWIDTH	25
APPENDIX C - CONDUCTED EMISSIONS	30
APPENDIX D - RADIATED EMISSION	35
APPENDIX E - BAND EDGE	56
APPENDIX F - PEAK TO AVERAGE RATIO	65
APPENDIX G - FREQUENCY STABILITY	68

### REPORT ISSUED HISTORY

Issued No.	Description	Issued Date
BTL-FCCP-1-1712C196	Original Issue.	Feb. 06, 2018

## 1. CERTIFICATION

Equipment : eMTC Module  
Brand Name : HUAWEI  
Test Model : ME309-562  
Series Model : N/A  
Applicant : Huawei Technologies Co.,Ltd.  
Manufacturer : Huawei Technologies Co.,Ltd.  
Address : Administration Building, Headquarters of Huawei Technologies Co., Ltd.,  
Bantian, Longgang District, Shenzhen, 518129, P.R.C  
Factory : Huawei Technologies Co.,Ltd.  
Address : Administration Building, Headquarters of Huawei Technologies Co., Ltd.,  
Bantian, Longgang District, Shenzhen, 518129, P.R.C  
Date of Test : Dec. 29, 2017 ~ Jan. 26, 2018  
Test Sample : Engineering Sample  
Standard(s) : 47 CFR FCC Part 24 Subpart E  
47 CFR FCC Part 2  
ANSI/TIA-603-D-2010  
KDB 971168 D01 Power Meas License Digital Systems v03

The above equipment has been tested and found compliance with the requirement of the relative standards by BTL Inc.

The test data, data evaluation, and equipment configuration contained in our test report (Ref No. BTL-FCCP-1-1712C196) were obtained utilizing the test procedures, test instruments, test sites that has been accredited by the Authority of NVLAP according to the ISO-17025 quality assessment standard and technical standard(s).

**Test results included in this report is only for the eMTC Band 2 part.**

## 2. SUMMARY OF TEST RESULTS

Test procedures according to the technical standard(s):

FCC Part 24 Subpart E & Part 2			
Standard(s) Section	Test Item	Judgment	Tested By
2.1046 & 24.232(c)	Radiated power	PASS	Paul Li
2.1046 & 24.232(c)	Conducted Output Power	PASS	Paul Li
2.1049 & 24.238(a)	Occupied Bandwidth	PASS	Paul Li
2.1051 & 24.238(a)	Conducted Spurious Emissions	PASS	Paul Li
2.1053 & 24.238(a)	Radiated Spurious Emissions	PASS	Paul Li
24.238(a)	Band Edge Measurements	PASS	Paul Li
24.232(d)	Peak To Average Ratio	PASS	Paul Li
2.1055 & 24.235	Frequency Stability	PASS	Paul Li

**NOTE:**

(1) "N/A" denotes test is not applicable to this device.

## 2.1 TEST FACILITY

The test facilities used to collect the test data in this report is at the location of No.3, Jinshagang 1st Road, Shixia, Dalang Town, Dongguan, Guangdong, China.

BTL's test firm registration number for FCC: 854385

BTL's designation number for FCC: CN5020

## 2.2 MEASUREMENT UNCERTAINTY

The measurement uncertainty figures shall be calculated according the methods described in the ETSI TR 100 028 and shall correspond to an expansion factor (coverage factor)  $k=1.96$  or  $k=2$ (which provide confidence levels of respectively 90% and 95.45% in the case where the distributions characterizing the actual measurement uncertainties are normal (Gaussian)).

Measurement Uncertainty for a Level of Confidence of 95 %,  $U=2xUc(y)$ .

The BTL measurement uncertainty as below table:

### A. Radiated Measurement :

Test Site	Method	Measurement Frequency Range	Ant. H / V	U,(dB)
DG-CB03 (3m)	CISPR	9KHz ~ 30MHz	V	3.79
		9KHz ~ 30MHz	H	3.57
		30MHz ~ 200MHz	V	3.82
		30MHz ~ 200MHz	H	3.78
		200MHz ~ 1,000MHz	V	4.10
		200MHz ~ 1,000MHz	H	4.06

Test Site	Method	Measurement Frequency Range	Ant. H / V	U,(dB)
DG-CB03 (3m)	CISPR	1GHz ~ 18GHz	V	3.12
		1GHz ~ 18GHz	H	3.68

Test Site	Method	Measurement Frequency Range	Ant. H / V	U,(dB)
DG-CB03 (1m)	CISPR	18GHz ~ 40GHz	V	4.15
		18GHz ~ 40GHz	H	4.14

Note: Unless specifically mentioned, the uncertainty of measurement has not been taken into account to declare the compliance or non-compliance to the specification.



### 3. GENERAL INFORMATION

#### 3.1 GENERAL DESCRIPTION OF EUT

Equipment	eMTC Module			
Brand Name	HUAWEI			
Model Name	ME309-562			
Model Difference	N/A			
Antenna Type	Dipole Antenna (External)			
Antenna Gain	2.5 dBi			
Hardware Version	ML2ME309M Ver.A			
Software Version	11.511.00.00.00			
IMEI No.	Radiated	865790030009203		
	Conducted	865790030009344		
Power Source	#1 DC voltage supplied from AC/DC adapter. (Support uint.) #2 Supplied from USB port.			
Power Rating	#1 AC 100-240V, DC 5V (EUT I/P: DC 3.8V) #2 DC 5V (EUT I/P: DC 3.8V)			
eMTC Category	CAT-M1			
Modulation Type	QPSK, 16QAM			
Operation Frequency	eMTC Band 2 (Channel Bandwidth: 5MHz)	1852.5 ~ 1907.5 MHz		
	eMTC Band 2 (Channel Bandwidth: 10MHz)	1855 ~ 1905 MHz		
	eMTC Band 2 (Channel Bandwidth: 15MHz)	1857.5 ~ 1902.5 MHz		
	eMTC Band 2 (Channel Bandwidth: 20MHz)	1860 ~ 1900 MHz		
Max. EIRP Power	eMTC Band 2 (Channel Bandwidth: 5MHz)	QPSK	25.33	dBm
		16QAM	25.37	dBm
	eMTC Band 2 (Channel Bandwidth: 10MHz)	QPSK	25.28	dBm
		16QAM	25.39	dBm
	eMTC Band 2 (Channel Bandwidth: 15MHz)	QPSK	25.13	dBm
		16QAM	25.15	dBm
	eMTC Band 2 (Channel Bandwidth: 20MHz)	QPSK	25.16	dBm
		16QAM	25.12	dBm

Note:

1. For a more detailed features description, please refer to the manufacturer's specifications or the user's manual.

### 3.2 DESCRIPTION OF TEST MODES AND TEST CONDITION

Following channel(s) was (were) selected for the final test as listed below:

Test item	Modes	Bandwidth (MHz)				Modulation		RB (%)			Test Channel		
		5	10	15	20	QPSK	16QAM	1	50	100	L	M	H
Radiated power	CAT-M1 B2	√	√	√	√	√	√	√	√	√	√	√	√
Conducted Output Power	CAT-M1 B2	√	√	√	√	√	√	√	√	√	√	√	√
Occupied Bandwidth	CAT-M1 B2	√	√	√	√	√	√			√		√	
Conducted Spurious Emissions	CAT-M1 B2	√	√	√	√	√		√				√	
Radiated Spurious Emissions	CAT-M1 B2	√			√	√		√			√		
Band Edge Measurements	CAT-M1 B2	√	√	√	√	√	√	√		√	√		√
Peak To Average Ratio	CAT-M1 B2	√	√	√	√	√	√			√		√	
Frequency Stability	CAT-M1 B2	√	√	√	√	√				√		√	

#### EUT TEST CONDITIONS:

Test Item	Environmental Conditions	Test Voltage
EIRP	25°C, 60%RH	DC 3.8V
Conducted Output Power	25°C, 65%RH	DC 3.8V
Occupied Bandwidth	25°C, 65%RH	DC 3.8V
Conducted Spurious Emissions	25°C, 65%RH	AC 120V/60Hz
Radiated Spurious Emissions	25°C, 60%RH	DC 3.8V
Band Edge	25°C, 65%RH	DC 3.8V
Peak to Average Ratio	25°C, 65%RH	DC 3.8V
Frequency Stability	Normal and Extreme	Normal and Extreme

### 3.3 BLOCK DIGRAM SHOWING THE CONFIGURATION OF SYSTEMTESTED FOR RADIATED

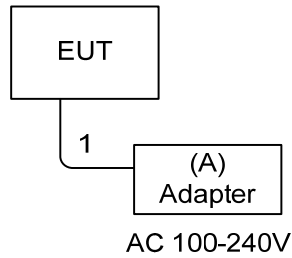

### 3.4 DESCRIPTION OF SUPPORT UNITS

The EUT has been tested as an independent unit together with other necessary accessories or support units. The following support units or accessories were used to form a representative test configuration during the tests.

Item	Equipment	Mfr/Brand	Model/Type No.	FCC ID	Series No.
A	Adapter	N/A	HW-050200E01	N/A	N/A

Item	Shielded Type	Ferrite Core	Length	Note
1	NO	NO	1.2m	USB Cable

## 4. TEST RESULT

### 4.1 OUTPUT POWER MEASUREMENT

#### 4.1.1 LIMIT

Mobile / Portable station are limited to 2 watts e.i.r.p.

#### 4.1.2 TEST PROCEDURE

##### EIRP/ERP:

EIRP= Conducted Power +Antenan gain

ERP power=EIPR power-2.15dBi.

##### Conducted Power:

The EUT was set up for the maximum power with CAT-M1 link data modulation and link up with simulator. Set the EUT to transmit under low, middle and high channel and record the power level shown on simulator.

#### 4.1.3 TESTSETUP LAYOUT

Conducted Power Measurement

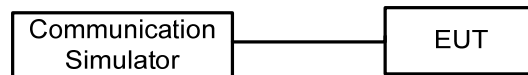

#### 4.1.4 TEST DEVIATION

No deviation

#### 4.1.5 TEST RESULTS

Please refer to the Appendix A.

## 4.2 OCCUPIED BANDWIDTH MEASUREMENT

### 4.2.1 TEST PROCEDURE

The EUT makes a call to the communication simulator. All measurements were done at low, middle and high operational frequency range. The communication simulator station system controlled a EUT to export maximum output power under transmission mode and specific channel frequency. Use OBW measurement function of Spectrum analyzer to measure 99 % occupied bandwidth and 26dB bandwidth.

### 4.2.2 TEST SETUP LAYOUT

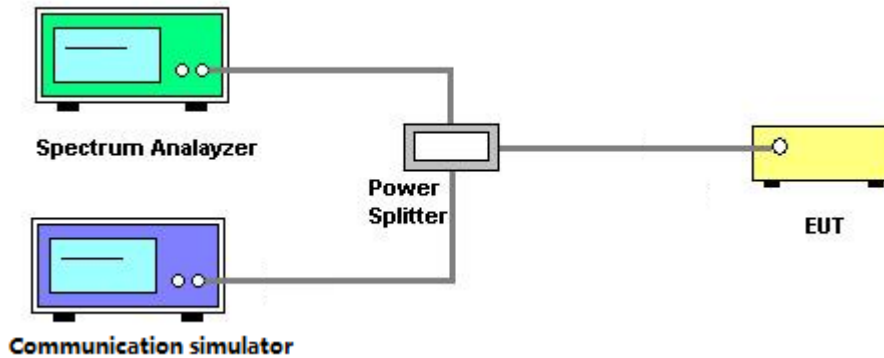

### 4.2.3 TEST DEVIATION

No deviation

### 4.2.4 TEST RESULTS

Please refer to the Appendix B.

### 4.3 CONDUCTED EMISSIONS MEASUREMENT

#### 4.3.1 LIMIT

The power of any emission outside of the authorized operating frequency ranges must be attenuated below the transmitting power (P) by a factor of at least  $43 + 10 \log(P)$  dB. The emission limit equal to  $-13\text{dBm}$ .

#### 4.3.2 TEST PROCEDURES

1. The testing follows FCC KDB 971168 v03 Section 6.0.
2. The EUT was connected to spectrum analyzer and system simulator via a power divider.
3. The band edges of low and high channels for the highest RF powers were measured. Set  $\text{RBW} \geq 1\%$  EBW in the 1MHz band immediately outside and adjacent to the band edge.
4. Set spectrum analyzer with RMS detector.
5. The RF fundamental frequency should be excluded against the limit line in the operating frequency band.
6. The limit line is derived from  $43+10\log(P)\text{dB}$  below the transmitter power P(Watts)  
 $=P(W)-[43+10\log(P)](\text{dB})$   
 $=[30+10\log(P)](\text{dBm})-[43+10\log(P)](\text{dB})$   
 $=-13\text{dBm}$

#### 4.3.3 TESTSETUP LAYOUT

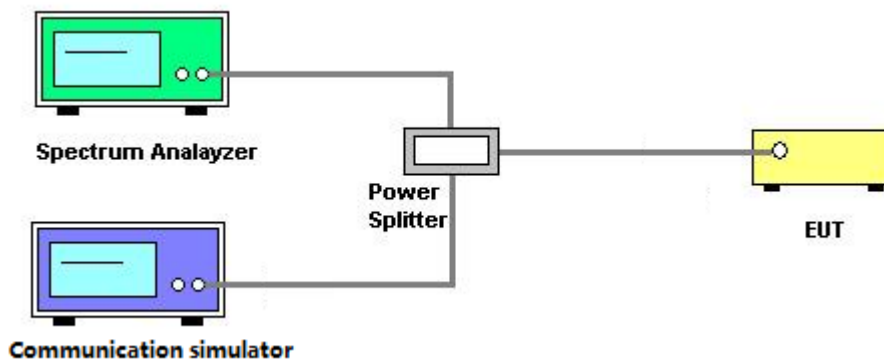

#### 4.3.4 TESTDEVIATION

No deviation

#### 4.3.5 TEST RESULTS

Please refer to the Appendix C.

#### 4.4 RADIATED EMISSIONS MEASUREMENT

##### 4.4.1 LIMIT

The power of any emission outside of the authorized operating frequency ranges must be attenuated below the transmitting power (P) by a factor of at least  $43 + 10 \log(P)$  dB. The emission limit equal to  $-13\text{dBm}$ .

##### 4.4.2 TEST PROCEDURES

1. In the semi-anechoic chamber, EUT placed on the 0.8m height of Turn Table, rotated the table around 360 degrees to search the maximum radiation power and receiver antenna shall be rotated vertical and horizontal polarization and moved height from 1m to 4m to find the maximum polar radiated power. The "Read Value" is the spectrum reading the maximum power value.
2. The substitution horn antenna is substituted for EUT at the same position and signals generator export the CW signal to the substitution antenna via a TX cable. Rotated the Turn Table and moved receiving antenna to find the maximum radiation power. Adjust output power level of S.G to get a Value of spectrum reading equal to "Read Value" of step a. Record the power level of S.G
3.  $\text{EIRP} = \text{Output power level of S.G} - \text{TX cable loss} + \text{Antenna gain of substitution horn}$ .
4. E.R.P power can be calculated form E.I.R.P power by subtracting the gain of dipole,  $\text{E.R.P power} = \text{E.I.P.R power} - 2.15\text{dBi}$ .
5. The resolution bandwidth and video bandwidth of test receiver/spectrum analyzer is 1MHz/3MHz.

##### 4.4.3 TESTSETUP LAYOUT

Below 30MHz

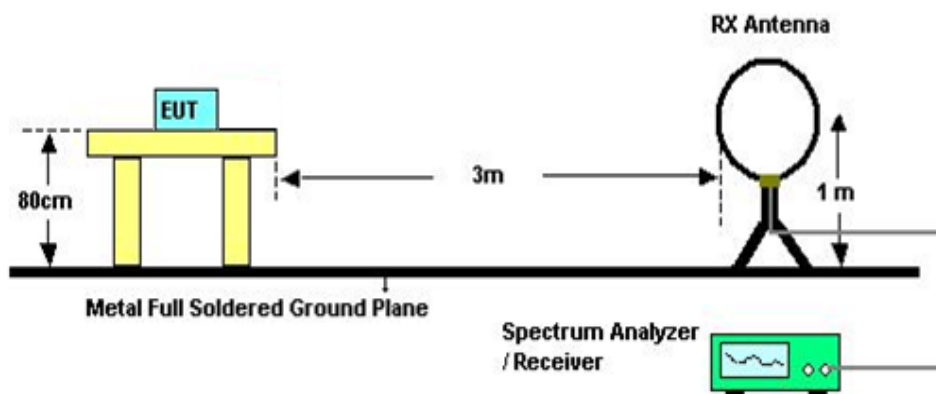

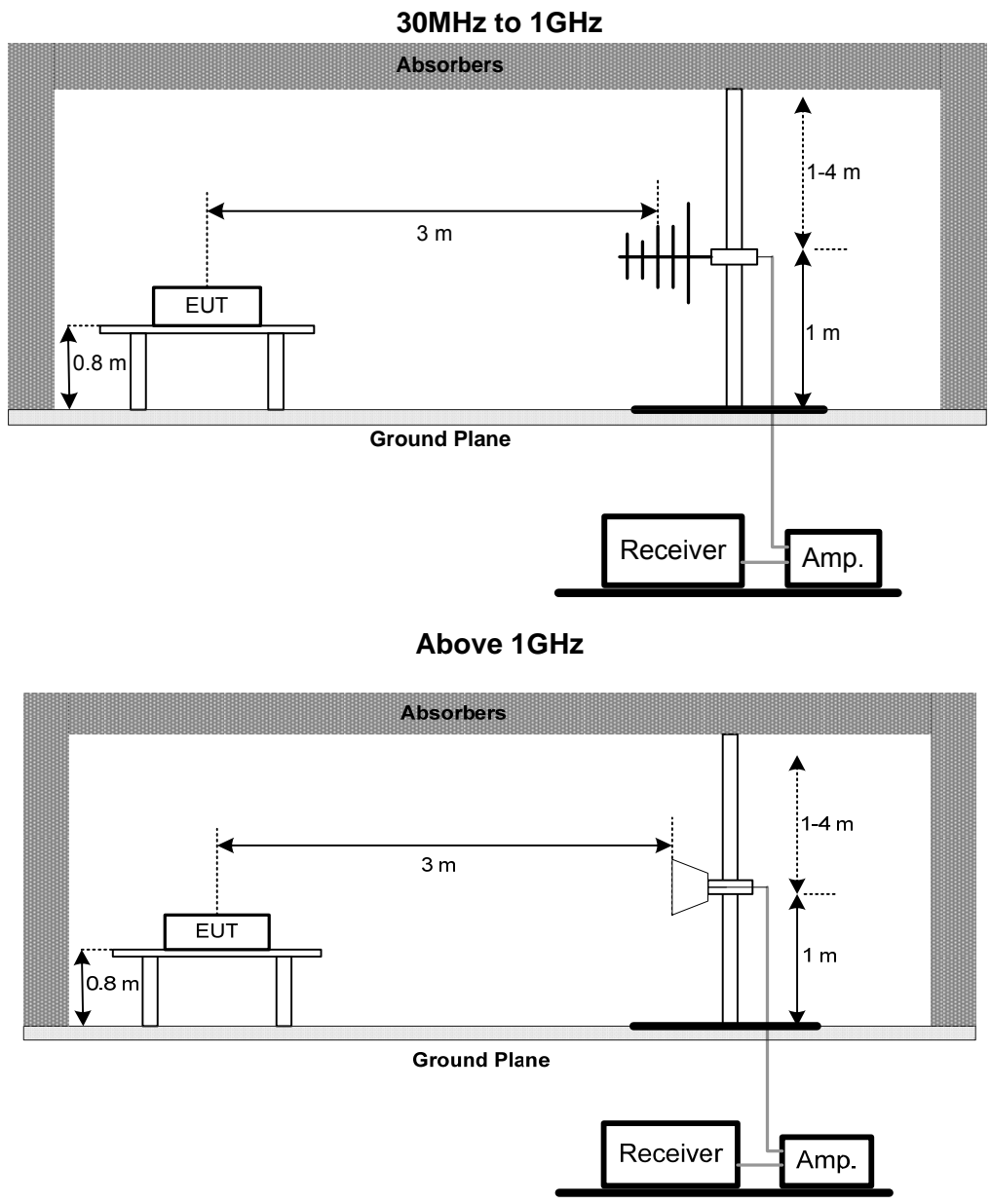

**4.4.4 TEST DEVIATION**

No deviation

**4.4.5 TEST RESULTS**

Please refer to the Appendix D.



## 4.5 BAND EDGE MEASUREMENT

### 4.5.1 LIMIT

A Power of any emission outside of the authorized operating frequency ranges must be attenuated below the transmitting power (P) by a factor of at least  $43 + 10 \log(P)$  dB. In the 1 MHz bands immediately outside and adjacent to the frequency block a resolution bandwidth of at least one percent of the emission bandwidth of the fundamental emission of the transmitter may be employed.

### 4.5.2 TEST PROCEDURES

1. All measurements were done at low and high operational frequency range.
2.  $RBW = 99\%OBW * (1\% \sim 5\%)$   
 $VBW \geq 3 * RBW$
3. Record the max trace plot into the test report.

### 4.5.3 TESTSETUP LAYOUT

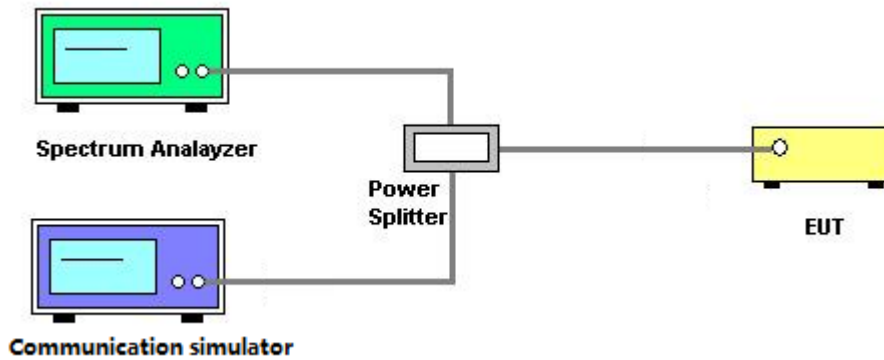

### 4.5.4 TESTDEVIATION

No deviation

### 4.5.5 TEST RESULTS

Please refer to the Appendix E.

## 4.6 PEAK TO AVERAGE RATIO MEASUREMENT

### 4.6.1 LIMIT

In measuring transmissions in this band using an average power technique, the peak to-average ratio (PAR) of the transmission may not exceed 13 dB.

### 4.6.2 TEST PROCEDURES

1. Set resolution/measurement bandwidth  $\geq$  signal's occupied bandwidth;
2. Set the number of counts to a value that stabilizes the measured CCDF curve;
3. Record the maximum PAPR level associated with a probability of 0.1%.

### 4.6.3 TESTSETUP LAYOUT

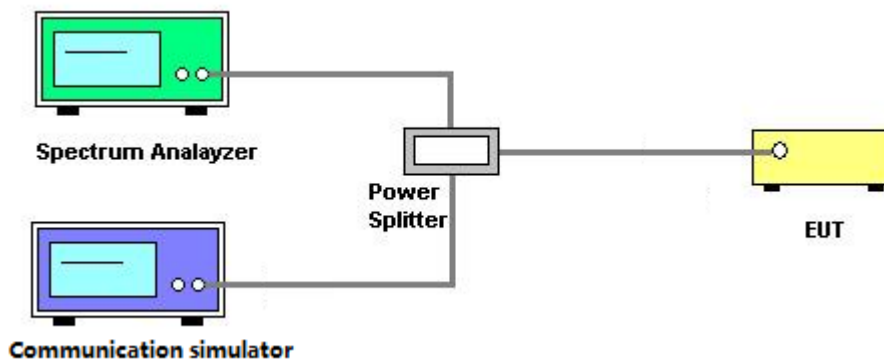

### 4.6.4 TESTDEVIATION

No deviation

### 4.6.5 TEST RESULTS

Please refer to the Appendix F.

## 4.7 FREQUENCY STABILITY MEASUREMENT

### 4.7.1 LIMIT

1.5 ppm is for base and fixed station. 2.5 ppm is for mobile station.

### 4.7.2 TEST PROCEDURES

1. Device is placed at the oven room. The oven room could control the temperatures and humidity. Power warm up is at least 15 min and power applied should perform before recording frequency error.
2. EUT is connected the external power supply to control the DC input power. The test voltage range is from minimum to maximum working voltage. Each step shall be record the frequency error rate.
3. The temperature range step is 10 degrees in this test items. All temperature levels shall be hold the  $\pm 0.5^{\circ}\text{C}$  during the measurement testing. The each temperature step shall be at least 0.5 hours, consider the EUT could be test under the stability condition.
4. The frequency error was recorded frequency error from the communication simulator.

### 4.7.3 TESTSETUP LAYOUT

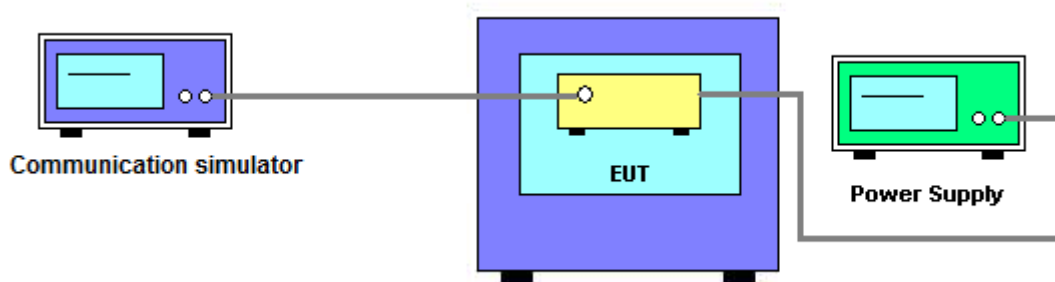

### 4.7.4 TESTDEVIATION

No deviation

### 4.7.5 TEST RESULTS

Please refer to the Appendix G.

## 5. LIST OF MEASUREMENT EQUIPMENTS

Radiated Emission Measurement					
Item	Kind of Equipment	Manufacturer	Type No.	Serial No.	Calibrated until
1	Antenna	Schwarbeck	VULB9160	9160-3232	Mar. 26, 2018
2	Amplifier	Agilent	8449B	3008A02274	May. 16, 2018
3	Amplifier	HP	8447D	2944A09673	Oct. 19, 2018
4	HighPass Filter	Wairwright Instruments Gmbh	WHK 1.5/15G-10ST	11	Feb. 20, 2018
5	Band Reject Filter	Wairwright Instruments Gmbh	WRCG 1710/1785-1690/180 5-60/12SS	38	Feb. 15, 2018
6	Band Reject Filter	Wairwright Instruments Gmbh	WRCG 824/849-810/863-60/ 9SS	7	Feb. 15, 2018
7	Band Reject Filter	Wairwright Instruments Gmbh	WRCG 880/915-860/935-60/ 9SS	14	Feb. 15, 2018
8	Band Reject Filter	Wairwright Instruments Gmbh	WRCG 1850/1910-1830/193 0-60/10SS	17	Feb. 15, 2018
9	HighPass Filter	Wairwright Instruments Gmbh	WHK3.1/18G-10SS	24	Feb. 20, 2018
10	Wireless Communication Test SET	Agilent	E5515C	MY48364183	Mar. 26, 2018
11	Microwave Preamplifier With Adaptor	EMC INSTRUMENT	EMC2654045	980039 & HA01	Mar. 26, 2018
12	Receiver	Agilent	N9038A	MY52130039	Aug. 20, 2018
13	wideband radio communication tester	R&S	CMW500	152372	Mar. 26, 2018
14	High pass filter	KANGMAIWEI	ZHPF-M3-12.75G-38 69	B2015073763	Aug. 04, 2018
15	High pass filter	KANGMAIWEI	ZHPF-M1000-4000-1	B2015073762	Aug. 04, 2018
16	High pass filter	KANGMAIWEI	ZHPF-M6-186-1727	B2015073764	Aug. 04, 2018
17	Cable	emci	LMR-400(30MHz-1G Hz)(8m+5m)	N/A	Jun. 26, 2018
18	Cable	emci	EMC104-SM-SM-120 00(12m)	N/A	Jun. 26, 2018
19	Controller	ETS-Lindgren	2090	N/A	N/A
20	Measurement Software	Farad	EZ-EMC Ver.NB-03A1-01	N/A	N/A
21	Double Ridged Guide Antenna	ETS	3115	75789	Mar. 26, 2018
22	Broad-Band Horn Antenna	Schwarzbeck	BBHA 9170	9170319	Apr. 22, 2018
23	Antenna	EM	EM-6876-1	230	Mar. 06, 2018

Conducted Emission & Band Edge & Occupied Bandwidth Measurement					
Item	Kind of Equipment	Manufacturer	Type No.	Serial No.	Calibrated until
1	EXA Spectrum Analyzer	Agilent	N9010A	MY50520044	Mar. 26, 2018
2	POWER SPLITTER	Mini-Circuits	ZFRSC-123-S+	331000910-1	May. 16, 2018
3	wideband radio communication tester	R&S	CMW500	152372	Mar. 26, 2018

Frequency Stability Measurement					
Item	Kind of Equipment	Manufacturer	Type No.	Serial No.	Calibrated until
1	Multi-output DC Power Supply	GW Instek	GPC-3030DN	EK880675	Sep. 26, 2020
2	POWER SPLITTER	Mini-Circuits	ZFRSC-123-S+	331000910-1	May. 16, 2018
3	wideband radio communication tester	R&S	CMW500	152372	Mar. 26, 2018
4	Const Temp.& Humidity Chamber	Bell	BTH-50C	20170306001	Mar. 26, 2018

Remark: "N/A" denotes no model name, serial no. or calibration specified.

## APPENDIX A - OUTPUT POWER

Test Mode: eMTC Band 2 - QPSK

Bandwidth	Channel	Frequency (MHz)	RB size	RB Offset	Index	Conducted Power	EIRP Power
5M	18625	1852.5	1	0	0	22.77	25.27
			6	0	0	22.81	25.31
	18900	1880	1	0	0	22.64	25.14
			6	0	0	22.68	25.18
	19175	1907.5	1	5	3	22.83	25.33
			6	0	3	22.79	25.29
10M	18650	1855	1	0	0	22.78	25.28
			4	0	0	22.74	25.24
	18900	1880	1	0	0	22.49	24.99
			4	0	0	22.38	24.88
	19150	1905	1	5	7	22.59	25.09
			4	2	7	22.53	25.03
15M	18675	1857.5	1	0	0	22.41	24.91
			6	0	0	22.39	24.89
	18900	1880	1	0	0	22.59	25.09
			6	0	0	22.54	25.04
	19125	1902.5	1	5	11	22.58	25.08
			6	0	11	22.63	25.13
20M	18700	1860	1	0	0	22.61	25.11
			6	0	0	22.66	25.16
	18900	1880	1	0	0	22.37	24.87
			6	0	0	22.31	24.81
	19100	1900	1	5	15	22.61	25.11
			6	0	15	22.56	25.06

Test Mode: eMTC Band 2 - 16QAM

Bandwidth	Channel	Frequency (MHz)	RB size	RB Offset	Index	Conducted Power	EIRP Power
5M	18625	1852.5	1	0	0	22.74	25.24
			5	0	0	22.44	24.94
	18900	1880	1	0	0	22.87	25.37
			5	0	0	22.32	24.82
	19175	1907.5	1	5	3	22.83	25.33
			5	0	3	22.48	24.98
10M	18650	1855	1	0	0	22.89	25.39
			4	0	0	22.79	25.29
	18900	1880	1	0	0	22.72	25.22
			4	0	0	22.35	24.85
	19150	1905	1	5	7	22.62	25.12
			4	2	7	22.53	25.03
15M	18675	1857.5	1	0	0	22.41	24.91
			5	0	0	22.37	24.87
	18900	1880	1	0	0	22.43	24.93
			5	0	0	22.23	24.73
	19125	1902.5	1	5	11	22.65	25.15
			5	0	11	22.35	24.85
20M	18700	1860	1	0	0	22.6	25.1
			5	0	0	22.34	24.84
	18900	1880	1	0	0	22.29	24.79
			5	0	0	22.19	24.69
	19100	1900	1	5	15	22.62	25.12
			5	0	15	22.31	24.81



## APPENDIX B - OCCUPIED BANDWIDTH

eMTC Band 2_5M					
QPSK			16QAM		
Channel	Frequency (MHz)	99% Occupied Bandwidth (MHz)	Channel	Frequency (MHz)	99% Occupied Bandwidth (MHz)
18900	1880	1.1390	18900	1880	1.0459
Channel	Frequency (MHz)	26dB Bandwidth (MHz)	Channel	Frequency (MHz)	26dB Bandwidth (MHz)
18900	1880	1.480	18900	1880	1.528

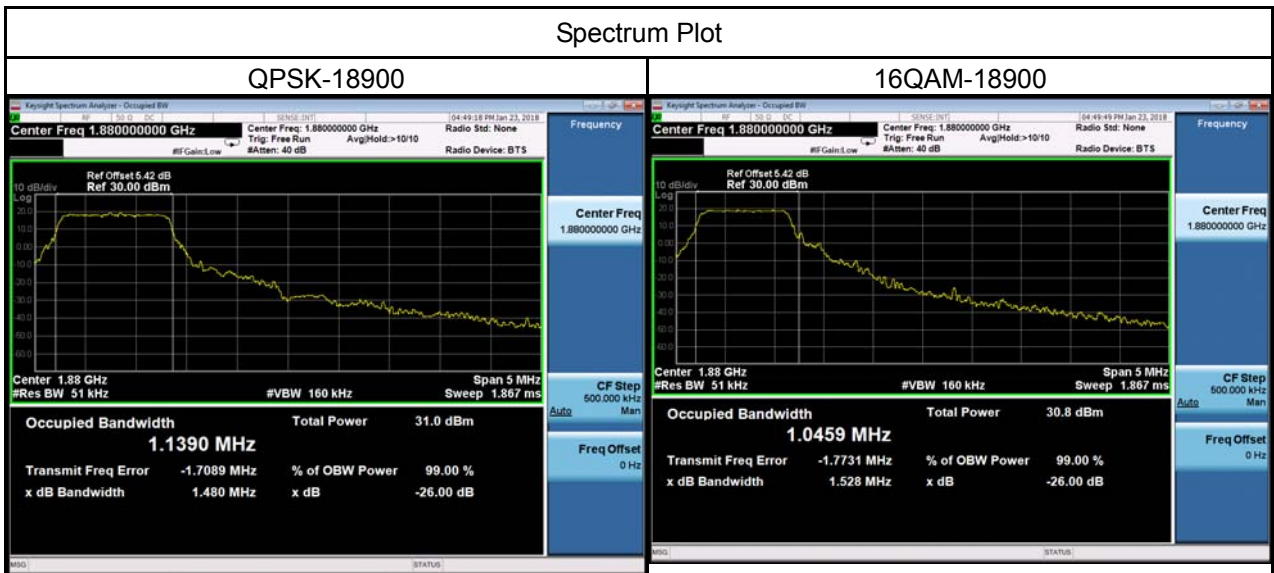

eMTC Band 2_10M					
QPSK			16QAM		
Channel	Frequency (MHz)	99% Occupied Bandwidth (MHz)	Channel	Frequency (MHz)	99% Occupied Bandwidth (MHz)
18900	1880	1.1611	18900	1880	1.0161
Channel	Frequency (MHz)	26dB Bandwidth (MHz)	Channel	Frequency (MHz)	26dB Bandwidth (MHz)
18900	1880	1.516	18900	1880	1.511

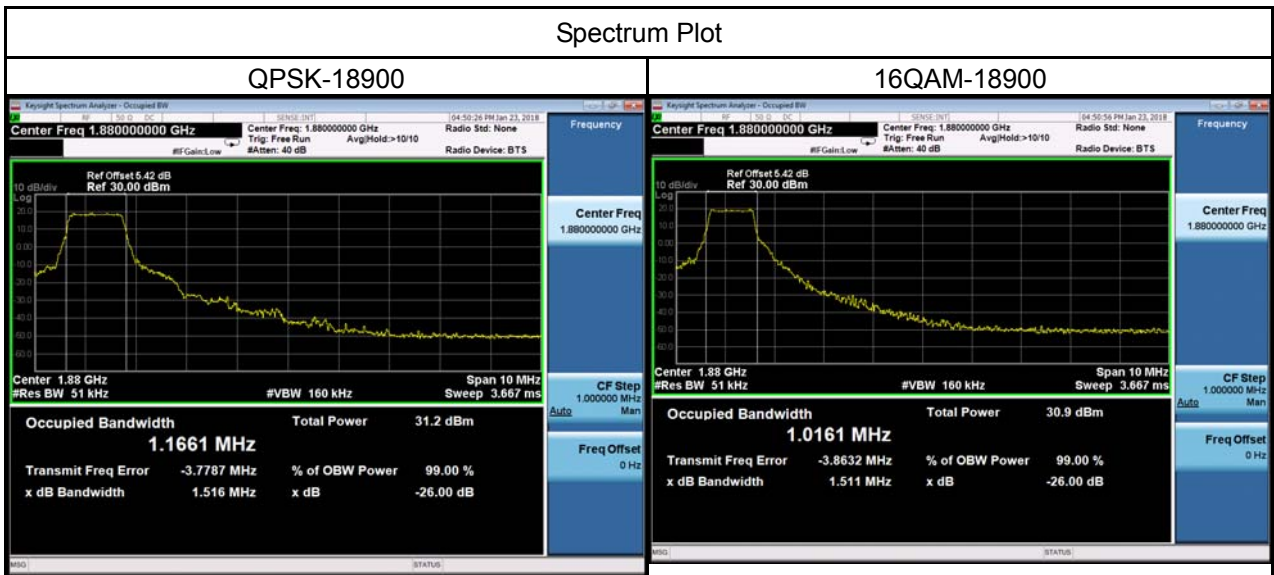

eMTC Band 2_15M					
QPSK			16QAM		
Channel	Frequency (MHz)	99% Occupied Bandwidth (MHz)	Channel	Frequency (MHz)	99% Occupied Bandwidth (MHz)
18900	1880	1.1720	18900	1880	1.0422
Channel	Frequency (MHz)	26dB Bandwidth (MHz)	Channel	Frequency (MHz)	26dB Bandwidth (MHz)
18900	1880	1.502	18900	1880	1.598

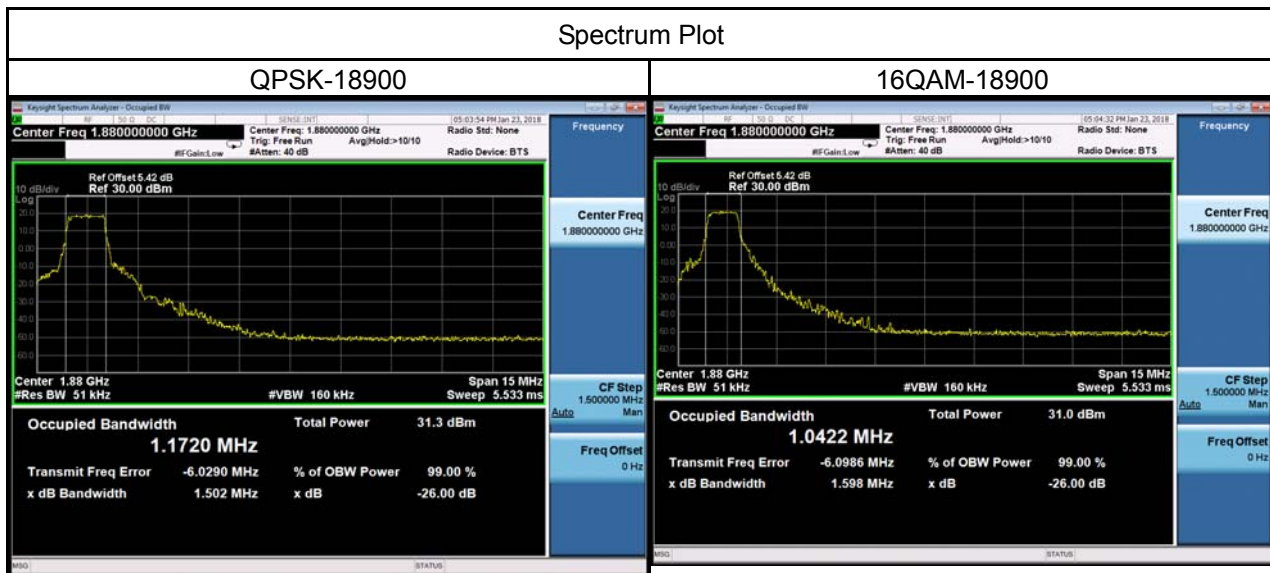

eMTC Band 2_20M					
QPSK			16QAM		
Channel	Frequency (MHz)	99% Occupied Bandwidth (MHz)	Channel	Frequency (MHz)	99% Occupied Bandwidth (MHz)
18900	1880	1.1619	18900	1880	1.0334
Channel	Frequency (MHz)	26dB Bandwidth (MHz)	Channel	Frequency (MHz)	26dB Bandwidth (MHz)
18900	1880	1.536	18900	1880	1.471

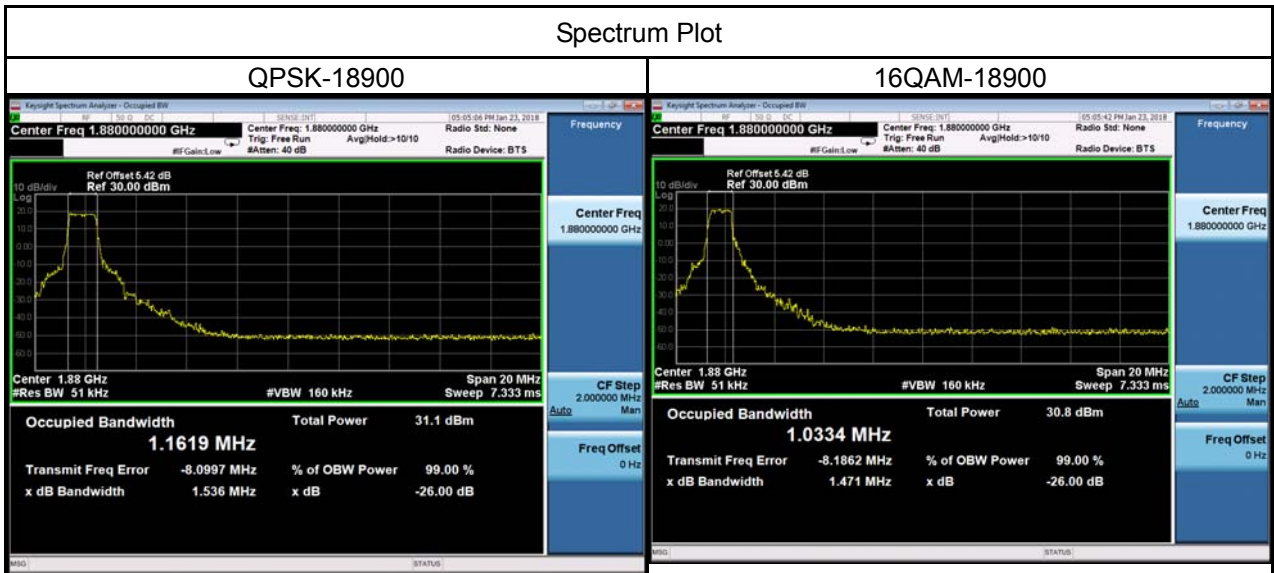

## APPENDIX C - CONDUCTED EMISSIONS

eMTC Band 2\_5M

Channel	Frequency(MHz)	Channel	Frequency(MHz)
18900	1880	18900	1880
Date: 18.JAN.2018 18:13:25		Date: 18.JAN.2018 18:14:08	
Channel	Frequency(MHz)	-	-
18900	1880	-	-

eMTC Band 2\_10M

Channel	Frequency(MHz)	Channel	Frequency(MHz)
18900	1880	18900	1880
Date: 18.JAN.2018 18:17:30		Date: 18.JAN.2018 18:14:56	
Channel	Frequency(MHz)	-	-
18900	1880	-	-



eMTC Band 2\_15M

Channel	Frequency(MHz)	Channel	Frequency(MHz)
18900	1880	18900	1880
Date: 18.JAN.2018 18:17:05		Date: 18.JAN.2018 18:15:25	
Channel	Frequency(MHz)	-	-
18900	1880	-	-

eMTC Band 2\_20M

Channel	Frequency(MHz)	Channel	Frequency(MHz)
18900	1880	18900	1880
Date: 18.JAN.2018 18:15:56			
Channel	Frequency(MHz)	-	-
18900	1880	-	-

## APPENDIX D - RADIATED EMISSION

Test Mode: TX Mode

Ant 0°

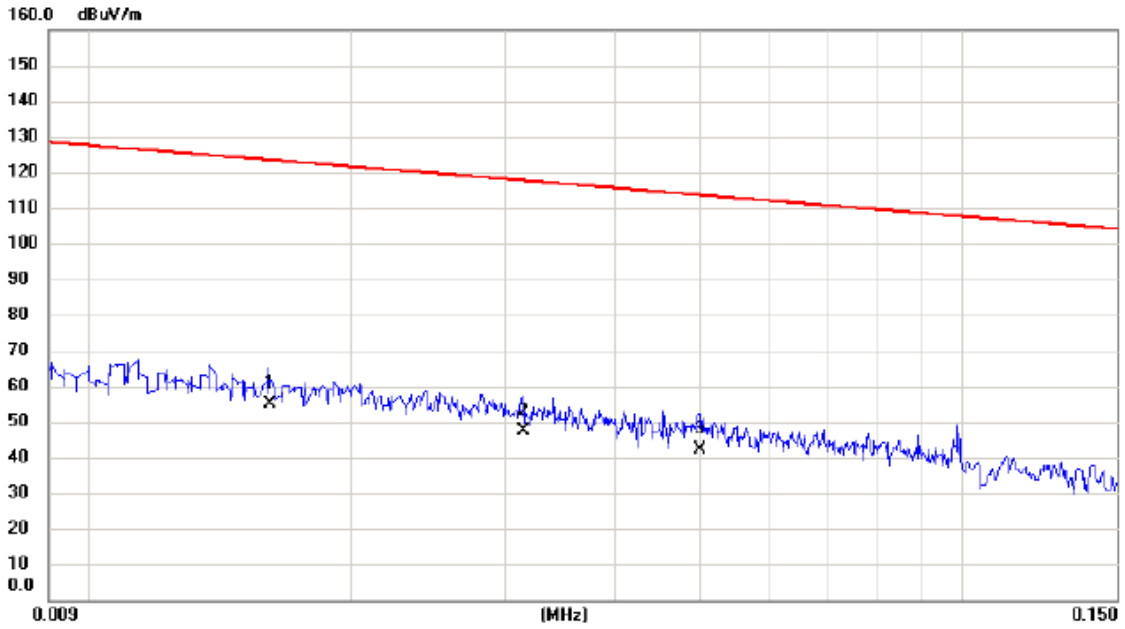

No.	Mk.	Freq. MHz	Reading Level dBuV	Correct Factor dB	Measure- ment dBuV/m	Limit dBuV/m	Margin dB	Detector	Comment
1	*	0.0161	35.03	20.13	55.16	123.47	-68.31	AVG	
2		0.0314	28.08	19.28	47.36	117.67	-70.31	AVG	
3		0.0500	23.57	18.72	42.29	113.63	-71.34	AVG	

Test Mode: TX Mode

Ant 0°

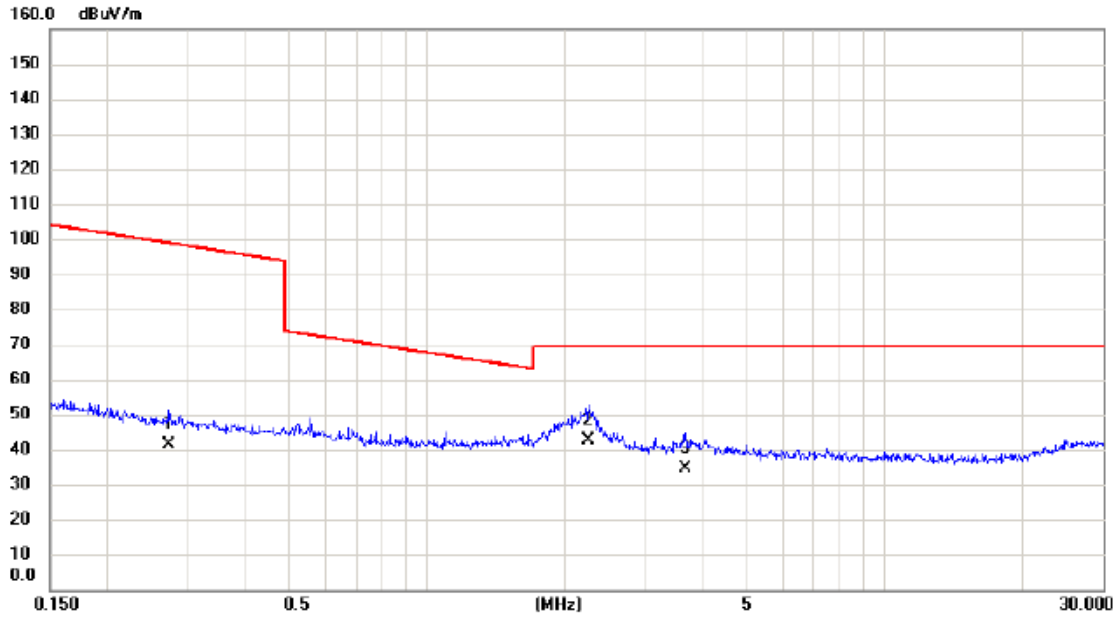

No.	Mk.	Freq. MHz	Reading Level dBuV	Correct Factor dB	Measure- ment dBuV/m	Limit dBuV/m	Margin dB	Detector	Comment
1		0.2730	24.60	16.64	41.24	98.88	-57.64	AVG	
2	*	2.2486	27.00	15.44	42.44	69.54	-27.10	QP	
3		3.6611	19.37	15.04	34.41	69.54	-35.13	QP	

Test Mode: TX Mode

Ant 90°

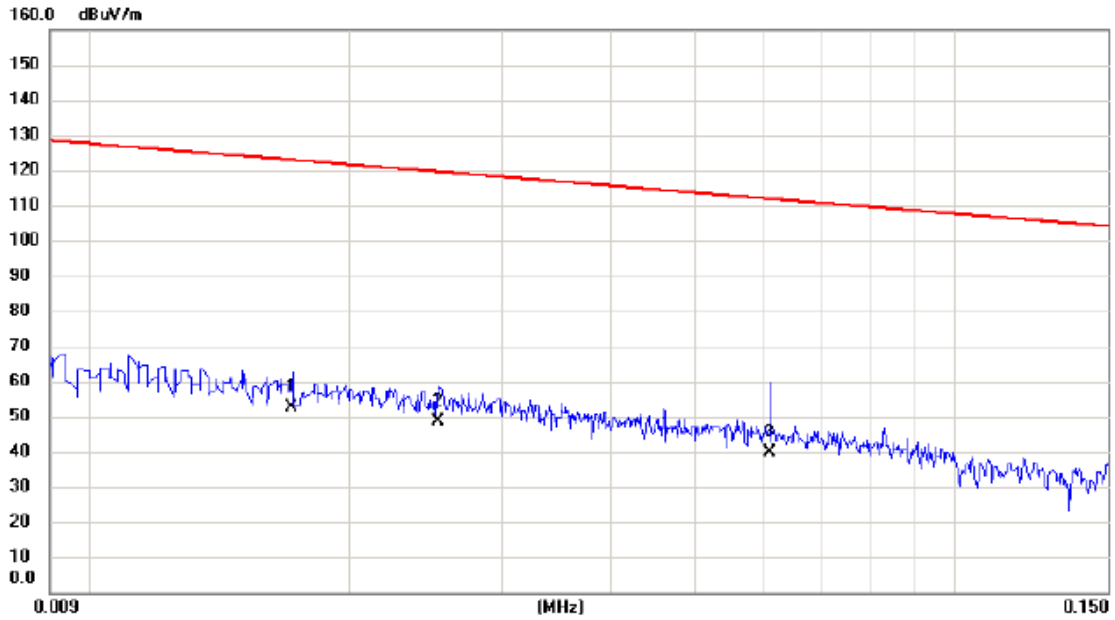

No.	Mk.	Freq. MHz	Reading Level dBuV	Correct Factor dB	Measure- ment dBuV/m	Limit dBuV/m	Margin dB	Detector	Comment
1	*	0.0171	32.67	20.00	52.67	122.94	-70.27	AVG	
2		0.0253	28.96	19.46	48.42	119.54	-71.12	AVG	
3		0.0610	21.10	18.51	39.61	111.90	-72.29	AVG	

Test Mode: TX Mode

Ant 90°

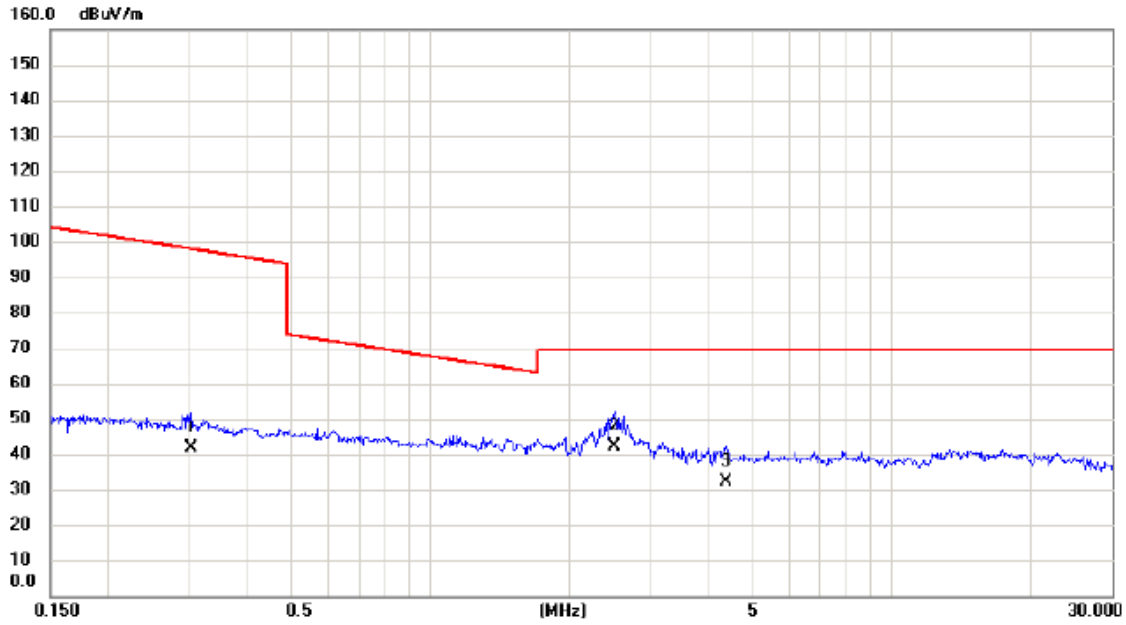

No.	Mk.	Freq. MHz	Reading Level dBuV	Correct Factor dB	Measure- ment dBuV/m	Limit dBuV/m	Margin dB	Detector	Comment
1		0.3034	25.08	16.62	41.70	97.96	-56.26	AVG	
2	*	2.5131	26.74	15.37	42.11	69.54	-27.43	QP	
3		4.3837	17.66	14.73	32.39	69.54	-37.15	QP	

Test Mode: eMTC Band 2\_TX CH19157\_5M

Vertical

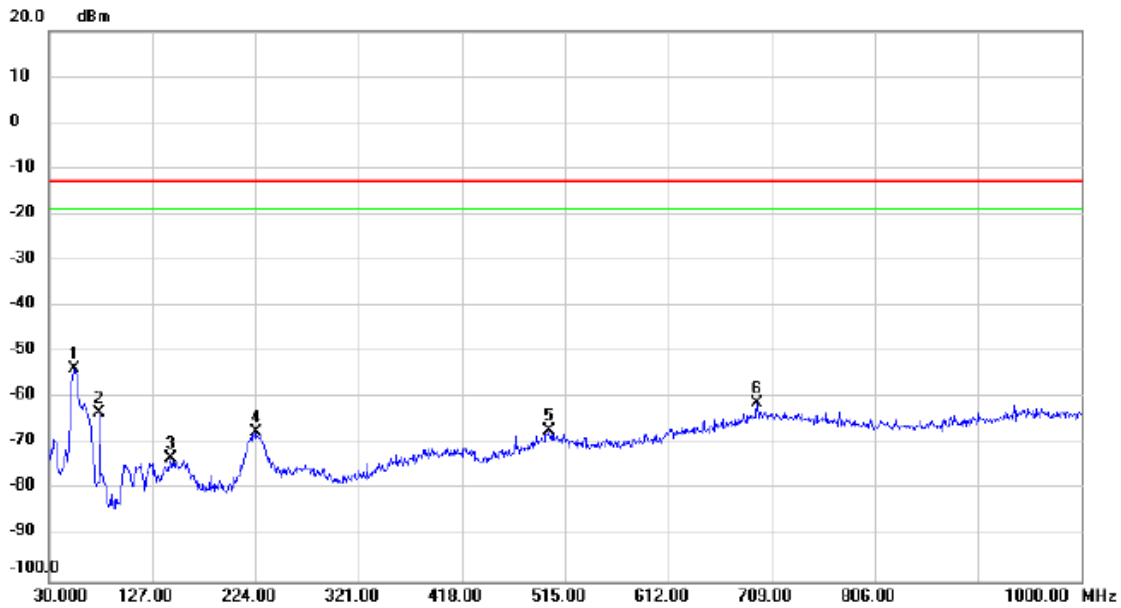

No.	Mk.	Freq. MHz	Reading Level dBm	Correct Factor dB	Measure- ment dBm	Limit dBm	Margin dB	Detector	Comment
1	*	54.250	-55.94	2.40	-53.54	-13.00	-40.54	peak	
2		77.530	-57.70	-5.60	-63.30	-13.00	-50.30	peak	
3		144.460	-75.69	2.60	-73.09	-13.00	-60.09	peak	
4		224.000	-66.83	-0.64	-67.47	-13.00	-54.47	peak	
5		499.480	-74.61	7.52	-67.09	-13.00	-54.09	peak	
6		695.420	-71.60	10.45	-61.15	-13.00	-48.15	peak	



Test Mode: eMTC Band 2\_TX CH19157\_5M

### Horizontal

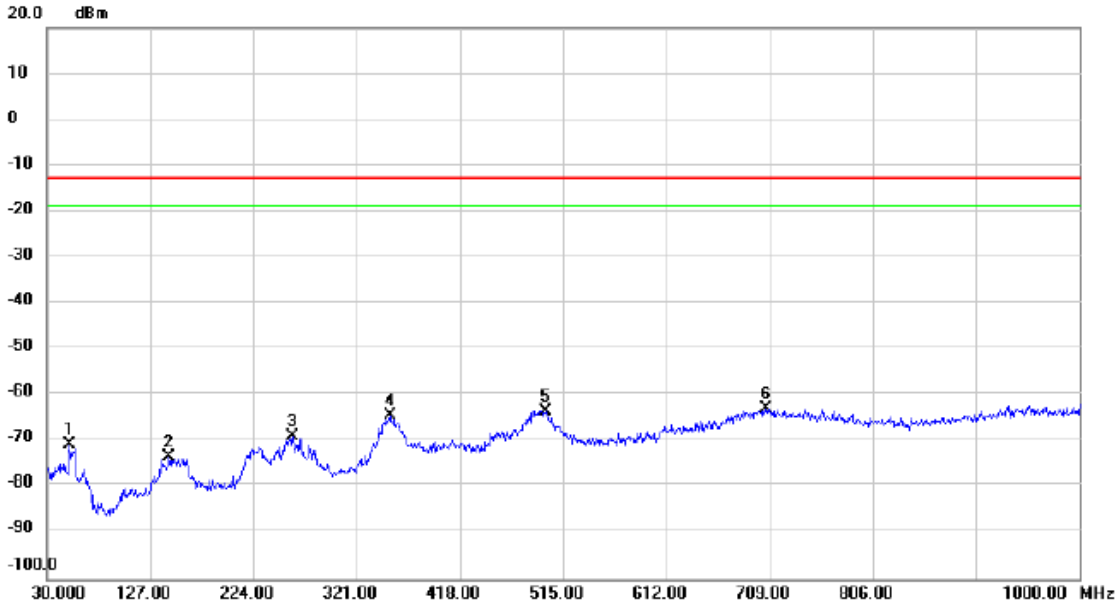

No.	Mk.	Freq. MHz	Reading Level dBm	Correct Factor dB	Measure- ment dBm	Limit dBm	Margin dB	Detector	Comment
1		51.340	-72.34	1.64	-70.70	-13.00	-57.70	peak	
2		144.460	-76.99	3.63	-73.36	-13.00	-60.36	peak	
3		260.860	-71.09	2.02	-69.07	-13.00	-56.07	peak	
4		352.040	-67.60	3.25	-64.35	-13.00	-51.35	peak	
5		498.510	-71.38	7.95	-63.43	-13.00	-50.43	peak	
6	*	705.120	-76.92	13.86	-63.06	-13.00	-50.06	peak	

Test Mode: eMTC Band 2\_TX CH19157\_5M

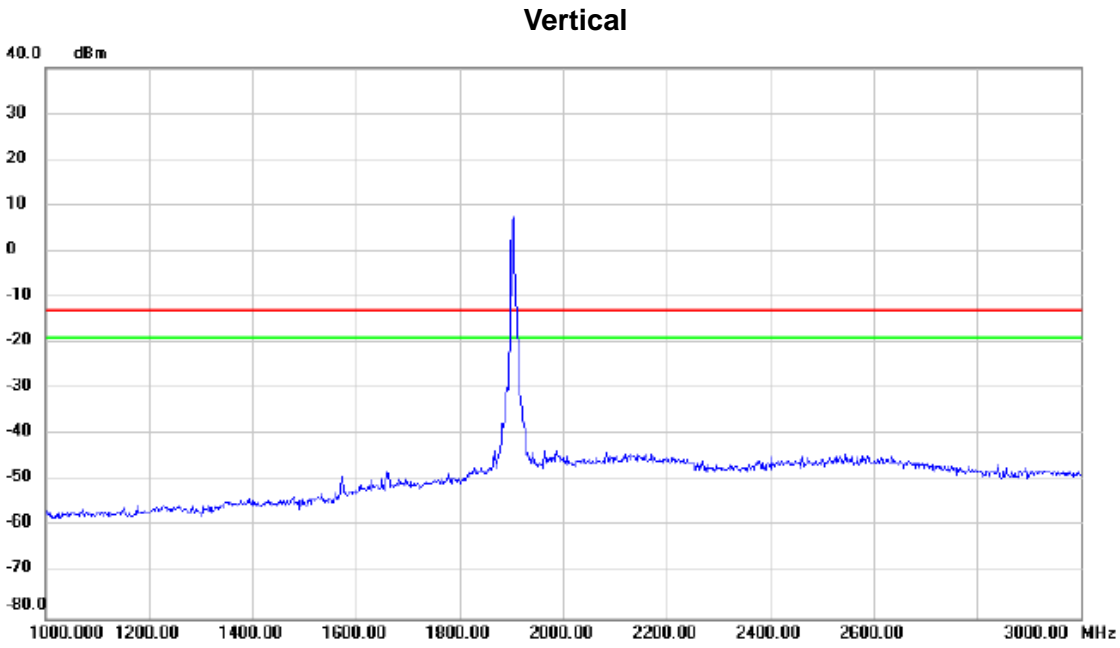

No.	Mk.	Freq.	Reading Level	Correct Factor	Measurement	Limit	Margin	Detector	Comment
		MHz	dBm	dB	dBm	dBm	dB		
		19157	~8		~8	-20	~28		

Test Mode: eMTC Band 2\_TX CH19157\_5M

Horizontal

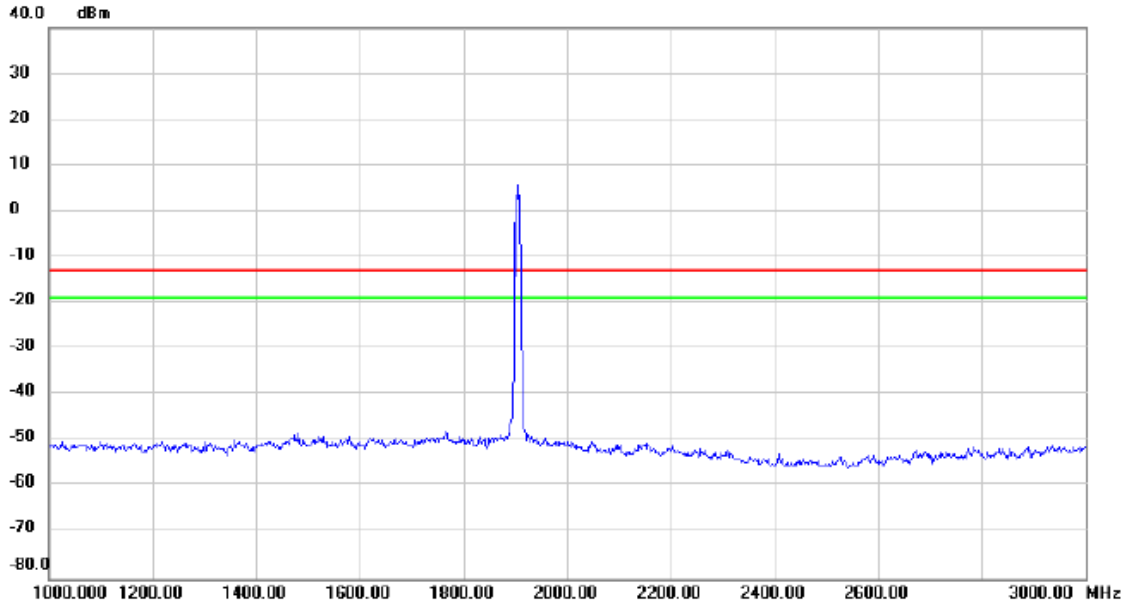

No.	Mk.	Freq.	Reading Level	Correct Factor	Measurement	Limit	Margin	Detector	Comment
		MHz	dBm	dB	dBm	dBm	dB		
		19157	5		5	-20	25		

Test Mode: eMTC Band 2\_TX CH19157\_5M

Vertical

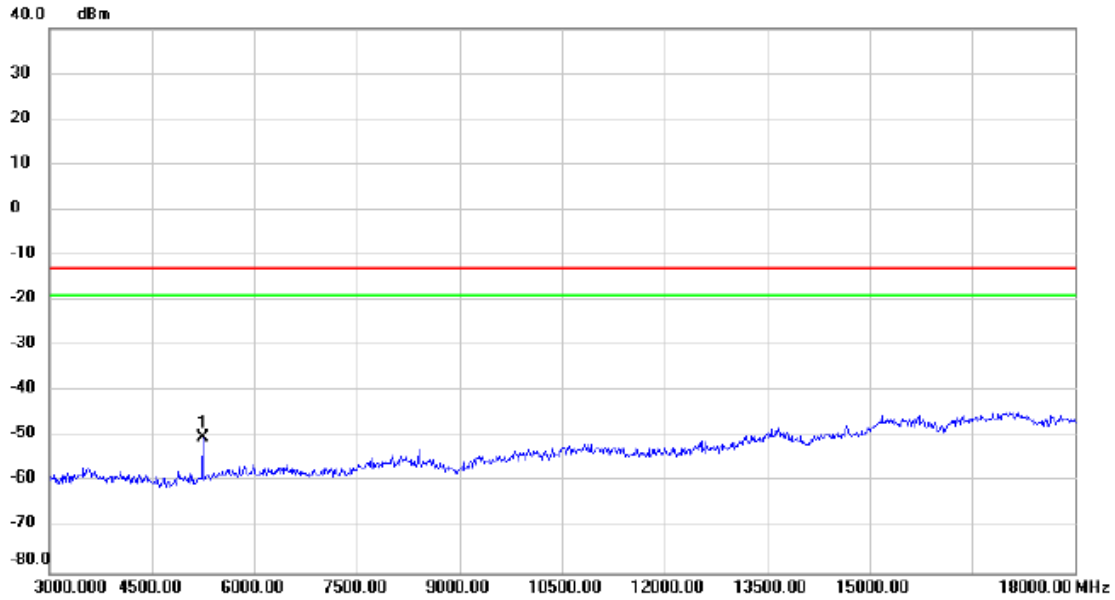

No.	Mk.	Freq. MHz	Reading Level dBm	Correct Factor dB	Measure- ment dBm	Limit dBm	Margin dB	Detector	Comment
1	*	5250.000	-65.45	15.32	-50.13	-13.00	-37.13	peak	

Test Mode: eMTC Band 2\_TX CH19157\_5M

Horizontal

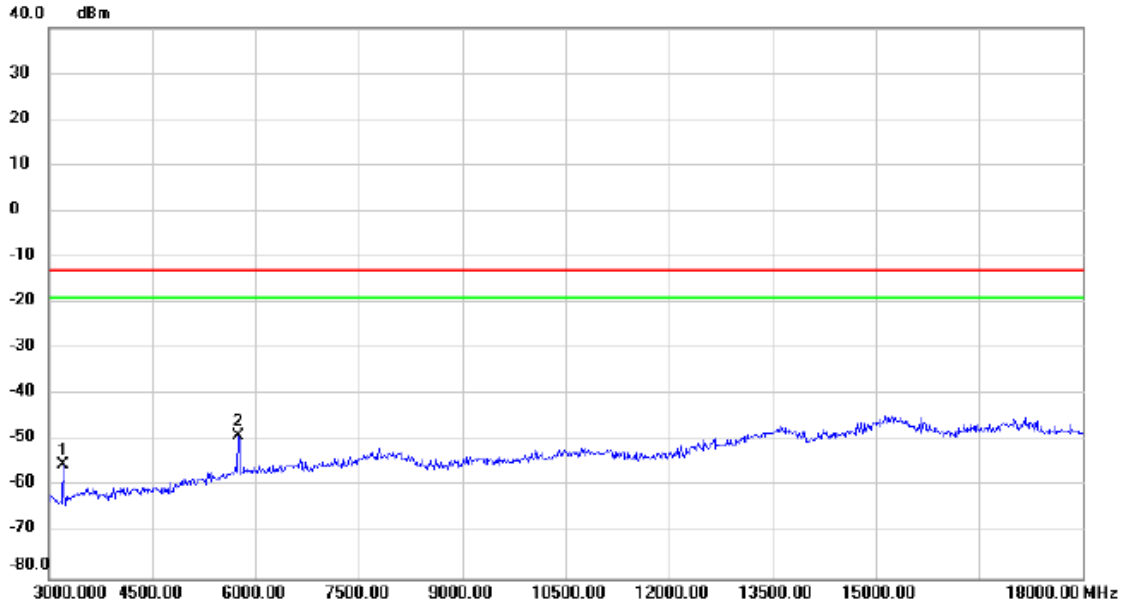

No.	Mk.	Freq. MHz	Reading Level dBm	Correct Factor dB	Measure- ment dBm	Limit dBm	Margin dB	Detector	Comment
1		3210.000	-64.84	9.52	-55.32	-13.00	-42.32	peak	
2	*	5745.000	-66.44	17.38	-49.06	-13.00	-36.06	peak	

Test Mode: eMTC Band 2\_TX CH19157\_5M

Vertical

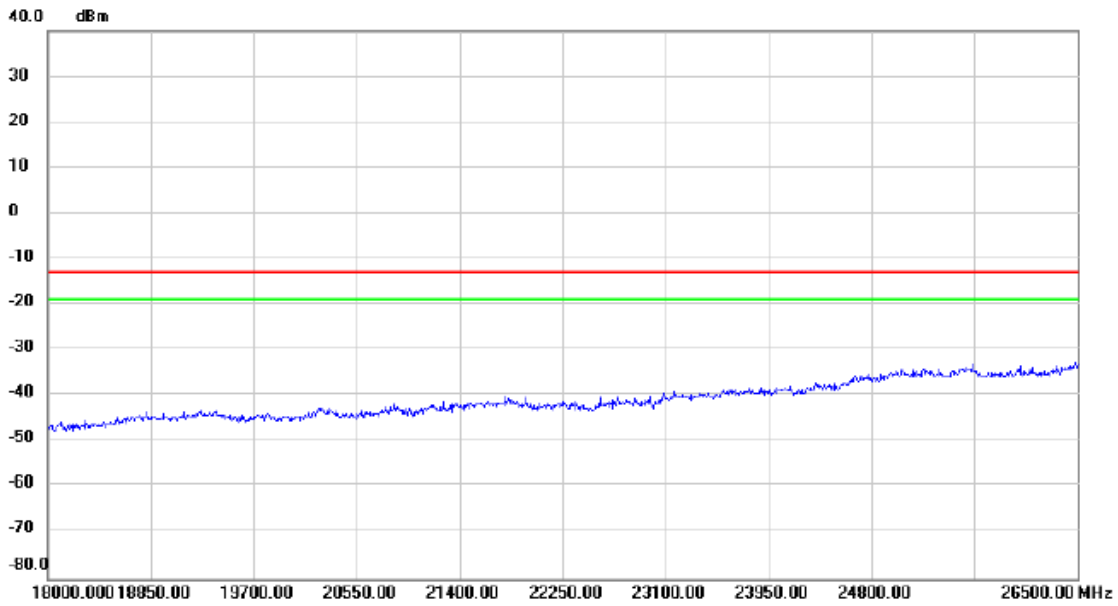

No.	Mk.	Freq.	Reading Level	Correct Factor	Measurement	Limit	Margin	Detector	Comment
		MHz	dBm	dB	dBm	dBm	dB		

Test Mode: eMTC Band 2\_TX CH19157\_5M

### Horizontal

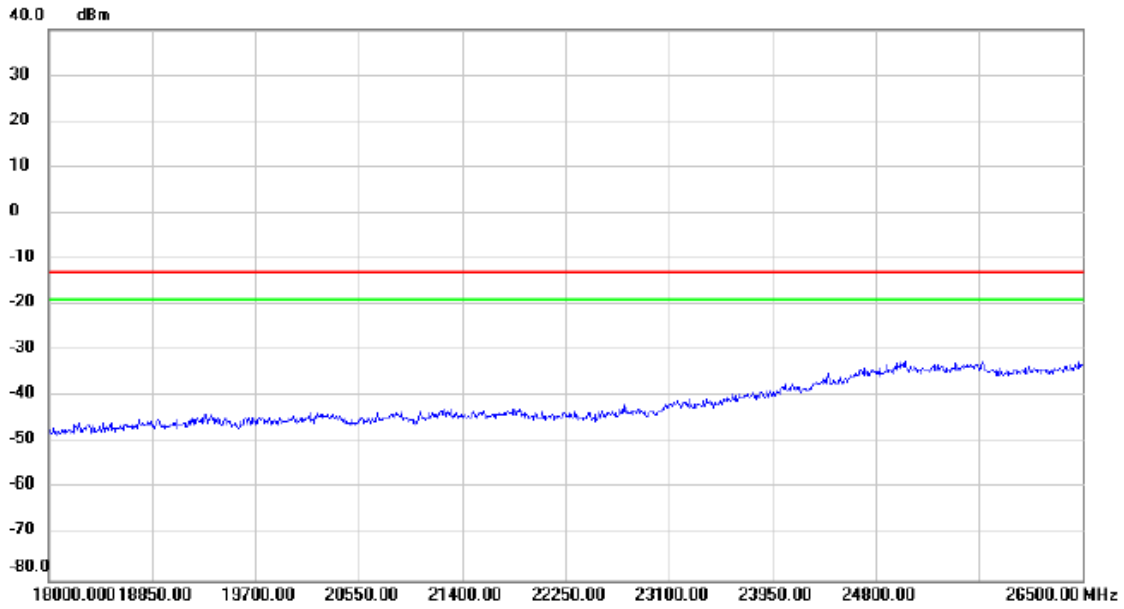

No.	Mk.	Freq.	Reading Level	Correct Factor	Measurement	Limit	Margin	Detector	Comment
		MHz	dBm	dB	dBm	dBm	dB		

Test Mode: eMTC Band 2\_TX CH18700\_20M

Vertical

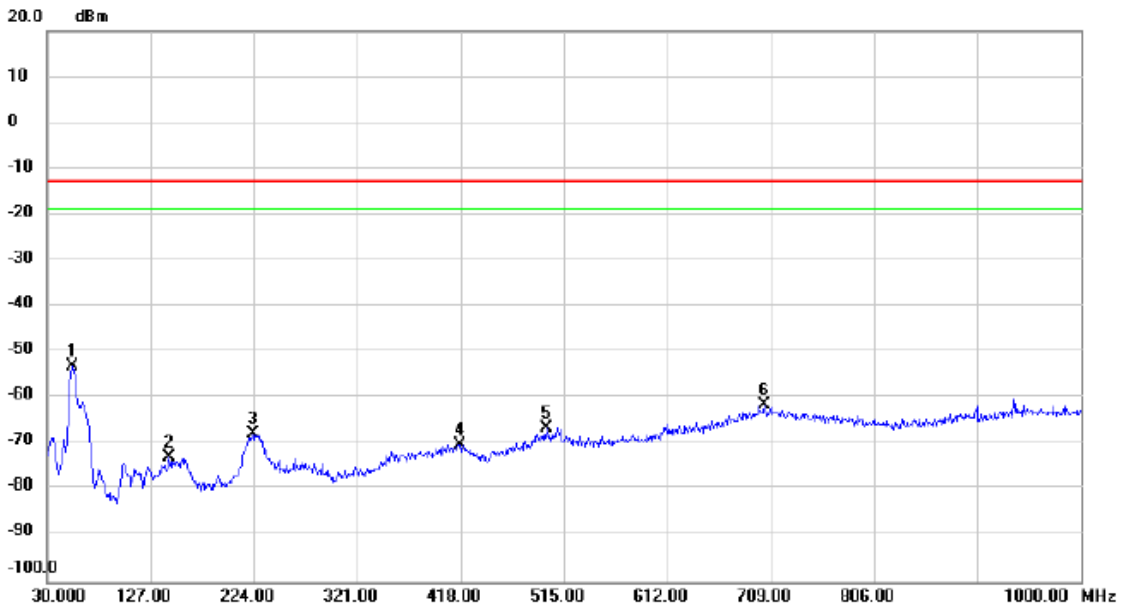

No.	Mk.	Freq. MHz	Reading Level dBm	Correct Factor dB	Measure- ment dBm	Limit dBm	Margin dB	Detector	Comment
1	*	53.280	-55.01	1.99	-53.02	-13.00	-40.02	peak	
2		144.460	-75.43	2.60	-72.83	-13.00	-59.83	peak	
3		223.030	-66.80	-0.82	-67.62	-13.00	-54.62	peak	
4		417.030	-74.62	4.57	-70.05	-13.00	-57.05	peak	
5		498.510	-73.92	7.46	-66.46	-13.00	-53.46	peak	
6		703.180	-72.10	10.61	-61.49	-13.00	-48.49	peak	



Test Mode: eMTC Band 2\_TX CH18700\_20M

### Horizontal

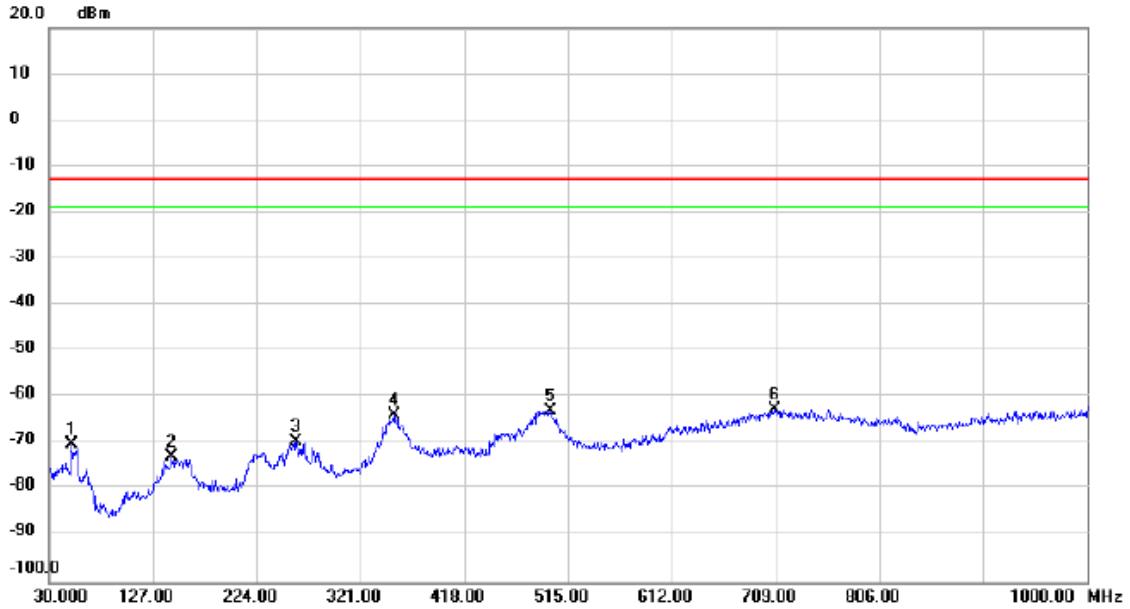

No.	Mk.	Freq. MHz	Reading Level dBm	Correct Factor dB	Measure- ment dBm	Limit dBm	Margin dB	Detector	Comment
1		51.340	-71.84	1.64	-70.20	-13.00	-57.20	peak	
2		144.460	-76.49	3.63	-72.86	-13.00	-59.86	peak	
3		260.860	-71.59	2.02	-69.57	-13.00	-56.57	peak	
4		352.040	-67.10	3.25	-63.85	-13.00	-50.85	peak	
5		498.510	-70.88	7.95	-62.93	-13.00	-49.93	peak	
6	*	708.030	-76.36	13.79	-62.57	-13.00	-49.57	peak	

Test Mode: eMTC Band 2\_TX CH18700\_20M

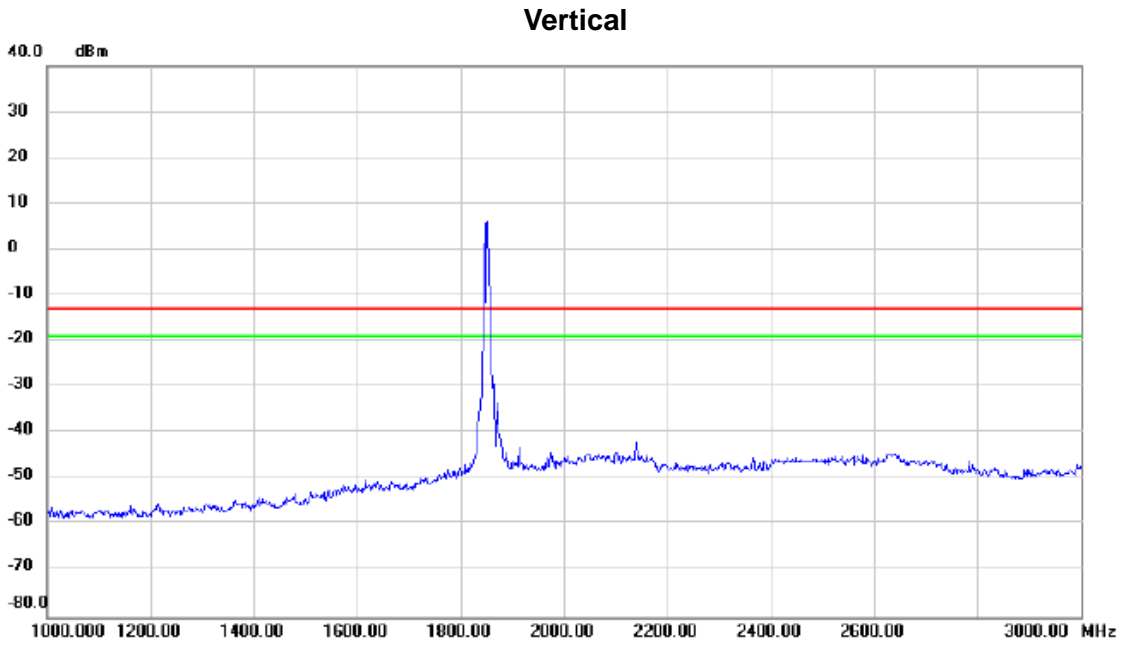

No.	Mk.	Freq.	Reading Level	Correct Factor	Measurement	Limit	Margin	Detector	Comment
		MHz	dBm	dB	dBm	dBm	dB		
		1870.00	5.00	0.00	5.00	-15.00	20.00		

Test Mode: eMTC Band 2\_TX CH18700\_20M

### Horizontal

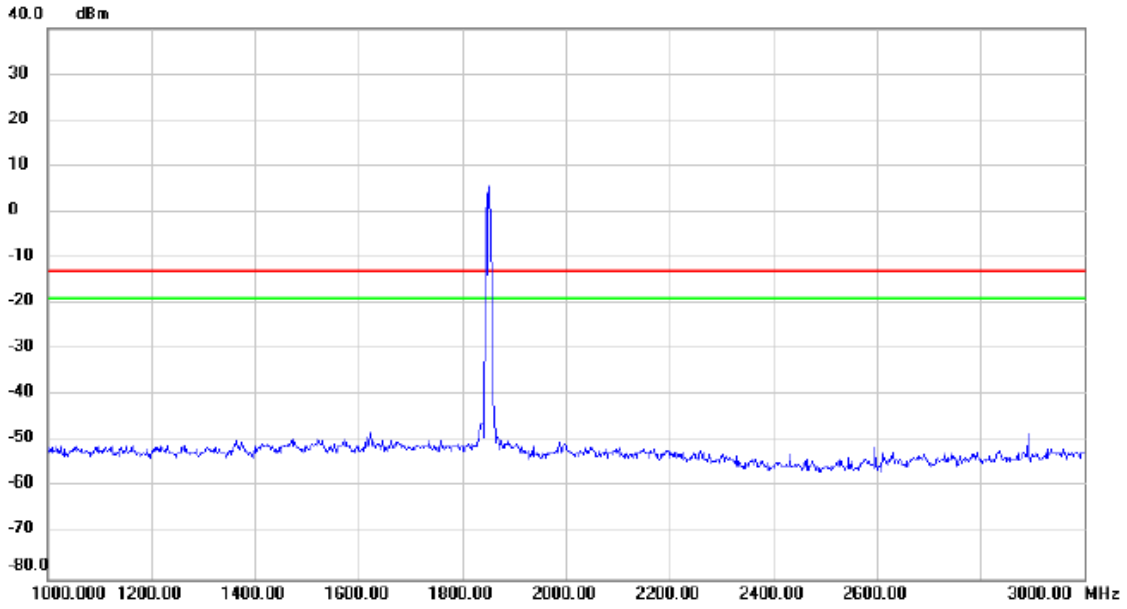

No.	Mk.	Freq.	Reading Level	Correct Factor	Measurement	Limit	Margin	Detector	Comment
		MHz	dBm	dB	dBm	dBm	dB		
		1870.000	5.0	0.0	5.0	-13.0	18.0		

Test Mode: eMTC Band 2\_TX CH18700\_20M

Vertical

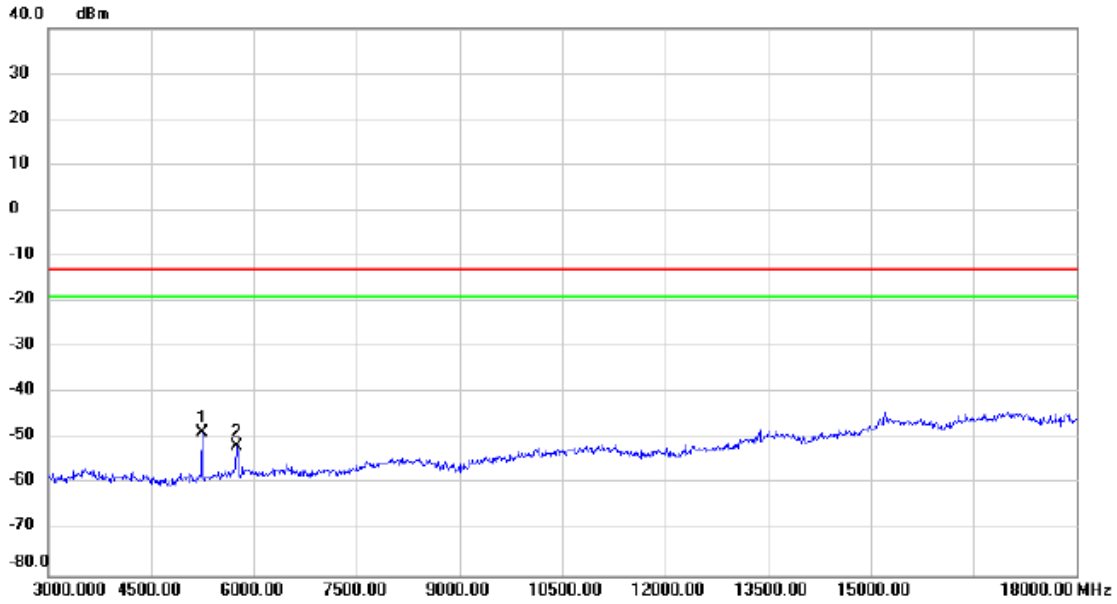

No.	Mk.	Freq. MHz	Reading Level dBm	Correct Factor dB	Measure- ment dBm	Limit dBm	Margin dB	Detector	Comment
1	*	5250.000	-64.11	15.32	-48.79	-13.00	-35.79	peak	
2		5745.000	-68.01	16.49	-51.52	-13.00	-38.52	peak	

Test Mode: eMTC Band 2\_TX CH18700\_20M

Horizontal

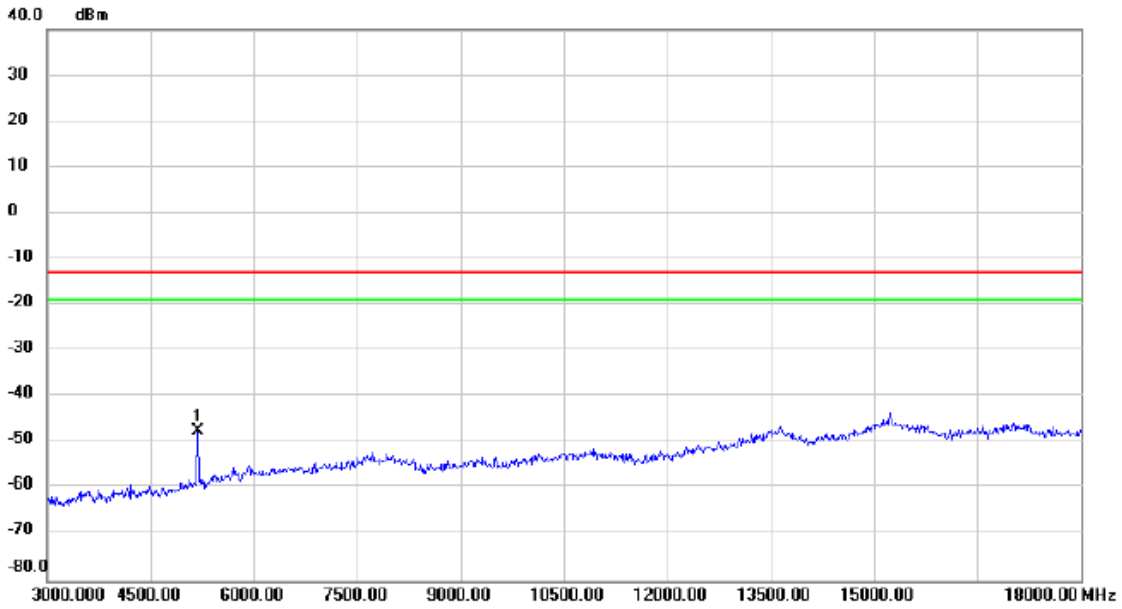

No.	Mk.	Freq. MHz	Reading Level dBm	Correct Factor dB	Measure- ment dBm	Limit dBm	Margin dB	Detector	Comment
1	*	5190.000	-62.77	15.39	-47.38	-13.00	-34.38	peak	

Test Mode: eMTC Band 2\_TX CH18700\_20M

Vertical

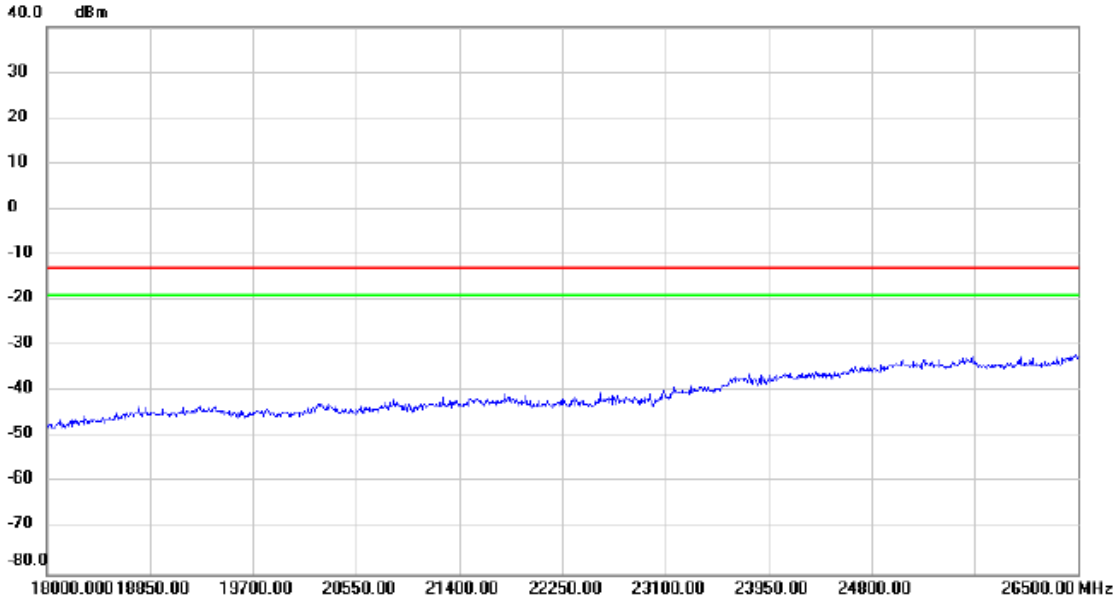

No.	Mk.	Freq.	Reading Level	Correct Factor	Measurement	Limit	Margin	Detector	Comment
		MHz	dBm	dB	dBm	dBm	dB		

Test Mode: eMTC Band 2\_TX CH18700\_20M

Horizontal

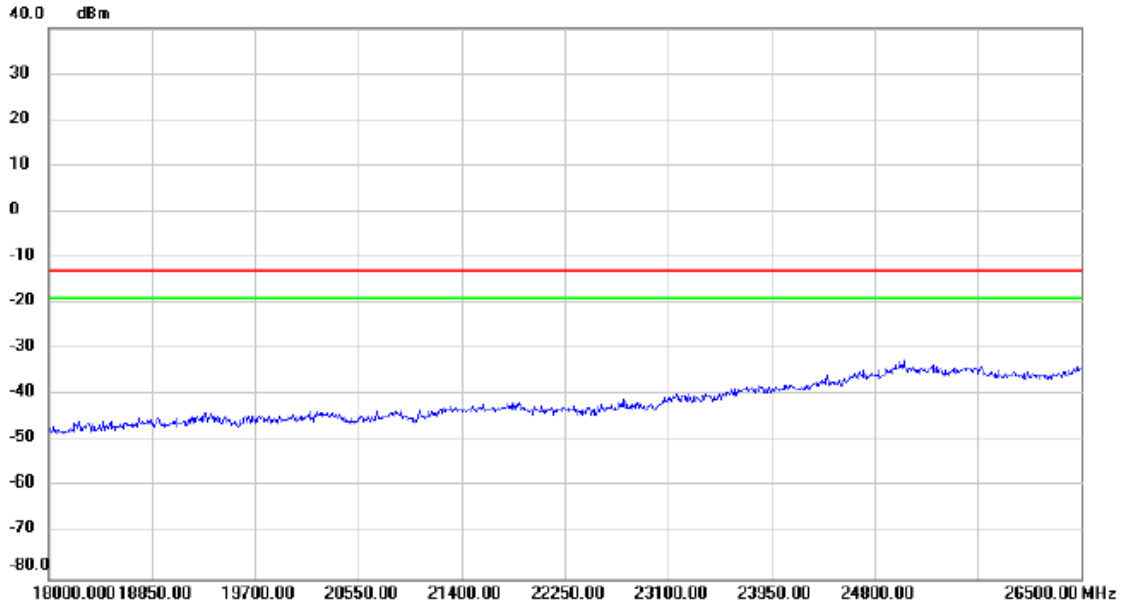

No.	Mk.	Freq.	Reading Level	Correct Factor	Measurement	Limit	Margin	Detector	Comment
		MHz	dBm	dB	dBm	dBm	dB		

## APPENDIX E - BAND EDGE



eMTC Band 2\_5M - QPSK

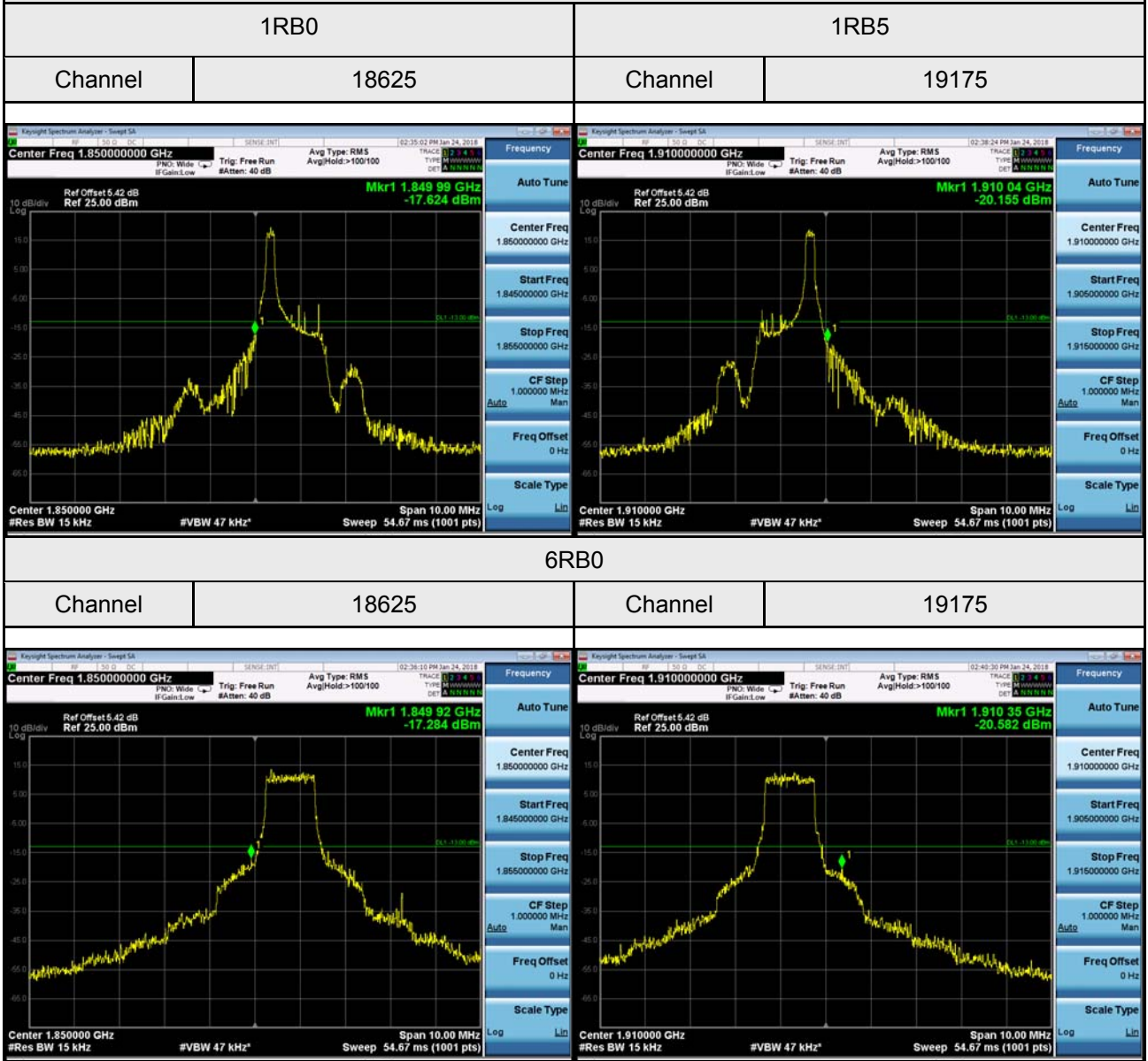

eMTC Band 2\_5M - 16QAM

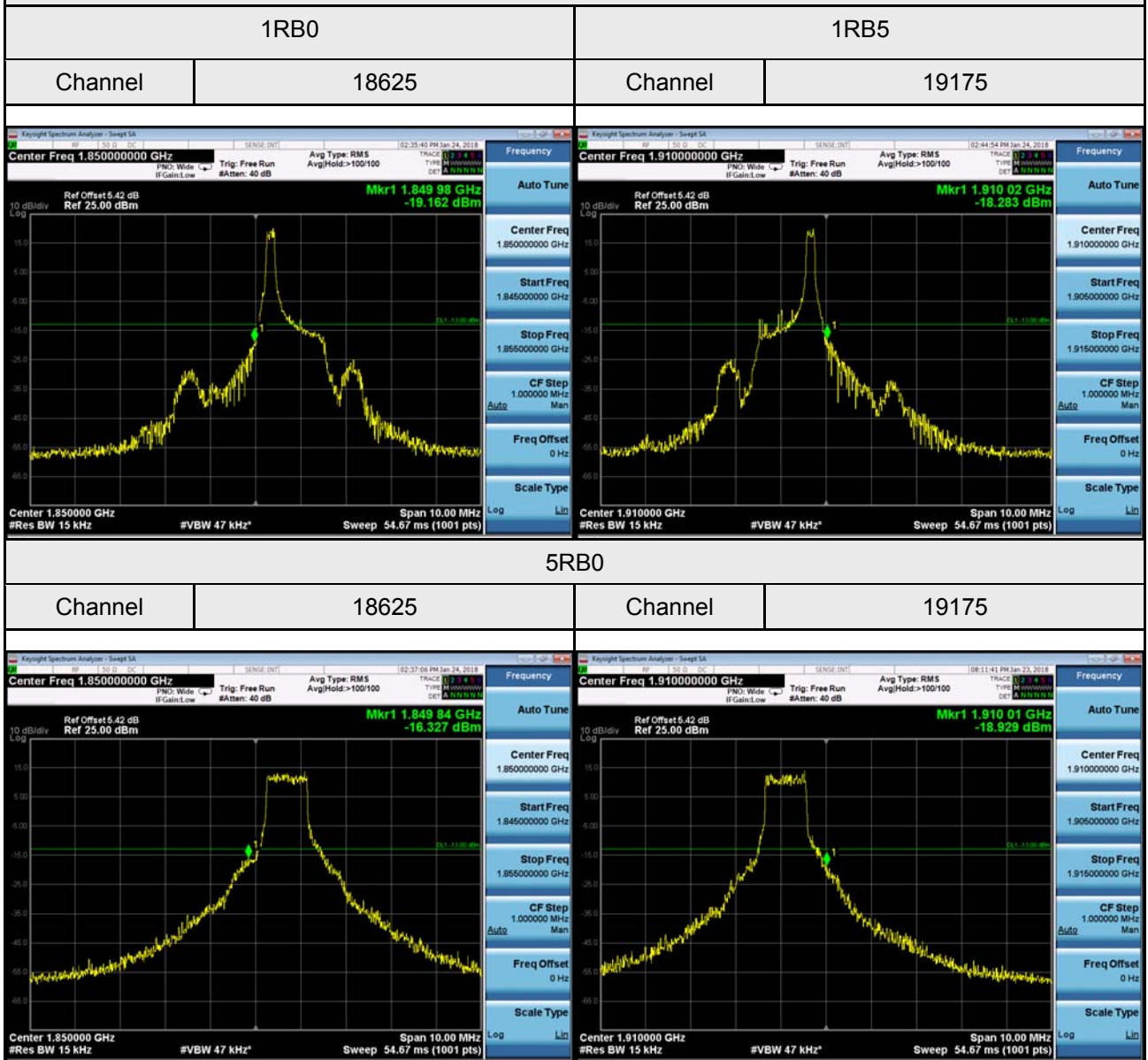

eMTC Band 2\_10M - QPSK

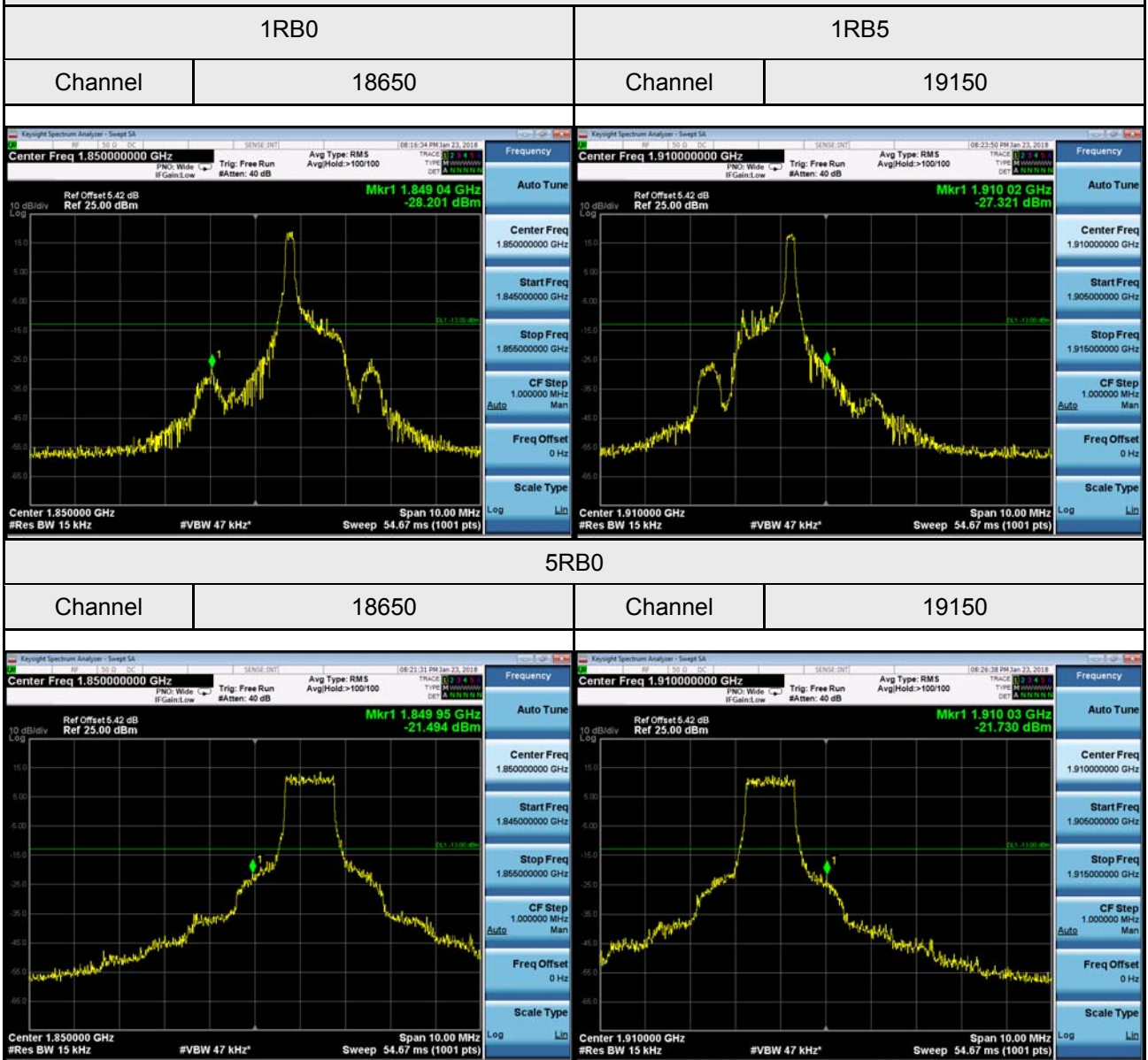

eMTC Band 2\_10M - 16QAM

1RB0

1RB5

Channel

18650

Channel

19150

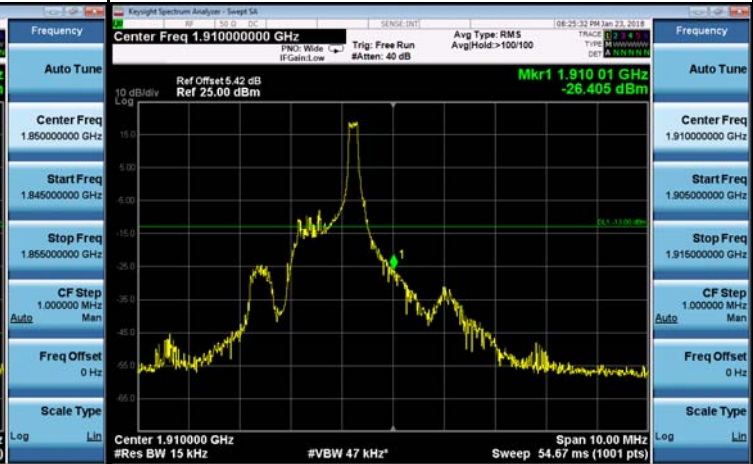
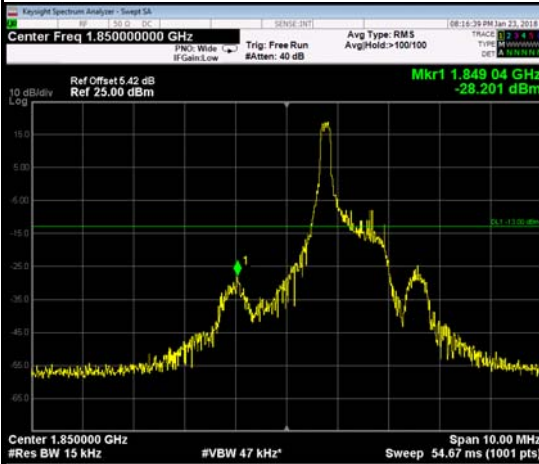

5RB0

Channel

18650

Channel

19150

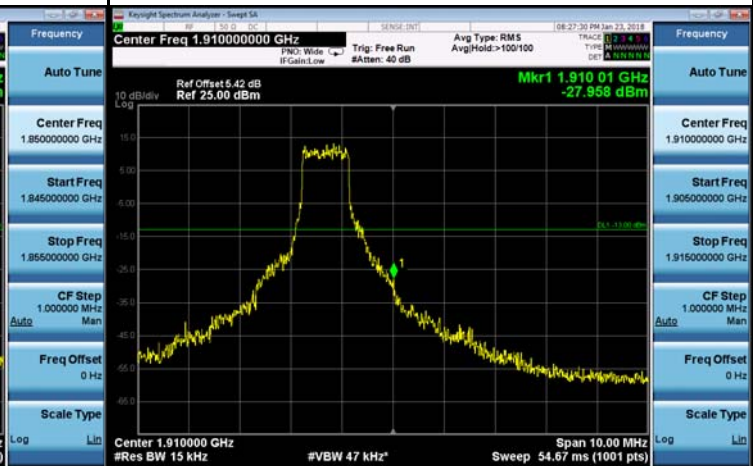
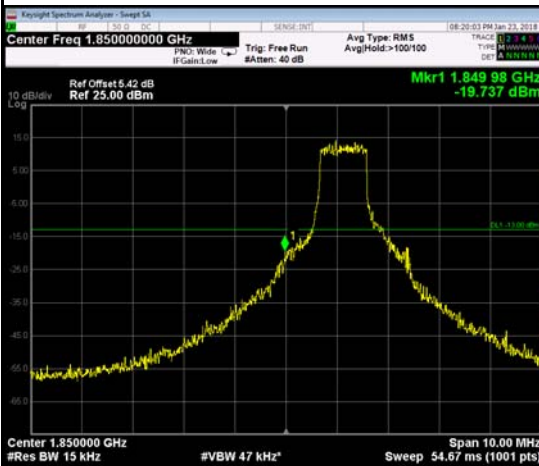

eMTC Band 2\_15M - QPSK

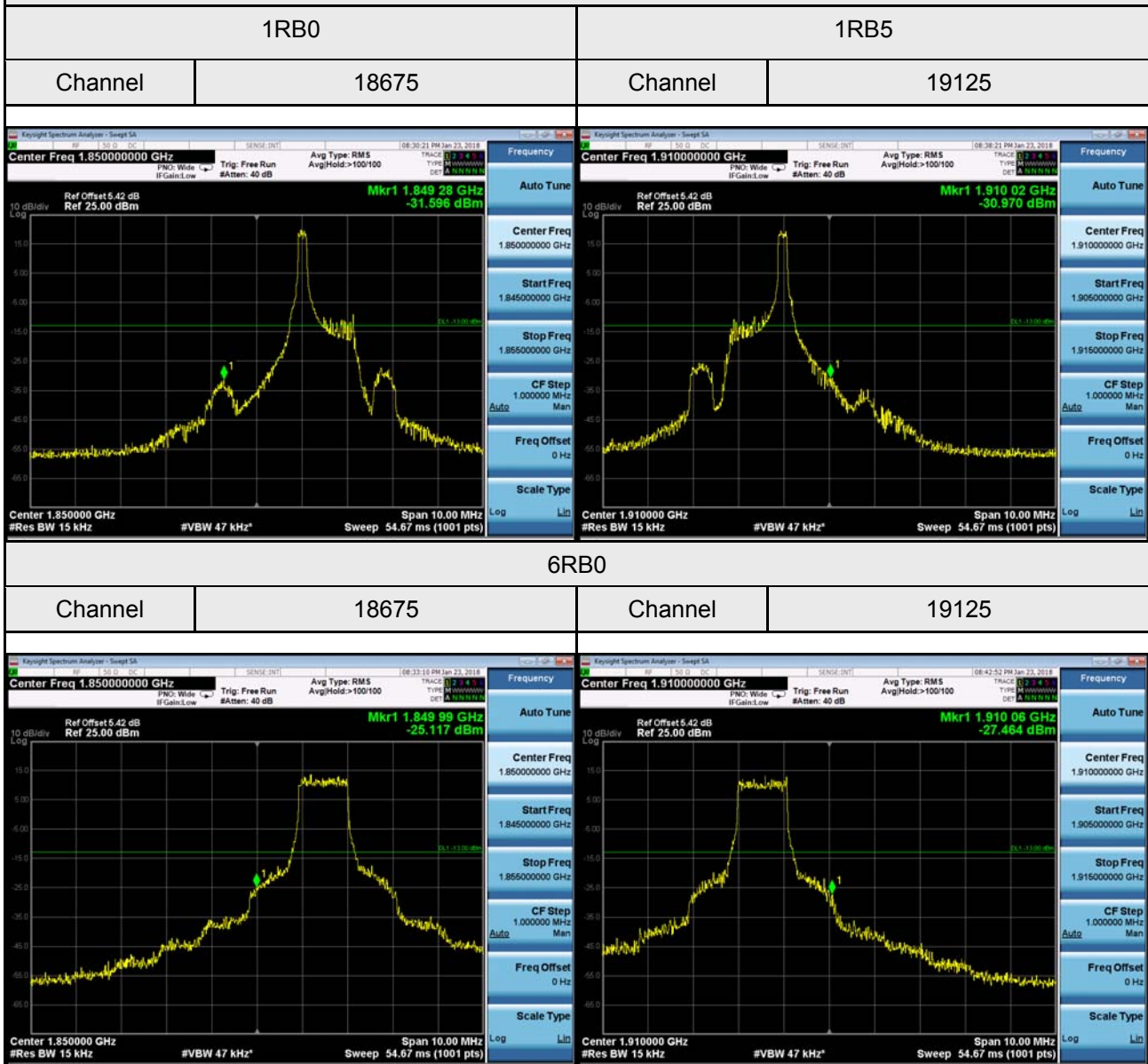



eMTC Band 2\_15M - 16QAM

1RB0

1RB5

Channel

18675

Channel

19125

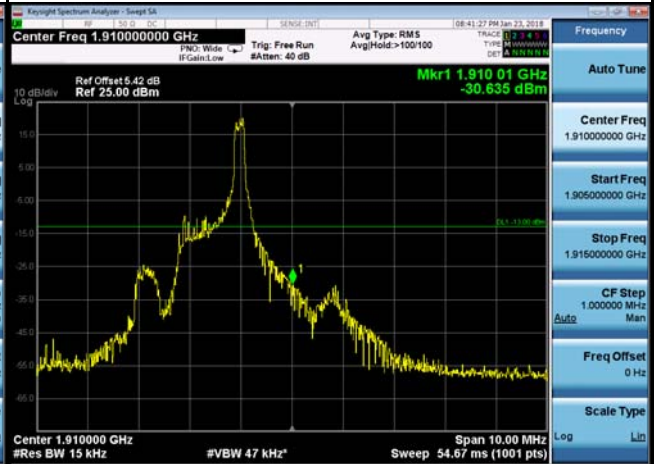
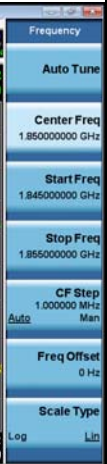
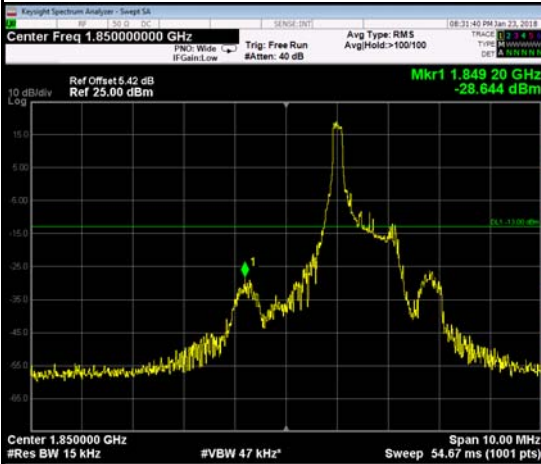

6RB0

Channel

18675

Channel

19125

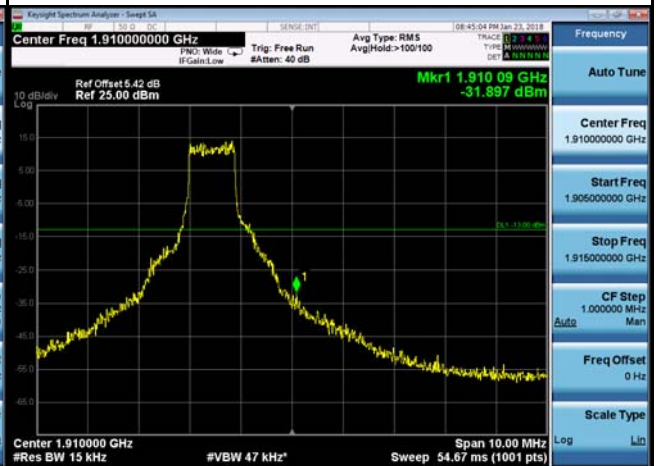
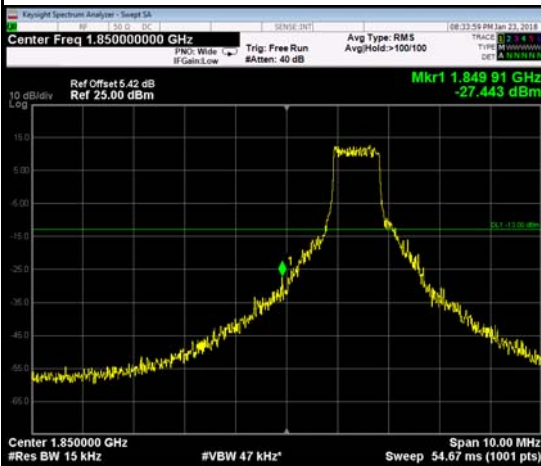

eMTC Band 2\_20M - QPSK

1RB0

1RB5

Channel

18700

Channel

19100

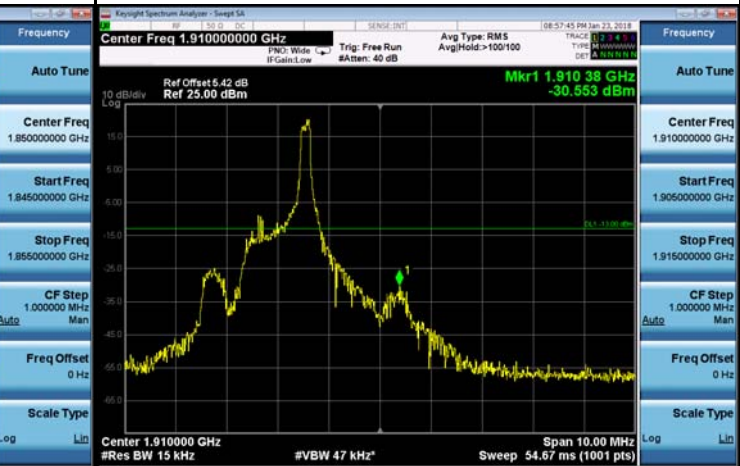
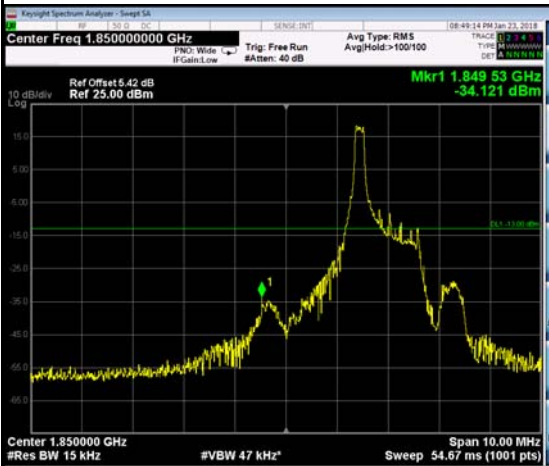

6RB0

Channel

18700

Channel

19100

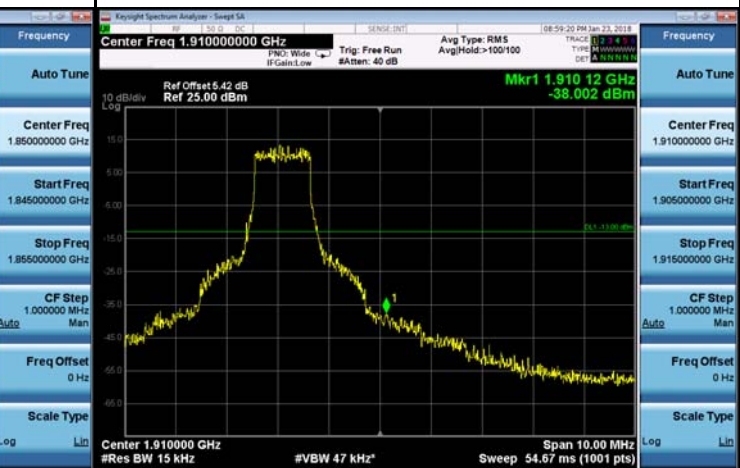
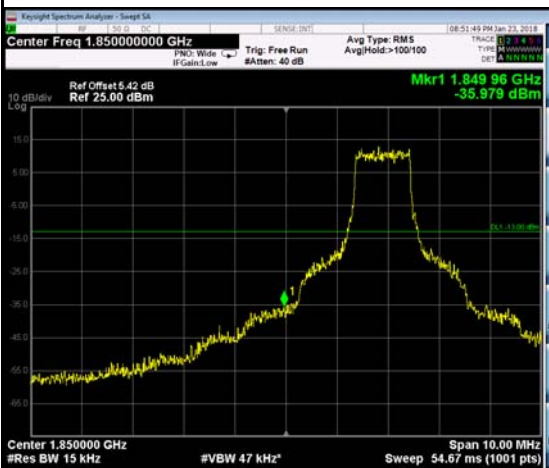

eMTC Band 2\_20M - 16QAM

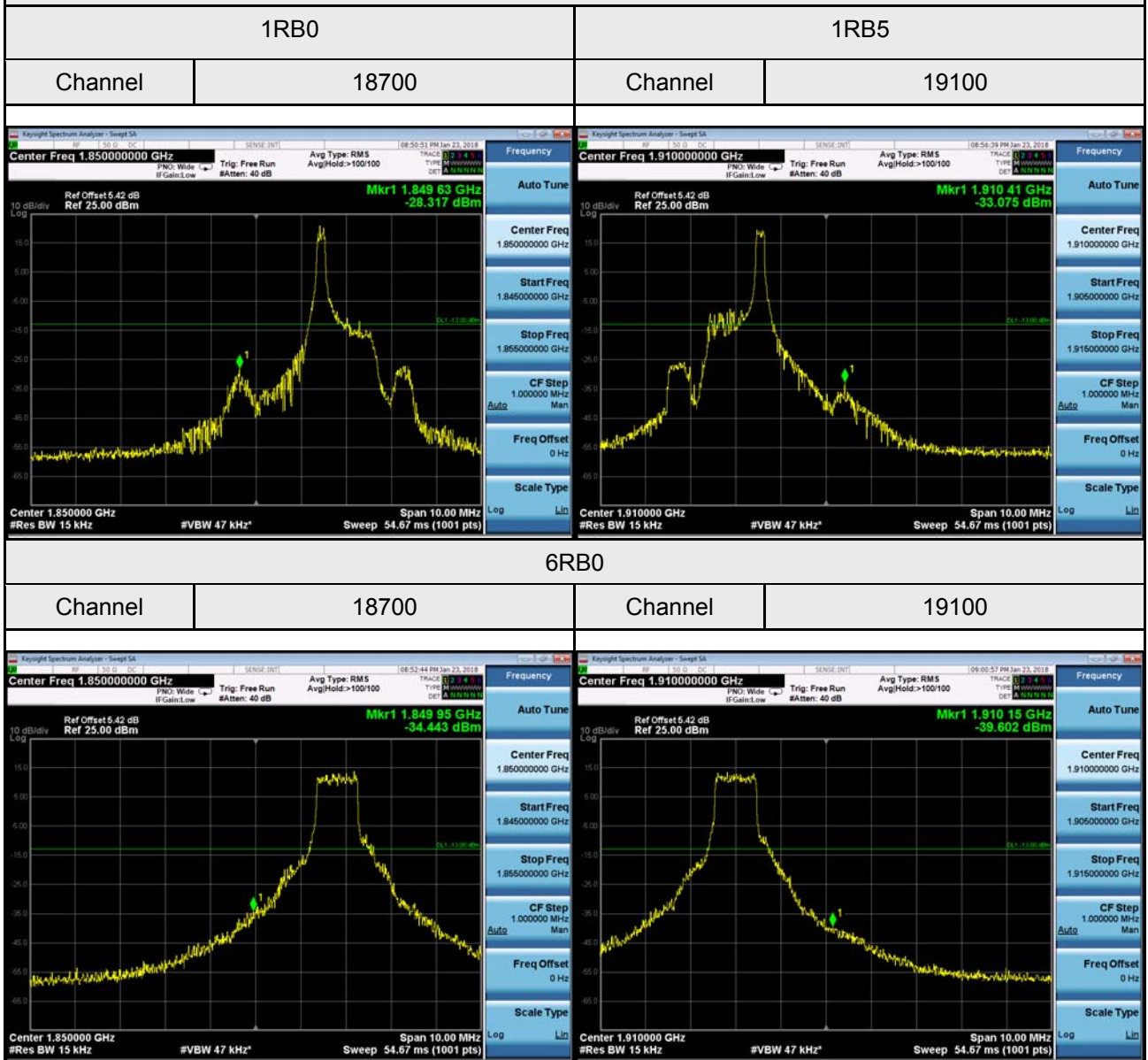



## APPENDIX F - PEAK TO AVERAGE RATIO

### eMTC Band 2 Spectrum Plot\_5M

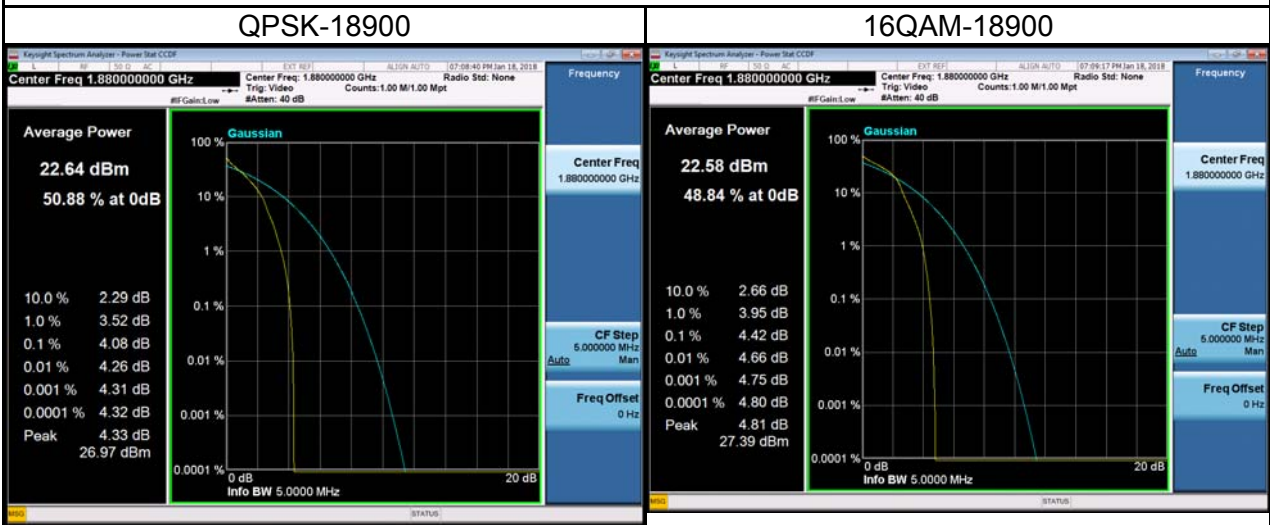

### eMTC Band 2 Spectrum Plot\_10M

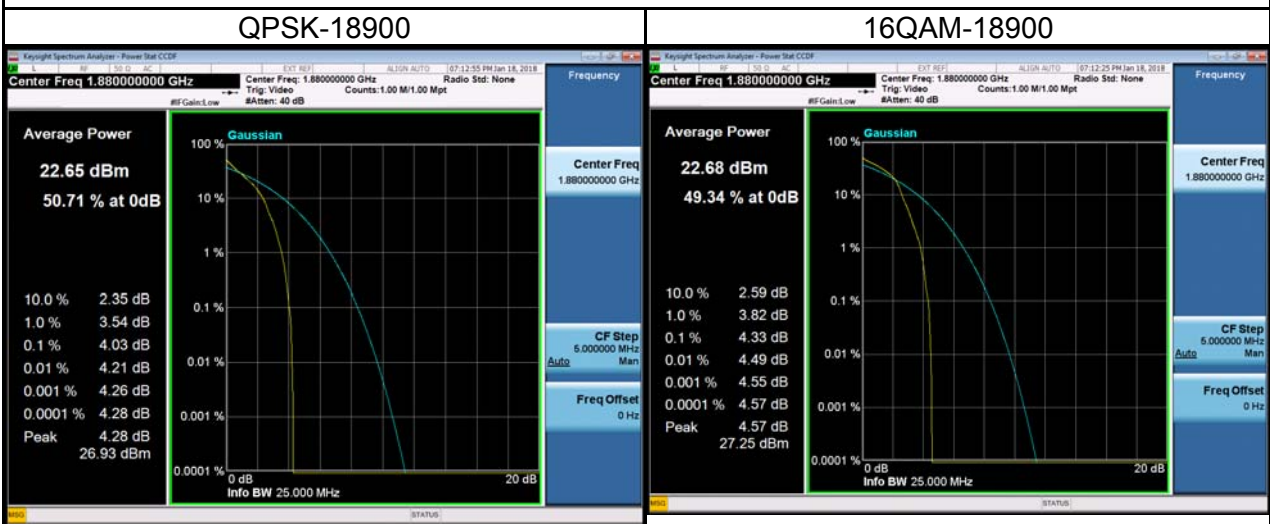

### eMTC Band 2 Spectrum Plot\_15M



### eMTC Band 2 Spectrum Plot\_20M

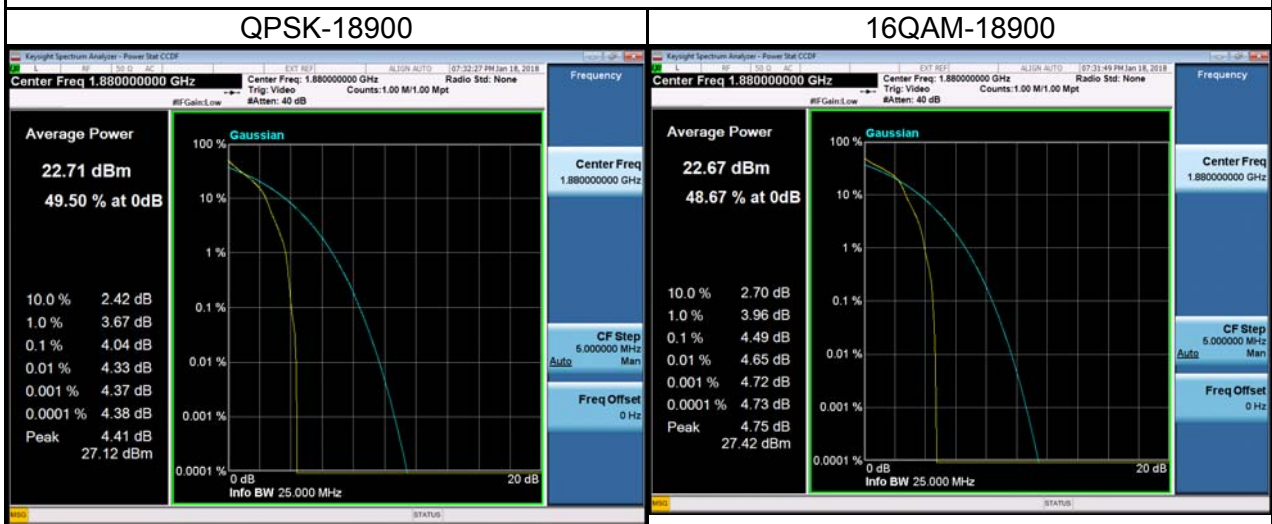

## APPENDIX G - FREQUENCY STABILITY

Test Mode:	eMTC Band 2_CH18900_5M
------------	------------------------

**Temperature vs. Frequency Stability**

Temperature(°C)	Frequency Error (Hz)	Frequency Error (ppm)	Limit(ppm)
-30	-21.12	0.011234043	1.5
-20	13.96	0.007425532	1.5
-10	-11.98	0.006372340	1.5
0	-14.52	0.007723404	1.5
10	15.10	0.008031915	1.5
20	14.93	0.007941489	1.5
30	19.68	0.010468085	1.5
40	-17.18	0.009138298	1.5
50	18.03	0.009590426	1.5
60	14.83	0.007888298	1.5
70	18.21	0.009686170	1.5
75	-12.69	0.006750000	1.5
Max. Deviation (ppm)	21.12	0.011234043	1.5

**Voltage vs. Frequency Stability**

Voltage(Volts)	Frequency Error (Hz)	Frequency Error (ppm)	Limit(ppm)
3.3	12.58	0.006691489	1.5
3.8	-19.77	0.010515957	1.5
4.2	-18.96	0.010085106	1.5
Max. Deviation (ppm)	19.77	0.010515957	1.5

Test Mode:	eMTC Band 2_CH18900_10M
------------	-------------------------

**Temperature vs. Frequency Stability**

Temperature(°C)	Frequency Error (Hz)	Frequency Error (ppm)	Limit(ppm)
-30	12.88	0.006851064	1.5
-20	13.16	0.007000000	1.5
-10	-15.48	0.008234043	1.5
0	21.73	0.011558511	1.5
10	-22.66	0.012053191	1.5
20	14.83	0.007888298	1.5
30	15.46	0.008223404	1.5
40	16.29	0.008664894	1.5
50	-17.06	0.009074468	1.5
60	-18.16	0.009659574	1.5
70	14.81	0.007877660	1.5
75	19.53	0.010388298	1.5
Max. Deviation (ppm)	22.66	0.012053191	1.5

**Voltage vs. Frequency Stability**

Voltage(Volts)	Frequency Error (Hz)	Frequency Error (ppm)	Limit(ppm)
3.3	13.49	0.007175532	1.5
3.8	15.21	0.008090426	1.5
4.2	-18.66	0.009925532	1.5
Max. Deviation (ppm)	18.66	0.009925532	1.5

Test Mode:	eMTC Band 2_CH18900_15M
------------	-------------------------

**Temperature vs. Frequency Stability**

Temperature(°C)	Frequency Error (Hz)	Frequency Error (ppm)	Limit(ppm)
-30	22.61	0.012026596	1.5
-20	-13.71	0.007292553	1.5
-10	-16.37	0.008707447	1.5
0	15.42	0.008202128	1.5
10	16.17	0.008601064	1.5
20	17.03	0.009058511	1.5
30	18.48	0.009829787	1.5
40	-16.48	0.008765957	1.5
50	-15.11	0.008037234	1.5
60	14.62	0.007776596	1.5
70	17.14	0.009117021	1.5
75	-20.62	0.010968085	1.5
Max. Deviation (ppm)	22.61	0.012026596	1.5

**Voltage vs. Frequency Stability**

Voltage(Volts)	Frequency Error (Hz)	Frequency Error (ppm)	Limit(ppm)
3.3	13.13	0.006984043	1.5
3.8	20.06	0.010670213	1.5
4.2	12.25	0.006515957	1.5
Max. Deviation (ppm)	20.06	0.010670213	1.5

Test Mode:	eMTC Band 2_CH18900_20M
------------	-------------------------

**Temperature vs. Frequency Stability**

Temperature(°C)	Frequency Error (Hz)	Frequency Error (ppm)	Limit(ppm)
-30	19.74	0.010500000	1.5
-20	15.39	0.008186170	1.5
-10	-14.21	0.007558511	1.5
0	-15.28	0.008127660	1.5
10	14.87	0.007909574	1.5
20	-18.62	0.009904255	1.5
30	13.46	0.007159574	1.5
40	-11.84	0.006297872	1.5
50	17.33	0.009218085	1.5
60	-16.66	0.008861702	1.5
70	-12.21	0.006494681	1.5
75	19.44	0.010340426	1.5
Max. Deviation (ppm)	19.74	0.010500000	1.5

**Voltage vs. Frequency Stability**

Voltage(Volts)	Frequency Error (Hz)	Frequency Error (ppm)	Limit(ppm)
3.3	16.16	0.008595745	1.5
3.8	-20.51	0.010909574	1.5
4.2	13.33	0.007090426	1.5
Max. Deviation (ppm)	20.51	0.010909574	1.5