

FCC Radio Test Report

FCC ID: QISMAR-LX3AM

This report concerns: Original Grant

Project No. : 1904C018
Equipment : Smart Phone
Test Model : MAR-LX3Am
Series Model : N/A
Applicant : Huawei Technologies Co., Ltd.
Address : Administration Building, Headquarters of Huawei Technologies Co., Ltd., Bantian, Longgang District, Shenzhen, 518129, China

Date of Receipt : Apr. 04, 2019
Date of Test : Apr. 04, 2019 ~ Apr. 19, 2019
Issued Date : May 20, 2019
Tested by : BTL Inc.

Technical Manager :



(Ethan Ma)

Authorized Signatory :



(Steven Lu)

B T L I N C .

No.3, Jinshagang 1st Road, Shixia, Dalang Town, Dongguan, Guangdong, China.

TEL: +86-769-8318-3000 FAX: +86-769-8319-6000



Certificate #5123.02

Declaration

BTL represents to the client that testing is done in accordance with standard procedures as applicable and that test instruments used has been calibrated with standards traceable to international standard(s) and/or national standard(s).

BTL's reports apply only to the specific samples tested under conditions. It is manufacture's responsibility to ensure that additional production units of this model are manufactured with the identical electrical and mechanical components. **BTL** shall have no liability for any declarations, inferences or generalizations drawn by the client or others from **BTL** issued reports.

The report must not be used by the client to claim product certification, approval, or endorsement by NIST, A2LA, or any agency of the U.S. Government.

This report is the confidential property of the client. As a mutual protection to the clients, the public and ourselves, the test report shall not be reproduced, except in full, without our written approval.

BTL's laboratory quality assurance procedures are in compliance with the **ISO/IEC 17025** requirements, and accredited by the conformity assessment authorities listed in this test report.

BTL is not responsible for the sampling stage, so the results only apply to the sample as received.

The information, data and test plan are provided by manufacturer which may affect the validity of results, so it is manufacturer's responsibility to ensure that the apparatus meets the essential requirements of applied standards and in all the possible configurations as representative of its intended use.

Limitation

For the use of the authority's logo is limited unless the Test Standard(s)/Scope(s)/Item(s) mentioned in this test report is (are) included in the conformity assessment authorities acceptance respective.

Please note that the measurement uncertainty is provided for informational purpose only and is not use in determining the Pass/Fail results.

Table of Contents**Page**

REPORT ISSUED HISTORY	5
1 . GENERAL SUMMARY	6
2 . SUMMARY OF TEST RESULTS	7
2.1 TEST FACILITY	8
2.2 MEASUREMENT UNCERTAINTY	8
3 . GENERAL INFORMATION	9
3.1 GENERAL DESCRIPTION OF EUT	9
3.2 DESCRIPTION OF TEST MODES AND TEST CONDITION	12
3.3 BLOCKDIGRAMSHOWINGTHECONFIGURATIONOFSYSTEMTESTED FOR RADIATED	15
3.4 DESCRIPTION OF SUPPORT UNITS	15
4 . TEST RESULT	16
4.1 OUTPUT POWER MEASUREMENT	16
4.1.1 LIMIT	16
4.1.2 TEST PROCEDURE	16
4.1.3 TEST SETUP LAYOUT	16
4.1.4 TEST DEVIATION	16
4.1.5 TEST RESULTS	16
4.2 OCCUPIED BANDWIDTH MEASUREMENT	17
4.2.1 TEST PROCEDURE	17
4.2.2 TEST SETUP LAYOUT	17
4.2.3 TEST DEVIATION	17
4.2.4 TEST RESULTS	17
4.3 CONDUCTED EMISSIONS MEASUREMENT	18
4.3.1 LIMIT	18
4.3.2 TEST PROCEDURES	18
4.3.3 TEST SETUP LAYOUT	18
4.3.4 TEST DEVIATION	18
4.3.5 TEST RESULTS	18
4.4 RADIATED EMISSIONS MEASUREMENT	19
4.4.1 LIMIT	19
4.4.2 TEST PROCEDURES	19
4.4.3 TEST SETUP LAYOUT	20
4.4.4 TEST DEVIATION	22
4.4.5 TEST RESULTS (9KHZ TO 30MHZ)	22
4.4.6 TEST RESULTS (30MHZ TO 1000MHZ)	22
4.4.7 TEST RESULTS (ABOVE 1000MHZ)	22

Table of Contents	Page
4.5 BAND EDGE MEASUREMENT	23
4.5.1 LIMIT	23
4.5.2 TEST PROCEDURES	23
4.5.3 TEST SETUP LAYOUT	23
4.5.4 TEST DEVIATION	23
4.5.5 TEST RESULTS	23
4.6 PEAK TO AVERAGE RATIO MEASUREMENT	24
4.6.1 LIMIT	24
4.6.2 TEST PROCEDURES	24
4.6.3 TEST SETUP LAYOUT	24
4.6.4 TEST DEVIATION	24
4.6.5 TEST RESULTS	24
4.7 FREQUENCY STABILITY MEASUREMENT	25
4.7.1 LIMIT	25
4.7.2 TEST PROCEDURES	25
4.7.3 TEST SETUP LAYOUT	25
4.7.4 TEST DEVIATION	25
4.7.5 TEST RESULTS	25
5. LIST OF MEASUREMENT EQUIPMENTS	26
APPENDIX A - MAXIMUM OUTPUT POWER	28
APPENDIX B - OCCUPIED BANDWIDTH	37
APPENDIX C - CONDUCTED EMISSIONS	55
APPENDIX D - RADIATED EMISSION (9KHZ TO 30MHZ)	61
APPENDIX E - RADIATED EMISSION (30MHZ TO 1GHZ)	66
APPENDIX C - RADIATED EMISSION (ABOVE 1GHZ)	99
APPENDIX G - BAND EDGE	196
APPENDIX H - PEAK TO AVERAGE RATIO	205
APPENDIX I - FREQUENCY STABILITY	216

REPORT ISSUED HISTORY

Report Version	Description	Issued Date
R00	Original Issue.	Apr. 24, 2019
R01	Updated the Software Version.	May 15, 2019
R02	Changed the FCC ID QISMAR-LX3Am to QISMAR-LX3AM.	May 20, 2019

1. GENERAL SUMMARY

Equipment : Smart Phone
Brand Name : HUAWEI
Test Model : MAR-LX3Am
Series Model : N/A
Applicant : Huawei Technologies Co., Ltd.
Manufacturer : Huawei Technologies Co., Ltd.
Address : Administration Building, Headquarters of Huawei Technologies Co., Ltd.,
Bantian, Longgang District, Shenzhen, 518129, China
Date of Test : Apr. 04, 2019 ~ Apr. 19, 2019
Test Sample : Engineering Sample No.: D190403577 for conducted, D190403530 for
radiated.
Standard(s) : 47 CFR FCC Part 24 Subpart E
47 CFR FCC Part 2
ANSI/TIA/EIA-603-E-2016
KDB 971168 D01 Power Meas License Digital Systems v03r01

The above equipment has been tested and found compliance with the requirement of the relative standards by BTL Inc.

The test data, data evaluation, and equipment configuration contained in our test report (Ref No. BTL-FCCP-5-1904C018) were obtained utilizing the test procedures, test instruments, test sites that has been accredited by the Authority of A2LA according to the ISO/IEC 17025 quality assessment standard and technical standard(s).

Test results included in this report are only for the PCS1900, WCDMA Band II and LTE Band 2 part.

2. SUMMARY OF TEST RESULTS

Test procedures according to the technical standard(s):

FCC Part 24 Subpart E& Part 2			
Standard(s) Section	Test Item	Judgment	Tested By
2.1046 & 24.232(c)	Radiated power	PASS	Paul Li
2.1046 & 24.232(c)	Maximum Output Power	PASS	Paul Li
2.1049 & 24.238(a)	Occupied Bandwidth	PASS	Paul Li
2.1051 & 24.238(a)	Conducted Spurious Emissions	PASS	Paul Li
2.1053 & 24.238(a)	Radiated Spurious Emissions	PASS	Paul Li
24.238(a)	Band Edge Measurements	PASS	Paul Li
24.232(d)	Peak To Average Ratio	PASS	Paul Li
2.1055 & 24.235	Frequency Stability	PASS	Paul Li

2.1 TEST FACILITY

The test facilities used to collect the test data in this report is at the location of No.3, Jinshagang 1st Road, Shixia, Dalang Town, Dongguan, Guangdong, China.

BTL's Test Firm Registration Number for FCC: 357015

BTL's Designation Number for FCC: CN1240

2.2 MEASUREMENT UNCERTAINTY

The measurement uncertainty figures shall be calculated according the methods described in the ETSI TR 100 028 and shall correspond to an expansion factor (coverage factor) $k=1.96$ or $k=2$ (which provide confidence levels of respectively 90% and 95.45% in the case where the distributions characterizing the actual measurement uncertainties are normal (Gaussian)).

Measurement Uncertainty for a Level of Confidence of 95 %, $U=2xUc(y)$.

The BTL measurement uncertainty as below table:

A. Radiated Measurement :

Test Site	Method	Measurement Frequency Range	Ant. H / V	U,(dB)
DG-CB03	CISPR	9KHz ~ 30MHz	V	3.79
		9KHz ~ 30MHz	H	3.57
		30MHz ~ 200MHz	V	3.82
		30MHz ~ 200MHz	H	3.78
		200MHz ~ 1,000MHz	V	4.10
		200MHz ~ 1,000MHz	H	4.06

Test Site	Method	Measurement Frequency Range	Ant. H / V	U,(dB)
DG-CB03	CISPR	1GHz ~ 18GHz	V	3.12
		1GHz ~ 18GHz	H	3.68
		18GHz ~ 40GHz	V	4.15
		18GHz ~ 40GHz	H	4.14

Note: Unless specifically mentioned, the uncertainty of measurement has not been taken into account to declare the compliance or non-compliance to the specification.

3. GENERAL INFORMATION

3.1 GENERAL DESCRIPTION OF EUT

Equipment	Smart Phone	
Brand Name	HUAWEI	
Test Model	MAR-LX3Am	
Series Model	N/A	
Model Difference(s)	N/A	
Hardware Version	HL4MARM	
Software Version	9.0.1.156(SP1C900E141R1P6)	
Antenna Type	Internal Antenna	
Antenna Gain	Main Antenna	-1.8 dBi
	Second Antenna	-3.7 dBi
IMEI No.	Conducted	865004040000552
	Radiated	865004040000263
Modulation Type	GSM/GPRS	GMSK
	EDGE	GMSK, 8PSK
	WCDMA	UL: BPSK DL: QPSK
	WCDMA(HSDPA/HSUPA)	16QAM
	LTE	UL: QPSK, 16QAM, 64QAM DL: QPSK, 16QAM, 64QAM
Operation Frequency	GSM /EDGE/GPRS	1850.2MHz ~ 1909.8MHz
	WCDMA Band II	1852.4MHz ~ 1907.6MHz
	LTE 2 (Channel Bandwidth: 1.4MHz)	1850.7MHz ~ 1909.3MHz
	LTE 2 (Channel Bandwidth: 3MHz)	1851.5MHz ~ 1908.5MHz
	LTE 2 (Channel Bandwidth: 5MHz)	1852.5MHz ~ 1907.5MHz
	LTE 2 (Channel Bandwidth: 10MHz)	1855.0MHz ~ 1905.0MHz
	LTE 2 (Channel Bandwidth: 15MHz)	1857.5MHz ~ 1902.5MHz
	LTE 2 (Channel Bandwidth: 20MHz)	1860.0MHz ~ 1900.0MHz

Max. EIRP Power	GSM/GPRS	GMSK	28.47	dBm
	EDGE	8PSK	23.21	dBm
	WCDMA	BPSK	21.17	dBm
	WCDMA_HSDPA	16QAM	20.63	dBm
	WCDMA_HSUPA	16QAM	21.24	dBm
	LTE Band 2 (Channel Bandwidth: 1.4MHz)	QPSK	21.04	dBm
		16QAM	20.12	dBm
		64QAM	18.73	dBm
	LTE Band 2 (Channel Bandwidth: 3MHz)	QPSK	20.99	dBm
		16QAM	20.10	dBm
		64QAM	18.71	dBm
	LTE Band 2 (Channel Bandwidth: 5MHz)	QPSK	21.01	dBm
		16QAM	20.10	dBm
		64QAM	18.72	dBm
	LTE Band 2 (Channel Bandwidth: 10MHz)	QPSK	20.93	dBm
		16QAM	19.95	dBm
		64QAM	18.81	dBm
	LTE Band 2 (Channel Bandwidth: 15MHz)	QPSK	21.03	dBm
		16QAM	20.13	dBm
		64QAM	18.73	dBm
LTE Band 2 (Channel Bandwidth: 20MHz)	QPSK	21.14	dBm	
	16QAM	20.20	dBm	
	64QAM	18.78	dBm	
Power Source	1# DC voltage supplied from AC/DC adapter. 2# Supplied from battery. 3# Supplied from USB.			
Power Rating	1# I/P:100-240V ~50/60Hz, 0.5A O/P: 5V 2A OR 9V 2A 2# DC 3.82V, 3240mAh 3# DC 5V			

Note:

1. For a more detailed features description, please refer to the manufacturer's specifications or the user's manual.

2.The EUT contains following accessory devices.

Item	Manufacturer	Factory	Model	Description
Adapter	Huawei Technologies Co., Ltd.	Salcomp (Shenzhen) Co., Ltd.	HW-090200EH0 HW-090200BH0 HW-090200UH0 HW-059200EHQ	I/P:100-240V ~50/60Hz, 0.5A O/P:5V 2A OR 9V 2A
		HUIZHOU BYD ELECTRONIC CO., LTD.		
		SHENZHEN HUNTKEY ELECTRIC CO., LTD.	HW-090200EH0 HW-090200BH0 HW-090200UH0	
		Huawei Technologies Co., Ltd.	HW-090200UH1	
Battery	Huawei Technologies Co., Ltd.	SCUD (FUJIAN) Electronics Co., Ltd.	HB356687ECW	Rated capacity: 3240mAh Nominal Voltage: +3.82V Charging Voltage: +4.40V
		Huizhou Desay Battery Co., Ltd.		
		Sunwoda Electronic Co., Ltd.		
Earphone	-	Jiangxi Lianchuang Hongsheng Electronic Co., LTD.	MEND1532B528A02 MEND1532B528B00	-
		Boluo County Quancheng Electronic Co., Ltd.	1293-3283-3.5mm-322 1293-3283-3.5mm-336	
		FOXCONN INTERCONNECT TECHNOLOGY LIMITED	EPAB542-2WH05-DH EPAB542-2WH06-DH	

3.2 DESCRIPTION OF TEST MODES AND TEST CONDITION

Following channel(s) was (were) selected for the final test as listed below:

GSM MODE			
Test Item	Available Channel	Tested Channel	Mode
EIRP	512 to 810	512, 661, 810	GSM, EDGE
Maximum Output Power	512 to 810	512, 661, 810	GSM, EDGE
Occupied Bandwidth	512 to 810	512, 661, 810	GSM, EDGE
Conducuted Emission	512 to 810	661	GSM, EDGE
Radiated Emission	512 to 810	661	GSM, EDGE
Band Edge	512 to 810	512, 810	GSM, EDGE
Peak to Average Ratio	512 to 810	512, 661, 810	GSM, EDGE
Frequency Stability	512 to 810	661	GSM

WCDMA MODE			
Test Item	Available Channel	Tested Channel	Mode
EIRP	9262 to 9538	9262, 9400, 9538	WCDMA, HSDPA,HSUPA
Maximum Output Power	9262 to 9538	9262, 9400, 9538	WCDMA, HSDPA,HSUPA
Conducted Emission	9262 to 9538	9400	WCDMA
Radiated Emission	9262 to 9538	9400	WCDMA
Band Edge	9262 to 9538	9262, 9538	WCDMA, HSDPA, HSUPA
Peak to Average Ratio	9262 to 9538	9262, 9400, 9538	WCDMA, HSDPA, HSUPA
Frequency Stability	9262 to 9538	9400	WCDMA

LTE BAND 2 MODE					
Test Item	Available Channel	Tested Channel	Channel Bandwidth	Modulation	Mode
EIRP	18607 to 19193	18607, 18900, 19193	1.4MHz	QPSK, 16QAM, 64QAM	1RB/3RB/6RB
	18615 to 19185	18615, 18900, 19185	3MHz	QPSK, 16QAM, 64QAM	1RB/8RB/15RB
	18625 to 19175	18625, 18900, 19175	5MHz	QPSK, 16QAM, 64QAM,	1RB/12RB/25RB
	18650 to 19150	18650, 18900, 19150	10MHz	QPSK, 16QAM, 64QAM	1RB/25RB/50RB
	18675 to 19125	18675, 18900, 19125	15MHz	QPSK, 16QAM, 64QAM	1RB/36RB/75RB
	18700 to 19100	18700, 18900, 19100	20MHz	QPSK, 16QAM, 64QAM	1RB/50RB/100RB
Occupied Bandwidth	18607 to 19193	18607, 18900, 19193	1.4MHz	QPSK, 16QAM	6RB
	18615 to 19185	18615, 18900, 19185	3MHz	QPSK, 16QAM	15RB
	18625 to 19175	18625, 18900, 19175	5MHz	QPSK, 16QAM	25RB
	18650 to 19150	18650, 18900, 19150	10MHz	QPSK, 16QAM	50RB
	18675 to 19125	18675, 18900, 19125	15MHz	QPSK, 16QAM	75 RB
	18700 to 19100	18700, 18900, 19100	20MHz	QPSK, 16QAM	100RB
Conducted Emission	18607 to 19193	18900	1.4 MHz	QPSK	1RB
	18625 to 19175	18900	5MHz	QPSK	1RB
	18700 to 19100	18900	20MHz	QPSK	1RB
Radiated Emission	18607 to 19193	18900	1.4 MHz	QPSK	1RB
	18625 to 19175	18900	5MHz	QPSK	1RB
	18700 to 19100	18900	20MHz	QPSK	1RB

LTE BAND 2 MODE					
Test Item	Available Channel	Tested Channel	Channel Bandwidth	Modulation	Mode
Band Edge	18607 to 19193	18607	1.4MHz	QPSK	1RB/6RB
		19193	1.4MHz	QPSK	
	18615 to 19185	18615	3MHz	QPSK	1RB/15RB
		19185	3MHz	QPSK	
	18625 to 19175	18625	5MHz	QPSK	1RB/25RB
		19175	5MHz	QPSK	
	18650 to 19150	18650	10MHz	QPSK	1RB/50RB
		19150	10MHz	QPSK	
	18675 to 19125	18675	15MHz	QPSK	1RB/75RB
		19125	15MHz	QPSK	
	18700 to 19100	18700	20MHz	QPSK	1RB/100RB
		19100	20MHz	QPSK	
Peak To Average Ratio	18607 to 19193	18607, 18900, 19193	1.4MHz	QPSK, 16QAM	1RB
	18615 to 19185	18615, 18900, 19185	3MHz	QPSK, 16QAM	1RB
	18625 to 19175	18625, 18900, 19175	5MHz	QPSK, 16QAM	1RB
	18650 to 19150	18650, 18900, 19150	10MHz	QPSK, 16QAM	1RB
	18675 to 19125	18675, 18900, 19125	15MHz	QPSK, 16QAM	1RB
	18700 to 19100	18700, 18900, 19100	20MHz	QPSK, 16QAM	1RB
Frequency Stability	18607 to 19193	18900	1.4MHz	QPSK	1RB
	18615 to 19185	18900	3MHz	QPSK	1RB
	18625 to 19175	18900	5MHz	QPSK	1RB
	18650 to 19150	18900	10MHz	QPSK	1RB
	18675 to 19125	18900	15MHz	QPSK	1RB
	18700 to 19100	18900	20MHz	QPSK	1RB

EUT TEST CONDITIONS:

Test Item	Environmental Conditions	Test Voltage
EIRP	22.1°C, 48.7%RH	DC 3.80V
Maximum Output Power	22.1°C, 48.7%RH	DC 3.80V
Occupied Bandwidth	22.1°C, 48.7%RH	DC 3.80V
Conducted Emission	22.1°C, 48.7%RH	DC 3.80V
Radiated Emission	24°C, 68%RH	AC 120V/60Hz
Band Edge	22.1°C, 48.7%RH	DC 3.80V
Peak to Average Ratio	22.1°C, 48.7%RH	DC 3.80V
Frequency Stability	Normal and Extreme	Normal and Extreme

3.3 BLOCKDIGRAMSHOWINGTHECONFIGURATIONOFSYSTEMTESTED FOR RADIATED

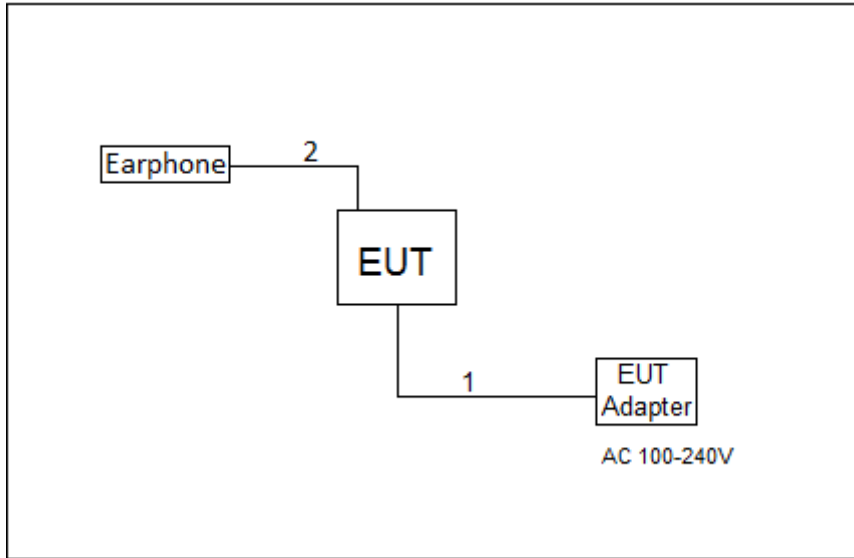

3.4 DESCRIPTION OF SUPPORT UNITS

The EUT has been tested as an independent unit together with other necessary accessories or support units. The following support units or accessories were used to form a representative test configuration during the tests.

Item	Equipment	Mfr/Brand	Model/Type No.	Series No.
-	-	-	-	-

Item	Shielded Type	Ferrite Core	Length	Note
1	NO	NO	1.2m	DC Cable
2	NO	NO	1.0m	Audio Cable

4. TEST RESULT

4.1 OUTPUT POWER MEASUREMENT

4.1.1 LIMIT

Mobile / Portable station are limited to 2 watts e.i.r.p.

4.1.2 TEST PROCEDURE

EIRP:

$EIRP = \text{Output Power} + \text{Antenan gain}$

Maximum Output Power:

The EUT was set up for the maximum power with GSM, GPRS, EDGE, WCDMA and LTE link data modulation and link up with simulator. Set the EUT to transmit under low, middle and high channel and record the power level shown on simulator.

4.1.3 TEST SETUP LAYOUT

Output Power Measurement

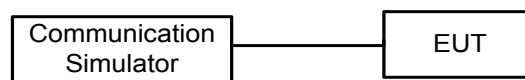

4.1.4 TEST DEVIATION

No deviation

4.1.5 TEST RESULTS

Please refer to the Appendix A.

4.2 OCCUPIED BANDWIDTH MEASUREMENT

4.2.1 TEST PROCEDURE

The EUT makes a call to the communication simulator. All measurements were done at low, middle and high operational frequency range. The communication simulator station system controlled a EUT to export maximum output power under transmission mode and specific channel frequency. Use OBW measurement function of Spectrum analyzer to measure 99 % occupied bandwidth and 26dB bandwidth.

4.2.2 TEST SETUP LAYOUT

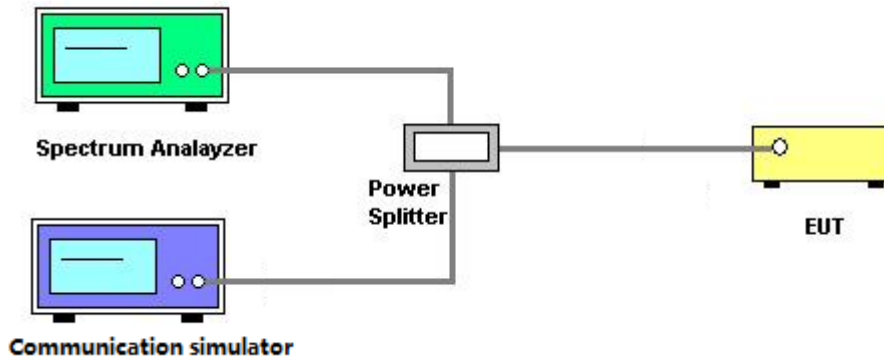

4.2.3 TEST DEVIATION

No deviation

4.2.4 TEST RESULTS

Please refer to the Appendix B.

4.3 CONDUCTED EMISSIONS MEASUREMENT

4.3.1 LIMIT

The power of any emission outside of the authorized operating frequency ranges must be attenuated below the transmitting power (P) by a factor of at least $43 + 10 \log(P)$ dB. The emission limit equal to -13dBm .

4.3.2 TEST PROCEDURES

1. The testing follows FCC KDB 971168 v03r01 Section 6.0.
2. The EUT was connected to spectrum analyzer and system simulator via a power divider.
3. The band edges of low and high channels for the highest RF powers were measured. Set $\text{RBW} \geq 1\%$ EBW in the 1MHz band immediately outside and adjacent to the band edge.
4. Set spectrum analyzer with RMS detector.
5. The RF fundamental frequency should be excluded against the limit line in the operating frequency band.
6. The limit line is derived from $43+10\log(P)\text{dB}$ below the transmitter power P(Watts)
 $=P(\text{W})-[43+10\log(P)](\text{dB})$
 $=[30+10\log(P)](\text{dBm})-[43+10\log(P)](\text{dB})$
 $=-13\text{dBm}$

4.3.3 TEST SETUP LAYOUT

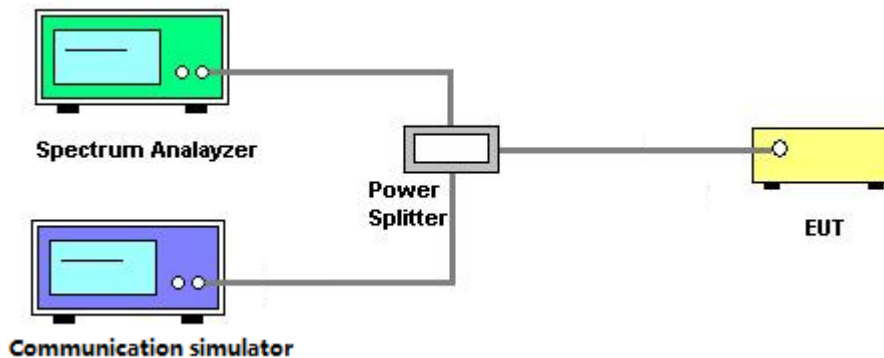

4.3.4 TEST DEVIATION

No deviation

4.3.5 TEST RESULTS

Please refer to the Appendix C.

4.4 RADIATED EMISSIONS MEASUREMENT

4.4.1 LIMIT

The power of any emission outside of the authorized operating frequency ranges must be attenuated below the transmitting power (P) by a factor of at least $43 + 10 \log(P)$ dB. The emission limit equal to -13dBm.

4.4.2 TEST PROCEDURES

1. In the semi-anechoic chamber, EUT placed on the 0.8m height of Turn Table, rotated the table around 360 degrees to search the maximum radiation power and receiver antenna shall be rotated vertical and horizontal polarization and moved height from 1m to 4m to find the maximum polar radiated power. The "Read Value" is the spectrum reading the maximum power value.
2. The substitution horn antenna is substituted for EUT at the same position and signals generator export the CW signal to the substitution antenna via a TX cable. Rotated the Turn Table and moved receiving antenna to find the maximum radiation power. Adjust output power level of S.G to get a Value of spectrum reading equal to "Read Value " of step a. Record the power level of S.G
3. $EIRP = \text{Output power level of S.G} - \text{TX cable loss} + \text{Antenna gain of substitution horn.}$
4. E.R.P power can be calculated form E.I.R.P power by subtracting the gain of dipole, $E.R.P \text{ power} = E.I.P.R \text{ power} - 2.15\text{dBi.}$
5. The resolution bandwidth and video bandwidth of test receiver/spectrum analyzer is 1MHz/3MHz.

4.4.3 TEST SETUP LAYOUT

Below 30MHz

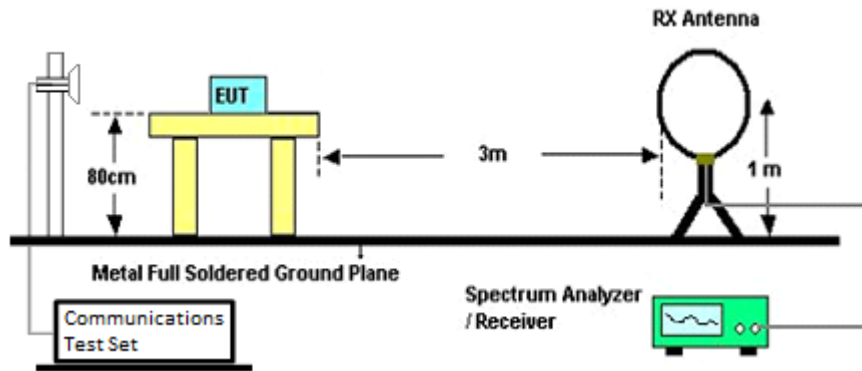

30MHz to 1GHz

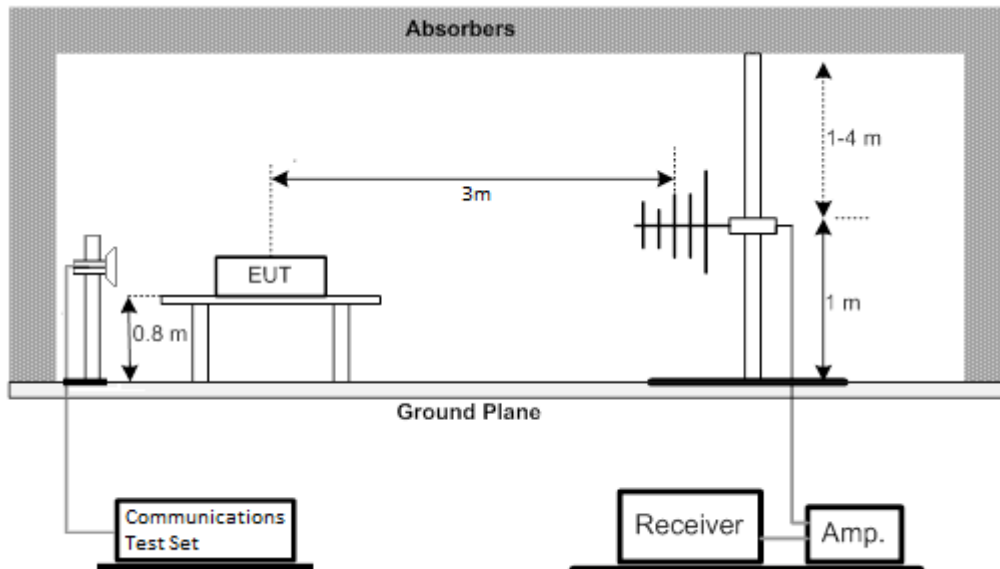

1GHz to 18GHz

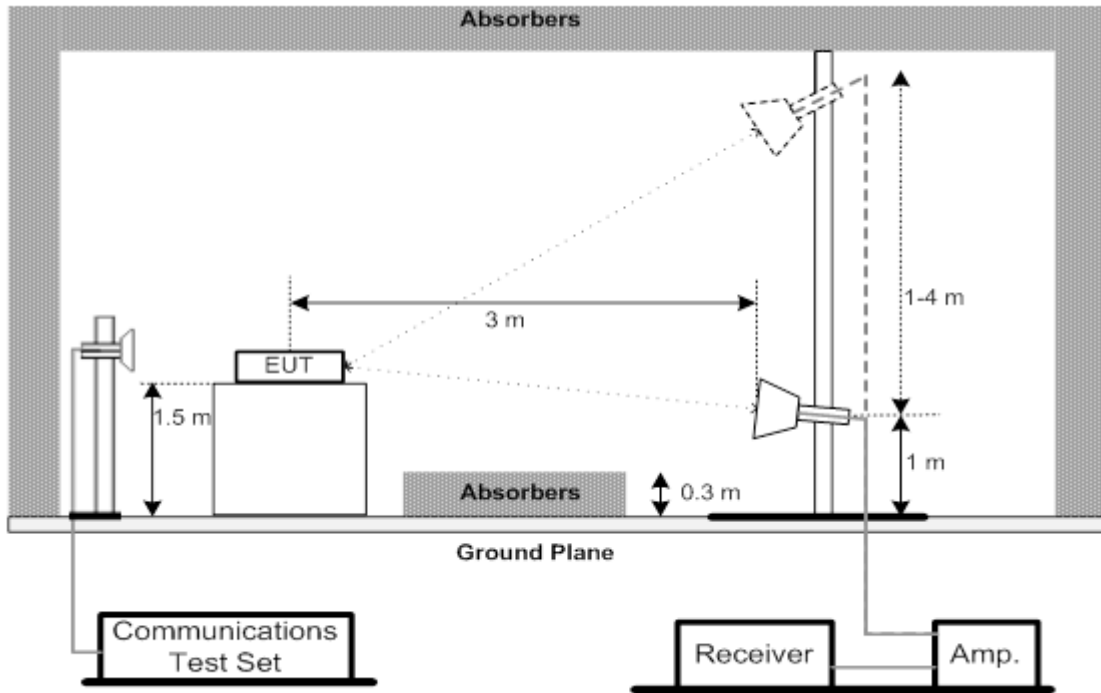

Above 18GHz

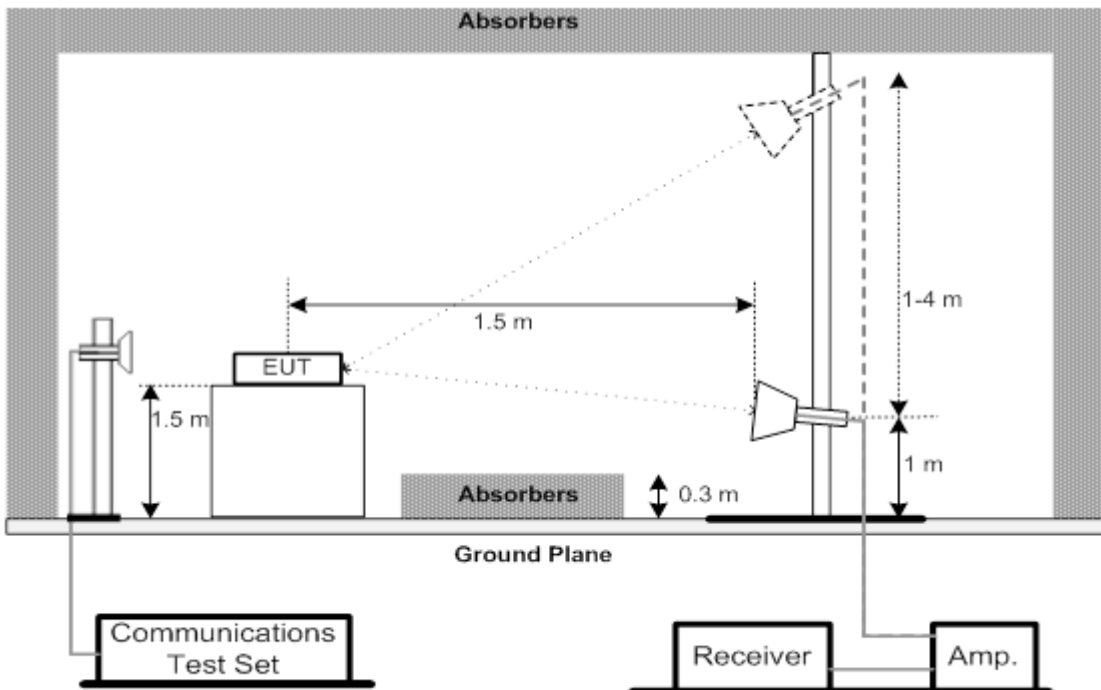

4.4.4 TEST DEVIATION

No deviation

4.4.5 TEST RESULTS (9KHZ TO 30MHZ)

Please refer to the Appendix D.

Remark:

(1) All adapters had been pre-test and in this report only recorded the worst case.

4.4.6 TEST RESULTS (30MHZ TO 1000MHZ)

Please refer to the Appendix E.

Remark:

(1) All adapters had been pre-test and in this report only recorded the worst case.

4.4.7 TEST RESULTS (ABOVE 1000MHZ)

Please refer to the Appendix F.

Remark:

(1) All adapters had been pre-test and in this report only recorded the worst case.

4.5 BAND EDGE MEASUREMENT

4.5.1 LIMIT

A Power of any emission outside of the authorized operating frequency ranges must be attenuated below the transmitting power (P) by a factor of at least $43 + 10 \log(P)$ dB. In the 1 MHz bands immediately outside and adjacent to the frequency block a resolution bandwidth of at least one percent of the emission bandwidth of the fundamental emission of the transmitter may be employed.

4.5.2 TEST PROCEDURES

1. All measurements were done at low and high operational frequency range.
2. The center frequency of spectrum is the band edge frequency and span is 1.5MHz. RB of the spectrum is 3kHz and VB of the spectrum is 10kHz (GSM/GPRS/EDGE).
3. The center frequency of spectrum is the band edge frequency and span is 10MHz. RB of the spectrum is 100kHz and VB of the spectrum is 300kHz (WCDMA).
4. The center frequency of spectrum is the band edge frequency and span is 2MHz. RB of the spectrum is 15kHz and VB of the spectrum is 43kHz (LTE Bandwidth 1.4MHz).
5. The center frequency of spectrum is the band edge frequency and span is 2MHz. RB of the spectrum is 30kHz and VB of the spectrum is 91kHz (LTE Bandwidth 3MHz).
6. The center frequency of spectrum is the band edge frequency and span is 2MHz. RB of the spectrum is 51kHz and VB of the spectrum is 150kHz (LTE Bandwidth 5MHz).
7. The center frequency of spectrum is the band edge frequency and span is 2MHz. RB of the spectrum is 100kHz and VB of the spectrum is 300kHz (LTE Bandwidth 10MHz).
8. The center frequency of spectrum is the band edge frequency and span is 2MHz. RB of the spectrum is 150kHz and VB of the spectrum is 470kHz (LTE Bandwidth 15MHz).
9. The center frequency of spectrum is the band edge frequency and span is 2MHz. RB of the spectrum is 200kHz and VB of the spectrum is 620kHz (LTE Bandwidth 20MHz).
10. Record the max trace plot into the test report.

4.5.3 TEST SETUP LAYOUT

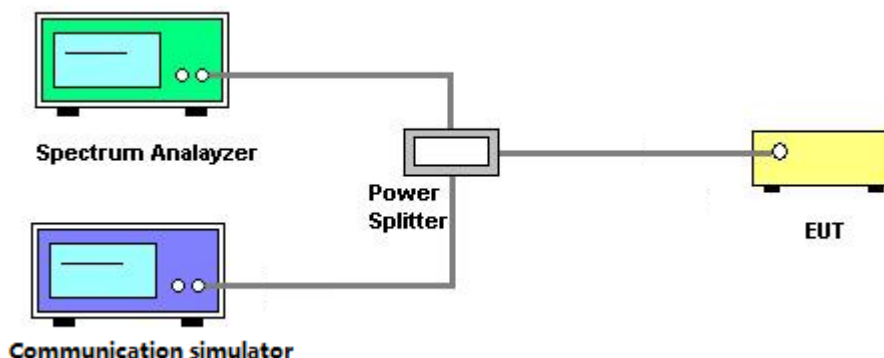

4.5.4 TEST DEVIATION

No deviation

4.5.5 TEST RESULTS

Please refer to the Appendix G.

4.6 PEAK TO AVERAGE RATIO MEASUREMENT

4.6.1 LIMIT

In measuring transmissions in this band using an average power technique, the peak to-average ratio (PAR) of the transmission may not exceed 13 dB.

4.6.2 TEST PROCEDURES

1. Set resolution/measurement bandwidth \geq signal's occupied bandwidth;
2. Set the number of counts to a value that stabilizes the measured CCDF curve;
3. Record the maximum PAPR level associated with a probability of 0.1%.

4.6.3 TEST SETUP LAYOUT

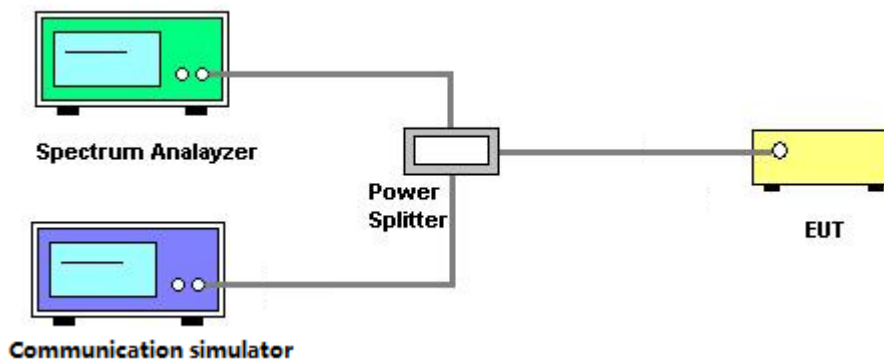

4.6.4 TEST DEVIATION

No deviation

4.6.5 TEST RESULTS

Please refer to the Appendix H.

4.7 FREQUENCY STABILITY MEASUREMENT

4.7.1 LIMIT

1.5 ppm is for base and fixed station. 2.5 ppm is for mobile station.

4.7.2 TEST PROCEDURES

1. Device is placed at the oven room. The oven room could control the temperatures and humidity. Power warm up is at least 15 min and power applied should perform before recording frequency error.
2. EUT is connected the external power supply to control the DC input power. The test voltage range is from minimum to maximum working voltage. Each step shall be record the frequency error rate.
3. The temperature range step is 10 degrees in this test items. All temperature levels shall be hold the $\pm 0.5^{\circ}\text{C}$ during the measurement testing. The each temperature step shall be at least 0.5 hours, consider the EUT could be test under the stability condition.
4. The frequency error was recorded frequency error from the communication simulator.

4.7.3 TEST SETUP LAYOUT

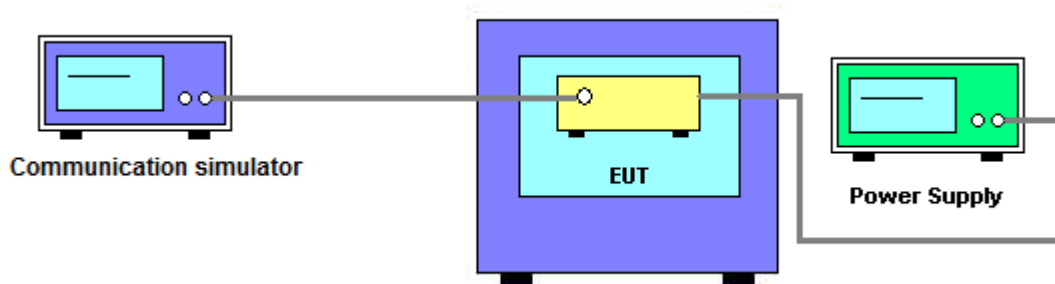

4.7.4 TEST DEVIATION

No deviation

4.7.5 TEST RESULTS

Please refer to the Appendix I.

5. LIST OF MEASUREMENT EQUIPMENTS

Radiated Emission Measurement					
Item	Kind of Equipment	Manufacturer	Type No.	Serial No.	Calibrated until
1	Antenna	Schwarzbeck	VULB9160	9160-3232	Mar. 09, 2020
2	Amplifier	Agilent	8449B	3008A02274	Mar. 10, 2020
3	Amplifier	HP	8447D	2944A09673	Aug. 11, 2019
4	HighPass Filter	Wairwright Instruments Gmbh	WHK 1.5/15G-10ST	11	Mar. 10, 2020
5	Band Reject Filter	Wairwright Instruments Gmbh	WRCG 1710/1785-1690/180 5-60/12SS	38	Mar. 10, 2020
6	Band Reject Filter	Wairwright Instruments Gmbh	WRCG 824/849-810/863-60/ 9SS	7	Mar. 10, 2020
7	Band Reject Filter	Wairwright Instruments Gmbh	WRCG 880/915-860/935-60/ 9SS	14	Mar. 10, 2020
8	Band Reject Filter	Wairwright Instruments Gmbh	WRCG 1850/1910-1830/193 0-60/10SS	17	Mar. 10, 2020
9	HighPass Filter	Wairwright Instruments Gmbh	WHK3.1/18G-10SS	24	Mar. 10, 2020
10	Wireless Communication Test SET	Agilent	E5515C	MY48364183	Mar. 10, 2020
11	Microwave Preamplifier With Adaptor	EMC INSTRUMENT	EMC2654045	980039 & HA01	Mar. 10, 2020
12	Receiver	Agilent	N9038A	MY52130039	Aug. 11, 2019
13	wideband radio communication tester	R&S	CMW500	152372	Mar. 10, 2020
14	Cable	emci	LMR-400(30MHz-1G Hz)(8m+5m)	N/A	May. 25, 2019
15	Cable	mitron	B10-01-01-12M	18072744	Jul. 30, 2019
16	Controller	ETS-Lindgren	2090	N/A	N/A
17	Measurement Software	Farad	EZ-EMC Ver.NB-03A1-01	N/A	N/A
18	Loop Antenna	EM	EM-6876-1	230	Jan. 15, 2020
19	Double Ridged Guide Antenna	ETS	3115	75789	Mar. 09, 2020
20	Broad-Band Horn Antenna	Schwarzbeck	BBHA 9170	9170319	Jun. 30, 2019

Conducted Emission & Band Edge & Occupied Bandwidth Measurement

Item	Kind of Equipment	Manufacturer	Type No.	Serial No.	Calibrated until
1	Wireless Communication Test SET	Agilent	E5515C	MY48364183	Mar. 10, 2020
2	EXA Spectrum Analyzer	Agilent	N9010A	MY50520044	Mar. 10, 2020
3	POWER SPLITTER	Mini-Circuits	ZFRSC-123-S+	331000910-1	Mar. 10, 2020
4	wideband radio communication tester	R&S	CMW500	152372	Mar. 10, 2020
5	Spectrum Analyzer	R&S	FSP40	100185	Aug. 11, 2019

Frequency Stability Measurement

Item	Kind of Equipment	Manufacturer	Type No.	Serial No.	Calibrated until
1	Wireless Communication Test SET	Agilent	E5515C	MY48364183	Mar. 10, 2020
2*	Multi-output DC Power Supply	GW Instek	GPC-3030DN	EK880675	Sep. 26, 2020
3	POWER SPLITTER	Mini-Circuits	ZFRSC-123-S+	331000910-1	Mar. 10, 2020
4	wideband radio communication tester	R&S	CMW500	152372	Mar. 10, 2020
5	Const Temp. & Humidity Chamber	Bell	BTH-50C	20170306001	Mar. 10, 2020

Remark: "N/A" denotes no model name, serial no. or calibration specified.

All calibration period of equipment list is one year.

*All calibration period of equipment list is three year

APPENDIX A - MAXIMUM OUTPUT POWER

Maximum Output Power (dBm):

PCS1900		Burst Output Power		
		512CH	661CH	810CH
		1850.2MHz	1880MHz	1909.8MHz
GSM (CS)		30.27	30.15	30.04
GPRS/EDGE (GMSK)	1 Tx Slot	30.18	30.09	30.00
	2 Tx Slot	26.74	26.82	26.94
	3 Tx Slot	24.96	24.94	25.07
	4 Tx Slot	23.73	23.69	23.83
EDGE (8PSK)	1 Tx Slot	24.99	24.88	25.01
	2 Tx Slot	21.95	21.91	21.98
	3 Tx Slot	20.19	20.11	20.21
	4 Tx Slot	19.02	18.94	18.93

Modulation	Band	WCDMA Band II		
	Tx Channel	9262CH	9400CH	9538CH
	Frequency	1852.4MHz	1880MHz	1907.6MHz
BPSK	RMC 12.2K	22.97	22.87	22.95
	RMC 64K	22.95	22.84	22.93
	RMC 144K	22.82	22.92	22.88
	RMC 384K	22.93	22.88	22.76
16QAM	HSDPA Subtest-1	22.39	22.34	22.43
	HSDPA Subtest-2	21.76	21.73	21.88
	HSDPA Subtest-3	21.31	21.23	21.37
	HSDPA Subtest-4	21.29	21.31	21.33
16QAM	HSUPA Subtest-1	21.16	21.28	21.02
	HSUPA Subtest-2	19.98	20.05	20.09
	HSUPA Subtest-3	21.79	21.71	21.56
	HSUPA Subtest-4	20.31	21.12	20.59
	HSUPA Subtest-5	23.02	22.9	23.04

LTE Band / BW	Modulation	RB Size	RB Offset	Low CH	Mid CH	High CH
				18607CH	18900CH	19193CH
				1850.7MHz	1880MHz	1909.3MHz
2 / 1.4M	QPSK	1	0	22.84	22.75	22.67
		1	2	22.23	22.57	22.42
		1	5	22.64	22.75	22.39
		3	0	22.62	22.60	22.61
		3	1	22.22	22.34	22.19
		3	2	22.25	22.45	22.20
		6	0	21.42	21.43	21.44
	16QAM	1	0	21.81	21.92	21.71
		1	2	21.77	21.66	21.17
		1	5	21.79	21.90	21.48
		3	0	21.67	21.67	21.52
		3	1	21.48	21.45	21.33
		3	2	21.35	21.77	21.25
		6	0	20.55	20.57	20.38
	64QAM	1	0	20.53	20.48	20.36
		1	2	20.45	20.44	20.27
		1	5	20.37	20.34	20.29
		3	0	20.36	20.51	20.37
		3	1	20.28	20.47	20.33
		3	2	20.43	20.41	20.36
		6	0	19.58	19.52	19.48

LTE Band / BW	Modulation	RB Size	RB Offset	Low CH	Mid CH	High CH
				18615CH	18900CH	19185CH
				1851.5MHz	1880MHz	1908.5MHz
2 / 3M	QPSK	1	0	22.79	22.57	22.48
		1	7	22.55	22.05	22.32
		1	14	22.57	22.70	22.38
		8	0	21.43	21.46	21.31
		8	4	21.47	21.45	21.33
		8	7	21.43	21.45	21.19
		15	0	21.42	21.48	21.38
	16QAM	1	0	21.78	21.75	21.63
		1	7	21.50	21.27	21.58
		1	14	21.68	21.90	21.69
		8	0	20.56	20.50	20.50
		8	4	20.60	20.53	20.25
		8	7	20.57	20.50	20.37
		15	0	20.53	20.50	20.35
	64QAM	1	0	20.47	20.43	20.38
		1	7	20.44	20.41	20.38
		1	14	20.51	20.37	20.45
		8	0	19.59	19.62	19.49
		8	4	19.52	19.56	19.59
		8	7	19.47	19.63	19.37
		15	0	19.44	19.52	19.41

LTE Band / BW	Modulation	RB Size	RB Offset	Low CH	Mid CH	High CH
				18625CH	18900CH	19175CH
				1852.5MHz	1880MHz	1907.5MHz
2 / 5M	QPSK	1	0	22.62	22.81	22.70
		1	13	22.63	22.79	22.78
		1	24	22.57	22.78	22.35
		12	0	21.38	21.69	21.60
		12	6	21.41	21.63	21.40
		12	11	21.39	21.64	21.43
		25	0	21.31	21.64	21.38
	16QAM	1	0	21.85	21.88	21.90
		1	13	21.83	21.82	21.89
		1	24	21.68	21.80	21.81
		12	0	20.51	20.63	20.40
		12	6	20.38	20.49	20.40
		12	11	20.48	20.59	20.25
		25	0	20.40	20.60	20.45
	64QAM	1	0	20.37	20.52	20.41
		1	13	20.33	20.48	20.39
		1	24	20.43	20.45	20.37
		12	0	19.58	19.53	19.66
		12	6	19.59	19.61	19.55
		12	11	19.49	19.54	19.59
		25	0	19.64	19.61	19.52

LTE Band / BW	Modulation	RB Size	RB Offset	Low CH	Mid CH	High CH
				18650CH	18900CH	19150CH
				1855MHz	1880MHz	1905MHz
2 / 10M	QPSK	1	0	22.72	22.69	22.69
		1	25	22.42	22.16	22.38
		1	49	22.58	22.73	22.56
		25	0	21.46	21.62	21.50
		25	13	21.46	21.54	21.43
		25	25	21.47	21.48	21.32
		50	0	21.45	21.48	21.48
	16QAM	1	0	21.63	21.71	21.74
		1	25	21.34	21.18	21.31
		1	49	21.75	21.74	21.68
		25	0	20.51	20.65	20.31
		25	13	20.54	20.61	20.30
		25	25	20.52	20.57	20.30
		50	0	20.50	20.58	20.37
	64QAM	1	0	20.48	20.53	20.36
		1	25	20.51	20.44	20.42
		1	49	20.61	20.47	20.49
		25	0	19.53	19.51	19.43
		25	13	19.39	19.48	19.46
		25	25	19.44	19.41	19.40
		50	0	19.65	19.58	19.45

LTE Band / BW	Modulation	RB Size	RB Offset	Low CH	Mid CH	High CH
				18675CH	18900CH	19125CH
				1857.5MHz	1880MHz	1902.5MHz
2 / 15M	QPSK	1	0	22.73	22.68	22.83
		1	38	22.66	22.35	22.68
		1	74	22.61	22.60	22.51
		36	0	21.55	21.50	21.57
		36	18	21.56	21.60	21.54
		36	39	21.51	21.52	21.51
		75	0	21.59	21.62	21.49
	16QAM	1	0	21.88	21.71	21.93
		1	38	21.81	21.69	21.85
		1	74	21.74	21.63	21.60
		36	0	20.47	21.63	20.51
		36	18	20.54	20.58	20.41
		36	39	20.42	20.55	20.47
		75	0	20.58	20.57	20.45
	64QAM	1	0	20.53	20.51	20.42
		1	38	20.49	20.44	20.39
		1	74	20.44	20.48	20.46
		36	0	19.66	19.63	19.67
		36	18	19.62	19.58	19.68
		36	39	19.65	19.52	19.63
		75	0	19.59	19.55	19.61

LTE Band / BW	Modulation	RB Size	RB Offset	Low CH	Mid CH	High CH
				18700CH	18900CH	19100CH
				1860MHz	1880MHz	1900MHz
2 / 20M	QPSK	1	0	22.84	22.94	22.85
		1	50	22.36	22.57	22.38
		1	99	22.78	22.81	22.62
		50	0	21.63	21.65	21.57
		50	25	21.47	21.63	21.57
		50	50	21.47	21.61	21.34
		100	0	21.46	21.62	21.53
	16QAM	1	0	21.95	21.88	22.00
		1	50	21.47	21.39	21.55
		1	99	21.98	21.88	21.83
		50	0	20.53	20.58	20.55
		50	25	20.39	20.59	20.56
		50	50	20.39	20.57	20.31
		100	0	20.48	20.62	20.54
	64QAM	1	0	20.44	20.58	20.49
		1	50	20.49	20.51	20.48
		1	99	20.55	20.53	20.47
		50	0	19.61	19.65	19.72
		50	25	19.64	19.66	19.58
		50	50	19.59	19.63	19.57
		100	0	19.55	19.53	19.49

EIRP Power (dBm):

PCS1900		EIRP Power		
		512CH	661CH	810CH
		1850.2MHz	1880MHz	1909.8MHz
GSM (CS)		28.47	28.35	28.24
GPRS/EDGE (GMSK)	1 Tx Slot	28.38	28.29	28.20
	2 Tx Slot	24.94	25.02	25.14
	3 Tx Slot	23.16	23.14	23.27
	4 Tx Slot	21.93	21.89	22.03
EDGE (8PSK)	1 Tx Slot	23.19	23.08	23.21
	2 Tx Slot	20.15	20.11	20.18
	3 Tx Slot	18.39	18.31	18.41
	4 Tx Slot	17.22	17.14	17.13

Modulation	Band	WCDMA Band II		
	Tx Channel	9262CH	9400CH	9538CH
	Frequency	1852.4MHz	1880MHz	1907.6MHz
BPSK	RMC 12.2K	21.17	21.07	21.15
	RMC 64K	21.15	21.04	21.13
	RMC 144K	21.02	21.12	21.08
	RMC 384K	21.13	21.08	20.96
16QAM	HSDPA Subtest-1	20.59	20.54	20.63
	HSDPA Subtest-2	19.96	19.93	20.08
	HSDPA Subtest-3	19.51	19.43	19.57
	HSDPA Subtest-4	19.49	19.51	19.53
16QAM	HSUPA Subtest-1	19.36	19.48	19.22
	HSUPA Subtest-2	18.18	18.25	18.29
	HSUPA Subtest-3	19.99	19.91	19.76
	HSUPA Subtest-4	18.51	19.32	18.79
	HSUPA Subtest-5	21.22	21.10	21.24

LTE Band / BW	Modulation	RB Size	RB Offset	Low CH	Mid CH	High CH
				18607CH	18900CH	19193CH
				1850.7MHz	1880MHz	1909.3MHz
2 / 1.4M	QPSK	1	0	21.04	20.95	20.87
		1	2	20.43	20.77	20.62
		1	5	20.84	20.95	20.59
		3	0	20.82	20.80	20.81
		3	1	20.42	20.54	20.39
		3	2	20.45	20.65	20.40
		6	0	19.62	19.63	19.64
	16QAM	1	0	20.01	20.12	19.91
		1	2	19.97	19.86	19.37
		1	5	19.99	20.10	19.68
		3	0	19.87	19.87	19.72
		3	1	19.68	19.65	19.53
		3	2	19.55	19.97	19.45
		6	0	18.75	18.77	18.58
	64QAM	1	0	18.73	18.68	18.56
		1	2	18.65	18.64	18.47
		1	5	18.57	18.54	18.49
		3	0	18.56	18.71	18.57
		3	1	18.48	18.67	18.53
		3	2	18.63	18.61	18.56
		6	0	17.78	17.72	17.68

LTE Band / BW	Modulation	RB Size	RB Offset	Low CH	Mid CH	High CH
				18615CH	18900CH	19185CH
				1851.5MHz	1880MHz	1908.5MHz
2 / 3M	QPSK	1	0	20.99	20.77	20.68
		1	7	20.75	20.25	20.52
		1	14	20.77	20.90	20.58
		8	0	19.63	19.66	19.51
		8	4	19.67	19.65	19.53
		8	7	19.63	19.65	19.39
		15	0	19.62	19.68	19.58
	16QAM	1	0	19.98	19.95	19.83
		1	7	19.70	19.47	19.78
		1	14	19.88	20.10	19.89
		8	0	18.76	18.70	18.70
		8	4	18.80	18.73	18.45
		8	7	18.77	18.70	18.57
		15	0	18.73	18.70	18.55
	64QAM	1	0	18.67	18.63	18.58
		1	7	18.64	18.61	18.58
		1	14	18.71	18.57	18.65
		8	0	17.79	17.82	17.69
		8	4	17.72	17.76	17.79
		8	7	17.67	17.83	17.57
		15	0	17.64	17.72	17.61

LTE Band / BW	Modulation	RB Size	RB Offset	Low CH	Mid CH	High CH
				18625CH	18900CH	19175CH
				1852.5MHz	1880MHz	1907.5MHz
2 / 5M	QPSK	1	0	20.82	21.01	20.90
		1	13	20.83	20.99	20.98
		1	24	20.77	20.98	20.55
		12	0	19.58	19.89	19.80
		12	6	19.61	19.83	19.60
		12	11	19.59	19.84	19.63
		25	0	19.51	19.84	19.58
	16QAM	1	0	20.05	20.08	20.10
		1	13	20.03	20.02	20.09
		1	24	19.88	20.00	20.01
		12	0	18.71	18.83	18.60
		12	6	18.58	18.69	18.60
		12	11	18.68	18.79	18.45
		25	0	18.60	18.80	18.65
	64QAM	1	0	18.57	18.72	18.61
		1	13	18.53	18.68	18.59
		1	24	18.63	18.65	18.57
		12	0	17.78	17.73	17.86
		12	6	17.79	17.81	17.75
		12	11	17.69	17.74	17.79
		25	0	17.84	17.81	17.72

LTE Band / BW	Modulation	RB Size	RB Offset	Low CH	Mid CH	High CH
				18650CH	18900CH	19150CH
				1855MHz	1880MHz	1905MHz
2 / 10M	QPSK	1	0	20.92	20.89	20.89
		1	25	20.62	20.36	20.58
		1	49	20.78	20.93	20.76
		25	0	19.66	19.82	19.70
		25	13	19.66	19.74	19.63
		25	25	19.67	19.68	19.52
		50	0	19.65	19.68	19.68
	16QAM	1	0	19.83	19.91	19.94
		1	25	19.54	19.38	19.51
		1	49	19.95	19.94	19.88
		25	0	18.71	18.85	18.51
		25	13	18.74	18.81	18.50
		25	25	18.72	18.77	18.50
		50	0	18.70	18.78	18.57
	64QAM	1	0	18.68	18.73	18.56
		1	25	18.71	18.64	18.62
		1	49	18.81	18.67	18.69
		25	0	17.73	17.71	17.63
		25	13	17.59	17.68	17.66
		25	25	17.64	17.61	17.60
		50	0	17.85	17.78	17.65

LTE Band / BW	Modulation	RB Size	RB Offset	Low CH	Mid CH	High CH
				18675CH	18900CH	19125CH
				1857.5MHz	1880MHz	1902.5MHz
2 / 15M	QPSK	1	0	20.93	20.88	21.03
		1	38	20.86	20.55	20.88
		1	74	20.81	20.80	20.71
		36	0	19.75	19.70	19.77
		36	18	19.76	19.80	19.74
		36	39	19.71	19.72	19.71
		75	0	19.79	19.82	19.69
	16QAM	1	0	20.08	19.91	20.13
		1	38	20.01	19.89	20.05
		1	74	19.94	19.83	19.80
		36	0	18.67	19.83	18.71
		36	18	18.74	18.78	18.61
		36	39	18.62	18.75	18.67
		75	0	18.78	18.77	18.65
	64QAM	1	0	18.73	18.71	18.62
		1	38	18.69	18.64	18.59
		1	74	18.64	18.68	18.66
		36	0	17.86	17.83	17.87
		36	18	17.82	17.78	17.88
		36	39	17.85	17.72	17.83
		75	0	17.79	17.75	17.81

LTE Band / BW	Modulation	RB Size	RB Offset	Low CH	Mid CH	High CH
				18700CH	18900CH	19100CH
				1860MHz	1880MHz	1900MHz
2 / 20M	QPSK	1	0	21.04	21.14	21.05
		1	50	20.56	20.77	20.58
		1	99	20.98	21.01	20.82
		50	0	19.83	19.85	19.77
		50	25	19.67	19.83	19.77
		50	50	19.67	19.81	19.54
		100	0	19.66	19.82	19.73
	16QAM	1	0	20.15	20.08	20.20
		1	50	19.67	19.59	19.75
		1	99	20.18	20.08	20.03
		50	0	18.73	18.78	18.75
		50	25	18.59	18.79	18.76
		50	50	18.59	18.77	18.51
		100	0	18.68	18.82	18.74
	64QAM	1	0	18.64	18.78	18.69
		1	50	18.69	18.71	18.68
		1	99	18.75	18.73	18.67
		50	0	17.81	17.85	17.92
		50	25	17.84	17.86	17.78
		50	50	17.79	17.83	17.77
		100	0	17.75	17.73	17.69

APPENDIX B - OCCUPIED BANDWIDTH

PCS1900					
GSM			EDGE		
CS			8PSK		
Channel	Frequency (MHz)	99% Occupied Bandwidth (MHz)	Channel	Frequency (MHz)	99% Occupied Bandwidth (MHz)
512	1850.2	0.250	512	1850.2	0.251
661	1880	0.247	661	1880	0.247
810	1909.8	0.247	810	1909.8	0.251
Channel	Frequency (MHz)	26dB Bandwidth (MHz)	Channel	Frequency (MHz)	26dB Bandwidth (MHz)
512	1850.2	0.311	512	1850.2	0.321
661	1880	0.321	661	1880	0.317
810	1909.8	0.307	810	1909.8	0.324

Spectrum Plot

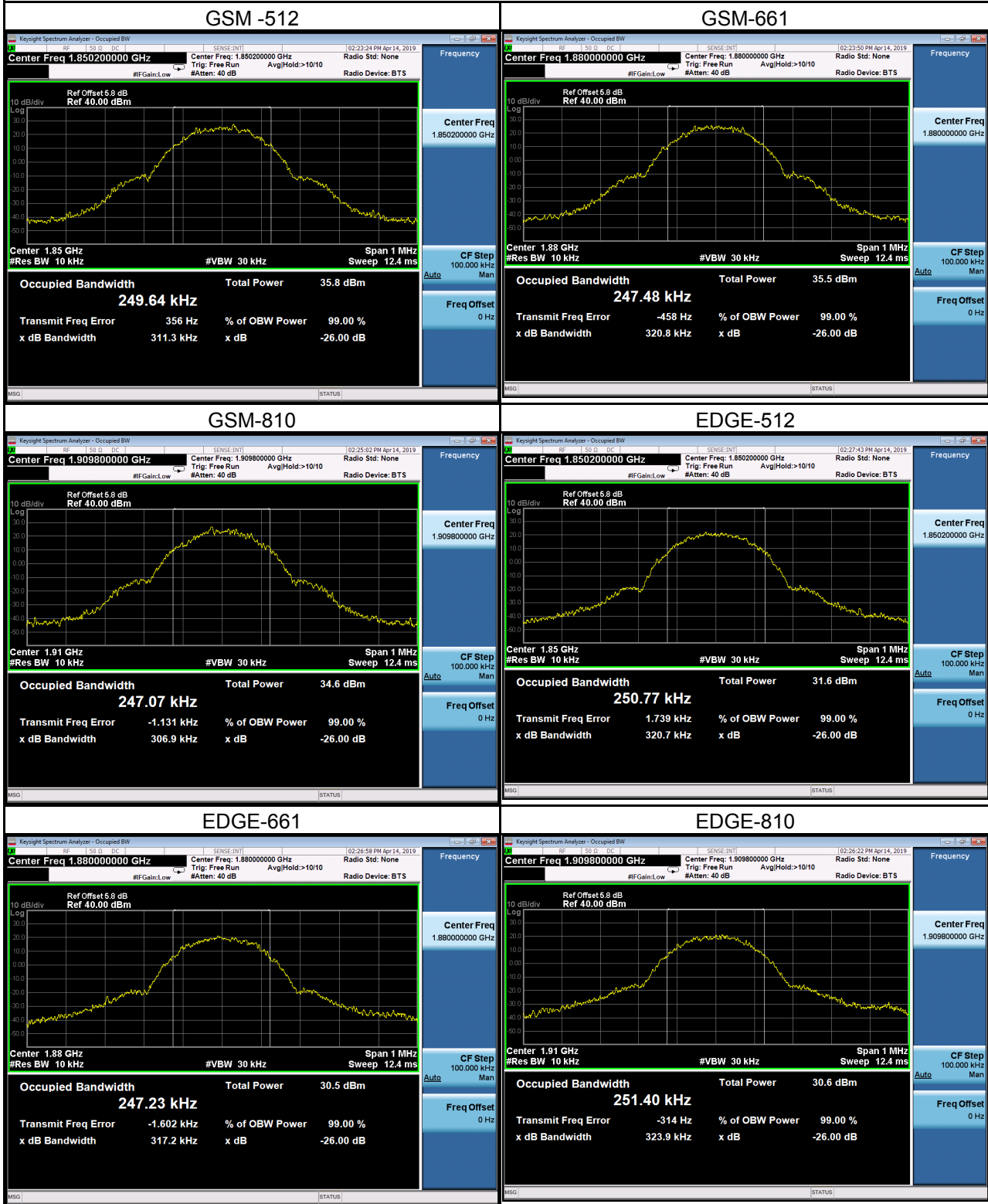

WCDMA Band II

BPSK

Channel	Frequency (MHz)	99% Occupied Bandwidth (MHz)	Channel	Frequency (MHz)	26dB Bandwidth (MHz)
9262	1852.4	4.175	9262	1852.4	4.717
9400	1880	4.168	9400	1880	4.741
9538	1907.6	4.169	9538	1907.6	4.739

Spectrum Plot



WCDMA_HSDPA Band II					
16QAM					
Channel	Frequency (MHz)	99% Occupied Bandwidth (MHz)	Channel	Frequency (MHz)	26dB Bandwidth (MHz)
9262	1852.4	4.164	9262	1852.4	4.728
9400	1880	4.169	9400	1880	4.738
9538	1907.6	4.169	9538	1907.6	4.706



WCDMA_HSUPA Band II					
16QAM					
Channel	Frequency (MHz)	99% Occupied Bandwidth (MHz)	Channel	Frequency (MHz)	26dB Bandwidth (MHz)
9262	1852.4	4.162	9262	1852.4	4.751
9400	1880	4.188	9400	1880	4.742
9538	1907.6	4.167	9538	1907.6	4.724



LTE Band 2_1.4M					
QPSK			16QAM		
Channel	Frequency (MHz)	99% Occupied Bandwidth (MHz)	Channel	Frequency (MHz)	99% Occupied Bandwidth (MHz)
18607	1850.7	1.090	18607	1850.7	1.092
18900	1880	1.093	18900	1880	1.092
19193	1909.3	1.091	19193	1909.3	1.089
Channel	Frequency (MHz)	26dB Bandwidth (MHz)	Channel	Frequency (MHz)	26dB Bandwidth (MHz)
18607	1850.7	1.241	18607	1850.7	1.230
18900	1880	1.239	18900	1880	1.229
19193	1909.3	1.238	19193	1909.3	1.239

Spectrum Plot

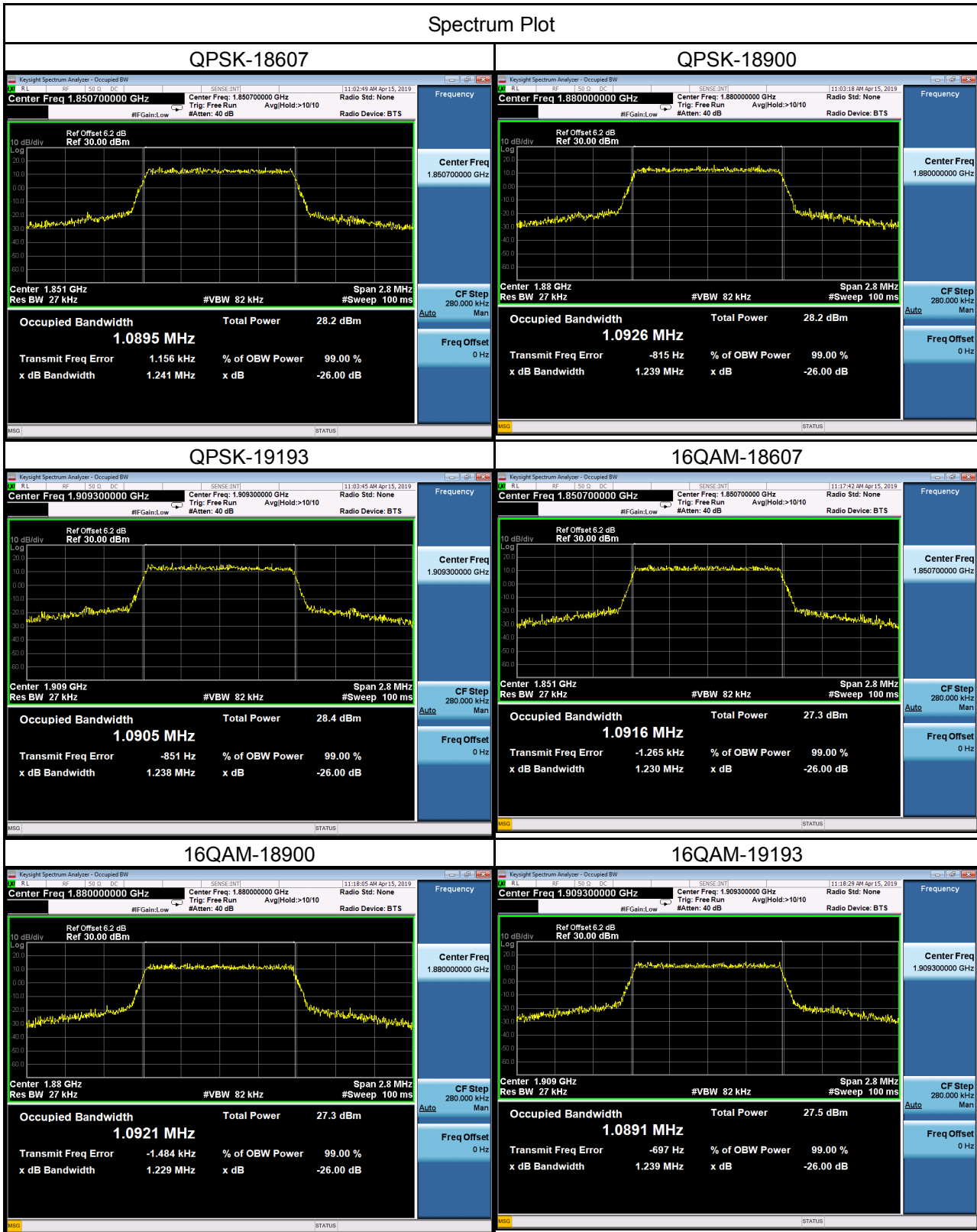

LTE Band 2_3M					
QPSK			16QAM		
Channel	Frequency (MHz)	99% Occupied Bandwidth (MHz)	Channel	Frequency (MHz)	99% Occupied Bandwidth (MHz)
18615	1851.5	2.701	18615	1851.5	2.699
18900	1880	2.702	18900	1880	2.700
19185	1908.5	2.699	19185	1908.5	2.700
Channel	Frequency (MHz)	26dB Bandwidth (MHz)	Channel	Frequency (MHz)	26dB Bandwidth (MHz)
18615	1851.5	3.025	18615	1851.5	2.972
18900	1880	2.994	18900	1880	2.973
19185	1908.5	2.982	19185	1908.5	2.972

Spectrum Plot

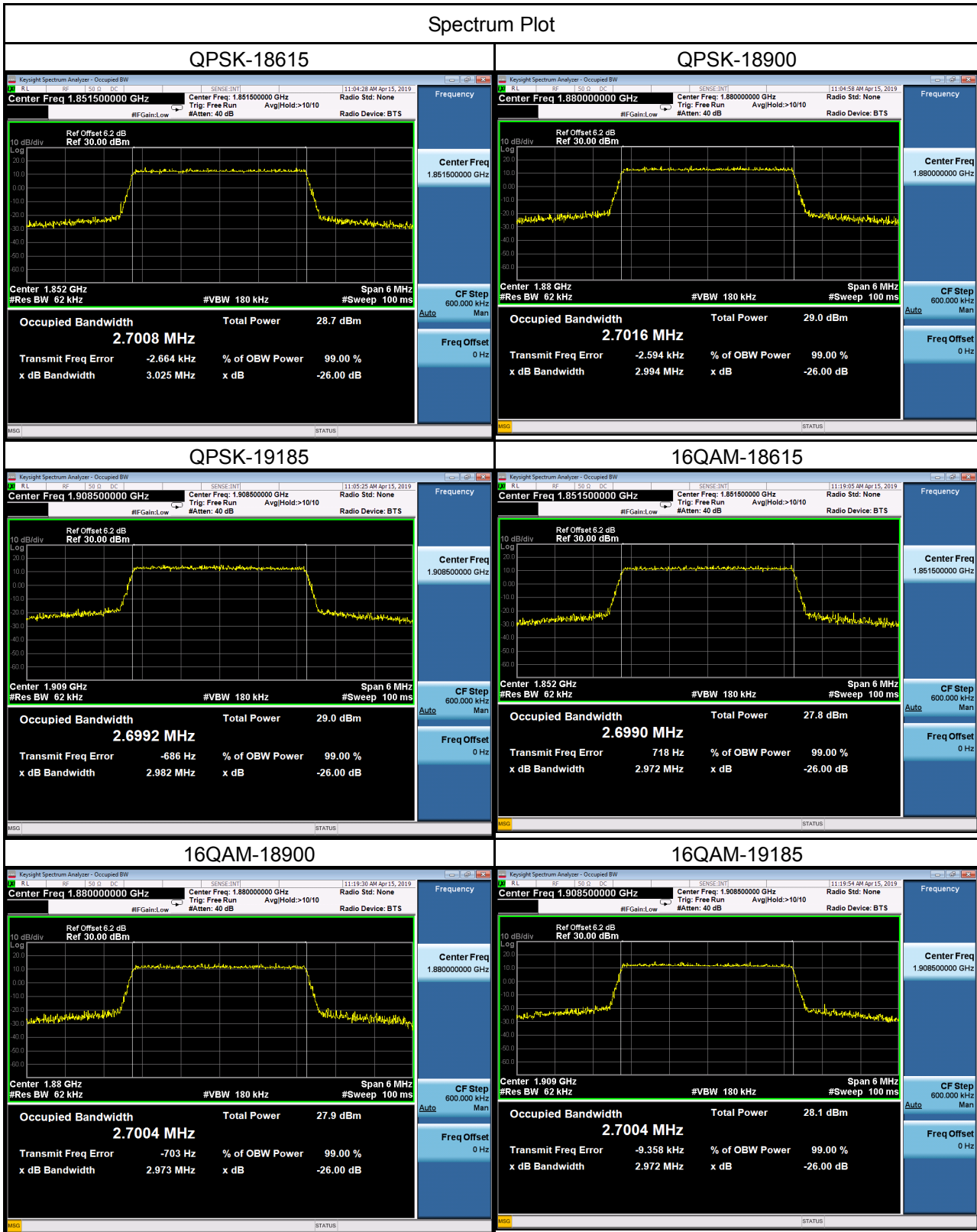

LTE Band 2_5M					
QPSK			16QAM		
Channel	Frequency (MHz)	99% Occupied Bandwidth (MHz)	Channel	Frequency (MHz)	99% Occupied Bandwidth (MHz)
18625	1852.5	4.500	18625	1852.5	4.505
18900	1880	4.513	18900	1880	4.509
19175	1907.5	4.502	19175	1907.5	4.515
Channel	Frequency (MHz)	26dB Bandwidth (MHz)	Channel	Frequency (MHz)	26dB Bandwidth (MHz)
18625	1852.5	4.989	18625	1852.5	4.959
18900	1880	4.964	18900	1880	4.920
19175	1907.5	4.948	19175	1907.5	4.961

Spectrum Plot

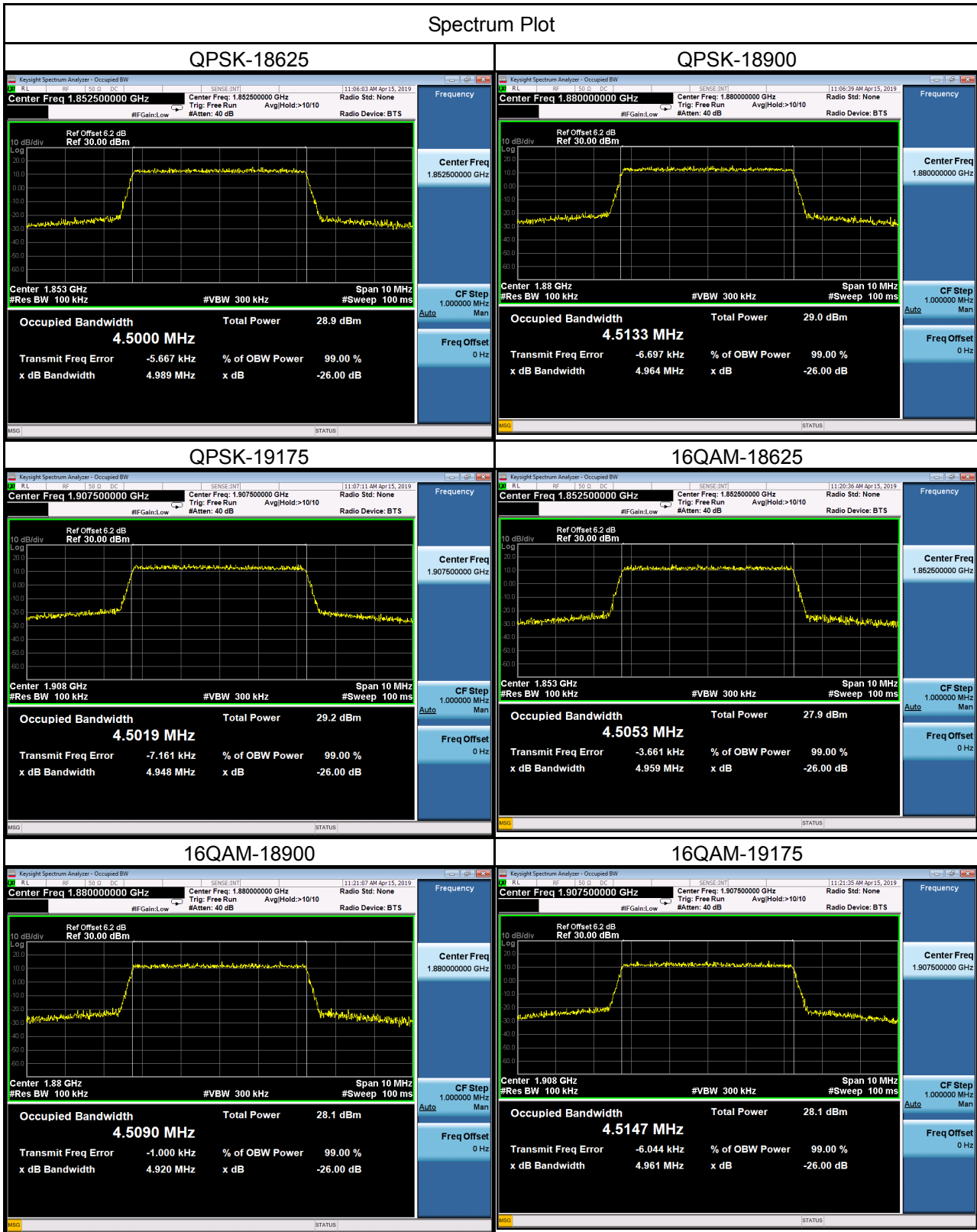

LTE Band 2_10M					
QPSK			16QAM		
Channel	Frequency (MHz)	99% Occupied Bandwidth (MHz)	Channel	Frequency (MHz)	99% Occupied Bandwidth (MHz)
18650	1855	8.970	18650	1855	8.988
18900	1880	8.970	18900	1880	8.997
19150	1905	8.987	19150	1905	9.000
Channel	Frequency (MHz)	26dB Bandwidth (MHz)	Channel	Frequency (MHz)	26dB Bandwidth (MHz)
18650	1855	9.938	18650	1855	9.909
18900	1880	9.812	18900	1880	9.930
19150	1905	9.813	19150	1905	9.861

Spectrum Plot

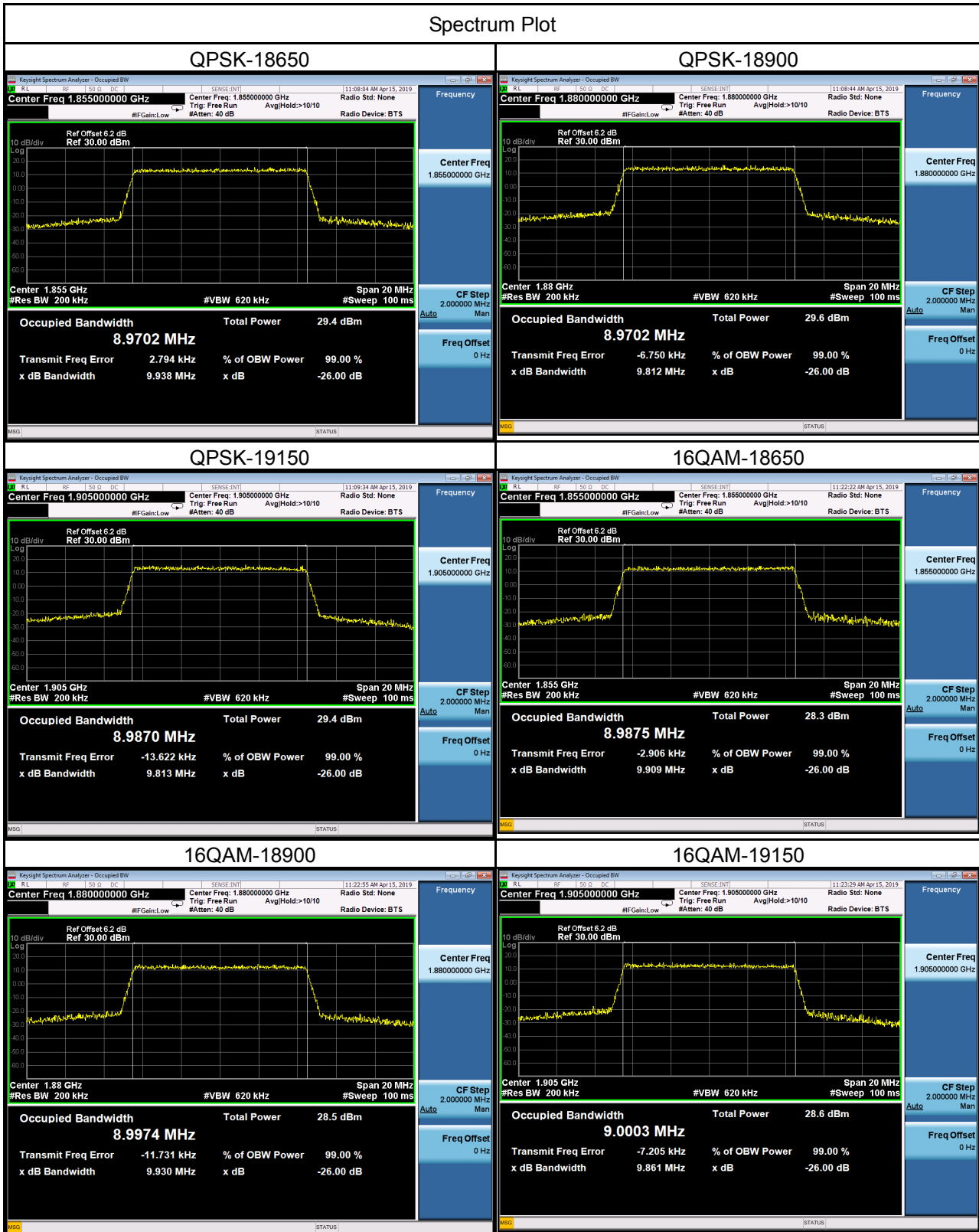

LTE Band 2_15M					
QPSK			16QAM		
Channel	Frequency (MHz)	99% Occupied Bandwidth (MHz)	Channel	Frequency (MHz)	99% Occupied Bandwidth (MHz)
18675	1857.5	13.454	18675	1857.5	13.459
18900	1880	13.481	18900	1880	13.488
19125	1902.5	13.483	19125	1902.5	13.466
Channel	Frequency (MHz)	26dB Bandwidth (MHz)	Channel	Frequency (MHz)	26dB Bandwidth (MHz)
18675	1857.5	14.950	18675	1857.5	14.880
18900	1880	14.910	18900	1880	14.980
19125	1902.5	14.920	19125	1902.5	14.900

Spectrum Plot

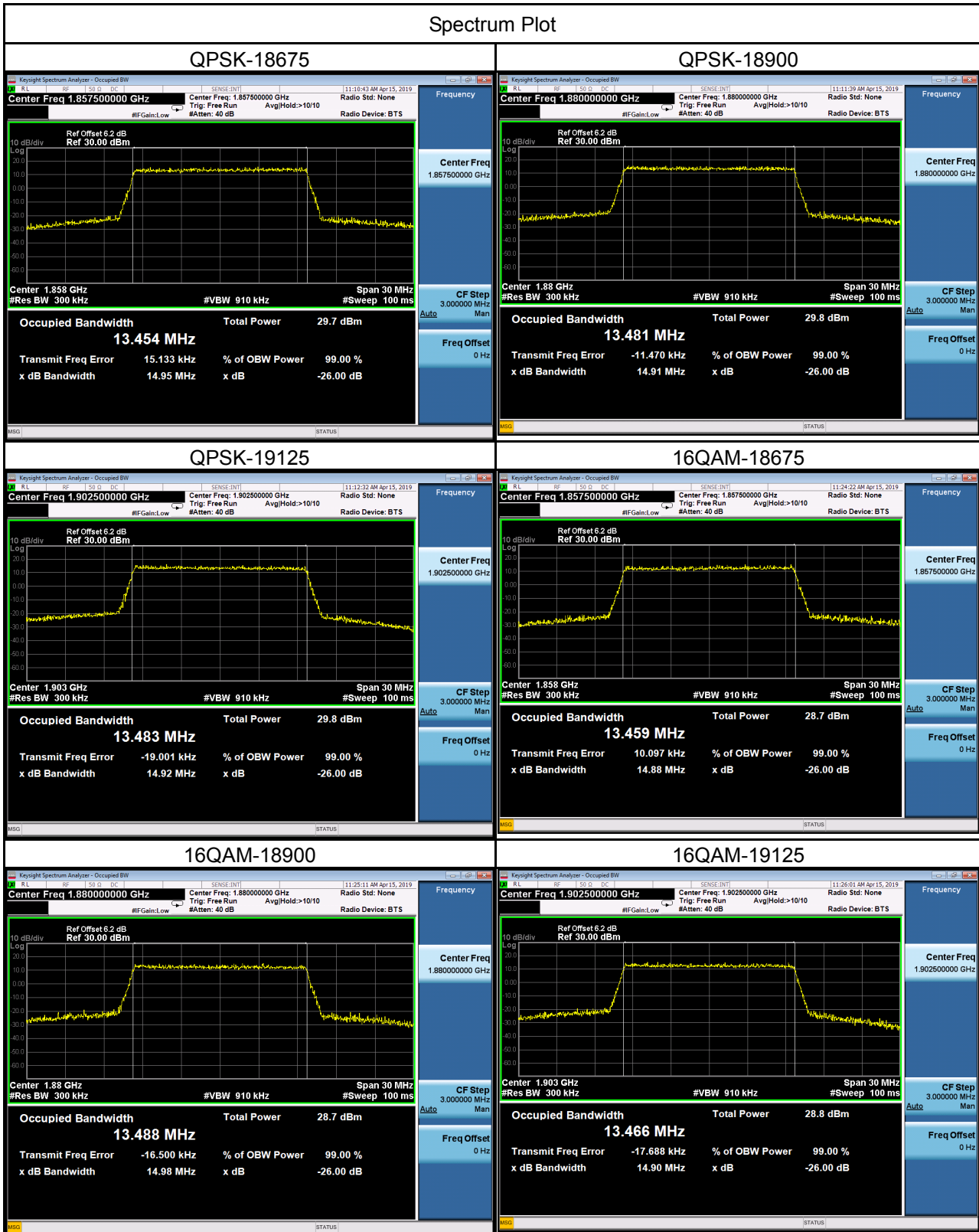

LTE Band 2_20M					
QPSK			16QAM		
Channel	Frequency (MHz)	99% Occupied Bandwidth (MHz)	Channel	Frequency (MHz)	99% Occupied Bandwidth (MHz)
18700	1860	17.990	18700	1860	17.924
18900	1880	17.968	18900	1880	17.964
19100	1900	18.006	19100	1900	17.987
Channel	Frequency (MHz)	26dB Bandwidth (MHz)	Channel	Frequency (MHz)	26dB Bandwidth (MHz)
18700	1860	19.760	18700	1860	19.850
18900	1880	19.810	18900	1880	19.780
19100	1900	19.770	19100	1900	19.650

Spectrum Plot

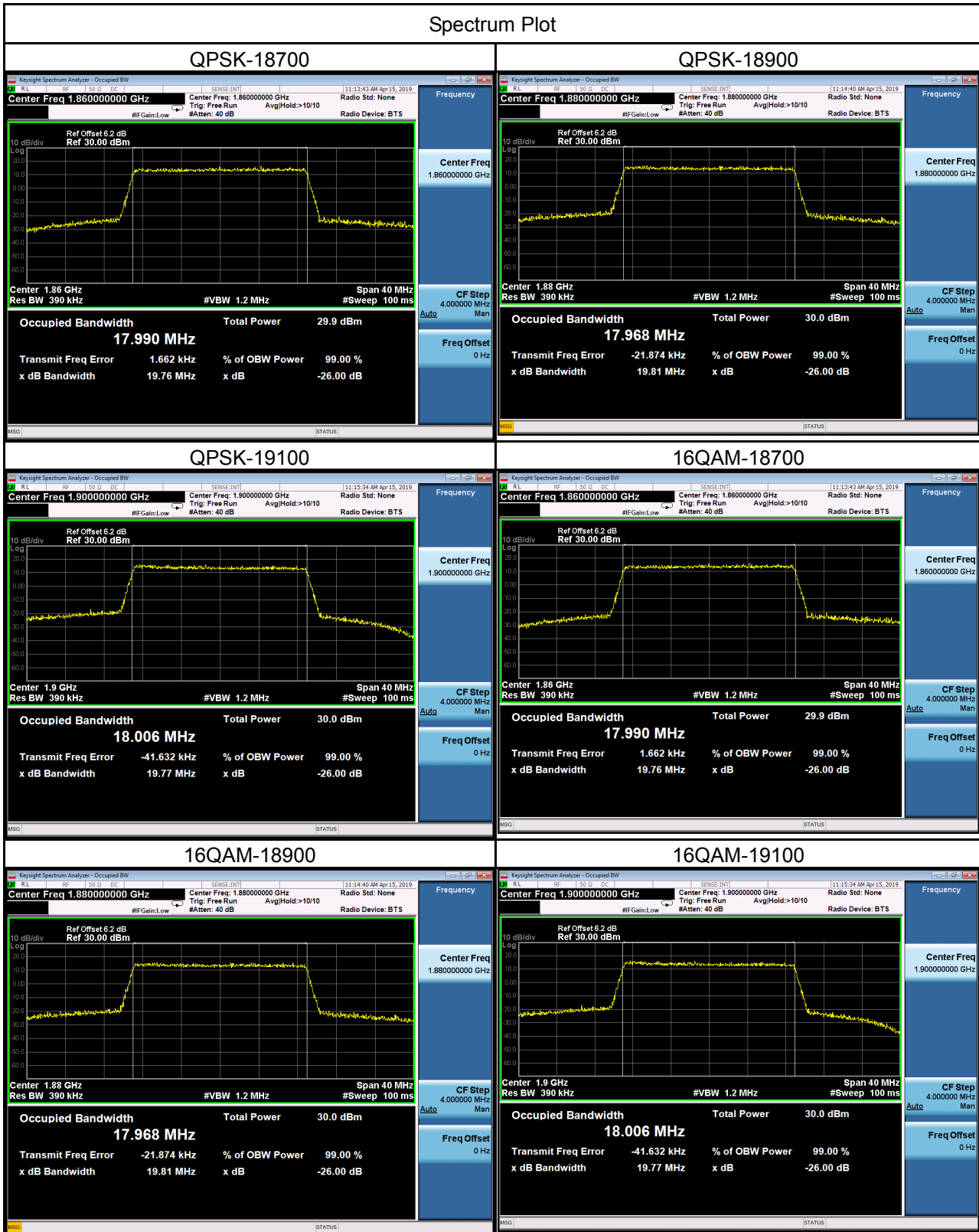

APPENDIX C - CONDUCTED EMISSIONS

PCS1900			
GSM		GSM	
Channel	Frequency(MHz)	Channel	Frequency(MHz)
661	1880	661	1880
GSM		EDGE	
Channel	Frequency(MHz)	Channel	Frequency(MHz)
661	1880	661	1880
EDGE		EDGE	
Channel	Frequency(MHz)	Channel	Frequency(MHz)
661	1880	661	1880

WCDMA Band II

Channel	Frequency(MHz)	Channel	Frequency(MHz)
9400	1880	9400	1880
Channel	Frequency(MHz)	-	-
9400	1880	-	-
		-	

LTE Band 2_1.4M

Channel	Frequency(MHz)	Channel	Frequency(MHz)
18900	1880	18900	1880
Channel	Frequency(MHz)	-	-
18900	1880	-	-

LTE Band 2_5M

Channel	Frequency(MHz)	Channel	Frequency(MHz)
18900	1880	18900	1880
Channel	Frequency(MHz)	-	-
18900	1880	-	-
		-	

LTE Band 2_20M

Channel	Frequency(MHz)	Channel	Frequency(MHz)
18900	1880	18900	1880
Channel	Frequency(MHz)	-	-
18900	1880	-	-

APPENDIX D - RADIATED EMISSION (9KHZ TO 30MHZ)

Test Mode: TX Mode

Ant 0°

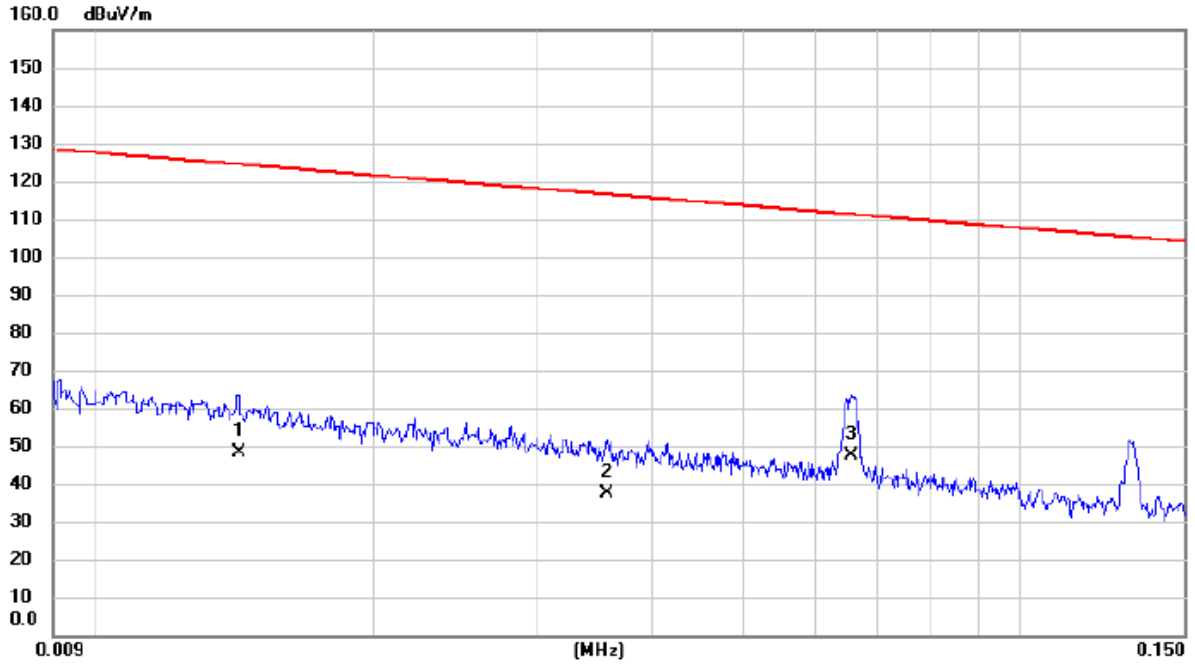

No.	Mk.	Freq. MHz	Reading Level dBuV	Correct Factor dB	Measure- ment dBuV/m	Limit dBuV/m	Margin dB	Detector	Comment
1		0.0143	32.80	15.53	48.33	124.50	-76.17	AVG	
2		0.0357	23.40	13.88	37.28	116.55	-79.27	AVG	
3	*	0.0656	33.70	13.68	47.38	111.27	-63.89	AVG	

Test Mode: TX Mode

Ant 0°

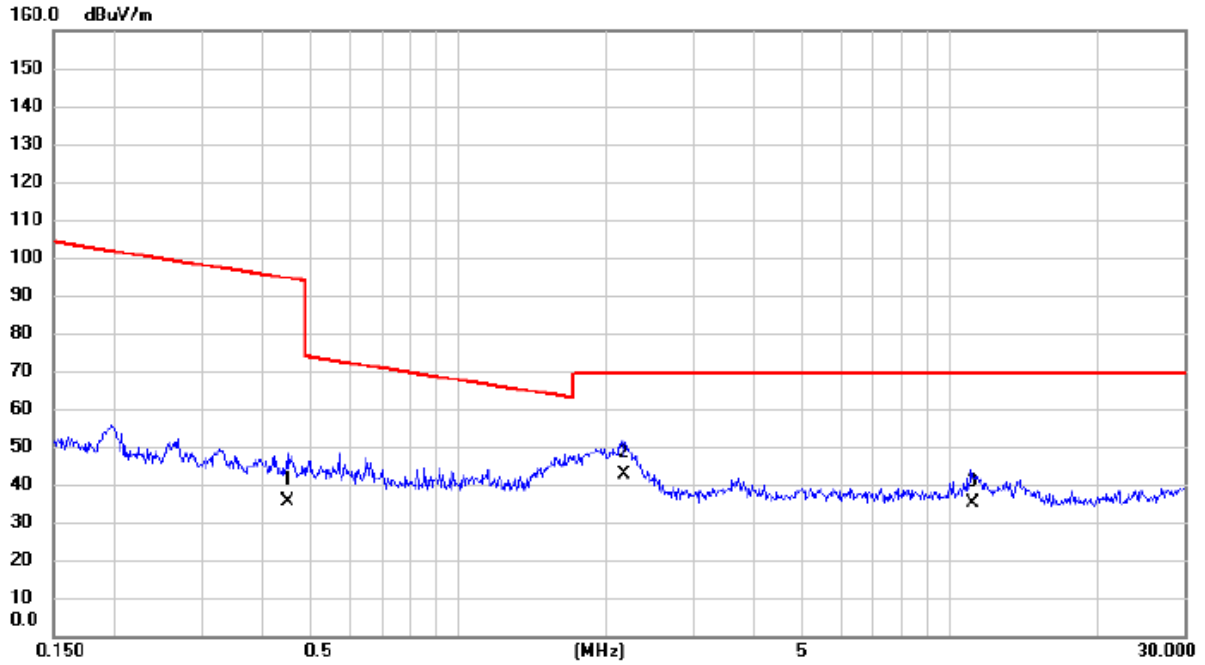

No.	Mk.	Freq. MHz	Reading Level dBuV	Correct Factor dB	Measure- ment dBuV/m	Limit dBuV/m	Margin dB	Detector	Comment
1		0.4492	22.20	13.18	35.38	94.56	-59.18	AVG	
2	*	2.1783	30.70	11.71	42.41	69.54	-27.13	QP	
3		11.0797	23.40	11.62	35.02	69.54	-34.52	QP	

Test Mode: TX Mode

Ant 90°

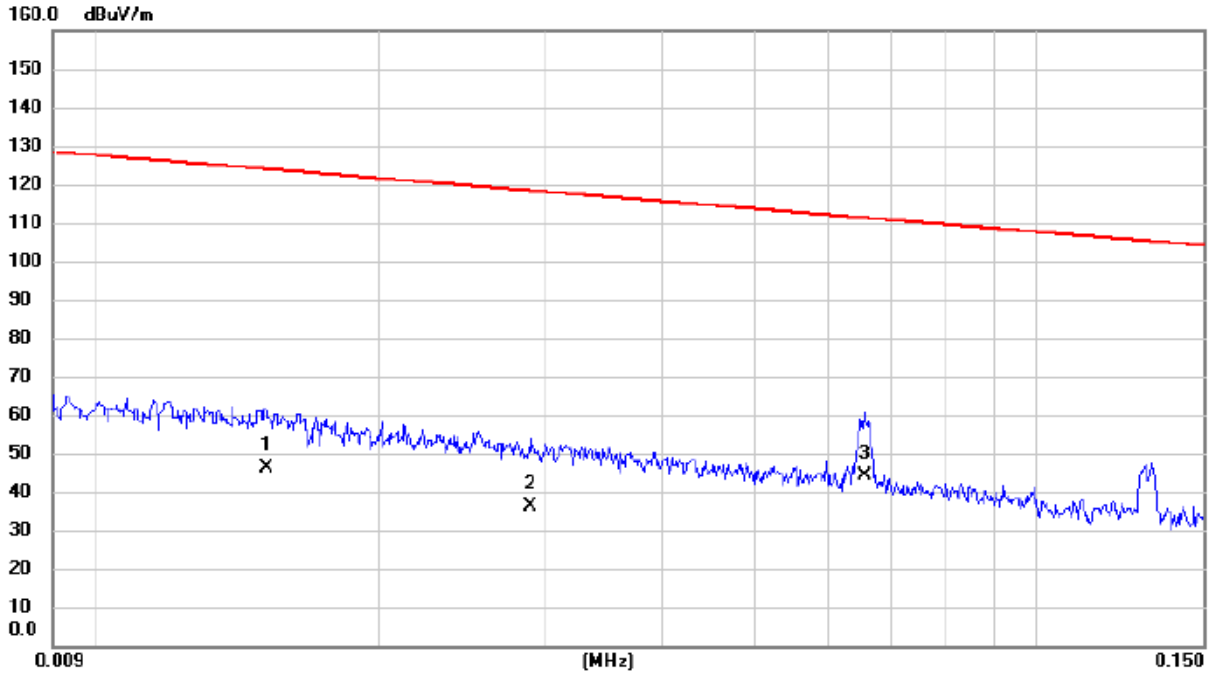

No.	Mk.	Freq. MHz	Reading Level dBuV	Correct Factor dB	Measure- ment dBuV/m	Limit dBuV/m	Margin dB	Detector	Comment
1		0.0152	31.10	15.26	46.36	123.97	-77.61	AVG	
2		0.0290	22.50	13.85	36.35	118.36	-82.01	AVG	
3	*	0.0656	30.40	13.68	44.08	111.27	-67.19	AVG	

Test Mode: TX Mode

Ant 90°

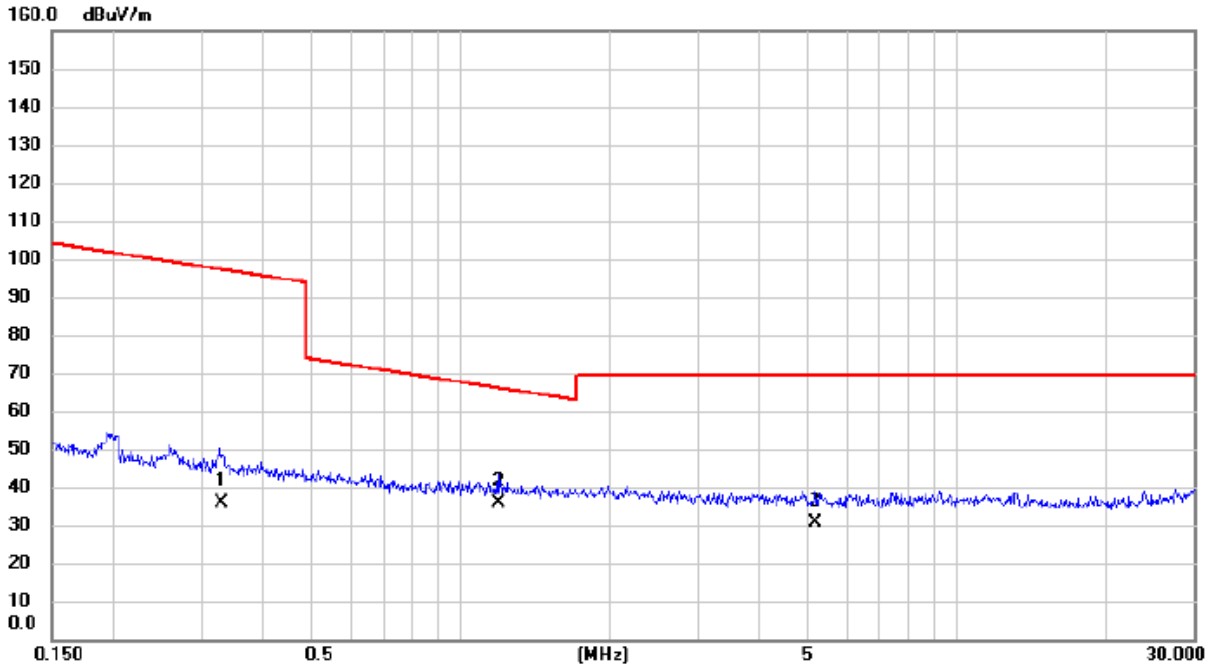

No.	Mk.	Freq. MHz	Reading Level dBuV	Correct Factor dB	Measure- ment dBuV/m	Limit dBuV/m	Margin dB	Detector	Comment
1		0.3286	22.30	13.47	35.77	97.27	-61.50	AVG	
2	*	1.1907	23.40	12.37	35.77	66.09	-30.32	QP	
3		5.1663	19.70	10.88	30.58	69.54	-38.96	QP	

APPENDIX E - RADIATED EMISSION (30MHZ TO 1GHZ)

Test Mode: PCS1900_TX CH661_GSM_with Accessory Devices_Main Antenna

Vertical

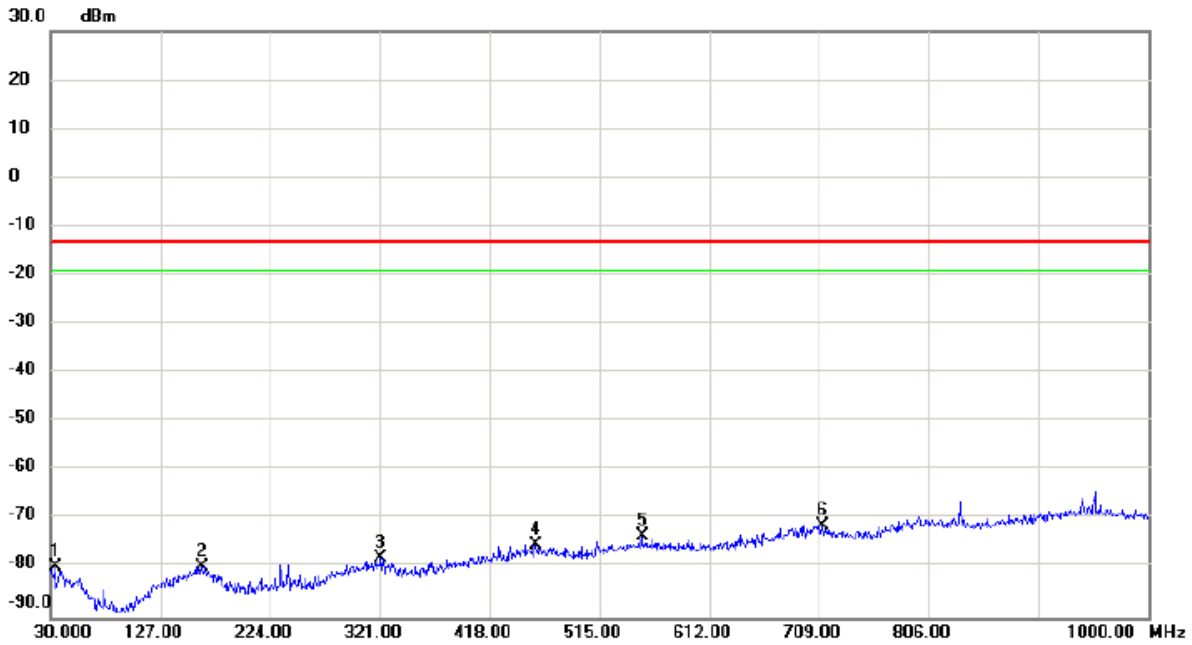

No.	Mk.	Freq. MHz	Reading Level dBm	Correct Factor dB	Measure- ment dBm	Limit dBm	Margin dB	Detector	Comment
1		33.880	-64.98	-14.82	-79.80	-13.00	-66.80	peak	
2		163.860	-68.89	-10.83	-79.72	-13.00	-66.72	peak	
3		321.970	-67.27	-10.68	-77.95	-13.00	-64.95	peak	
4		458.740	-67.65	-7.60	-75.25	-13.00	-62.25	peak	
5		552.830	-67.93	-5.52	-73.45	-13.00	-60.45	peak	
6	*	711.910	-68.08	-3.06	-71.14	-13.00	-58.14	peak	

Test Mode: PCS1900_TX CH661_GSM_with Accessory Devices_Main Antenna

Horizontal

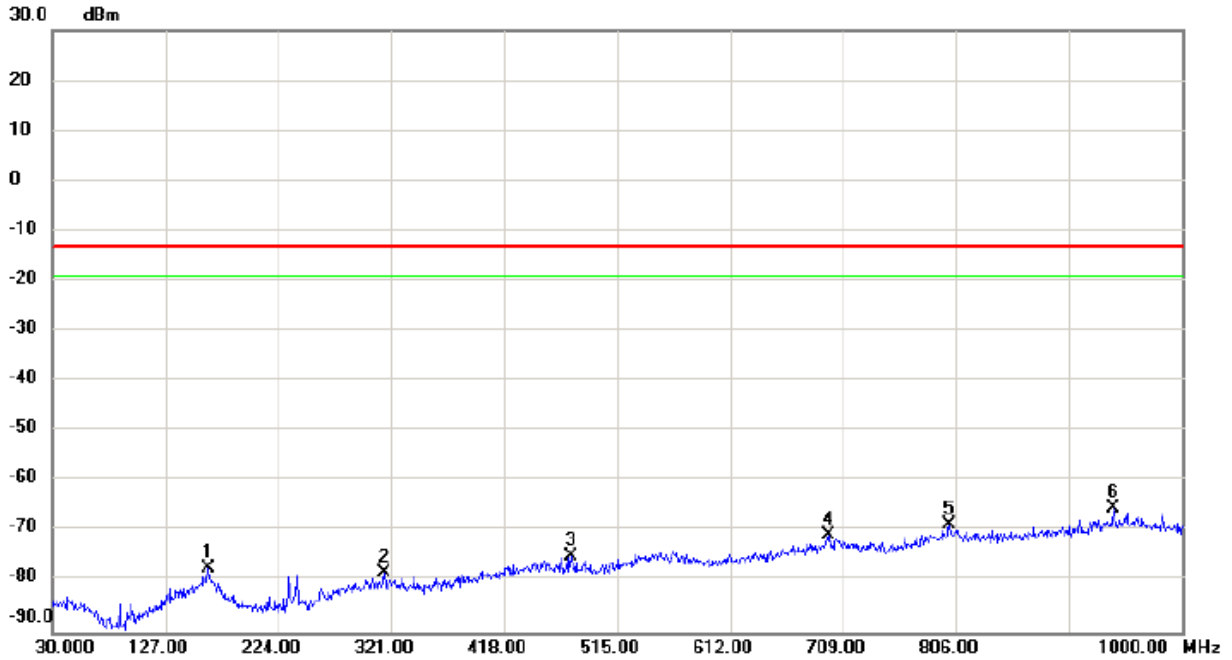

No.	Mk.	Freq. MHz	Reading Level dBm	Correct Factor dB	Measure- ment dBm	Limit dBm	Margin dB	Detector	Comment
1		163.860	-66.56	-10.83	-77.39	-13.00	-64.39	peak	
2		315.180	-67.58	-10.58	-78.16	-13.00	-65.16	peak	
3		475.230	-67.02	-7.97	-74.99	-13.00	-61.99	peak	
4		696.390	-67.66	-2.93	-70.59	-13.00	-57.59	peak	
5		800.180	-67.51	-1.04	-68.55	-13.00	-55.55	peak	
6	*	940.830	-66.42	1.04	-65.38	-13.00	-52.38	peak	

Test Mode: PCS1900_TX CH661_EDGE_with Accessory Devices_Main Antenna

Vertical

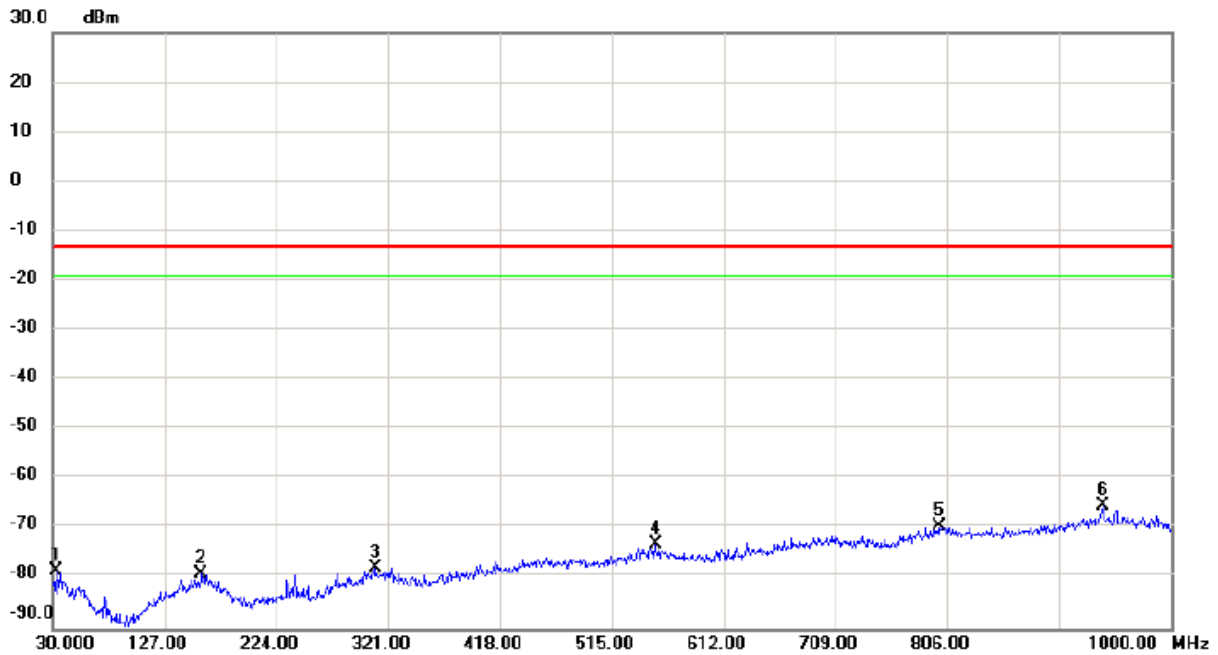

No.	Mk.	Freq. MHz	Reading Level dBm	Correct Factor dB	Measure- ment dBm	Limit dBm	Margin dB	Detector	Comment
1		32.910	-63.57	-14.94	-78.51	-13.00	-65.51	peak	
2		159.010	-68.35	-10.68	-79.03	-13.00	-66.03	peak	
3		309.360	-67.42	-10.51	-77.93	-13.00	-64.93	peak	
4		552.830	-67.56	-5.52	-73.08	-13.00	-60.08	peak	
5		799.210	-68.52	-1.08	-69.60	-13.00	-56.60	peak	
6	*	940.830	-66.21	1.04	-65.17	-13.00	-52.17	peak	

Test Mode: PCS1900_TX CH661_EDGE_with Accessory Devices_Main Antenna

Horizontal

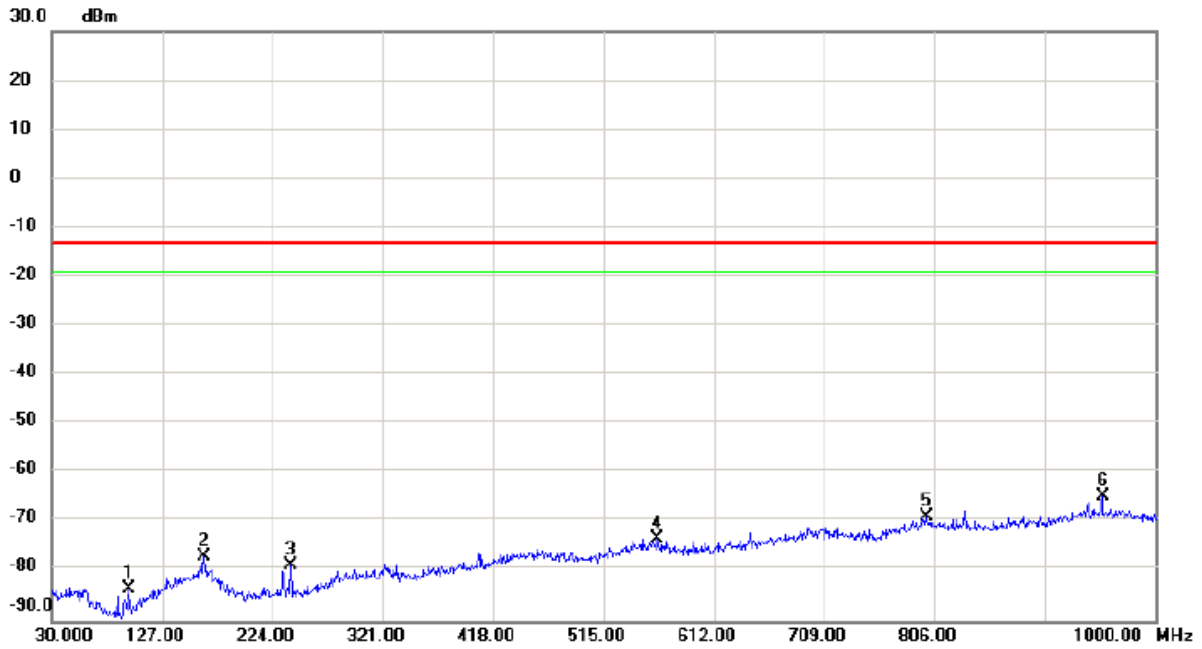

No.	Mk.	Freq. MHz	Reading Level dBm	Correct Factor dB	Measure- ment dBm	Limit dBm	Margin dB	Detector	Comment
1		97.900	-65.08	-18.58	-83.66	-13.00	-70.66	peak	
2		163.860	-66.02	-10.83	-76.85	-13.00	-63.85	peak	
3		240.490	-64.11	-14.66	-78.77	-13.00	-65.77	peak	
4		562.530	-67.53	-5.68	-73.21	-13.00	-60.21	peak	
5		798.240	-67.82	-1.15	-68.97	-13.00	-55.97	peak	
6	*	953.440	-66.05	1.33	-64.72	-13.00	-51.72	peak	

Test Mode: PCS1900_TX CH661_GSM_without Accessory Devices_Main Antenna

Vertical

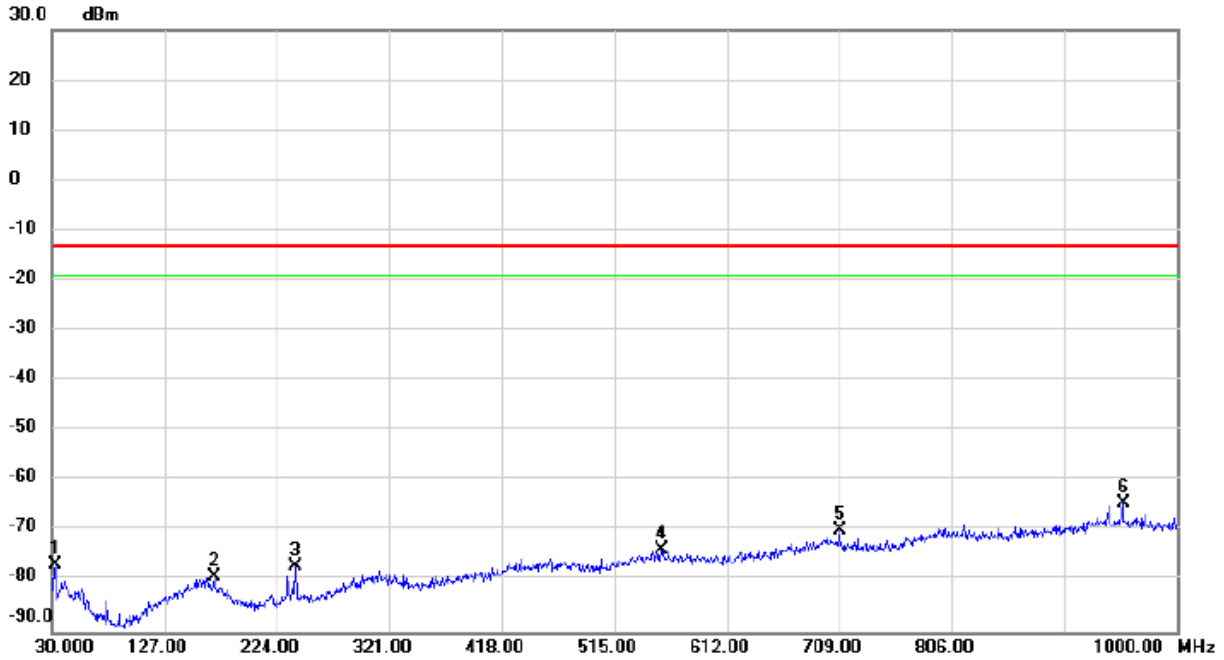

No.	Mk.	Freq. MHz	Reading Level dBm	Correct Factor dB	Measure- ment dBm	Limit dBm	Margin dB	Detector	Comment
1		32.910	-61.78	-14.94	-76.72	-13.00	-63.72	peak	
2		169.680	-67.84	-11.18	-79.02	-13.00	-66.02	peak	
3		240.490	-62.33	-14.66	-76.99	-13.00	-63.99	peak	
4		555.740	-68.23	-5.56	-73.79	-13.00	-60.79	peak	
5		709.000	-66.84	-2.98	-69.82	-13.00	-56.82	peak	
6 *		953.440	-65.65	1.33	-64.32	-13.00	-51.32	peak	

Test Mode: PCS1900_TX CH661_GSM_without Accessory Devices_Main Antenna

Horizontal

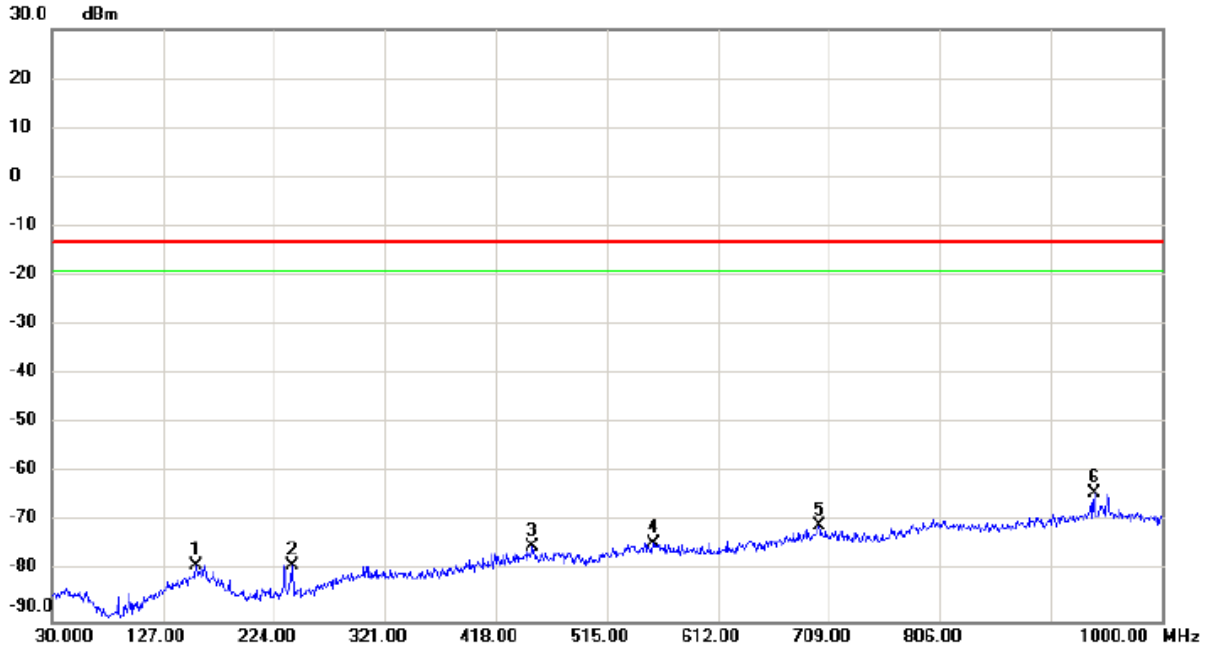

No.	Mk.	Freq. MHz	Reading Level dBm	Correct Factor dB	Measure- ment dBm	Limit dBm	Margin dB	Detector	Comment
1		156.100	-67.72	-10.94	-78.66	-13.00	-65.66	peak	
2		240.490	-64.06	-14.66	-78.72	-13.00	-65.72	peak	
3		450.010	-67.55	-7.40	-74.95	-13.00	-61.95	peak	
4		555.740	-68.55	-5.56	-74.11	-13.00	-61.11	peak	
5		700.270	-67.97	-2.75	-70.72	-13.00	-57.72	peak	
6	*	940.830	-65.10	1.04	-64.06	-13.00	-51.06	peak	

Test Mode: PCS1900_TX CH661_EDGE_without Accessory Devices_Main Antenna

Vertical

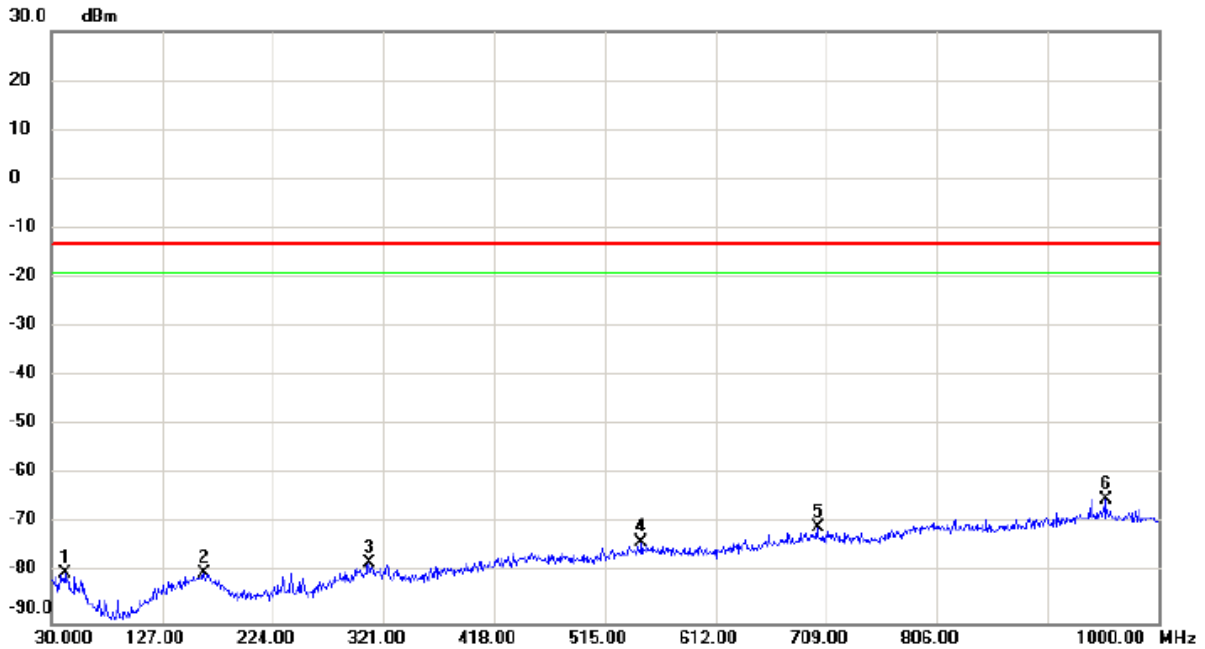

No.	Mk.	Freq. MHz	Reading Level dBm	Correct Factor dB	Measure- ment dBm	Limit dBm	Margin dB	Detector	Comment
1		41.640	-65.21	-14.69	-79.90	-13.00	-66.90	peak	
2		163.860	-69.09	-10.83	-79.92	-13.00	-66.92	peak	
3		308.390	-67.35	-10.49	-77.84	-13.00	-64.84	peak	
4		547.010	-68.04	-5.65	-73.69	-13.00	-60.69	peak	
5		701.240	-67.96	-2.78	-70.74	-13.00	-57.74	peak	
6	*	953.440	-66.16	1.33	-64.83	-13.00	-51.83	peak	

Test Mode: PCS1900_TX CH661_EDGE_without Accessory Devices_Main Antenna

Horizontal

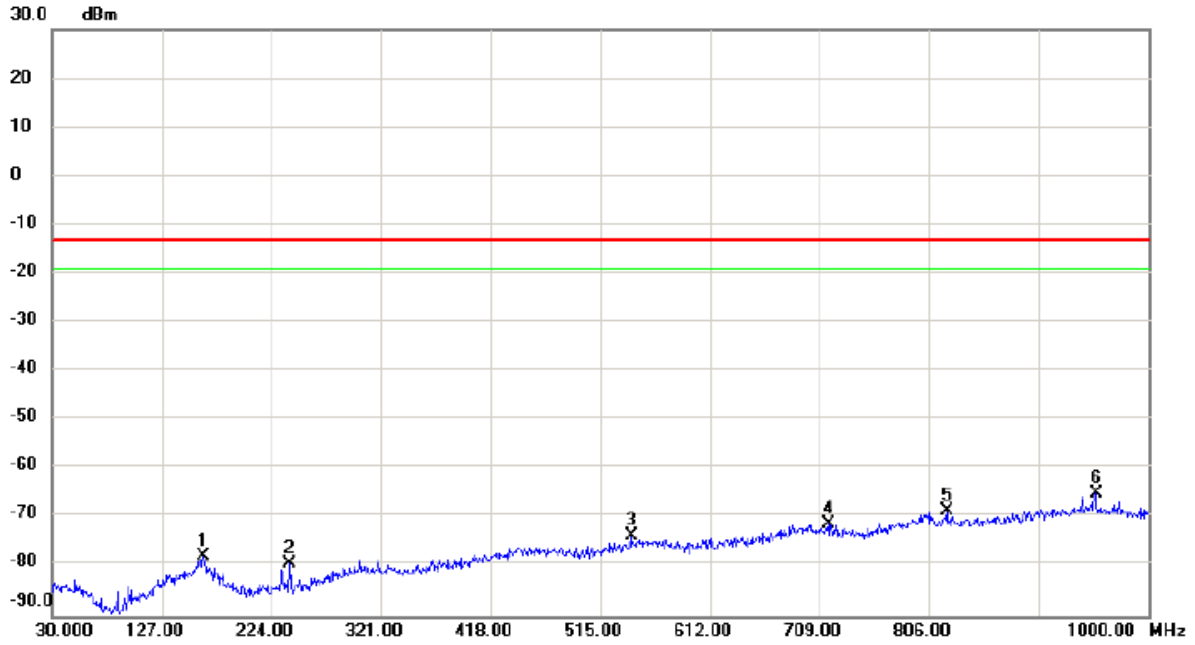

No.	Mk.	Freq. MHz	Reading Level dBm	Correct Factor dB	Measure- ment dBm	Limit dBm	Margin dB	Detector	Comment
1		163.860	-67.08	-10.83	-77.91	-13.00	-64.91	peak	
2		240.490	-64.80	-14.66	-79.46	-13.00	-66.46	peak	
3		542.160	-67.75	-5.94	-73.69	-13.00	-60.69	peak	
4		716.760	-67.93	-3.18	-71.11	-13.00	-58.11	peak	
5		821.520	-67.09	-1.38	-68.47	-13.00	-55.47	peak	
6	*	953.440	-66.17	1.33	-64.84	-13.00	-51.84	peak	

Test Mode: WCDMA Band II_TX CH9400_Main Antenna

Vertical

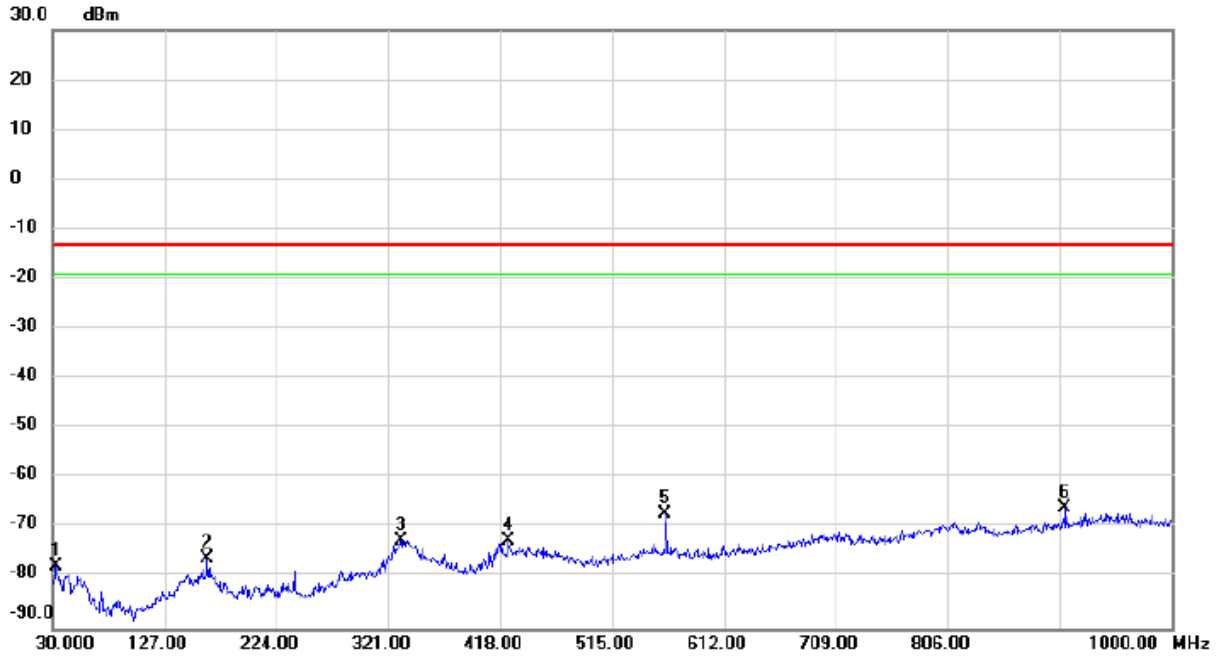

No.	Mk.	Freq. MHz	Reading Level dBm	Correct Factor dB	Measure- ment dBm	Limit dBm	Margin dB	Detector	Comment
1		33.395	-62.56	-14.88	-77.44	-13.00	-64.44	peak	
2		163.860	-65.27	-10.83	-76.10	-13.00	-63.10	peak	
3		332.155	-61.52	-10.83	-72.35	-13.00	-59.35	peak	
4		425.275	-64.10	-8.39	-72.49	-13.00	-59.49	peak	
5		561.560	-61.30	-5.65	-66.95	-13.00	-53.95	peak	
6	*	907.850	-65.53	-0.28	-65.81	-13.00	-52.81	peak	

Test Mode: WCDMA Band II_TX CH9400_Main Antenna

Horizontal

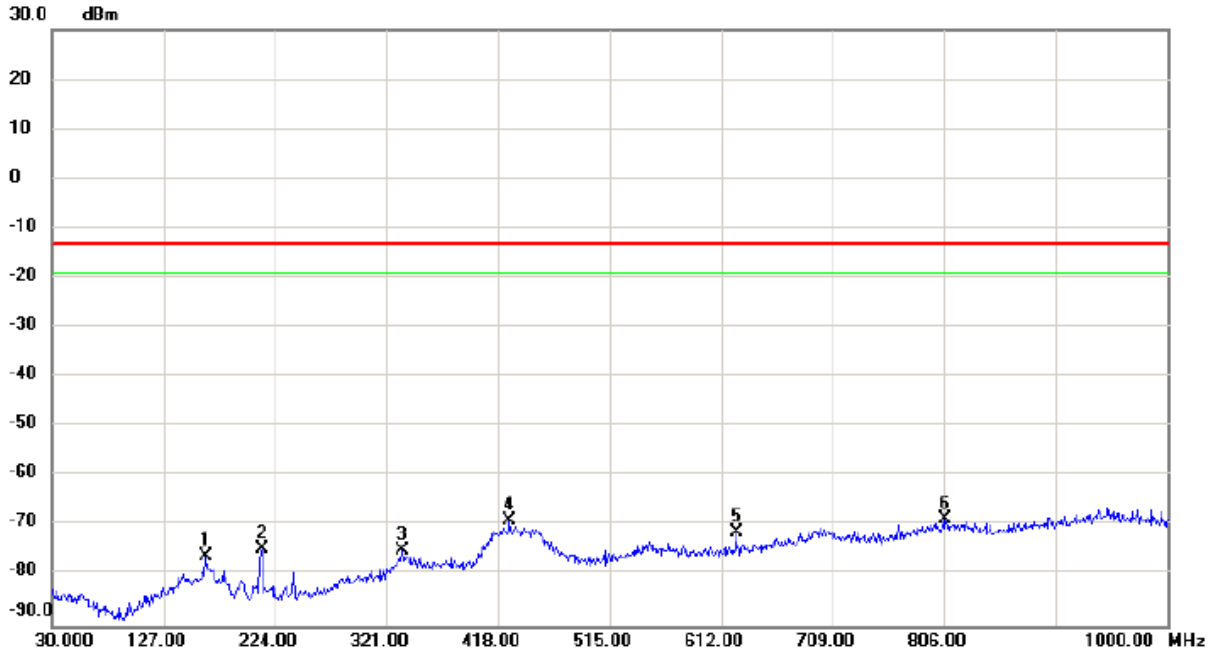

No.	Mk.	Freq. MHz	Reading Level dBm	Correct Factor dB	Measure- ment dBm	Limit dBm	Margin dB	Detector	Comment
1		164.345	-65.14	-10.86	-76.00	-13.00	-63.00	peak	
2		212.845	-59.41	-15.11	-74.52	-13.00	-61.52	peak	
3		334.580	-64.09	-10.85	-74.94	-13.00	-61.94	peak	
4		428.185	-60.56	-8.26	-68.82	-13.00	-55.82	peak	
5		625.095	-65.56	-5.73	-71.29	-13.00	-58.29	peak	
6	*	806.970	-67.52	-1.14	-68.66	-13.00	-55.66	peak	

Test Mode: LTE Band 2_TX CH18900_1.4M_Main Antenna

Vertical

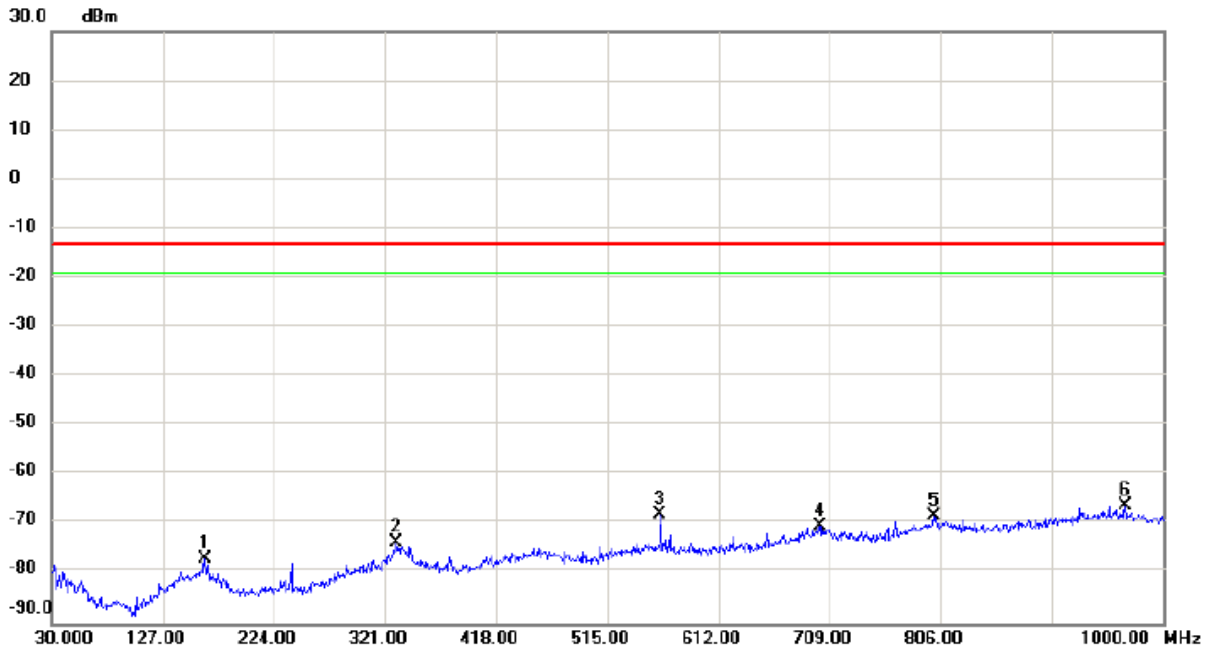

No.	Mk.	Freq. MHz	Reading Level dBm	Correct Factor dB	Measure- ment dBm	Limit dBm	Margin dB	Detector	Comment
1		163.860	-66.07	-10.83	-76.90	-13.00	-63.90	peak	
2		331.185	-62.94	-10.81	-73.75	-13.00	-60.75	peak	
3		561.560	-62.33	-5.65	-67.98	-13.00	-54.98	peak	
4		700.270	-67.69	-2.75	-70.44	-13.00	-57.44	peak	
5		799.695	-67.14	-1.06	-68.20	-13.00	-55.20	peak	
6	*	967.505	-67.00	0.99	-66.01	-13.00	-53.01	peak	

Test Mode: LTE Band 2_TX CH18900_1.4M_Main Antenna

Horizontal

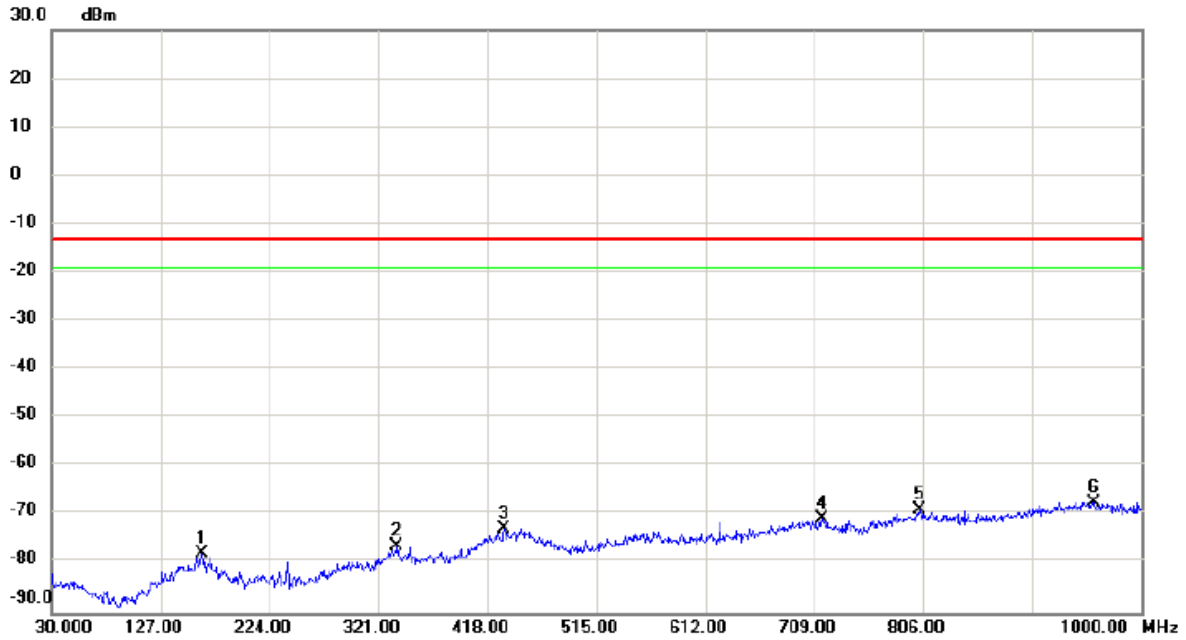

No.	Mk.	Freq. MHz	Reading Level dBm	Correct Factor dB	Measure- ment dBm	Limit dBm	Margin dB	Detector	Comment
1		163.860	-66.90	-10.83	-77.73	-13.00	-64.73	peak	
2		337.490	-65.48	-10.89	-76.37	-13.00	-63.37	peak	
3		433.035	-64.65	-8.08	-72.73	-13.00	-59.73	peak	
4		716.275	-67.48	-3.17	-70.65	-13.00	-57.65	peak	
5		802.120	-67.83	-1.07	-68.90	-13.00	-55.90	peak	
6	*	957.805	-68.52	1.22	-67.30	-13.00	-54.30	peak	

Test Mode: LTE Band 2_TX CH18900_5M_Main Antenna

Vertical

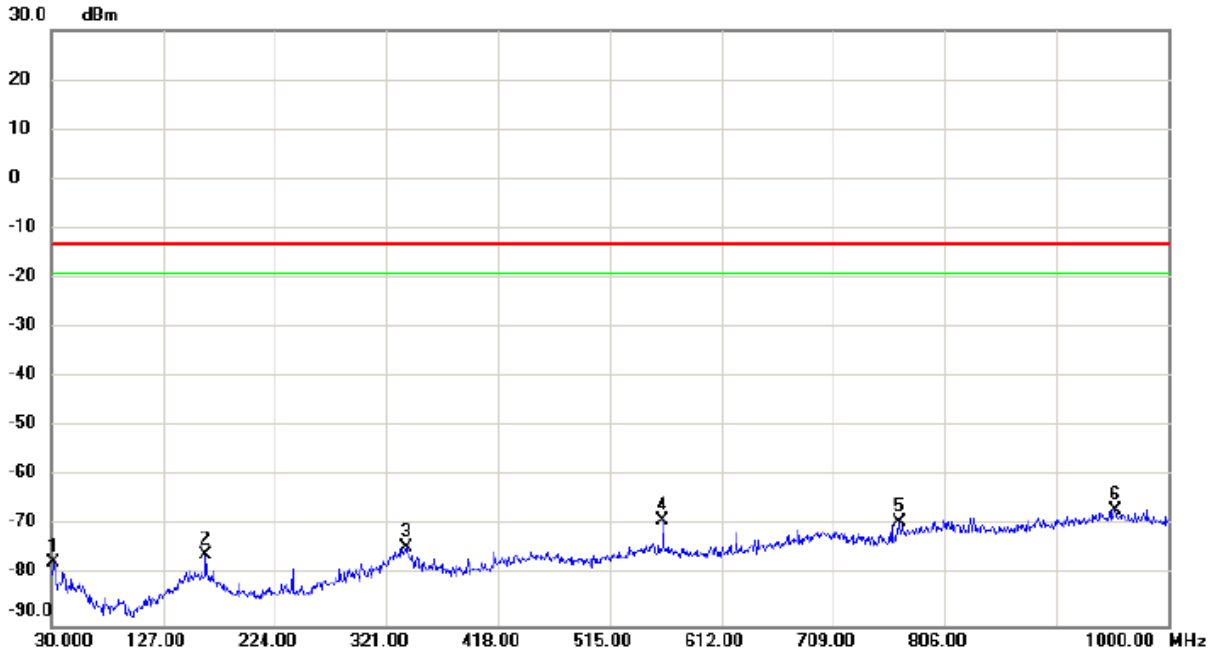

No.	Mk.	Freq. MHz	Reading Level dBm	Correct Factor dB	Measure- ment dBm	Limit dBm	Margin dB	Detector	Comment
1		32.425	-62.28	-15.00	-77.28	-13.00	-64.28	peak	
2		163.860	-64.99	-10.83	-75.82	-13.00	-62.82	peak	
3		337.975	-63.32	-10.91	-74.23	-13.00	-61.23	peak	
4		561.560	-63.25	-5.65	-68.90	-13.00	-55.90	peak	
5		766.715	-66.05	-3.03	-69.08	-13.00	-56.08	peak	
6	*	953.925	-68.02	1.31	-66.71	-13.00	-53.71	peak	

Test Mode: LTE Band 2_TX CH18900_5M_Main Antenna

Horizontal

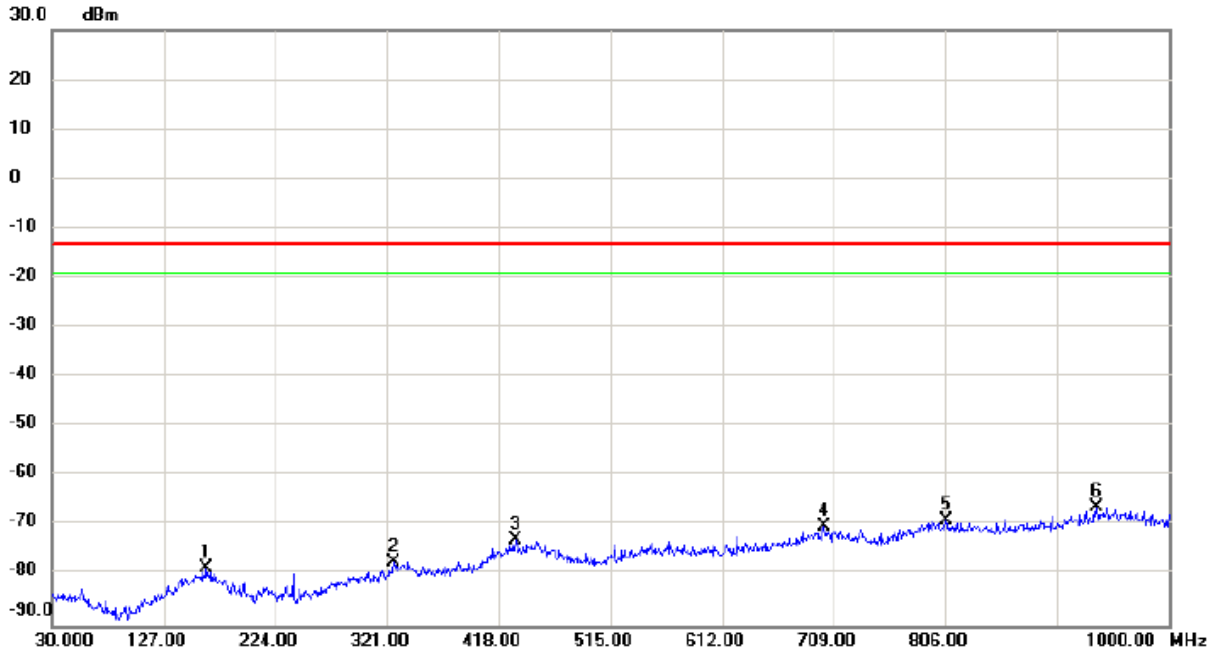

No.	Mk.	Freq. MHz	Reading Level dBm	Correct Factor dB	Measure- ment dBm	Limit dBm	Margin dB	Detector	Comment
1		164.345	-67.57	-10.86	-78.43	-13.00	-65.43	peak	
2		327.305	-66.56	-10.75	-77.31	-13.00	-64.31	peak	
3		433.035	-64.69	-8.08	-72.77	-13.00	-59.77	peak	
4		700.270	-67.20	-2.75	-69.95	-13.00	-56.95	peak	
5		806.000	-67.74	-1.14	-68.88	-13.00	-55.88	peak	
6	*	937.435	-66.97	0.90	-66.07	-13.00	-53.07	peak	

Test Mode: LTE Band 2_TX CH18900_20M_Main Antenna

Vertical

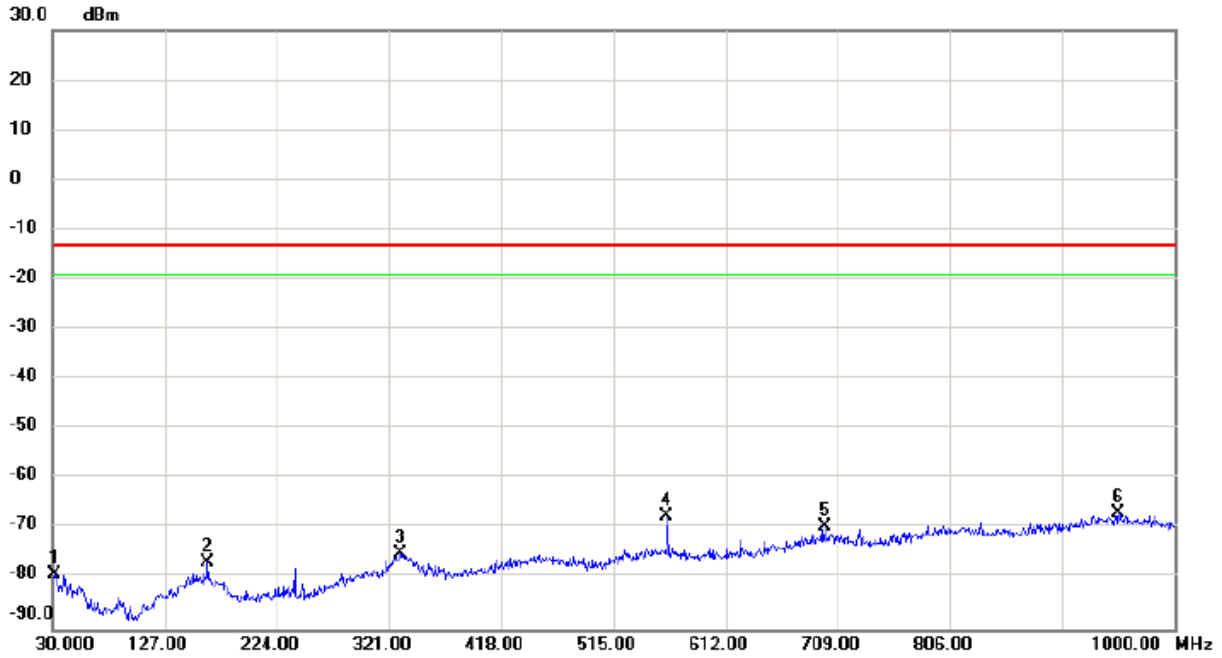

No.	Mk.	Freq. MHz	Reading Level dBm	Correct Factor dB	Measure- ment dBm	Limit dBm	Margin dB	Detector	Comment
1		32.425	-64.09	-15.00	-79.09	-13.00	-66.09	peak	
2		163.860	-65.89	-10.83	-76.72	-13.00	-63.72	peak	
3		331.185	-63.94	-10.81	-74.75	-13.00	-61.75	peak	
4		561.560	-61.82	-5.65	-67.47	-13.00	-54.47	peak	
5		697.360	-66.57	-2.88	-69.45	-13.00	-56.45	peak	
6	*	951.500	-68.21	1.37	-66.84	-13.00	-53.84	peak	

Test Mode: LTE Band 2_TX CH18900_20M_Main Antenna

Horizontal

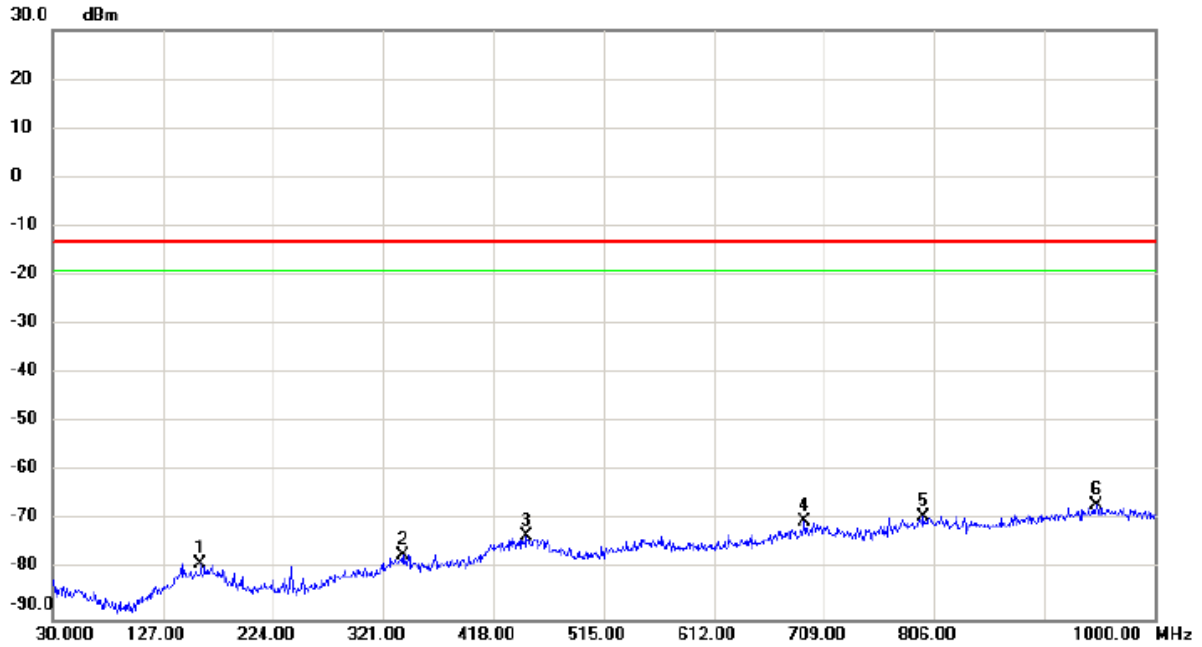

No.	Mk.	Freq. MHz	Reading Level dBm	Correct Factor dB	Measure- ment dBm	Limit dBm	Margin dB	Detector	Comment
1		159.980	-68.03	-10.60	-78.63	-13.00	-65.63	peak	
2		338.945	-65.97	-10.92	-76.89	-13.00	-63.89	peak	
3		447.100	-65.42	-7.53	-72.95	-13.00	-59.95	peak	
4		692.025	-66.89	-3.13	-70.02	-13.00	-57.02	peak	
5		795.815	-67.87	-1.29	-69.16	-13.00	-56.16	peak	
6	*	949.075	-68.17	1.37	-66.80	-13.00	-53.80	peak	

Test Mode: PCS1900_TX CH661_GSM_with Accessory Devices_Second Antenna

Vertical

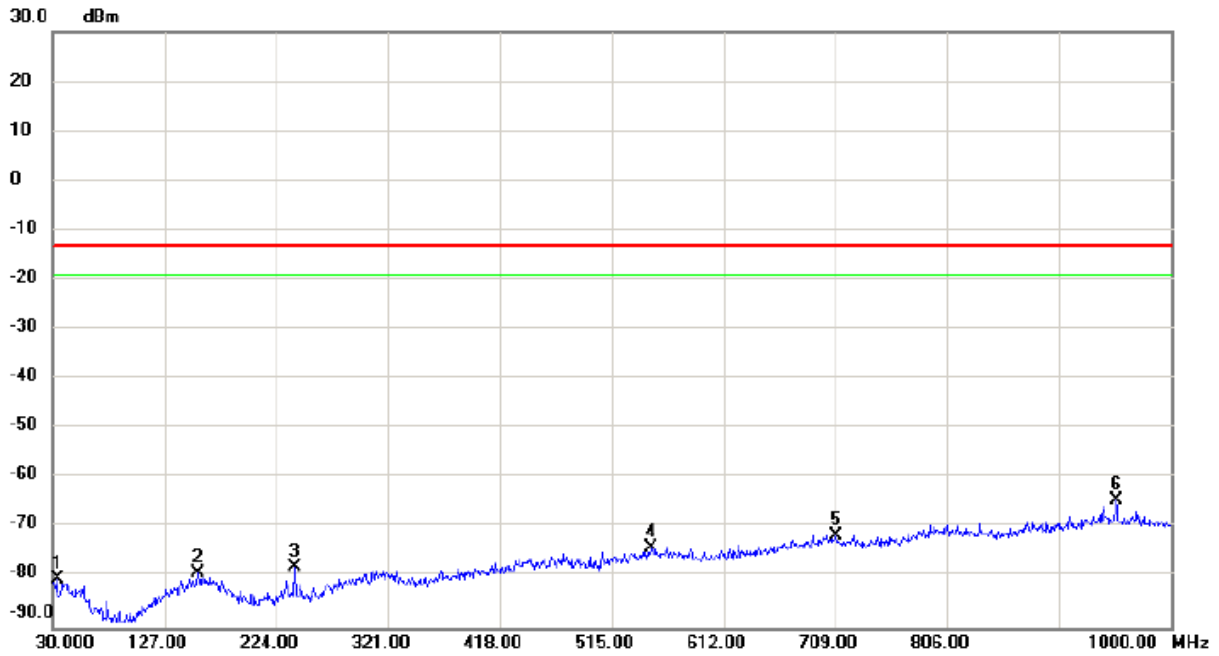

No.	Mk.	Freq. MHz	Reading Level dBm	Correct Factor dB	Measure- ment dBm	Limit dBm	Margin dB	Detector	Comment
1		33.880	-65.44	-14.82	-80.26	-13.00	-67.26	peak	
2		156.100	-68.00	-10.94	-78.94	-13.00	-65.94	peak	
3		239.520	-63.26	-14.69	-77.95	-13.00	-64.95	peak	
4		549.920	-68.36	-5.46	-73.82	-13.00	-60.82	peak	
5		709.000	-68.52	-2.98	-71.50	-13.00	-58.50	peak	
6	*	952.470	-65.81	1.35	-64.46	-13.00	-51.46	peak	

Test Mode: PCS1900_TX CH661_GSM_with Accessory Devices_Second Antenna

Horizontal

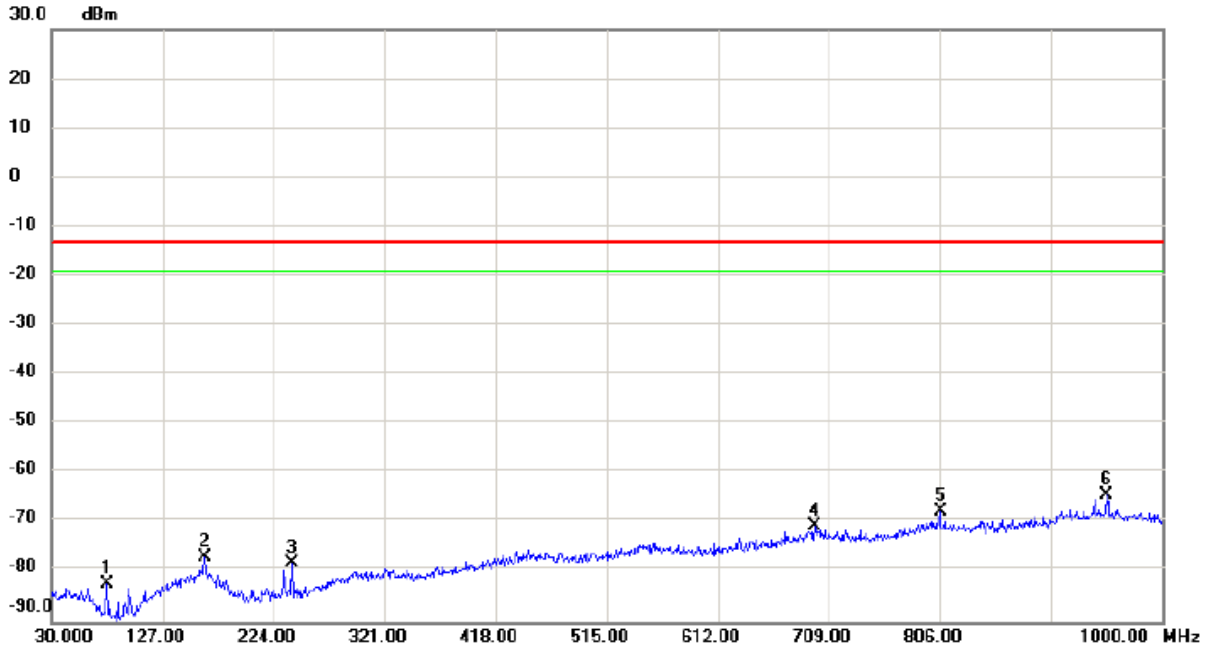

No.	Mk.	Freq. MHz	Reading Level dBm	Correct Factor dB	Measure- ment dBm	Limit dBm	Margin dB	Detector	Comment
1		78.500	-63.77	-18.52	-82.29	-13.00	-69.29	peak	
2		163.860	-66.05	-10.83	-76.88	-13.00	-63.88	peak	
3		239.520	-63.50	-14.69	-78.19	-13.00	-65.19	peak	
4		696.390	-67.80	-2.93	-70.73	-13.00	-57.73	peak	
5		806.000	-66.64	-1.14	-67.78	-13.00	-54.78	peak	
6	*	951.500	-65.73	1.37	-64.36	-13.00	-51.36	peak	

Test Mode: PCS1900_TX CH661_EDGE_with Accessory Devices_Second Antenna

Vertical

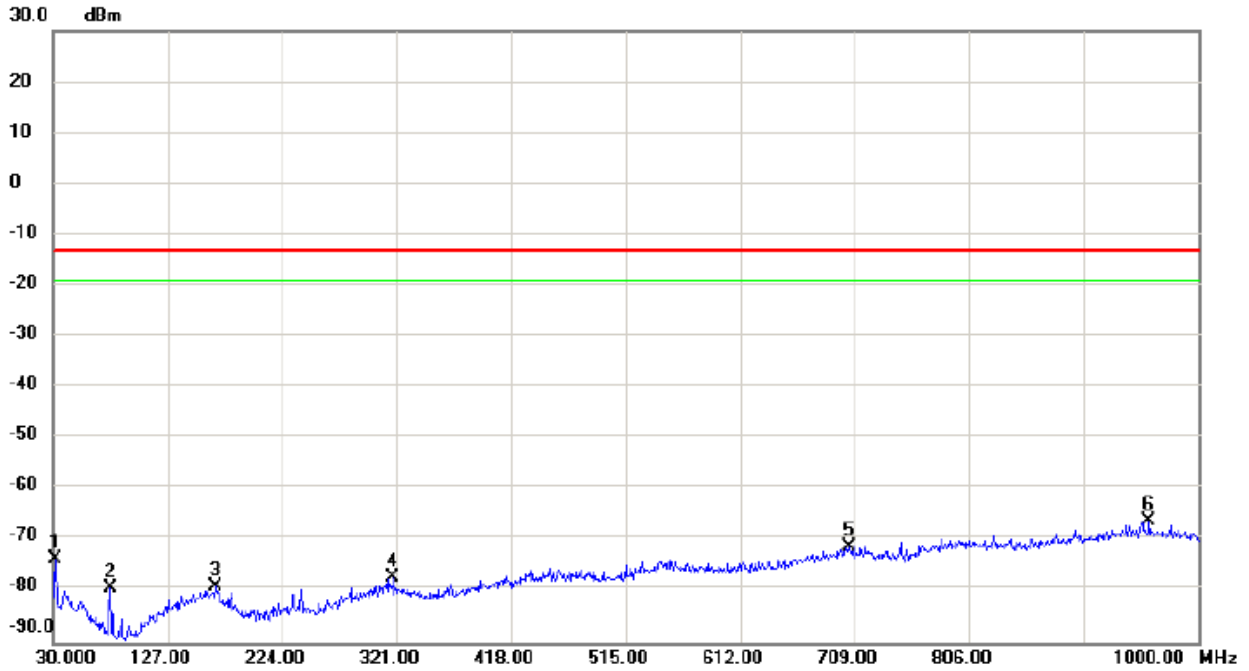

No.	Mk.	Freq. MHz	Reading Level dBm	Correct Factor dB	Measure- ment dBm	Limit dBm	Margin dB	Detector	Comment
1		31.940	-58.70	-15.05	-73.75	-13.00	-60.75	peak	
2		78.500	-60.73	-18.52	-79.25	-13.00	-66.25	peak	
3		167.740	-67.86	-11.07	-78.93	-13.00	-65.93	peak	
4		318.090	-66.74	-10.62	-77.36	-13.00	-64.36	peak	
5		704.150	-68.36	-2.84	-71.20	-13.00	-58.20	peak	
6	*	958.290	-67.50	1.22	-66.28	-13.00	-53.28	peak	

Test Mode: PCS1900_TX CH661_EDGE_with Accessory Devices_Second Antenna

Horizontal

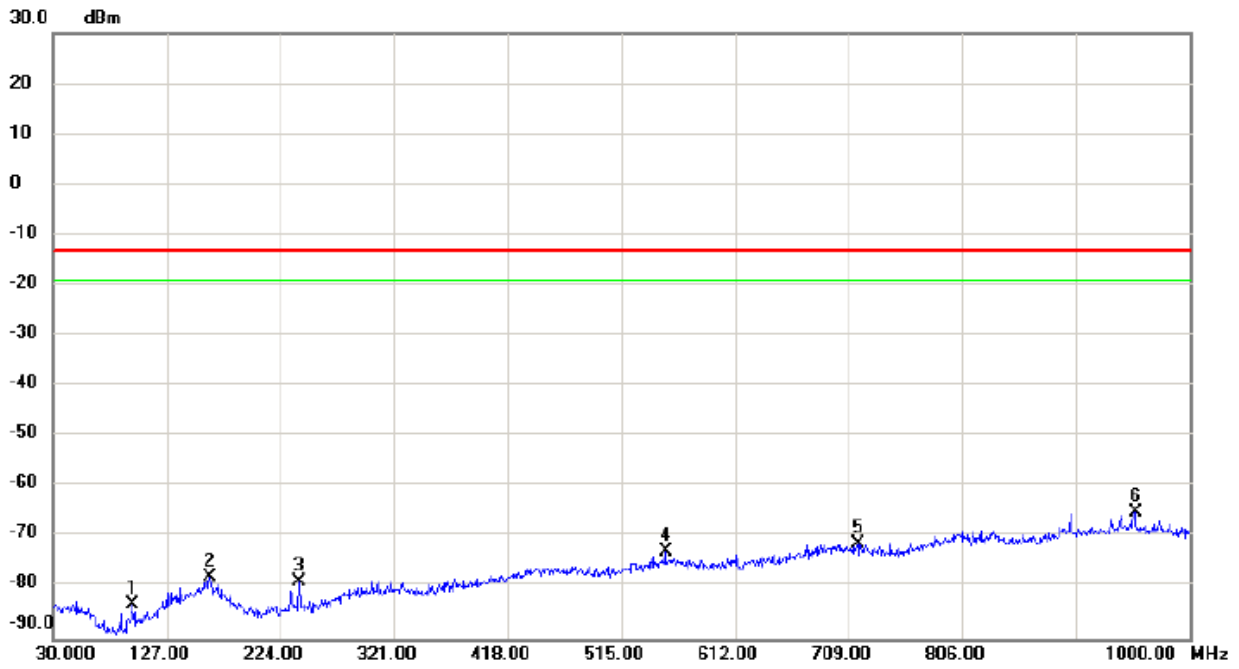

No.	Mk.	Freq. MHz	Reading Level dBm	Correct Factor dB	Measure- ment dBm	Limit dBm	Margin dB	Detector	Comment
1		97.900	-64.57	-18.58	-83.15	-13.00	-70.15	peak	
2		163.860	-67.08	-10.83	-77.91	-13.00	-64.91	peak	
3		240.490	-64.16	-14.66	-78.82	-13.00	-65.82	peak	
4		552.830	-67.30	-5.52	-72.82	-13.00	-59.82	peak	
5		716.760	-67.93	-3.18	-71.11	-13.00	-58.11	peak	
6 *		953.440	-66.17	1.33	-64.84	-13.00	-51.84	peak	

Test Mode: PCS1900_TX CH661_GSM_without Accessory Devices_Second Antenna

Vertical

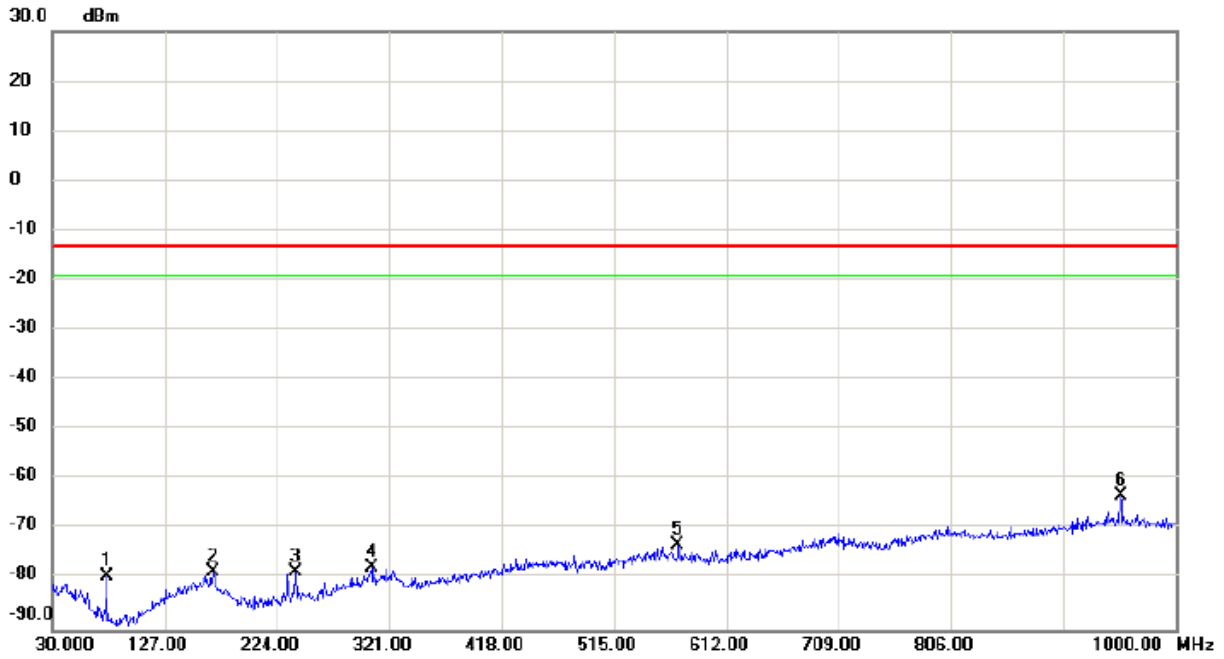

No.	Mk.	Freq. MHz	Reading Level dBm	Correct Factor dB	Measure- ment dBm	Limit dBm	Margin dB	Detector	Comment
1		76.560	-60.77	-18.47	-79.24	-13.00	-66.24	peak	
2		168.710	-67.41	-11.12	-78.53	-13.00	-65.53	peak	
3		240.490	-63.68	-14.66	-78.34	-13.00	-65.34	peak	
4		305.480	-67.03	-10.45	-77.48	-13.00	-64.48	peak	
5		570.290	-67.22	-5.79	-73.01	-13.00	-60.01	peak	
6	*	952.470	-64.50	1.35	-63.15	-13.00	-50.15	peak	

Test Mode: PCS1900_TX CH661_GSM_without Accessory Devices_Second Antenna

Horizontal

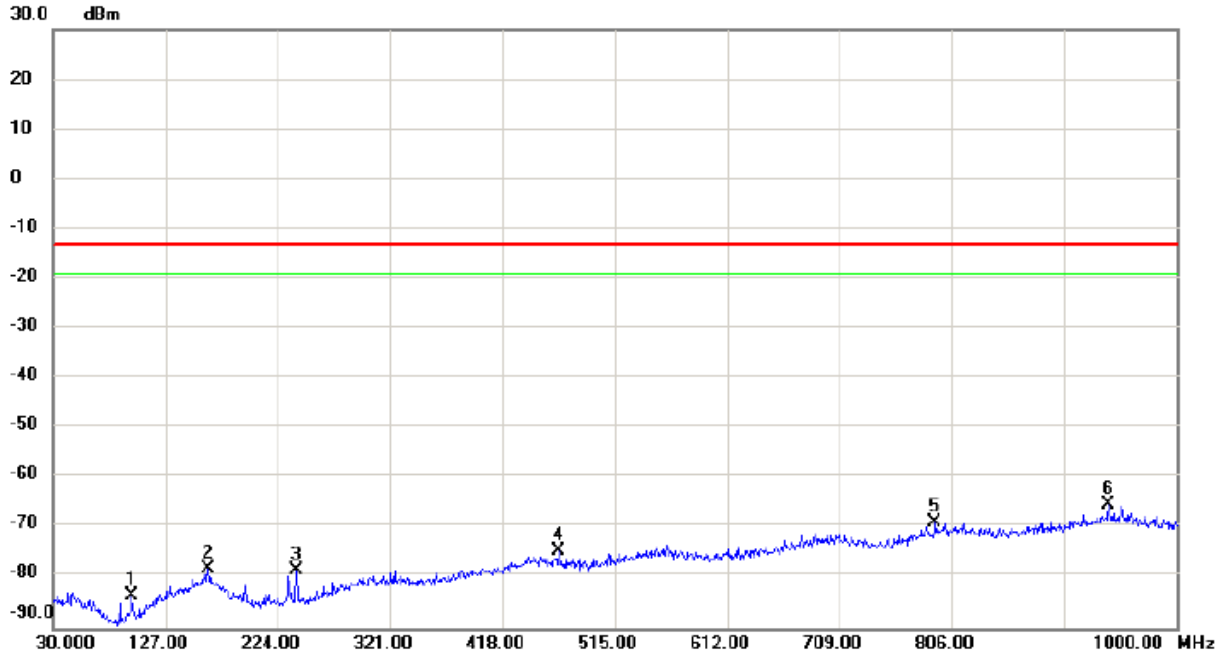

No.	Mk.	Freq. MHz	Reading Level dBm	Correct Factor dB	Measure- ment dBm	Limit dBm	Margin dB	Detector	Comment
1		97.900	-65.05	-18.58	-83.63	-13.00	-70.63	peak	
2		163.860	-67.44	-10.83	-78.27	-13.00	-65.27	peak	
3		240.490	-63.78	-14.66	-78.44	-13.00	-65.44	peak	
4		466.500	-66.76	-7.77	-74.53	-13.00	-61.53	peak	
5		791.450	-67.25	-1.55	-68.80	-13.00	-55.80	peak	
6 *		940.830	-66.43	1.04	-65.39	-13.00	-52.39	peak	

Test Mode: PCS1900_TX CH661_EDGE_without Accessory Devices_Second Antenna

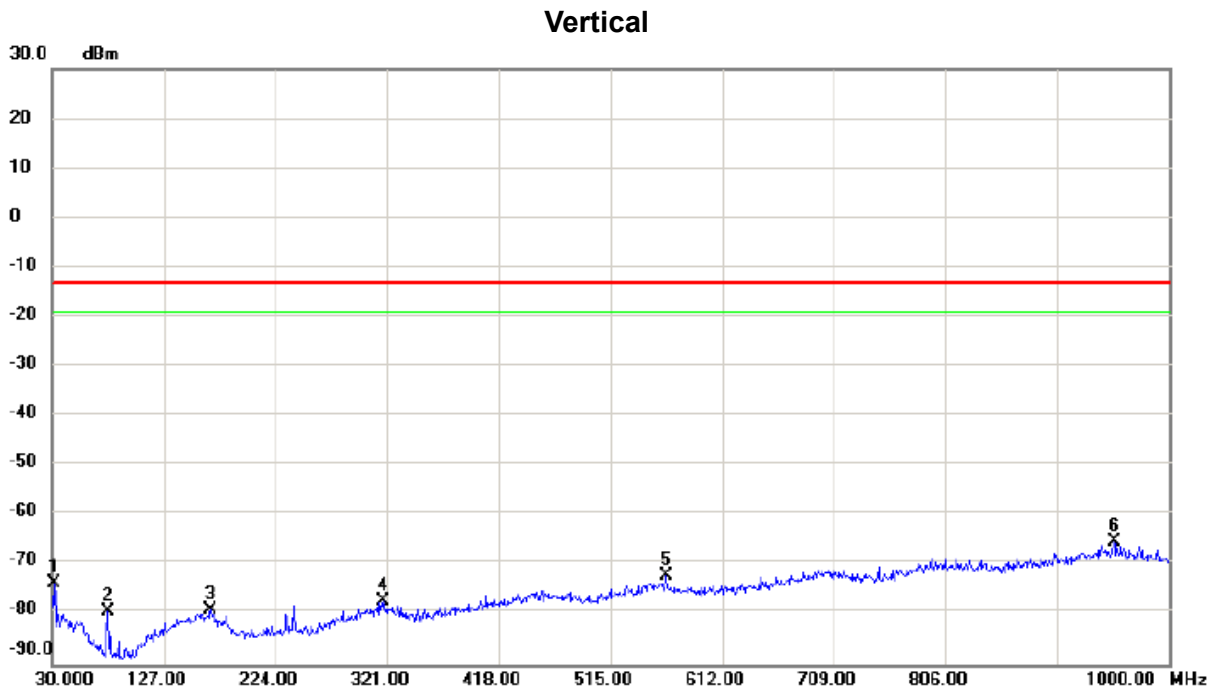

No.	Mk.	Freq. MHz	Reading Level dBm	Correct Factor dB	Measure- ment dBm	Limit dBm	Margin dB	Detector	Comment
1		31.940	-58.70	-15.05	-73.75	-13.00	-60.75	peak	
2		78.500	-60.73	-18.52	-79.25	-13.00	-66.25	peak	
3		167.740	-67.86	-11.07	-78.93	-13.00	-65.93	peak	
4		318.090	-66.74	-10.62	-77.36	-13.00	-64.36	peak	
5		563.500	-66.48	-5.69	-72.17	-13.00	-59.17	peak	
6 *		952.470	-66.67	1.35	-65.32	-13.00	-52.32	peak	

Test Mode: PCS1900_TX CH661_EDGE_without Accessory Devices_Second Antenna

Horizontal

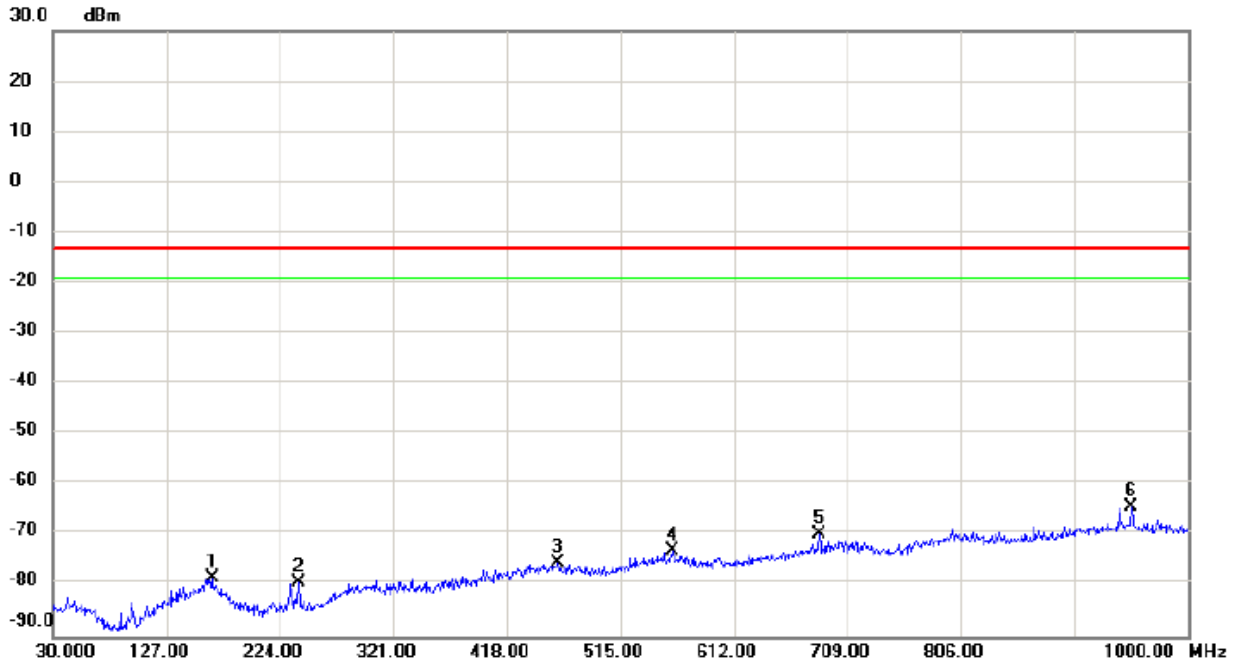

No.	Mk.	Freq. MHz	Reading Level dBm	Correct Factor dB	Measure- ment dBm	Limit dBm	Margin dB	Detector	Comment
1		165.800	-67.51	-10.95	-78.46	-13.00	-65.46	peak	
2		240.490	-64.58	-14.66	-79.24	-13.00	-66.24	peak	
3		461.650	-67.64	-7.67	-75.31	-13.00	-62.31	peak	
4		559.620	-67.44	-5.62	-73.06	-13.00	-60.06	peak	
5		684.750	-66.30	-3.48	-69.78	-13.00	-56.78	peak	
6 *		951.500	-65.58	1.37	-64.21	-13.00	-51.21	peak	

Test Mode: WCDMA Band II_TX CH9400_Second Antenna

Vertical

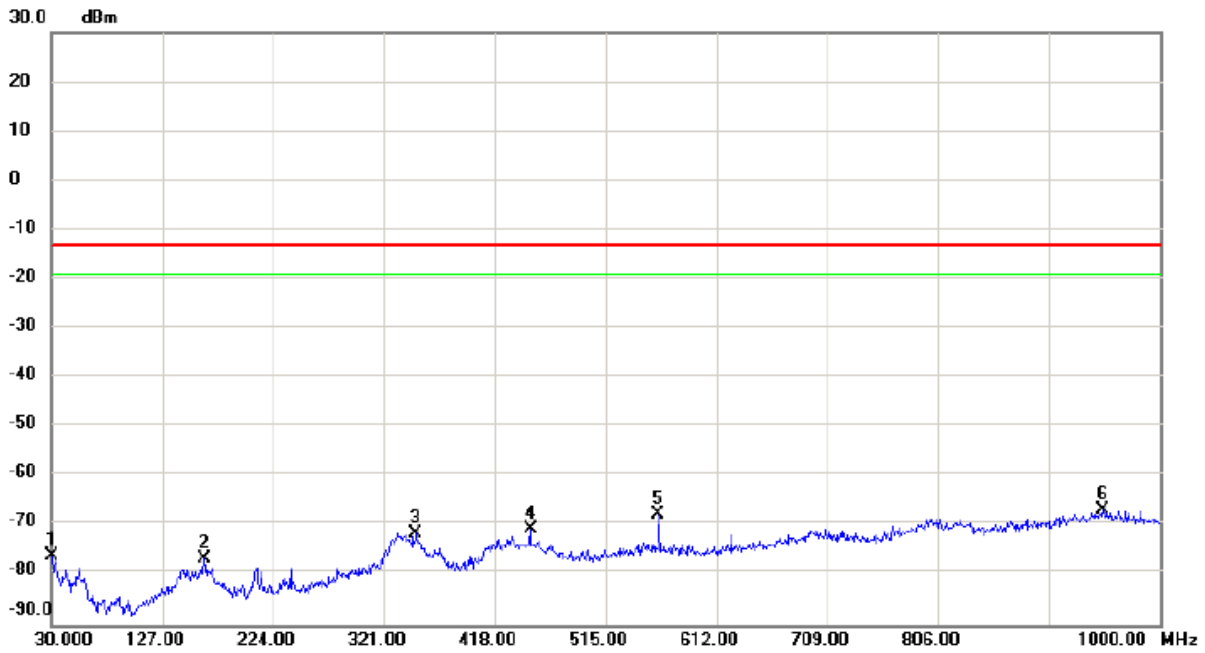

No.	Mk.	Freq. MHz	Reading Level dBm	Correct Factor dB	Measure- ment dBm	Limit dBm	Margin dB	Detector	Comment
1		30.000	-61.07	-14.97	-76.04	-13.00	-63.04	peak	
2		163.860	-65.84	-10.83	-76.67	-13.00	-63.67	peak	
3		349.130	-60.43	-11.06	-71.49	-13.00	-58.49	peak	
4		449.525	-63.09	-7.43	-70.52	-13.00	-57.52	peak	
5		561.560	-62.07	-5.65	-67.72	-13.00	-54.72	peak	
6	*	950.045	-68.28	1.42	-66.86	-13.00	-53.86	peak	

Test Mode: WCDMA Band II_TX CH9400_Second Antenna

Horizontal

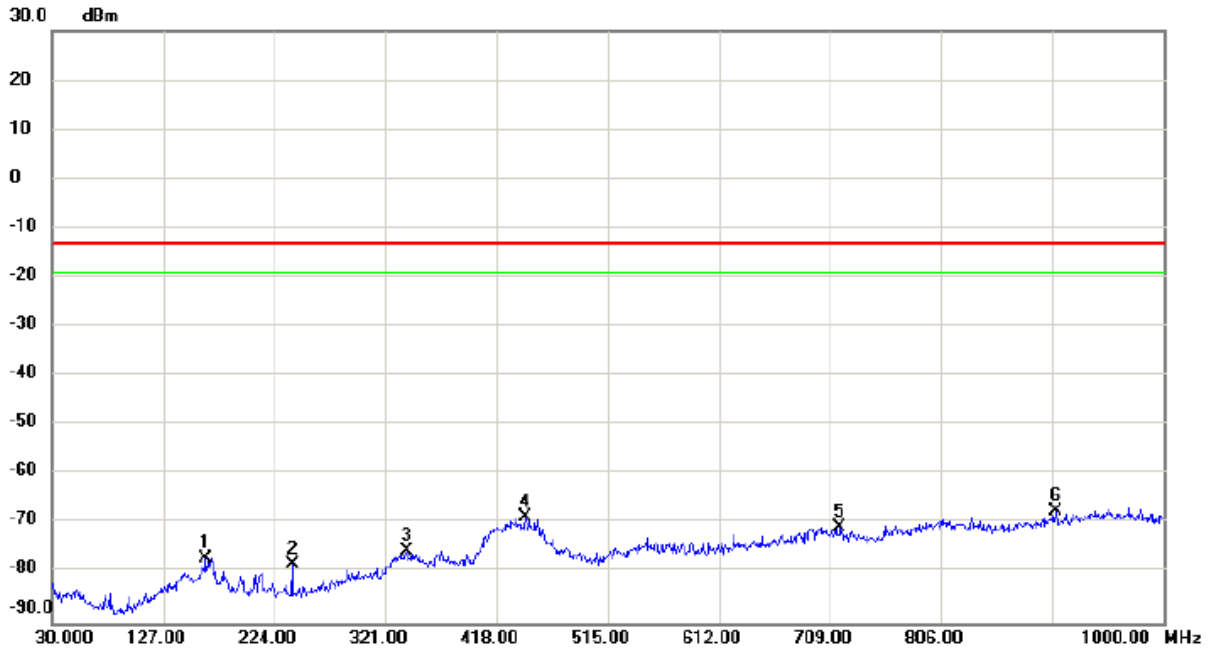

No.	Mk.	Freq. MHz	Reading Level dBm	Correct Factor dB	Measure- ment dBm	Limit dBm	Margin dB	Detector	Comment
1		163.860	-66.06	-10.83	-76.89	-13.00	-63.89	peak	
2		240.005	-63.51	-14.67	-78.18	-13.00	-65.18	peak	
3		339.915	-64.40	-10.94	-75.34	-13.00	-62.34	peak	
4		443.705	-61.00	-7.65	-68.65	-13.00	-55.65	peak	
5		717.730	-67.45	-3.20	-70.65	-13.00	-57.65	peak	
6	*	906.395	-66.95	-0.34	-67.29	-13.00	-54.29	peak	

Test Mode: LTE Band 2_TX CH18900_1.4M_Second Antenna

Vertical

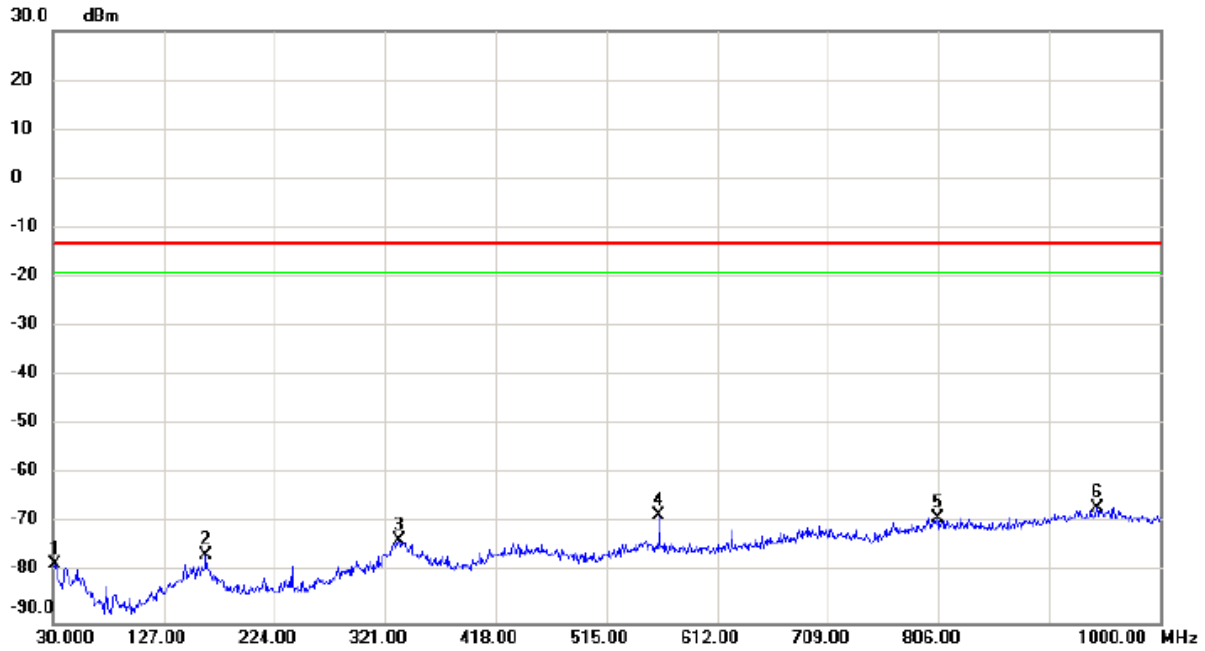

No.	Mk.	Freq. MHz	Reading Level dBm	Correct Factor dB	Measure- ment dBm	Limit dBm	Margin dB	Detector	Comment
1		32.425	-63.15	-15.00	-78.15	-13.00	-65.15	peak	
2		163.860	-65.50	-10.83	-76.33	-13.00	-63.33	peak	
3		333.125	-62.43	-10.83	-73.26	-13.00	-60.26	peak	
4		561.560	-62.64	-5.65	-68.29	-13.00	-55.29	peak	
5		805.030	-67.62	-1.12	-68.74	-13.00	-55.74	peak	
6	*	944.710	-67.93	1.20	-66.73	-13.00	-53.73	peak	

Test Mode: LTE Band 2_TX CH18900_1.4M_Second Antenna

Horizontal

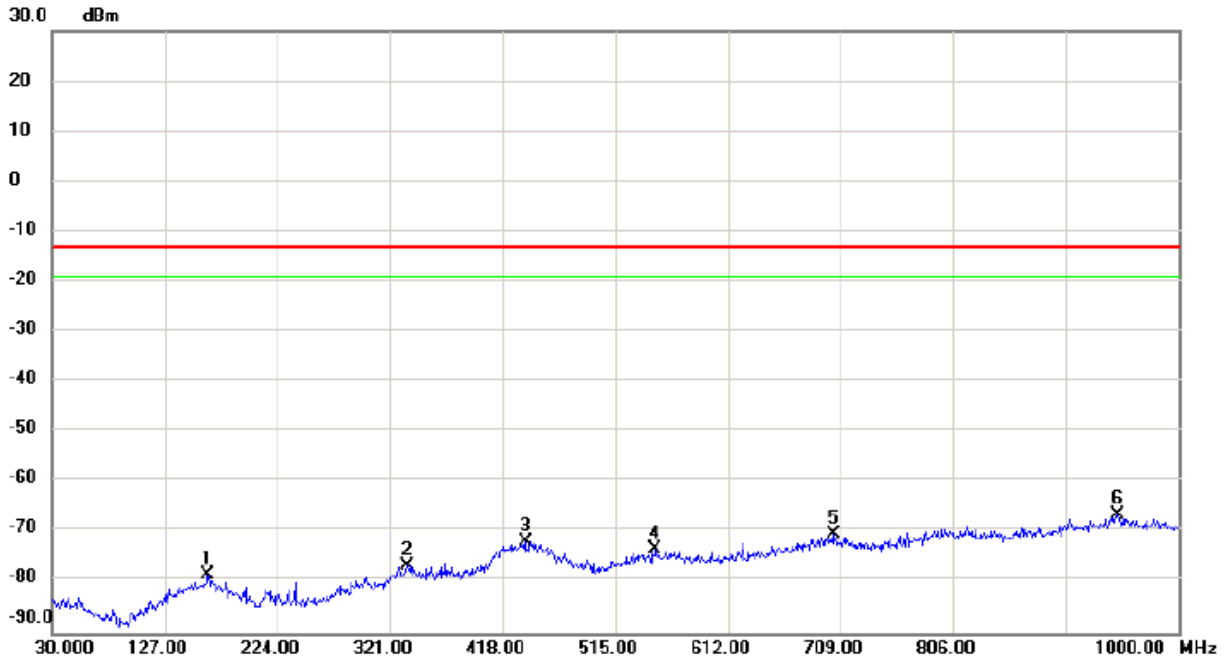

No.	Mk.	Freq. MHz	Reading Level dBm	Correct Factor dB	Measure- ment dBm	Limit dBm	Margin dB	Detector	Comment
1		163.860	-67.52	-10.83	-78.35	-13.00	-65.35	peak	
2		336.035	-65.65	-10.88	-76.53	-13.00	-63.53	peak	
3		437.400	-63.80	-7.90	-71.70	-13.00	-58.70	peak	
4		549.920	-68.01	-5.46	-73.47	-13.00	-60.47	peak	
5		702.695	-67.48	-2.81	-70.29	-13.00	-57.29	peak	
6	*	948.105	-67.88	1.34	-66.54	-13.00	-53.54	peak	

Test Mode: LTE Band 2_TX CH18900_5M_Second Antenna

Vertical

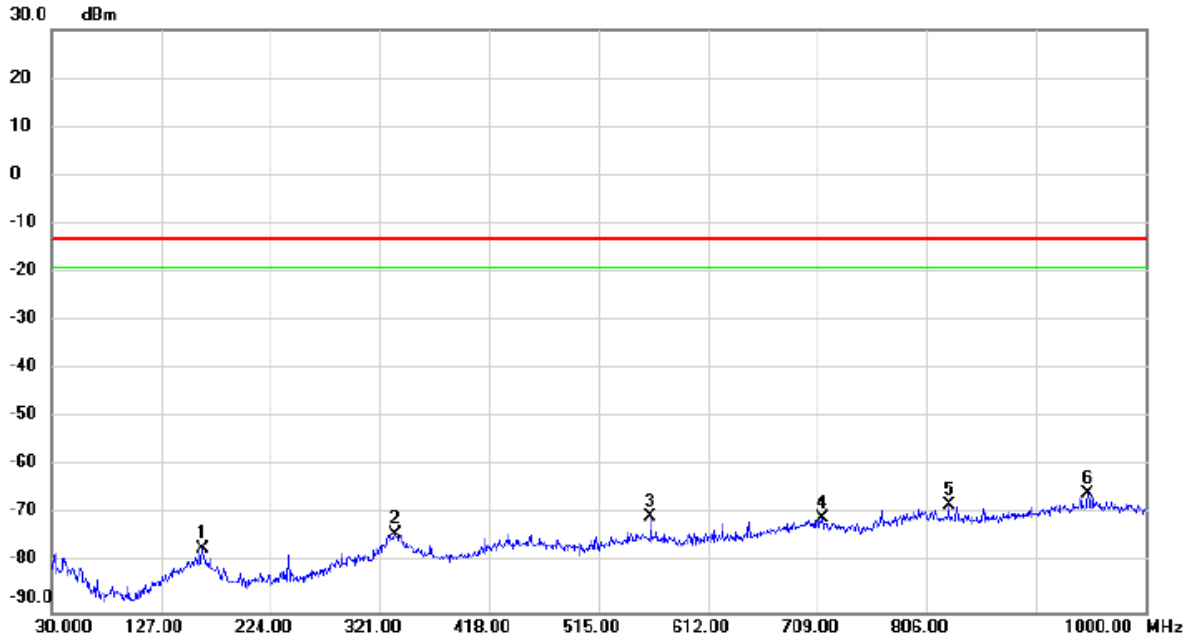

No.	Mk.	Freq. MHz	Reading Level dBm	Correct Factor dB	Measure- ment dBm	Limit dBm	Margin dB	Detector	Comment
1		163.860	-66.21	-10.83	-77.04	-13.00	-64.04	peak	
2		334.580	-62.96	-10.85	-73.81	-13.00	-60.81	peak	
3		561.560	-64.65	-5.65	-70.30	-13.00	-57.30	peak	
4		712.880	-67.72	-3.08	-70.80	-13.00	-57.80	peak	
5		825.885	-66.52	-1.45	-67.97	-13.00	-54.97	peak	
6	*	948.590	-66.97	1.35	-65.62	-13.00	-52.62	peak	

Test Mode: LTE Band 2_TX CH18900_5M_Second Antenna

Horizontal

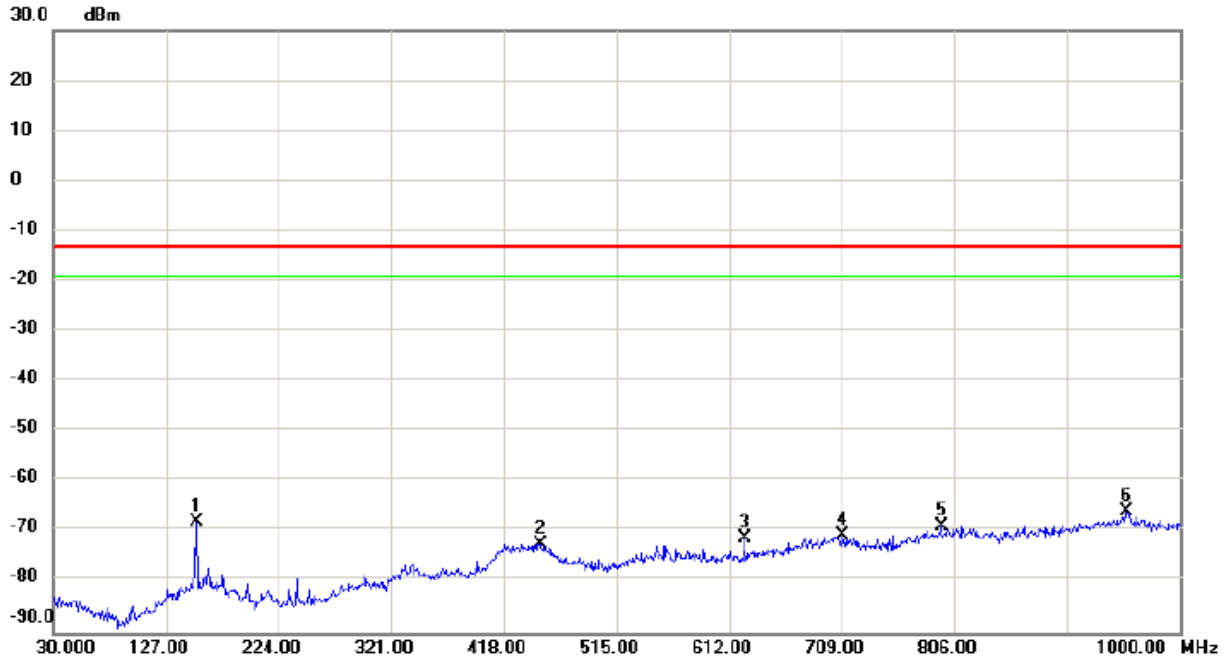

No.	Mk.	Freq. MHz	Reading Level dBm	Correct Factor dB	Measure- ment dBm	Limit dBm	Margin dB	Detector	Comment
1		153.190	-56.82	-11.20	-68.02	-13.00	-55.02	peak	
2		449.525	-64.95	-7.43	-72.38	-13.00	-59.38	peak	
3		625.095	-65.54	-5.73	-71.27	-13.00	-58.27	peak	
4		709.485	-67.63	-2.98	-70.61	-13.00	-57.61	peak	
5		794.360	-67.32	-1.38	-68.70	-13.00	-55.70	peak	
6 *		953.925	-67.11	1.31	-65.80	-13.00	-52.80	peak	

Test Mode: LTE Band 2_TX CH18900_20M_Second Antenna

Vertical

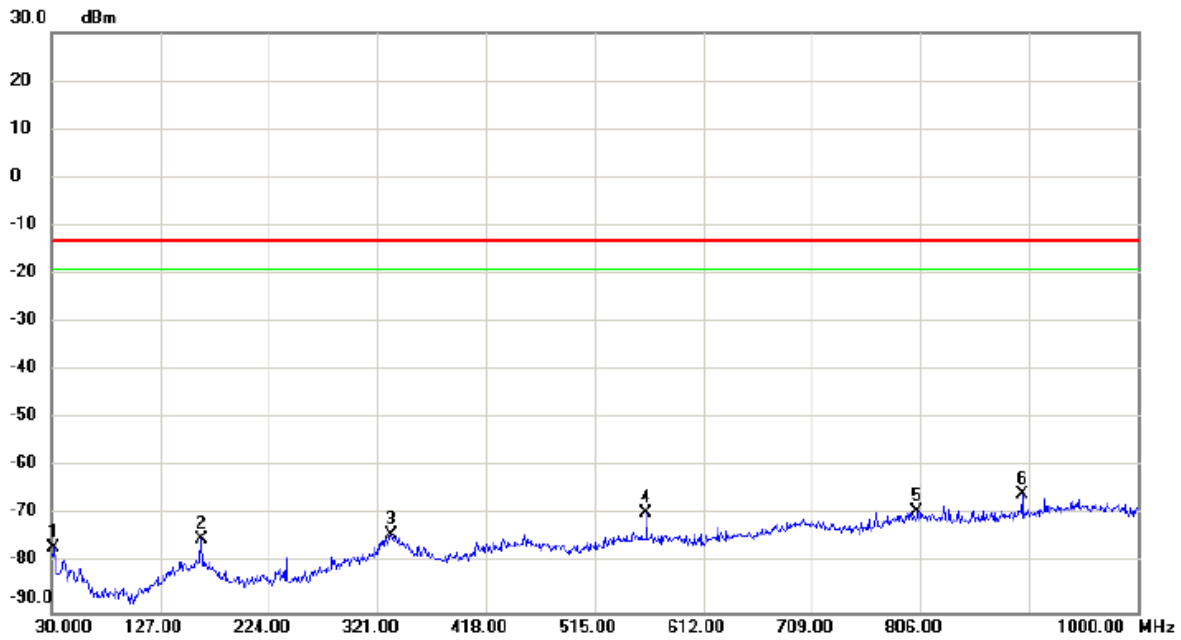

No.	Mk.	Freq. MHz	Reading Level dBm	Correct Factor dB	Measure- ment dBm	Limit dBm	Margin dB	Detector	Comment
1		31.940	-61.60	-15.05	-76.65	-13.00	-63.65	peak	
2		163.860	-63.91	-10.83	-74.74	-13.00	-61.74	peak	
3		332.640	-63.26	-10.83	-74.09	-13.00	-61.09	peak	
4		561.560	-63.90	-5.65	-69.55	-13.00	-56.55	peak	
5		803.090	-68.01	-1.09	-69.10	-13.00	-56.10	peak	
6	*	896.695	-64.74	-0.68	-65.42	-13.00	-52.42	peak	

Test Mode: LTE Band 2_TX CH18900_20M_Second Antenna

Horizontal

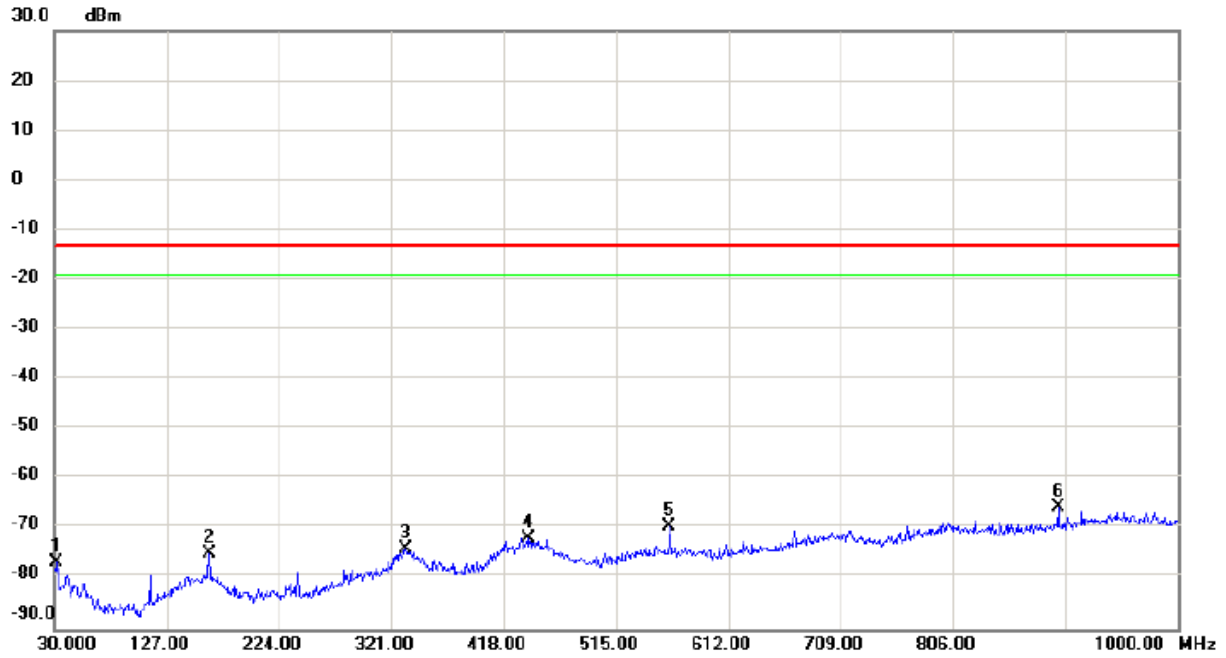

No.	Mk.	Freq. MHz	Reading Level dBm	Correct Factor dB	Measure- ment dBm	Limit dBm	Margin dB	Detector	Comment
1		31.940	-61.60	-15.05	-76.65	-13.00	-63.65	peak	
2		163.860	-63.91	-10.83	-74.74	-13.00	-61.74	peak	
3		332.640	-63.26	-10.83	-74.09	-13.00	-61.09	peak	
4		438.855	-63.93	-7.86	-71.79	-13.00	-58.79	peak	
5		561.560	-63.90	-5.65	-69.55	-13.00	-56.55	peak	
6	*	896.695	-64.74	-0.68	-65.42	-13.00	-52.42	peak	