

FCC Radio Test Report

FCC ID: QISMAR-LX3AM

This report concerns: Original Grant

Project No. : 1904C018
Equipment : Smart Phone
Test Model : MAR-LX3AM
Series Model : N/A
Applicant : Huawei Technologies Co., Ltd.
Address : Administration Building, Headquarters of Huawei Technologies Co., Ltd., Bantian, Longgang District, Shenzhen, 518129, China

Date of Receipt : Apr. 04, 2019
Date of Test : Apr. 08, 2019 ~ Apr. 23, 2019
Issued Date : May 20, 2019
Tested by : BTL Inc.

Testing Engineer : Paul Li
 (Paul Li)

Technical Manager : Steven Lu
 (Steven Lu)

Authorized Signatory : Ethan Ma
 (Ethan Ma)

B T L I N C .

No.3, Jinshagang 1st Road, Shixia, Dalang Town, Dongguan, Guangdong, China.

TEL: +86-769-8318-3000 FAX: +86-769-8319-6000



Certificate #5123.02

Declaration

BTL represents to the client that testing is done in accordance with standard procedures as applicable and that test instruments used has been calibrated with standards traceable to international standard(s) and/or national standard(s).

BTL's reports apply only to the specific samples tested under conditions. It is manufacture's responsibility to ensure that additional production units of this model are manufactured with the identical electrical and mechanical components. **BTL** shall have no liability for any declarations, inferences or generalizations drawn by the client or others from **BTL** issued reports.

The report must not be used by the client to claim product certification, approval, or endorsement by NIST, A2LA, or any agency of the U.S. Government.

This report is the confidential property of the client. As a mutual protection to the clients, the public and ourselves, the test report shall not be reproduced, except in full, without our written approval.

BTL's laboratory quality assurance procedures are in compliance with the **ISO/IEC 17025** requirements, and accredited by the conformity assessment authorities listed in this test report.

BTL is not responsible for the sampling stage, so the results only apply to the sample as received.

The information, data and test plan are provided by manufacturer which may affect the validity of results, so it is manufacturer's responsibility to ensure that the apparatus meets the essential requirements of applied standards and in all the possible configurations as representative of its intended use.

Limitation

For the use of the authority's logo is limited unless the Test Standard(s)/Scope(s)/Item(s) mentioned in this test report is (are) included in the conformity assessment authorities acceptance respective.

Please note that the measurement uncertainty is provided for informational purpose only and is not use in determining the Pass/Fail results.

Table of Contents	Page
REPORT ISSUED HISTORY	6
1 . GENERAL SUMMARY	7
2 . SUMMARY OF TEST RESULTS	8
2.1 TEST FACILITY	9
2.2 MEASUREMENT UNCERTAINTY	9
3 . GENERAL INFORMATION	10
3.1 GENERAL DESCRIPTION OF EUT	10
3.2 DESCRIPTION OF TEST MODES	12
3.3 PARAMETERS OF TEST SOFTWARE	13
3.4 BLOCK DIAGRAM SHOWING THE CONFIGURATION OF SYSTEM TESTED	14
3.5 SUPPORT UNITS	14
4 . AC POWER LINE CONDUCTED EMISSIONS TEST	15
4.1 LIMIT	15
4.2 TEST PROCEDURE	15
4.3 DEVIATION FROM TEST STANDARD	15
4.4 TEST SETUP	16
4.5 EUT OPERATION CONDITIONS	16
4.6 EUT TEST CONDITIONS	16
4.7 TEST RESULTS	16
5 . RADIATED EMISSIONS TEST	17
5.1 LIMIT	17
5.2 TEST PROCEDURE	18
5.3 DEVIATION FROM TEST STANDARD	18
5.4 TEST SETUP	19
5.5 EUT OPERATION CONDITIONS	21
5.6 EUT TEST CONDITIONS	21
5.7 TEST RESULTS - 9 KHZ TO 30 MHZ	21
5.8 TEST RESULTS - 30 MHZ TO 1000 MHZ	21
5.9 TEST RESULTS - ABOVE 1000 MHZ	21
6 . BANDWIDTH TEST	22
6.1 LIMIT	22
6.2 TEST PROCEDURE	22

Table of Contents	Page
6.3 DEVIATION FROM STANDARD	22
6.4 TEST SETUP	22
6.5 EUT OPERATION CONDITIONS	22
6.6 EUT TEST CONDITIONS	22
6.7 TEST RESULTS	22
7 . MAXIMUM OUTPUT POWER TEST	23
7.1 LIMIT	23
7.2 TEST PROCEDURE	23
7.3 DEVIATION FROM STANDARD	23
7.4 TEST SETUP	23
7.5 EUT OPERATION CONDITIONS	23
7.6 EUT TEST CONDITIONS	23
7.7 TEST RESULTS	23
8 . CONDUCTED SPURIOUS EMISSIONS	24
8.1 LIMIT	24
8.2 TEST PROCEDURE	24
8.3 DEVIATION FROM STANDARD	24
8.4 TEST SETUP	24
8.5 EUT OPERATION CONDITIONS	24
8.6 EUT TEST CONDITIONS	24
8.7 TEST RESULTS	24
9 . POWER SPECTRAL DENSITY TEST	25
9.1 LIMIT	25
9.2 TEST PROCEDURE	25
9.3 DEVIATION FROM STANDARD	25
9.4 TEST SETUP	25
9.5 EUT OPERATION CONDITIONS	25
9.6 EUT TEST CONDITIONS	25
9.7 TEST RESULTS	25
10 . MEASUREMENT INSTRUMENTS LIST	26
APPENDIX A - AC POWER LINE CONDUCTED EMISSIONS	28
APPENDIX B - RADIATED EMISSION - 9 KHZ TO 30 MHZ	31
APPENDIX C - RADIATED EMISSION - 30 MHZ TO 1000 MHZ	36

Table of Contents**Page**

APPENDIX D - RADIATED EMISSION- ABOVE 1000 MHZ	39
APPENDIX E - BANDWIDTH	80
APPENDIX F - MAXIMUM OUTPUT POWER	83
APPENDIX G - CONDUCTED SPURIOUS EMISSIONS	85
APPENDIX H - POWER SPECTRAL DENSITY	90

REPORT ISSUED HISTORY

Report Version	Description	Issued Date
R00	Original Issue.	Apr. 24, 2019
R01	Updated the Software Version.	May 15, 2019
R02	Changed the FCC ID QISMAR-LX3Am to QISMAR-LX3AM.	May 20, 2019

1. GENERAL SUMMARY

Equipment : Smart Phone
Brand Name : HUAWEI
Test Model : MAR-LX3Am
Series Model : N/A
Applicant : Huawei Technologies Co., Ltd.
Manufacturer : Huawei Technologies Co., Ltd.
Address : Administration Building, Headquarters of Huawei Technologies Co., Ltd.,
Bantian, Longgang District, Shenzhen, 518129, China
Date of Test : Apr. 08, 2019 ~ Apr. 23, 2019
Test Sample : Engineering Sample No.: D190403577 for conducted, D190403530 for
radiated.
Standard(s) : FCC Part15, Subpart C (15.247)
ANSI C63.10-2013

The above equipment has been tested and found compliance with the requirement of the relative standards by BTL Inc.

The test data, data evaluation, and equipment configuration contained in our test report (Ref No. BTL-FCCP-3-1904C018) were obtained utilizing the test procedures, test instruments, test sites that has been accredited by the Authority of A2LA according to the ISO/IEC 17025 quality assessment standard and technical standard(s).

Test results included in this report are only for the WLAN 2.4 GHz part.

2. SUMMARY OF TEST RESULTS

Test procedures according to the technical standard(s):

Applied Standard(s): FCC Part15, Subpart C (15.247)				
Standard(s) Section	Test Item	Test Result	Judgment	Remark
15.207	AC Power Line Conducted Emissions	APPENDIX A	PASS	-----
15.247(d) 15.205(a) 15.209(a)	Radiated Emissions	APPENDIX B APPENDIX C APPENDIX D	PASS	-----
15.247(a)(2)	Bandwidth	APPENDIX E	PASS	-----
15.247(b)(3)	Maximum Output Power	APPENDIX F	PASS	-----
15.247(d)	Conducted Spurious Emissions	APPENDIX G	PASS	-----
15.247(e)	Power Spectral Density	APPENDIX H	PASS	-----
15.203	Antenna Requirement	-----	PASS	-----

2.1 TEST FACILITY

The test facilities used to collect the test data in this report is at the location of No.3,Jinshagang 1st Road, Shixia, Dalang Town, Dongguan, Guangdong, China.

BTL's Test Firm Registration Number for FCC: 357015

BTL's Designation Number for FCC: CN1240

2.2 MEASUREMENT UNCERTAINTY

ISO/IEC 17025 requires that an estimate of the measurement uncertainties associated with the emissions test results be included in the report. The measurement uncertainties given below are based on a 95% confidence level (based on a coverage factor (k=2))

The BTL measurement uncertainty as below table:

A. AC power line conducted emissions test:

Test Site	Method	Measurement Frequency Range	U, (dB)
DG-C02	CISPR	150 kHz ~ 30 MHz	2.32

B. Radiated emissions test:

Test Site	Method	Measurement Frequency Range	Ant. H / V	U, (dB)
DG-CB03	CISPR	9 KHz~30 MHz	V	3.79
		9 KHz~30 MHz	H	3.57
		30 MHz~200 MHz	V	3.82
		30 MHz~200 MHz	H	3.78
		200 MHz~1,000 MHz	V	4.10
		200 MHz~1,000 MHz	H	4.06
		1 GHz~18 GHz	V	3.12
		1 GHz~18 GHz	H	3.68
		18 GHz~40 GHz	V	4.15
		18 GHz~40 GHz	H	4.14

Note: Unless specifically mentioned, the uncertainty of measurement has not been taken into account to declare the compliance or non-compliance to the specification.

3. GENERAL INFORMATION

3.1 GENERAL DESCRIPTION OF EUT

Equipment	Smart Phone
Brand Name	HUAWEI
Test Model	MAR-LX3Am
Series Model	N/A
Model Difference(s)	N/A
Hardware Version	HL4MARM
Software Version	9.0.1.156(SP1C900E141R1P6)
Power Source	1# DC voltage supplied from AC/DC adapter. 2# Supplied from battery. 3# Supplied from USB.
Power Rating	1# I/P:100-240V ~50/60Hz, 0.5A O/P: 5V 2A OR 9V 2A 2# DC 3.82V, 3240mAh 3# DC 5V
Operation Frequency	2412 MHz ~ 2462 MHz
Modulation Type	IEEE 802.11b: DSSS IEEE 802.11g: OFDM IEEE 802.11n: OFDM
Bit Rate of Transmitter	IEEE 802.11b: 11/5.5/2/1 Mbps IEEE 802.11g: 54/48/36/24/18/12/9/6 Mbps IEEE 802.11n: up to 150 Mbps
Maximum Output Power	IEEE 802.11b: 21.62 dBm (0.1452 W) IEEE 802.11g: 24.11 dBm (0.2576 W) IEEE 802.11n (HT20): 23.26 dBm (0.2118 W) IEEE 802.11n (HT40): 22.02 dBm (0.1592 W)

Note:

- For a more detailed features description, please refer to the manufacturer's specifications or the user's manual.
- Channel List:

CH01 - CH11 for 802.11b, 802.11g, 802.11n(20 MHz)							
CH03 - CH09 for 802.11n(40 MHz)							
Channel	Frequency (MHz)	Channel	Frequency (MHz)	Channel	Frequency (MHz)	Channel	Frequency (MHz)
01	2412	04	2427	07	2442	10	2457
02	2417	05	2432	08	2447	11	2462
03	2422	06	2437	09	2452		

3. Table for Filed Antenna:

Ant.	Brand	Model Name	Antenna Type	Connector	Gain (dBi)
1	N/A	N/A	Internal	N/A	-2.4

4. The EUT contains following accessory devices.

Item	Manufacturer	Factory	Model	Description
Adapter	Huawei Technologies Co., Ltd.	Salcomp (Shenzhen) Co., Ltd.	HW-090200EH0	I/P:100-240V ~50/60Hz, 0.5A O/P:5V \equiv 2A OR 9V \equiv 2A
		HUIZHOU BYD ELECTRONIC CO., LTD.	HW-090200BH0 HW-090200UH0 HW-059200EHQ	
		SHENZHEN HUNTKEY ELECTRIC CO., LTD.	HW-090200EH0 HW-090200BH0 HW-090200UH0	
		Huawei Technologies Co., Ltd.	HW-090200UH1	
Battery	Huawei Technologies Co., Ltd.	SCUD (FUJIAN) Electronics Co., Ltd.	HB356687ECW	Rated capacity: 3240mAh Nominal Voltage: \equiv +3.82V Charging Voltage: \equiv +4.40V
		Huizhou Desay Battery Co., Ltd.		
		Sunwoda Electronic Co., Ltd.		
Earphone	-	Jiangxi Lianchuang Hongsheng Electronic Co., LTD.	MEND1532B528A02 MEND1532B528B00	-
		Boluo County Quancheng Electronic Co., Ltd.	1293-3283-3.5mm-322 1293-3283-3.5mm-336	
		FOXCONN INTERCONNECT TECHNOLOGY LIMITED	EPAB542-2WH05-DH EPAB542-2WH06-DH	

3.2 DESCRIPTION OF TEST MODES

The test system was pre-tested based on the consideration of all possible combinations of EUT operation mode.

Pretest Mode	Description
Mode 1	TX B Mode Channel 01/06/11
Mode 2	TX G Mode Channel 01/06/11
Mode 3	TX N-20 MHz Mode Channel 01/06/11
Mode 4	TX N-40 MHz Mode Channel 03/06/09
Mode 5	TX G Mode Channel 01

Following mode(s) was (were) found to be the worst case(s) and selected for the final test.

AC power line conducted emissions test	
Final Test Mode:	Description
Mode 5	TX G Mode Channel 01

Radiated emissions test - Below 1GHz	
Final Test Mode:	Description
Mode 5	TX G Mode Channel 01

Radiated emissions test - Above 1GHz - Band edge	
Final Test Mode:	Description
Mode 1	TX B Mode Channel 01/11
Mode 2	TX G Mode Channel 01/11
Mode 3	TX N-20 MHz Mode Channel 01/11
Mode 4	TX N-40 MHz Mode Channel 03/09

Radiated emissions test - Harmonic	
Final Test Mode:	Description
Mode 1	TX B Mode Channel 06
Mode 2	TX G Mode Channel 06
Mode 3	TX N-20 MHz Mode Channel 06
Mode 4	TX N-40 MHz Mode Channel 06

Conducted test	
Final Test Mode:	Description
Mode 1	TX B Mode Channel 01/06/11
Mode 2	TX G Mode Channel 01/06/11
Mode 3	TX N-20 MHz Mode Channel 01/06/11
Mode 4	TX N-40 MHz Mode Channel 03/06/09

NOTE:

- (1) Radiated Emissions of middle channel is performed and Band edge of high and low channels are performed.
- (2) For radiated emission below 1 GHz test, the IEEE 802.11g channel 01 is found to be the worst case and recorded.
- (3) For radiated emission above 1 GHz test, 1GHz~26.5GHz have been pre-tested and in this report only recorded the worst case.

3.3 PARAMETERS OF TEST SOFTWARE

Test Software	WiFIRFAuth.apk		
Frequency (MHz)	2412	2437	2462
IEEE 802.11b	18	17	18
IEEE 802.11g	13	13	13
IEEE 802.11n (HT20)	12	12	12
Frequency (MHz)	2422	2437	2452
IEEE 802.11n (HT40)	10	10	10

3.4 BLOCK DIAGRAM SHOWING THE CONFIGURATION OF SYSTEM TESTED

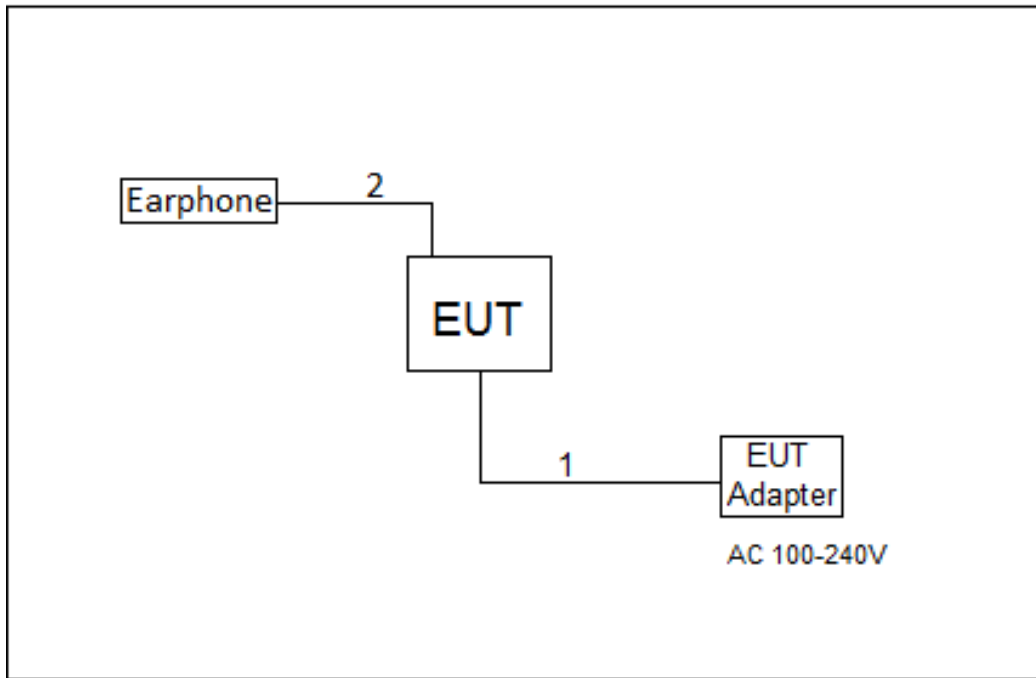

3.5 SUPPORT UNITS

Item	Equipment	Mfr/Brand	Model/Type No.	Series No.
-	-	-	-	-

Item	Shielded Type	Ferrite Core	Length	Note
1	NO	NO	1.2m	DC Cable
2	NO	NO	1.0m	Audio Cable

4. AC POWER LINE CONDUCTED EMISSIONS TEST

4.1 LIMIT

Frequency of Emission (MHz)	Limit (dB μ V)	
	Quasi-peak	Average
0.15 - 0.5	66 to 56*	56 - 46*
0.5 - 5.0	56	46
5.0 - 30.0	60	50

NOTE:

- (1) The tighter limit applies at the band edges.
- (2) The limit of " * " marked band means the limitation decreases linearly with the logarithm of the frequency in the range.

The following table is the setting of the receiver

Receiver Parameters	Setting
Attenuation	10 dB
Start Frequency	0.15 MHz
Stop Frequency	30 MHz
IF Bandwidth	9 kHz

4.2 TEST PROCEDURE

- a. The EUT was placed 0.8 meters from the horizontal ground plane with EUT being connected to the power mains through a line impedance stabilization network (LISN). All other support equipment powered from additional LISN(s). The LISN provide 50 Ohm/ 50uH of coupling impedance for the measuring instrument.
- b. Interconnecting cables that hang closer than 40 cm to the ground plane shall be folded back and forth in the center forming a bundle 30 to 40 cm long.
- c. I/O cables that are not connected to a peripheral shall be bundled in the center. The end of the cable may be terminated, if required, using the correct terminating impedance. The overall length shall not exceed 1 m.
- d. LISN at least 80 cm from nearest part of EUT chassis.
- e. For the actual test configuration, please refer to the related Item -EUT Test Photos.

4.3 DEVIATION FROM TEST STANDARD

No deviation

4.4 TEST SETUP

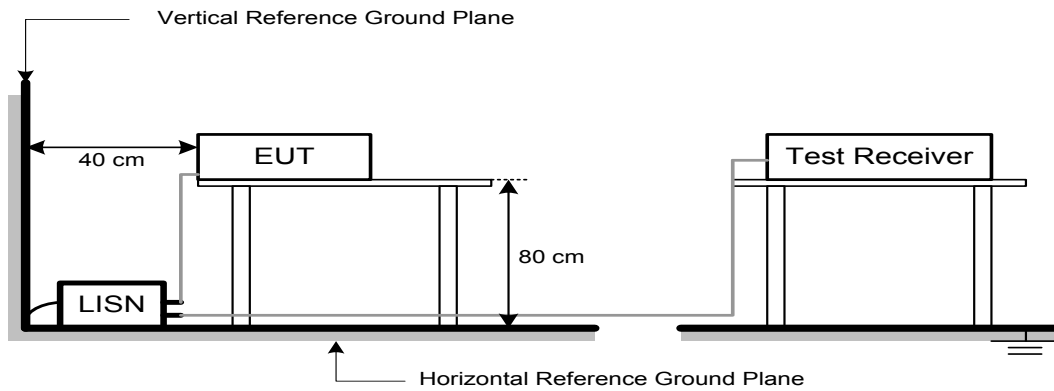

4.5 EUT OPERATION CONDITIONS

EUT was programmed to be in continuously transmitting mode.

4.6 EUT TEST CONDITIONS

Temperature: 25°C Relative Humidity: 53% Test Voltage: AC 120V/60Hz

4.7 TEST RESULTS

Please refer to the APPENDIX A.

5. RADIATED EMISSIONS TEST

5.1 LIMIT

In case the emission fall within the restricted band specified on 15.205(a), then the 15.209(a) limit in the table below has to be followed.

LIMITS OF RADIATED EMISSION MEASUREMENT (9 kHz-1000 MHz)

Frequency (MHz)	Field Strength (microvolts/meter)	Measurement Distance (meters)
0.009-0.490	2400/F(kHz)	300
0.490-1.705	24000/F(kHz)	30
1.705-30.0	30	30
30-88	100	3
88-216	150	3
216-960	200	3
Above 960	500	3

LIMITS OF RADIATED EMISSION MEASUREMENT (Above 1000 MHz)

Frequency (MHz)	Band edge / Harmonic at 3m (dBµV/m)		Harmonic at 1.5m (dBµV/m)	
	Peak	Average	Peak	Average
Above 1000	74	54	80 (Note 5)	60(Note 5)

NOTE:

- (1) The limit for radiated test was performed according to FCC PART 15C.
- (2) The tighter limit applies at the band edges.
- (3) Emission level (dBuV/m)=20log Emission level (uV/m).
- (4) The test result calculated as following:
 Measurement Value = Reading Level + Correct Factor
 Correct Factor = Antenna Factor + Cable Loss - Amplifier Gain(if use)
 Margin Level = Measurement Value - Limit Value

$$(5) \quad FS_{\text{limit}} = FS_{\text{max}} - 20 \log \left(\frac{d_{\text{limit}}}{d_{\text{measure}}} \right)$$

$$20 \log d_{\text{limit}}/d_{\text{measure}} = 20 \log 3/1.5 = 6 \text{ dB.}$$

Spectrum Parameter	Setting
Attenuation	Auto
Start Frequency	1000 MHz
Stop Frequency	10th carrier harmonic
RBW / VBW (Emission in restricted band)	1 MHz / 3 MHz for Peak, 1 MHz / 1/T for Average

Receiver Parameter	Setting
Attenuation	Auto
Start ~ Stop Frequency	9 kHz~90 kHz for PK/AVG detector
Start ~ Stop Frequency	90 kHz~110 kHz for QP detector
Start ~ Stop Frequency	110 kHz~490 kHz for PK/AVG detector
Start ~ Stop Frequency	490 kHz~30 MHz for QP detector
Start ~ Stop Frequency	30 MHz~1000 MHz for QP detector

5.2 TEST PROCEDURE

- a. The measuring distance of 3 m shall be used for measurements. The EUT was placed on the top of a rotating table 0.8 meter above the ground at a 3 meter semi-anechoic chamber. The table was rotated 360 degrees to determine the position of the highest radiation.(below 1 GHz)
- b. The measuring distance of 3 m or 1.5m shall be used for measurements. The EUT was placed on the top of a rotating table 1.5 meter above the ground at a 3 meter semi-anechoic chamber. The table was rotated 360 degrees to determine the position of the highest radiation.(above 1GHz)
- c. The height of the equipment or of the substitution antenna shall be 0.8m or 1.5m; the height of the test antenna shall vary between 1 m to 4 m. Both horizontal and vertical polarizations of the antenna are set to make the measurement.
- d. For each suspected emission, the EUT was arranged to its worst case and then the antenna was tuned to heights find the maximum reading (used Bore sight function).
- e. The receiver system was set to peak and average detect function and specified bandwidth with maximum hold mode when the test frequency is above 1 GHz.
- f. The initial step in collecting radiated emission data is a receiver peak detector mode pre-scanning the measurement frequency range. Significant peaks are then marked and then Quasi Peak detector mode re-measured.
- g. All readings are Peak unless otherwise stated QP in column of Note. Peak denotes that the Peak reading compliance with the QP Limits and then QP Mode measurement didn't perform. (below 1 GHz)
- h. All readings are Peak Mode value unless otherwise stated AVG in column of Note. If the Peak Mode Measured value compliance with the Peak Limits and lower than AVG Limits, the EUT shall be deemed to meet both Peak & AVG Limits and then only Peak Mode was measured, but AVG Mode didn't perform. (above 1 GHz)
- i. For the actual test configuration, please refer to the related Item -EUT Test Photos.

5.3 DEVIATION FROM TEST STANDARD

No deviation

5.4 TEST SETUP

9 kHz-30 MHz

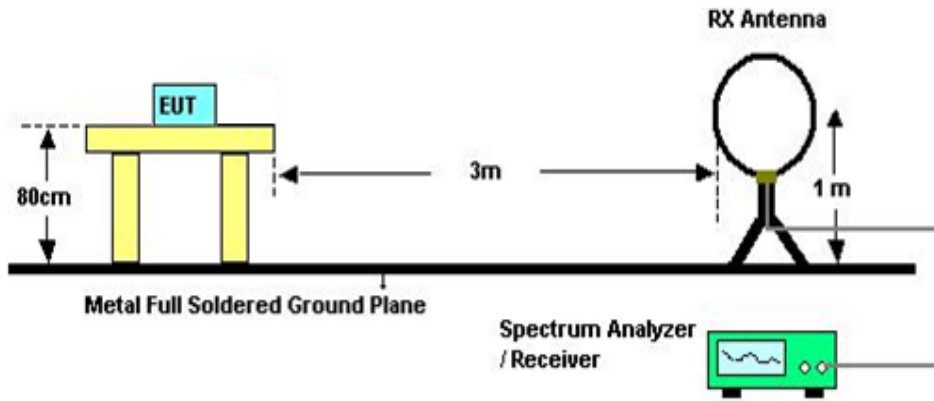

30 MHz to 1 GHz

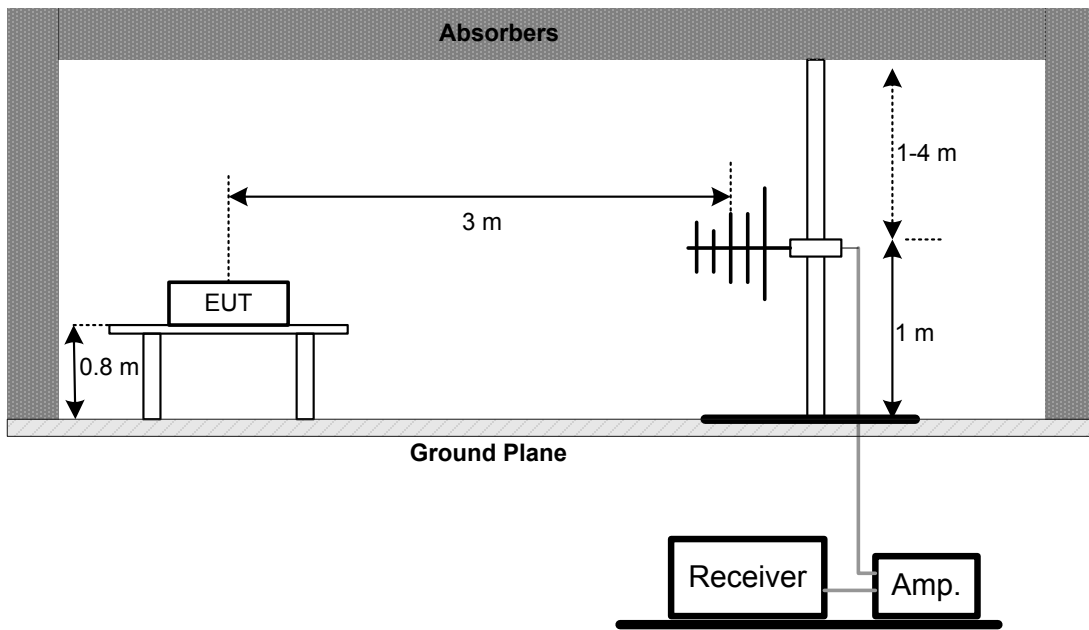

Band edge & Harmonic (Above 1 GHz)

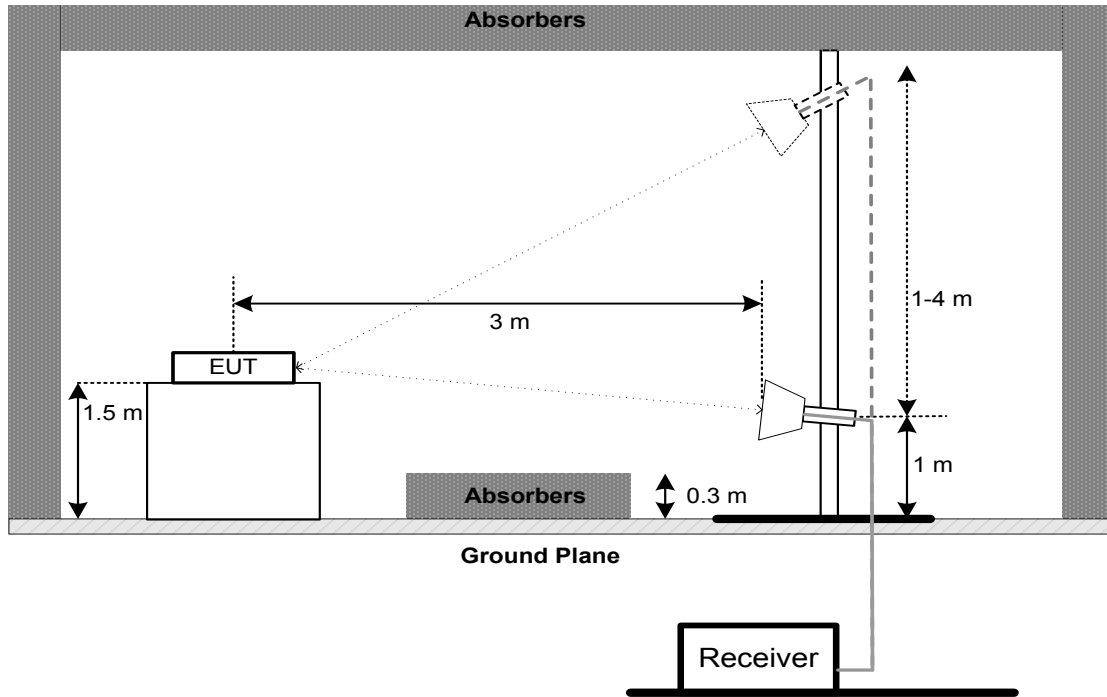

Harmonic (Above 18 GHz)

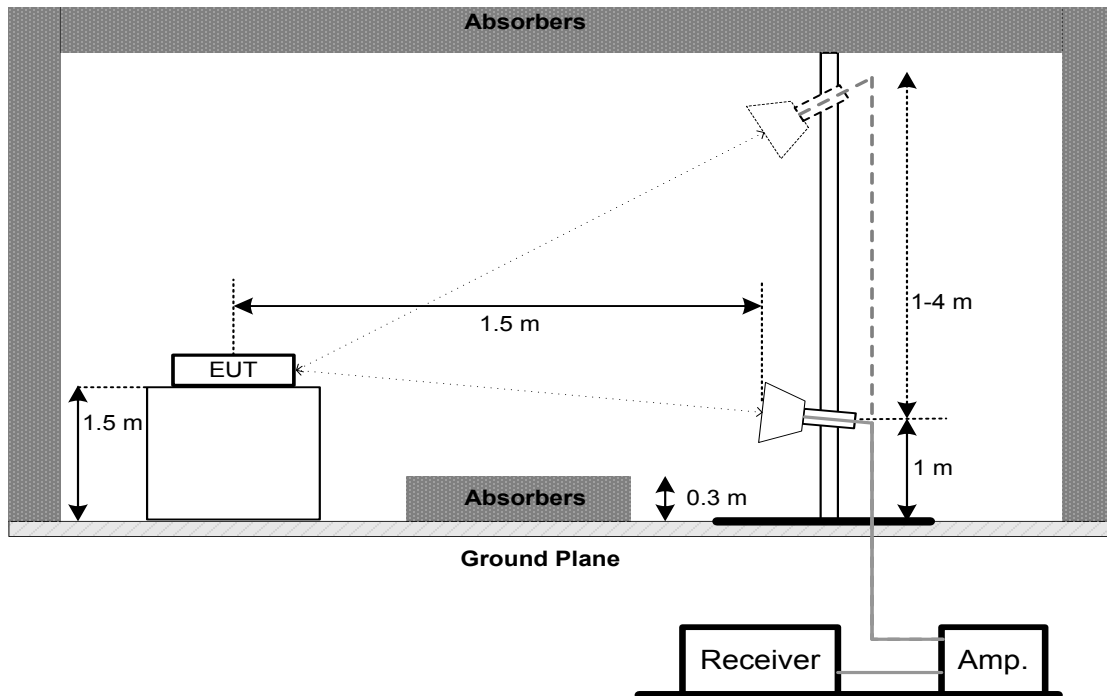

5.5 EUT OPERATION CONDITIONS

The EUT was programmed to be in continuously transmitting mode.

5.6 EUT TEST CONDITIONS

Temperature: 24°C Relative Humidity: 68% Test Voltage: AC 120V/60Hz

5.7 TEST RESULTS - 9 KHZ TO 30 MHZ

Please refer to the APPENDIX B

Remark:

- (1) Distance extrapolation factor = $40 \log$ (specific distance / test distance) (dB).
- (2) Limit line = specific limits (dBuV) + distance extrapolation factor.
- (3) All adapters had been pre-test and in this report only recorded the worst case.

5.8 TEST RESULTS - 30 MHZ TO 1000 MHZ

Please refer to the APPENDIX C.

Remark:

- (1) All adapters had been pre-test and in this report only recorded the worst case.

5.9 TEST RESULTS - ABOVE 1000 MHZ

Please refer to the APPENDIX D.

Remark:

- (1) No limit: This is fundamental signal, the judgment is not applicable.
For fundamental signal judgment was referred to Peak output test.
- (2) All adapters had been pre-test and in this report only recorded the worst case.

6. BANDWIDTH TEST

6.1 LIMIT

FCC Part15, Subpart C (15.247)		
Section	Test Item	Limit
15.247(a)(2)	6 dB Bandwidth	Minimum 500 kHz
	99% Emission Bandwidth	-

6.2 TEST PROCEDURE

- a. The EUT was directly connected to the spectrum analyzer and antenna output port as show in the block diagram below.
- b. Spectrum Setting: RBW= 100 kHz, VBW=300 kHz, Sweep time = 2.5 ms.
- c. The bandwidth was performed in accordance with method 11.8 of ANSI C63.10-2013.

6.3 DEVIATION FROM STANDARD

No deviation.

6.4 TEST SETUP



6.5 EUT OPERATION CONDITIONS

The EUT was programmed to be in continuously transmitting mode.

6.6 EUT TEST CONDITIONS

Temperature: 26°C Relative Humidity: 63.2% Test Voltage: AC 120V/60Hz

6.7 TEST RESULTS

Please refer to the APPENDIX E.

7. MAXIMUM OUTPUT POWER TEST

7.1 LIMIT

FCC Part15, Subpart C (15.247)		
Section	Test Item	Limit
15.247(b)(3)	Maximum Output Power	1 Watt or 30dBm

7.2 TEST PROCEDURE

- a. The EUT was directly connected to the power meter and antenna output port as show in the block diagram below.
- b. The maximum conducted output power was performed in accordance with method 11.9.1.3 (for peak power) or 11.9.2.3 (for AVG power) of ANSI C63.10-2013.

7.3 DEVIATION FROM STANDARD

No deviation.

7.4 TEST SETUP



7.5 EUT OPERATION CONDITIONS

The EUT was programmed to be in continuously transmitting mode.

7.6 EUT TEST CONDITIONS

Temperature: 26°C Relative Humidity: 63.2% Test Voltage: AC 120V/60Hz

7.7 TEST RESULTS

Please refer to the APPENDIX F.

8. CONDUCTED SPURIOUS EMISSIONS

8.1 LIMIT

In any 100 kHz bandwidth outside the frequency band in which the spread spectrum or digitally modulated intentional radiator is operating, the radio frequency power that is produced by the intentional radiator shall be at least 20 dB below that in the 100 kHz bandwidth within the band that contains the highest level of the desired power, based on either an RF conducted or a radiated measurement, provided the transmitter demonstrates compliance with the peak Output Power limits. If the transmitter complies with the Output Power limits based on the use of RMS averaging over a time interval, as permitted under paragraph (b)(3) of this section, the attenuation required under this paragraph shall be 30 dB instead of 20 dB. Attenuation below the general limits specified in Section 15.209(a) is not required. In addition, radiated emissions which fall in the restricted bands, as defined in Section 15.205(a), must also comply with the radiated emission limits specified in Section 15.209(a) (see Section 15.205(c)).

8.2 TEST PROCEDURE

- a. The EUT was directly connected to the spectrum analyzer and antenna output port as show in the block diagram below.
- b. Spectrum Setting: RBW= 100 kHz, VBW=300 kHz, Sweep time = Auto.

8.3 DEVIATION FROM STANDARD

No deviation.

8.4 TEST SETUP



8.5 EUT OPERATION CONDITIONS

The EUT was programmed to be in continuously transmitting mode.

8.6 EUT TEST CONDITIONS

Temperature: 26°C Relative Humidity: 63.2% Test Voltage: AC 120V/60Hz

8.7 TEST RESULTS

Please refer to the APPENDIX G.

9. POWER SPECTRAL DENSITY TEST

9.1 LIMIT

FCC Part15, Subpart C (15.247)		
Section	Test Item	Limit
15.247(e)	Power Spectral Density	8 dBm (in any 3 kHz)

9.2 TEST PROCEDURE

- The EUT was directly connected to the spectrum analyzer and antenna output port as show in the block diagram below.
- Spectrum Setting: RBW=3 kHz, VBW=10 kHz, Sweep time = Auto.
- The Power Spectral Density was performed in accordance with method 11.10.2 of ANSI C63.10-2013.

9.3 DEVIATION FROM STANDARD

No deviation.

9.4 TEST SETUP

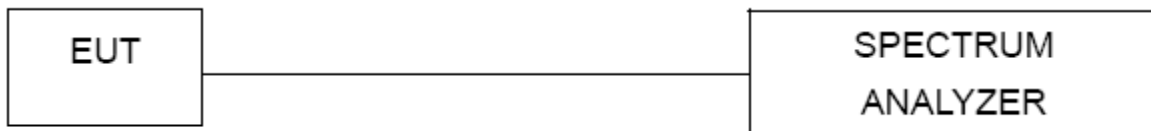

9.5 EUT OPERATION CONDITIONS

The EUT was programmed to be in continuously transmitting mode.

9.6 EUT TEST CONDITIONS

Temperature: 26°C Relative Humidity: 63.2% Test Voltage: AC 120V/60Hz

9.7 TEST RESULTS

Please refer to the APPENDIX H.

10. MEASUREMENT INSTRUMENTS LIST

AC Power Line Conducted Emissions					
Item	Kind of Equipment	Manufacturer	Type No.	Serial No.	Calibrated until
1	EMI Test Receiver	R&S	ESCI	100382	Mar. 10, 2020
2	LISN	EMCO	3816/2	52765	Mar. 10, 2020
3	50ohm Terminator	SHX	TF5-3	15041305	Mar. 10, 2020
4	Artificial-Mains Network	SCHWARZBECK	NSLK 8127	8127685	Mar. 10, 2020
5	TRANSIENT LIMITER	EM	EM-7600	772	Mar. 10, 2020
6	Measurement Software	Farad	EZ-EMC Ver.NB-03A1-01	N/A	N/A
7	Cable	N/A	RG223	12m	Mar. 12, 2020

Radiated Emissions - 9 kHz to 30 MHz					
Item	Kind of Equipment	Manufacturer	Type No.	Serial No.	Calibrated until
1	Loop Antenna	EM	EM-6876-1	230	Jan. 15, 2020
2	Cable	N/A	RG 213/U	C-102	Jun. 01, 2019
3	EMI Test Receiver	R&S	ESCI	100895	Mar. 10, 2020
4	Measurement Software	Farad	EZ-EMC Ver.NB-03A1-01	N/A	N/A

Radiated Emissions - 30 MHz to 1 GHz					
Item	Kind of Equipment	Manufacturer	Type No.	Serial No.	Calibrated until
1	Antenna	Schwarzbeck	VULB9160	9160-3232	Mar. 09, 2020
2	Amplifier	HP	8447D	2944A09673	Aug. 11, 2019
3	Receiver	Agilent	N9038A	MY52130039	Aug. 11, 2019
4	Cable	emci	LMR-400(30MHz-1GHz)(8m+5m)	N/A	May 25, 2019
5	Controller	CT	SC100	N/A	N/A
6	Controller	MF	MF-7802	MF780208416	N/A
7	Measurement Software	Farad	EZ-EMC Ver.NB-03A1-01	N/A	N/A

Radiated Emissions - Above 1 GHz					
Item	Kind of Equipment	Manufacturer	Type No.	Serial No.	Calibrated until
1	Double Ridged Guide Antenna	ETS	3115	75789	Mar. 09, 2020
2	Broad-Band Horn Antenna	Schwarzbeck	BBHA 9170	9170319	Jun. 30, 2019
3	Amplifier	Agilent	8449B	3008A02333	Mar. 10, 2020
4	Microwave Preamplifier With Adaptor	EMC INSTRUMENT	EMC2654045	980039 & HA01	Mar. 10, 2020
5	Receiver	Agilent	N9038A	MY52130039	Aug. 11, 2019
6	Controller	CT	SC100	N/A	N/A
7	Controller	MF	MF-7802	MF780208416	N/A
8	Cable	mitron	B10-01-01-12M	18072744	Jul. 30, 2019
9	Measurement Software	Farad	EZ-EMC Ver.NB-03A1-01	N/A	N/A

Bandwidth					
Item	Kind of Equipment	Manufacturer	Type No.	Serial No.	Calibrated until
1	Spectrum Analyzer	R&S	FSP40	100185	Aug. 11, 2019

Maximum Output Power					
Item	Kind of Equipment	Manufacturer	Type No.	Serial No.	Calibrated until
1	P-series power meter	Agilent	N1911A	MY45100473	Aug. 11, 2019
2	wideband power sensor	Agilent	N1921A	MY51100041	Aug. 11, 2019

Antenna Conducted Spurious Emissions					
Item	Kind of Equipment	Manufacturer	Type No.	Serial No.	Calibrated until
1	Spectrum Analyzer	R&S	FSP40	100185	Aug. 11, 2019

Power Spectral Density					
Item	Kind of Equipment	Manufacturer	Type No.	Serial No.	Calibrated until
1	Spectrum Analyzer	R&S	FSP40	100185	Aug. 11, 2019

Remark: "N/A" denotes no model name, serial no. or calibration specified.
 All calibration period of equipment list is one year.

APPENDIX A - AC POWER LINE CONDUCTED EMISSIONS

Test Mode: TX G MODE CHANNEL 01

Line

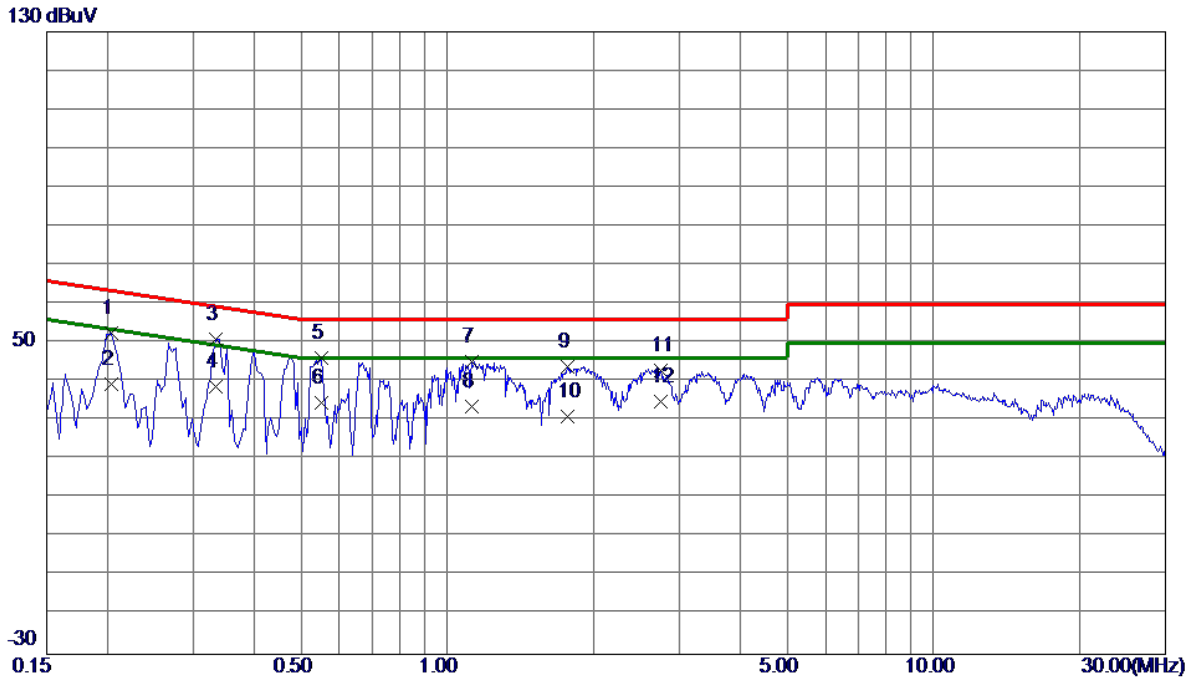

No.	Freq. MHz	Reading Level dBuV	Correct Factor dB	Measurement dBuV	Limit dBuV	Margin dB	Detector	Comment
1	0.2040	42.02	10.48	52.50	63.45	-10.95	Peak	
2	0.2040	28.92	10.48	39.40	53.45	-14.05	AVG	
3 *	0.3345	40.39	10.49	50.88	59.34	-8.46	Peak	
4	0.3345	28.43	10.49	38.92	49.34	-10.42	AVG	
5	0.5503	35.65	10.51	46.16	56.00	-9.84	Peak	
6	0.5503	24.19	10.51	34.70	46.00	-11.30	AVG	
7	1.1220	34.74	10.58	45.32	56.00	-10.68	Peak	
8	1.1220	23.15	10.58	33.73	46.00	-12.27	AVG	
9	1.7700	33.29	10.62	43.91	56.00	-12.09	Peak	
10	1.7700	20.62	10.62	31.24	46.00	-14.76	AVG	
11	2.7465	32.22	10.68	42.90	56.00	-13.10	Peak	
12	2.7465	24.18	10.68	34.86	46.00	-11.14	AVG	

REMARKS:

- (1) Measurement Value = Reading Level + Correct Factor.
- (2) Margin Level = Measurement Value - Limit Value.

Test Mode: TX G MODE CHANNEL 01

Neutral

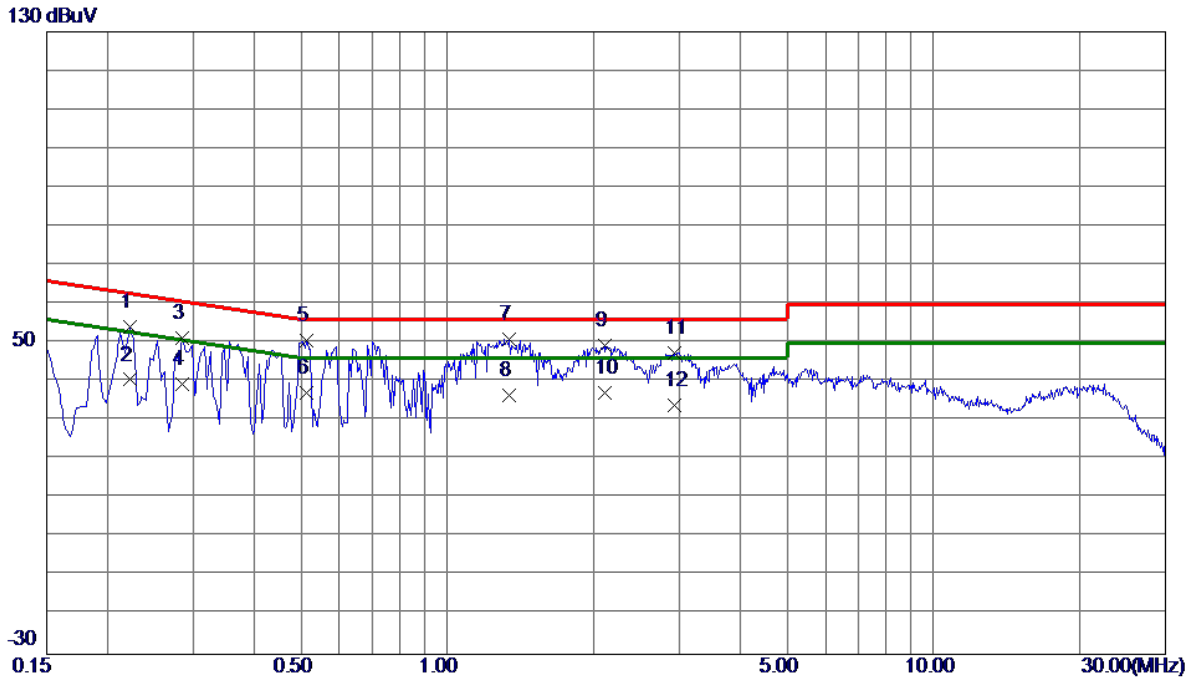

No.	Freq. MHz	Reading Level dBuV	Correct Factor dB	Measure ment dBuV	Limit dBuV	Margin dB	Detector	Comment
1	0.2220	43.62	10.46	54.08	62.74	-8.66	Peak	
2	0.2220	30.10	10.46	40.56	52.74	-12.18	AVG	
3	0.2850	40.83	10.46	51.29	60.67	-9.38	Peak	
4	0.2850	29.08	10.46	39.54	50.67	-11.13	AVG	
5	0.5142	40.05	10.49	50.54	56.00	-5.46	Peak	
6	0.5143	26.83	10.49	37.32	46.00	-8.68	AVG	
7 *	1.3380	40.40	10.53	50.93	56.00	-5.07	Peak	
8	1.3380	25.99	10.53	36.52	46.00	-9.48	AVG	
9	2.1074	38.76	10.60	49.36	56.00	-6.64	Peak	
10	2.1074	26.72	10.60	37.32	46.00	-8.68	AVG	
11	2.9310	36.86	10.65	47.51	56.00	-8.49	Peak	
12	2.9310	23.34	10.65	33.99	46.00	-12.01	AVG	

REMARKS:

- (1) Measurement Value = Reading Level + Correct Factor.
- (2) Margin Level = Measurement Value - Limit Value.

APPENDIX B - RADIATED EMISSION - 9 KHZ TO 30 MHZ

Test Mode: TX G MODE CHANNEL 01

Ant 0°

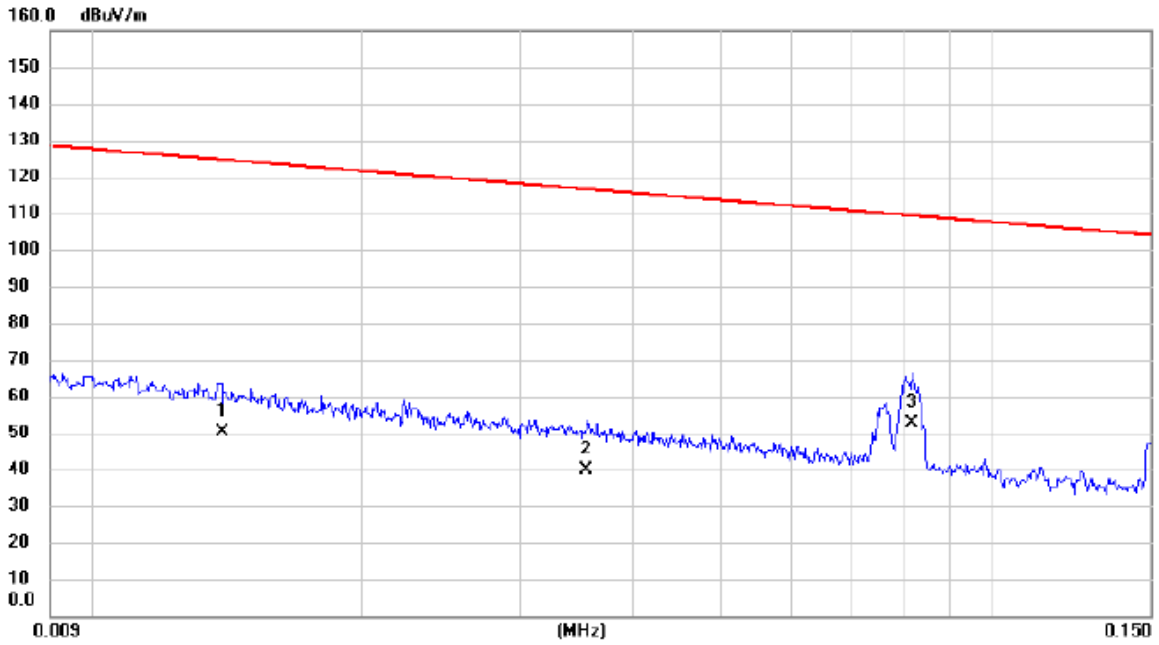

No.	Mk.	Freq. MHz	Reading Level dBuV	Correct Factor dB	Measure- ment dBuV/m	Limit dBuV/m	Margin dB	Detector	Comment
1		0.0140	34.60	15.62	50.22	124.68	-74.46	AVG	
2		0.0355	25.90	13.88	39.78	116.60	-76.82	AVG	
3	*	0.0815	39.10	13.54	52.64	109.38	-56.74	AVG	

REMARKS:

- (1) Measurement Value = Reading Level + Correct Factor.
- (2) Margin Level = Measurement Value - Limit Value.

Test Mode: TX G MODE CHANNEL 01

Ant 0°

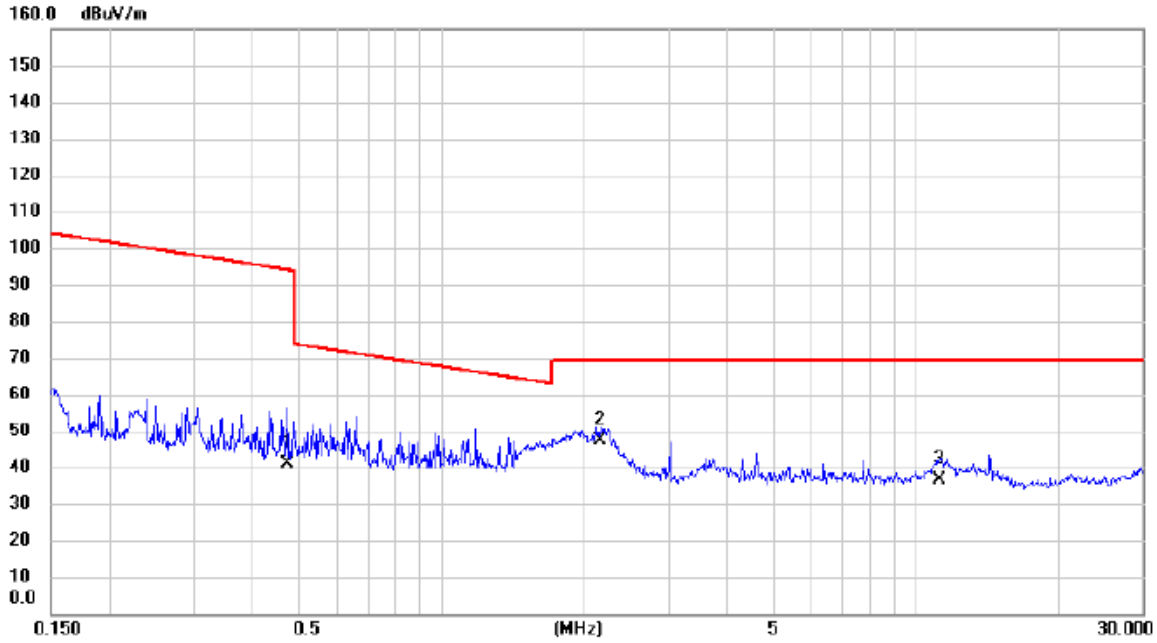

No.	Mk.	Freq. MHz	Reading Level dBuV	Correct Factor dB	Measure- ment dBuV/m	Limit dBuV/m	Margin dB	Detector	Comment
1		0.4736	27.80	13.12	40.92	94.10	-53.18	AVG	
2	*	2.1552	35.80	11.73	47.53	69.54	-22.01	QP	
3		11.1977	24.90	11.62	36.52	69.54	-33.02	QP	

REMARKS:

- (1) Measurement Value = Reading Level + Correct Factor.
- (2) Margin Level = Measurement Value - Limit Value.

Test Mode: TX G MODE CHANNEL 01

Ant 90°

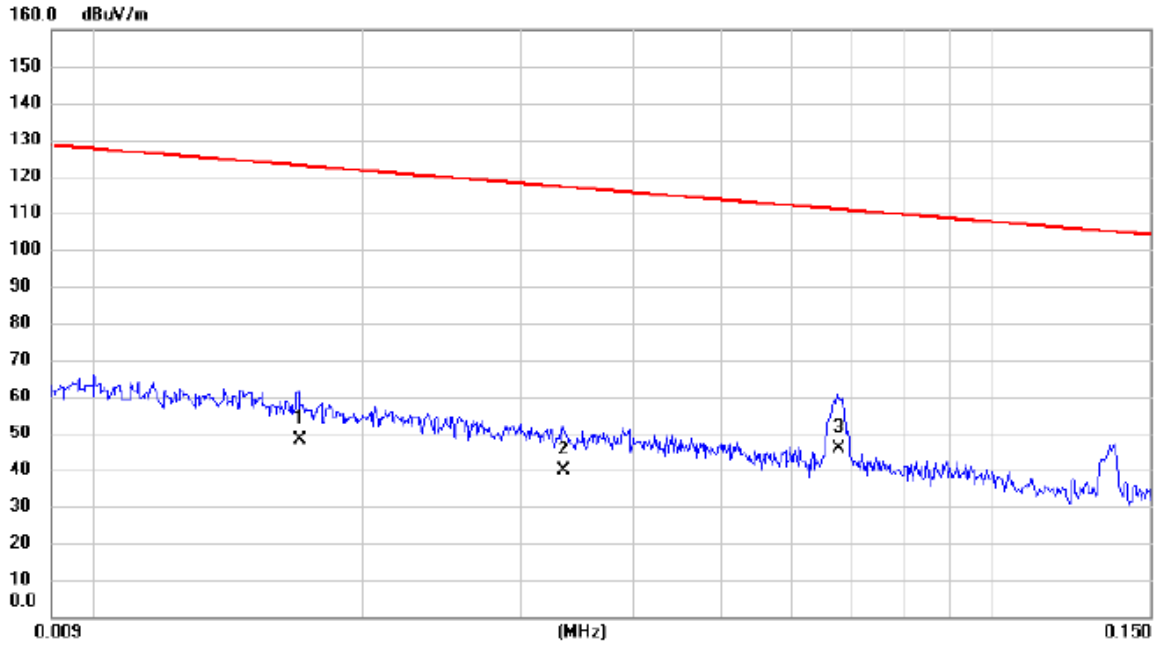

No.	Mk.	Freq. MHz	Reading Level dBuV	Correct Factor dB	Measure- ment dBuV/m	Limit dBuV/m	Margin dB	Detector	Comment
1		0.0170	33.43	14.72	48.15	123.00	-74.85	AVG	
2		0.0334	25.80	13.87	39.67	117.13	-77.46	AVG	
3	*	0.0675	32.10	13.65	45.75	111.02	-65.27	AVG	

REMARKS:

- (1) Measurement Value = Reading Level + Correct Factor.
- (2) Margin Level = Measurement Value - Limit Value.

Test Mode: TX G MODE CHANNEL 01

Ant 90°

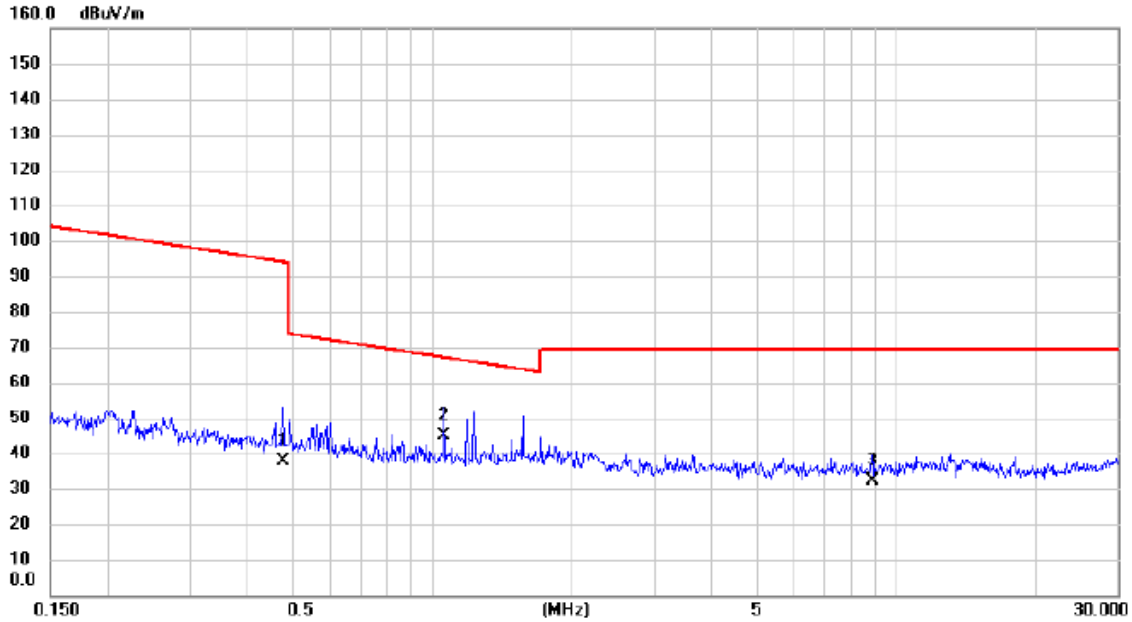

No.	Mk.	Freq. MHz	Reading Level dBuV	Correct Factor dB	Measure- ment dBuV/m	Limit dBuV/m	Margin dB	Detector	Comment
1		0.4761	24.70	13.12	37.82	94.05	-56.23	AVG	
2	*	1.0596	32.60	12.46	45.06	67.10	-22.04	QP	
3		8.8691	20.80	11.45	32.25	69.54	-37.29	QP	

REMARKS:

- (1) Measurement Value = Reading + Correct Factor.
- (2) Margin Level = Measurement Value - Limit Value.

APPENDIX C - RADIATED EMISSION - 30 MHZ TO 1000 MHZ

Test Mode: TX G MODE CHANNEL 01

Vertical

80 dBuV/m

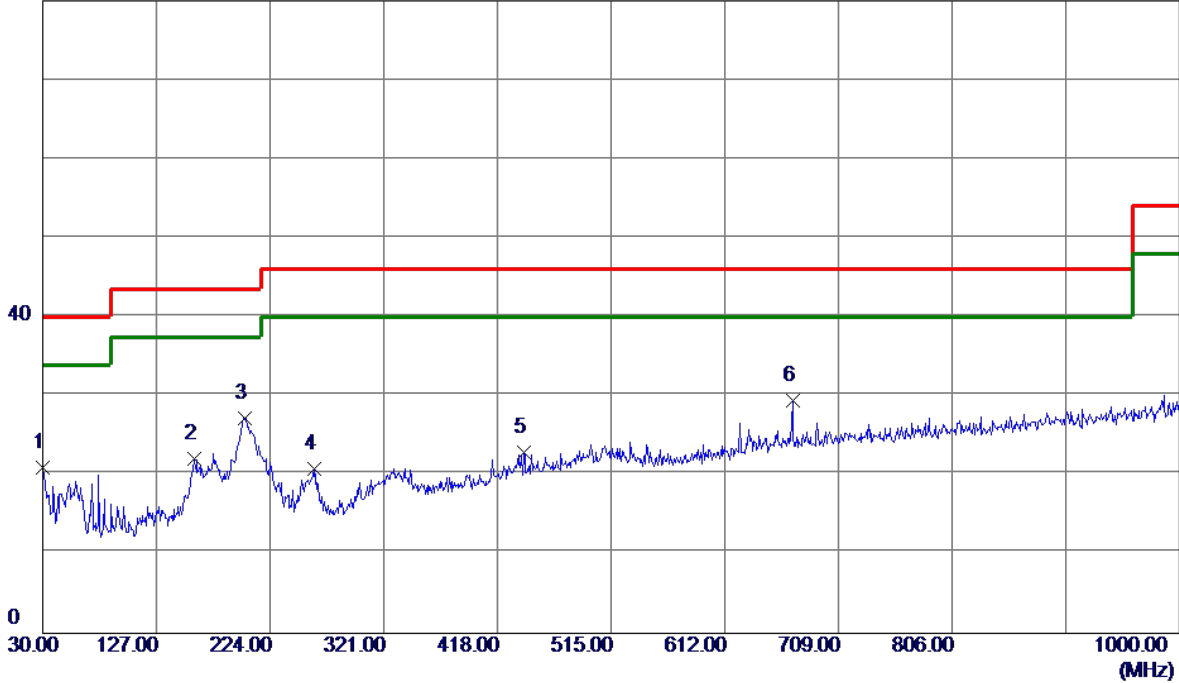

No.	Freq. MHz	Reading Level dBuV/m	Correct Factor dB	Measure ment dBuV/m	Limit dBuV/m	Margin dB	Detector	Comment
1	30.0000	35.92	-15.02	20.90	40.00	-19.10	Peak	
2	159.4950	33.21	-11.13	22.08	43.50	-21.42	Peak	
3 *	202.1750	42.52	-15.33	27.19	43.50	-16.31	Peak	
4	261.3450	33.63	-12.78	20.85	46.00	-25.15	Peak	
5	440.3100	31.24	-8.41	22.83	46.00	-23.17	Peak	
6	669.7150	33.88	-4.45	29.43	46.00	-16.57	Peak	

REMARKS:

- (1) Measurement Value = Reading Level + Correct Factor.
- (2) Margin Level = Measurement Value - Limit Value.

Test Mode: TX G MODE CHANNEL 01

Horizontal

80 dBuV/m

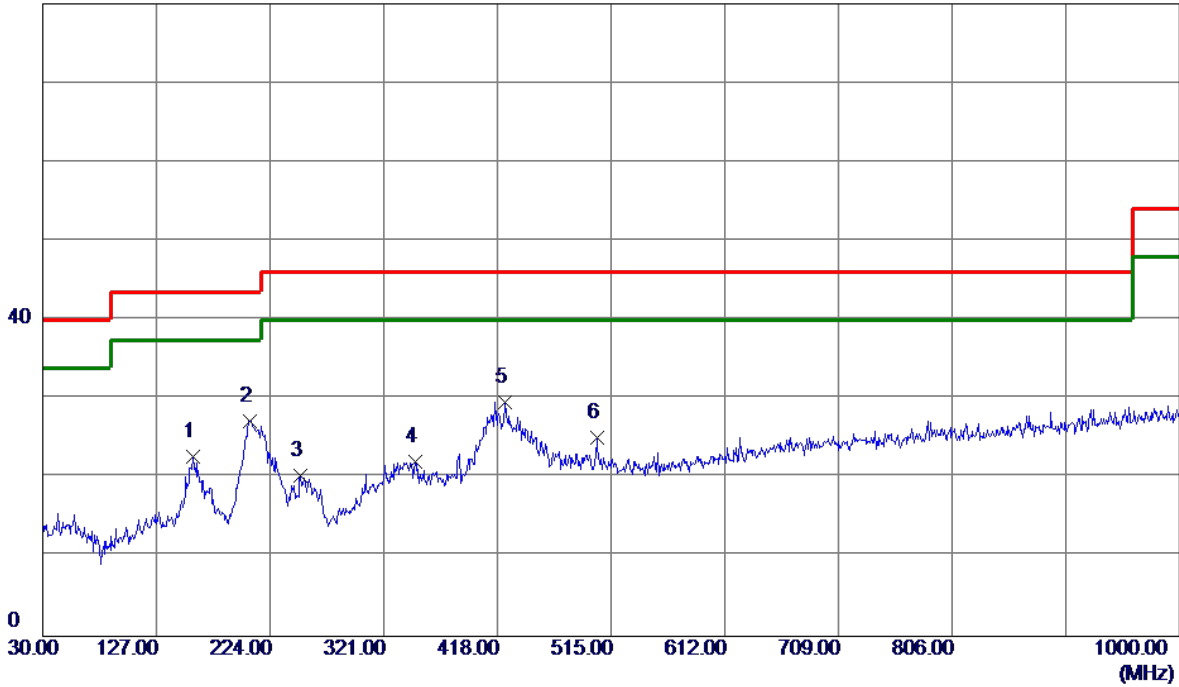

No.	Freq. MHz	Reading Level dBuV/m	Correct Factor dB	Measure ment dBuV/m	Limit dBuV/m	Margin dB	Detector	Comment
1	158.5250	33.94	-11.26	22.68	43.50	-20.82	Peak	
2 *	206.5399	42.75	-15.52	27.23	43.50	-16.27	Peak	
3	250.1900	34.02	-13.77	20.25	46.00	-25.75	Peak	
4	347.6750	32.88	-10.78	22.10	46.00	-23.90	Peak	
5	424.7900	38.49	-8.85	29.64	46.00	-16.36	Peak	
6	502.8750	32.81	-7.73	25.08	46.00	-20.92	Peak	

REMARKS:

- (1) Measurement Value = Reading Level + Correct Factor.
- (2) Margin Level = Measurement Value - Limit Value.

APPENDIX D - RADIATED EMISSION- ABOVE 1000 MHZ

Orthogonal Axis	X
Test Mode:	TX B Mode 2412 MHz

Vertical

130 dBuV/m

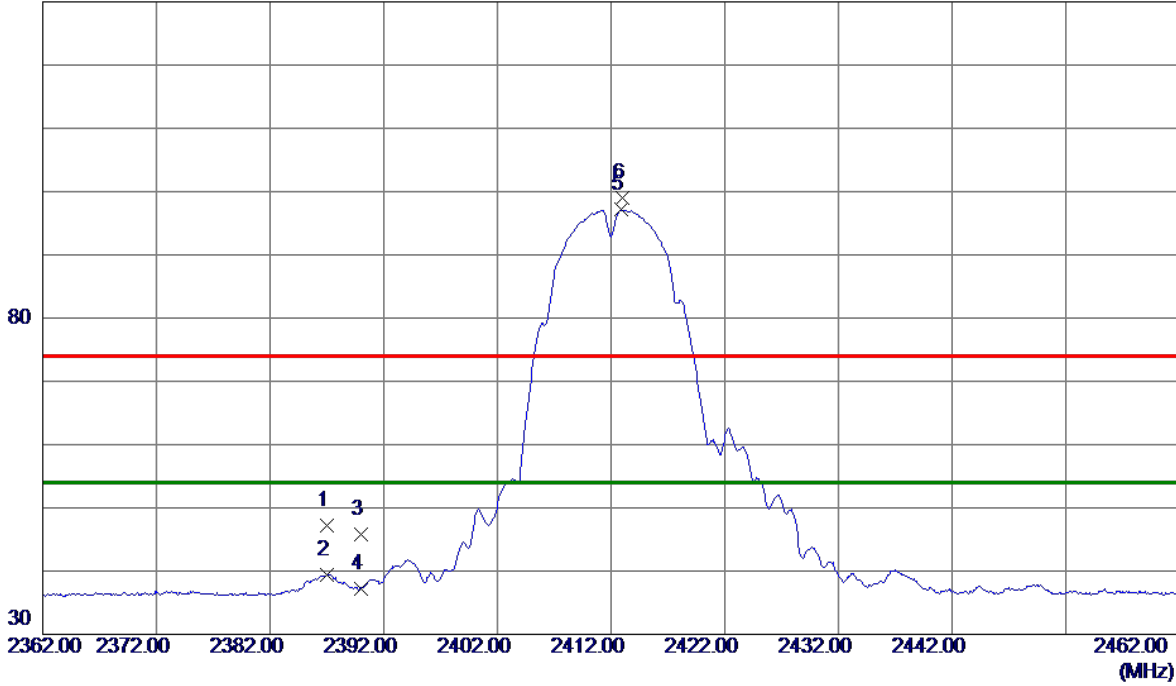

No.	Freq. MHz	Reading Level dBuV/m	Correct Factor dB	Measure ment dBuV/m	Limit dBuV/m	Margin dB	Detector	Comment
1	2387.0000	40.75	6.53	47.28	74.00	-26.72	Peak	
2	2387.0000	32.93	6.53	39.46	54.00	-14.54	AVG	
3	2390.0000	39.26	6.53	45.79	74.00	-28.21	Peak	
4	2390.0000	30.69	6.53	37.22	54.00	-16.78	AVG	
5 *	2412.8500	90.61	6.51	97.12	54.00	43.12	AVG	No Limit
6	2412.9500	92.49	6.51	99.00	74.00	25.00	Peak	No Limit

REMARKS:

- (1) Measurement Value = Reading Level + Correct Factor.
- (2) Margin Level = Measurement Value - Limit Value.

Orthogonal Axis	X
Test Mode:	TX B Mode 2412 MHz

Horizontal

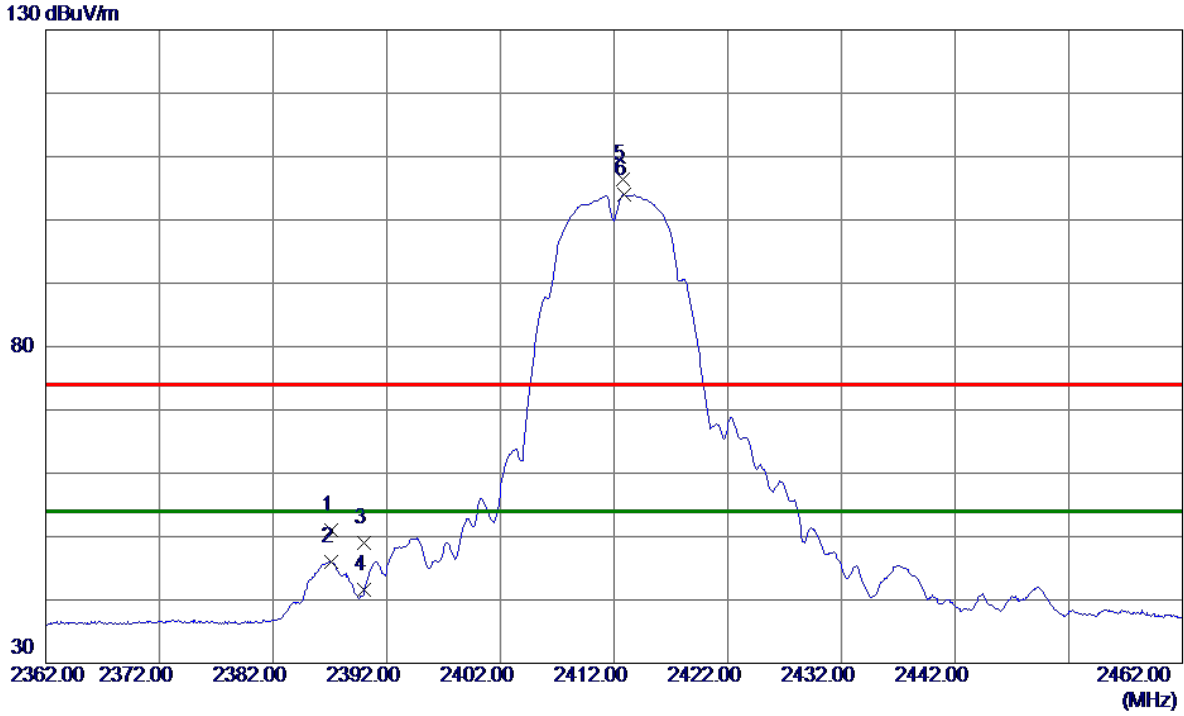

No.	Freq. MHz	Reading Level dBuV/m	Correct Factor dB	Measure ment dBuV/m	Limit dBuV/m	Margin dB	Detector	Comment
1	2387.1500	44.48	6.53	51.01	74.00	-22.99	Peak	
2	2387.1500	39.44	6.53	45.97	54.00	-8.03	AVG	
3	2390.0000	42.52	6.53	49.05	74.00	-24.95	Peak	
4	2390.0000	35.10	6.53	41.63	54.00	-12.37	AVG	
5	2412.8000	99.98	6.51	106.49	74.00	32.49	Peak	No Limit
6 *	2412.8500	97.58	6.51	104.09	54.00	50.09	AVG	No Limit

REMARKS:

- (1) Measurement Value = Reading Level + Correct Factor.
- (2) Margin Level = Measurement Value - Limit Value.

Orthogonal Axis	X
Test Mode:	TX B Mode 2437 MHz

Vertical

130 dBuV/m

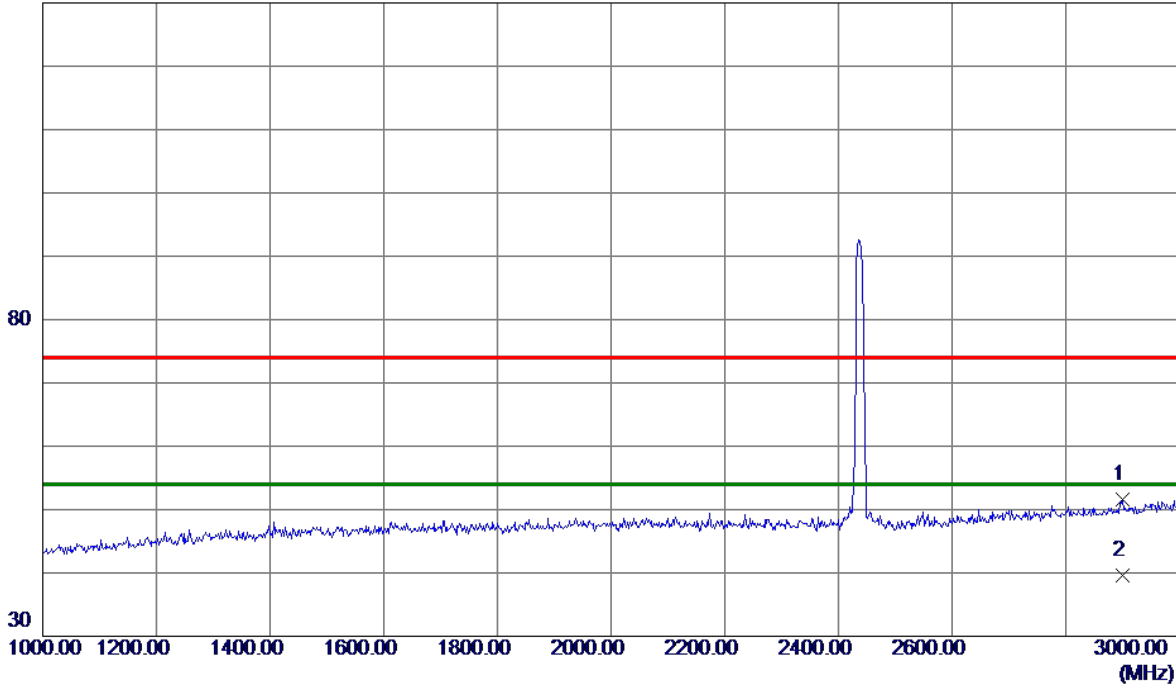

No.	Freq. MHz	Reading Level dBuV/m	Correct Factor dB	Measure ment dBuV/m	Limit dBuV/m	Margin dB	Detector	Comment
1	2900.0000	41.59	9.93	51.52	74.00	-22.48	Peak	
2 *	2900.0000	29.64	9.93	39.57	54.00	-14.43	AVG	

REMARKS:

- (1) Measurement Value = Reading Level + Correct Factor.
- (2) Margin Level = Measurement Value - Limit Value.

Orthogonal Axis	X
Test Mode:	TX B Mode 2437 MHz

Vertical

130 dBuV/m

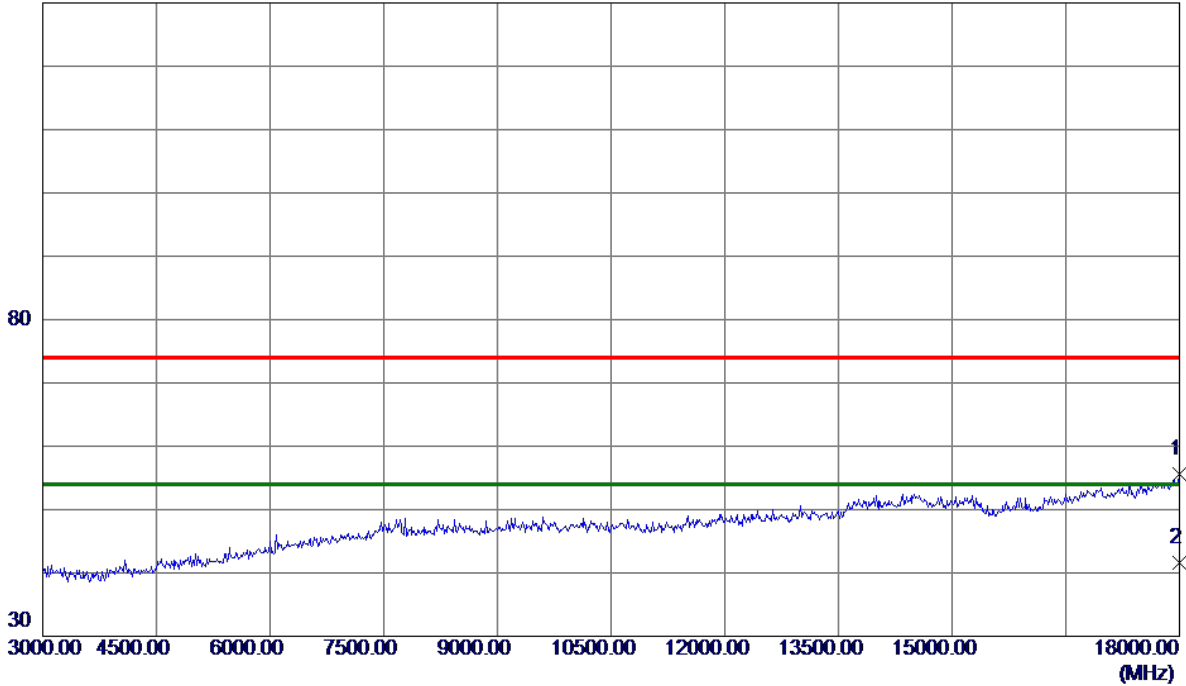

No.	Freq. MHz	Reading Level dBuV/m	Correct Factor dB	Measure ment dBuV/m	Limit dBuV/m	Margin dB	Detector	Comment
1	18000.0000	32.85	22.67	55.52	74.00	-18.48	Peak	
2 *	18000.0000	18.96	22.67	41.63	54.00	-12.37	AVG	

REMARKS:

- (1) Measurement Value = Reading Level + Correct Factor.
- (2) Margin Level = Measurement Value - Limit Value.

Orthogonal Axis	X
Test Mode:	TX B Mode 2437 MHz

Vertical

130 dBuV/m

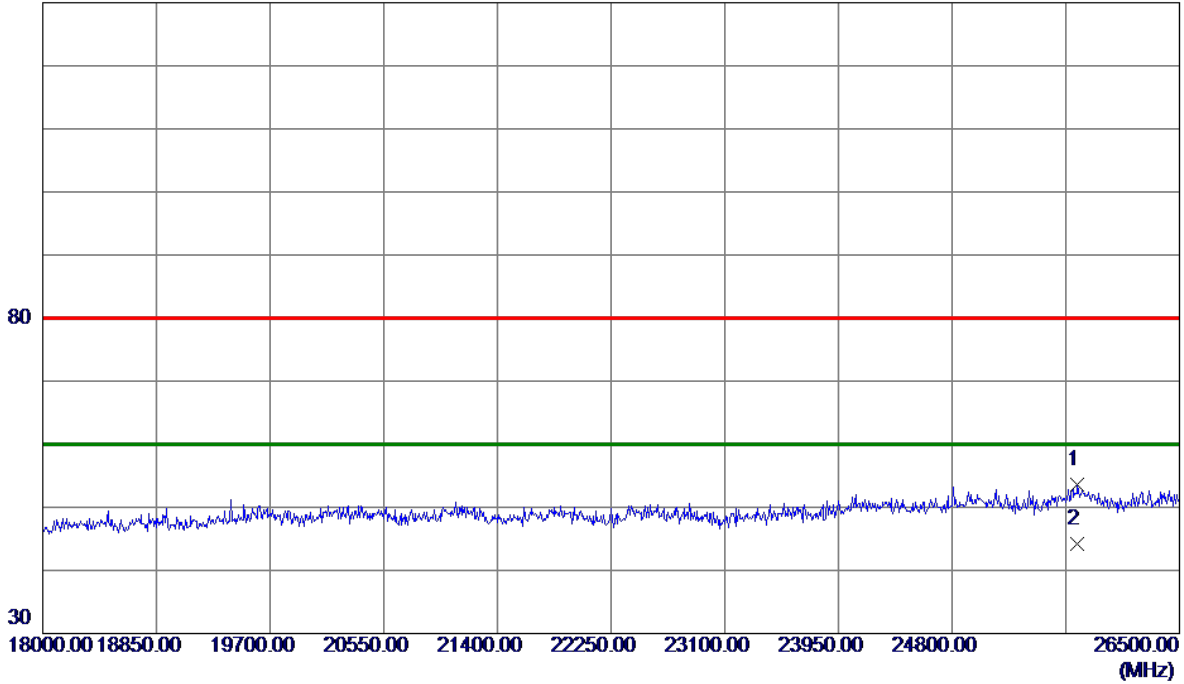

No.	Freq. MHz	Reading Level dBuV/m	Correct Factor dB	Measure ment dBuV/m	Limit dBuV/m	Margin dB	Detector	Comment
1	25739.2500	35.95	17.74	53.69	80.00	-26.31	Peak	
2 *	25739.2500	26.39	17.74	44.13	60.00	-15.87	AVG	

REMARKS:

- (1) Measurement Value = Reading Level + Correct Factor.
- (2) Margin Level = Measurement Value - Limit Value.

Orthogonal Axis	X
Test Mode:	TX B Mode 2437 MHz

Horizontal

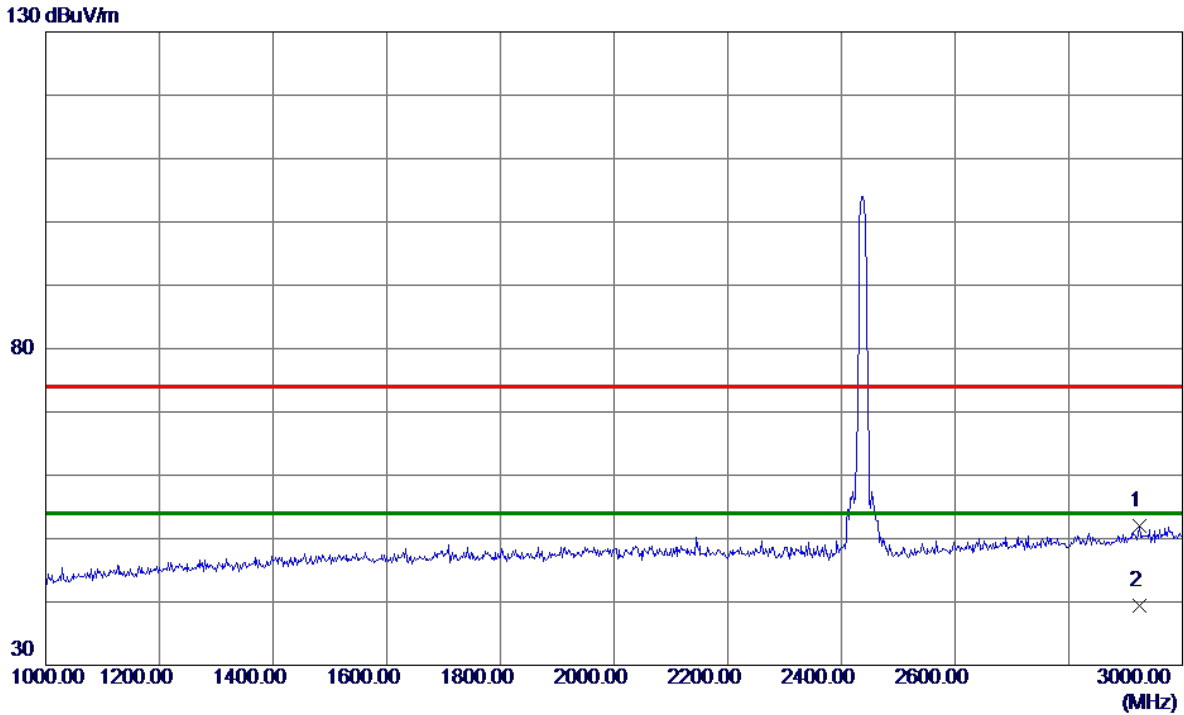

No.	Freq. MHz	Reading Level dBuV/m	Correct Factor dB	Measure ment dBuV/m	Limit dBuV/m	Margin dB	Detector	Comment
1	2924.0000	41.81	10.10	51.91	74.00	-22.09	Peak	
2 *	2924.0000	29.35	10.10	39.45	54.00	-14.55	AVG	

REMARKS:

(1) Measurement Value = Reading Level + Correct Factor.

(2) Margin Level = Measurement Value - Limit Value.

Orthogonal Axis	X
Test Mode:	TX B Mode 2437 MHz

Horizontal

130 dBuV/m

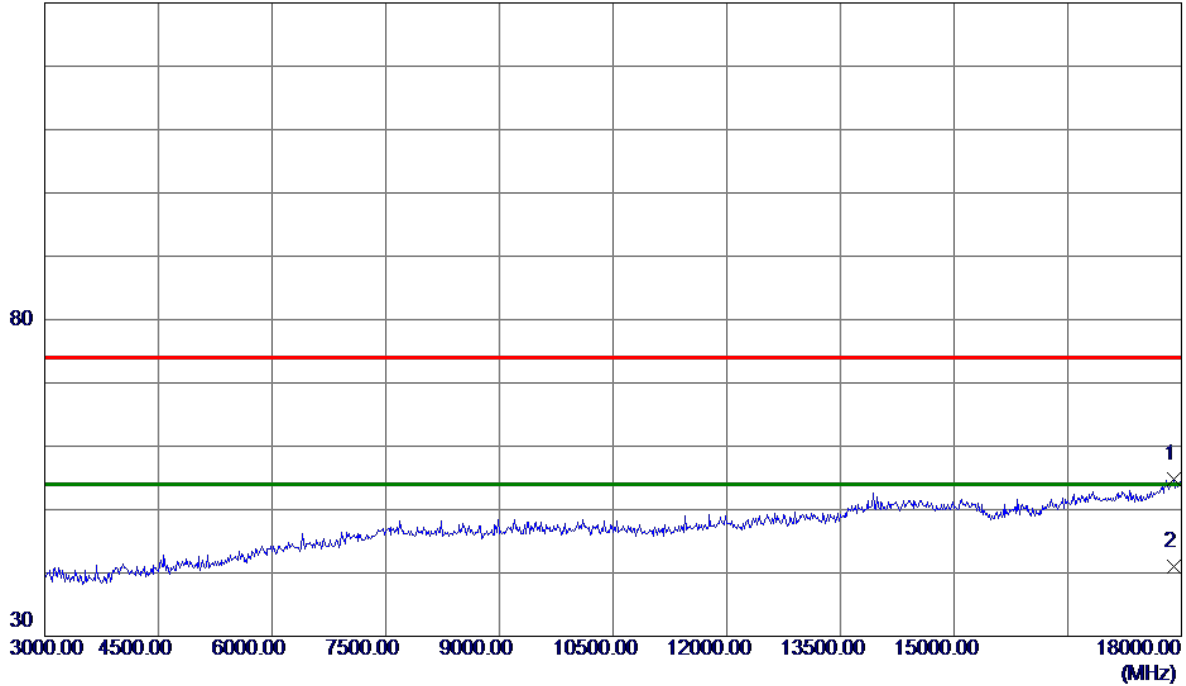

No.	Freq. MHz	Reading Level dBuV/m	Correct Factor dB	Measure ment dBuV/m	Limit dBuV/m	Margin dB	Detector	Comment
1	17895.0000	32.40	22.32	54.72	74.00	-19.28	Peak	
2 *	17895.0000	18.66	22.32	40.98	54.00	-13.02	AVG	

REMARKS:

(1) Measurement Value = Reading Level + Correct Factor.

(2) Margin Level = Measurement Value - Limit Value.

Orthogonal Axis	X
Test Mode:	TX B Mode 2437 MHz

Horizontal

130 dBuV/m

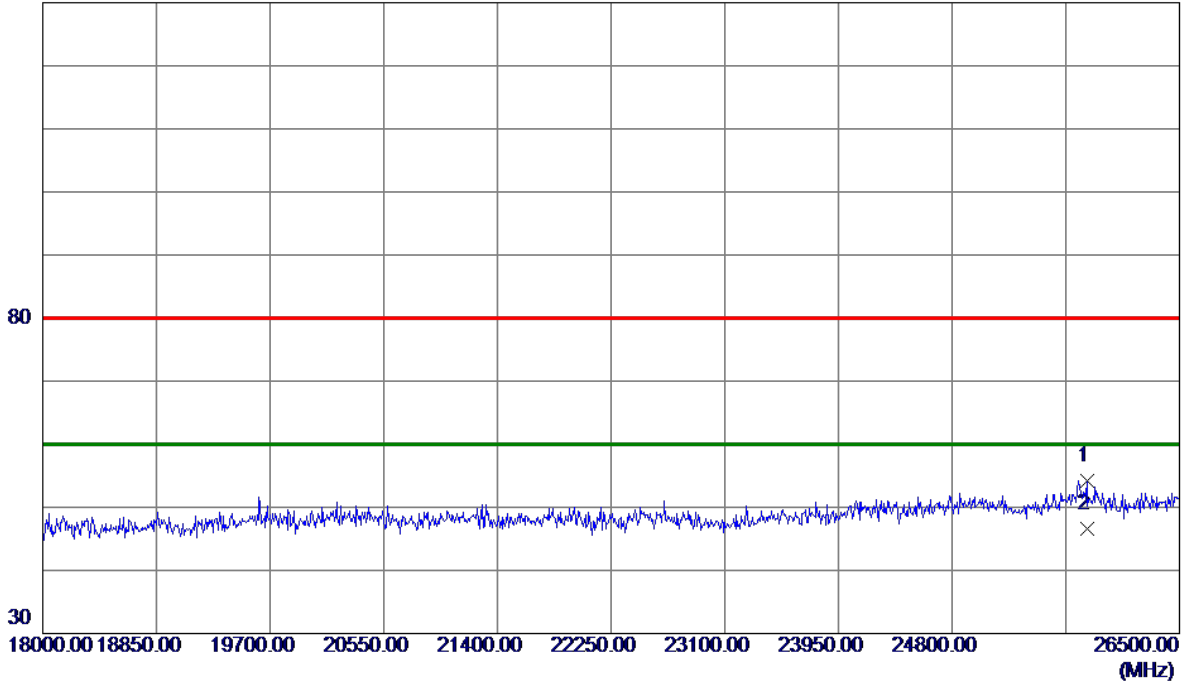

No.	Freq. MHz	Reading Level dBuV/m	Correct Factor dB	Measure ment dBuV/m	Limit dBuV/m	Margin dB	Detector	Comment
1	25807.2500	36.47	17.72	54.19	80.00	-25.81	Peak	
2 *	25807.2500	28.84	17.72	46.56	60.00	-13.44	AVG	

REMARKS:

(1) Measurement Value = Reading Level + Correct Factor.

(2) Margin Level = Measurement Value - Limit Value.

Orthogonal Axis	X
Test Mode:	TX B Mode 2462 MHz

Vertical

130 dBuV/m

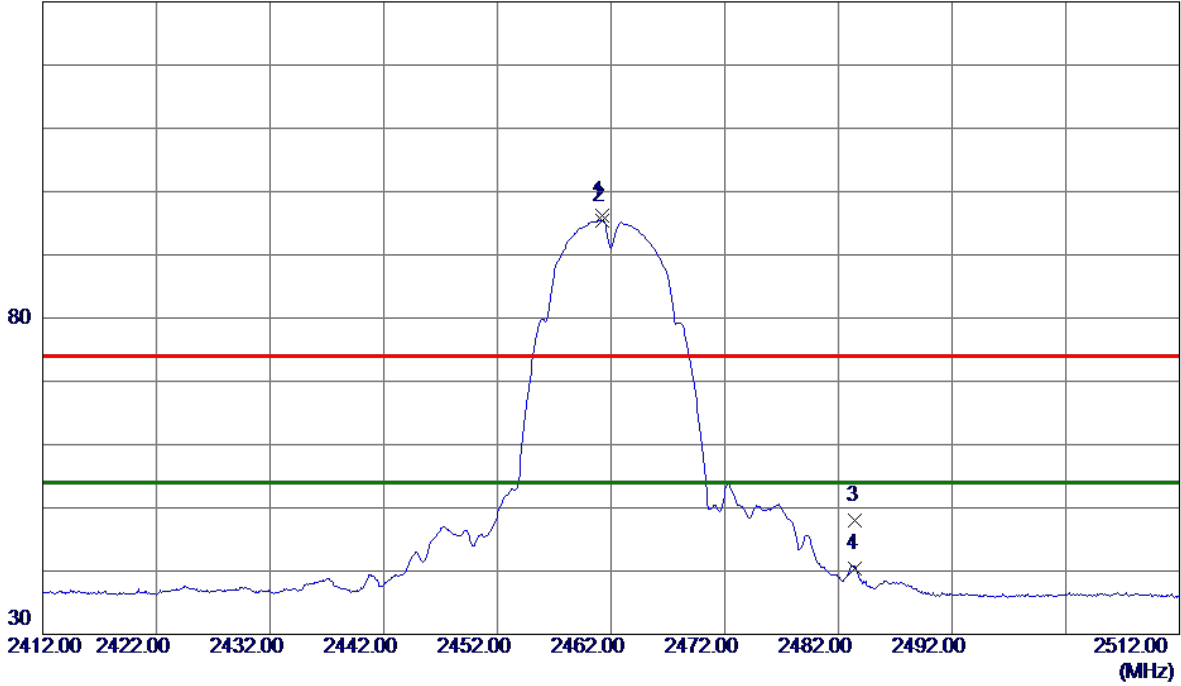

No.	Freq. MHz	Reading Level dBuV/m	Correct Factor dB	Measure ment dBuV/m	Limit dBuV/m	Margin dB	Detector	Comment
1	2461.2000	89.77	6.45	96.22	74.00	22.22	Peak	No Limit
2 *	2461.2500	89.00	6.45	95.45	54.00	41.45	AVG	No Limit
3	2483.5000	41.59	6.42	48.01	74.00	-25.99	Peak	
4	2483.5000	33.98	6.42	40.40	54.00	-13.60	AVG	

REMARKS:

- (1) Measurement Value = Reading Level + Correct Factor.
- (2) Margin Level = Measurement Value - Limit Value.

Orthogonal Axis	X
Test Mode:	TX B Mode 2462 MHz

Horizontal

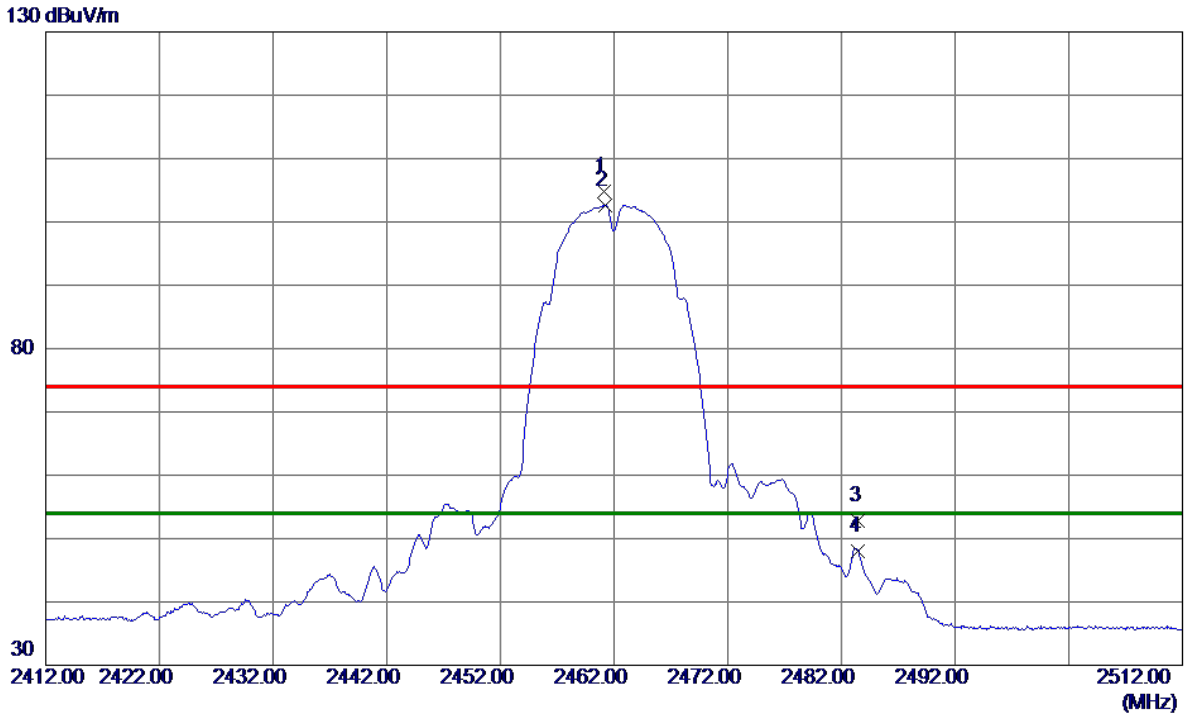

No.	Freq. MHz	Reading Level dBuV/m	Correct Factor dB	Measure ment dBuV/m	Limit dBuV/m	Margin dB	Detector	Comment
1	2461.1500	98.41	6.45	104.86	74.00	30.86	Peak	No Limit
2 *	2461.2500	96.23	6.45	102.68	54.00	48.68	AVG	No Limit
3	2483.5000	46.45	6.42	52.87	74.00	-21.13	Peak	
4	2483.5000	41.51	6.42	47.93	54.00	-6.07	AVG	

REMARKS:

- (1) Measurement Value = Reading Level + Correct Factor.
- (2) Margin Level = Measurement Value - Limit Value.

Orthogonal Axis	X
Test Mode:	TX G Mode 2412 MHz

Vertical

130 dBuV/m

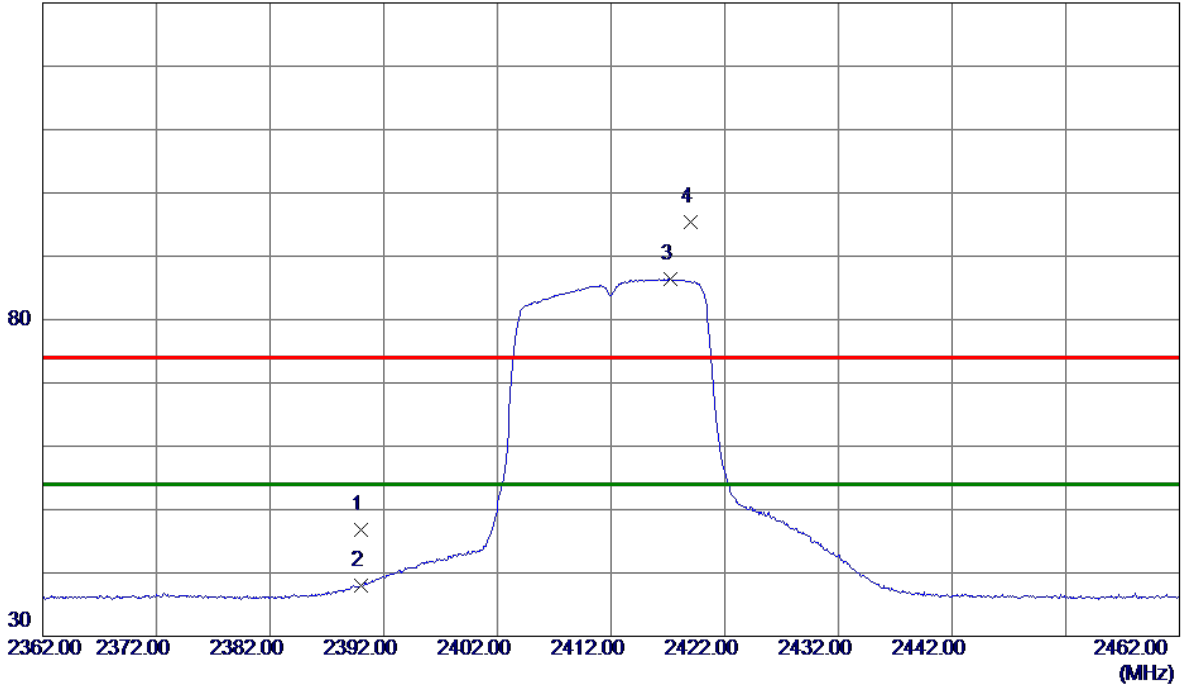

No.	Freq. MHz	Reading Level dBuV/m	Correct Factor dB	Measure ment dBuV/m	Limit dBuV/m	Margin dB	Detector	Comment
1	2390.0000	40.24	6.53	46.77	74.00	-27.23	Peak	
2	2390.0000	31.54	6.53	38.07	54.00	-15.93	AVG	
3 *	2417.2500	79.82	6.50	86.32	54.00	32.32	AVG	No Limit
4	2419.0000	88.87	6.50	95.37	74.00	21.37	Peak	No Limit

REMARKS:

- (1) Measurement Value = Reading Level + Correct Factor.
- (2) Margin Level = Measurement Value - Limit Value.

Orthogonal Axis	X
Test Mode:	TX G Mode 2412 MHz

Horizontal

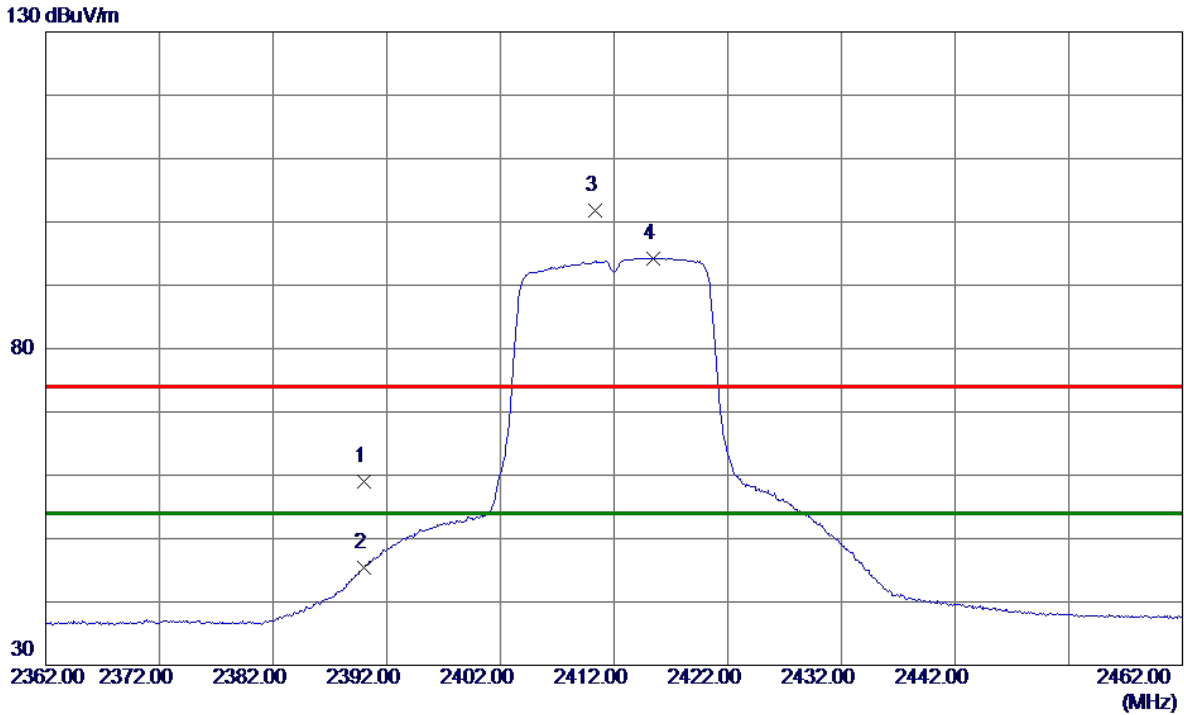

No.	Freq. MHz	Reading Level dBuV/m	Correct Factor dB	Measure ment dBuV/m	Limit dBuV/m	Margin dB	Detector	Comment
1	2390.0000	52.06	7.01	59.07	74.00	-14.93	Peak	
2	2390.0000	38.48	7.01	45.49	54.00	-8.51	AVG	
3	2410.3000	94.75	7.02	101.77	74.00	27.77	Peak	No Limit
4 *	2415.4000	87.27	7.02	94.29	54.00	40.29	AVG	No Limit

REMARKS:

- (1) Measurement Value = Reading Level + Correct Factor.
- (2) Margin Level = Measurement Value - Limit Value.

Orthogonal Axis	X
Test Mode:	TX G Mode 2437 MHz

Vertical

130 dBuV/m

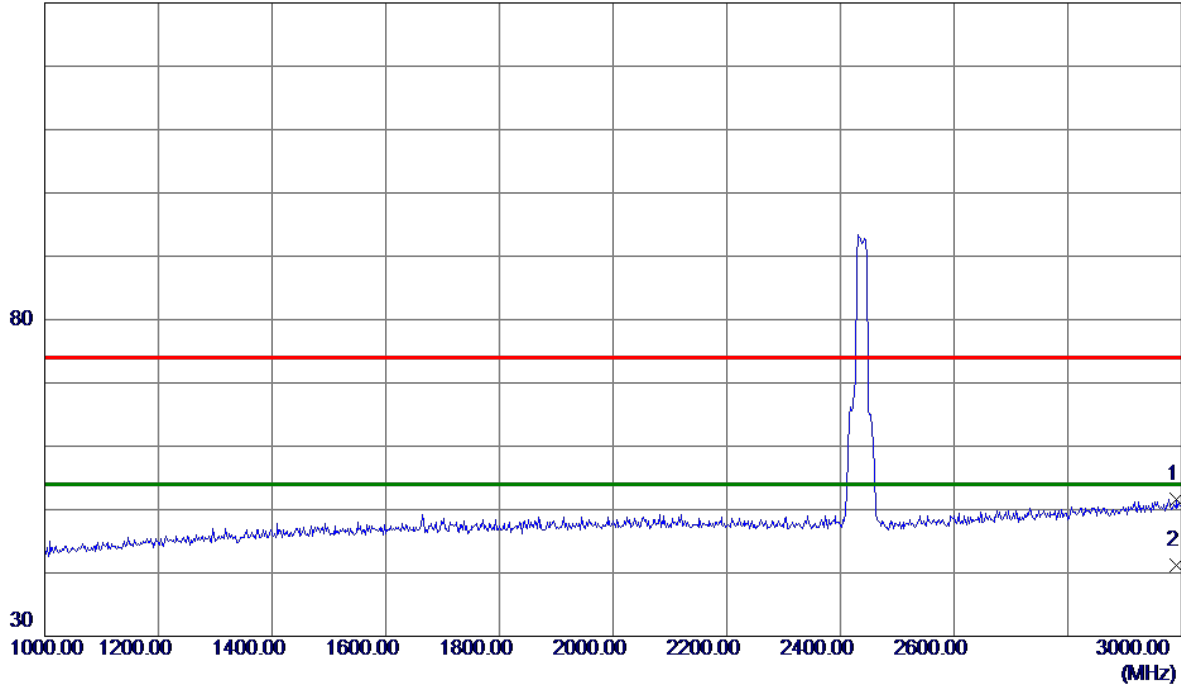

No.	Freq. MHz	Reading Level dBuV/m	Correct Factor dB	Measure ment dBuV/m	Limit dBuV/m	Margin dB	Detector	Comment
1	2992.0000	40.99	10.59	51.58	74.00	-22.42	Peak	
2 *	2992.0000	30.52	10.59	41.11	54.00	-12.89	AVG	

REMARKS:

- (1) Measurement Value = Reading Level + Correct Factor.
- (2) Margin Level = Measurement Value - Limit Value.

Orthogonal Axis	X
Test Mode:	TX G Mode 2437 MHz

Vertical

130 dBuV/m

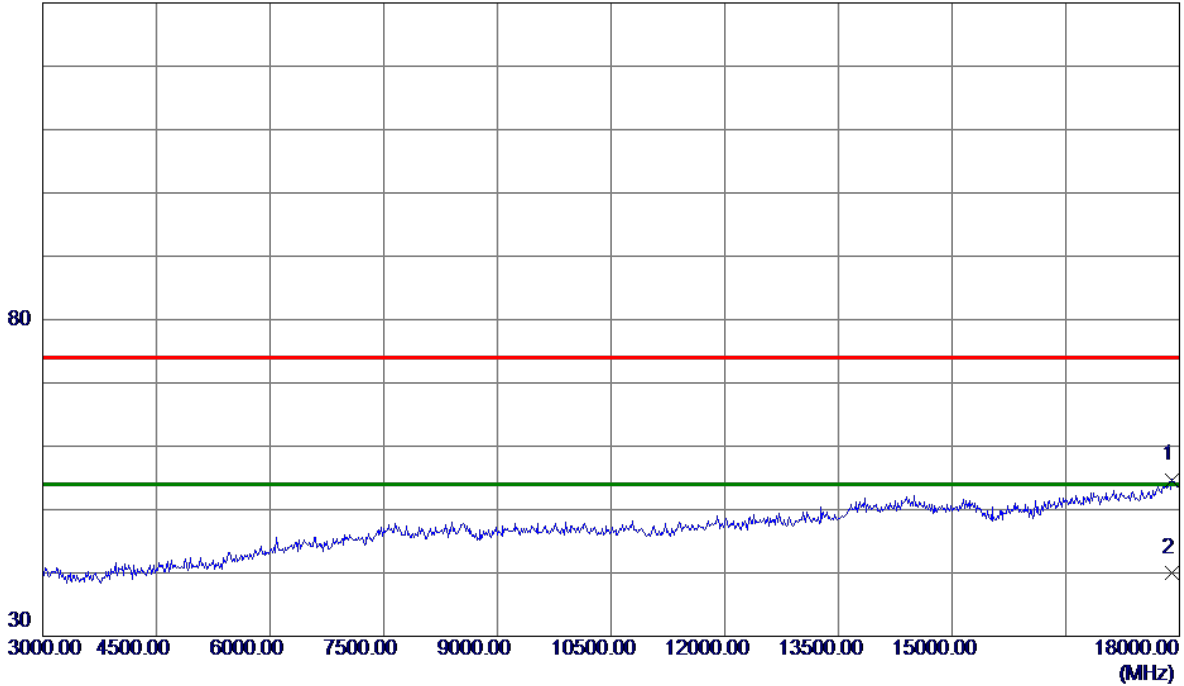

No.	Freq. MHz	Reading Level dBuV/m	Correct Factor dB	Measure ment dBuV/m	Limit dBuV/m	Margin dB	Detector	Comment
1	17895.0000	32.38	22.32	54.70	74.00	-19.30	Peak	
2 *	17895.0000	17.69	22.32	40.01	54.00	-13.99	AVG	

REMARKS:

- (1) Measurement Value = Reading Level + Correct Factor.
- (2) Margin Level = Measurement Value - Limit Value.

Orthogonal Axis	X
Test Mode:	TX G Mode 2437 MHz

Vertical

130 dBuV/m

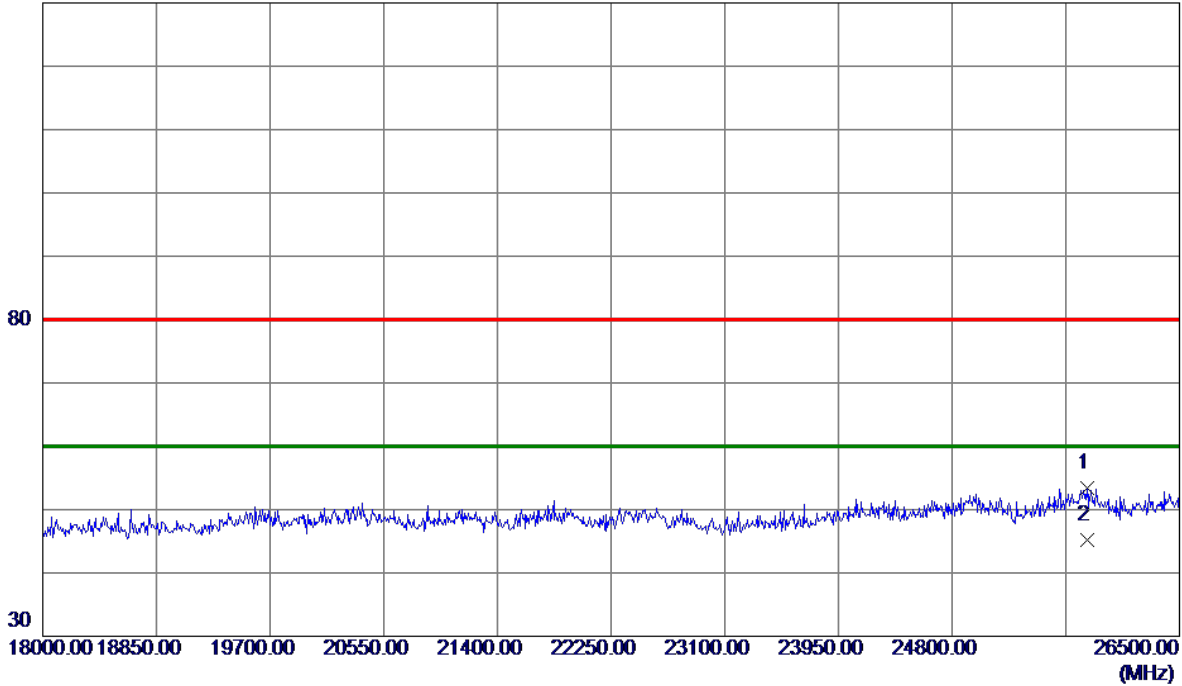

No.	Freq. MHz	Reading Level dBuV/m	Correct Factor dB	Measure ment dBuV/m	Limit dBuV/m	Margin dB	Detector	Comment
1	25807.2500	35.69	17.72	53.41	80.00	-26.59	Peak	
2 *	25807.2500	27.48	17.72	45.20	60.00	-14.80	AVG	

REMARKS:

- (1) Measurement Value = Reading Level + Correct Factor.
- (2) Margin Level = Measurement Value - Limit Value.

Orthogonal Axis	X
Test Mode:	TX G Mode 2437 MHz

Horizontal

130 dBuV/m

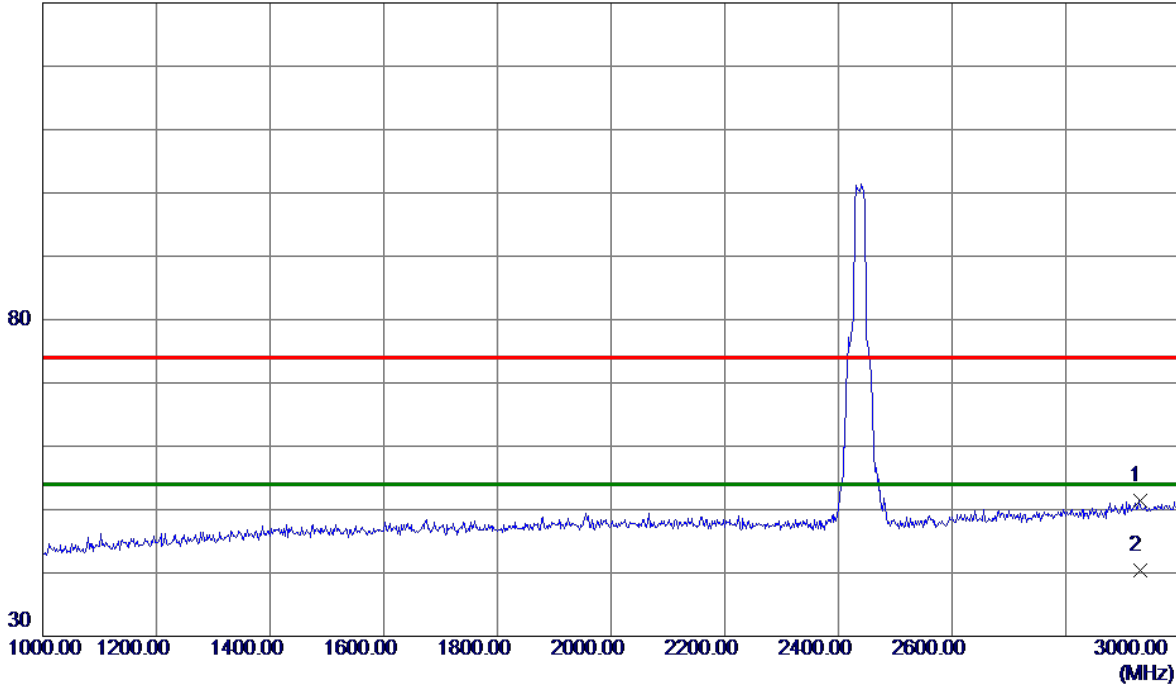

No.	Freq. MHz	Reading Level dBuV/m	Correct Factor dB	Measure ment dBuV/m	Limit dBuV/m	Margin dB	Detector	Comment
1	2930.0000	41.19	10.14	51.33	74.00	-22.67	Peak	
2 *	2930.0000	30.26	10.14	40.40	54.00	-13.60	AVG	

REMARKS:

(1) Measurement Value = Reading Level + Correct Factor.

(2) Margin Level = Measurement Value - Limit Value.

Orthogonal Axis	X
Test Mode:	TX G Mode 2437 MHz

Horizontal

130 dBuV/m

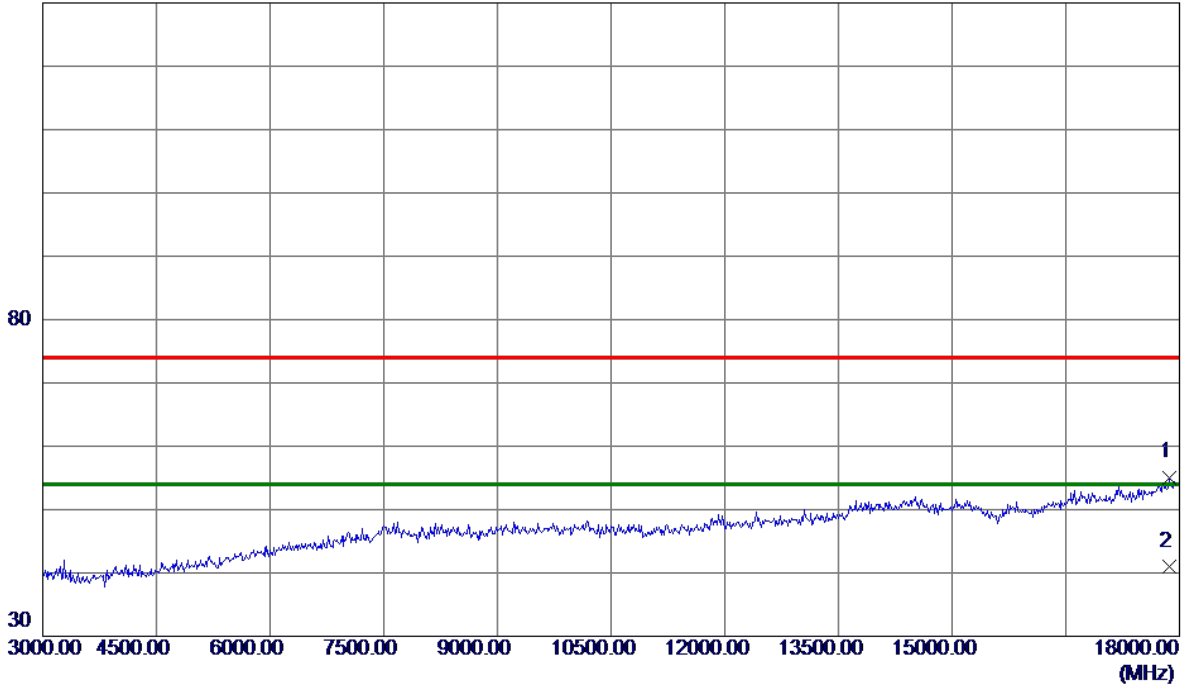

No.	Freq. MHz	Reading Level dBuV/m	Correct Factor dB	Measure ment dBuV/m	Limit dBuV/m	Margin dB	Detector	Comment
1	17865.0000	32.88	22.22	55.10	74.00	-18.90	Peak	
2 *	17865.0000	18.69	22.22	40.91	54.00	-13.09	AVG	

REMARKS:

(1) Measurement Value = Reading Level + Correct Factor.

(2) Margin Level = Measurement Value - Limit Value.

Orthogonal Axis	X
Test Mode:	TX G Mode 2437 MHz

Horizontal

130 dBuV/m

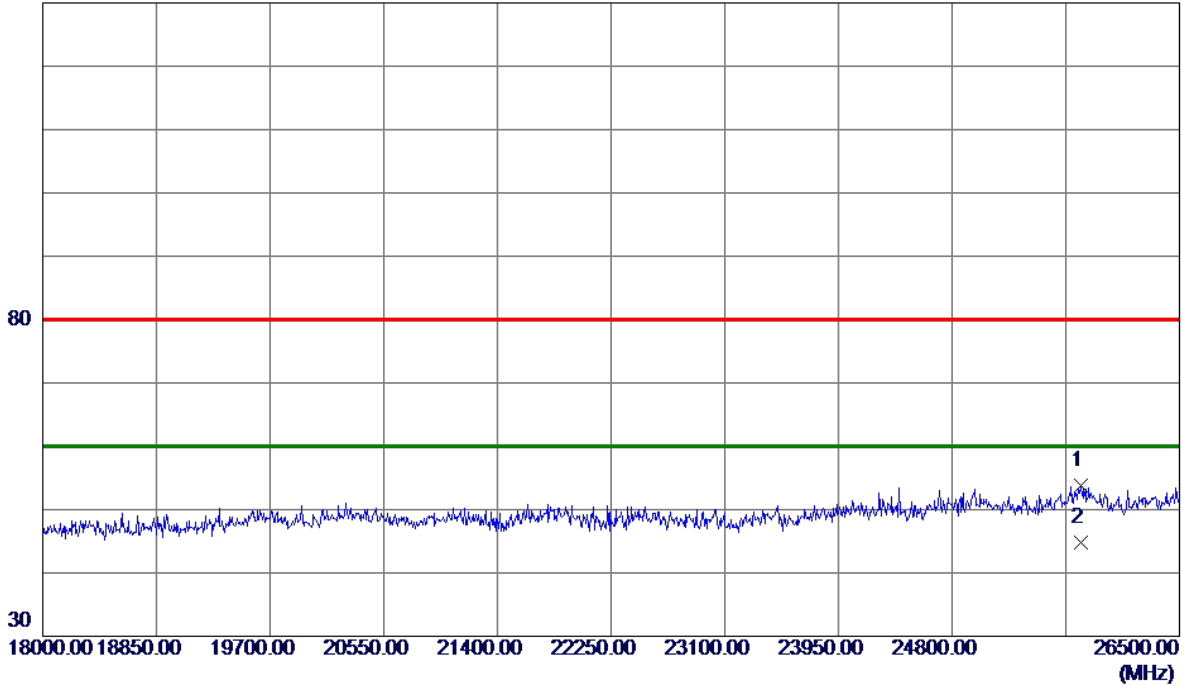

No.	Freq. MHz	Reading Level dBuV/m	Correct Factor dB	Measure ment dBuV/m	Limit dBuV/m	Margin dB	Detector	Comment
1	25764.7500	36.04	17.73	53.77	80.00	-26.23	Peak	
2 *	25764.7500	27.12	17.73	44.85	60.00	-15.15	AVG	

REMARKS:

(1) Measurement Value = Reading Level + Correct Factor.

(2) Margin Level = Measurement Value - Limit Value.

Orthogonal Axis	X
Test Mode:	TX G Mode 2462 MHz

Vertical

130 dBuV/m

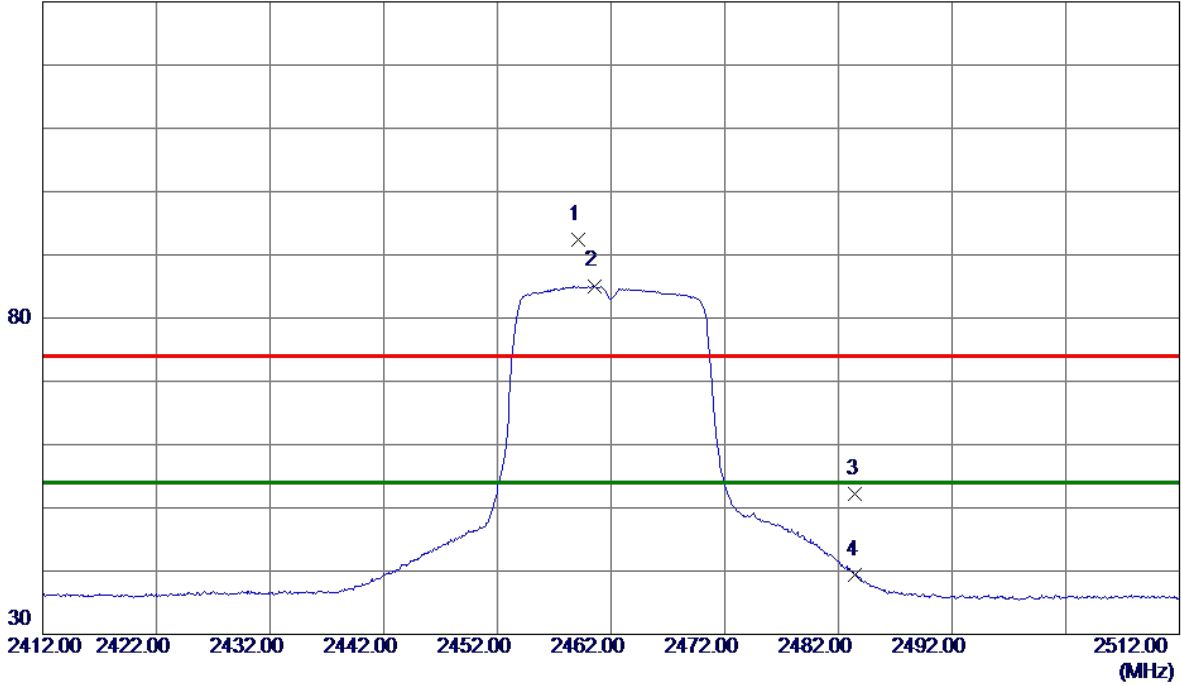

No.	Freq. MHz	Reading Level dBuV/m	Correct Factor dB	Measure ment dBuV/m	Limit dBuV/m	Margin dB	Detector	Comment
1	2459.1000	86.03	6.45	92.48	74.00	18.48	Peak	No Limit
2 *	2460.5500	78.65	6.45	85.10	54.00	31.10	AVG	No Limit
3	2483.5000	45.71	6.42	52.13	74.00	-21.87	Peak	
4	2483.5000	32.91	6.42	39.33	54.00	-14.67	AVG	

REMARKS:

- (1) Measurement Value = Reading Level + Correct Factor.
- (2) Margin Level = Measurement Value - Limit Value.

Orthogonal Axis	X
Test Mode:	TX G Mode 2462 MHz

Horizontal

130 dBuV/m

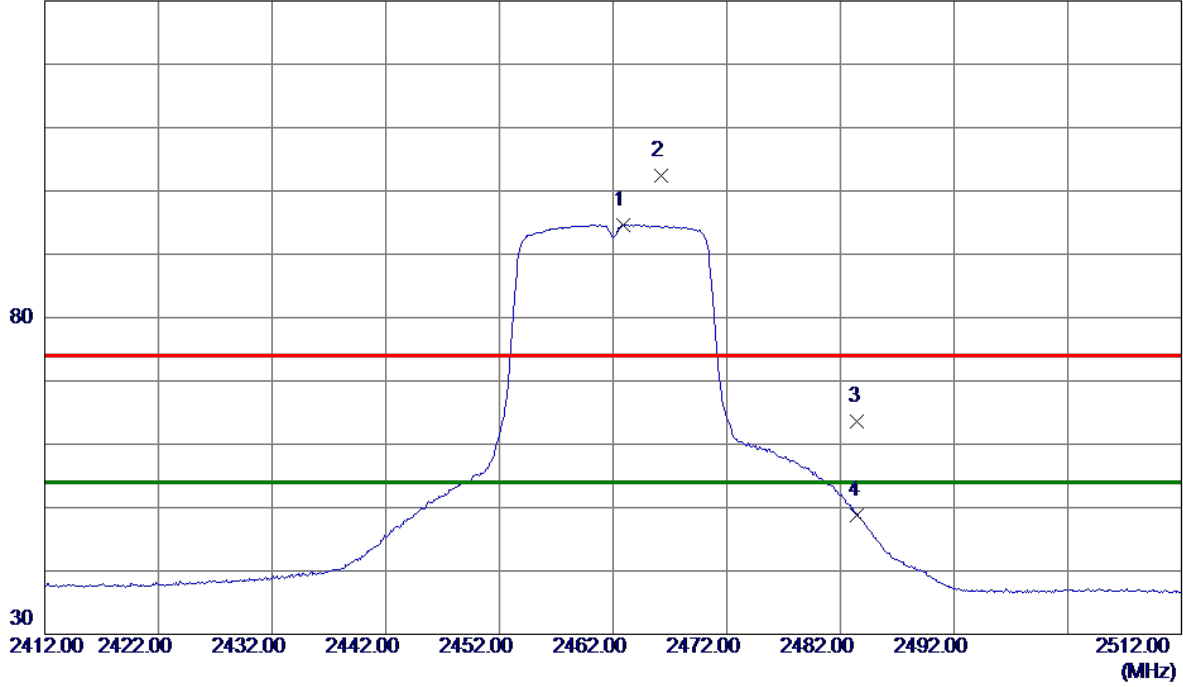

No.	Freq. MHz	Reading Level dBuV/m	Correct Factor dB	Measure ment dBuV/m	Limit dBuV/m	Margin dB	Detector	Comment
1 *	2462.9000	87.58	7.03	94.61	54.00	40.61	AVG	No Limit
2	2466.2000	95.38	7.03	102.41	74.00	28.41	Peak	No Limit
3	2483.5000	56.56	7.03	63.59	74.00	-10.41	Peak	
4	2483.5000	41.79	7.03	48.82	54.00	-5.18	AVG	

REMARKS:

- (1) Measurement Value = Reading Level + Correct Factor.
- (2) Margin Level = Measurement Value - Limit Value.

Orthogonal Axis	X
Test Mode:	TX N-20M Mode 2412 MHz

Vertical

130 dBuV/m

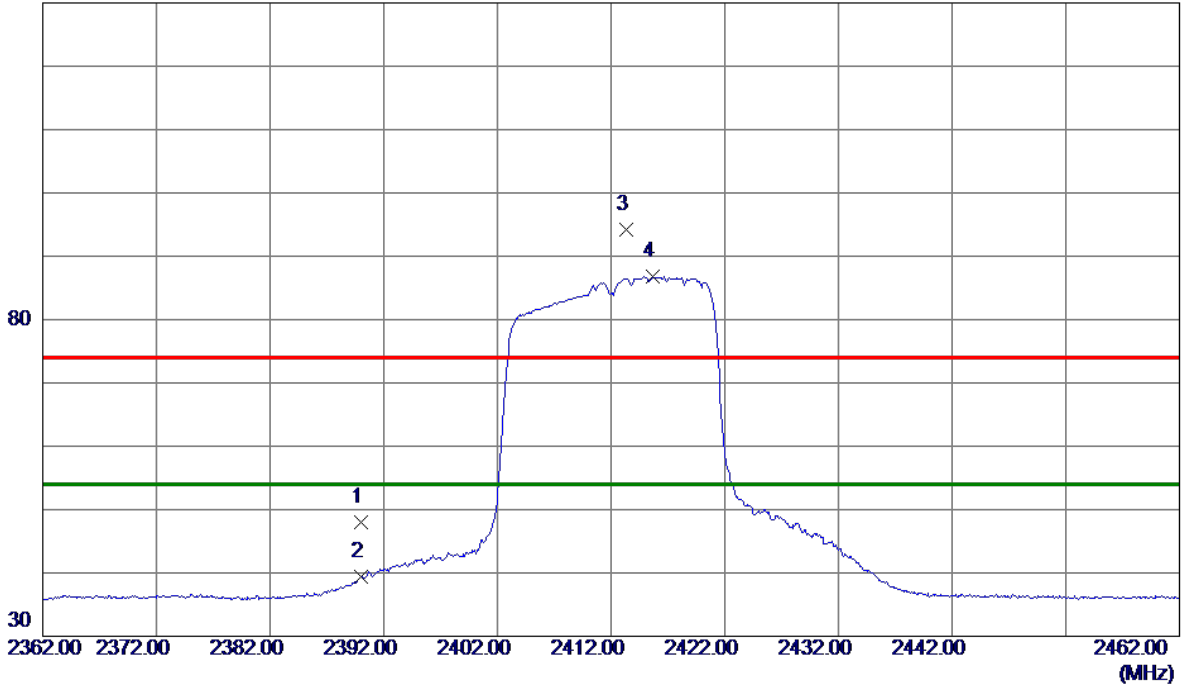

No.	Freq. MHz	Reading Level dBuV/m	Correct Factor dB	Measure ment dBuV/m	Limit dBuV/m	Margin dB	Detector	Comment
1	2390.0000	41.51	6.53	48.04	74.00	-25.96	Peak	
2	2390.0000	32.85	6.53	39.38	54.00	-14.62	AVG	
3	2413.3000	87.63	6.50	94.13	74.00	20.13	Peak	No Limit
4 *	2415.7000	80.33	6.50	86.83	54.00	32.83	AVG	No Limit

REMARKS:

- (1) Measurement Value = Reading Level + Correct Factor.
- (2) Margin Level = Measurement Value - Limit Value.

Orthogonal Axis	X
Test Mode:	TX N-20M Mode 2412 MHz

Horizontal

130 dBuV/m

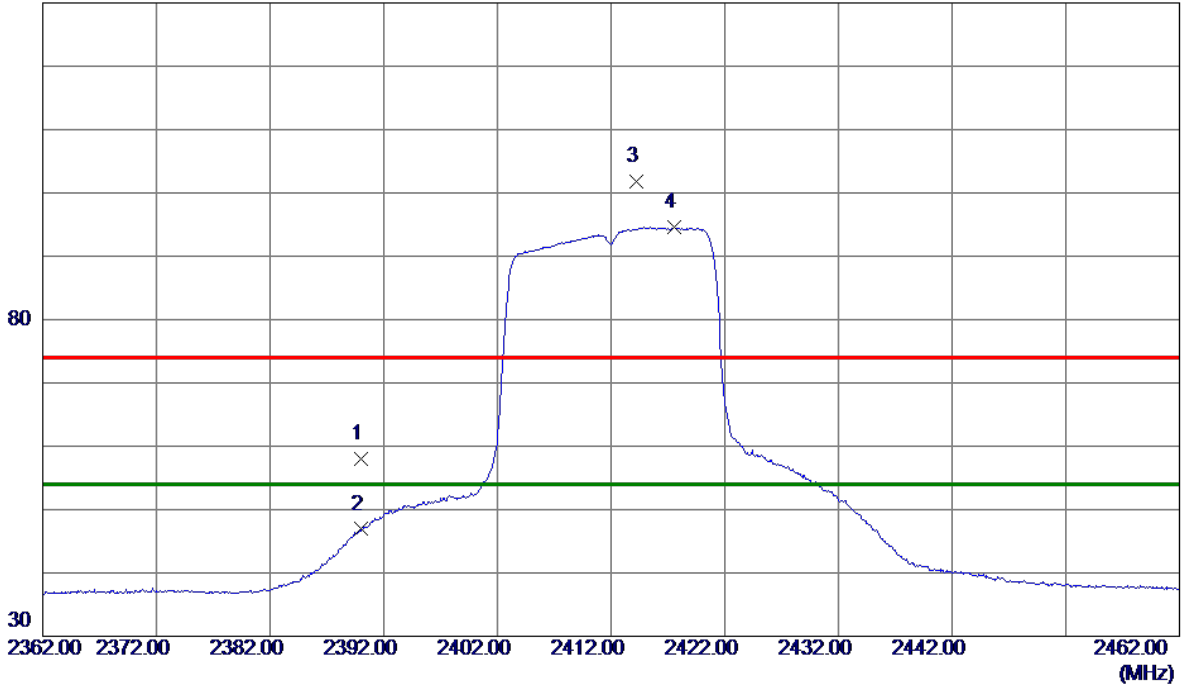

No.	Freq. MHz	Reading Level dBuV/m	Correct Factor dB	Measure ment dBuV/m	Limit dBuV/m	Margin dB	Detector	Comment
1	2390.0000	50.99	7.01	58.00	74.00	-16.00	Peak	
2	2390.0000	39.89	7.01	46.90	54.00	-7.10	AVG	
3	2414.2500	94.78	7.02	101.80	74.00	27.80	Peak	No Limit
4 *	2417.5500	87.55	7.02	94.57	54.00	40.57	AVG	No Limit

REMARKS:

- (1) Measurement Value = Reading Level + Correct Factor.
- (2) Margin Level = Measurement Value - Limit Value.

Orthogonal Axis	X
Test Mode:	TX N-20M Mode 2437 MHz

Vertical

130 dBuV/m

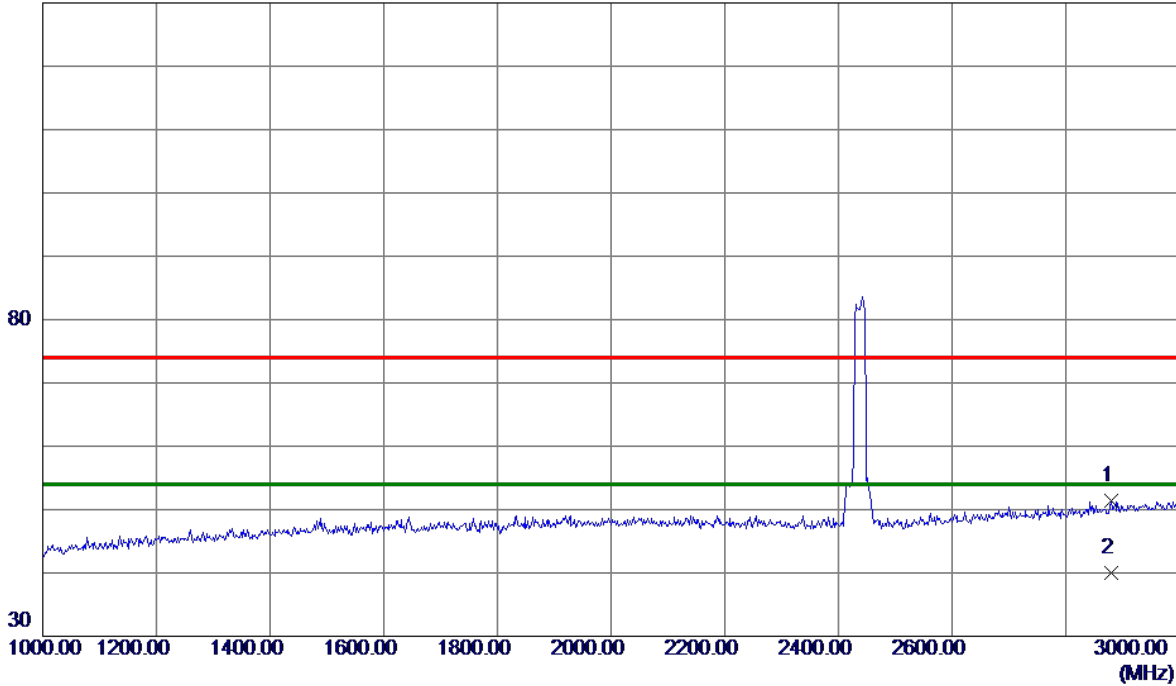

No.	Freq. MHz	Reading Level dBuV/m	Correct Factor dB	Measure ment dBuV/m	Limit dBuV/m	Margin dB	Detector	Comment
1	2880.0000	41.61	9.78	51.39	74.00	-22.61	Peak	
2 *	2880.0000	30.26	9.78	40.04	54.00	-13.96	AVG	

REMARKS:

- (1) Measurement Value = Reading Level + Correct Factor.
- (2) Margin Level = Measurement Value - Limit Value.

Orthogonal Axis	X
Test Mode:	TX N-20M Mode 2437 MHz

Vertical

130 dBuV/m

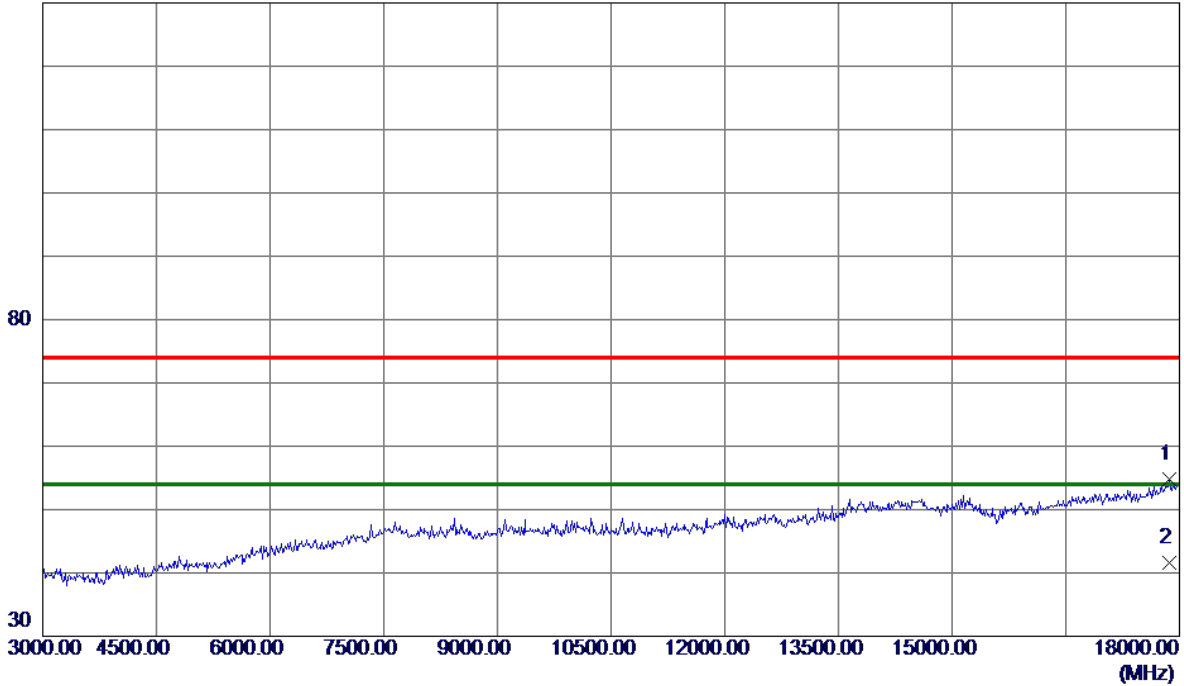

No.	Freq. MHz	Reading Level dBuV/m	Correct Factor dB	Measure ment dBuV/m	Limit dBuV/m	Margin dB	Detector	Comment
1	17865.0000	32.51	22.22	54.73	74.00	-19.27	Peak	
2 *	17865.0000	19.36	22.22	41.58	54.00	-12.42	AVG	

REMARKS:

- (1) Measurement Value = Reading Level + Correct Factor.
- (2) Margin Level = Measurement Value - Limit Value.

Orthogonal Axis	X
Test Mode:	TX N-20M Mode 2437 MHz

Vertical

130 dBuV/m

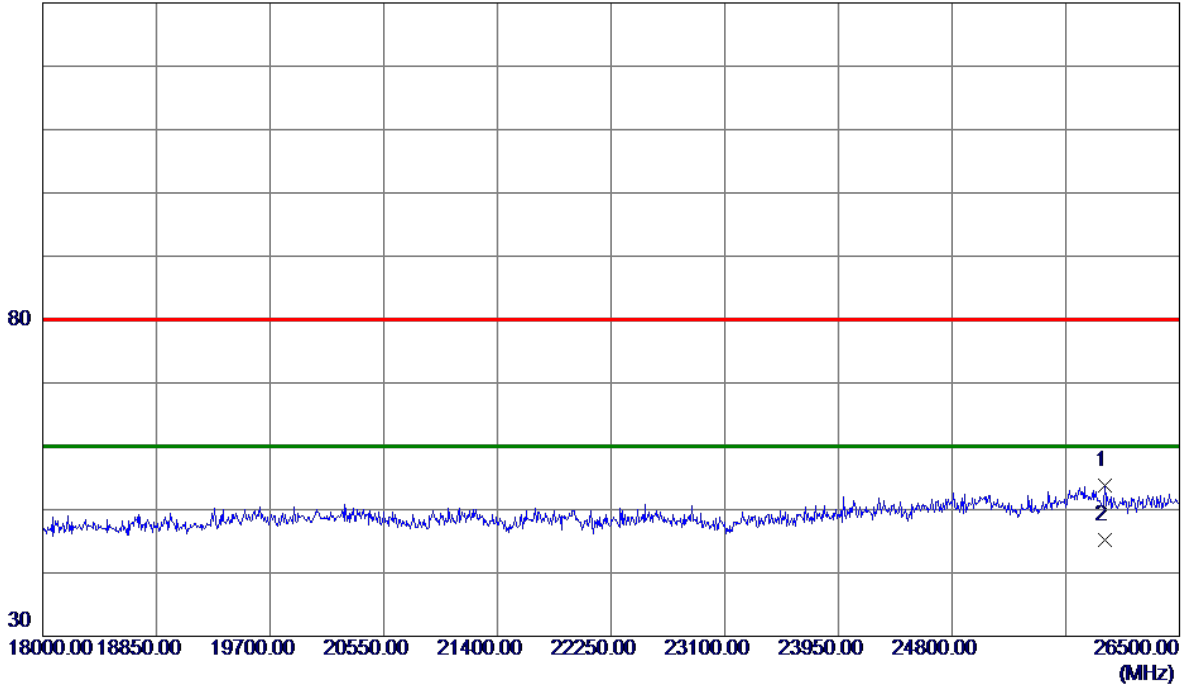

No.	Freq. MHz	Reading Level dBuV/m	Correct Factor dB	Measure ment dBuV/m	Limit dBuV/m	Margin dB	Detector	Comment
1	25943.2500	36.19	17.67	53.86	80.00	-26.14	Peak	
2 *	25943.2500	27.62	17.67	45.29	60.00	-14.71	AVG	

REMARKS:

- (1) Measurement Value = Reading Level + Correct Factor.
- (2) Margin Level = Measurement Value - Limit Value.

Orthogonal Axis	X
Test Mode:	TX N-20M Mode 2437 MHz

Horizontal

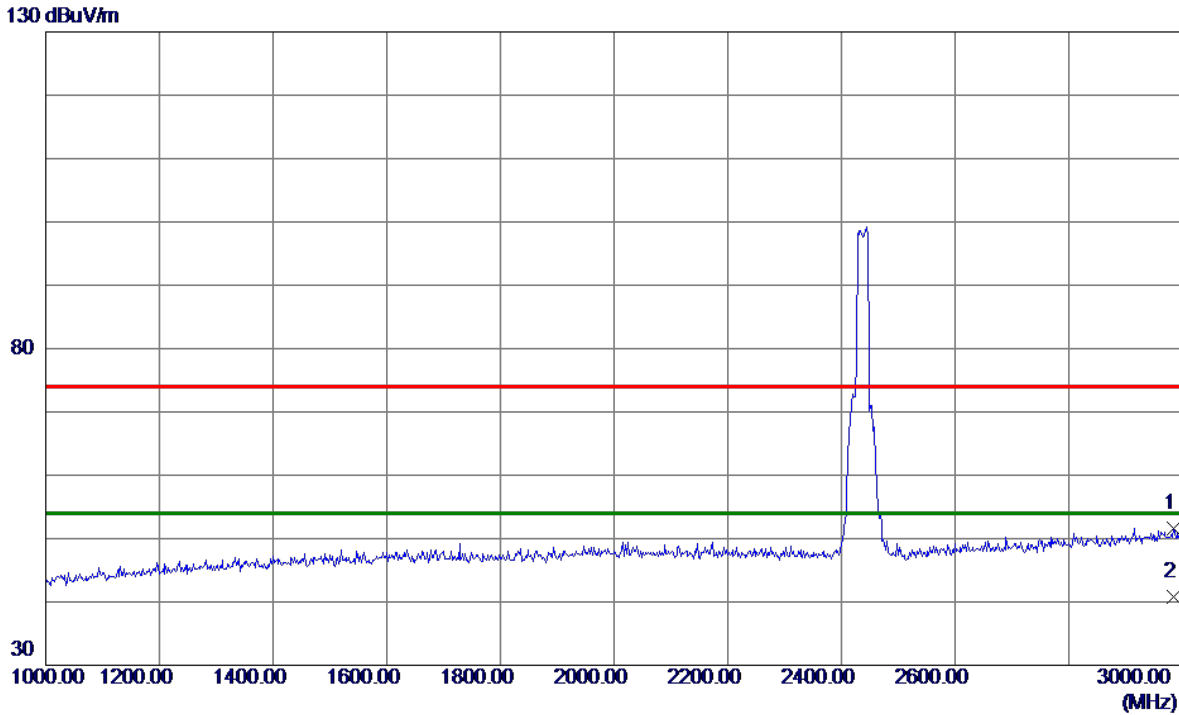

No.	Freq. MHz	Reading Level dBuV/m	Correct Factor dB	Measure ment dBuV/m	Limit dBuV/m	Margin dB	Detector	Comment
1	2984.0000	41.10	10.53	51.63	74.00	-22.37	Peak	
2 *	2984.0000	30.25	10.53	40.78	54.00	-13.22	AVG	

REMARKS:

- (1) Measurement Value = Reading Level + Correct Factor.
- (2) Margin Level = Measurement Value - Limit Value.

Orthogonal Axis	X
Test Mode:	TX N-20M Mode 2437 MHz

Horizontal

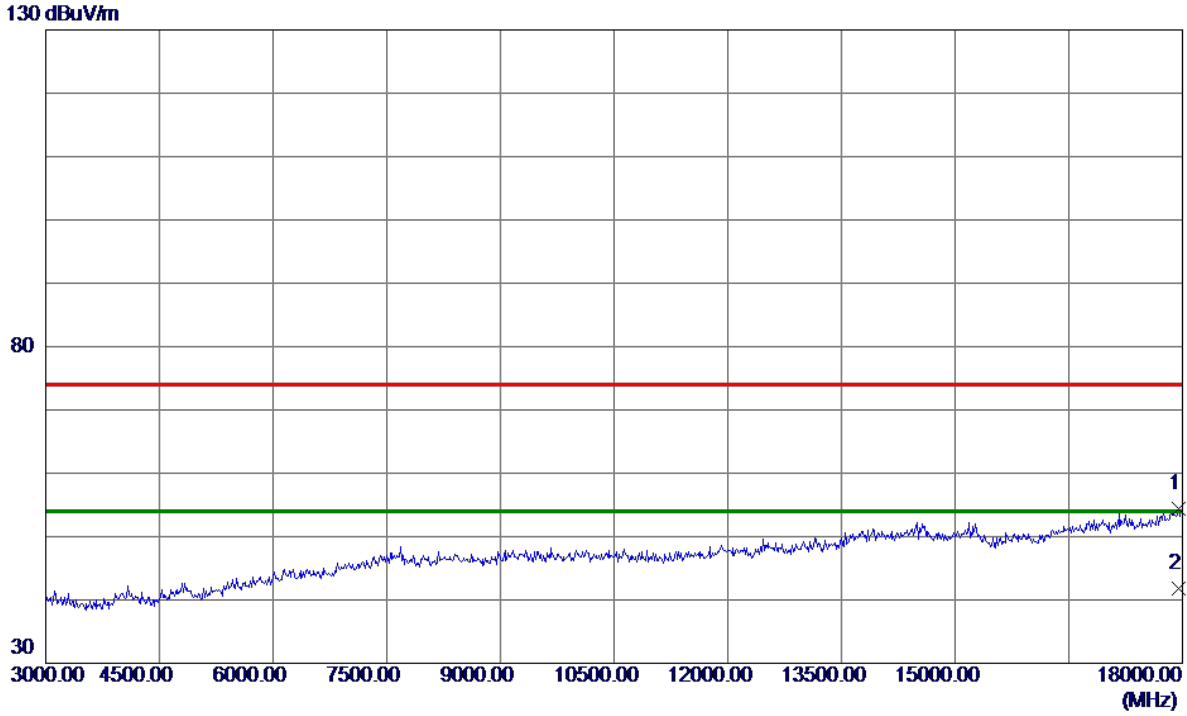

No.	Freq. MHz	Reading Level dBuV/m	Correct Factor dB	Measure ment dBuV/m	Limit dBuV/m	Margin dB	Detector	Comment
1	17955.0000	31.79	22.52	54.31	74.00	-19.69	Peak	
2 *	17955.0000	19.30	22.52	41.82	54.00	-12.18	AVG	

REMARKS:

- (1) Measurement Value = Reading Level + Correct Factor.
- (2) Margin Level = Measurement Value - Limit Value.

Orthogonal Axis	X
Test Mode:	TX N-20M Mode 2437 MHz

Horizontal

130 dBuV/m

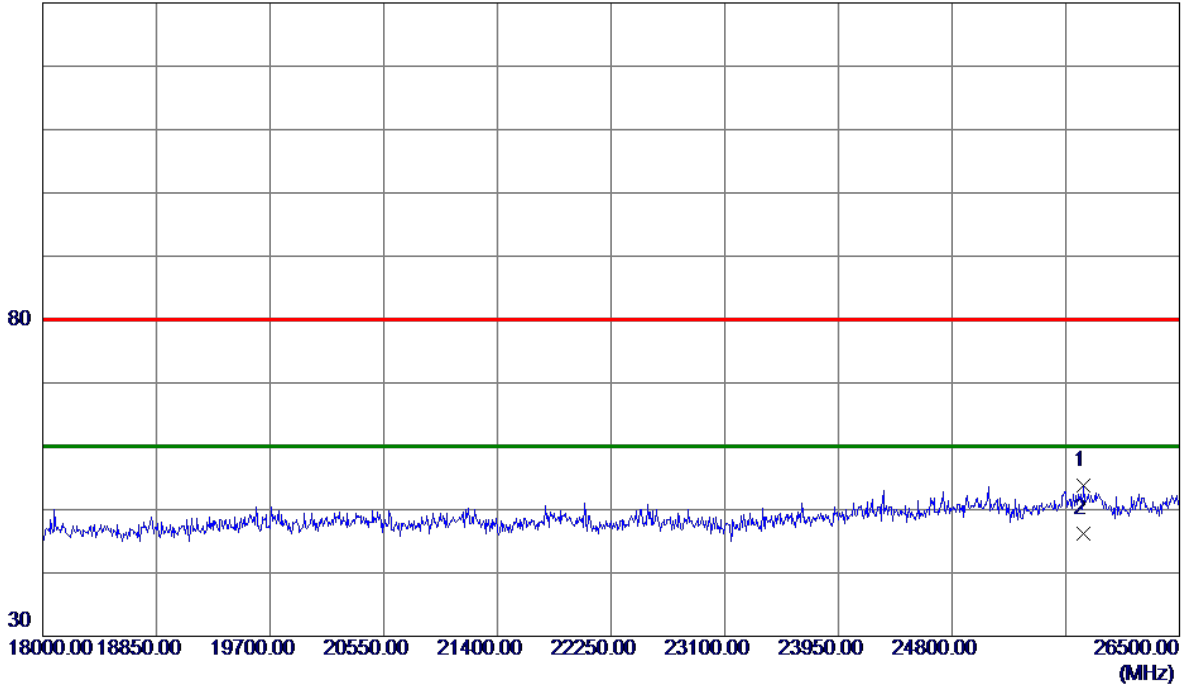

No.	Freq. MHz	Reading Level dBuV/m	Correct Factor dB	Measure ment dBuV/m	Limit dBuV/m	Margin dB	Detector	Comment
1	25781.7500	36.13	17.73	53.86	80.00	-26.14	Peak	
2 *	25781.7500	28.50	17.73	46.23	60.00	-13.77	AVG	

REMARKS:

- (1) Measurement Value = Reading Level + Correct Factor.
- (2) Margin Level = Measurement Value - Limit Value.

Orthogonal Axis	X
Test Mode:	TX N-20M Mode 2462 MHz

Vertical

130 dBuV/m

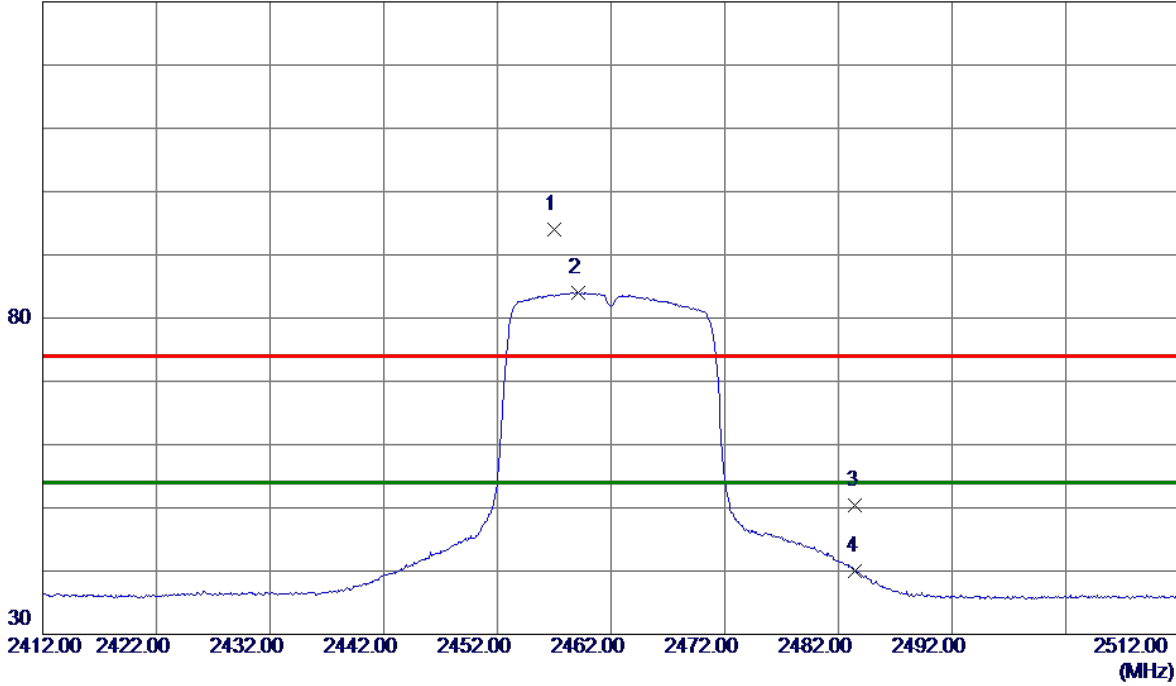

No.	Freq. MHz	Reading Level dBuV/m	Correct Factor dB	Measure ment dBuV/m	Limit dBuV/m	Margin dB	Detector	Comment
1	2457.0500	87.58	6.45	94.03	74.00	20.03	Peak	No Limit
2 *	2459.1000	77.60	6.45	84.05	54.00	30.05	AVG	No Limit
3	2483.5000	44.05	6.42	50.47	74.00	-23.53	Peak	
4	2483.5000	33.52	6.42	39.94	54.00	-14.06	AVG	

REMARKS:

- (1) Measurement Value = Reading Level + Correct Factor.
- (2) Margin Level = Measurement Value - Limit Value.

Orthogonal Axis	X
Test Mode:	TX N-20M Mode 2462 MHz

Horizontal

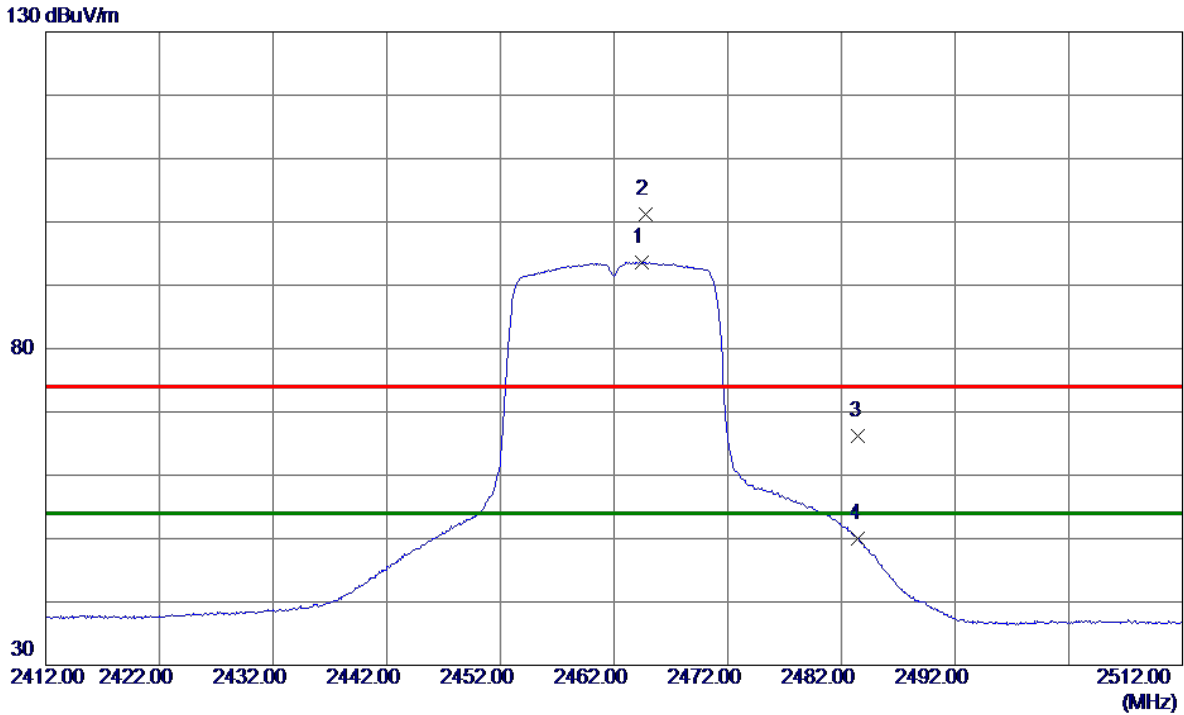

No.	Freq. MHz	Reading Level dBuV/m	Correct Factor dB	Measure ment dBuV/m	Limit dBuV/m	Margin dB	Detector	Comment
1 *	2464.4500	86.58	7.03	93.61	54.00	39.61	AVG	No Limit
2	2464.7500	94.12	7.03	101.15	74.00	27.15	Peak	No Limit
3	2483.5000	59.13	7.03	66.16	74.00	-7.84	Peak	
4	2483.5000	42.93	7.03	49.96	54.00	-4.04	AVG	

REMARKS:

- (1) Measurement Value = Reading Level + Correct Factor.
- (2) Margin Level = Measurement Value - Limit Value.

Orthogonal Axis	X
Test Mode:	TX N-40M Mode 2422MHz

Vertical

130 dBuV/m

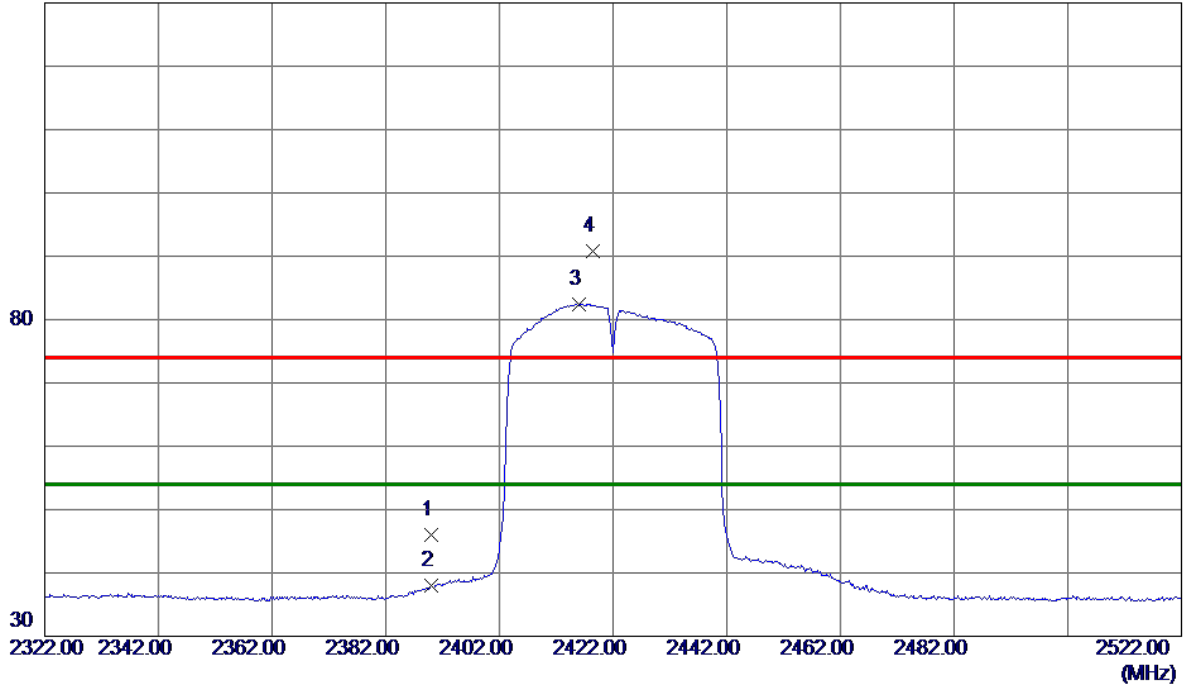

No.	Freq. MHz	Reading Level dBuV/m	Correct Factor dB	Measure ment dBuV/m	Limit dBuV/m	Margin dB	Detector	Comment
1	2390.0000	39.47	6.53	46.00	74.00	-28.00	Peak	
2	2390.0000	31.40	6.53	37.93	54.00	-16.07	AVG	
3 *	2416.1000	75.98	6.50	82.48	54.00	28.48	AVG	No Limit
4	2418.5000	84.27	6.50	90.77	74.00	16.77	Peak	No Limit

REMARKS:

- (1) Measurement Value = Reading Level + Correct Factor.
- (2) Margin Level = Measurement Value - Limit Value.

Orthogonal Axis	X
Test Mode:	TX N-40M Mode 2422MHz

Horizontal

130 dBuV/m

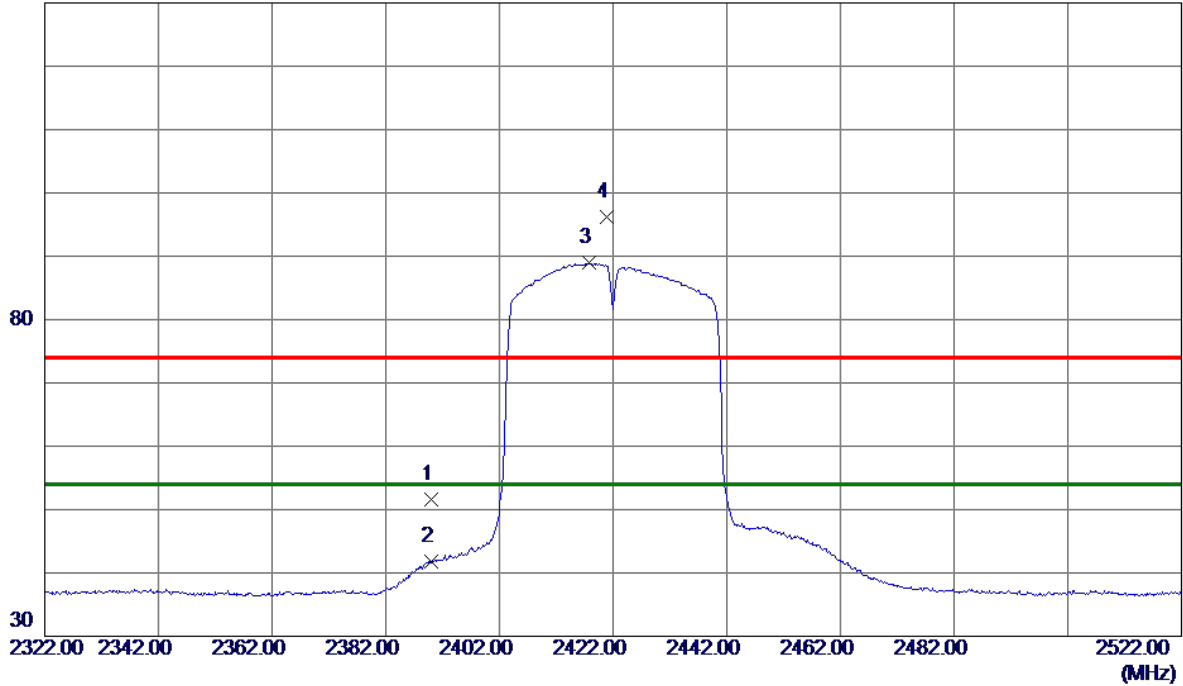

No.	Freq. MHz	Reading Level dBuV/m	Correct Factor dB	Measure ment dBuV/m	Limit dBuV/m	Margin dB	Detector	Comment
1	2390.0000	44.52	7.01	51.53	74.00	-22.47	Peak	
2	2390.0000	34.76	7.01	41.77	54.00	-12.23	AVG	
3 *	2417.8000	81.92	7.02	88.94	54.00	34.94	AVG	No Limit
4	2420.8000	89.23	7.02	96.25	74.00	22.25	Peak	No Limit

REMARKS:

- (1) Measurement Value = Reading Level + Correct Factor.
- (2) Margin Level = Measurement Value - Limit Value.

Orthogonal Axis	X
Test Mode:	TX N-40M Mode 2437 MHz

Vertical

130 dBuV/m

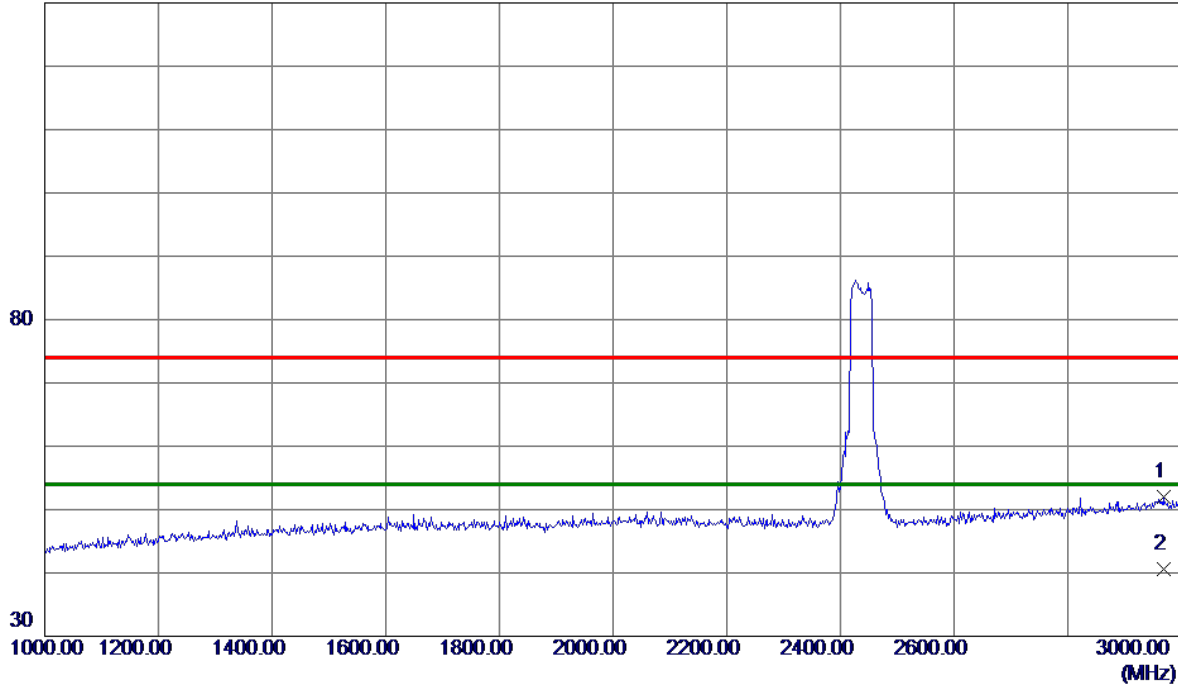

No.	Freq. MHz	Reading Level dBuV/m	Correct Factor dB	Measure ment dBuV/m	Limit dBuV/m	Margin dB	Detector	Comment
1	2968.0000	41.56	10.42	51.98	74.00	-22.02	Peak	
2 *	2968.0000	30.25	10.42	40.67	54.00	-13.33	AVG	

REMARKS:

- (1) Measurement Value = Reading Level + Correct Factor.
- (2) Margin Level = Measurement Value - Limit Value.

Orthogonal Axis	X
Test Mode:	TX N-40M Mode 2437 MHz

Vertical

130 dBuV/m

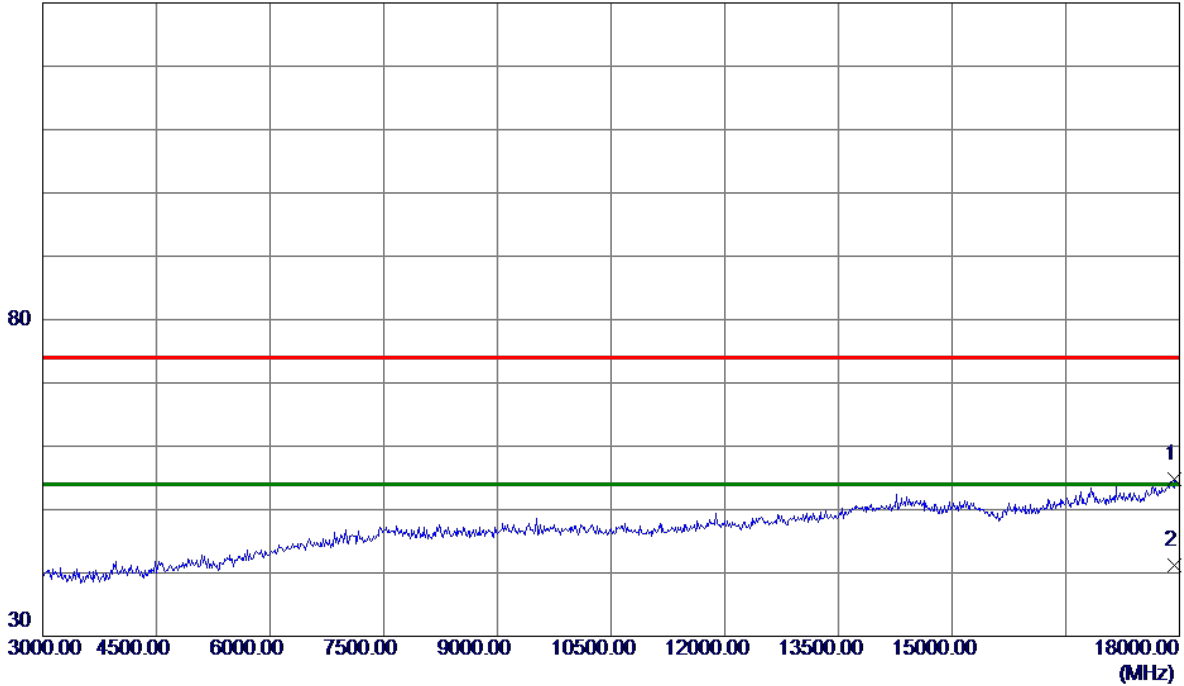

No.	Freq. MHz	Reading Level dBuV/m	Correct Factor dB	Measure ment dBuV/m	Limit dBuV/m	Margin dB	Detector	Comment
1	17940.0000	32.27	22.47	54.74	74.00	-19.26	Peak	
2 *	17940.0000	18.69	22.47	41.16	54.00	-12.84	AVG	

REMARKS:

- (1) Measurement Value = Reading Level + Correct Factor.
- (2) Margin Level = Measurement Value - Limit Value.

Orthogonal Axis	X
Test Mode:	TX N-40M Mode 2437 MHz

Vertical

130 dBuV/m

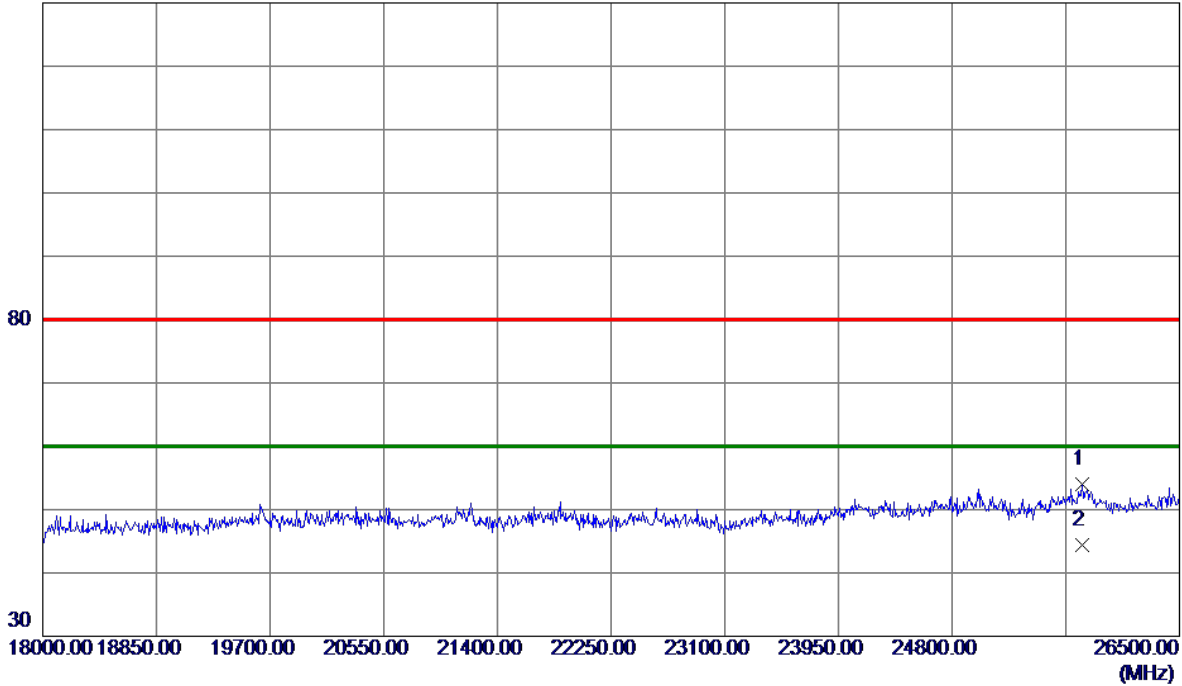

No.	Freq. MHz	Reading Level dBuV/m	Correct Factor dB	Measure ment dBuV/m	Limit dBuV/m	Margin dB	Detector	Comment
1	25773.2500	36.35	17.73	54.08	80.00	-25.92	Peak	
2 *	25773.2500	26.58	17.73	44.31	60.00	-15.69	AVG	

REMARKS:

- (1) Measurement Value = Reading Level + Correct Factor.
- (2) Margin Level = Measurement Value - Limit Value.

Orthogonal Axis	X
Test Mode:	TX N-40M Mode 2437 MHz

Horizontal

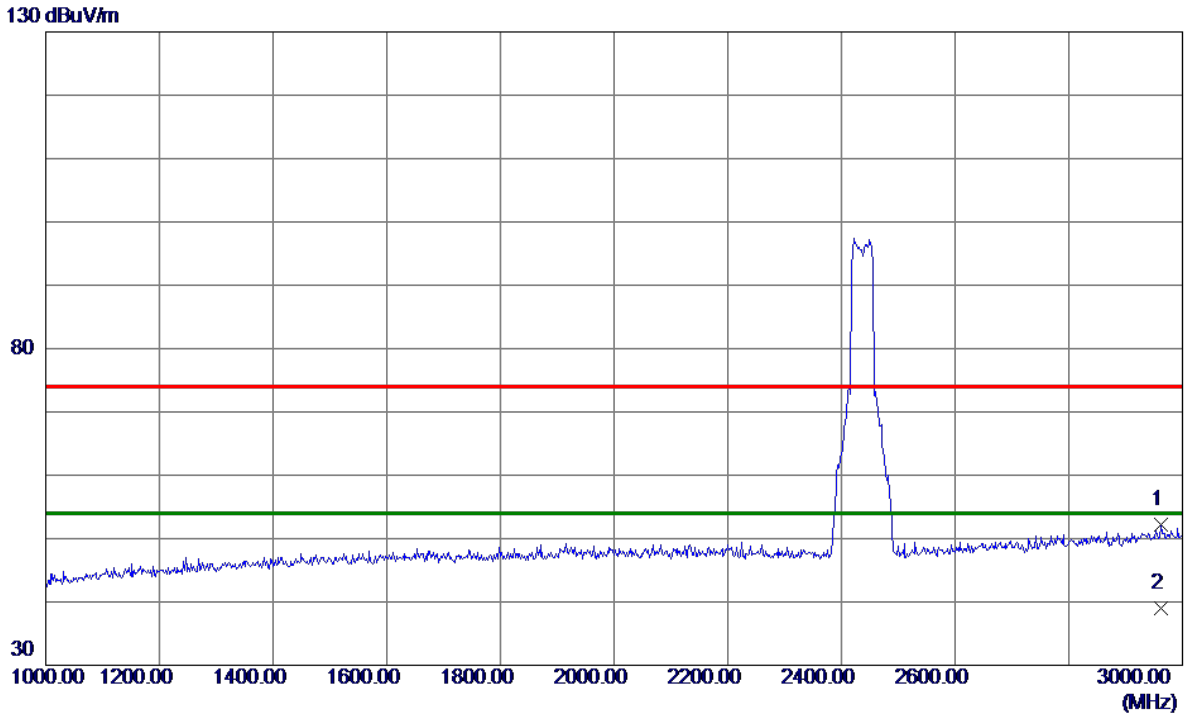

No.	Freq. MHz	Reading Level dBuV/m	Correct Factor dB	Measure ment dBuV/m	Limit dBuV/m	Margin dB	Detector	Comment
1	2962.0000	41.87	10.38	52.25	74.00	-21.75	Peak	
2 *	2962.0000	28.65	10.38	39.03	54.00	-14.97	AVG	

REMARKS:

- (1) Measurement Value = Reading Level + Correct Factor.
- (2) Margin Level = Measurement Value - Limit Value.

Orthogonal Axis	X
Test Mode:	TX N-40M Mode 2437 MHz

Horizontal

130 dBuV/m

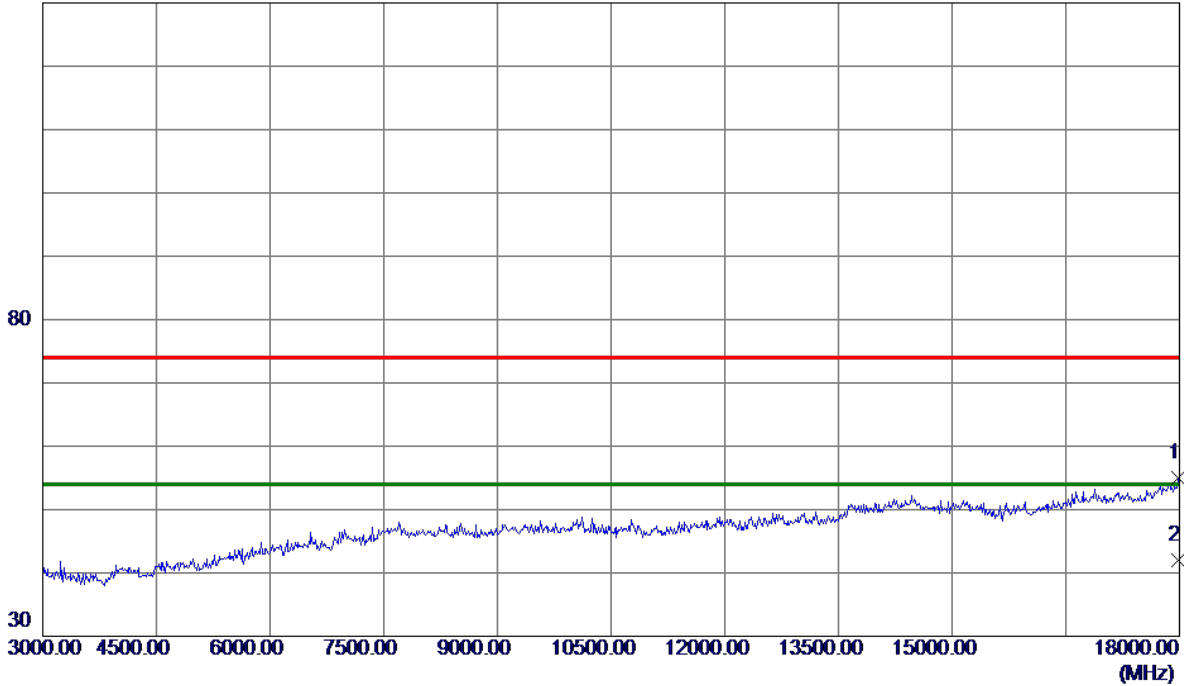

No.	Freq. MHz	Reading Level dBuV/m	Correct Factor dB	Measure ment dBuV/m	Limit dBuV/m	Margin dB	Detector	Comment
1	17985.0000	32.36	22.62	54.98	74.00	-19.02	Peak	
2 *	17985.0000	19.32	22.62	41.94	54.00	-12.06	AVG	

REMARKS:

- (1) Measurement Value = Reading Level + Correct Factor.
- (2) Margin Level = Measurement Value - Limit Value.

Orthogonal Axis	X
Test Mode:	TX N-40M Mode 2437 MHz

Horizontal

130 dBuV/m

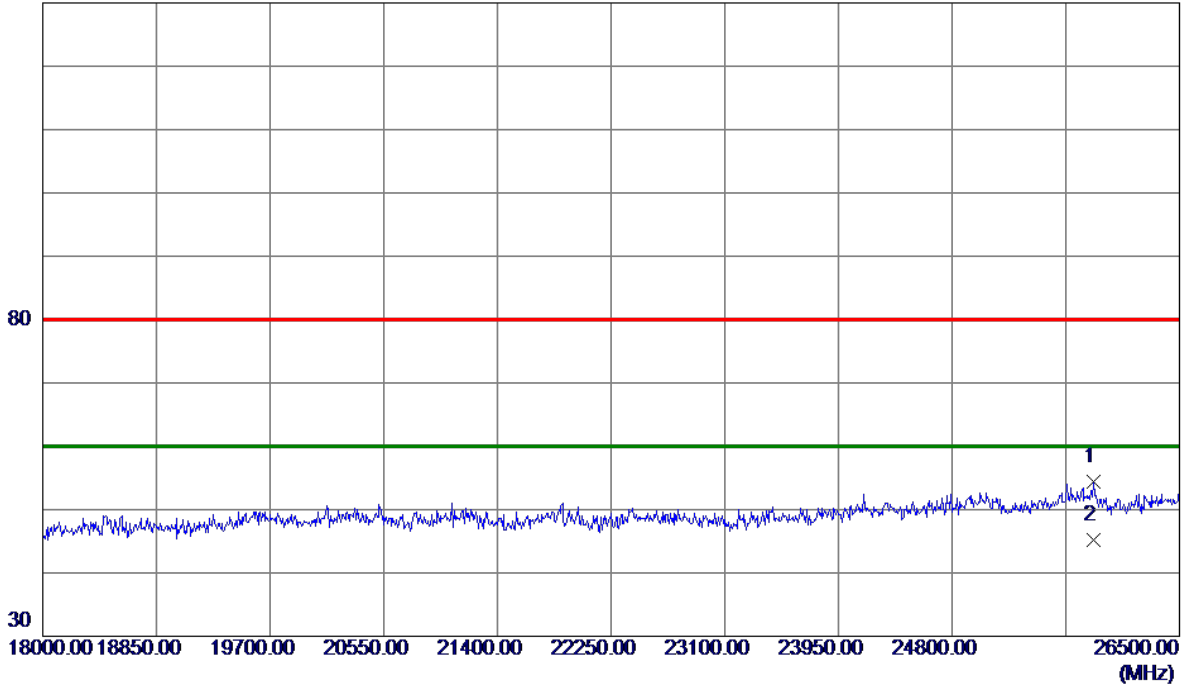

No.	Freq. MHz	Reading Level dBuV/m	Correct Factor dB	Measure ment dBuV/m	Limit dBuV/m	Margin dB	Detector	Comment
1	25854.0000	36.68	17.70	54.38	80.00	-25.62	Peak	
2 *	25854.0000	27.48	17.70	45.18	60.00	-14.82	AVG	

REMARKS:

- (1) Measurement Value = Reading Level + Correct Factor.
- (2) Margin Level = Measurement Value - Limit Value.

Orthogonal Axis	X
Test Mode:	TX N-40M Mode 2452 MHz

Vertical

130 dBuV/m

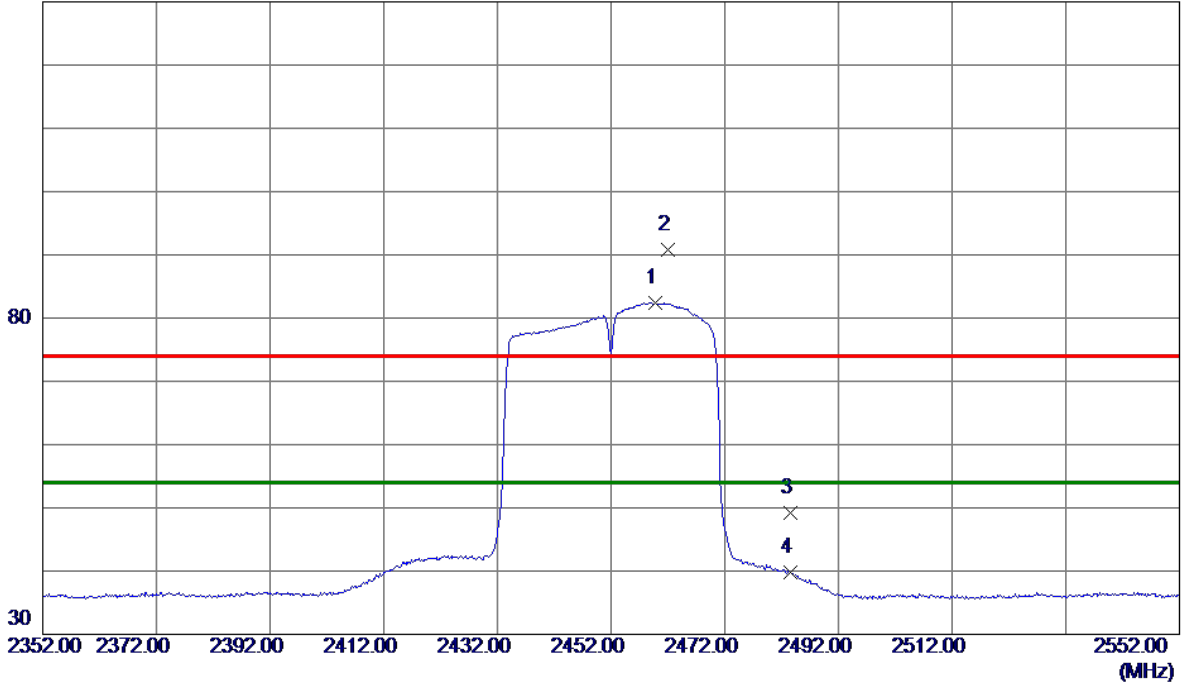

No.	Freq. MHz	Reading Level dBuV/m	Correct Factor dB	Measure ment dBuV/m	Limit dBuV/m	Margin dB	Detector	Comment
1 *	2459.7000	76.01	6.45	82.46	54.00	28.46	AVG	No Limit
2	2462.1000	84.33	6.45	90.78	74.00	16.78	Peak	No Limit
3	2483.5000	42.74	6.42	49.16	74.00	-24.84	Peak	
4	2483.5000	33.35	6.42	39.77	54.00	-14.23	AVG	

REMARKS:

- (1) Measurement Value = Reading Level + Correct Factor.
- (2) Margin Level = Measurement Value - Limit Value.

Orthogonal Axis	X
Test Mode:	TX N-40M Mode 2452 MHz

Horizontal

130 dBuV/m

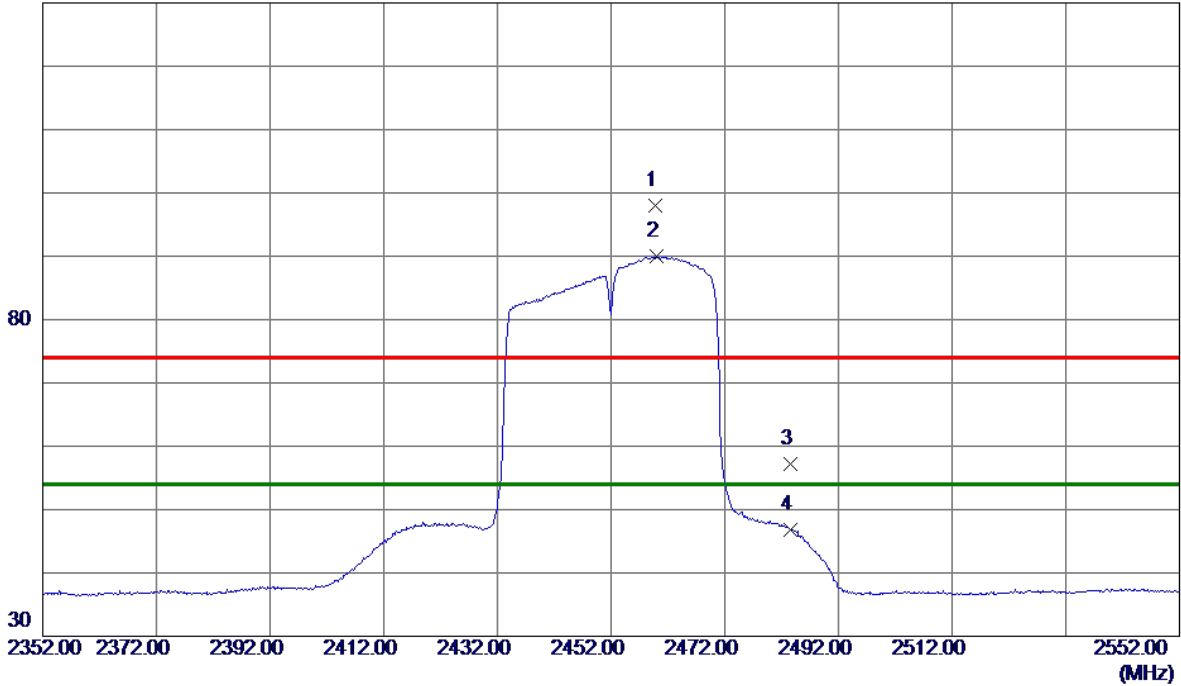

No.	Freq. MHz	Reading Level dBuV/m	Correct Factor dB	Measure ment dBuV/m	Limit dBuV/m	Margin dB	Detector	Comment
1	2459.7000	91.05	7.03	98.08	74.00	24.08	Peak	No Limit
2 *	2460.1000	82.87	7.03	89.90	54.00	35.90	AVG	No Limit
3	2483.5000	50.26	7.03	57.29	74.00	-16.71	Peak	
4	2483.5000	39.75	7.03	46.78	54.00	-7.22	AVG	

REMARKS:

- (1) Measurement Value = Reading Level + Correct Factor.
- (2) Margin Level = Measurement Value - Limit Value.

APPENDIX E - BANDWIDTH

Test Mode	TX B Mode
-----------	-----------

Channel	Frequency (MHz)	6 dB Bandwidth (MHz)	99 % Emission Bandwidth (MHz)	6 dB Bandwidth Min. Limit (kHz)	Result
01	2412	8.16	10.88	500	Complies
06	2437	8.63	10.52	500	Complies
11	2462	8.55	10.72	500	Complies

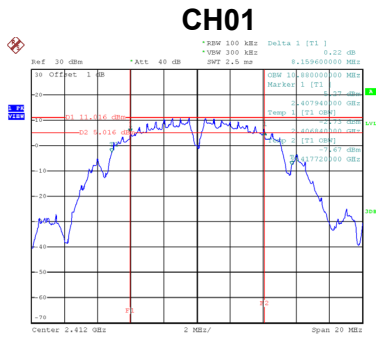

Date: 19.APR.2019 09:55:53

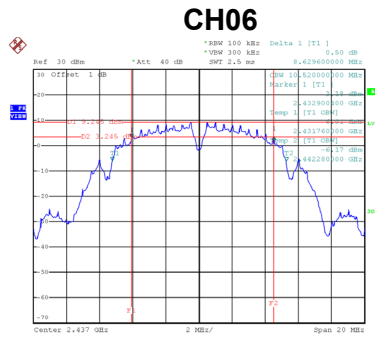

Date: 19.APR.2019 09:58:35

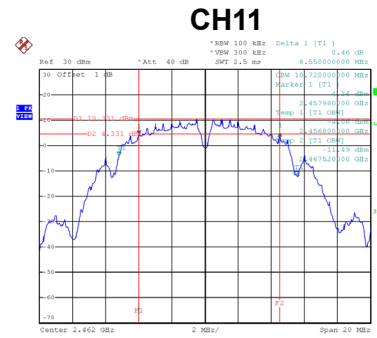

Date: 19.APR.2019 10:00:11

Test Mode	TX G Mode
-----------	-----------

Channel	Frequency (MHz)	6 dB Bandwidth (MHz)	99 % Emission Bandwidth (MHz)	6 dB Bandwidth Min. Limit (kHz)	Result
01	2412	16.41	16.40	500	Complies
06	2437	16.44	16.48	500	Complies
11	2462	16.48	16.44	500	Complies

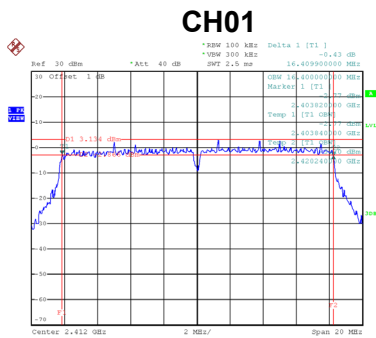

Date: 19.APR.2019 10:01:48

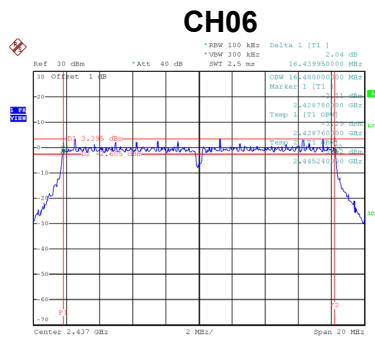

Date: 19.APR.2019 10:03:11

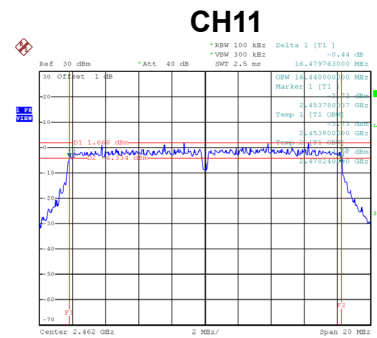

Date: 19.APR.2019 10:04:28

Test Mode	TX N-20M Mode
-----------	---------------

Channel	Frequency (MHz)	6 dB Bandwidth (MHz)	99 % Emission Bandwidth (MHz)	6 dB Bandwidth Min. Limit (kHz)	Result
01	2412	17.36	17.60	500	Complies
06	2437	17.66	17.64	500	Complies
11	2462	17.66	17.60	500	Complies

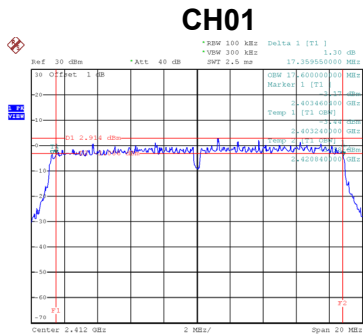

Date: 19.APR.2019 10:06:23

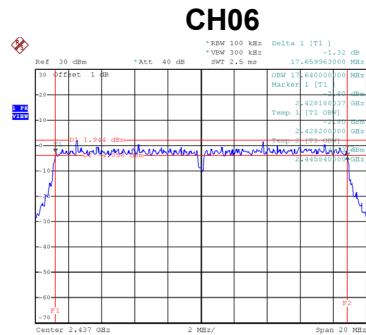

Date: 19.APR.2019 10:07:40

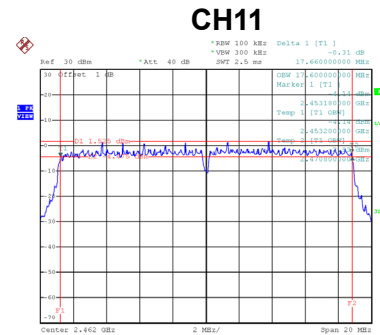

Date: 19.APR.2019 10:08:48

Test Mode	TX N-40M Mode
-----------	---------------

Channel	Frequency (MHz)	6 dB Bandwidth (MHz)	99 % Emission Bandwidth (MHz)	6 dB Bandwidth Min. Limit (kHz)	Result
03	2422	35.20	35.84	500	Complies
06	2437	36.36	36.00	500	Complies
09	2452	35.20	36.00	500	Complies

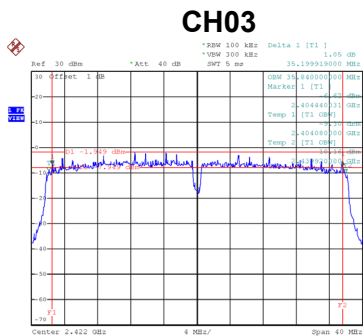

Date: 19.APR.2019 10:10:29

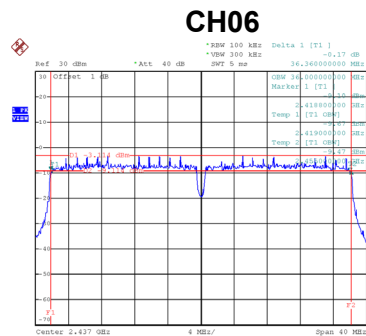

Date: 19.APR.2019 10:11:31

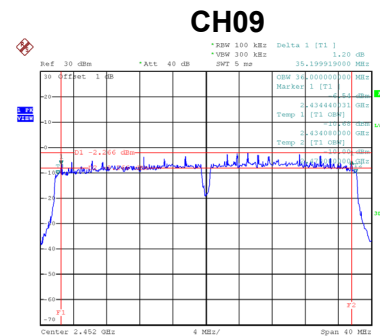

Date: 19.APR.2019 10:11:50

APPENDIX F - MAXIMUM OUTPUT POWER

Test Mode	TX B Mode
-----------	-----------

Channel	Frequency (MHz)	Output Power (dBm)	Output Power (W)	Max. Limit (dBm)	Max. Limit (W)	Result
01	2412	21.62	0.1452	30.00	1.0000	Complies
06	2437	19.72	0.0938	30.00	1.0000	Complies
11	2462	20.92	0.1236	30.00	1.0000	Complies

Test Mode	TX G Mode
-----------	-----------

Channel	Frequency (MHz)	Output Power (dBm)	Output Power (W)	Max. Limit (dBm)	Max. Limit (W)	Result
01	2412	24.11	0.2576	30.00	1.0000	Complies
06	2437	23.51	0.2244	30.00	1.0000	Complies
11	2462	23.78	0.2388	30.00	1.0000	Complies

Test Mode	TX N-20M Mode
-----------	---------------

Channel	Frequency (MHz)	Output Power (dBm)	Output Power (W)	Max. Limit (dBm)	Max. Limit (W)	Result
01	2412	22.98	0.1986	30.00	1.0000	Complies
06	2437	23.26	0.2118	30.00	1.0000	Complies
11	2462	22.44	0.1754	30.00	1.0000	Complies

Test Mode	TX N-40M Mode
-----------	---------------

Channel	Frequency (MHz)	Output Power (dBm)	Output Power (W)	Max. Limit (dBm)	Max. Limit (W)	Result
03	2422	21.32	0.1355	30.00	1.0000	Complies
06	2437	22.02	0.1592	30.00	1.0000	Complies
09	2452	21.53	0.1422	30.00	1.0000	Complies

APPENDIX G - CONDUCTED SPURIOUS EMISSIONS

Test Mode TX B Mode

Bandedge-CH01

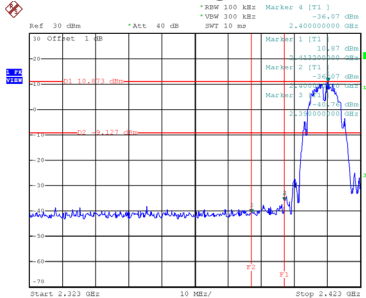

Bandedge-CH11

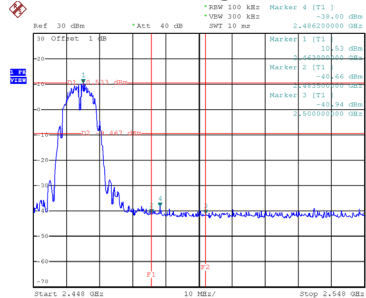

CH01 – 10th Harmonic of the fundamental frequency

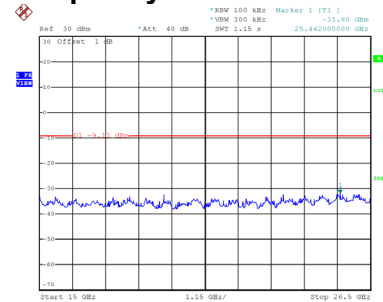
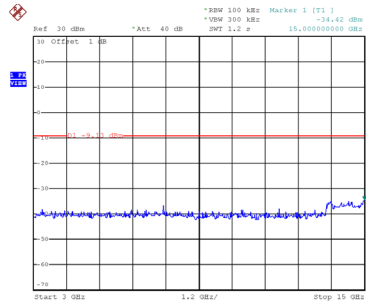
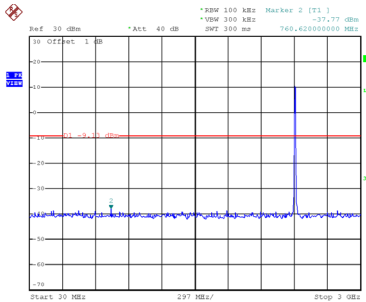

CH06 – 10th Harmonic of the fundamental frequency

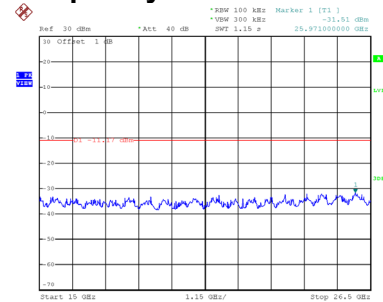
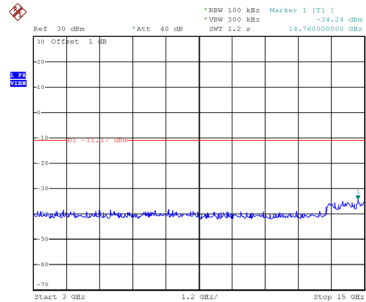
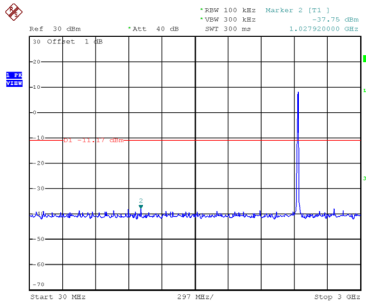

CH11 – 10th Harmonic of the fundamental frequency

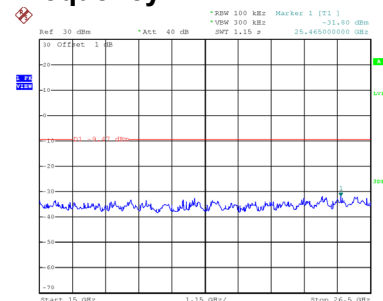
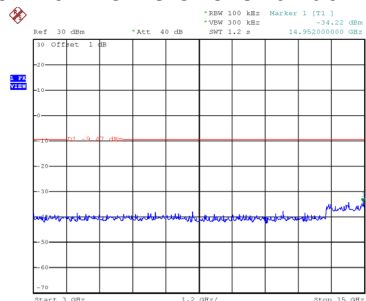
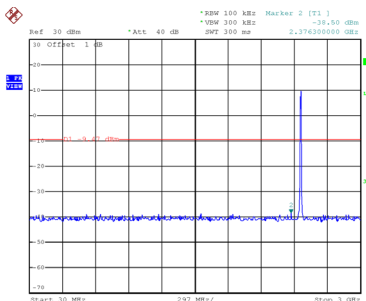

Test Mode TX G Mode

Bandedge-CH01

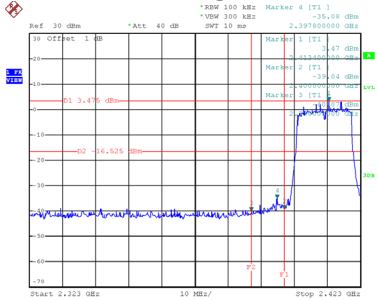

Date: 19.APR.2019 10:01:55

Bandedge-CH11

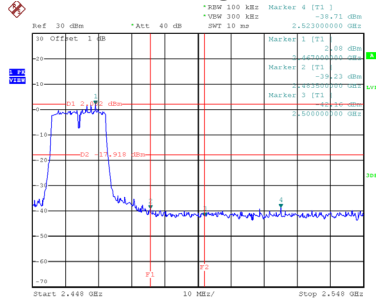

Date: 19.APR.2019 10:04:35

CH01 – 10th Harmonic of the fundamental frequency

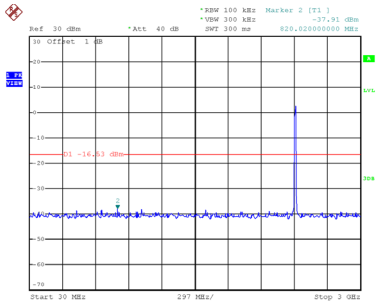

Date: 19.APR.2019 10:02:07

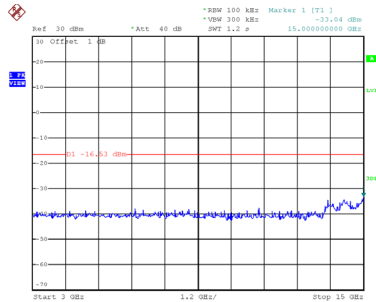

Date: 19.APR.2019 10:02:14

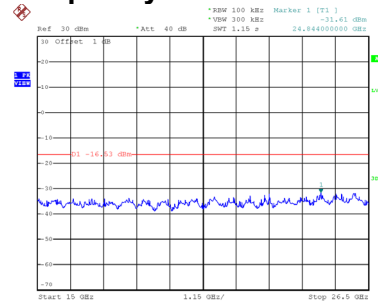

Date: 19.APR.2019 10:02:21

CH06 – 10th Harmonic of the fundamental frequency

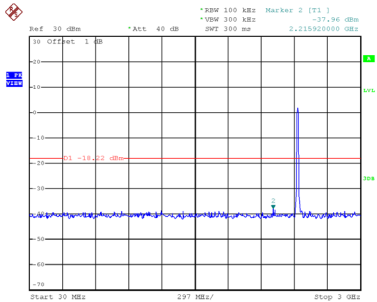

Date: 19.APR.2019 10:03:31

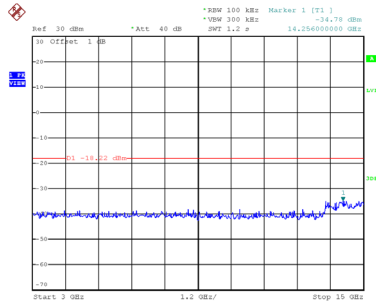

Date: 19.APR.2019 10:03:38

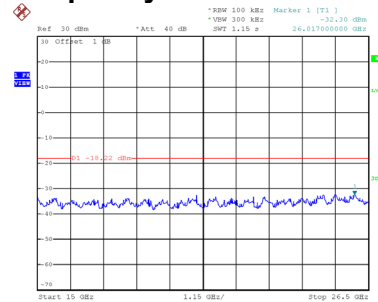

Date: 19.APR.2019 10:03:45

CH11 – 10th Harmonic of the fundamental frequency

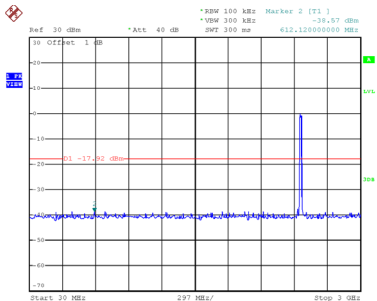

Date: 19.APR.2019 10:04:48

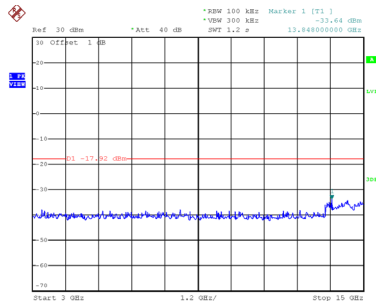

Date: 19.APR.2019 10:04:54

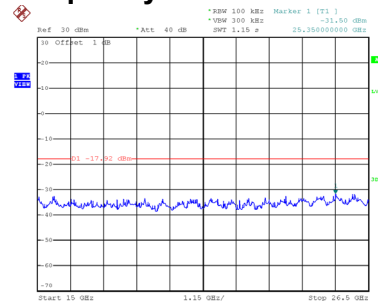

Date: 19.APR.2019 10:05:01

Test Mode TX N-20M Mode

Bandedge-CH01

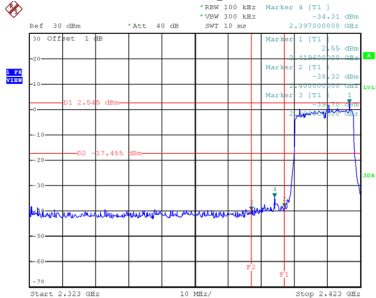

Date: 19.APR.2019 10:06:31

Bandedge-CH11

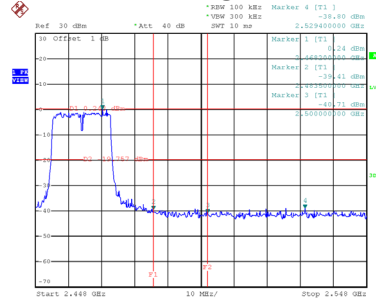

Date: 19.APR.2019 10:08:55

CH01 – 10th Harmonic of the fundamental frequency

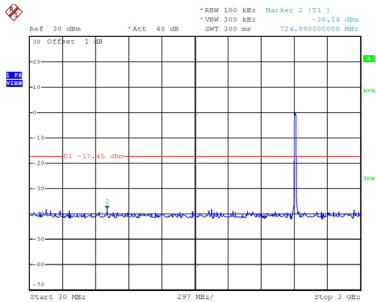

Date: 19.APR.2019 10:06:43

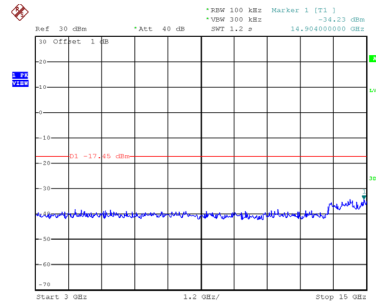

Date: 19.APR.2019 10:06:50

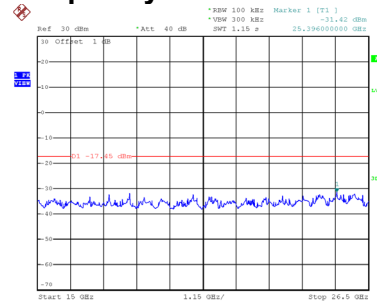

Date: 19.APR.2019 10:06:57

CH06 – 10th Harmonic of the fundamental frequency

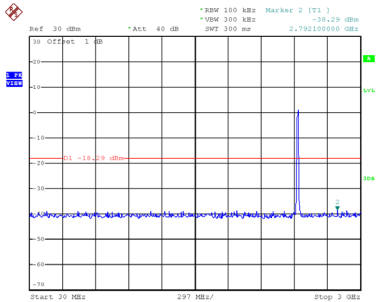

Date: 19.APR.2019 10:08:01

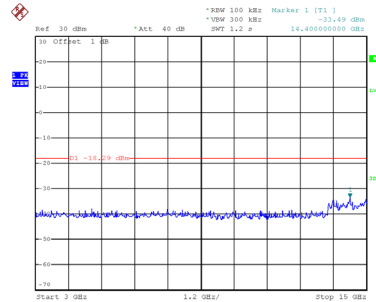

Date: 19.APR.2019 10:08:07

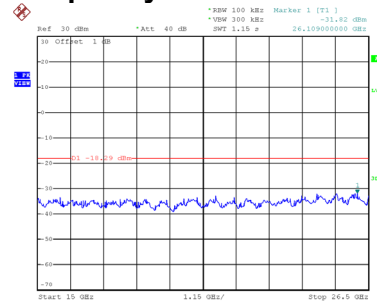

Date: 19.APR.2019 10:08:14

CH11 – 10th Harmonic of the fundamental frequency

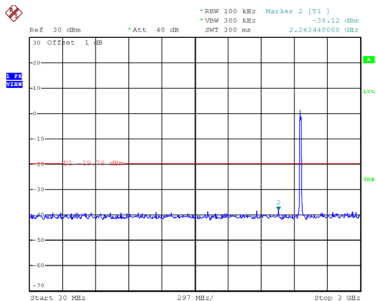

Date: 19.APR.2019 10:09:08

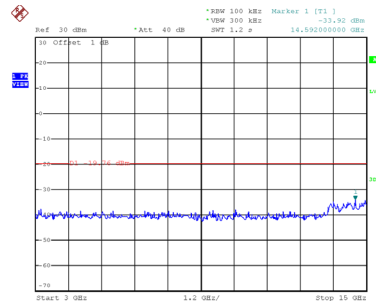

Date: 19.APR.2019 10:09:15

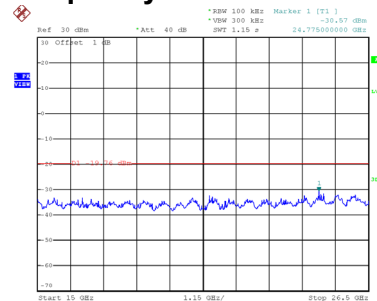

Date: 19.APR.2019 10:09:22

Test Mode TX N-40M Mode

Bandedge-CH03

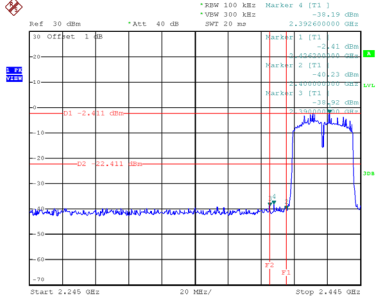

Date: 19.APR.2019 10:10:36

Bandedge-CH09

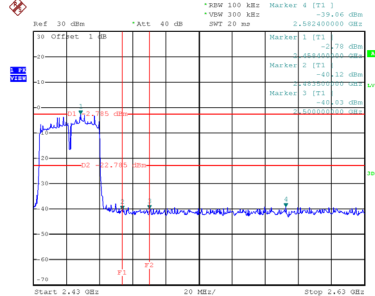

Date: 19.APR.2019 10:13:57

CH03 – 10th Harmonic of the fundamental frequency

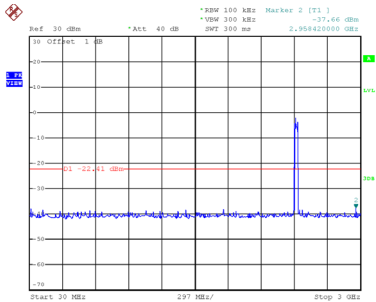

Date: 19.APR.2019 10:10:49

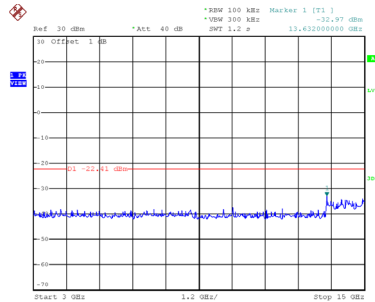

Date: 19.APR.2019 10:10:56

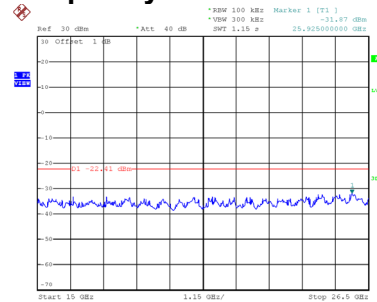

Date: 19.APR.2019 10:11:03

CH06 – 10th Harmonic of the fundamental frequency

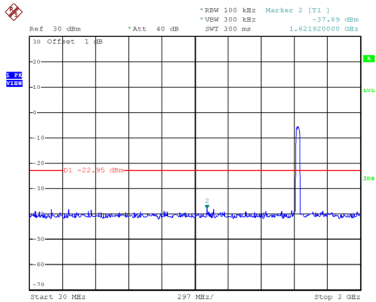

Date: 19.APR.2019 10:12:54

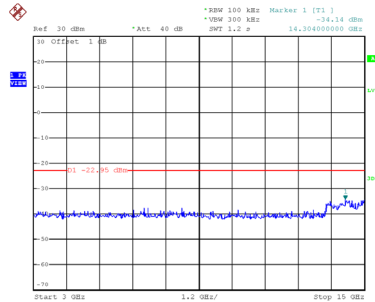

Date: 19.APR.2019 10:13:01

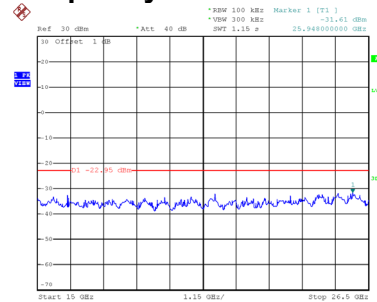

Date: 19.APR.2019 10:13:08

CH09 – 10th Harmonic of the fundamental frequency

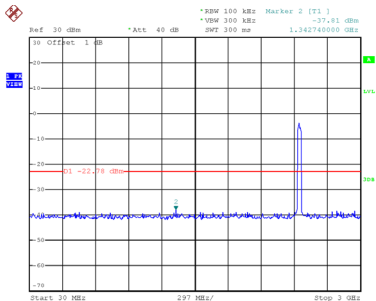

Date: 19.APR.2019 10:14:10

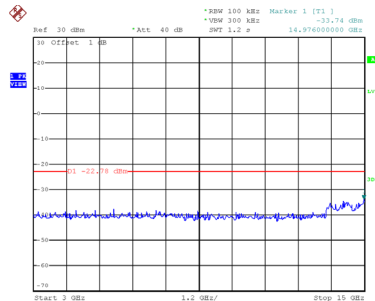

Date: 19.APR.2019 10:14:17

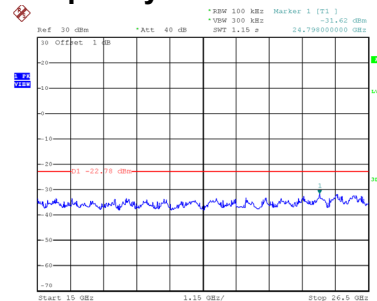

Date: 19.APR.2019 10:14:24

APPENDIX H - POWER SPECTRAL DENSITY

Test Mode	TX B Mode
-----------	-----------

Channel	Frequency (MHz)	Power Spectral Density (dBm/3kHz)	Max. Limit (dBm/3kHz)	Result
01	2412	-2.57	8	Complies
06	2437	-3.26	8	Complies
11	2462	-3.56	8	Complies

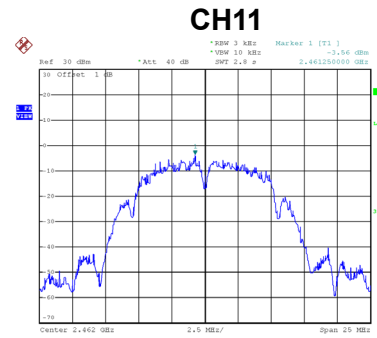
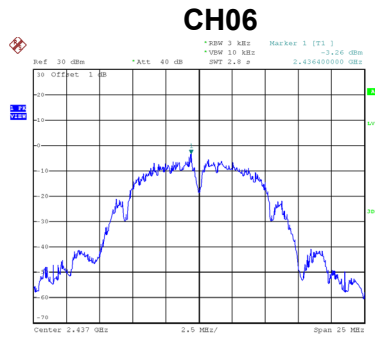
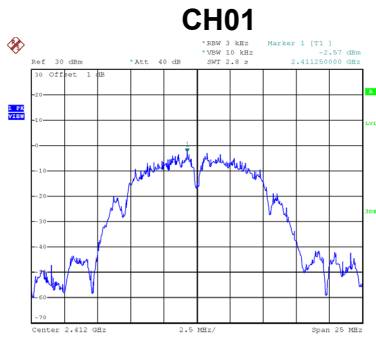

Test Mode	TX G Mode
-----------	-----------

Channel	Frequency (MHz)	Power Spectral Density (dBm/3kHz)	Max. Limit (dBm/3kHz)	Result
01	2412	-11.03	8	Complies
06	2437	-9.49	8	Complies
11	2462	-11.61	8	Complies

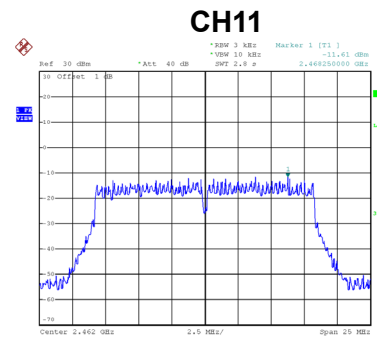
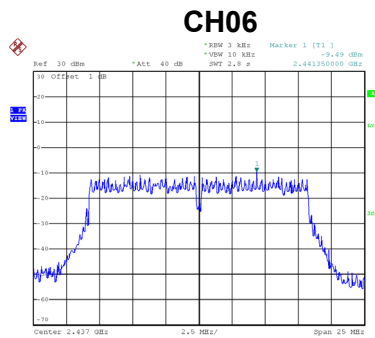
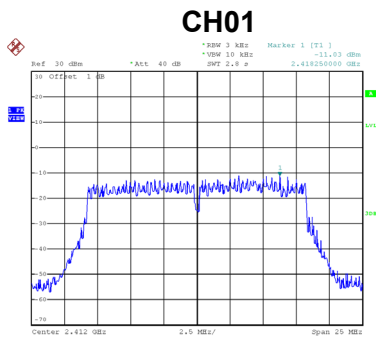

Test Mode	TX N-20M Mode
-----------	---------------

Channel	Frequency (MHz)	Power Spectral Density (dBm/3kHz)	Max. Limit (dBm/3kHz)	Result
01	2412	-11.94	8	Complies
06	2437	-12.22	8	Complies
11	2462	-13.25	8	Complies

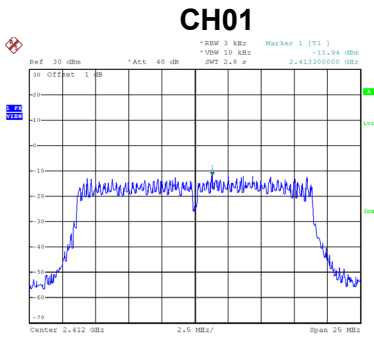

Date: 19.APR.2019 10:07:05

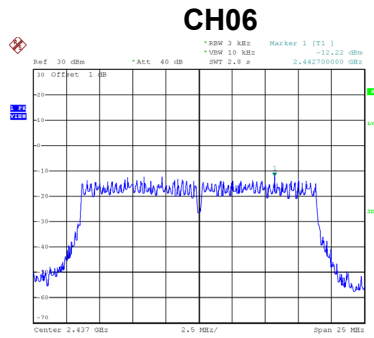

Date: 19.APR.2019 10:08:23

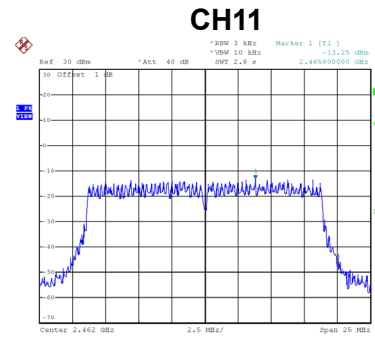

Date: 19.APR.2019 10:09:30

Test Mode	TX N-40M Mode
-----------	---------------

Channel	Frequency (MHz)	Power Spectral Density (dBm/3kHz)	Max. Limit (dBm/3kHz)	Result
03	2422	-17.37	8	Complies
06	2437	-16.77	8	Complies
09	2452	-16.39	8	Complies

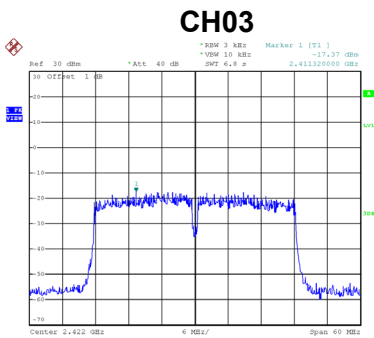

Date: 19.APR.2019 10:11:14

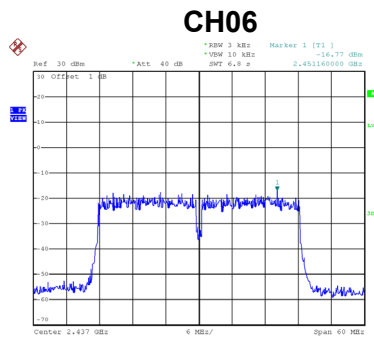

Date: 19.APR.2019 10:13:19

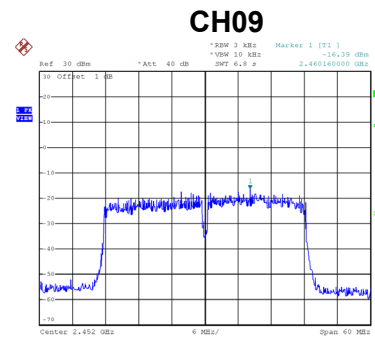

Date: 19.APR.2019 10:14:35

End of Test Report