



FCC&ISED RF Test Report

Product Name: HUAWEI MateBook

Model Number: MACHR-W29/MACHR-W19

Report No.: SYBH(Z-RF)20190123011002-2004

FCC ID:QISMACHR-WX9

IC:6369A-MACHRWX9

Authorized	APPROVED (Lab Manager)	PREPARED (Test Engineer)
BY	He Hao	Zhang Shuangxia
DATE	2019-03-18	2019-03-18

Reliability Laboratory of Huawei Technologies Co., Ltd.

(Global Compliance and Testing Center of Huawei Technologies Co., Ltd)

No.2, New City Avenue, Songshan Lake Sci. & Tech. Industry Park, Dongguan, 523808, P.R.C

Telephone: +86 769 23830808

Fax: +86 769 23837628

※ ※ Notice ※ ※

1. The laboratory has passed the accreditation by The American Association for Laboratory Accreditation (A2LA). The accreditation number is 2174.01.
2. The laboratory has been recognized by the US Federal Communications Commission (FCC) to perform compliance testing subject to the Commission's Certification rules. The Designation Number is CN1173, and the Test Firm Registration Number is 294140.
3. The laboratory has been recognized by the Innovation, Science and Economic Development Canada (ISED) to test to Canadian radio equipment requirements. The CAB identifier is CN0003, and the ISED# is 21741
4. The laboratory (Reliability Lab of Huawei Technologies Co., Ltd) is also named "Global Compliance and Testing Center of Huawei Technologies Co., Ltd", the both names have coexisted since 2009.
5. The test report is invalid if not marked with the signatures of the persons responsible for preparing and approving the test report.
6. The test report is invalid if there is any evidence of erasure and/or falsification.
7. The test report is only valid for the test samples.
8. Content of the test report, in part or in full, cannot be used for publicity and/or promotional purposes without prior written approval from the laboratory.
9. If any question about this report, please contact the laboratory (PublicGCTC@huawei.com).

MODIFICATION RECORD

No.	Report No	Modification Description
1	SYBH(Z-RF)201901230220 02-2004	First release.

DECLARATION

Type	Description
Multiple Models Applications	<p><input type="checkbox"/> The present report applies to single model.</p> <p><input checked="" type="checkbox"/> The present report applies to several models. The practical measurements are performed with the model <u>MACHR-W29</u>.</p> <p>These models utilize the similar radio design, shielding, interface, physical layout and so on. The differences and modifications between these models are declared by the applicant and showed in General Description</p> <p>All others between these models are identical.</p> <p>The present report only presents the worst test case of all modes, see relevant test results for detailed.</p>

1 Table of contents

1	Table of contents	4
2	General Information	5
2.1	Test standard/s	5
2.2	Test Environment	5
2.3	Test Laboratories	6
2.4	Applicant and Manufacturer	6
2.5	Application details	6
3	Test Summary	7
4	Description of the Equipment under Test (EUT)	8
4.1	General Description	8
4.2	EUT Identity	9
4.3	Technical Description	11
5	General Test Conditions / Configurations	12
5.1	EUT Configurations	12
5.2	Test Setups	13
5.3	Test Conditions	16
6	Main Test Instruments	18
7	Measurement Uncertainty	20
8	Appendixes	20

2 General Information

2.1 Test standard/s

Applied Rules :	47 CFR FCC Part 2, Subpart J 47 CFR FCC Part 15, Subpart C ISED RSS-Gen (Issue 5, April 2018) ISED RSS-247 (Issue 2, February 2017)
Test Method :	FCC KDB 558074 D01 DTS Meas Guidance v05r01 ANSI C63.10-2013, American National Standard for Testing Unlicensed Wireless Devices.

2.2 Test Environment

Temperature :	TN	15 to 30	°C during room temperature tests
Ambient Relative Humidity:	20 to 85 %		
Atmospheric Pressure:	Not applicable		
Power supply :	VL	7.4	V
	VN	8.0	V DC by Battery
	VH	8.7	V

NOTE 1: 1) VN= nominal voltage, VL= low extreme test voltage, VH= High extreme test voltage;

TN= normal temperature, TL= low extreme test temperature, TH= High extreme test temperature.

NOTE 2: The values used in the test report may be stringent than the declared.

2.3 Test Laboratories

Test Location 1 :	RELIABILITY LABORATORY OF HUAWEI TECHNOLOGIES CO., LTD.
Address of Test Location 1 :	No.2, New City Avenue, Songshan Lake Sci. & Tech. Industry Park, Dongguan, 523808, P.R.C

2.4 Applicant and Manufacturer

Company Name :	HUAWEI TECHNOLOGIES CO., LTD
Address :	Administration Building, Headquarters of Huawei Technologies Co., Ltd., Bantian, Longgang District, Shenzhen, 518129, P.R.C

2.5 Application details

Date of Receipt Sample:	2019-01-28
Start of test:	2019-01-29
End of test:	2019-03-18

3 Test Summary

Test Item	FCC Rule No.	ISED Rule No.	Requirements	Test Result	Verdict	Testing location
DTS (6 dB) Bandwidth	15.247(a)(2)	RSS-247, 5.2	≥ 500 kHz.	Appendix A	Pass	Test Location 1
Occupied Bandwidth	---	RSS-247, 5.2 RSS-Gen, 6.7	No limit.	Appendix B	Pass	Test Location 1
Duty Cycle	KDB 558074 D01 (6.0)	KDB 558074 D01 (6.0)	No limit.	Appendix C	Pass	Test Location 1
Maximum Conducted Average Output Power	15.247(b)(3)	RSS-247, 5.4	FCC: For directional gain: Conducted < 30 dBm – (G[dBi] – 6 [dB]); Otherwise: Conducted < 30 dBm, ISED: Conducted < 30 dBm. EIRP < 36 dBm,	Appendix D	Pass	Test Location 1
Maximum Power Spectral Density Level	15.247(e)	RSS-247, 5.2	Conducted < 8 dBm/3 kHz.	Appendix E	Pass	Test Location 1
Band Edges Compliance	15.247(d)	RSS-247, 5.5	< -30 dBm/100 kHz if total average power ≤ power limit.	Appendix F	Pass	Test Location 1
Unwanted Emissions into Non-Restricted Frequency Bands				Appendix G	Pass	Test Location 1
Unwanted Emissions into Restricted Frequency Bands (Radiated)	15.247(d) 15.209 (NOTE 1)	RSS-247, 5.5 RSS-Gen, 6.13 RSS-Gen, 8.10	FCC Part 15.209 field strength limit; RSS-Gen 8.10 Field strength limit.	Appendix H	Pass	Test Location 1
AC Power Line Conducted Emissions	15.207	RSS-Gen, 8.8	FCC Part 15.207 conducted limit; RSS-Gen, 8.8 conducted limit.	Appendix I	Pass	Test Location 1
NOTE1 : According to KDB 558074 D01, antenna-port conducted measurements are acceptable as an alternative to radiated measurements for demonstrating compliance to the limits in the restricted frequency bands. If						

Test Item	FCC Rule No.	ISED Rule No.	Requirements	Test Result	Verdict	Testing location
<p>conducted measurements are performed, then proper impedance matching must be ensured and an additional radiated test for cabinet/case emissions will also be required.</p> <p>NOTE2: The transmitter has an integral PCB loop antenna that is enclosed within the housing of the EUT and meets the requirements of FCC 15.203</p>						

4 Description of the Equipment under Test (EUT)

4.1 General Description

MACHR-W29/MACHR-W19 is a notebook computer, Which supports 2.4G Wi-Fi, 5G Wi-Fi, and Bluetooth wireless frequency bands. It provides power and fingerprint key switch, one USB type A , two USB type C, and a earphone interfaces.

The difference between MACHR-W29 and MACHR-W19 is show in the following table:

	MACHR-W29 (with GPU version)	MACHR-W29 (without GPU version)	MACHR-W19 (with GPU version)	MACHR-W19 (without GPU version)
PCB layout	The same	The same	The same	The same
Main board	The same	Delete GPU chip and related components	The same	Delete GPU chip and related components
Frequency bands	The same,support Wi-Fi 2.4G&5G,BT 2.4G	The same,support Wi-Fi 2.4G&5G,BT 2.4G	The same,support Wi-Fi 2.4G&5G,BT 2.4G	The same,support Wi-Fi 2.4G&5G,BT 2.4G
BT/ Wi-Fi antenna	The same	The same	The same	The same
Appearance	The same	The same	The same	The same
Dimension	The same	The same	The same	The same
CPU	Whiskey lake-U i7, Support max 4.6GHz	Whiskey lake-U i7, Support max 4.6GHz	Whiskey lake-U i5, Support max 3.9GHz	Whiskey lake-U i5, Support max 3.9GHz

GPU	Support	Not support	Support	Not support
Memory	16/8G	16/8G	8G	8G
SSD	512G/1T	512G/1T	256G/512G	256G/512G
Rear camera	Not support	Not support	Not support	Not support
Front camera	The same	The same	The same	The same
Adapter	The same	The same	The same	The same
Battery	The same	The same	The same	The same
Accessories	The same	The same	The same	The same

Note1: Only Bluetooth BLE test data included in this report.

Note2: We do not test the data of MACHR-W19 except RSE (worst case) and the data is not worsen, So all test data share the MACHR-W29.













4.2 EUT Identity





















NOTE: Unless otherwise noted in the report, the functional boards installed in the units shall be selected from the below list, but not means all the functional boards listed below shall be installed in one unit.

4.2.1 Board

Board		
Description	Software Version	Hardware Version
Main Board	1.5.0.7(C001)	SP2MACHRW19M

4.2.2 Sub-Assembly

Sub-Assembly			
Sub-Assembly Name	Model	Manufacturer	Description
Adapter	HW-200325EP0	Huawei Technologies Co., Ltd.	Input voltage: 100-240V ~50/60Hz 1.8A Output voltage: 5V  2A OR 9V  2A OR 12V  2A OR 15V  3A OR 20V  3.25A
Adapter	HW-200325BP0	Huawei Technologies Co., Ltd.	Input voltage: 100-240V ~50/60Hz 1.8A Output voltage: 5V  2A OR 9V  2A OR 12V  2A OR 15V  3A OR 20V  3.25A
Adapter	HW-200325UP0	Huawei Technologies	Input voltage: 100-240V ~50/60Hz 1.8A Output voltage: 5V  2A OR 9V  2A

Sub-Assembly			
Sub-Assembly Name	Model	Manufacturer	Description
		Co., Ltd.	OR 12V  2A OR 15V  3A OR 20V  3.25A
Adapter	HW-200325AP0	Huawei Technologies Co., Ltd.	Input voltage: 100-240V ~50/60Hz 1.8A Output voltage: 5V  2A OR 9V  2A OR 12V  2A OR 15V  3A OR 20V  3.25A
Adapter	HW-200325CP0	Huawei Technologies Co., Ltd.	Input voltage: 100-240V ~50/60Hz 1.8A Output voltage: 5V  2A OR 9V  2A OR 12V  2A OR 15V  3A OR 20V  3.25A
Adapter	HW-200325JP0	Huawei Technologies Co., Ltd.	Input voltage: 100-240V ~50/60Hz 1.8A Output voltage: 5V  2A OR 9V  2A OR 12V  2A OR 15V  3A OR 20V  3.25A
Battery	HB4593R1ECW	Huawei Technologies Co., Ltd.	Rated capacity: 7410mAh Rated Voltage:  +7.6V Limited Charge Voltage:  +8.7V

4.3 Technical Description

NOTE: For the detailed technical descriptions, see the applicant/manufacturer's specifications or user manual.

Characteristics	Description	
TX/RX Operating Range	2400-2483.5 MHz band	$f_c = 2402 \text{ MHz} + N * 2 \text{ MHz}$, where: - f_c = "Operating Frequency" in MHz, - N = "Channel Number" with the range from 0 to 39.
Modulation Type	Digital	GFSK,
Emission Designator	GFSK for BT 4.2: 1M04FXD GFSK for BT 5.0: 2M06FXD	
Bluetooth Power Class	Class 1	
Antenna	Description	Isotropic Antenna
	Type	<input checked="" type="checkbox"/> Integral <input type="checkbox"/> External <input type="checkbox"/> Dedicated
	Ports	<input checked="" type="checkbox"/> Ant 1, <input type="checkbox"/> Ant 2, <input type="checkbox"/> Ant 3
	Gain	0.5 dBi (per antenna port, max.)
	Remark	When the EUT is put into service, the practical maximum antenna gain should NOT exceed the value as described above.
Power Supply	Type	<input type="checkbox"/> External DC mains, <input checked="" type="checkbox"/> Battery, <input checked="" type="checkbox"/> AC/DC Adapter, <input type="checkbox"/> Powered over Ethernet (PoE). <input type="checkbox"/> Other

5 General Test Conditions / Configurations

5.1 EUT Configurations

5.1.1 General Configurations

Configuration	Description
Test Antenna Ports	Until otherwise specified, <ul style="list-style-type: none"> - All TX tests are performed at all TX antenna ports of the EUT, and - All RX tests are performed at all RX antenna ports of the EUT.
Multiple RF Sources	Other than the tested RF source of the EUT, other RF source(s) are disabled or shutdown during measurements.

5.1.2 Customized Configurations

# EUT Conf.	Signal Description	Operating Frequency	Duty cycle
TM1_Ch0	GFSK for BT 4.2 modulation, package type DH5, hopping off.	Ch No. 0 / 2402 MHz	62.40%
TM1_Ch19	GFSK for BT 4.2 modulation, package type DH5, hopping off.	Ch No. 19 / 2440 MHz	62.40%
TM1_Ch39	GFSK for BT 4.2 modulation, package type DH5, hopping off.	Ch No. 39 / 2480 MHz	62.40%
TM2_Ch0	GFSK for BT 5.0 modulation, package type DH5, hopping off.	Ch No. 0 / 2402 MHz	33.10%
TM2_Ch19	GFSK for BT 5.0 modulation, package type DH5, hopping off.	Ch No. 19 / 2440 MHz	33.10%
TM2_Ch39	GFSK for BT 5.0 modulation, package type DH5, hopping off.	Ch No. 39 / 2480 MHz	33.10%

5.2 Test Setups

5.2.1 Test Setup 1

The Bluetooth component's antenna ports(s) of the EUT are connected to the measurement instrument per an appropriate attenuator. The EUT is controlled by Bluetooth System Simulator and/or PC/software to emit the specified signals for the purpose of measurements.

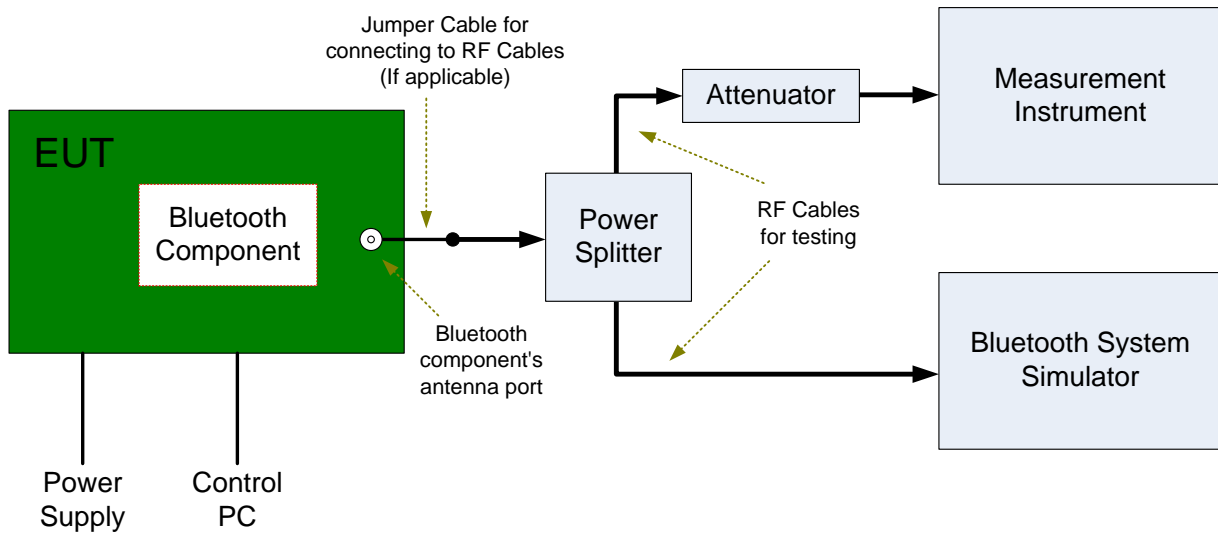

5.2.2 Test Setup 2

The semi-anechoic chamber and full-anechoic chamber has met the requirement of ANSI C63.4. The test distance is 3m. The setup is according to ANSI C63.4 and CAN/CSA-CEI/IEC CISPR 22.

The maximal emission value is acquired by adjusting the antenna height, polarisation and turntable azimuth. Normally, the height range of antenna is 1 m to 4 m, the azimuth range of turntable is 0° to 360°, and the receive antenna has two polarizations Vertical (V) and Horizontal (H).

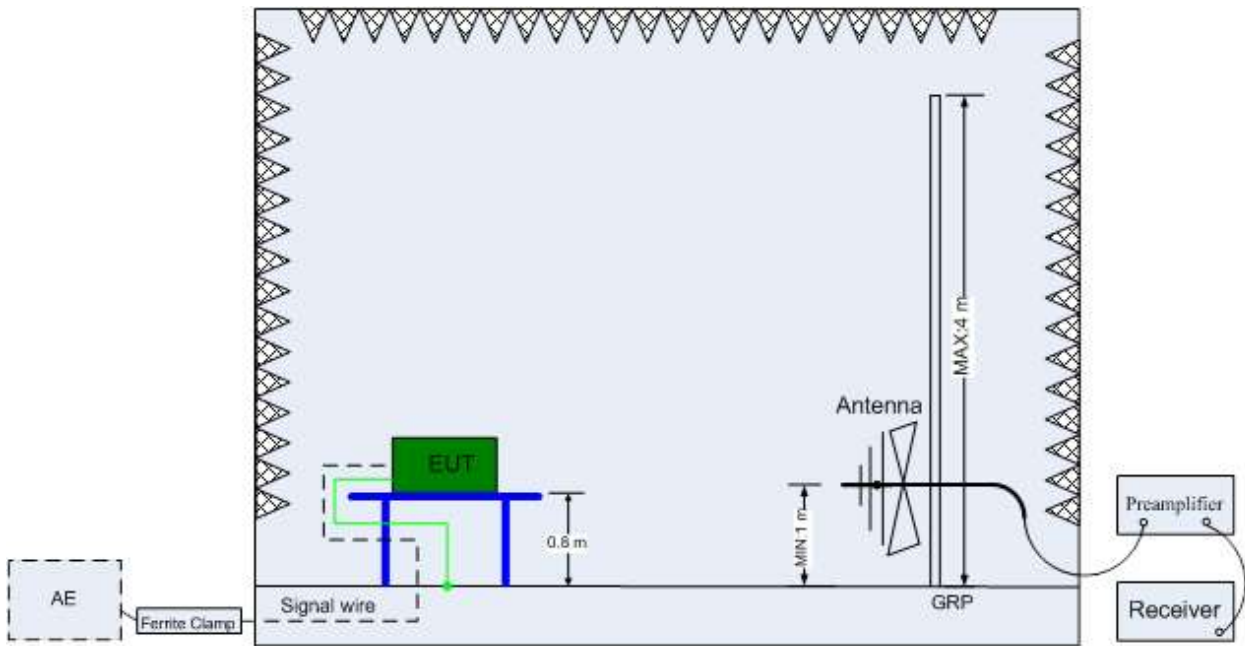

(Below 1 GHz)

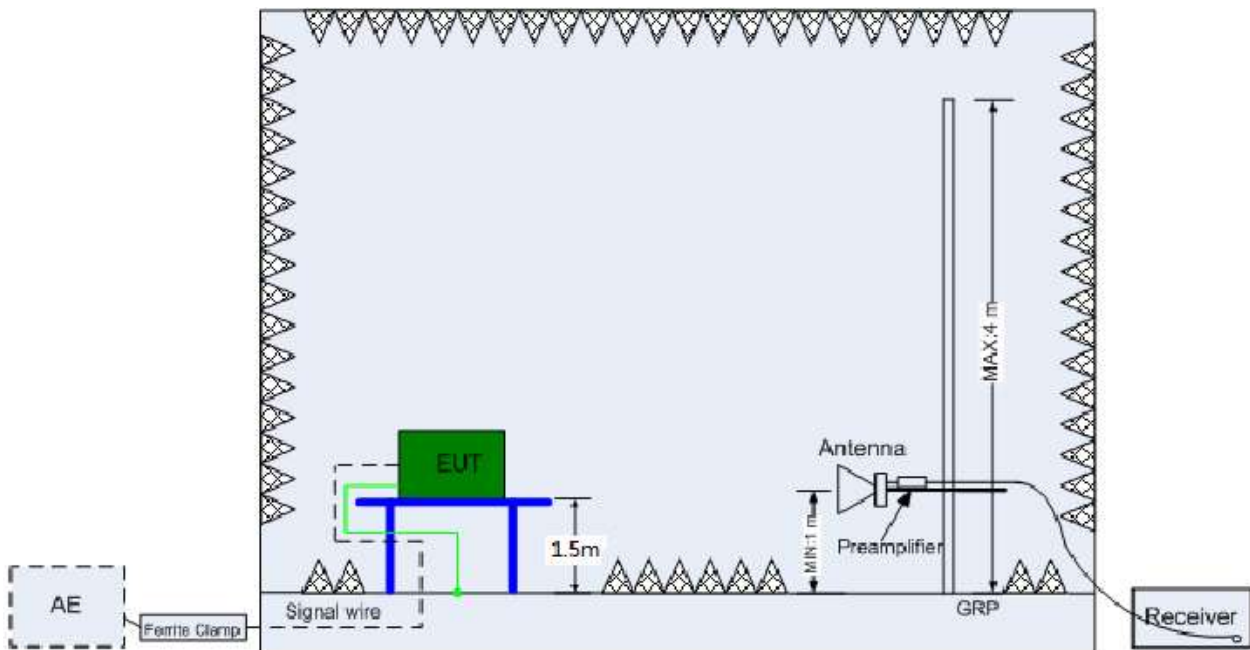

(Above 1 GHz)

5.2.3 Test Setup 3

The mains cable of the EUT (maybe per AC/DC Adapter) must be connected to LISN. The LISN shall be placed 0.8 m from the boundary of EUT and bonded to a ground reference plane for LISN mounted on top of the ground reference plane. This distance is between the closest points of the LISN and the EUT. All other units of the EUT and associated equipment shall be at least 0.8m from the LISN.

Ground connections, where required for safety purposes, shall be connected to the reference ground point of the LISN and, where not otherwise provided or specified by the manufacturer, shall be of same length as the mains cable and run parallel to the mains connection at a separation distance of not more than 0.1 m.

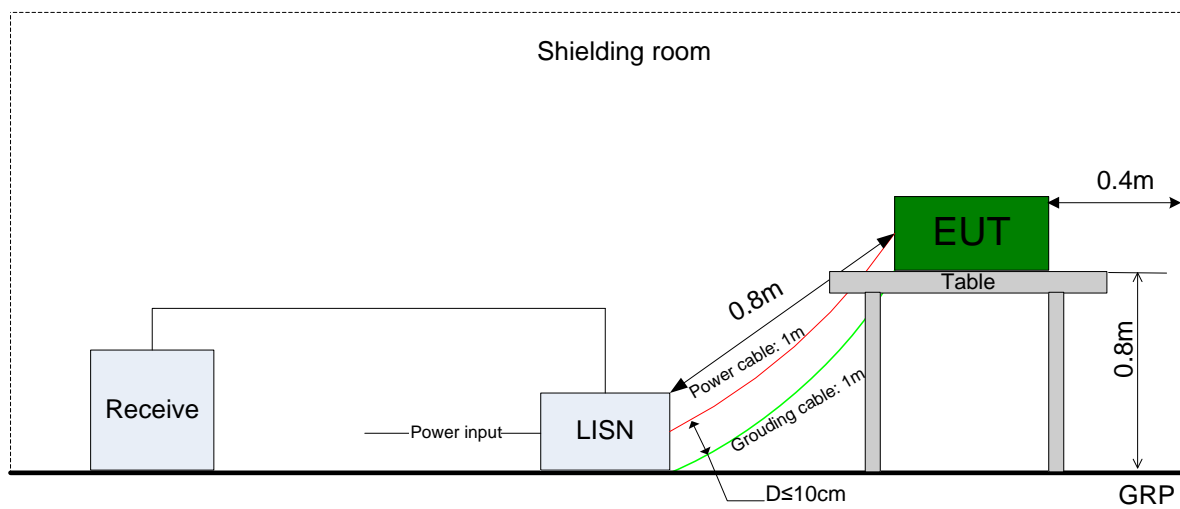

5.3 Test Conditions

Test Case	Test Conditions			
	Configuration	Description		
6dB Emission Bandwidth (EBW)	Meas. Method	FCC KDB 558074 D01 §8.2 Option 2.		
	Test Env.	TN/VN		
	Test Setup	Test Setup 1		
	EUT Conf.	TM1_Ch0, TM1_Ch19, TM1_Ch39. TM2_Ch0, TM2_Ch19, TM2_Ch39.		
Occupied Bandwidth	Meas. Method	FCC KDB 558074 D01 §8.2 Option 2.		
	Test Env.	TN/VN		
	Test Setup	Test Setup 1		
	EUT Conf.	TM1_Ch0, TM1_Ch19, TM1_Ch39. TM2_Ch0, TM2_Ch19, TM2_Ch39.		
Maximum peak Conducted Output Power	Meas. Method	FCC KDB 558074 D01 §8.3.1.1		
	Test Env.	TN/VN		
	Test Setup	Test Setup 1		
	EUT Conf.	TM1_Ch0, TM1_Ch19, TM1_Ch39. TM2_Ch0, TM2_Ch19, TM2_Ch39.		
Maximum Power Spectral Density Level	Meas. Method	FCC KDB 558074 D01 §8.4		
	Test Env.	TN/VN		
	Test Setup	Test Setup 1		
	EUT Conf.	TM1_Ch0, TM1_Ch19, TM1_Ch39. TM2_Ch0, TM2_Ch19, TM2_Ch39.		
Band edge spurious emission	Meas. Method	FCC KDB 558074 D01§8.7		
	Test Env.	TN/VN		
	Test Setup	Test Setup 1		
	EUT Conf.	TM1_Ch0, TM1_Ch39. TM2_Ch0, TM2_Ch39.		
Unwanted Emissions into Non-Restricted Frequency Bands	Meas. Method	FCC KDB 558074 D01§8.5		
	Test Env.	TN/VN		
	Test Setup	Test Setup 1		
	EUT Conf.	TM1_Ch0, TM1_Ch19, TM1_Ch39. TM2_Ch0, TM2_Ch19, TM2_Ch39.		
Unwanted Emissions into Restricted Frequency Bands (Radiated)	Meas. Method	ANSI C63.10; FCC KDB 558074 D01§8.6, Radiated		
	Test Env.	TN/VN		
	Test Setup	Test Setup 2		
	EUT Conf.	30 MHz -1 GHz	TM1_Ch0 (Worst Conf.). TM2_Ch0 (Worst Conf.).	
		1-3 GHz	TM1_Ch0, TM2_Ch39. TM2_Ch0, TM2_Ch39.	
3-18 GHz		TM1_Ch19 (Worst Conf.), TM2_Ch19 (Worst Conf.),		
18-26.5 GHz		TM1_Ch0 (Worst Conf.). TM2_Ch0 (Worst Conf.).		

Test Case	Test Conditions	
	Configuration	Description
AC Power Line Conducted Emissions	Meas. Method	AC mains conducted. Pre: RBW = 10 kHz; Det. = Peak. Final: RBW = 9 kHz; Det. = CISPR Quasi-Peak & Average.
	Test Env.	TN/VN
	Test Setup	Test Setup 3
	EUT Conf.	TM1_Ch39, TM2_Ch39

6 Main Test Instruments

This table gives a complete overview of the RF measurement equipment.

Devices used during the test described are marked

<input checked="" type="checkbox"/> Main Test Equipment (BT/WIFI test system)						
Marked	Equipment Name	Manufacturer	Model	Serial Number	Cal Date	Cal-Due
<input checked="" type="checkbox"/>	JS1120-3 BT/WIFI test system	JS Tonscend	JS0806-2	/	2018/05/30	2019/05/30
<input type="checkbox"/>	Power Detecting & Samplig Unit	R&S	OSP-B157	101429	2018/07/23	2019/07/23
<input type="checkbox"/>	Power Sensor	R&S	NRP2	103085/106211	2018/05/17	2019/05/17
<input type="checkbox"/>	DC Power Supply	KEITHLEY	2303	1342889	2018/10/24	2019/10/24
<input type="checkbox"/>	DC Power Supply	KEITHLEY	2303	000500E	2018/05/21	2019/05/21
<input type="checkbox"/>	DC Power Supply	KEITHLEY	2303	1288003	2018/05/21	2019/05/21
<input type="checkbox"/>	DC Power Supply	KEITHLEY	2303	000381E	2018/05/21	2019/05/21
<input type="checkbox"/>	DC Power Supply	KEITHLEY	2303	000510E	2018/10/24	2019/10/24
<input type="checkbox"/>	Temperature Chamber	WEISS	WKL64	56246002940010	2018/12/13	2019/12/13
<input checked="" type="checkbox"/>	Spectrum Analyzer	Agilent	N9030A	MY51380032	2018/07/23	2019/07/23
<input type="checkbox"/>	Spectrum Analyzer	Agilent	N9030A	MY49431698	2018/07/23	2019/07/23
<input type="checkbox"/>	Spectrum Analyzer	Keysight	N9040B	MY57212529	2018/06/28	2019/06/28
<input type="checkbox"/>	Signal Analyzer	R&S	FSQ31	200021	2018/07/23	2019/07/23
<input type="checkbox"/>	Signal Analyzer	R&S	FSU26	201069	2018/11/2	2019/11/2
<input type="checkbox"/>	Universal Radio Communication Tester	R&S	CMW500	159302	2018/07/23	2019/07/23
<input type="checkbox"/>	Wireless Communication Test set	Agilent	N4010A	MY49081592	2018/07/23	2019/07/23
<input checked="" type="checkbox"/>	Signal generator	Agilent	E8257D	MY51500314	2018/04/27	2019/04/27
<input type="checkbox"/>	Signal generator	Agilent	E8257D	MY49281095	2018/07/23	2019/07/23
<input type="checkbox"/>	Vector Signal Generator	R&S	SMW200A	103447	2018/05/31	2019/05/31
<input type="checkbox"/>	Vector Signal Generator	R&S	SMU200A	104162	2018/07/23	2019/07/23

<input checked="" type="checkbox"/> Main Test Equipment (CE test system)						
Marked	Equipment Name	Manufacturer	Model	Serial Number	Cal Date	Cal-Due
<input type="checkbox"/>	Test receiver	R&S	ESU26	100387	2019/01/15	2020/01/14
<input checked="" type="checkbox"/>	Test receiver	R&S	ESCI	101163	2019/01/15	2020/01/14
<input type="checkbox"/>	Artificial Main Network	R&S	ENV4200	100134	2018/05/08	2019/05/07
<input checked="" type="checkbox"/>	Line Impedance Stabilization Network	R&S	ENV216	100382	2018/05/08	2019/05/07
<input checked="" type="checkbox"/>	Measurement Software	R&S	EMC32 V9.25.0	/	/	/

<input checked="" type="checkbox"/> Main Test Equipment(RE test system)						
Marked	Equipment Name	Manufacturer	Model	Serial Number	Cal Date	Cal-Due
<input checked="" type="checkbox"/>	Test receiver	R&S	ESU26	100387	2019/01/15	2020/01/14
<input checked="" type="checkbox"/>	LOOP Antennas(9kHz-30MHz)	R&S	HFH2-Z2	100262	2017/04/25	2019/04/25
<input type="checkbox"/>	LOOP Antennas(9kHz-30MHz)	R&S	HFH2-Z2	100263	2017/04/25	2019/04/25
<input checked="" type="checkbox"/>	Trilog Broadband Antenna (30M~3GHz)	SCHWARZBE CK	VULB 9163	9163-357	2017/04/21	2019/04/20
<input type="checkbox"/>	Trilog Broadband Antenna (30M~3GHz)	SCHWARZBE CK	VULB 9163	9163-520	2017/3/29	2019/3/28
<input type="checkbox"/>	Trilog Broadband Antenna (30M~3GHz)	SCHWARZBE CK	VULB 9163	9163-491	2017/3/29	2019/3/28
<input type="checkbox"/>	Trilog Broadband Antenna (30M~3GHz)	SCHWARZBE CK	VULB 9163	9163-356	2018/4/9	2020/4/8
<input checked="" type="checkbox"/>	Double-Ridged Waveguide Horn Antenna (1G~18GHz)	R&S	HF907	100305	2017/4/21	2019/4/20
<input type="checkbox"/>	Double-Ridged Waveguide Horn Antenna (1G~18GHz)	R&S	HF906	100684	2017/5/27	2019/5/26
<input type="checkbox"/>	Double-Ridged Waveguide Horn Antenna (1G~18GHz)	R&S	HF906	100683	2017/3/29	2019/3/28
<input checked="" type="checkbox"/>	Pyramidal Horn Antenna(18GHz-26.5G Hz)	ETS-Lindgren	3160-09	5140299	2017/07/20	2019/07/19
<input type="checkbox"/>	Pyramidal Horn Antenna(18GHz-26.5G Hz)	ETS-Lindgren	3160-09	00206665	2018/4/21	2020/4/20
<input checked="" type="checkbox"/>	Pyramidal Horn Antenna(26.5GHz-40G Hz)	ETS-Lindgren	3160-10	00205695	2018/04/20	2020/04/19
<input type="checkbox"/>	Pyramidal Horn Antenna(26.5GHz-40G Hz)	ETS-Lindgren	3160-10	LM5947	2017/07/20	2019/07/19
<input checked="" type="checkbox"/>	Measurement Software	R&S	EMC32 V9.25.0	/	/	/

7 Measurement Uncertainty

For a 95% confidence level ($k = 2$), the measurement expanded uncertainties for defined systems, in accordance with the recommendations of ISO 17025 as following:

Test Item		Extended Uncertainty
Transmit Output Power Data	Power [dBm]	U = 0.39 dB
RF Power Density, Conducted	Power [dBm]	U = 0.64 dB
Bandwidth	Magnitude [%]	U=7%
Band Edge Compliance	Disturbance Power [dBm]	U = 0.9 dB
Spurious Emissions, Conducted	Disturbance Power [dBm]	20MHz~3.6GHz: U=0.88dB 3.6GHz~8.4GHz: U=1.08dB 8.4GHz~13.6GHz: U=1.24dB 13.6GHz~22GHz: U=1.34dB 22GHz~26.5GHz: U=1.36dB
Field Strength of Spurious Radiation	ERP/EIRP [dBm]	For 3 m Chamber: U = 5.90 dB (30 MHz-1 GHz) U = 4.94 dB (1 GHz-18 GHz) U = 4.24 dB (18 GHz-26.5 GHz)
Frequency Stability	Frequency Accuracy [Hz]	U=41.58Hz
AC Power Line Conducted Emissions	Disturbance Voltage[dB μ V]	U=2.3 dB
Duty Cycle	Duty Cycle [%]	U= \pm 2.06 %

8 Appendixes

Appendix No.	Description
SYBH(Z-RF)20190123011002-2004-A	Appendix for Bluetooth BLE

END