



# FCC&ISED RF Test Report

Product Name: HUAWEI MateBook

Model Number: MACHR-W29/MACHR-W19

Report No.: SYBH(Z-RF)20190123011002-2002

FCC ID:QISMACHR-WX9

IC:6369A-MACHRWX9

Authorized	APPROVED (Lab Manager)	PREPARED (Test Engineer)
BY	He Hao	Zhang Shuangxia
DATE	2019-03-18	2019-03-18

**Reliability Laboratory of Huawei Technologies Co., Ltd.**

**(Global Compliance and Testing Center of Huawei Technologies Co., Ltd)**

No.2, New City Avenue, Songshan Lake Sci. & Tech. Industry Park, Dongguan, 523808, P.R.C

Telephone: +86 769 23830808

Fax: +86 769 23837628

**※ ※ Notice ※ ※**

1. The laboratory has passed the accreditation by The American Association for Laboratory Accreditation (A2LA). The accreditation number is 2174.01.
2. The laboratory has been recognized by the US Federal Communications Commission (FCC) to perform compliance testing subject to the Commission's Certification rules. The Designation Number is CN1173, and the Test Firm Registration Number is 294140.
3. The laboratory has been recognized by the Innovation, Science and Economic Development Canada (ISED) to test to Canadian radio equipment requirements. The CAB identifier is CN0003, and the ISED# is 21741.
4. The laboratory (Reliability Lab of Huawei Technologies Co., Ltd) is also named "Global Compliance and Testing Center of Huawei Technologies Co., Ltd", the both names have coexisted since 2009.
5. The test report is invalid if not marked with the signatures of the persons responsible for preparing and approving the test report.
6. The test report is invalid if there is any evidence of erasure and/or falsification.
7. The test report is only valid for the test samples.
8. Content of the test report, in part or in full, cannot be used for publicity and/or promotional purposes without prior written approval from the laboratory.
9. If any question about this report, please contact the laboratory ([PublicGCTC@huawei.com](mailto:PublicGCTC@huawei.com)).

**MODIFICATION RECORD**

No.	Report No	Modification Description
1	SYBH(Z-RF)2019012 3011002-2002	First release.

**DECLARATION**

Type	Description
Multiple Models Applications	<p><input type="checkbox"/> The present report applies to single model.</p> <p><input checked="" type="checkbox"/> The present report applies to several models. The practical measurements are performed with the model <u>MACHR-W29</u>.</p> <p>These models utilize the similar radio design, shielding, interface, physical layout and so on. The differences and modifications between these models are declared by the applicant and showed in General Description</p> <p>All others between these models are identical.</p> <p>The present report only presents the worst test case of all modes, see relevant test results for detailed.</p>

## 1 Table of contents

1	Table of contents .....	4
2	General Information .....	5
2.1	Test standard/s .....	5
2.2	Test Environment .....	5
2.3	Test Laboratories .....	6
2.4	Applicant and Manufacturer .....	6
2.5	Application details .....	6
3	Test Summary .....	7
3.1	Measurement Technical Requirements .....	7
4	Description of the Equipment under Test (EUT) .....	10
4.1	General Description .....	10
4.2	EUT Identity .....	11
4.3	Technical Description .....	13
5	General Test Conditions / Configurations .....	15
5.1	Test Modes .....	15
5.2	EUT Configurations .....	15
5.3	Test Setups .....	17
5.4	Test Conditions .....	18
6	Main Test Instruments .....	19
7	Measurement Uncertainty .....	20
8	Appendixes .....	20

## 2 General Information

### 2.1 Test standard/s

Applied Rules :	47 CFR FCC Part 2, Subpart J 47 CFR FCC Part 15, Subpart C 47 CFR FCC Part 15, Subpart E ISED RSS-Gen Issue 5 ISED RSS-247 Issue2
Test Method :	KDB 789033 D02 General UNII Test Procedures New Rules v02 FCC KDB 558074 D01 DTS Meas Guidance v05r01 FCC KDB 662911 D01 Multiple Transmitter Output v02r01 ANSI C63.10-2013, American National Standard for Testing Unlicensed Wireless Devices

### 2.2 Test Environment

Temperature :	TN	15 to 30	°C during room temperature tests
Ambient Relative Humidity:	20 to 85 %		
Atmospheric Pressure:	Not applicable		
Power supply :	VL	7.4	V
	VN	8.0	V DC by Battery
	VH	8.7	V

NOTE 1: 1) VN= nominal voltage, VL= low extreme test voltage, VH= High extreme test voltage;

TN= normal temperature, TL= low extreme test temperature, TH= High extreme test temperature.

NOTE 2: The values used in the test report may be stringent than the declared.

### 2.3 Test Laboratories

Test Location 1 :	RELIABILITY LABORATORY OF HUAWEI TECHNOLOGIES CO., LTD.
Address of Test Location 1 :	No.2, New City Avenue, Songshan Lake Sci. & Tech. Industry Park, Dongguan, 523808, P.R.C

### 2.4 Applicant and Manufacturer

Company Name :	HUAWEI TECHNOLOGIES CO., LTD
Address :	Administration Building, Headquarters of Huawei Technologies Co., Ltd., Bantian, Longgang District, Shenzhen, 518129, P.R.C

### 2.5 Application details

Date of Receipt Sample:	2019-01-28
Start of test:	2019-01-29
End of test:	2019-03-18

### 3 Test Summary

#### 3.1 Measurement Technical Requirements

##### 3.1.1 U-NII (5150-5250, 5250-5350, 5470-5725 MHz, 5725-5850)

Test Item	Band	FCC Rule No.	ISED Rule No.	Requirements	Test Result	Verdict	Testing location
Emission Bandwidth	5150-5250	15.403(i) 15.407(a)(1)	RSS-gen, §6.7	No limit.	Appendix A1&A2	Pass	Test Location 1
	5250-5350	15.403(i) 15.407(a)(2)	RSS-gen, §6.7				
	5470-5725	15.403(i) 15.407(a)(2)	RSS-gen, §6.7				
	5725-5850	15.403(i) 15.407(e)	RSS-gen, §6.7 RSS-247, §6.2.4.1	≥ 500 kHz.			
Occupied Bandwidth	5150-5250	KDB 789033 D02 § D	RSS-gen, §6.7	No limit.	Appendix B	Pass	Test Location 1
	5250-5350		RSS-gen, §6.7				
	5470-5725		RSS-gen, §6.7				
	5725-5850		RSS-gen, §6.7				
Duty Cycle	5150-5850	KDB 789033 D02 § B	--	No limit.	Appendix C	Pass	Test Location 1
Maximum Average Output Power	5150-5250	15.407(a)(1) 15.407(a)(4)	RSS-247, §6.2.1 RSS-gen, §6.12	FCC: conducted < 250mW (avg during transmission) ISED: e.i.r.p .<MIN{200mW,10dBm+10*Ig(OBW)} (avg during transmission)	Appendix D		
	5250-5350	15.407(a)(2) 15.407(a)(4)	RSS-247, §6.2.2 RSS-gen, §6.12	FCC:conducted <MIN{250mW,11dBm+10*Ig(EBW)} (avg during transmission) ISED: conducted <MIN{250mW,11dBm+10*Ig(OBW)}			



Test Item	Band	FCC Rule No.	ISED Rule No.	Requirements	Test Result	Verdict	Testing location
				(avg during e.i.r.p <MIN{1W,17dBm+10*Ig(OBW)} (avg during transmission)			
	5470-5725	15.407(a)(2) 15.407(a)(4)	RSS-247, §6.2.3 RSS-gen, §6.12	FCC: conducted <MIN{250mW,11dBm+10*Ig(EBW)} (avg during transmission) ISED: conducted <MIN{250mW,11dBm+10*Ig(OBW)} (avg during transmission) e.i.r.p <MIN{1W,17dBm+10*Ig(OBW)} (avg during transmission)			
	5725-5850	15.407(a)(3)	RSS-247, §6.2.4 RSS-gen, §6.12	conducted < 1W (avg during transmission)			
maximum Power Spectral Density	5150-5250	15.407(a)(1) 15.407(a)(4)	RSS-247, §6.2.1	FCC conducted <11dBm/MHz (avg during transmission) ISED: e.i.r.p <10dBm/MHz (avg during transmission)	Appendix E		Test Location 1
	5250-5350	15.407(a)(2) 15.407(a)(4)	RSS-247, §6.2.2	conducted <11dBm/MHz (avg during transmission)			
	5470-5725	15.407(a)(2) 15.407(a)(4)	RSS-247, §6.2.3	conducted <11dBm/MHz (avg during transmission)			
	5725-5850	15.407(a)(3) 15.407(a)(4)	RSS-247, §6.2.4	conducted <30dBm/500KHz (avg during transmission)			
Frequency Stability	5150-5250 5250-5350 5470-5725 5725-5850	15.407(g)	RSS-Gen, 6.11 RSS -gen, §8.11	FCC Part 15.407(g) ISED RSS-Gen, 8.11	Appendix F	Pass	Test Location 1





Test Item	Band	FCC Rule No.	ISED Rule No.	Requirements	Test Result	Verdict	Testing location
NOTE: The transmitter has an integral PCB loop antenna that is enclosed within the housing of the EUT and meets the requirements of FCC 15.203							

## 4 Description of the Equipment under Test (EUT)

### 4.1 General Description

MACHR-W29/MACHR-W19 is a notebook computer,

Which supports 2.4G Wi-Fi, 5G Wi-Fi, and Bluetooth wireless frequency bands. It provides power and fingerprint key switch, one USB type A , two USB type C, and a earphone interfaces.

The difference between MACHR-W29,and MACHR-W19 is show in the following table:

	MACHR-W29 (with GPU version)	MACHR-W29 (without GPU version)	MACHR-W19 (with GPU version)	MACHR-W19 (without GPU version)
PCB layout	The same	The same	The same	The same
Main board	The same	Delete GPU chip and related components	The same	Delete GPU chip and related components
Frequency bands	The same,support Wi-Fi 2.4G&5G,BT 2.4G	The same,support Wi-Fi 2.4G&5G,BT 2.4G	The same,support Wi-Fi 2.4G&5G,BT 2.4G	The same,support Wi-Fi 2.4G&5G,BT 2.4G
BT/ Wi-Fi antenna	The same	The same	The same	The same
Appearance	The same	The same	The same	The same
Dimension	The same	The same	The same	The same
CPU	Whiskey lake-U i7, Support max 4.6GHz	Whiskey lake-U i7, Support max 4.6GHz	Whiskey lake-U i5, Support max 3.9GHz	Whiskey lake-U i5, Support max 3.9GHz
GPU	Support	Not support	Support	Not support
Memory	16/8G	16/8G	8G	8G
SSD	512G/1T	512G/1T	256G/512G	256G/512G
Rear camera	Not support	Not support	Not support	Not support
Front camera	The same	The same	The same	The same

Adapter	The same	The same	The same	The same
Battery	The same	The same	The same	The same
Accessories	The same	The same	The same	The same

Note1: Only 5G WIFI test data included in this report

Note2: We do not test the data of MACHR-W19 except RSE (worst case) and the data is not worsen, So all test data share the MACHR-W29.





















## 4.2 EUT Identity











NOTE: Unless otherwise noted in the report, the functional boards installed in the units shall be selected from the below list, but not means all the functional boards listed below shall be installed in one unit.

### 4.2.1 Board

Board		
Description	Software Version	Hardware Version
Main Board	1.5.0.7(C001)	SP2MACHRW19M

### 4.2.2 Sub-Assembly

Sub-Assembly			
Sub-Assembly Name	Model	Manufacturer	Description
Adapter	HW-200325EP0	Huawei Technologies Co., Ltd.	Input voltage: 100-240V ~50/60Hz 1.8A Output voltage: 5V  2A OR 9V  2A OR 12V  2A OR 15V  3A OR 20V  3.25A
Adapter	HW-200325BP0	Huawei Technologies Co., Ltd.	Input voltage: 100-240V ~50/60Hz 1.8A Output voltage: 5V  2A OR 9V  2A OR 12V  2A OR 15V  3A OR 20V  3.25A
Adapter	HW-200325UP0	Huawei Technologies Co., Ltd.	Input voltage: 100-240V ~50/60Hz 1.8A Output voltage: 5V  2A OR 9V  2A OR 12V  2A OR 15V  3A OR 20V  3.25A
Adapter	HW-200325AP0	Huawei Technologies Co., Ltd.	Input voltage: 100-240V ~50/60Hz 1.8A Output voltage: 5V  2A OR 9V  2A OR 12V  2A OR 15V  3A OR 20V  3.25A
Adapter	HW-200325CP0	Huawei	Input voltage: 100-240V ~50/60Hz 1.8A

Sub-Assembly			
Sub-Assembly Name	Model	Manufacturer	Description
		Technologies Co., Ltd.	Output voltage: 5V  2A OR 9V  2A OR 12V  2A OR 15V  3A OR 20V  3.25A
Adapter	HW-200325JP0	Huawei Technologies Co., Ltd.	Input voltage: 100-240V ~50/60Hz 1.8A Output voltage: 5V  2A OR 9V  2A OR 12V  2A OR 15V  3A OR 20V  3.25A
Battery	HB4593R1ECW	Huawei Technologies Co., Ltd.	Rated capacity: 7410mAh Rated Voltage:  +7.6V Limited Charge Voltage:  +8.7V

### 4.3 Technical Description

Characteristics	Description	
IEEE 802.11 WLAN Mode Supported	<input checked="" type="checkbox"/> 802.11a (20 MHz channel bandwidth), <input checked="" type="checkbox"/> 802.11n (20 MHz channel bandwidth), <input checked="" type="checkbox"/> 802.11n (40 MHz channel bandwidth), <input checked="" type="checkbox"/> 802.11ac (20 MHz channel bandwidth), <input checked="" type="checkbox"/> 802.11ac (40 MHz channel bandwidth), <input checked="" type="checkbox"/> 802.11ac (80 MHz channel bandwidth), <input checked="" type="checkbox"/> 802.11ac (160 MHz channel bandwidth)	
TX/RX Operating Range	All	$f_c = 5000 \text{ MHz} + N * 5 \text{ MHz}$ , where: - $f_c$ = "Operating Frequency" in MHz, - $N$ = "Channel Number".
	5150-5250 MHz (U-NII)	$N = 36$ to $48$ with step of $4$ for the $20 \text{ MHz}$ channel bandwidth. $N = 38$ to $46$ with step of $8$ for the $40 \text{ MHz}$ channel bandwidth. $N = 42$ for the $80 \text{ MHz}$ channel bandwidth. $N = 50$ for the $160 \text{ MHz}$ channel bandwidth
	5250-5350 MHz (U-NII)	$N = 52$ to $64$ with step of $4$ for the $20 \text{ MHz}$ channel bandwidth. $N = 54$ to $62$ with step of $8$ for the $40 \text{ MHz}$ channel bandwidth. $N = 58$ for the $80 \text{ MHz}$ channel bandwidth.
	5470-5600 MHz (U-NII)(for ISSED)	$N = 100$ to $116$ with step of $4$ for the $20 \text{ MHz}$ channel bandwidth. $N = 102$ to $110$ with step of $8$ for the $40 \text{ MHz}$ channel bandwidth. $N = 106$ for the $80 \text{ MHz}$ channel bandwidth.
	5470-5650 MHz (U-NII) (for FCC)	$N = 100$ to $128$ with step of $4$ for the $20 \text{ MHz}$ channel bandwidth. $N = 102$ to $126$ with step of $8$ for the $40 \text{ MHz}$ channel bandwidth. $N = 106$ to $122$ with step of $16$ for the $80 \text{ MHz}$ channel bandwidth. $N = 114$ for the $160 \text{ MHz}$ channel bandwidth.
	5650-5725 MHz (U-NII)	$N = 132$ to $140$ with step of $4$ for the $20 \text{ MHz}$ channel bandwidth. $N = 134$ for the $80 \text{ MHz}$ channel bandwidth.
	5725-5850MHz z(U-NII)	$N = 149$ to $165$ with step of $4$ for the $20 \text{ MHz}$ channel bandwidth. $N = 151$ to $159$ with step of $8$ for the $40 \text{ MHz}$ channel bandwidth. $N = 155$ for the $80 \text{ MHz}$ channel bandwidth.
Modulation Type	802.11a: BPSK/QPSK/16QAM/64QAM (OFDM).	
	802.11n: BPSK/QPSK/16QAM/64QAM (OFDM).	
	802.11ac: BPSK/QPSK/16QAM/64QAM/256QAM (OFDM).	
Emission Designator	U-NII(5150-5250, 5250-5350, 5470-5725, 5725-5850)	17M3G7D (for 802.11a mod), 18M3G7D (for 802.11n 20 MHz mode), 36M8G7D (for 802.11n 40 MHz mode), 18M4G7D (for 802.11ac 20 MHz mode) 36M8G7D (for 802.11ac 40 MHz mode) 75M4G7D (for 802.11ac 80 MHz mode) 154MG7D (for 802.11ac 160 MHz mode)

Characteristics	Description	
TX Power Control (TPC)	<input checked="" type="checkbox"/> Supported, <input type="checkbox"/> Not Supported	
Equipment Type	<input checked="" type="checkbox"/> Stand-alone equipment, <input type="checkbox"/> Plug-in radio device, <input type="checkbox"/> Combined equipment	
Antenna	Description	Isotropic Antenna
	Type	<input checked="" type="checkbox"/> Integral <input type="checkbox"/> External <input type="checkbox"/> Dedicated
	Ports	<input checked="" type="checkbox"/> Ant 1, <input checked="" type="checkbox"/> Ant 2, <input type="checkbox"/> Ant 3, <input type="checkbox"/> Ant 4
	Smart System	<input checked="" type="checkbox"/> SISO (for 802.11a/n/ac), <input checked="" type="checkbox"/> MIMO (for 802.11a/ac), 2 Tx & 2 Rx, <input type="checkbox"/> Diversity (for 802.11a/n/ac) :       Tx &       Rx
	Gain	Ant 1: 2.5 dBi (per antenna port, max.) Ant 2: 2.5 dBi (per antenna port, max.)
	Remark	When the EUT is put into service, the practical maximum antenna gain should NOT exceed the value as described above.
Power Supply	Type	<input type="checkbox"/> External DC mains, <input checked="" type="checkbox"/> Battery, <input checked="" type="checkbox"/> AC/DC Adapter, <input type="checkbox"/> Powered over Ethernet (PoE). <input type="checkbox"/> Other

## 5 General Test Conditions / Configurations

### 5.1 Test Modes

NOTE: Worst cases for each IEEE 802.11 mode are selected to perform tests.

Test Mode	Test Modes Description
11A	IEEE 802.11a with data rate of 6 Mbps using SISO mode.
11N20	IEEE 802.11n with data rate of MCS0 and bandwidth of 20 MHz using SISO mode.
11N20m	IEEE 802.11n with data rate of MCS8 and bandwidth of 20 MHz using MIMO mode.
11N40	IEEE 802.11n with data rate of MCS0 and bandwidth of 40 MHz using SISO mode.
11N40m	IEEE 802.11n with data rate of MCS8 and bandwidth of 40 MHz using MIMO mode.
11AC20	IEEE 802.11ac with data rate of MCS0 and bandwidth of 20 MHz using SISO mode.
11AC20m	IEEE 802.11ac with data rate of MCS8 and bandwidth of 20 MHz using SISO mode.
11AC40	IEEE 802.11ac with data rate of MCS0 and bandwidth of 40 MHz using SISO mode.
11AC40m	IEEE 802.11ac with data rate of MCS8 and bandwidth of 40 MHz using MIMO mode.
11AC80	IEEE 802.11ac with data rate of MCS0 and bandwidth of 80 MHz using SISO mode.
11AC80m	IEEE 802.11ac with data rate of MCS8 and bandwidth of 80 MHz using MIMO mode.
11AC160	IEEE 802.11ac with data rate of MCS0 and bandwidth of 160 MHz using SISO mode.
11AC160m	IEEE 802.11ac with data rate of MCS8 and bandwidth of 160 MHz using MIMO mode.

### 5.2 EUT Configurations

#### 5.2.1 General Configurations

Configuration	Description
Test Antenna Ports	Until otherwise specified, <ul style="list-style-type: none"> <li>All TX tests are performed at all TX antenna ports of the EUT, and</li> <li>All RX tests are performed at all RX antenna ports of the EUT.</li> </ul>
Multiple RF Sources	Other than the tested RF source of the EUT, other RF source(s) are disabled or shutdown during measurements.

#### 5.2.2 Customized Configurations

Test Mode	Antenna Port	Power Conf.,	Duty cycle [%]
11A	Ant 1	9.5	97.86
	Ant 2	9	97.86
11N20	Ant 1	9.5	97.81
	Ant 2	9	97.87
11N20M	Ant 1	6.5	95.02
	Ant 2		95.12



11N40	Ant 1	9.5	96.07
	Ant 2	9	96.07
11N40M	Ant 1	6.5	84.49
	Ant 2		84.49
11AC20	Ant 1	9.5	97.77
	Ant 2	9	97.77
11AC20M	Ant 1	6.5	97.45
	Ant 2		97.45
11AC40	Ant 1	9.5	95.99
	Ant 2	9	95.89
11AC40M	Ant 1	6.5	91.06
	Ant 2		91.06
11AC80	Ant 1	9.5	84.37
	Ant 2	9	84.38
11AC80M	Ant 1	6.5	83.68
	Ant 2		83.68
11AC160	Ant 1	9.5	84.04
	Ant 2	9	83.80
11AC160M	Ant 1	6.5	76.26
	Ant 2		74.87



### 5.3 Test Setups

#### 5.3.1 Test Setup 1

The WLAN component's antenna ports(s) of the EUT are connected to the measurement instrument per an appropriate attenuator. The EUT is controlled by PC/software to emit the specified signals for the purpose of measurements.

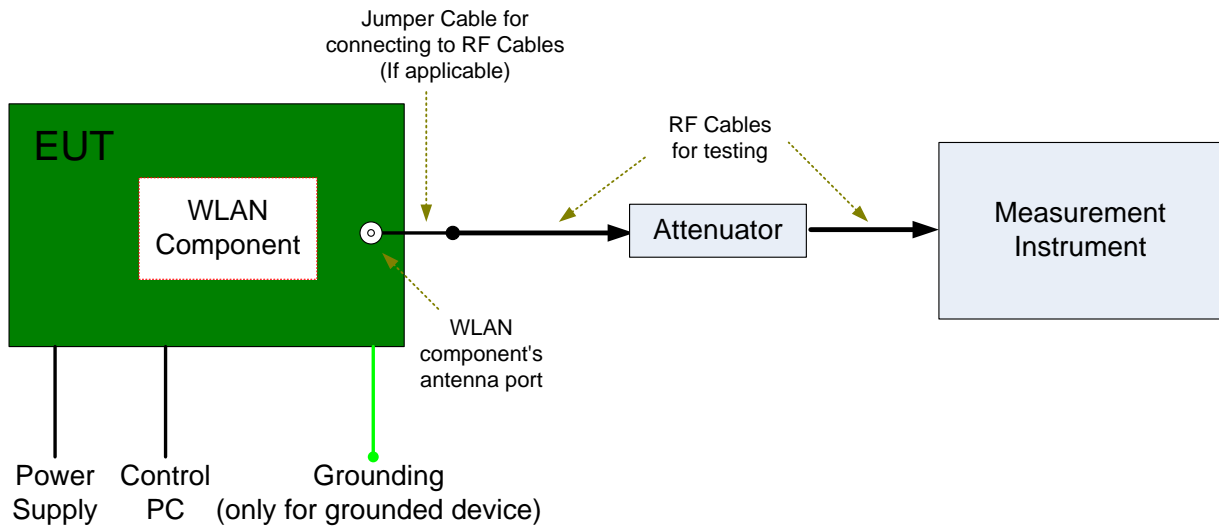

## 5.4 Test Conditions

Test Case	Test Conditions	
	Configuration	Description
Emission Bandwidth (EBW)	Meas. Method	FCC KDB 789033 D02 §C).
	Test Env.	TN/VN
	Test Setup	Test Setup 1
	EUT Conf.	All EUT conf. with Tx modes.
Occupied Bandwidth (OBW)	Meas. Method	FCC KDB 789033 D02 §D).
	Test Env.	TN/VN
	Test Setup	Test Setup 1
	EUT Conf.	All EUT conf. with Tx modes.
Maximum Average Conducted Output Power	Meas. Method	FCC KDB 789033 D02 §E)2)b) Method SA-1 and d) Method SA-2.
	Test Env.	TN/VN
	Test Setup	Test Setup 1
	EUT Conf.	All EUT conf. with Tx modes.
Maximum Power Spectral Density	Meas. Method	FCC KDB 789033 D02 §F).
	Test Env.	TN/VN
	Test Setup	Test Setup 1
	EUT Conf.	All EUT conf. with Tx modes.
Frequency Stability	Meas. Method	15.407(g) Frequency Stability
	Test Env.	(1) -30 °C to +50 °C with step 10 °C at Rated Voltage; (2) VL, VN and VH of Rated Voltage at Ambient Climate.
	Test Setup	Test Setup 1
	EUT Conf.	Ch.36,Ch.165

## 6 Main Test Instruments

This table gives a complete overview of the RF measurement equipment.

Devices used during the test described are marked

<input checked="" type="checkbox"/> Main Test Equipment(BT/WIFI test system)						
Marked	Equipment Name	Manufacturer	Model	Serial Number	Cal Date	Cal-Due
<input type="checkbox"/>	JS1120-3 BT/WIFI test system	JS Tonscend	JS0806-2	188060102	2018/05/30	2019/05/30
<input type="checkbox"/>	Power Detecting & Samplig Unit	R&S	OSP-B157	101429	2018/07/23	2019/07/23
<input type="checkbox"/>	Power Sensor	R&S	NRP2	103085/106211	2018/05/17	2019/05/17
<input checked="" type="checkbox"/>	DC Power Supply	KEITHLEY	2303	1342889	2018/10/24	2019/10/24
<input type="checkbox"/>	DC Power Supply	KEITHLEY	2303	000500E	2018/05/21	2019/05/21
<input type="checkbox"/>	DC Power Supply	KEITHLEY	2303	000381E	2018/05/21	2019/05/21
<input type="checkbox"/>	DC Power Supply	KEITHLEY	2303	000510E	2018/05/21	2019/05/21
<input checked="" type="checkbox"/>	Temperature Chamber	WEISS	WKL64	56246002940010	2018/12/13	2019/12/13
<input type="checkbox"/>	Spectrum Analyzer	Agilent	N9030A	MY51380032	2018/07/23	2019/07/23
<input type="checkbox"/>	Spectrum Analyzer	Agilent	N9030A	MY49431698	2018/07/23	2019/07/23
<input checked="" type="checkbox"/>	Spectrum Analyzer	Keysight	N9040B	MY57212529	2018/06/28	2019/06/28
<input type="checkbox"/>	Signal Analyzer	R&S	FSQ31	200021	2018/07/23	2019/07/23
<input type="checkbox"/>	Signal Analyzer	R&S	FSU26	201069	2018/11/2	2019/11/2
<input type="checkbox"/>	Universal Radio Communication Tester	R&S	CMW500	159302	2018/07/23	2019/07/23
<input type="checkbox"/>	Wireless Communication Test set	Agilent	N4010A	MY49081592	2018/07/23	2019/07/23
<input type="checkbox"/>	Signal generator	Agilent	E8257D	MY51500314	2018/04/27	2019/04/27
<input checked="" type="checkbox"/>	Signal generator	Agilent	E8257D	MY49281095	2018/07/23	2019/07/23
<input type="checkbox"/>	Vector Signal Generator	R&S	SMW200A	103447	2018/05/31	2019/05/31
<input type="checkbox"/>	Vector Signal Generator	R&S	SMU200A	104162	2018/07/23	2019/07/23

## 7 Measurement Uncertainty

For a 95% confidence level ( $k = 2$ ), the measurement expanded uncertainties for defined systems, in accordance with the recommendations of ISO 17025 as following:

Test Item		Extended Uncertainty
Transmit Output Power Data	Power [dBm]	U = 0.58 dB
RF Power Density, Conducted	Power [dBm]	U = 0.64 dB
Bandwidth	Magnitude [kHz]	20MHz: U=41.78kHz 40MHz: U=82.12kHz 80MHz: U=163.5kHz
Frequency Stability	Frequency Accuracy [Hz]	U=82.24Hz
Duty Cycle	Duty Cycle [%]	U=±2.06 %

## 8 Appendixes

Appendix No.	Description
SYBH(Z-RF)20190123011002-2002-A	Appendix_for_5G_WLAN

---

END