



中国认可
国际互认
检测
TESTING
CNAS L0310



FCC&ISED RF Test Report

Product Name: Smart Phone

Model Number: LYA-L0C

Report No.: SYBH(Z-RF)20180808003001-2002

FCC ID: QISLYA-L0C

IC: 6369A-LYAL0C

Reliability Laboratory of Huawei Technologies Co., Ltd.

(Global Compliance and Testing Center of Huawei Technologies Co., Ltd)

Administration Building, Headquarters of Huawei Technologies Co., Ltd., Bantian, Longgang District,
Shenzhen, 518129, P.R.C

Tel: +86 755 28780808

Fax: +86 755 89652518



Notice

1. The laboratory has passed the accreditation by China National Accreditation Service for Conformity Assessment (CNAS). The accreditation number is L0310.
2. The laboratory has passed the accreditation by The American Association for Laboratory Accreditation (A2LA). The accreditation number is 2174.01.
3. The laboratory has been recognized by the US Federal Communications Commission (FCC) to perform compliance testing subject to the Commission's Certification rules. The Designation Number is CN1173, and the Test Firm Registration Number is 294140.
4. The laboratory has been listed by Industry Canada to perform electromagnetic emission measurements. The recognition numbers of test site are 6369A-1.
5. The laboratory (Reliability Lab of Huawei Technologies Co., Ltd) is also named "Global Compliance and Testing Center of Huawei Technologies Co., Ltd", the both names have coexisted since 2009.
6. The test report is invalid if not marked with the signatures of the persons responsible for preparing and approving the test report.
7. The test report is invalid if there is any evidence of erasure and/or falsification.
8. The test report is only valid for the test samples.
9. Content of the test report, in part or in full, cannot be used for publicity and/or promotional purposes without prior written approval from the laboratory.



Applicant: Huawei Technologies Co., Ltd.
Address: Administration Building, Headquarters of Huawei Technologies Co., Ltd.,
 Bantian, Longgang District, Shenzhen, 518129, P.R.C

Date of Receipt Sample: 2018-09-01
Start Date of Test: 2018-09-01
End Date of Test: 2018-09-19

Test Result: Pass

Approved by Senior	2018-09-19	He Hao	<i>He Hao</i>
Engineer:	Date	Name	Signature

Prepared by:	2018-09-19	zhoulingbo	<i>zhoulingbo</i>
	Date	Name	Signature



CONTENT

1 General Information5
1.1 Applied Standard.....5
1.2 Test Location.....5
1.3 Test Environment Condition5
2 Test Summary6
3 Description of the Equipment under Test (EUT)8
3.1 General Description8
3.2 EUT Identity12
3.3 Technical Description13
4 General Test Conditions / Configurations14
4.1 Test Modes14
4.2 EUT Configurations14
4.3 Test Environments17
4.4 Antenna requirements17
4.5 Description of tests18
4.6 Test Setups20
4.7 Test Conditions23
5 Main Test Instruments26
6 Measurement Uncertainty27
7 Appendixes27



1 General Information

1.1 Applied Standard

Applied Rules: 47 CFR FCC Part 2, Subpart J
47 CFR FCC Part 15, Subpart C

ISED RSS-Gen Issue 5
ISED RSS-247 Issue2

Test Method: FCC KDB 558074 D01 DTS Meas Guidance v04
FCC KDB 662911 D01 Multiple Transmitter Output v02r01
ANSI C63.10-2013, American National Standard for Testing Unlicensed Wireless Devices.

1.2 Test Location

Test Location 1: Reliability Laboratory of Huawei Technologies Co., Ltd.
Address1: Administration Building, Headquarters of Huawei Technologies Co., Ltd.,
Bantian, Longgang District, Shenzhen, 518129, P.R.C
Address2: No.2 New City Avenue Songshan Lake Sci. &Tech. Industry Park, Dongguan,
Guangdong, P.R.C

1.3 Test Environment Condition

Ambient Temperature: 19.5to 25 °C
Ambient Relative Humidity: 40 to 55 %
Atmospheric Pressure: Not applicable



2 Test Summary

Test Item	FCC Rule No.	ISED Rule No.	Requirements	Test Result	Verdict
DTS (6 dB) Bandwidth	15.247(a)(2)	RSS-247, 5.2	≥ 500 kHz.	Appendix A	Refer to No.SYBH(Z-RF)2180706013002-2002 of LYA-L29,LYA-L09
Occupied Bandwidth	---	RSS-247, 5.2 RSS-Gen, 6.7	No limit	Appendix B	Refer to No.SYBH(Z-RF)2180706013002-2002 of LYA-L29,LYA-L09
Duty Cycle	KDB 558074 D01 (6.0)	--	No limit	Appendix C	Refer to No.SYBH(Z-RF)2180706013002-2002 of LYA-L29,LYA-L09
Maximum Average Output Power	15.247(b)(3)	RSS-247, 5.4	FCC: For directional gain: Conducted < 30 dBm – (G[dBi] – 6 [dB]); Otherwise: Conducted < 30 dBm, ISED: Conducted < 30 dBm. EIRP < 36 dBm,	Appendix D	Refer to No.SYBH(Z-RF)2180706013002-2002 of LYA-L29,LYA-L09
Maximum Power Spectral Density Level	15.247(e)	RSS-247, 5.2	Conducted < 8 dBm/3 kHz.	Appendix E	Refer to No.SYBH(Z-RF)2180706013002-2002 of LYA-L29,LYA-L09
Band Edges Compliance	15.247(d)	RSS-247, 5.5	< -30 dB/100 kHz if total average power \leq power limit.	Appendix F	Refer to No.SYBH(Z-RF)2180706013002-2002 of LYA-L29,LYA-L09
Unwanted Emissions into Non-Restricted Frequency Bands				Appendix G	Refer to No.SYBH(Z-RF)2180706013002-2002 of LYA-L29,LYA-L09



Test Item	FCC Rule No.	ISED Rule No.	Requirements	Test Result	Verdict
Unwanted Emissions into Restricted Frequency Bands (Radiated)	15.247(d) 15.209 (NOTE 1)	RSS-247, 5.5 RSS-Gen, §6.13 RSS-Gen, 8.10	FCC Part 15.209 field strength limit; RSS-Gen 8.10 field strength limit.	Appendix H	Refer to No.SYBH(Z-RF)2180706013002-2002 of LYA-L29,LYA-L09
AC Power Line Conducted Emissions	15.207	RSS-Gen, 8.8	FCC Part 15.207 conducted limit; RSS-Gen, 8.8 conducted limit.	Appendix I	Refer to No.SYBH(Z-RF)2180706013002-2002 of LYA-L29,LYA-L09

NOTE : According to KDB 558074 D01, antenna-port conducted measurements are acceptable as an alternative to radiated measurements for demonstrating compliance to the limits in the restricted frequency bands. If conducted measurements are performed, then proper impedance matching must be ensured and an additional radiated test for cabinet/case emissions will also be required.



3 Description of the Equipment under Test (EUT)

3.1 General Description

LYA-L0C is a subscriber equipment in the GSM/WCDMA/LTE system. The GSM frequency band includes GSM850 and GSM900 and DCS1800 and PCS1900. The UMTS frequency band is B1 and B2 and B4 and B5 and B6 and B8 and B19. The LTE frequency band is B1 and B2 and B3 and B4 and B5 and B6 and B7 and B8 and B9 and B12 and B17 and B18 and B19 and B20 and B26 and B28 and B34 and B38 and B39 and B40 and B41 and B66. The Mobile Phone implements such functions as RF signal receiving/transmitting, LTE/HSPA/UMTS and GSM/GPRS/EDGE protocol processing, voice, video MMS service, GPS, Bluetooth, NFC, Wi-Fi and Wirelessly Charging etc. LYA-L0C provides one USIM card interface and one HUAWEI Nano SD card interface. Externally it provides type C USB charging port, and the port could be used as the earphone port or data-transfer port.

Below is the difference between LYA-L29 and LYA-L0C

Model	LYA-L29	LYA-L0C														
PCB	The same	The same														
Frequency-GSM	The same	The same														
Frequency-WCDMA	The same	The same														
Frequency-LTE	Different B2/4/5/7/12/17/38/40/41(2545~2655MHz, support AXGP)	Different B2/4/5/7/12/17/38/40/41(2545~2655MHz, support AXGP)/B66														
4*4 Mimo	Different Support B3、B7、B1	Different Support B2、B7、B66(B4) Replace TRI SAW filters of B1/B3/B7 with SAW filters of B2/B66/B7. Replace														
SIM Card	Dual	Single														
RF NV parameters	Different	Different The power of LYA-L0C is different from LYA-L29 by change RF NV parameters. <ul style="list-style-type: none"> Down antenna (Primary) <ol style="list-style-type: none"> 0mm body Scenario <table border="1" style="margin-left: 20px;"> <tr> <td></td> <td>WB2</td> <td>WB4</td> <td>LTEB2</td> <td>LTEB4</td> </tr> <tr> <td>reduce</td> <td>0.5dB</td> <td>0.5dB</td> <td>0.5dB</td> <td>1.5dB</td> </tr> </table> 10mm hotspot Scenario <table border="1" style="margin-left: 20px;"> <tr> <td></td> <td>LTEB4</td> </tr> <tr> <td>reduce</td> <td>0.5dB</td> </tr> </table> Up antenna (Secondary) Head Scenario 		WB2	WB4	LTEB2	LTEB4	reduce	0.5dB	0.5dB	0.5dB	1.5dB		LTEB4	reduce	0.5dB
	WB2	WB4	LTEB2	LTEB4												
reduce	0.5dB	0.5dB	0.5dB	1.5dB												
	LTEB4															
reduce	0.5dB															



		<table border="1"> <tr> <td></td> <td>WB2</td> <td>WB4</td> <td>LTEB2</td> </tr> <tr> <td>rise</td> <td>1dB</td> <td>1dB</td> <td>1dB</td> </tr> </table>		WB2	WB4	LTEB2	rise	1dB	1dB	1dB
	WB2	WB4	LTEB2							
rise	1dB	1dB	1dB							
Hardware	<p>Different</p> <p>Location ID: Z4102, Z4302, Z4401</p> <p>Description: B1/3/7 Tri saw filter, 2140MHz.</p> <p>Location ID: Z4103</p> <p>Description: SAW filter -1960MHz</p>	<p>Different</p> <p>1) Replace TRI SAW filters of B1/B3/B7 with SAW filters of B2/B66/B7.</p> <p>Replace</p> <p>Location ID: Z4102, Z4302, Z4401</p> <p>Description: B2/B66/B7 Tri saw filter, 2655MHz.</p> <p>2) Delete some chip inductors in Peripheral RF Matching circuits of the diversity circuit, MIMO main circuit, and MIMO diversity circuit.</p> <p>Delete</p> <p>Location ID: L4126 L4127 L4130 L3506</p> <p>Description: Chip inductor 0.018uH/0.001uH/0.0022uH/0.0039uH</p> <p>3) Delete The circuits related to the B32 frequency band.</p> <p>Delete:</p> <p>Location ID: Z3502, Z4104</p> <p>Description: B32 saw filter 1474MHz</p> <p>Location ID: C3512, C5401, C5405</p> <p>Description: Ceramic capacitor 0.033nF</p> <p>Location ID: Z5403</p> <p>Description: Ceramic filter -1710MHz</p> <p>Location ID: U3503, U4101</p> <p>Description: RF low noise amplifier -1559~1610MHz</p> <p>4) Replace B3 SAW filter with B2 SAW filter and slight change of Peripheral RF matching circuits.</p> <p>Replace:</p> <p>Location ID: Z4103</p> <p>Description: SAW filter -1842.5MHz</p> <p>Delete:</p> <p>Location ID: L3502 L3516 L4129</p> <p>Description: Chip inductor 0.0056uH/0.002uH/0.0075uH</p> <p>Location ID: C3514, C4110</p> <p>Description: Ceramic capacitor 0.018nF</p>								
Software	Different	Different								
Dimensions	The same	The same								
Appearance	The same	The same								



main antenna	The same	The same
BT/Wi-Fi antenna	The same	The same
DIV antenna	The same	The same
Supported CA configurations for DL CA	<p>Different</p> <p>support:CA_1A-3A CA_1C-3A CA_1A-3C CA_1A-3A-3A CA_1C-3C CA_1A-3D CA_1C-3D CA_1A-7A-7A CA_1A-32A CA_1A-38A CA_1A-38C CA_1A-40A CA_1A-40C CA_1A-41A CA_1A-41C CA_3A-3A-7A CA_3A-7A-7A CA_3A-3A-7A-7A CA_3A-3A-8A CA_3A-32A CA_3C-32A CA_3A-38A CA_3C-38A CA_3A-38C CA_3C-38C CA_3A-40A CA_3A-40C CA_3A-40D CA_3A-41A CA_7A-7A-8A CA_7A-32A CA_8A-32A CA_20A-32A CA_1A-3A-5A CA_1A-3C-5A CA_1A-3A-7A CA_1C-3A-7A CA_1A-3C-7A CA_1A-3A-3A-7A CA_1A-3A-7C CA_1A-3A-7A-7A CA_1C-3C-7A CA_1A-3A-3A-7A-7A CA_1A-3A-8A CA_1A-3C-8A CA_1A-3A-19A CA_1A-3A-20A CA_1A-3C-20A CA_1A-3A-26A CA_1A-3A-28A CA_1A-3C-28A CA_1A-3A-32A CA_1A-3A-38A CA_1A-3C-38A CA_1A-3A-38C CA_1A-3C-38C CA_1A-28A-40C CA_3A-3A-7A-8A CA_3A-7A-7A-8A CA_3A-3A-7A-7A-8A CA_3A-3A-7A-20A CA_3A-7A-32A CA_3C-7A-32A CA_3A-8A-38A CA_3C-8A-38A CA_3A-20A-32A CA_3A-28A-40A CA_3A-28A-40C CA_3A-28A-40D CA_7A-8A-32A CA_7A-20A-32A CA_1A-3A-7A-8A CA_1A-3C-7A-8A CA_1A-3A-7A-20A CA_1A-3C-7A-20A CA_1A-3A-7A-28A CA_1A-3A-7C-28A CA_1A-3A-7A-32A CA_1A-3A-8A-38A CA_1A-3A-20A-32A CA_1A-3A-28A-40A CA_1A-3A-28A-40C CA_1A-7A-20A-32A CA_3A-7A-20A-32A CA_1A-3A-7A-20A-32A</p> <p>unsupport:CA_66B CA_66C CA_66D CA_2A-2A CA_4A-4A CA_12A-12A</p>	<p>Different</p> <p>unsupport:CA_1A-3A CA_1C-3A CA_1A-3C CA_1A-3A-3A CA_1C-3C CA_1A-3D CA_1C-3D CA_1A-7A-7A CA_1A-32A CA_1A-38A CA_1A-38C CA_1A-40A CA_1A-40C CA_1A-41A CA_1A-41C CA_3A-3A-7A CA_3A-7A-7A CA_3A-3A-7A-7A CA_3A-3A-8A CA_3A-32A CA_3C-32A CA_3A-38A CA_3C-38A CA_3A-38C CA_3C-38C CA_3A-40A CA_3A-40C CA_3A-40D CA_3A-41A CA_7A-7A-8A CA_7A-32A CA_8A-32A CA_20A-32A CA_1A-3A-5A CA_1A-3C-5A CA_1A-3A-7A CA_1C-3A-7A CA_1A-3C-7A CA_1A-3A-3A-7A CA_1A-3A-7C CA_1A-3A-7A-7A CA_1C-3C-7A CA_1A-3A-3A-7A-7A CA_1A-3A-8A CA_1A-3C-8A CA_1A-3A-19A CA_1A-3A-20A CA_1A-3C-20A CA_1A-3A-26A CA_1A-3A-28A CA_1A-3C-28A CA_1A-3A-32A CA_1A-3A-38A CA_1A-3C-38A CA_1A-3A-38C CA_1A-3C-38C CA_1A-28A-40C CA_3A-3A-7A-8A CA_3A-7A-7A-8A CA_3A-3A-7A-7A-8A CA_3A-3A-7A-20A CA_3A-7A-32A CA_3C-7A-32A CA_3A-8A-38A CA_3C-8A-38A CA_3A-20A-32A CA_3A-28A-40A CA_3A-28A-40C CA_3A-28A-40D CA_7A-8A-32A CA_7A-20A-32A CA_1A-3A-7A-8A CA_1A-3C-7A-8A CA_1A-3A-7A-20A CA_1A-3C-7A-20A CA_1A-3A-7A-28A CA_1A-3A-7C-28A CA_1A-3A-7A-32A CA_1A-3A-8A-38A CA_1A-3A-20A-32A CA_1A-3A-28A-40A CA_1A-3A-28A-40C CA_1A-7A-20A-32A CA_3A-7A-20A-32A CA_1A-3A-7A-20A-32A</p> <p>support:CA_66B CA_66C CA_66D CA_2A-2A CA_4A-4A CA_12A-12A CA_66A-66A CA_2A-4A CA_2C-4A CA_2A-4A-4A</p>



	CA_66A-66A CA_2A-4A CA_2C-4A CA_2A-4A-4A CA_2A-5A CA_2A-7A CA_2A-7C CA_2A-7A-7A CA_2A-12A CA_2A-2A-12A CA_2A-12B CA_2A-12A-12A CA_2A-17A CA_2A-28A CA_2A-66A CA_2A-2A-66A CA_4A-5A CA_4A-4A-5A CA_4A-7A CA_4A-4A-7A CA_4A-7C CA_4A-7A-7A CA_4A-12A CA_4A-4A-12A CA_4A-12B CA_4A-12A-12A CA_4A-17A CA_4A-28A CA_7A-12A CA_7A-12B CA_7A-12A-12A CA_7A-66A CA_7C-66A CA_7A-66A-66A CA_7C-66A-66A CA_12A-66A CA_12B-66A CA_12A-66A-66A CA_2A-4A-5A CA_2A-4A-7A CA_2A-4A-7C CA_2A-4A-7A-7A CA_2A-4A-12A CA_2A-4A-12A-12A CA_2A-4A-28A CA_2A-7A-12A CA_2A-7A-12B CA_2A-7A-12A-12A CA_2A-7A-66A CA_2A-12A-66A CA_2A-2A-12A-66A CA_2A-12B-66A CA_4A-5A-7A CA_4A-7A-12A CA_4A-7A-12B CA_4A-7A-12A-12A CA_7A-12A-66A CA_7A-12B-66A CA_2A-4A-7A-12A CA_2A-7A-12A-66A CA_2A-7A-12B-66A	CA_2A-5A CA_2A-7A CA_2A-7C CA_2A-7A-7A CA_2A-12A CA_2A-2A-12A CA_2A-12B CA_2A-12A-12A CA_2A-17A CA_2A-28A CA_2A-66A CA_2A-2A-66A CA_4A-5A CA_4A-4A-5A CA_4A-7A CA_4A-4A-7A CA_4A-7C CA_4A-7A-7A CA_4A-12A CA_4A-4A-12A CA_4A-12B CA_4A-12A-12A CA_4A-17A CA_4A-28A CA_7A-12A CA_7A-12B CA_7A-12A-12A CA_7A-66A CA_7C-66A CA_7A-66A-66A CA_7C-66A-66A CA_12A-66A CA_12B-66A CA_12A-66A-66A CA_2A-4A-5A CA_2A-4A-7A CA_2A-4A-7C CA_2A-4A-7A-7A CA_2A-4A-12A CA_2A-4A-12A-12A CA_2A-4A-28A CA_2A-7A-12A CA_2A-7A-12B CA_2A-7A-12A-12A CA_2A-7A-66A CA_2A-12A-66A CA_2A-2A-12A-66A CA_2A-12B-66A CA_4A-5A-7A CA_4A-7A-12A CA_4A-7A-12B CA_4A-7A-12A-12A CA_7A-12A-66A CA_7A-12B-66A CA_2A-4A-7A-12A CA_2A-7A-12A-66A CA_2A-7A-12B-66A CA_2A-7A-7A-66A-66A CA_2A-7A-7A-66A CA_2A-7A-66A-66A CA_7A-7A-66A CA_7A-7A-66A-66A CA_2A-66A-66A
Supported CA configurations for UL CA	Different support:CA_3A-20A CA_7A-20A	Different Unsupport:CA_3A-20A CA_7A-20A
Others	NA	NA

NOTE1: For 2.4G WLAN of LYA-L0C, it is the same as LYA-L29, so all data refer to No. SYBH(Z-RF)20180706013002-2002 of LYA-L29,LYA-L09















3.2 EUT Identity

NOTE: Unless otherwise noted in the report, the functional boards installed in the units shall be selected from the below list, but not means all the functional boards listed below shall be installed in one unit.

3.2.1 Board

Board		
Description	Software version	Hardware version
Main Board	5.0.1.82(C792E4R1P9log)	HL2LAYAM

3.2.2 Sub- Assembly

Sub-Assembly			
Sub-Assembly Name	Model	Manufacturer	Description
Adapter	HW-100400A00	Huawei Technologies Co.,Ltd.	Input Voltage:100V-240V~50/60Hz, 1.2A Output Voltage: 5V  2A OR 9V  2A OR 10V  4A
Adapter	HW-100400U00	Huawei Technologies Co.,Ltd.	Input Voltage:100V-240V~50/60Hz, 1.2A Output Voltage: 5V  2A OR 9V  2A OR 10V  4A
Adapter	HW-100400E00	Huawei Technologies Co.,Ltd.	Input Voltage:100V-240V~50/60Hz, 1.2A Output Voltage: 5V  2A OR 9V  2A OR 10V  4A
Adapter	HW-100400B00	Huawei Technologies Co.,Ltd.	Input Voltage:100V-240V~50/60Hz, 1.2A Output Voltage: 5V  2A OR 9V  2A OR 10V  4A
Li-ion Polymer Battery	HB486486ECW	Huawei Technologies Co.,Ltd.	Rated capacity: 4100mAh Nominal Voltage: +3.82V Charging Voltage: +4.4V



3.3 Technical Description

Characteristics	Description		
IEEE 802.11 WLAN Mode Supported	<input checked="" type="checkbox"/> 802.11b (20 MHz channel bandwidth), <input checked="" type="checkbox"/> 802.11g (20 MHz channel bandwidth) <input checked="" type="checkbox"/> 802.11n (20 MHz channel bandwidth), <input checked="" type="checkbox"/> 802.11n (40 MHz channel bandwidth)		
TX/RX Operating Range	2412-2462 MHz band	$f_c = 2407 \text{ MHz} + N * 5 \text{ MHz}$, where: <ul style="list-style-type: none"> - f_c = "Operating Frequency" in MHz, - N = "Channel Number" with the range from 1 to 11 for the 20 MHz channel bandwidth, or 3 to 9 for the 40 MHz channel bandwidth. 	
Data Rate	802.11b	1 Mbps, 2 Mbps, 5.5 Mbps, 11 Mbps	
	802.11g	6 Mbps, 9 Mbps, 12 Mbps, 18 Mbps, 24 Mbps, 36 Mbps, 48 Mbps, 54 Mbps	
	802.11g(CDD)	6 Mbps, 9 Mbps, 12 Mbps, 18 Mbps, 24 Mbps, 36 Mbps, 48 Mbps, 54 Mbps	
	802.11n (SISO)	MCS 0 to MCS 7	
	802.11n (MIMO)	MCS 8 to MCS 15	
Modulation Type	DBPSK/DQPSK/CCK (DSSS), BPSK/QPSK/16QAM/64QAM (OFDM).		
Emission Designator	11M8G7D (for 802.11b mode), 16M8G7D (for 802.11g mod), 17M5G7D (for 802.11n20 mode) 36M3G7D (for 802.11n40 mode)		
TX Power Control	<input type="checkbox"/> Supported, <input checked="" type="checkbox"/> Not Supported		
Standby Mode	<input type="checkbox"/> Supported, <input checked="" type="checkbox"/> Not Supported		
Equipment Type	<input type="checkbox"/> Stand-alone equipment, <input type="checkbox"/> Plug-in radio device, <input checked="" type="checkbox"/> Combined equipment		
Antenna	Description	Isotropic Antenna	
	Type	<input type="checkbox"/> External, <input checked="" type="checkbox"/> Integrated	
	Ports	<input checked="" type="checkbox"/> Ant 1, <input checked="" type="checkbox"/> Ant 2, <input type="checkbox"/> Ant 3	
	Smart System	<input checked="" type="checkbox"/> SISO (for 802.11b/g/n), <input checked="" type="checkbox"/> MIMO (for 802.11n): 2 Tx & 2 Rx, <input checked="" type="checkbox"/> CDD (for 802.11g): 2 Tx & 2 Rx, <input type="checkbox"/> Diversity (for 802.11b/g) : Tx & Rx	
	Gain	ANT1:-1.19 dBi (per antenna port, max.) ANT2:-4.15 dBi(per antenna port, max.)	
	Remark	When the EUT is put into service, the practical maximum antenna gain should NOT exceed the value as described above.	
Power Supply	Type	<input checked="" type="checkbox"/> AC/DC Adapter	<input type="checkbox"/> PoE: <input type="checkbox"/> Other:



4 General Test Conditions / Configurations

4.1 Test Modes

NOTE: Worst cases for each IEEE 802.11 mode are selected to perform tests.

Test Mode	Test Modes Description
11B	IEEE 802.11b with data rate of 1 Mbps using SISO mode.
11G	IEEE 802.11g with data rate of 6 Mbps using SISO mode.
11G CDD	IEEE 802.11g with data rate of 6 Mbps using CDD mode.
11N20	IEEE 802.11n with data rate of MCS0 and bandwidth of 20 MHz using SISO mode.
11N20m	IEEE 802.11n with data rate of MCS8 and bandwidth of 20 MHz using MIMO mode.
11N40	IEEE 802.11n with data rate of MCS0 and bandwidth of 40 MHz using SISO mode.
11N40m	IEEE 802.11n with data rate of MCS8 and bandwidth of 40 MHz using MIMO mode.

4.2 EUT Configurations

4.2.1 General Configurations

Configuration	Description
Test Antenna Ports	Until otherwise specified, <ul style="list-style-type: none"> - All TX tests are performed at all TX antenna ports of the EUT, and - All RX tests are performed at all RX antenna ports of the EUT.
Multiple RF Sources	Other than the tested RF source of the EUT, other RF source(s) are disabled or shutdown during measurements.

4.2.2 Customized Configurations

Test Mode	RF Ch.	TX Freq. [MHz]	Antenna Port	RX Freq. [MHz]	Ch. BW [MHz]	Power Conf., per Port	Duty cycle [%]
11B	L	Ch No. 1 / 2412 MHz	Ant1	---	20	17	99.8
			Ant2	---	20	17.5	99.8
	M	Ch No. 6 / 2437 MHz	Ant1	---	20	17	99.8
			Ant2	---	20	17.5	99.8
	H	Ch No. 11 / 2462 MHz	Ant1	---	20	17	99.8
			Ant2	---	20	17.5	99.8
11G	L	Ch No. 1 / 2412 MHz	Ant1	---	20	11.5	98.6
			Ant2	---	20	11.5	98.4
	L	Ch No. 2/ 2417 MHz	Ant1	---	20	16	98.6
			Ant2	---	20	16.5	98.4
	M	Ch No. 6 / 2437 MHz	Ant1	---	20	16	98.6



Test Mode	RF Ch.	TX Freq. [MHz]	Antenna Port	RX Freq. [MHz]	Ch. BW [MHz]	Power Conf., per Port	Duty cycle [%]	
			Ant2	---	20	16.5	98.4	
			Ant1	---	20	16	98.6	
	H	Ch No. 10 / 2457 MHz	Ant2	---	20	16.5	98.4	
			Ant1	---	20	11.5	98.6	
	H	Ch No. 11 / 2462 MHz	Ant2	---	20	11.5	98.4	
			Ant1	---	20	11.5	98.6	
11G CDD	L	Ch No. 1 / 2412 MHz	Ant1	---	20	11.5	98.6	
			Ant2	---	20	11.5	98.8	
	L	Ch No. 2/ 2417 MHz	Ant1	---	20	16	98.6	
			Ant2	---	20	16.5	98.8	
	M	Ch No. 6 / 2437 MHz	Ant1	---	20	16	98.6	
			Ant2	---	20	16.5	98.8	
	H	Ch No. 10 / 2457 MHz	Ant1	---	20	16	98.6	
			Ant2	---	20	16.5	98.8	
	H	Ch No. 11 / 2462 MHz	Ant1	---	20	11.5	98.6	
			Ant2	---	20	11.5	98.8	
	11N20	L	Ch No. 1 / 2412 MHz	Ant1	---	20	11.5	98.8
				Ant2	---	20	11.5	98.9
L		Ch No. 2/ 2417 MHz	Ant1	---	20	15	98.8	
			Ant2	---	20	15.5	98.9	
M		Ch No. 6 / 2437 MHz	Ant1	---	20	15	98.8	
			Ant2	---	20	15.5	98.9	
H		Ch No. 10 / 2457 MHz	Ant1	---	20	15	98.8	
			Ant2	---	20	15.5	98.9	
H		Ch No. 11 / 2462 MHz	Ant1	---	20	11.5	98.8	
			Ant2	---	20	11.5	98.9	
11N20m	L	Ch No. 1 / 2412 MHz	Ant1	---	20	11.5	97	
			Ant2	---	20	11.5	96.8	
	L	Ch No. 2/ 2417 MHz	Ant1	---	20	15	97	
			Ant2	---	20	15.5	96.8	
	M	Ch No. 6 / 2437 MHz	Ant1	---	20	15	97	
			Ant2	---	20	15.5	96.8	
	H	Ch No. 10 / 2457 MHz	Ant1	---	20	15	97	
			Ant2	---	20	15.5	96.8	
	H	Ch No. 11 / 2462 MHz	Ant1	---	20	11.5	97	
			Ant2	---	20	11.5	96.8	
11N40	L	Ch No. 3 / 2422 MHz	Ant1	---	40	10	97.2	
			Ant2	---	40	10	97.2	
	L	Ch No. 4 / 2427 MHz	Ant1	---	40	13.5	97.2	
			Ant2	---	40	14	97.2	
	M	Ch No. 6 / 2437 MHz	Ant1	---	40	13.5	97.2	



Test Mode	RF Ch.	TX Freq. [MHz]	Antenna Port	RX Freq. [MHz]	Ch. BW [MHz]	Power Conf., per Port	Duty cycle [%]
	H	Ch No. 8 / 2447MHz	Ant2	---	40	14	97.2
			Ant1	---	40	13.5	97.2
			Ant2	---	40	14	97.2
	H	Ch No. 9 / 2452 MHz	Ant1	---	40	10	97.2
			Ant2	---	40	10	97.2
	11N40m	L	Ch No. 3 / 2422 MHz	Ant1	---	40	10
Ant2				---	40	10	94.7
L		Ch No. 4 / 2427 MHz	Ant1	---	40	13.5	94.4
			Ant2	---	40	14	94.7
M		Ch No. 6 / 2437 MHz	Ant1	---	40	13.5	94.4
			Ant2	---	40	14	94.7
H		Ch No. 8 / 2447MHz	Ant1	---	40	13.5	94.4
			Ant2	---	40	14	94.7
H		Ch No. 9 / 2452 MHz	Ant1	---	40	10	94.4
			Ant2	---	40	10	94.7



4.3 Test Environments

NOTE: The values used in the test report may be stringent than the declared.

Environment Parameter	Selected Values During Tests		
	Temperature	Voltage	Relative Humidity
NTNV	Ambient	3.82VDC	Ambient

4.4 Antenna requirements

Excerpt from §15.203 of the FCC Rules/Regulations:

“An intentional radiator antenna shall be designed to ensure that no antenna other than that furnished by the responsible party can be used with the device. The use of a permanently attached antenna or of an antenna that uses a unique coupling to the intentional radiator shall be considered sufficient to comply with the provisions of this section.”

The antennas of the **LYA-L0C** are **permanently attached**.

There are no provisions for connection to an external antenna.

Conclusion:

The EUT **FCC ID: QISLYA-L0C** unit complies with the requirement of §15.203.

Ch. Frequency (MHz)

Ch.	Frequency (MHz)
01	2412
.	.
.	.
06	2437
.	.
.	.
11	2462

Frequency/ Channel Operations



4.5 Description of tests

4.5.1 Bandwidth measurement

- (a) Connect EUT test port to spectrum analyzer.
- (b) Set the EUT to transmit maximum output power at 2.4GHz, then set the measured frequency number and test the bandwidth with spectrum analyzer.

4.5.2 Average output power

- (a) Connect EUT test port to spectrum analyzer.
- (b) Set the EUT to transmit maximum output power at 2.4GHz.
- (c) Then set the EUT to transmit at high, middle and low frequency and measure the conducted output power separately.

4.5.3 Band edge spurious emission

- (a) Connect EUT test port to spectrum analyzer
- (b) Set the EUT to transmit maximum output power at 2.4GHz.
- (c) Then set the EUT to transmit at high, low frequency and measure the conducted band edge spurious separately.

4.5.4 Conducted RF spurious

- (a) Connect EUT test port to spectrum analyzer
- (b) Set the EUT to transmit maximum output power at 2.4GHz.
- (c) Then set the EUT to transmit at high, middle and low frequency and measure the conducted spurious separately.

4.5.5 Power spectral density

- (a) Connect EUT test port to spectrum analyzer
- (b) Set the EUT to transmit maximum output power at 2.4GHz.
- (c) Then set the EUT to transmit at high, middle and low frequency and measure the conducted power spectral density.

4.5.6 Radiated spurious emission & spurious in restricted band

For frequency below 1GHz, the test site semi-anechoic chamber has met the requirement of NSA tolerance 4dB according to the standards: ANSI C63.10 (2013). The EUT was set-up on insulator 80cm above the Ground Plane. For frequency above 1GHz, the test site full-anechoic chamber has met the requirement of ANSI C63.10 (2013). The EUT was set-up on insulator 150cm above the Ground Plane.

The set-up and test methods were according to ANSI C63.10:2013. The Radiated Disturbance measurements were made using a Rohde and Schwarz Test Receiver and control software.

A preliminary scan and a final scan of the emissions were made by using test script of software; the emissions were measured using a Quasi-Peak Detector below 1GHz, Peak Detector and AV Detector above 1GHz. The maximal emission value was acquired by adjusting the antenna height, polarisation and turntable azimuth in accordance with the software setup. Normally, the height range of antenna



was 1m to 4m, and the azimuth range of turntable was 0° to 360°. The receive antenna has two polarizations V and H.

A portable or small unlicensed wireless device shall be placed on a non-metallic test fixture or other nonmetallic support during testing. The supporting fixture shall permit orientation of the EUT in each of three orthogonal (x, y, z) axis positions such that emissions from the EUT are maximized.

The EUT communicates with the BTS simulator through Air interface. The EUT operated on the typical channel.

Measurement bandwidth: 30 MHz – 1000 MHz: 120 kHz

Measurement bandwidth: 1000 MHz – 10th Carrier Frequency: 1 MHz

4.5.7 Conducted Emission at Power Port

The Table-top EUT was placed upon a non-metallic table 0.8 m above the horizontal metal reference ground plane. EUT was connected to LISN and LISN was connected to reference Ground Plane. EUT was 80cm from LISN. The set-up and test methods were according to ANSI C63.10: 2013.

Conducted Disturbance at AC Port measurements were undertaken on the L and N Lines. The emissions were measured using a Quasi-Peak Detector and Average Detector.

The EUT communicates with the BTS simulator through Air interface, the BTS simulator controls the Wireless Modem to transmit the maximum power which defined in specification of product. The Wireless Modem operated on the typical channel.

Measurement bandwidth (RBW) for 150kHz to 30 MHz: 9 kHz;

4.6 Test Setups

4.6.1 Test Setup 1

The WLAN component's antenna ports(s) of the EUT are connected to the measurement instrument per an appropriate attenuator. The EUT is controlled by PC/software to emit the specified signals for the purpose of measurements.

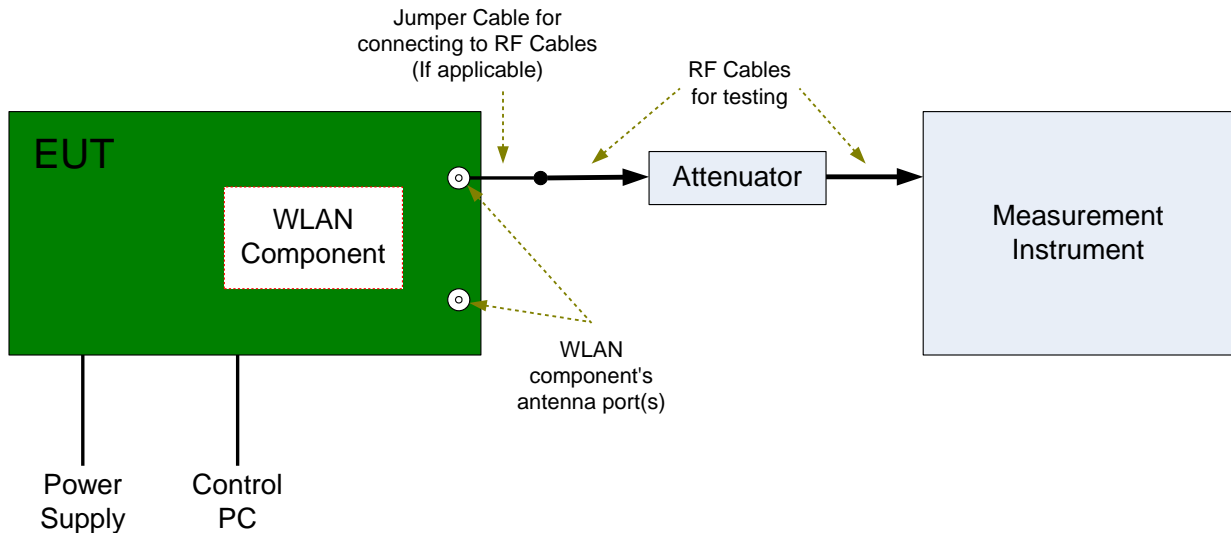

4.6.2 Test Setup 2

The semi-anechoic chamber and full-anechoic chamber has met the requirement of ANSI C63.4. The test distance is 3m. The setup is according to ANSI C63.4 and CAN/CSA-CEI/IEC CISPR 22.

The maximal emission value is acquired by adjusting the antenna height, polarisation and turntable azimuth. Normally, the height range of antenna is 1 m to 4 m, the azimuth range of turntable is 0° to 360°, and the receive antenna has two polarizations Vertical (V) and Horizontal (H).

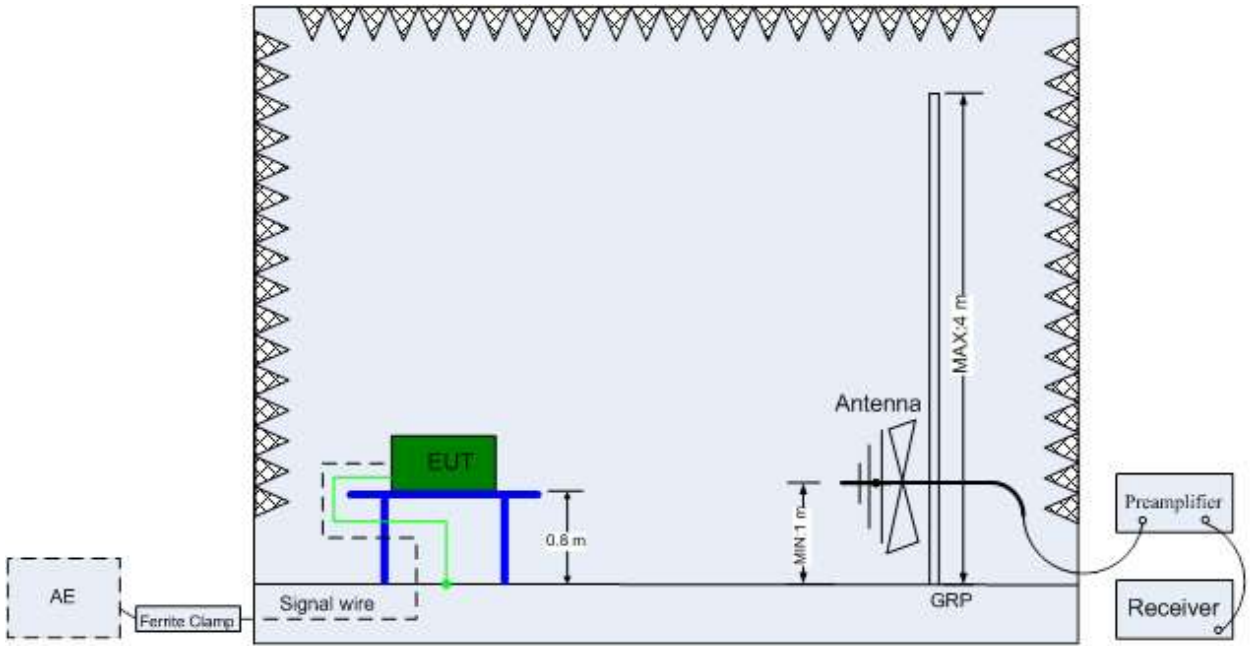

(Below 1 GHz)

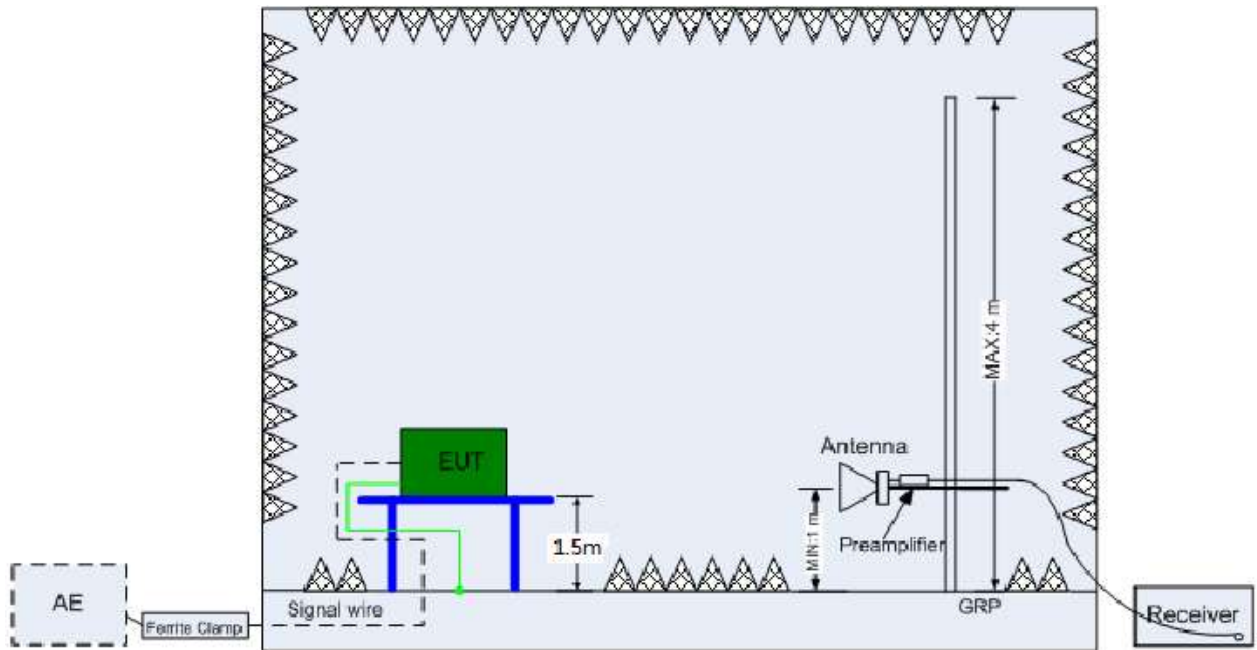

(Above 1 GHz)

4.6.3 Test Setup 3

The mains cable of the EUT (maybe per AC/DC Adapter) must be connected to LISN. The LISN shall be placed 0.8 m from the boundary of EUT and bonded to a ground reference plane for LISN mounted on top of the ground reference plane. This distance is between the closest points of the LISN and the EUT. All other units of the EUT and associated equipment shall be at least 0.8 m from the LISN.

Ground connections, where required for safety purposes, shall be connected to the reference ground point of the LISN and, where not otherwise provided or specified by the manufacturer, shall be of same length as the mains cable and run parallel to the mains connection at a separation distance of not more than 0.1 m.

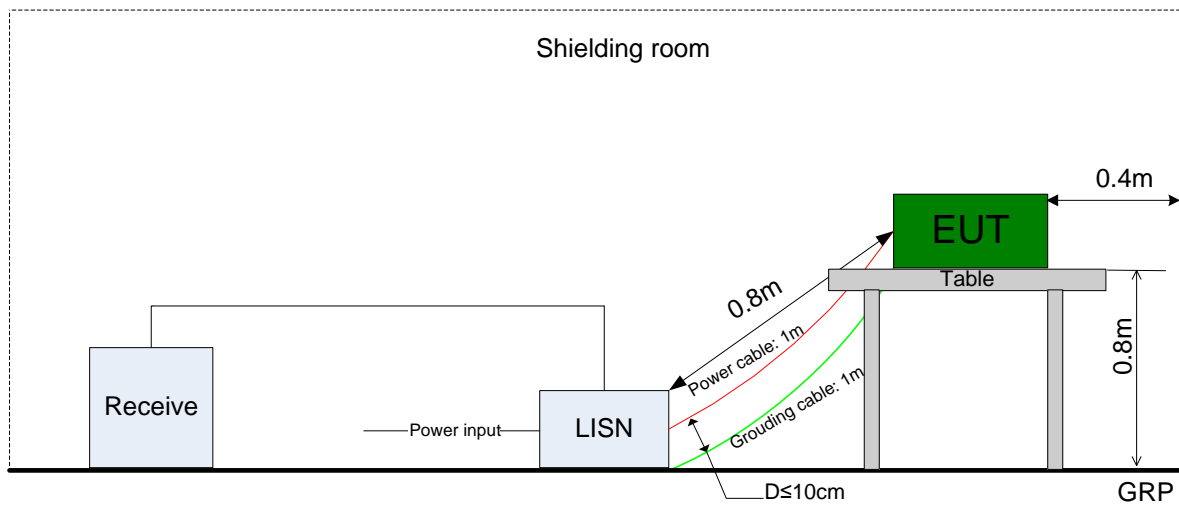



4.7 Test Conditions

Test Case	Test Conditions	
	Configuration	Description
DTS (6 dB) Bandwidth	Measurement Method	FCC KDB 558074 D01 §8.1 Option 2.
	Test Environment	NTNV
	Test Setup	Test Setup 1
	EUT Configuration	11B_L@Ant1, 11B_L@Ant2, 11B_M@Ant1, 11B_M@Ant2, 11B_H@Ant1, 11B_H@Ant2, 11G_L@Ant1, 11G_L@Ant2, 11G_M@Ant1, 11G_M@Ant2, 11G_H@Ant1, 11G_H@Ant2, 11N20_L@Ant1, 11N20_L@Ant2, 11N20_M@Ant1, 11N20_M@Ant2, 11N20_H@Ant1, 11N20_H@Ant2, 11N20m_L@Ant1, 11N20m_L@Ant2, 11N20m_M@Ant1, 11N20m_M@Ant2, 11N20m_H@Ant1, 11N20m_H@Ant2, 11N40_L@Ant1, 11N40_L@Ant2, 11N40_M@Ant1, 11N40_M@Ant2, 11N40_H@Ant1, 11N40_H@Ant2, 11N40m_L@Ant1, 11N40m_L@Ant2, 11N40m_M@Ant1, 11N40m_M@Ant2, 11N40m_H@Ant1, 11N40m_H@Ant2, 11G_CDD L@ Ant 1 11G_CDD M @Ant 1 11G_CDD H @Ant 1 11G_CDD L@ Ant 2 11G_CDD M@ Ant 2 11G_CDD H @Ant 2
Occupied Bandwidth	Measurement Method	FCC KDB 558074 D01 §8.2 Option 2.
	Test Environment	NTNV
	Test Setup	Test Setup 1
	EUT Configuration	11B_L@Ant1, 11B_L@Ant2, 11B_M@Ant1, 11B_M@Ant2, 11B_H@Ant1, 11B_H@Ant2, 11G_L@Ant1, 11G_L@Ant2, 11G_M@Ant1, 11G_M@Ant2, 11G_H@Ant1, 11G_H@Ant2, 11N20_L@Ant1, 11N20_L@Ant2, 11N20_M@Ant1, 11N20_M@Ant2, 11N20_H@Ant1, 11N20_H@Ant2, 11N20m_L@Ant1, 11N20m_L@Ant2, 11N20m_M@Ant1, 11N20m_M@Ant2, 11N20m_H@Ant1, 11N20m_H@Ant2, 11N40_L@Ant1, 11N40_L@Ant2, 11N40_M@Ant1, 11N40_M@Ant2, 11N40_H@Ant1, 11N40_H@Ant2, 11N40m_L@Ant1, 11N40m_L@Ant2, 11N40m_M@Ant1, 11N40m_M@Ant2, 11N40m_H@Ant1, 11N40m_H@Ant2, 11G_CDD L@ Ant 1 11G_CDD M @Ant 1 11G_CDD H @Ant 1 11G_CDD L@ Ant 2 11G_CDD M@ Ant 2 11G_CDD H @Ant 2
Maximum Conducted Average Output Power	Measurement Method	FCC KDB 558074 D01 §9.2 .2. 4
	Test Environment	NTNV
	Test Setup	Test Setup 1
	EUT Configuration	11B_L@Ant1, 11B_L@Ant2, 11B_M@Ant1, 11B_M@Ant2, 11B_H@Ant1, 11B_H@Ant2,



Test Case	Test Conditions	
	Configuration	Description
		11G_L@Ant1, 11G_L@Ant2, 11G_M@Ant1, 11G_M@Ant2, 11G_H@Ant1, 11G_H@Ant2, 11N20_L@Ant1, 11N20_L@Ant2, 11N20_M@Ant1, 11N20_M@Ant2, 11N20_H@Ant1, 11N20_H@Ant2, 11N20m_L@Ant1, 11N20m_L@Ant2, 11N20m_M@Ant1, 11N20m_M@Ant2, 11N20m_H@Ant1, 11N20m_H@Ant2, 11N40_L@Ant1, 11N40_L@Ant2, 11N40_M@Ant1, 11N40_M@Ant2, 11N40_H@Ant1, 11N40_H@Ant2, 11N40m_L@Ant1, 11N40m_L@Ant2, 11N40m_M@Ant1, 11N40m_M@Ant2, 11N40m_H@Ant1, 11N40m_H@Ant2, 11G_CDD L@ Ant 1 11G_CDD M @Ant 1 11G_CDD H @Ant 1 11G_CDD L@ Ant 2 11G_CDD M@ Ant 2 11G_CDD H @Ant 2
Maximum Power Spectral Density Level	Measurement Method	FCC KDB 558074 D01 §10.1
	Test Environment	NTNV
	Test Setup	Test Setup 1
	EUT Configuration	11B_L@Ant1, 11B_L@Ant2, 11B_M@Ant1, 11B_M@Ant2, 11B_H@Ant1, 11B_H@Ant2, 11G_L@Ant1, 11G_L@Ant2, 11G_M@Ant1, 11G_M@Ant2, 11G_H@Ant1, 11G_H@Ant2, 11N20_L@Ant1, 11N20_L@Ant2, 11N20_M@Ant1, 11N20_M@Ant2, 11N20_H@Ant1, 11N20_H@Ant2, 11N20m_L@Ant1, 11N20m_L@Ant2, 11N20m_M@Ant1, 11N20m_M@Ant2, 11N20m_H@Ant1, 11N20m_H@Ant2, 11N40_L@Ant1, 11N40_L@Ant2, 11N40_M@Ant1, 11N40_M@Ant2, 11N40_H@Ant1, 11N40_H@Ant2, 11N40m_L@Ant1, 11N40m_L@Ant2, 11N40m_M@Ant1, 11N40m_M@Ant2, 11N40m_H@Ant1, 11N40m_H@Ant2, 11G_CDD L@ Ant 1 11G_CDD M @Ant 1 11G_CDD H @Ant 1 11G_CDD L@ Ant 2 11G_CDD M@ Ant 2 11G_CDD H @Ant 2
Band Edges Compliance	Measurement Method	FCC KDB 558074 D01 §13.0.
	Test Environment	NTNV
	Test Setup	Test Setup 1
	EUT Configuration	11B_L@Ant1, 11B_L@Ant2, 11B_H@Ant1, 11B_H@Ant2, 11G_L@Ant1, 11G_L@Ant2, 11G_H@Ant1, 11G_H@Ant2, 11N20_L@Ant1, 11N20_L@Ant2, 11N20_H@Ant1, 11N20_H@Ant2, 11N20m_L@Ant1, 11N20m_L@Ant2, 11N20m_H@Ant1, 11N20m_H@Ant2, 11N40_L@Ant1, 11N40_L@Ant2, 11N40_H@Ant1, 11N40_H@Ant2, 11N40m_L@Ant1, 11N40m_L@Ant2, 11N40m_H@Ant1, 11N40m_H@Ant2, 11G_CDD L@ Ant 1 11G_CDD M @Ant 1 11G_CDD H @Ant 1 11G_CDD L@ Ant 2 11G_CDD M@ Ant 2 11G_CDD H @Ant 2



Test Case	Test Conditions	
	Configuration	Description
Unwanted Emissions into Non-Restricted Frequency Bands	Measurement Method	FCC KDB 558074 D01 §11.0
	Test Environment	NTNV
	Test Setup	Test Setup 1
	EUT Configuration	11B_L@Ant1, 11B_L@Ant2, 11B_M@Ant1, 11B_M@Ant2, 11B_H@Ant1, 11B_H@Ant2, 11G_L@Ant1, 11G_L@Ant2, 11G_M@Ant1, 11G_M@Ant2, 11G_H@Ant1, 11G_H@Ant2, 11N20_L@Ant1, 11N20_L@Ant2, 11N20_M@Ant1, 11N20_M@Ant2, 11N20_H@Ant1, 11N20_H@Ant2, 11N20m_L@Ant1, 11N20m_L@Ant2, 11N20m_M@Ant1, 11N20m_M@Ant2, 11N20m_H@Ant1, 11N20m_H@Ant2, 11N40_L@Ant1, 11N40_L@Ant2, 11N40_M@Ant1, 11N40_M@Ant2, 11N40_H@Ant1, 11N40_H@Ant2, 11N40m_L@Ant1, 11N40m_L@Ant2, 11N40m_M@Ant1, 11N40m_M@Ant2, 11N40m_H@Ant1, 11N40m_H@Ant2, 11G_CDD L@ Ant 1 11G_CDD M @Ant 1 11G_CDD H @Ant 1 11G_CDD L@ Ant 2 11G_CDD M@ Ant 2 11G_CDD H @Ant 2
Unwanted Emissions into Restricted Frequency Bands (Radiated)	Measurement Method	ANSI C63.10; FCC KDB 558074 D01 §12.1, Radiated
	Test Environment	NTNV
	Test Setup	Test Setup 2
	EUT Placement	<input checked="" type="checkbox"/> Flatwise, <input checked="" type="checkbox"/> Upright, <input checked="" type="checkbox"/> Hung
AC Power Line Conducted Emissions	EUT Configuration	(1) 30 MHz to 1 GHz: 11B_L@Ant1 (Worst Conf.). (2) 1 GHz to 3 GHz: 11B_L@Ant1, 11B_L@Ant2, 11B_H@Ant1, 11B_H@Ant2, 11G_L@Ant1, 11G_L@Ant2, 11G_H@Ant1, 11G_H@Ant2, 11N20_L@Ant1, 11N20_L@Ant2, 11N20_H@Ant1, 11N20_H@Ant2, 11N20m_L@Ant1, 11N20m_L@Ant2, 11N20m_H@Ant1, 11N20m_H@Ant2, 11N40_L@Ant1, 11N40_L@Ant2, 11N40_H@Ant1, 11N40_H@Ant2, 11N40m_L@Ant1, 11N40m_L@Ant2, 11N40m_H@Ant1, 11N40m_H@Ant2, (3) 3 GHz to 18 GHz: 11B_L@Ant1 (Worse Conf.), 11B_H@Ant1 (Worse Conf.). (4) 18 GHz to 26.5 GHz: 11B_L@Ant1 (Worse Conf.), 11B_H@Ant1 (Worse Conf.). 11G_CDD L@ Ant 1 11G_CDD M @Ant 1 11G_CDD H @Ant 1 11G_CDD L@ Ant 2 11G_CDD M@ Ant 2 11G_CDD H @Ant 2
	Measurement Method	AC mains conducted.
	Test Environment	NTNV
	Test Setup	Test Setup 3
	EUT Configuration	11B_L@Ant1 (Worst Conf.).



5 Main Test Instruments

Address1:

Main Test Equipments					
Equipment Name	Manufacturer	Model	Serial Number	Cal Date	Cal- Due
Power supply	KEITHLEY	2303	1342889	2017/10/24	2018/10/24
Universal Radio Communication Tester	R&S	CMU200	110932	2018/4/27	2019/4/27
Universal Radio Communication Tester	R & S	CMW500	126854	2017/10/19	2018/10/19
Signal Analyzer	R&S	FSQ31	200021	2018/7/23	2019/7/23
Spectrum Analyzer	Agilent	N9030A	MY49431698	2018/7/23	2019/7/23
Temperature Chamber	WEISS	WKL64	56246002940010	2017/12/13	2018/12/13
Signal generator	Agilent	E8257D	MY49281095	2018/7/23	2019/7/23
Vector Signal Generator	R&S	SMU200A	104162	2018/7/23	2019/7/23
Power Detecting & Samplig Unit	R&S	OSP-B157	101429	2018/7/23	2019/7/23
Spectrum Analyzer	Keysight	N9040B	MY57212529	2018/6/28	2019/6/28

Address2:

Main Test Equipments					
Equipment Name	Manufacturer	Model	Serial Number	Cal Date	Cal- Due
Test receiver	R&S	ESU26	100387	2018/1/20	2019/1/19
Test receiver	R&S	ESU26	100387	2018/1/20	2019/1/19
Test receiver	R&S	ESCI	101163	2018/1/20	2019/1/19
Spectrum analyzer	R&S	FSU3	200474	2018/1/20	2019/1/19
Spectrum analyzer	R&S	FSU43	100144	2018/1/20	2019/1/19
LOOP Antennas(9kHz-30MHz)	R&S	HFH2-Z2	100262	2017/4/25	2019/4/25
LOOP Antennas(9kHz-30MHz)	R&S	HFH2-Z2	100263	2017/4/25	2019/4/25
Trilog Broadband Antenna (30M~3GHz)	SCHWARZBECK	VULB 9163	9163-357	2017/4/21	2019/4/20
Double-Ridged Waveguide Horn Antenna (1G~18GHz)	R&S	HF907	100304	2017/5/27	2019/5/27
Pyramidal Horn Antenna(18GHz-26.5GHz)	ETS-Lindgren	3160-09	5140299	2017/7/20	2019/7/19
Artificial Main Network	R&S	ENV4200	100134	2018/5/8	2019/5/7
Line Impedance Stabilization Network	R&S	ENV216	100382	2018/5/8	2019/5/7



Software Information			
Test Item	Software Name	Manufacturer	Version
RE	EMC32	R&S	V9.25.0
CE	EMC32	R&S	V9.25.0

6 Measurement Uncertainty

For a 95% confidence level ($k = 2$), the measurement expanded uncertainties for defined systems, in accordance with the recommendations of ISO 17025 as following:

Test Item		Extended Uncertainty
Transmit Output Power Data	Power [dBm]	U = 0.39 dB
RF Power Density, Conducted	Power [dBm]	U = 0.64 dB
Bandwidth	Magnitude [kHz]	20MHz: U=41.78kHz 40MHz: U=82.12kHz
Band Edge Compliance	Disturbance Power [dBm]	U = 0.9 dB
Spurious Emissions, Conducted	Disturbance Power [dBm]	20MHz~3.6GHz: U=0.88dB 3.6GHz~8.4GHz: U=1.08dB 8.4GHz~13.6GHz: U=1.24dB 13.6GHz~22GHz: U=1.34dB 22GHz~26.5GHz: U=1.36dB
Field Strength of Spurious Radiation	ERP/EIRP [dBm]	For 3 m Chamber: U = 5.90 dB (30 MHz-1 GHz) U = 4.94 dB (1 GHz-18 GHz) U = 4.24 dB (18 GHz-26.5 GHz)
Frequency Stability	Frequency Accuracy [Hz]	U=41.58Hz
AC Power Line Conducted Emissions	Disturbance Voltage[dBμV]	U=2.3 dB
Duty Cycle	Duty Cycle [%]	U=±2.06 %

7 Appendixes

Appendix No.	Description
SYBH(Z-RF)20180706013002-2002-A	Appendix for 2.4 WLAN

END