



FCC RADIO TEST REPORT

FCC ID : QISLYA-LX9
Equipment : Smartphone
Brand Name : HUAWEI
Model Name : LYA-L29, LYA-L09
Applicant : Huawei Technologies Co., Ltd.
Administration Building, Headquarters of
Huawei Technologies Co., Ltd., Bantian,
Longgang District, Shenzhen, 518129,
P.R.C
Manufacturer : Huawei Technologies Co., Ltd.
Administration Building, Headquarters of
Huawei Technologies Co., Ltd., Bantian,
Longgang District, Shenzhen, 518129,
P.R.C
Standard : 47 CFR Part 2, 22(H)

The product was received on Aug. 02, 2018 and testing was started from Aug. 15, 2018 and completed on Aug. 18, 2018. We, SPORTON INTERNATIONAL INC., would like to declare that the tested sample has been evaluated in accordance with the test procedures given in ANSI / TIA-603-E and has been in compliance with the applicable technical standards.

The report must not be used by the client to claim product certification, approval, or endorsement by TAF or any agency of government.

The test results in this report apply exclusively to the tested model / sample. Without written approval of SPORTON INTERNATIONAL INC. EMC & Wireless Communications Laboratory, the test report shall not be reproduced except in full.



Approved by: Eric Shih / Manager

Sporton International (Shenzhen) Inc.

**1/F, 2/F, Bldg 5, Shiling Industrial Zone, Xinwei Village, Xili, Nanshan Shenzhen City
Guangdong Province 518055 China**



Table of Contents

History of this test report	3
Summary of Test Result	4
1 General Description.....	5
1.1 Product Feature of Equipment Under Test	5
1.2 Product Specification of Equipment Under Test	7
1.3 Modification of EUT	7
1.4 Maximum ERP Power, Frequency Tolerance, and Emission Designator	7
1.5 Testing Location	8
1.6 Applicable Standards	8
2 Test Configuration of Equipment Under Test.....	9
2.1 Test Mode.....	9
2.2 Connection Diagram of Test System	10
2.3 Support Unit used in test configuration and system.....	10
2.4 Measurement Results Explanation Example	10
2.5 Frequency List of Low/Middle/High Channels.....	11
3 Conducted Test Items	12
3.1 Measuring Instruments.....	12
3.2 Conducted Output Power and ERP	13
3.3 Peak-to-Average Ratio	14
3.4 Occupied Bandwidth	15
3.5 Conducted Band Edge	16
3.6 Conducted Spurious Emission	17
3.7 Frequency Stability	18
4 Radiated Test Items	19
4.1 Measuring Instruments.....	19
4.2 Radiated Spurious Emission	20
5 List of Measuring Equipment	21
6 Uncertainty of Evaluation.....	22
Appendix A. Test Results of Conducted Test	
Appendix B. Test Results of ERP and Radiated Test	



History of this test report

Report No.	Version	Description	Issued Date
FG880204A	01	Initial issue of report	Sep. 11, 2018



Summary of Test Result

Report Clause	Ref Std. Clause	Test Items	Result (PASS/FAIL)	Remark
3.2	§2.1046	Conducted Output Power	Reporting only	-
	§22.913 (a)(2)	Effective Radiated Power (Band 26)	Pass	
3.3	-	Peak-to-Average Ratio	Reporting only	-
3.4	§2.1049	Occupied Bandwidth	Reporting only	-
3.5	§2.1051 §22.917 (a)	Conducted Band Edge Measurement (Band 26)	Pass	-
3.6	§2.1051 §22.917 (a)	Conducted Spurious Emission (Band 26)	Pass	-
3.7	§2.1055 §22.355	Frequency Stability Temperature & Voltage	Pass	-
4.2	§2.1053 §22.917 (a)	Radiated Spurious Emission (Band 26)	Pass	Under limit 52.48 dB at 3299.000 MHz

Reviewed by: Wii Chang

Report Producer: Polly Tsai



1 General Description

1.1 Product Feature of Equipment Under Test

Product Feature	
Equipment	Smartphone
Brand Name	HUAWEI
Model Name	LYA-L29, LYA-L09
FCC ID	QISLYA-LX9
EUT supports Radios application	GSM/WCDMA/HSPA/LTE/NFC/GNSS/WPC WLAN 11a/b/g/n HT20/HT40 WLAN 11ac VHT20/VHT40/VHT80/VHT160 Bluetooth BR/EDR/LE
HW Version	HL2LAYAM
SW Version	9.0.0.82(C432E82R1P7)
EUT Stage	Production Unit



Accessories Information				
AC Adapter 1	Brand Name	Huawei Technologies Co., Ltd.	Model Name	HW-100400A00
	Manufacturer	Huawei Technologies Co., Ltd.		
	Power Rating	I/P: 100 - 240 Vac~50/60Hz, 1.2 A; O/P: 5V === 2A or 9V=== 2A or 10V=== 4A		
AC Adapter 2	Brand Name	Huawei Technologies Co., Ltd.	Model Name	HW-100400U00
	Manufacturer	Huawei Technologies Co., Ltd.		
	Power Rating	I/P: 100 - 240 Vac~50/60Hz, 1.2 A; O/P: 5V === 2A or 9V=== 2A or 10V=== 4A		
AC Adapter 3	Brand Name	Huawei Technologies Co., Ltd.	Model Name	HW-100400E00
	Manufacturer	Huawei Technologies Co., Ltd.		
	Power Rating	I/P: 100 - 240 Vac~50/60Hz, 1.2 A; O/P: 5V === 2A or 9V=== 2A or 10V=== 4A		
AC Adapter 4	Brand Name	Huawei Technologies Co., Ltd.	Model Name	HW-100400B00
	Manufacturer	Huawei Technologies Co., Ltd.		
	Power Rating	I/P: 100 - 240 Vac~50/60Hz, 1.2 A; O/P: 5V === 2A or 9V=== 2A or 10V=== 4A		
Battery 1	Brand Name	Huawei Technologies Co., Ltd.	Model Name	HB486486ECW
	Power Rating	Nominal Voltage: ===+3.82Vdc Charging Voltage: ===+4.4V Rated Capacity: 4100mAh	Type	Li-ion Polymer
Battery 2	Brand Name	Huawei Technologies Co., Ltd.	Model Name	HB486486ECW
	Power Rating	Nominal Voltage: ===+3.82Vdc Charging Voltage: ===+4.4V Rated Capacity: 4100mAh	Type	Li-ion Polymer
Battery 3	Brand Name	Huawei Technologies Co., Ltd.	Model Name	HB486486ECW
	Power Rating	Nominal Voltage: ===+3.82Vdc Charging Voltage: ===+4.4V Rated Capacity: 4100mAh	Type	Li-ion Polymer
Earphone 1	Brand Name	Jiangxi Lianchuang Hongsheng Electronic Co., Ltd.		
	Model Name	MEND1632B729003	Number	22040325
Earphone 2	Brand Name	GoerTek Inc.		
	Model Name	Windy-S	Number	22040325
Earphone 3	Brand Name	Boluo County Quancheng Electronic Co., Ltd.		
	Model Name	1331-3301-6001-TC-088	Number	22040325
Earphone 4	Brand Name	Boluo County Quancheng Electronic Co., Ltd.		
	Model Name	630276	Number	N/A

Note: Regarding to more detail and other information, please refer to user manual.



1.2 Product Specification of Equipment Under Test

Standards-related Product Specification	
Tx Frequency	LTE Band 26 : 824.7MHz ~ 848.3 MHz
Rx Frequency	LTE Band 26 : 869.7MHz ~ 893.3MHz
Bandwidth	LTE Band 26 : 1.4MHz / 3MHz / 5MHz / 10MHz / 15MHz
Maximum Output Power to Antenna	<Up Antenna> LTE Band 26 : 23.46 dBm < Down Antenna > LTE Band 26 : 24.17 dBm
Antenna Gain	LTE Band 26 : -5.35 dBi for Up Antenna LTE Band 26 : -4.05 dBi for Down Antenna
Antenna Type	IFA Antenna
Type of Modulation	QPSK / 16QAM / 64QAM

1.3 Modification of EUT

No modifications are made to the EUT during all test items.

1.4 Maximum ERP Power, Frequency Tolerance, and Emission Designator

<For Up Antenna>

LTE Band 26		QPSK			16QAM			64QAM		
BW (MHz)	Frequency Range (MHz)	Emission Designator (99%OBW)	Frequency Tolerance (ppm)	Maximum ERP(W)	Emission Designator (99%OBW)	Frequency Tolerance (ppm)	Maximum EIRP(W)	Emission Designator (99%OBW)	Frequency Tolerance (ppm)	Maximum ERP(W)
1.4	824.7 ~ 848.3	1M09G7D	-	0.0392	1M11W7D	-	0.0317	1M10W7D	-	0.0316
3	825.5 ~ 847.5	2M75G7D	-	0.0389	2M74W7D	-	0.0333	2M73W7D	-	0.0318
5	826.5 ~ 846.5	4M52G7D	-	0.0390	4M50W7D	-	0.0352	4M53W7D	-	0.0310
10	829.0 ~ 844.0	9M03G7D	0.0096	0.0392	9M07W7D	-	0.0346	9M09W7D	-	0.0264
15	831.5 ~ 841.5	13M4G7D	-	0.0394	13M6W7D	-	0.0336	13M5W7D	-	0.0257

<For Down Antenna>

LTE Band 26		QPSK			16QAM			64QAM		
BW (MHz)	Frequency Range (MHz)	Emission Designator (99%OBW)	Frequency Tolerance (ppm)	Maximum ERP(W)	Emission Designator (99%OBW)	Frequency Tolerance (ppm)	Maximum EIRP(W)	Emission Designator (99%OBW)	Frequency Tolerance (ppm)	Maximum ERP(W)
1.4	824.7 ~ 848.3	1M09G7D	-	0.0618	1M11W7D	-	0.0521	1M10W7D	-	0.0447
3	825.5 ~ 847.5	2M75G7D	-	0.0622	2M74W7D	-	0.0525	2M73W7D	-	0.0366
5	826.5 ~ 846.5	4M52G7D	-	0.0615	4M50W7D	-	0.0516	4M53W7D	-	0.0404
10	829.0 ~ 844.0	9M03G7D	0.0096	0.0621	9M07W7D	-	0.0520	9M09W7D	-	0.0434
15	831.5 ~ 841.5	13M4G7D	-	0.0627	13M6W7D	-	0.0520	13M5W7D	-	0.0468



1.5 Testing Location

Sporton Lab is accredited to ISO 17025 by National Voluntary Laboratory Accreditation Program (NVLAP code: 600155-0).

Test Site	Sporton International (Kunshan) Inc.		
Test Site Location	No. 1098, Pengxi North Road, Kunshan Economic Development Zone, Jiangsu Province 215335, China TEL : 86-512-57900158 FAX : 86-512-57900958		
Test Site No.	Sporton Site No.	FCC designation No.	FCC Test Firm Registration No.
	TH01-KS	CN5013	630927

Note: The test site complies with ANSI C63.4 2014 requirement.

Sporton International (Shenzhen) Inc. is accredited to ISO 17025 by National Voluntary Laboratory Accreditation Program (NVLAP code: 600156-0) and the FCC designation No are CN5018 and CN5019.

Test Site	Sporton International (Shenzhen) Inc.	
Test Site Location	No. 3 Bldg the third floor of south, Shahe River west, Fengzeyuan Warehouse, Nanshan District Shenzhen City Guangdong Province 518055 China TEL: +86-755-3320-2398	
Test Site No.	Sporton Site No.	FCC Test Firm Registration No.
	03CH01-SZ	577730

Note: The test site complies with ANSI C63.4 2014 requirement.

1.6 Applicable Standards

According to the specifications of the manufacturer, the EUT must comply with the requirements of the following standards:

- ♦ ANSI C63.26-2015
- ♦ ANSI / TIA-603-E
- ♦ 47 CFR Part 2, 22(H)
- ♦ FCC KDB 971168 D01 Power Meas. License Digital Systems v03r01
- ♦ FCC KDB 412172 D01 Determining ERP and EIRP v01r01

Remark: All test items were verified and recorded according to the standards and without any deviation during the test.



2 Test Configuration of Equipment Under Test

2.1 Test Mode

Antenna port conducted and radiated test items listed below are performed according to KDB 971168 D01 Power Meas. License Digital Systems v03r01 with maximum output power.

For radiated measurement, pre-scanned in three orthogonal panels, X, Y, Z. The worst cases (X plane) were recorded in this report.

Test Items	Band	Bandwidth (MHz)						Modulation			RB #			Test Channel		
		1.4	3	5	10	15	20	QPSK	16QAM	64QAM	1	Half	Full	L	M	H
Max. Output Power	26	v	v	v	v	v	-	v	v	v	v	v	v	v	v	v
Peak-to-Average Ratio	26					v	-	v	v	v	v		v	v	v	v
26dB and 99% Bandwidth	26	v	v	v	v	v	-	v	v	v			v	v	v	v
Conducted Band Edge	26	v	v	v	v	v	-	v	v	v	v		v			v
Conducted Spurious Emission	26	v	v	v	v	v	-	v	v	v	v			v	v	v
Frequency Stability	26				v		-	v					v		v	
E.R.P	26	v	v	v	v	v	-	v	v	v	v	v		v	v	v
Radiated Spurious Emission	26	Worst Case											v	v	v	
Remark	<ol style="list-style-type: none"> The mark "v" means that this configuration is chosen for testing The mark "-" means that this bandwidth is not supported. The device is investigated from 30MHz to 10 times of fundamental signal for radiated spurious emission test under different RB size/offset and modulations in exploratory test. Subsequently, only the worst case emissions are reported. All the radiated test cases were performed with Earphone 1 and USB Cable 1. 															

2.2 Connection Diagram of Test System

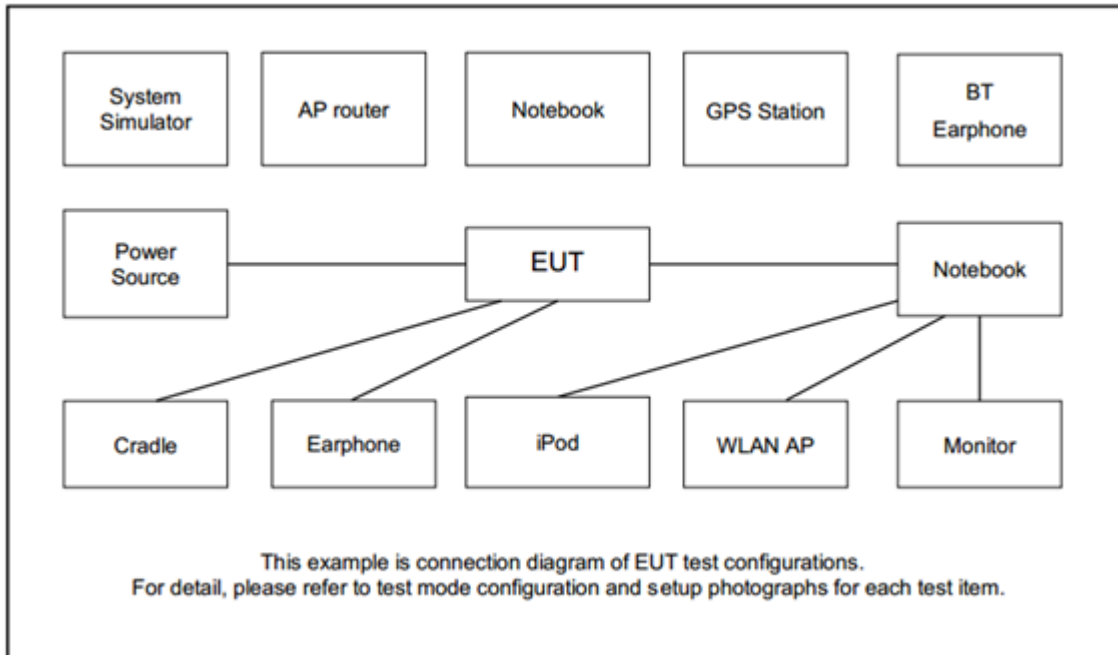

2.3 Support Unit used in test configuration and system

Item	Equipment	Trade Name	Model No.	FCC ID	Data Cable	Power Cord
1.	System Simulator	Anritsu	MT8820C	N/A	N/A	Unshielded, 1.8 m

2.4 Measurement Results Explanation Example

For all conducted test items:

The offset level is set in the spectrum analyzer to compensate the RF cable loss and attenuator factor between EUT conducted output port and spectrum analyzer. With the offset compensation, the spectrum analyzer reading level is exactly the EUT RF output level.

The spectrum analyzer offset is derived from RF cable loss and attenuator factor.

Offset = RF cable loss + attenuator factor.

Following shows an offset computation example with cable loss 4.2 dB and 10dB attenuator.

Example :

Offset(dB) = RF cable loss(dB) + attenuator factor(dB).

$$= 4.2 + 10 = 14.2 \text{ (dB)}$$



2.5 Frequency List of Low/Middle/High Channels

LTE Band 26 Channel and Frequency List				
BW [MHz]	Channel/Frequency(MHz)	Lowest	Middle	Highest
15	Channel	26865	26915	26965
	Frequency	831.5	836.5	841.5
10	Channel	26840	26915	26990
	Frequency	829	836.5	844
5	Channel	26815	26915	27015
	Frequency	826.5	836.5	846.5
3	Channel	26805	26915	27025
	Frequency	825.5	836.5	847.5
1.4	Channel	26797	26915	27033
	Frequency	824.7	836.5	848.3

3 Conducted Test Items

3.1 Measuring Instruments

See list of measuring instruments of this test report.

3.1.1 Test Setup

3.1.2 Conducted Output Power



3.1.3 Peak-to-Average Ratio, Occupied Bandwidth ,Conducted Band-Edge and Conducted Spurious Emission

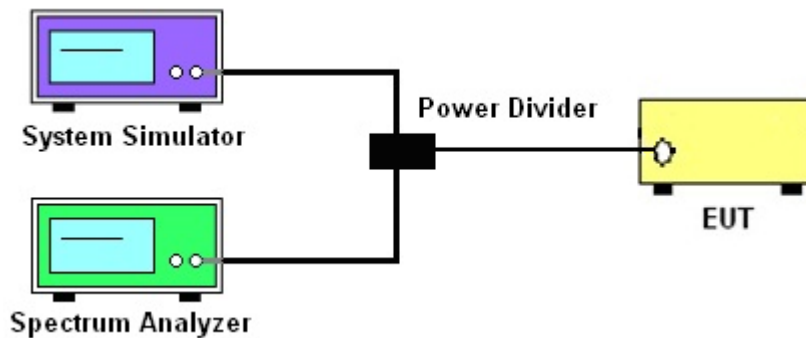

3.1.4 Frequency Stability

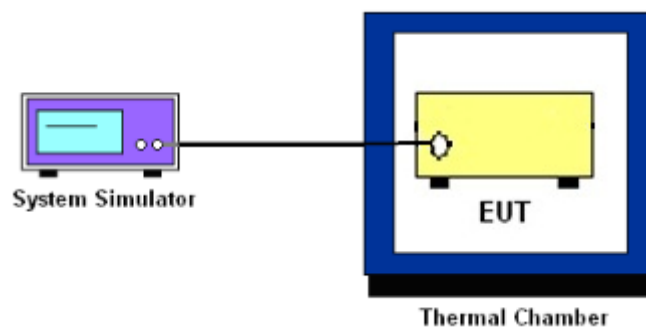

3.1.5 Test Result of Conducted Test

Please refer to Appendix A.



3.2 Conducted Output Power and ERP

3.2.1 Description of the Conducted Output Power Measurement and ERP Measurement

A system simulator was used to establish communication with the EUT. Its parameters were set to force the EUT transmitting at maximum output power. The measured power in the radio frequency on the transmitter output terminals shall be reported.

The ERP of mobile transmitters must not exceed 7 Watts for LTE Band 26.

According to KDB 412172 D01 Power Approach,

$EIRP = P_T + G_T - L_C$, $ERP = EIRP - 2.15$, where

P_T = transmitter output power in dBm

G_T = gain of the transmitting antenna in dBi

L_C = signal attenuation in the connecting cable between the transmitter and antenna in dB

3.2.2 Test Procedures

1. The transmitter output port was connected to the system simulator.
2. Set EUT at maximum power through the system simulator.
3. Select lowest, middle, and highest channels for each band and different modulation.
4. Measure and record the power level from the system simulator.



3.3 Peak-to-Average Ratio

3.3.1 Description of the PAR Measurement

Power Complementary Cumulative Distribution Function (CCDF) curves provide a means for characterizing the power peaks of a digitally modulated signal on a statistical basis. A CCDF curve depicts the probability of the peak signal amplitude exceeding the average power level. Most contemporary measurement instrumentation include the capability to produce CCDF curves for an input signal provided that the instrument's resolution bandwidth can be set wide enough to accommodate the entire input signal bandwidth. In measuring transmissions in this band using an average power technique, the peak-to-average ratio (PAR) of the transmission may not exceed 13 dB.

3.3.2 Test Procedures

The testing follows FCC KDB 971168 D01 v03r01 Section 5.7.1

1. The EUT was connected to spectrum and system simulator via a power divider.
2. Set the CCDF (Complementary Cumulative Distribution Function) option in spectrum analyzer.
3. The highest RF powers were measured and recorded the maximum PAPR level associated with a probability of 0.1 %.
4. Record the deviation as Peak to Average Ratio.



3.4 Occupied Bandwidth

3.4.1 Description of Occupied Bandwidth Measurement

The occupied bandwidth is the width of a frequency band such that, below the lower and above the upper frequency limits, the mean powers emitted are each equal to a specified percentage 0.5% of the total mean transmitted power.

The 26 dB emission bandwidth is defined as the frequency range between two points, one above and one below the carrier frequency, at which the spectral density of the emission is attenuated 26 dB below the maximum in-band spectral density of the modulated signal. Spectral density (power per unit bandwidth) is to be measured with a detector of resolution bandwidth equal to approximately 1.0% of the emission bandwidth.

3.4.2 Test Procedures

The testing follows FCC KDB 971168 D01 v03r01 Section 4.2

1. The EUT was connected to spectrum analyzer and system simulator via a power divider.
2. The spectrum analyzer center frequency is set to the nominal EUT channel center frequency. The span range for the spectrum analyzer shall be between two and five times the anticipated OBW.
3. The nominal resolution bandwidth (RBW) shall be in the range of 1 to 5 % of the anticipated OBW, and the VBW shall be at least 3 times the RBW.
4. Set the detection mode to peak, and the trace mode to max hold.
5. Determine the reference value: Set the EUT to transmit a modulated signal. Allow the trace to stabilize. Set the spectrum analyzer marker to the highest level of the displayed trace.
(this is the reference value)
6. Determine the “-26 dB down amplitude” as equal to (Reference Value – X).
7. Place two markers, one at the lowest and the other at the highest frequency of the envelope of the spectral display such that each marker is at or slightly below the “-X dB down amplitude” determined in step 6. If a marker is below this “-X dB down amplitude” value it shall be placed as close as possible to this value. The OBW is the positive frequency difference between the two markers.
8. Use the 99 % power bandwidth function of the spectrum analyzer and report the measured bandwidth.



3.5 Conducted Band Edge

3.5.1 Description of Conducted Band Edge Measurement

22.917(a)

For operations in the 824 – 849 MHz band, the FCC limit is $43 + 10\log_{10}(P[\text{Watts}])$ dB below the transmitter power $P(\text{Watts})$ in a 100kHz bandwidth. However, in the 1MHz bands immediately outside and adjacent to the licensee's frequency block, a resolution bandwidth of at least one percent of the emission bandwidth of the fundamental emission of the transmitter may be employed.

3.5.2 Test Procedures

The testing follows FCC KDB 971168 D01 v03r01 Section 6.0.

1. The EUT was connected to spectrum analyzer and system simulator via a power divider.
2. The band edges of low and high channels for the highest RF powers were measured.
3. Set RBW $\geq 1\%$ EBW in the 1MHz band immediately outside and adjacent to the band edge.
4. Beyond the 1 MHz band from the band edge, RBW=1MHz was used.
5. Set spectrum analyzer with RMS detector.
6. The RF fundamental frequency should be excluded against the limit line in the operating frequency band.
7. Checked that all the results comply with the emission limit line.

The limit line is derived from $43 + 10\log(P)\text{dB}$ below the transmitter power $P(\text{Watts})$



3.6 Conducted Spurious Emission

3.6.1 Description of Conducted Spurious Emission Measurement

The power of any emission outside of the authorized operating frequency ranges must be lower than the transmitter power (P) by a factor of at least $43 + 10 \log (P)$ dB.

It is measured by means of a calibrated spectrum analyzer and scanned from 30 MHz up to a frequency including its 10th harmonic.

3.6.2 Test Procedures

The testing follows FCC KDB 971168 D01 v03r01 Section 6.0.

1. The EUT was connected to spectrum analyzer and system simulator via a power divider.
2. The RF output of EUT was connected to the spectrum analyzer by RF cable and attenuator. The path loss was compensated to the results for each measurement.
3. The middle channel for the highest RF power within the transmitting frequency was measured.
4. The conducted spurious emission for the whole frequency range was taken.
5. Make the measurement with the spectrum analyzer's RBW = 1MHz, VBW = 3MHz.
6. Set spectrum analyzer with RMS detector.
7. Taking the record of maximum spurious emission.
8. The RF fundamental frequency should be excluded against the limit line in the operating frequency band.
9. The limit line is derived from $43 + 10\log(P)$ dB below the transmitter power P(Watts)



3.7 Frequency Stability

3.7.1 Description of Frequency Stability Measurement

22.355

The frequency stability shall be measured by variation of ambient temperature and variation of primary supply voltage to ensure that the fundamental emission stays within the authorized frequency block. The frequency stability of the transmitter shall be maintained within $\pm 0.00025\%$ ($\pm 2.5\text{ppm}$) of the center frequency.

3.7.2 Test Procedures for Temperature Variation

The testing follows FCC KDB 971168 D01 v03r01 Section 9.0.

1. The EUT was set up in the thermal chamber and connected with the system simulator.
2. With power OFF, the temperature was decreased to -30°C and the EUT was stabilized before testing. Power was applied and the maximum change in frequency was recorded within one minute.
3. With power OFF, the temperature was raised in 10°C step up to 50°C . The EUT was stabilized at each step for at least half an hour. Power was applied and the maximum frequency change was recorded within one minute.

3.7.3 Test Procedures for Voltage Variation

The testing follows FCC KDB 971168 D01 v03r01 Section 9.0.

1. The EUT was placed in a temperature chamber at $20\pm 5^{\circ}\text{C}$ and connected with the system simulator.
2. The power supply voltage to the EUT was varied from 85% to 115% of the nominal value measured at the input to the EUT.
3. The variation in frequency was measured for the worst case.

4 Radiated Test Items

4.1 Measuring Instruments

See list of measuring instruments of this test report.

4.1.1 Test Setup

For radiated test from 30MHz to 1GHz

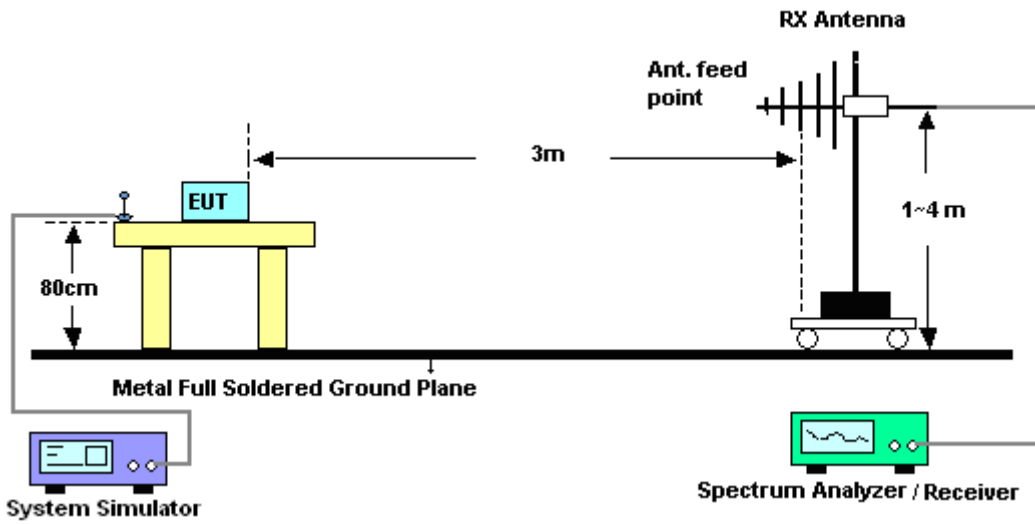

For radiated test above 1GHz

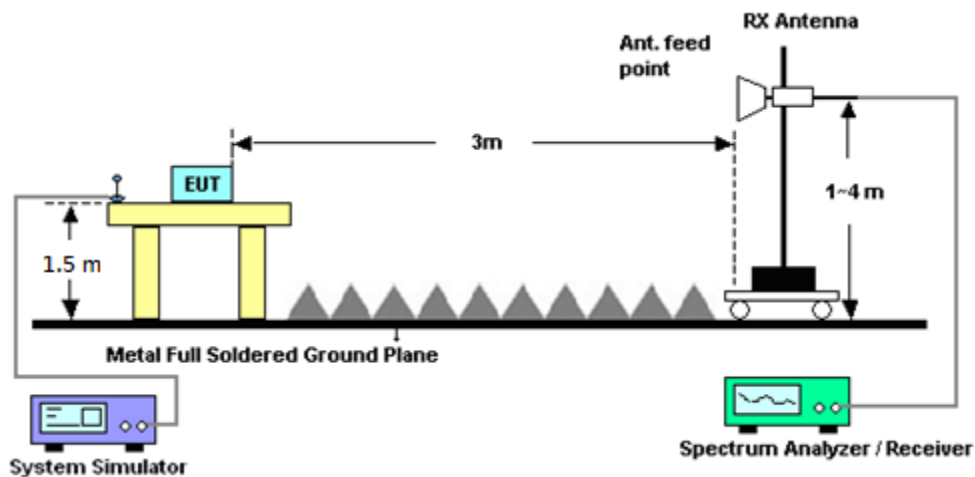

4.1.2 Test Result of Radiated Test

Please refer to Appendix B.



4.2 Radiated Spurious Emission

4.2.1 Description of Radiated Spurious Emission

The radiated spurious emission was measured by substitution method according to ANSI / TIA-603-E. The power of any emission outside of the authorized operating frequency ranges must be attenuated below the transmitter power (P) by a factor of at least $43 + 10 \log (P)$ dB.

The spectrum is scanned from 30 MHz up to a frequency including its 10th harmonic.

4.2.2 Test Procedures

The testing follows FCC KDB 971168 D01 v03r01 Section 5.8 and ANSI / TIA-603-E Section 2.2.12.

1. The EUT was placed on a turntable with 0.8 meter for frequency below 1GHz and 1.5 meter for frequency above 1GHz respectively above ground.
2. The EUT was set 3 meters from the receiving antenna, which was mounted on the antenna tower.
3. The table was rotated 360 degrees to determine the position of the highest spurious emission.
4. The height of the receiving antenna is varied between one meter and four meters to search the maximum spurious emission for both horizontal and vertical polarizations.
5. Make the measurement with the spectrum analyzer's RBW = 1MHz, VBW = 3MHz, taking the record of maximum spurious emission.
6. A horn antenna was substituted in place of the EUT and was driven by a signal generator.
7. Tune the output power of signal generator to the same emission level with EUT maximum spurious emission.
8. Taking the record of output power at antenna port.
9. Repeat step 7 to step 8 for another polarization.
10. The RF fundamental frequency should be excluded against the limit line in the operating frequency band.

The limit line is derived from $43 + 10\log(P)$ dB below the transmitter power P(Watts)



5 List of Measuring Equipment

Instrument	Manufacturer	Model No.	Serial No.	Characteristics	Calibration Date	Test Date	Due Date	Remark
Spectrum Analyzer	R&S	FSP40	100319	9kHz~40GHz	Oct.12, 2017	Aug. 18, 2018	Oct.11, 2018	Conducted (TH01-KS)
Spectrum Analyzer	R&S	FSV30	101338	10Hz~30GHz	Apr. 19, 2018	Aug. 18, 2018	Apr. 18, 2019	Conducted (TH01-KS)
Spectrum Analyzer	R&S	FSV40	101040	10Hz~40GHz	Aug. 07, 2018	Aug. 18, 2018	Aug. 06, 2019	Conducted (TH01-KS)
Thermal Chamber	Ten Billion	TTC-B3S	TBN-960502	-40~+150°C	Oct.12, 2017	Aug. 18, 2018	Oct. 11, 2018	Conducted (TH01-KS)
EMI Test Receiver&SA	Agilent	N9038A	MY52260185	20Hz~26.5GHz	Apr. 19, 2018	Aug. 15, 2018	Apr. 18, 2019	Radiation (03CH01-SZ)
Bilog Antenna	TeseQ	CBL6112D	35408	30MHz~2GHz	Apr. 19, 2018	Aug. 15, 2018	Apr. 18, 2019	Radiation (03CH01-SZ)
Double Ridge Horn Antenna	ETS Lindgren	3117	119436	1GHz~18GHz	Jul. 28, 2018	Aug. 15, 2018	Jul. 27, 2019	Radiation (03CH01-SZ)
SHF-EHF Horn	com-power	AH-840	101071	18Ghz~40GHz	Mar. 30, 2018	Aug. 15, 2018	Mar. 29, 2019	Radiation (03CH01-SZ)
LF Amplifier	Burgeon	BPA-530	102209	0.01~3000Mhz	Apr. 19, 2018	Aug. 15, 2018	Apr. 18, 2019	Radiation (03CH01-SZ)
HF Amplifier	MITEQ	AMF-7D-00101800-30-10P-R	1707137	1GHz~18GHz	Oct.19, 2017	Aug. 15, 2018	Oct. 18, 2018	Radiation (03CH01-SZ)
HF Amplifier	KEYSIGHT	83017A	MY53270104	0.5GHz~26.5GHz	Oct.19, 2017	Aug. 15, 2018	Oct. 18, 2018	Radiation (03CH01-SZ)
HF Amplifier	MITEQ	TTA1840-35-HG	1871923	18GHz~40GHz	Jul. 30, 2018	Aug. 15, 2018	Jul. 30, 2019	Radiation (03CH01-SZ)
AC Power Source	Chroma	61601	616010001985	N/A	NCR	Aug. 15, 2018	NCR	Radiation (03CH01-SZ)
Turn Table	EM	EM1000	N/A	0~360 degree	NCR	Aug. 15, 2018	NCR	Radiation (03CH01-SZ)
Antenna Mast	EM	EM1000	N/A	1 m~4 m	NCR	Aug. 15, 2018	NCR	Radiation (03CH01-SZ)



6 Uncertainty of Evaluation

Uncertainty of Radiated Emission Measurement (30 MHz ~ 1000 MHz)

Measuring Uncertainty for a Level of Confidence of 95% ($U = 2Uc(y)$)	2.5
---	-----

Uncertainty of Radiated Emission Measurement (1 GHz ~ 18 GHz)

Measuring Uncertainty for a Level of Confidence of 95% ($U = 2Uc(y)$)	3.5
---	-----

Uncertainty of Radiated Emission Measurement (18 GHz ~ 40 GHz)

Measuring Uncertainty for a Level of Confidence of 95% ($U = 2Uc(y)$)	4.0
---	-----



Appendix A. Test Results of Conducted Test

Conducted Output Power(Average power)

<Up Antenna>

LTE Band 26 Maximum Average Power [dBm]						
BW [MHz]	RB Size	RB Offset	Mod	Lowest	Middle	Highest
15	1	0	QPSK	23.43	23.46	23.33
15	1	37		23.22	23.25	22.79
15	1	74		23.35	23.38	23.34
15	36	0		22.40	22.43	22.41
15	36	20		22.38	22.41	22.48
15	36	39		22.34	22.37	22.55
15	75	0		22.38	22.41	22.49
15	1	0	16-QAM	22.60	22.63	22.37
15	1	37		22.67	22.70	22.45
15	1	74		22.73	22.76	22.53
15	36	0		21.41	21.44	21.34
15	36	20		21.25	21.28	21.47
15	36	39		21.26	21.29	21.42
15	75	0		21.40	21.43	21.30
15	1	0	64-QAM	21.33	21.36	21.46
15	1	37		21.04	21.07	21.08
15	1	74		21.56	21.59	21.60
15	36	0		20.15	20.18	20.28
15	36	20		20.18	20.21	20.37
15	36	39		20.25	20.28	20.36
15	75	0		20.22	20.25	20.32
10	1	0	QPSK	23.29	23.32	23.41
10	1	25		23.16	23.19	22.73
10	1	49		23.40	23.43	23.18
10	25	0		22.26	22.29	22.52
10	25	12		22.40	22.43	22.36
10	25	25		22.36	22.39	22.45
10	50	0		22.33	22.36	22.40
10	1	0	16-QAM	22.70	22.73	22.57
10	1	25		22.33	22.36	22.88
10	1	49		22.86	22.89	22.44
10	25	0		21.30	21.33	21.33
10	25	12		21.28	21.31	21.53
10	25	25		21.24	21.27	21.24
10	50	0		21.19	21.22	21.31
10	1	0	64-QAM	21.68	21.71	21.44
10	1	25		21.51	21.54	21.46
10	1	49		21.34	21.37	21.21
10	25	0		20.33	20.36	20.51
10	25	12		20.18	20.21	20.33
10	25	25		20.15	20.18	20.37
10	50	0		20.30	20.33	20.25



LTE Band 26 Maximum Average Power [dBm]						
BW [MHz]	RB Size	RB Offset	Mod	Lowest	Middle	Highest
5	1	0	QPSK	23.38	23.41	23.40
5	1	12		23.04	23.07	23.15
5	1	24		23.20	23.23	23.32
5	12	0		22.40	22.43	22.49
5	12	7		22.34	22.37	22.47
5	12	13		22.38	22.41	22.39
5	25	0		22.33	22.36	22.37
5	1	0	16-QAM	22.87	22.90	22.69
5	1	12		22.94	22.97	22.70
5	1	24		22.68	22.71	22.64
5	12	0		21.26	21.29	21.36
5	12	7		21.21	21.24	21.36
5	12	13		21.17	21.20	21.52
5	25	0		21.32	21.35	21.37
5	1	0	64-QAM	22.32	22.35	22.25
5	1	12		22.21	22.24	22.16
5	1	24		22.39	22.42	22.28
5	12	0		21.16	21.19	21.40
5	12	7		21.13	21.16	21.19
5	12	13		21.23	21.26	21.44
5	25	0		21.19	21.22	21.22
3	1	0	QPSK	23.32	23.35	23.37
3	1	8		23.09	23.12	23.03
3	1	14		23.31	23.34	23.40
3	8	0		22.37	22.40	22.42
3	8	4		22.01	22.04	22.37
3	8	7		22.18	22.21	22.27
3	15	0		22.25	22.28	22.40
3	1	0	16-QAM	22.55	22.58	22.40
3	1	8		22.34	22.37	22.21
3	1	14		22.70	22.73	22.26
3	8	0		21.51	21.54	21.58
3	8	4		21.30	21.33	21.51
3	8	7		21.23	21.26	21.21
3	15	0		21.30	21.33	21.37
3	1	0	64-QAM	22.50	22.53	22.42
3	1	8		22.32	22.35	22.24
3	1	14		22.22	22.25	22.23
3	8	0		21.26	21.29	21.45
3	8	4		21.25	21.28	21.12
3	8	7		21.24	21.27	21.10
3	15	0		21.23	21.26	21.35



LTE Band 26 Maximum Average Power [dBm]						
BW [MHz]	RB Size	RB Offset	Mod	Lowest	Middle	Highest
1.4	1	0	QPSK	23.40	23.43	23.35
1.4	1	3		23.40	23.43	23.32
1.4	1	5		23.32	23.35	23.33
1.4	3	0		23.29	23.32	23.35
1.4	3	1		23.25	23.28	22.90
1.4	3	3		23.40	23.43	23.26
1.4	6	0		22.23	22.26	22.31
1.4	1	0	16-QAM	22.24	22.27	22.23
1.4	1	3		22.08	22.11	22.40
1.4	1	5		22.02	22.05	22.09
1.4	3	0		22.29	22.32	22.28
1.4	3	1		22.30	22.33	22.47
1.4	3	3		22.48	22.51	22.10
1.4	6	0		21.22	21.25	21.30
1.4	1	0	64-QAM	22.46	22.49	22.23
1.4	1	3		22.06	22.09	22.14
1.4	1	5		22.44	22.47	22.31
1.4	3	0		22.05	22.08	22.09
1.4	3	1		22.13	22.16	22.40
1.4	3	3		22.14	22.17	22.32
1.4	6	0		21.07	21.10	21.39



<Down Antenna>

LTE Band 26 Maximum Average Power [dBm]						
BW [MHz]	RB Size	RB Offset	Mod	Lowest	Middle	Highest
15	1	0	QPSK	24.14	24.17	24.04
15	1	37		23.68	23.71	23.54
15	1	74		24.08	24.11	24.00
15	36	0		23.22	23.25	23.21
15	36	20		23.10	23.13	23.16
15	36	39		23.22	23.25	23.06
15	75	0		23.20	23.23	23.15
15	1	0	16-QAM	23.32	23.35	23.36
15	1	37		22.96	22.99	22.82
15	1	74		23.23	23.26	23.32
15	36	0		22.09	22.12	22.16
15	36	20		22.04	22.07	22.04
15	36	39		22.14	22.17	22.00
15	75	0		22.06	22.09	22.02
15	1	0	64-QAM	22.67	22.70	22.84
15	1	37		22.11	22.14	22.51
15	1	74		22.87	22.90	22.78
15	36	0		21.63	21.66	21.75
15	36	20		21.59	21.62	21.77
15	36	39		21.63	21.66	21.71
15	75	0		21.59	21.62	21.75
10	1	0	QPSK	24.04	24.04	24.13
10	1	25		23.85	23.85	23.77
10	1	49		24.11	24.11	23.98
10	25	0		23.02	23.02	23.02
10	25	12		22.98	22.98	22.99
10	25	25		23.06	23.06	23.00
10	50	0		23.02	23.02	23.04
10	1	0	16-QAM	23.33	23.33	23.33
10	1	25		23.13	23.13	22.91
10	1	49		23.36	23.36	23.18
10	25	0		21.96	21.96	22.05
10	25	12		21.94	21.94	21.95
10	25	25		21.98	21.98	22.00
10	50	0		21.93	21.93	21.92
10	1	0	64-QAM	22.57	22.57	21.80
10	1	25		22.42	22.42	21.75
10	1	49		22.48	22.48	21.88
10	25	0		21.55	21.55	20.64
10	25	12		21.57	21.57	20.66
10	25	25		21.56	21.56	20.64
10	50	0		21.54	21.54	20.77



LTE Band 26 Maximum Average Power [dBm]						
BW [MHz]	RB Size	RB Offset	Mod	Lowest	Middle	Highest
5	1	0	QPSK	24.00	24.03	24.02
5	1	12		23.63	23.66	23.76
5	1	24		24.01	24.04	24.09
5	12	0		23.07	23.10	23.02
5	12	7		23.00	23.03	23.07
5	12	13		23.07	23.10	23.06
5	25	0		22.97	23.00	23.09
5	1	0	16-QAM	23.26	23.29	23.24
5	1	12		22.72	22.75	22.73
5	1	24		23.30	23.33	23.20
5	12	0		22.02	22.05	22.01
5	12	7		21.93	21.96	22.06
5	12	13		22.03	22.06	22.01
5	25	0		21.94	21.97	21.97
5	1	0	64-QAM	22.15	22.18	21.84
5	1	12		22.08	22.11	21.45
5	1	24		22.23	22.26	21.79
5	12	0		21.61	21.64	20.68
5	12	7		21.57	21.60	20.67
5	12	13		21.60	21.63	20.70
5	25	0		21.55	21.58	20.60
3	1	0	QPSK	24.08	24.11	24.05
3	1	8		24.11	24.14	24.04
3	1	14		24.10	24.13	23.94
3	8	0		22.93	22.96	23.03
3	8	4		23.00	23.03	23.08
3	8	7		23.04	23.07	22.96
3	15	0		23.01	23.04	23.10
3	1	0	16-QAM	23.37	23.40	23.28
3	1	8		23.30	23.33	23.26
3	1	14		23.37	23.40	23.22
3	8	0		21.96	21.99	22.07
3	8	4		22.04	22.07	22.04
3	8	7		21.99	22.02	21.99
3	15	0		21.97	22.00	22.07
3	1	0	64-QAM	21.63	21.66	21.84
3	1	8		21.24	21.27	21.41
3	1	14		21.67	21.70	21.72
3	8	0		21.52	21.55	20.68
3	8	4		21.51	21.54	20.66
3	8	7		21.45	21.48	20.55
3	15	0		21.54	21.57	20.60



LTE Band 26 Maximum Average Power [dBm]						
BW [MHz]	RB Size	RB Offset	Mod	Lowest	Middle	Highest
1.4	1	0	QPSK	24.01	24.04	24.04
1.4	1	3		23.84	23.87	23.67
1.4	1	5		24.04	24.07	23.92
1.4	3	0		24.08	24.11	24.00
1.4	3	1		23.92	23.95	23.93
1.4	3	3		23.95	23.98	23.83
1.4	6	0		23.06	23.09	22.90
1.4	1	0	16-QAM	23.34	23.37	23.26
1.4	1	3		22.99	23.02	22.95
1.4	1	5		23.33	23.36	23.23
1.4	3	0		22.95	22.98	22.84
1.4	3	1		22.93	22.96	22.79
1.4	3	3		22.96	22.99	22.76
1.4	6	0		22.09	22.12	22.02
1.4	1	0	64-QAM	22.67	22.70	21.80
1.4	1	3		22.52	22.55	21.69
1.4	1	5		22.65	22.68	21.82
1.4	3	0		22.51	22.54	21.70
1.4	3	1		22.57	22.60	21.73
1.4	3	3		22.59	22.62	21.68
1.4	6	0		21.56	21.59	20.60



LTE Band 26_Part 22H

Peak-to-Average Ratio

Mode	LTE Band 26 / 15MHz				
Mod.	QPSK		16QAM		Limit: 13dB
RB Size	1RB	Full RB	1RB	Full RB	Result
Lowest CH	4.06	5.25	4.96	6.03	PASS
Middle CH	4.58	5.07	5.65	5.86	
Highest CH	4.78	5.1	5.22	5.91	
Mod.	64QAM		Limit: 13dB		
RB Size	1RB	Full RB	Result		
Lowest CH	5.77	6.38	PASS		
Middle CH	6.49	6.41			
Highest CH	6.29	6.38			



LTE Band 26 / 15MHz / QPSK

Lowest Channel / 1RB

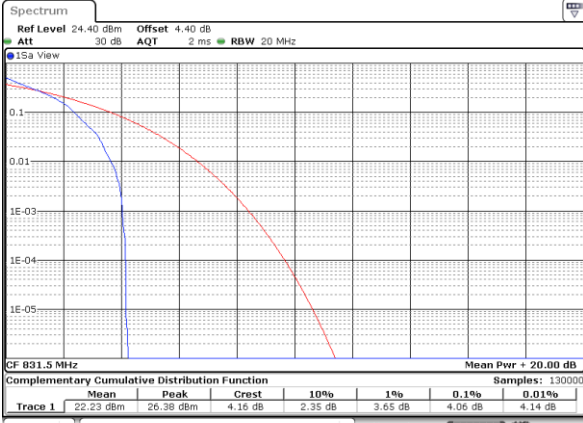

Date: 18 AUG 2018 13:00:42

Lowest Channel / Full RB

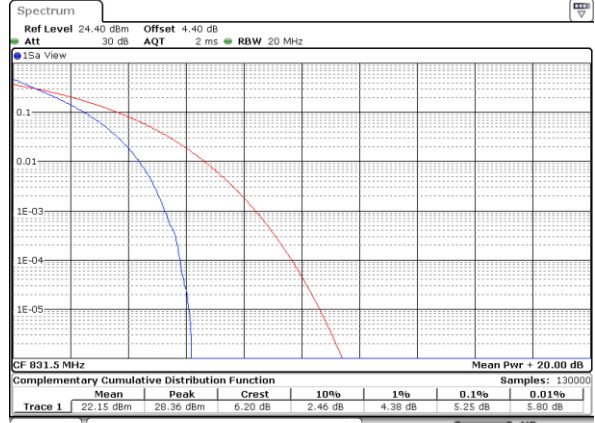

Date: 18 AUG 2018 13:01:50

Middle Channel / 1RB

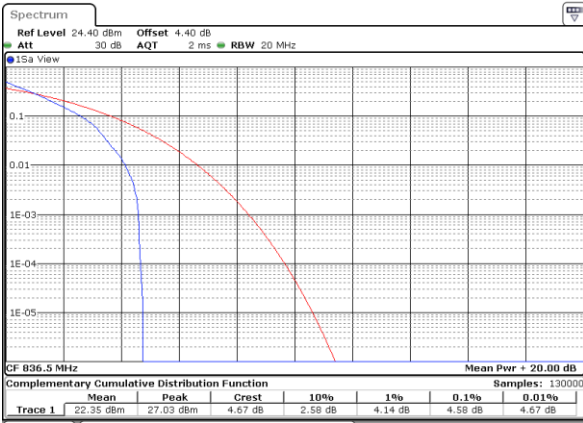

Date: 18 AUG 2018 13:02:50

Middle Channel / Full RB

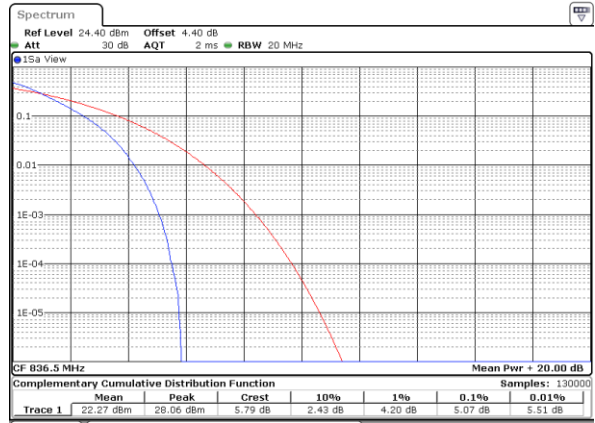

Date: 18 AUG 2018 13:03:37

Highest Channel / 1RB

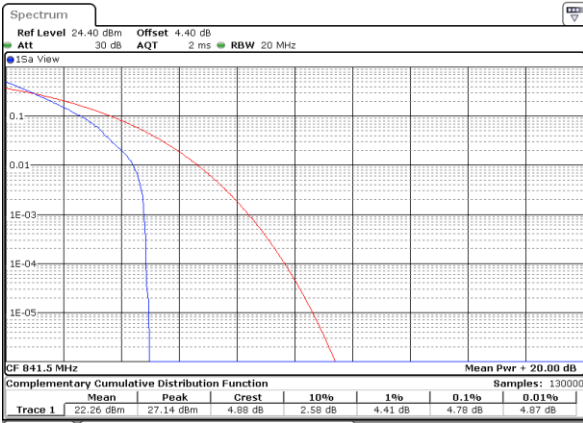

Date: 18 AUG 2018 13:04:25

Highest Channel / Full RB

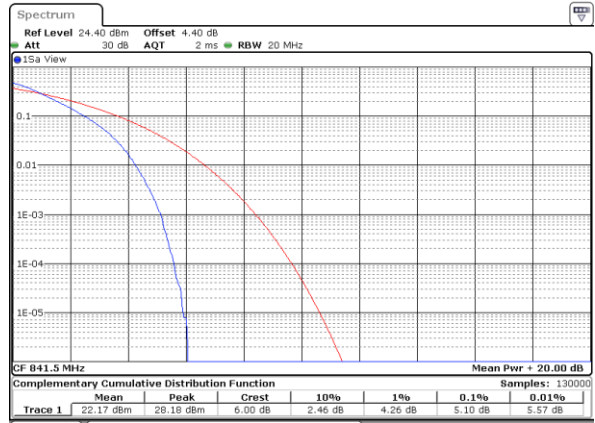

Date: 18 AUG 2018 13:05:06



LTE Band 26 / 15MHz / 16QAM

Lowest Channel / 1RB



Date: 18 AUG 2018 13:00:56

Lowest Channel / Full RB

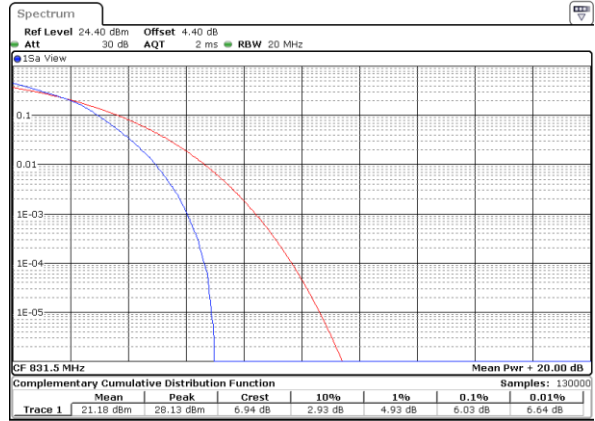

Date: 18 AUG 2018 13:02:03

Middle Channel / 1RB



Date: 18 AUG 2018 13:03:02

Middle Channel / Full RB

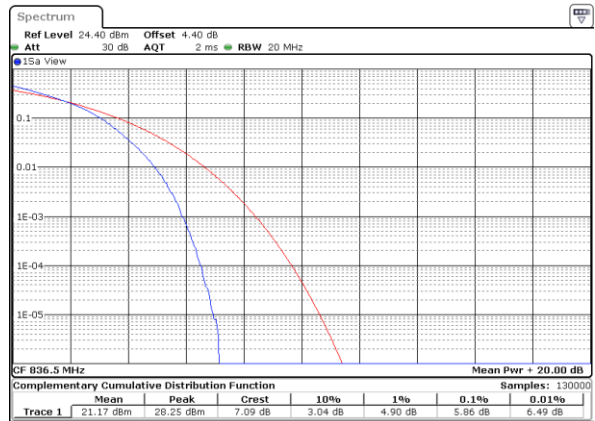

Date: 18 AUG 2018 13:03:48

Highest Channel / 1RB

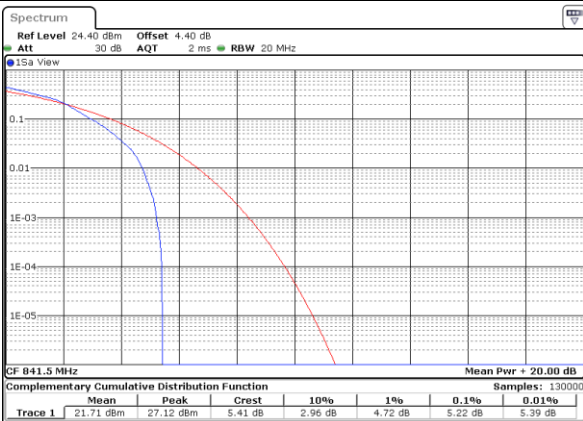

Date: 18 AUG 2018 13:04:37

Highest Channel / Full RB



Date: 18 AUG 2018 13:05:21



LTE Band 26 / 15MHz / 64QAM

Lowest Channel / 1RB

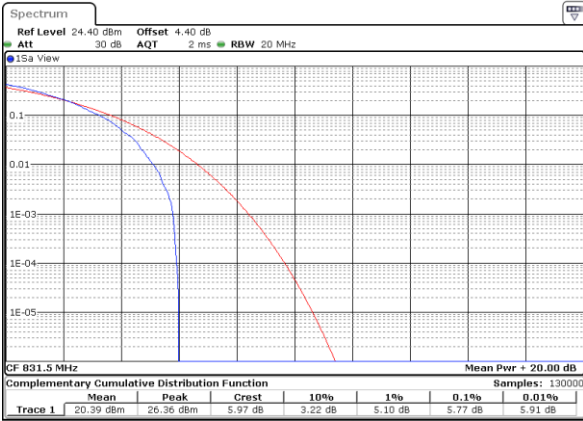

Date: 18 AUG 2018 13:01:30

Lowest Channel / Full RB

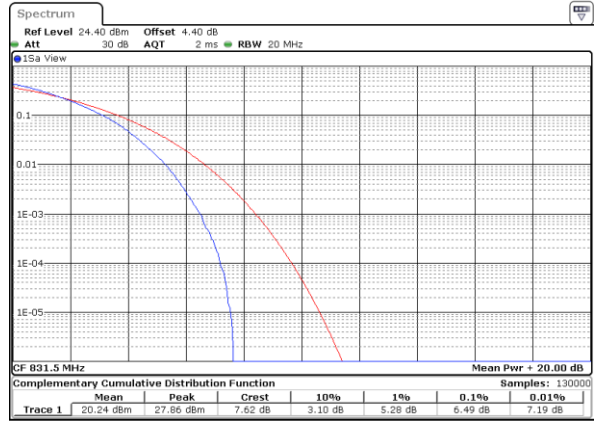

Date: 18 AUG 2018 13:02:23

Middle Channel / 1RB

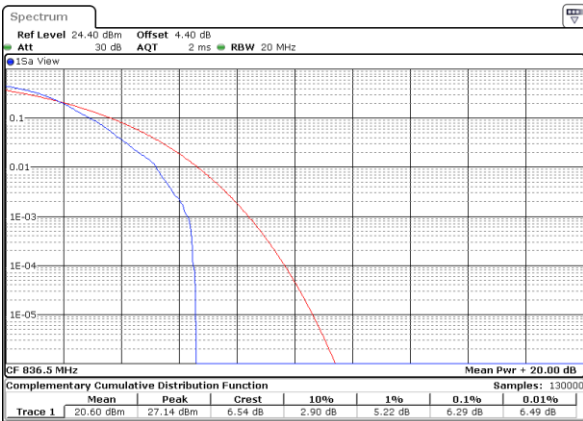

Date: 18 AUG 2018 13:03:22

Middle Channel / Full RB

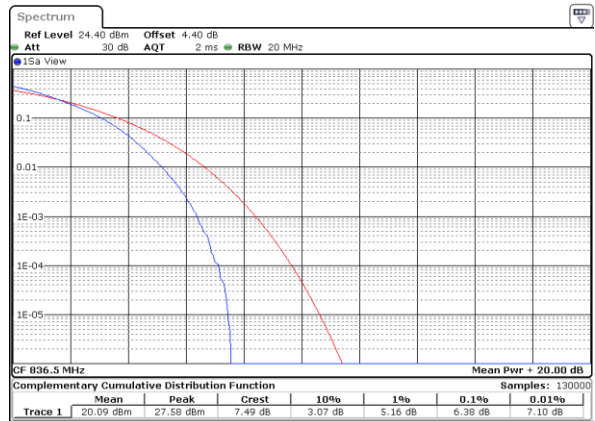

Date: 18 AUG 2018 13:04:01

Highest Channel / 1RB



Date: 18 AUG 2018 13:04:51

Highest Channel / Full RB



Date: 18 AUG 2018 13:05:38



26dB Bandwidth

Mode	LTE Band 26 : 26dB BW(MHz)											
BW	1.4MHz		3MHz		5MHz		10MHz		15MHz		20MHz	
Mod.	QPSK	16QAM	QPSK	16QAM	QPSK	16QAM	QPSK	16QAM	QPSK	16QAM	QPSK	16QAM
Lowest CH	1.234	1.245	3.009	2.985	4.945	4.885	9.73	9.75	14.505	14.865	-	-
Middle CH	1.231	1.248	3.009	3.009	4.965	4.915	9.77	9.83	14.535	14.595	-	-
Highest CH	1.234	1.248	3.027	2.979	4.835	4.955	9.99	9.91	14.176	14.835	-	-
BW	1.4MHz		3MHz		5MHz		10MHz		15MHz		20MHz	
Mod.	64QAM		64QAM		64QAM		64QAM		64QAM			
Lowest CH	1.245		2.943		4.905		9.97		14.895		-	-
Middle CH	1.253		3.009		4.905		9.81		14.356		-	-
Highest CH	1.242		2.991		4.915		9.87		14.685		-	-



LTE Band 26

Lowest Channel / 1.4MHz / QPSK

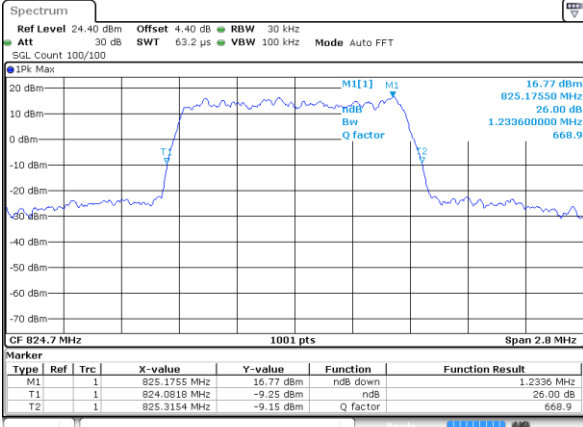

Date: 18 AUG 2018 10:28:46

Lowest Channel / 1.4MHz / 16QAM

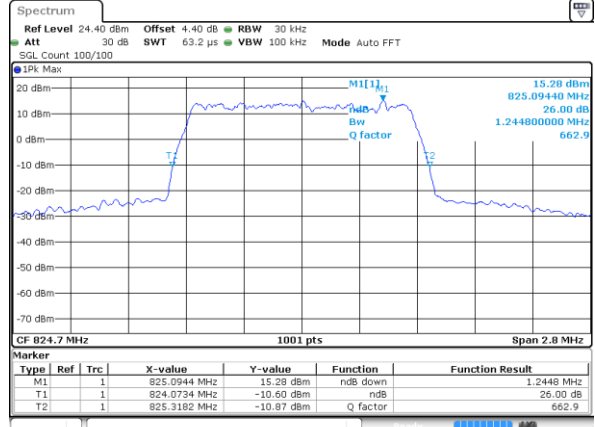

Date: 18 AUG 2018 10:29:06

Middle Channel / 1.4MHz / QPSK

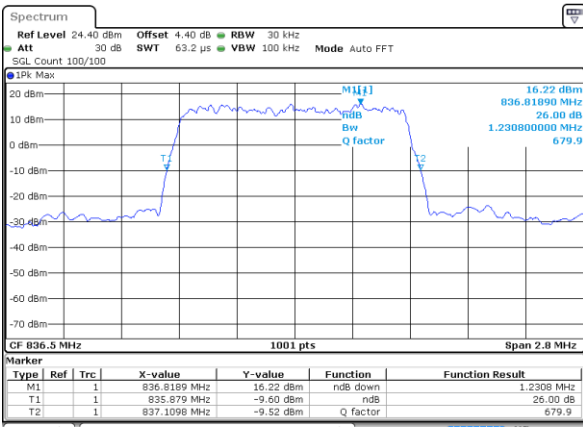

Date: 18 AUG 2018 10:29:45

Middle Channel / 1.4MHz / 16QAM

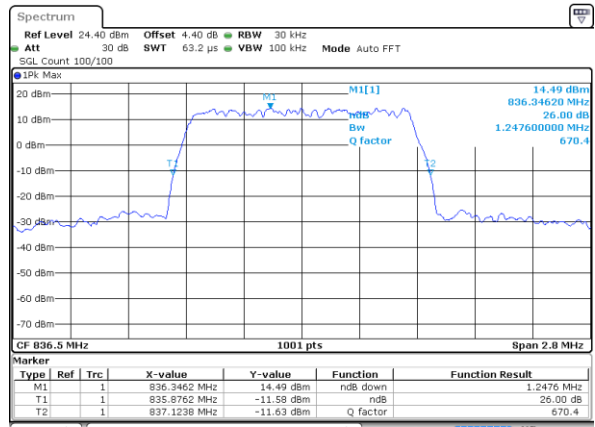

Date: 18 AUG 2018 10:30:04

Highest Channel / 1.4MHz / QPSK

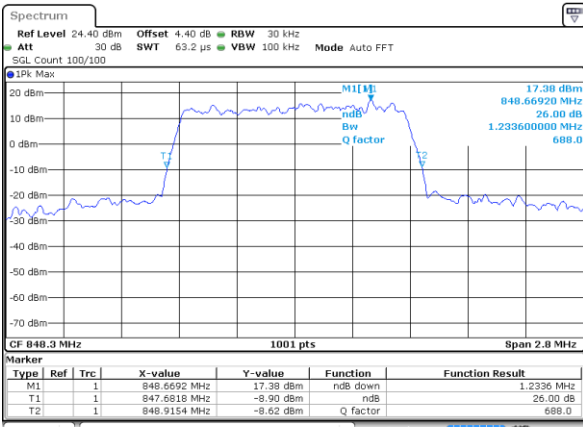

Date: 18 AUG 2018 10:30:56

Highest Channel / 1.4MHz / 16QAM

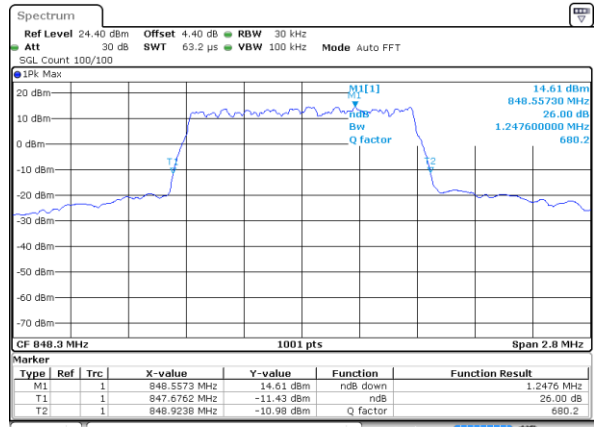

Date: 18 AUG 2018 10:31:31



LTE Band 26

Lowest Channel / 3MHz / QPSK

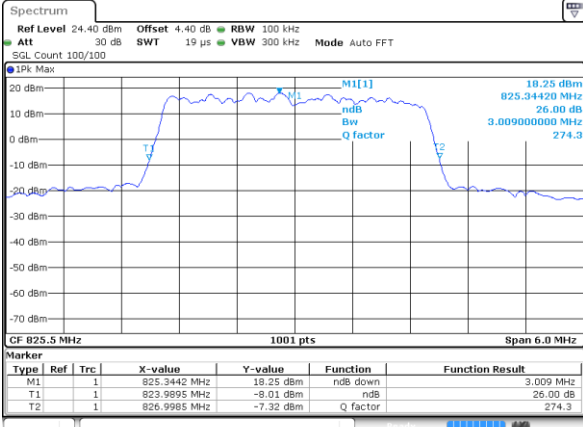

Date: 18 AUG 2018 11:10:54

Lowest Channel / 3MHz / 16QAM

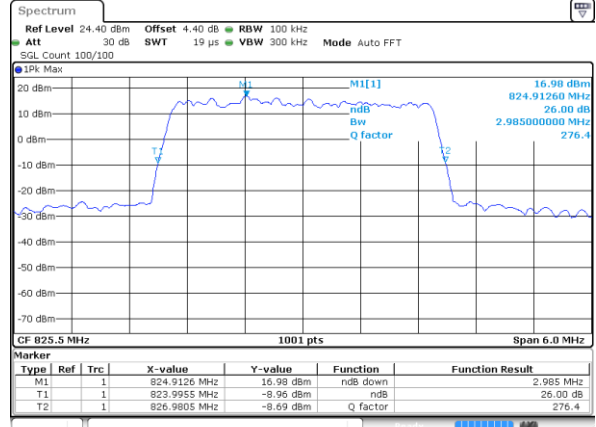

Date: 18 AUG 2018 11:11:13

Middle Channel / 3MHz / QPSK

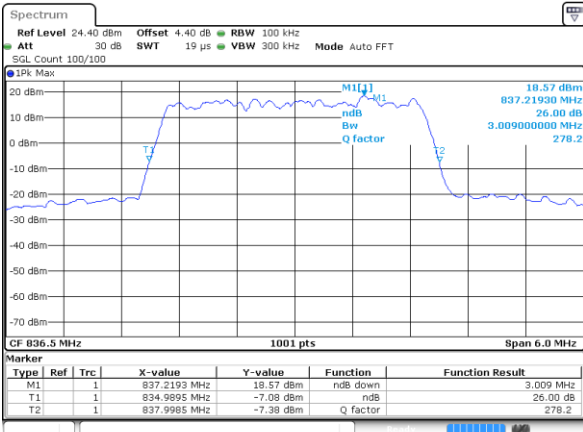

Date: 18 AUG 2018 11:12:03

Middle Channel / 3MHz / 16QAM

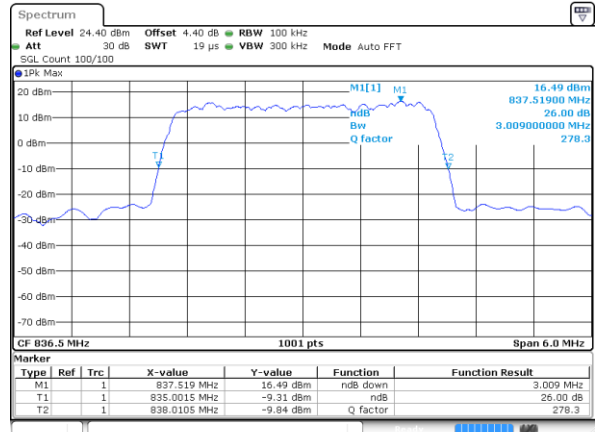

Date: 18 AUG 2018 11:12:25

Highest Channel / 3MHz / QPSK

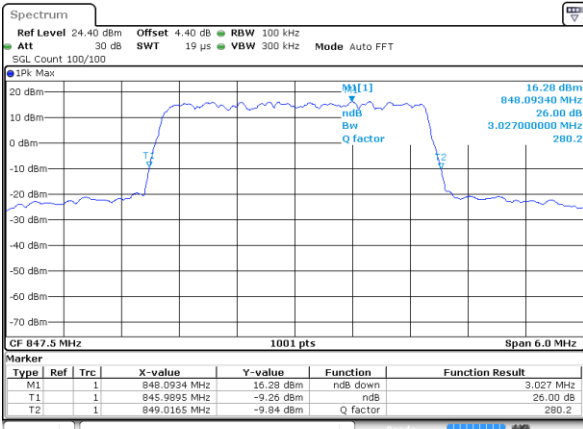

Date: 18 AUG 2018 11:13:08

Highest Channel / 3MHz / 16QAM

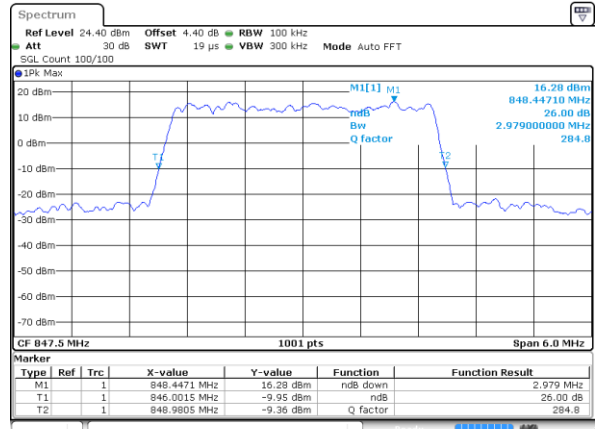

Date: 18 AUG 2018 11:13:26



LTE Band 26

Lowest Channel / 5MHz / QPSK

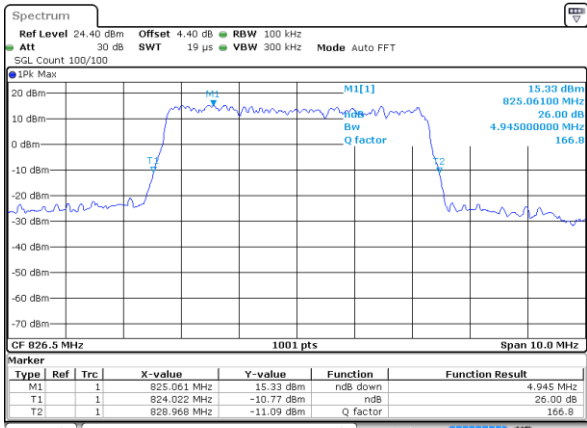

Date: 18 AUG 2018 11:33:04

Lowest Channel / 5MHz / 16QAM

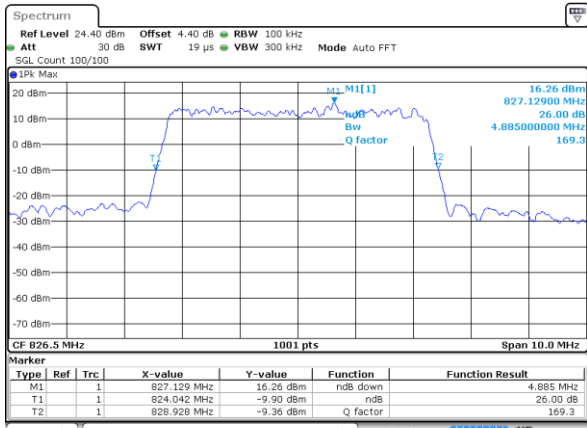

Date: 18 AUG 2018 11:33:23

Middle Channel / 5MHz / QPSK

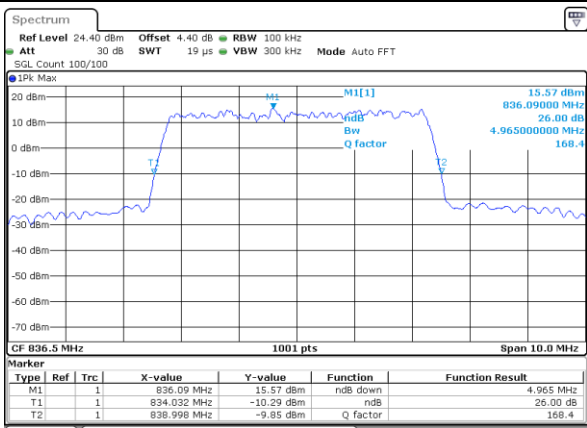

Date: 18 AUG 2018 11:34:02

Middle Channel / 5MHz / 16QAM

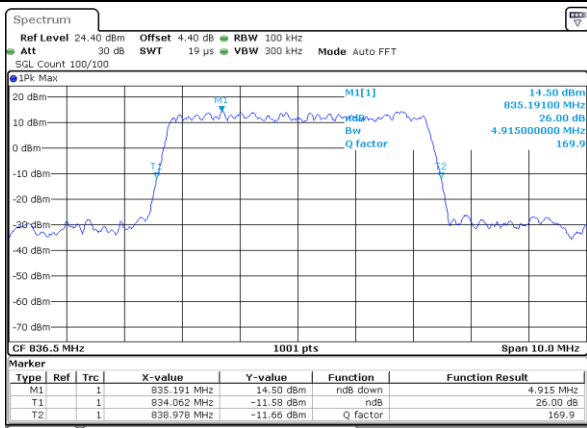

Date: 18 AUG 2018 11:34:21

Highest Channel / 5MHz / QPSK

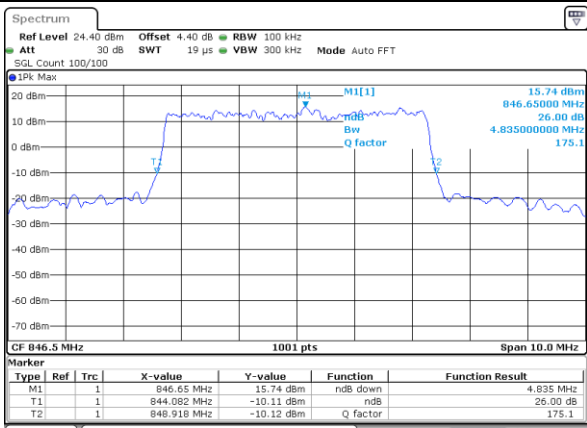

Date: 18 AUG 2018 11:35:01

Highest Channel / 5MHz / 16QAM

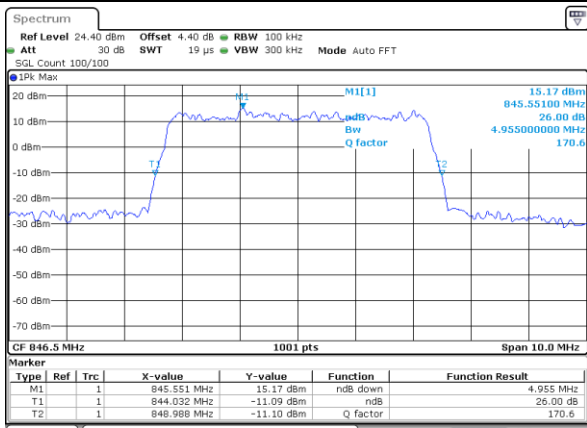

Date: 18 AUG 2018 11:35:21



LTE Band 26

Lowest Channel / 10MHz / QPSK

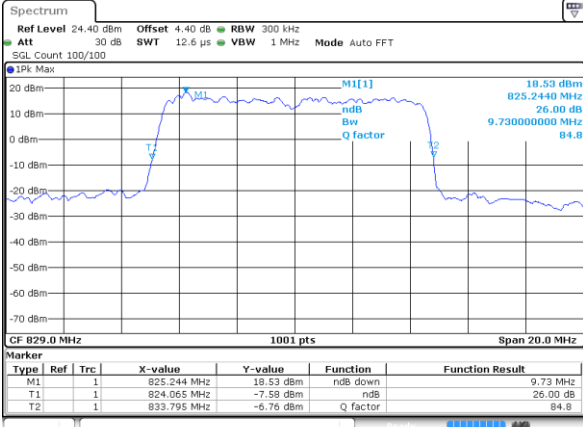

Date: 18 AUG 2018 11:53:36

Lowest Channel / 10MHz / 16QAM

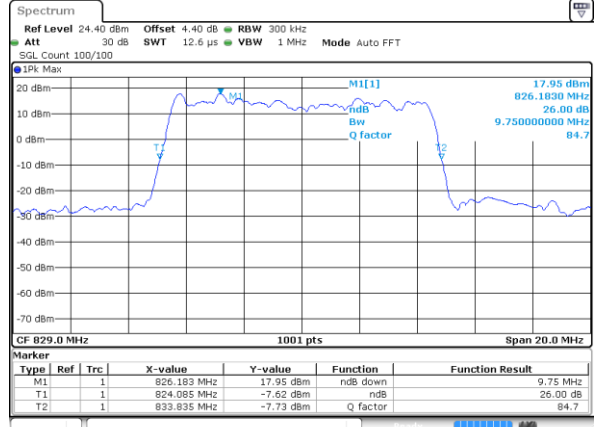

Date: 18 AUG 2018 11:53:55

Middle Channel / 10MHz / QPSK

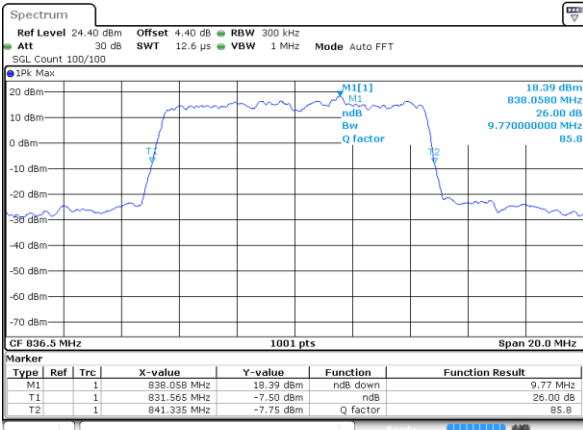

Date: 18 AUG 2018 11:54:35

Middle Channel / 10MHz / 16QAM

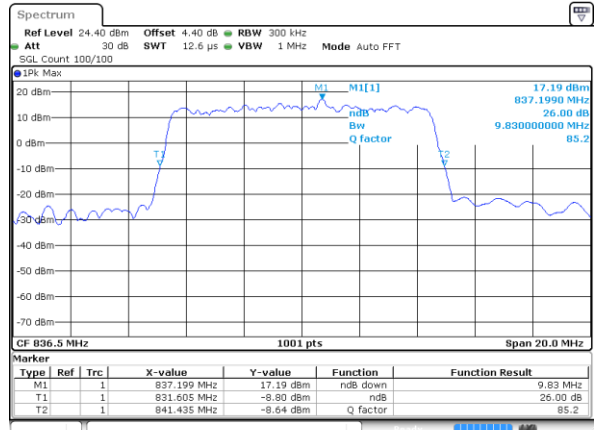

Date: 18 AUG 2018 11:54:53

Highest Channel / 10MHz / QPSK

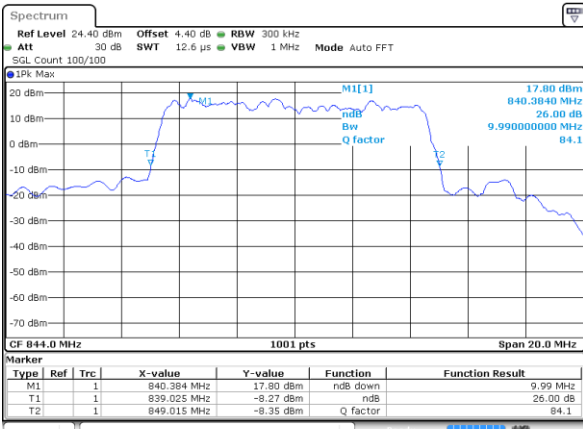

Date: 18 AUG 2018 11:55:44

Highest Channel / 10MHz / 16QAM

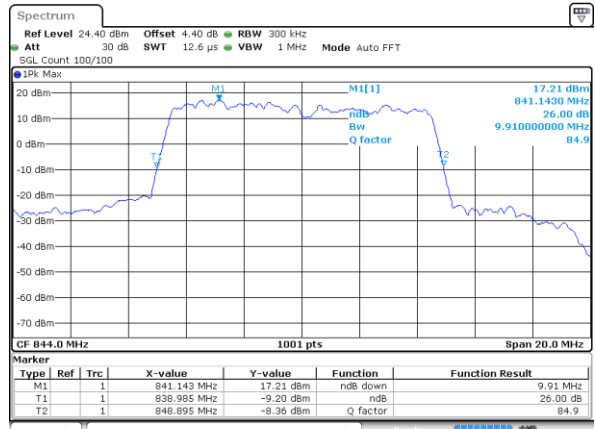

Date: 18 AUG 2018 11:56:05



LTE Band 26

Lowest Channel / 15MHz / QPSK

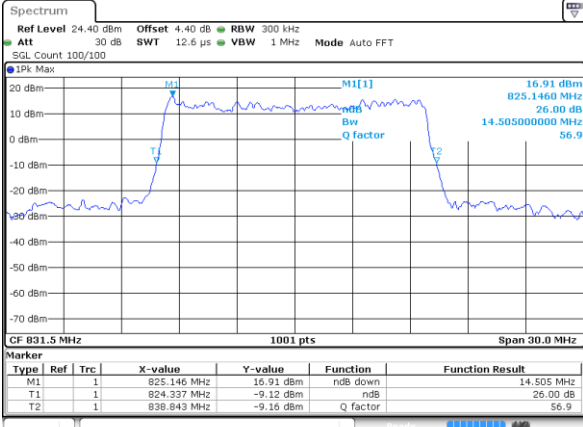

Date: 18 AUG 2018 12:42:49

Lowest Channel / 15MHz / 16QAM

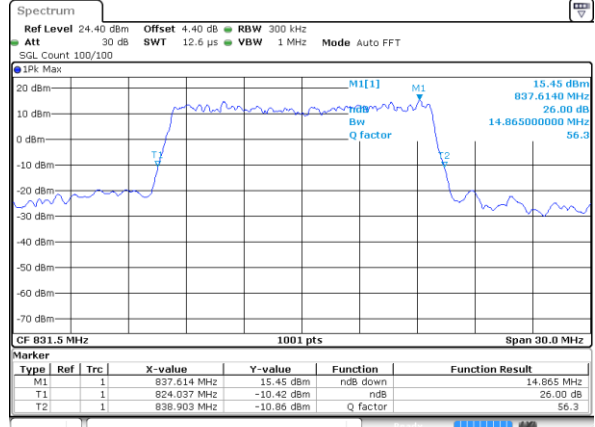

Date: 18 AUG 2018 12:43:09

Middle Channel / 15MHz / QPSK

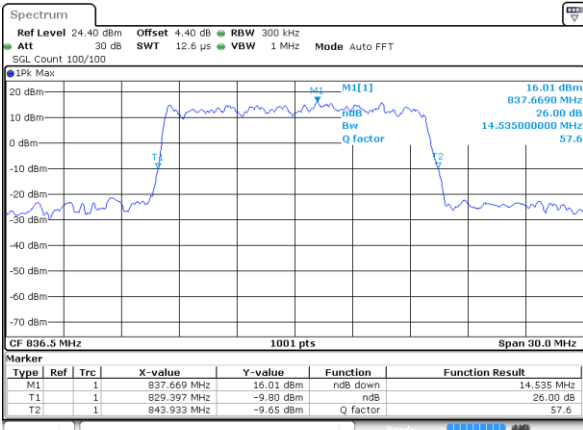

Date: 18 AUG 2018 12:43:57

Middle Channel / 15MHz / 16QAM

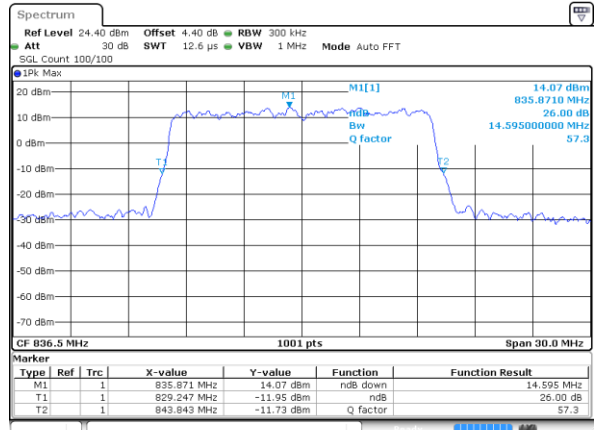

Date: 18 AUG 2018 12:44:31

Highest Channel / 15MHz / QPSK

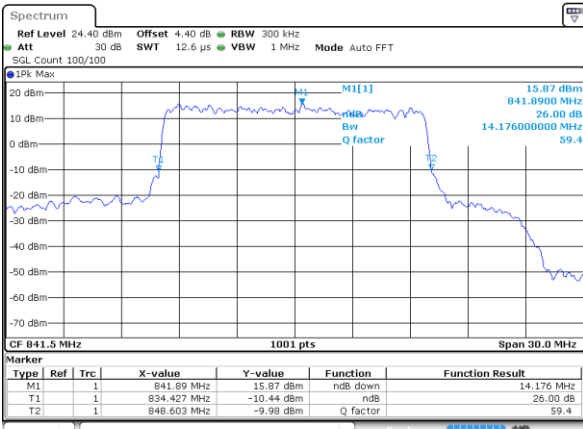

Date: 18 AUG 2018 12:45:24

Highest Channel / 15MHz / 16QAM

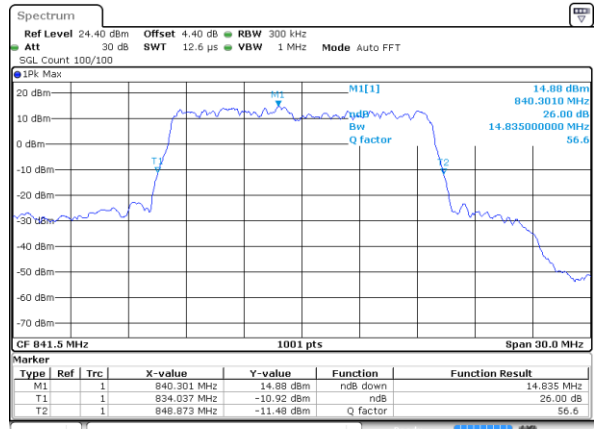

Date: 18 AUG 2018 12:45:44



LTE Band 26

Lowest Channel / 1.4MHz / 64QAM

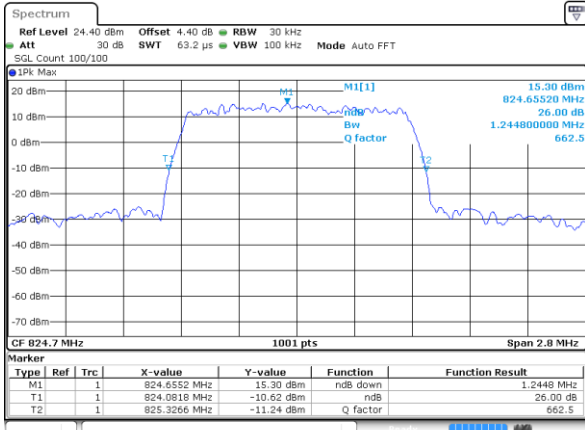

Date: 18 AUG 2018 10:29:24

Lowest Channel / 3MHz / 64QAM

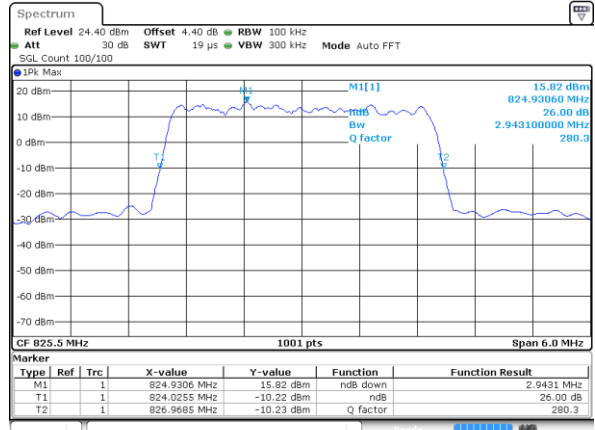

Date: 18 AUG 2018 11:11:34

Middle Channel / 1.4MHz / 64QAM

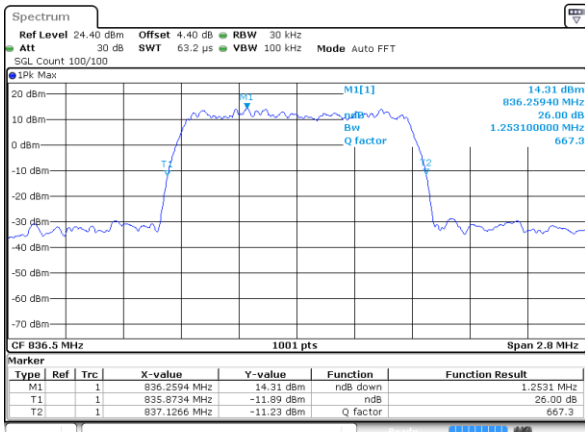

Date: 18 AUG 2018 10:30:27

Middle Channel / 3MHz / 64QAM

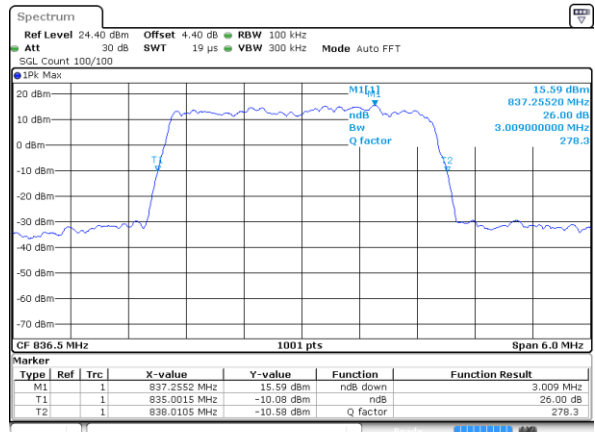

Date: 18 AUG 2018 11:12:46

Highest Channel / 1.4MHz / 64QAM

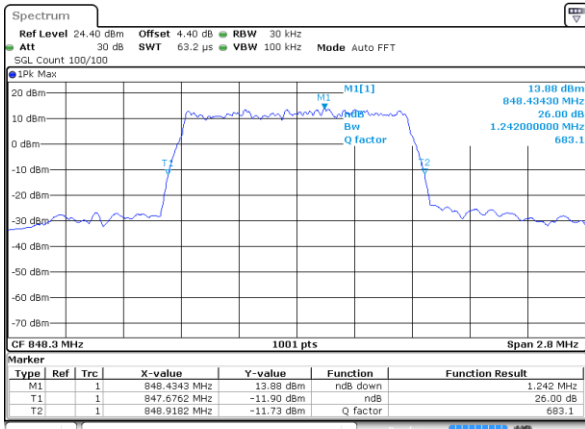

Date: 18 AUG 2018 10:31:50

Highest Channel / 3MHz / 64QAM

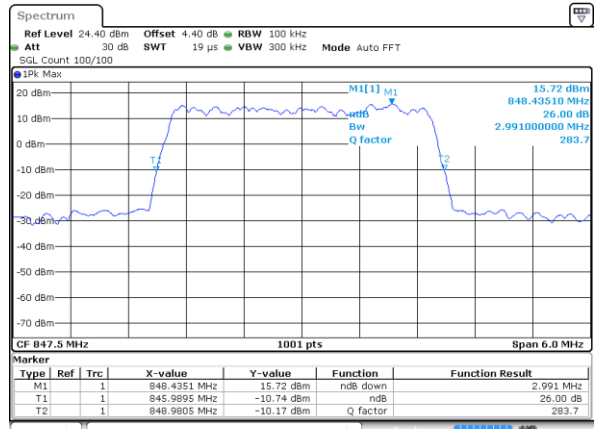

Date: 18 AUG 2018 11:13:53



LTE Band 26

Lowest Channel / 5MHz / 64QAM

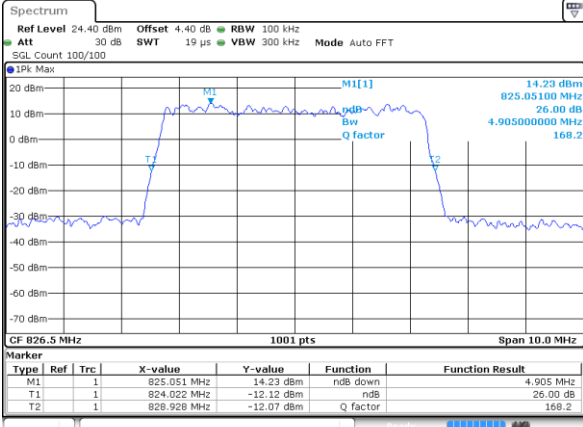

Date: 18 AUG 2018 11:33:42

Lowest Channel / 10MHz / 64QAM

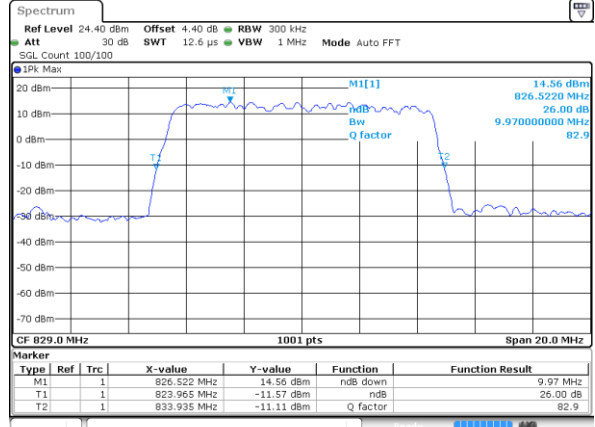

Date: 18 AUG 2018 11:54:14

Middle Channel / 5MHz / 64QAM

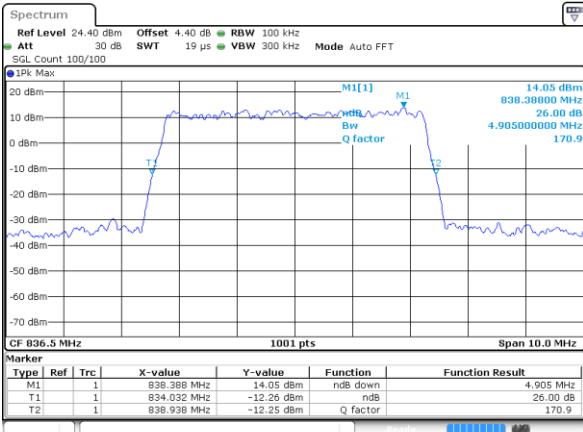

Date: 18 AUG 2018 11:34:41

Middle Channel / 10MHz / 64QAM

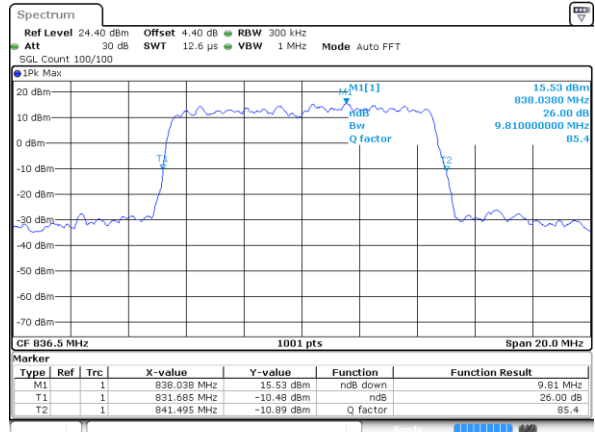

Date: 18 AUG 2018 11:55:15

Highest Channel / 5MHz / 64QAM

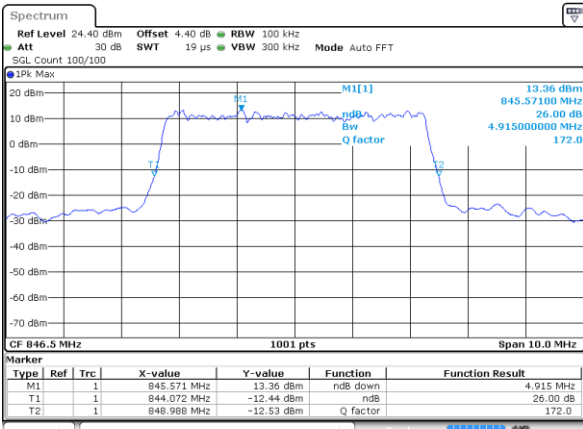

Date: 18 AUG 2018 11:35:40

Highest Channel / 10MHz / 64QAM

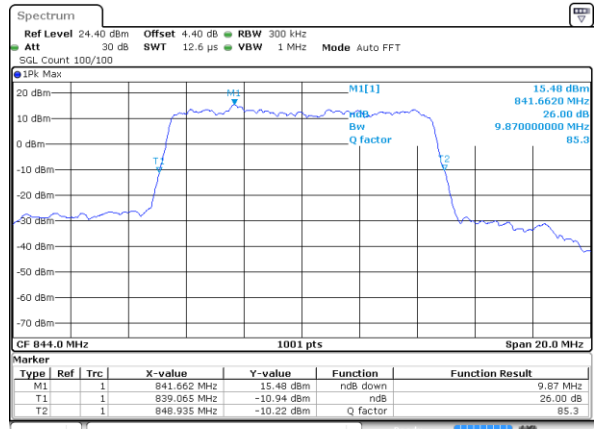

Date: 18 AUG 2018 11:56:26



LTE Band 26

Lowest Channel / 15MHz / 64QAM

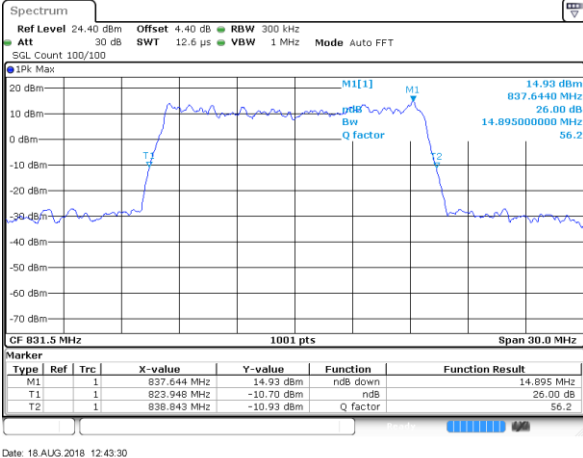

Middle Channel / 15MHz / 64QAM

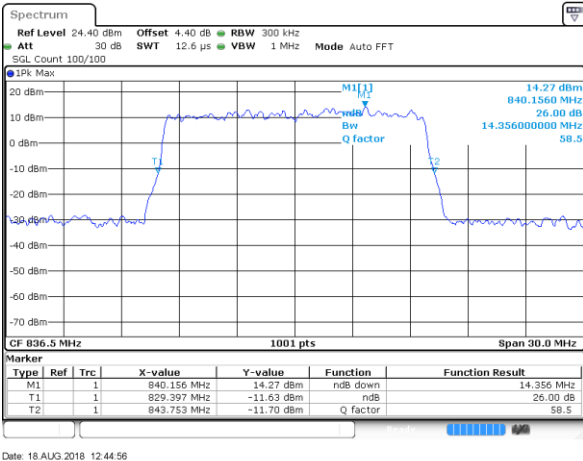

Highest Channel / 15MHz / 64QAM

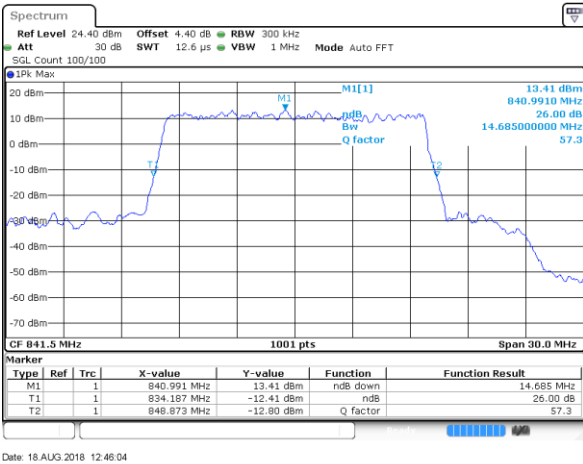



Occupied Bandwidth

Mode	LTE Band 26 : 99%OBW(MHz)											
BW	1.4MHz		3MHz		5MHz		10MHz		15MHz		20MHz	
Mod.	QPSK	16QAM	QPSK	16QAM	QPSK	16QAM	QPSK	16QAM	QPSK	16QAM	QPSK	16QAM
Lowest CH	1.09	1.1	2.75	2.73	4.5	4.49	9.01	9.07	13.43	13.55	-	-
Middle CH	1.09	1.1	2.71	2.74	4.48	4.5	8.99	9.01	13.43	13.4	-	-
Highest CH	1.09	1.11	2.74	2.72	4.52	4.48	9.03	9.07	13.43	13.46	-	-
BW	1.4MHz		3MHz		5MHz		10MHz		15MHz		20MHz	
Mod.	64QAM		64QAM		64QAM		64QAM		64QAM			
Lowest CH	1.1		2.73		4.51		9.09		13.43		-	-
Middle CH	1.09		2.72		4.48		8.99		13.43		-	-
Highest CH	1.09		2.7		4.53		9.09		13.49		-	-



LTE Band 26

Lowest Channel / 1.4MHz / QPSK

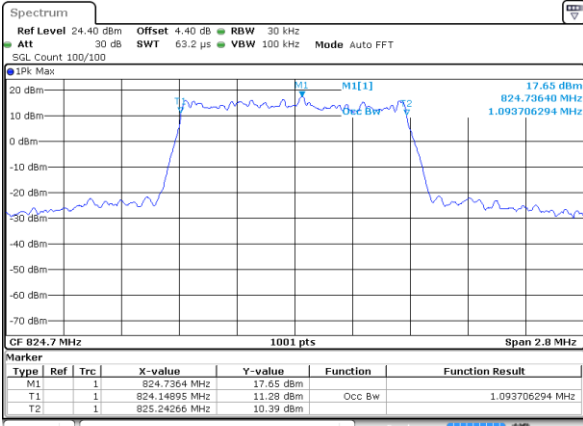

Date: 18 AUG 2018 10:28:36

Lowest Channel / 1.4MHz / 16QAM

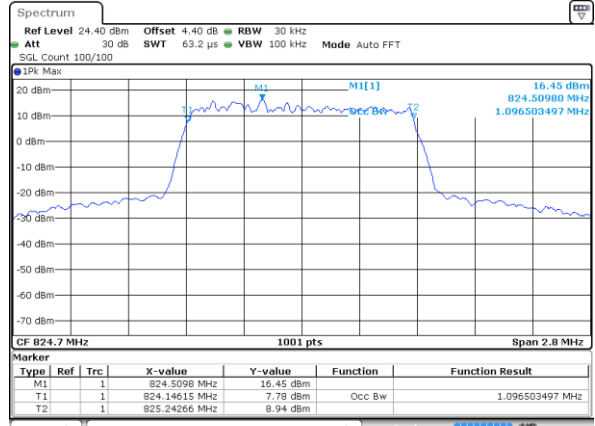

Date: 18 AUG 2018 10:28:58

Middle Channel / 1.4MHz / QPSK

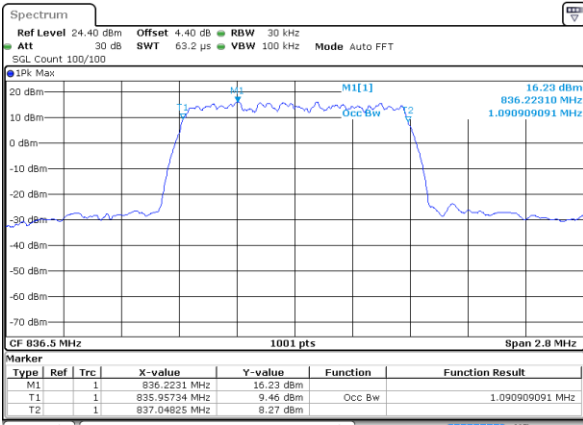

Date: 18 AUG 2018 10:29:37

Middle Channel / 1.4MHz / 16QAM

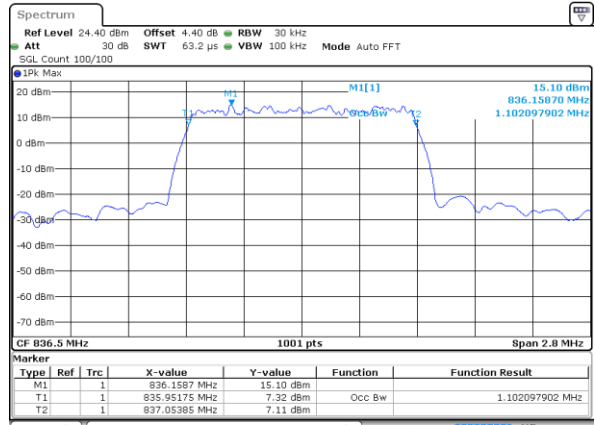

Date: 18 AUG 2018 10:29:55

Highest Channel / 1.4MHz / QPSK

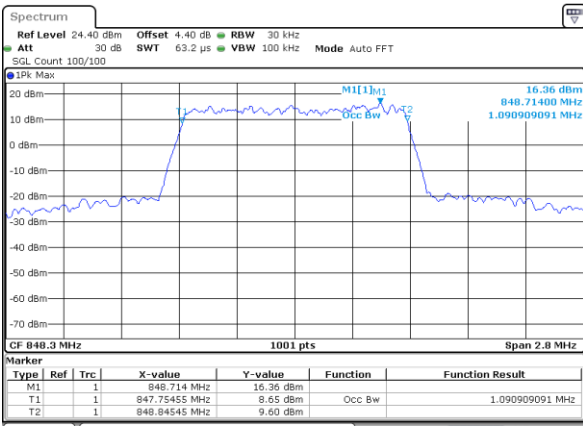

Date: 18 AUG 2018 10:30:48

Highest Channel / 1.4MHz / 16QAM

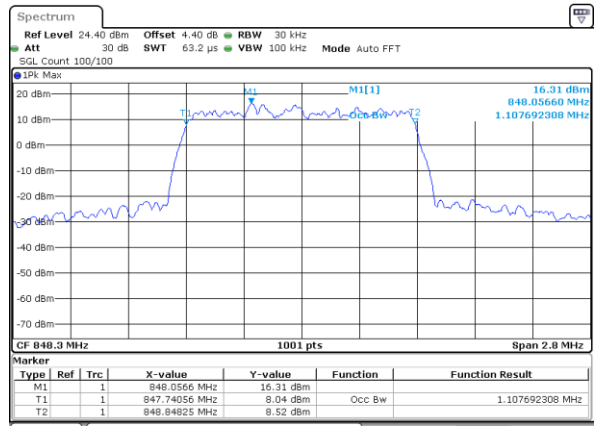

Date: 18 AUG 2018 10:31:16



LTE Band 26

Lowest Channel / 3MHz / QPSK

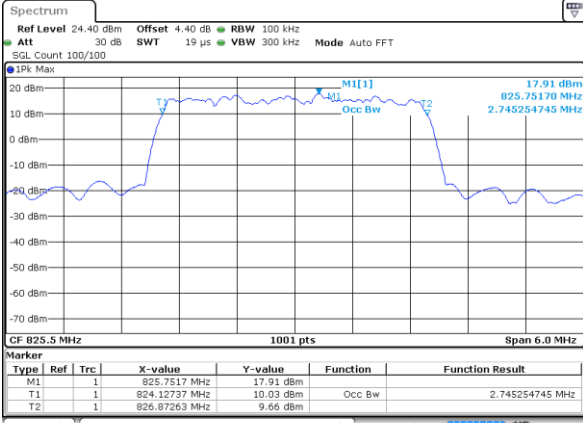

Date: 18 AUG 2018 11:10:46

Lowest Channel / 3MHz / 16QAM

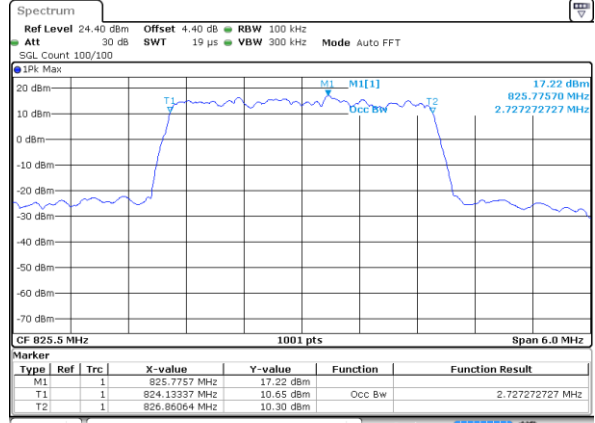

Date: 18 AUG 2018 11:11:04

Middle Channel / 3MHz / QPSK

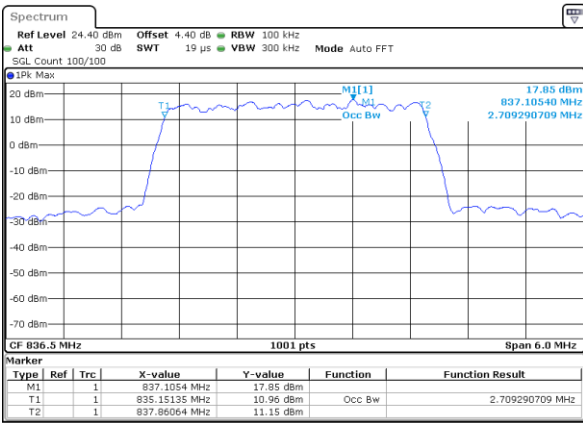

Date: 18 AUG 2018 11:11:46

Middle Channel / 3MHz / 16QAM

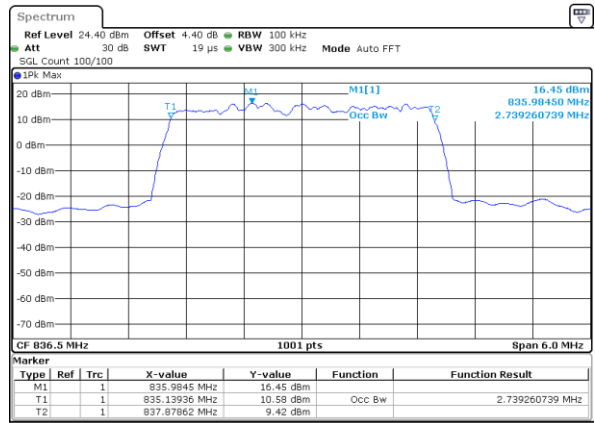

Date: 18 AUG 2018 11:12:14

Highest Channel / 3MHz / QPSK

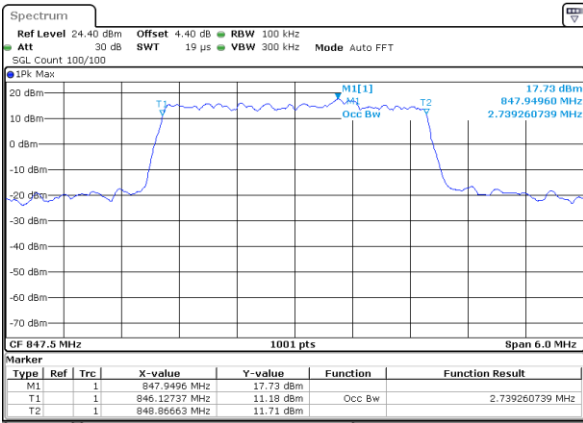

Date: 18 AUG 2018 11:12:58

Highest Channel / 3MHz / 16QAM

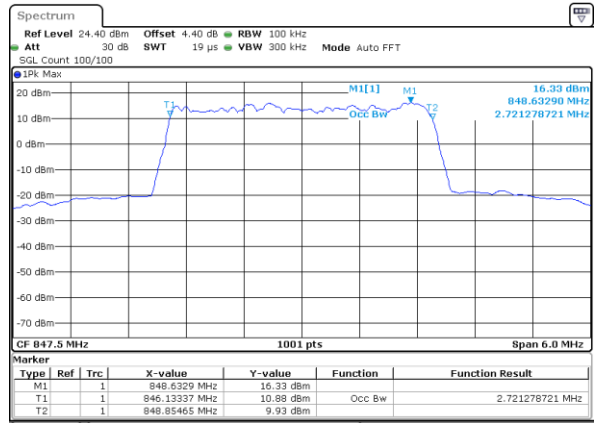

Date: 18 AUG 2018 11:13:18



LTE Band 26

Lowest Channel / 5MHz / QPSK

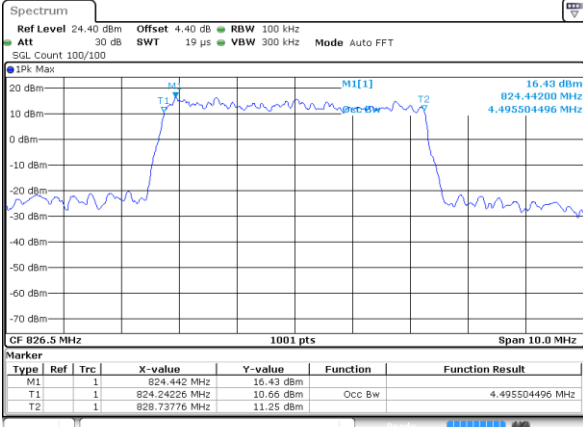

Date: 18 AUG 2018 11:32:55

Lowest Channel / 5MHz / 16QAM

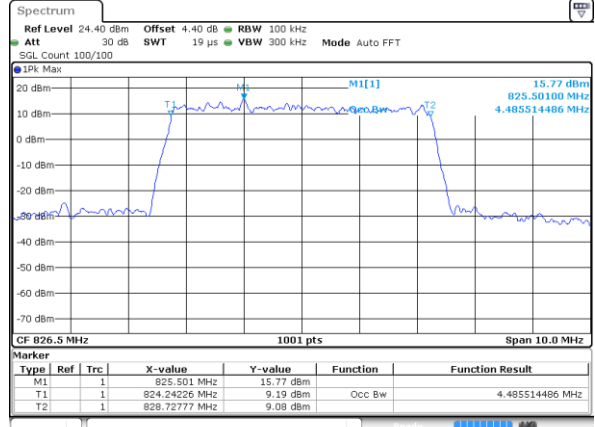

Date: 18 AUG 2018 11:33:15

Middle Channel / 5MHz / QPSK

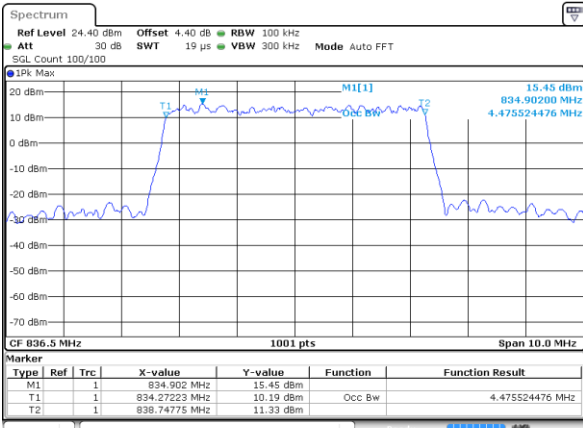

Date: 18 AUG 2018 11:33:54

Middle Channel / 5MHz / 16QAM

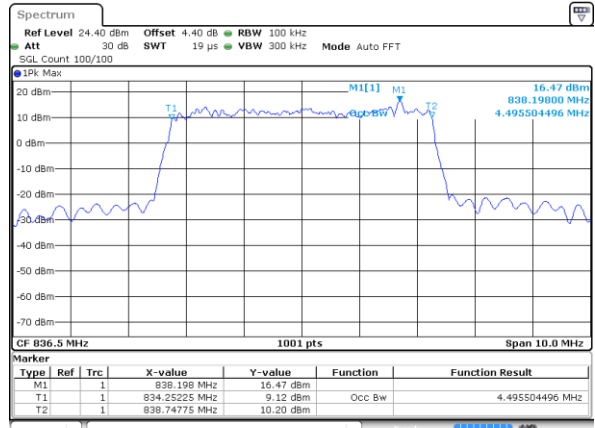

Date: 18 AUG 2018 11:34:13

Highest Channel / 5MHz / QPSK

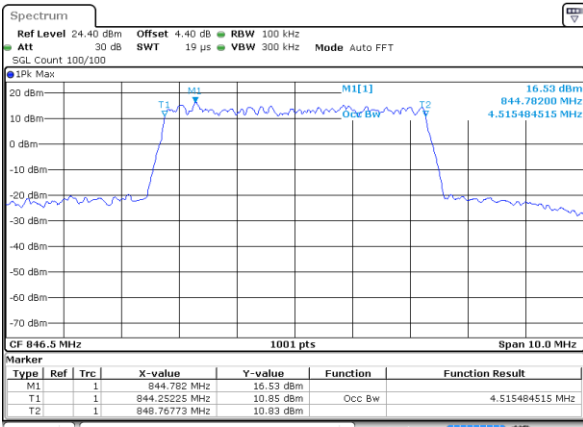

Date: 18 AUG 2018 11:34:53

Highest Channel / 5MHz / 16QAM

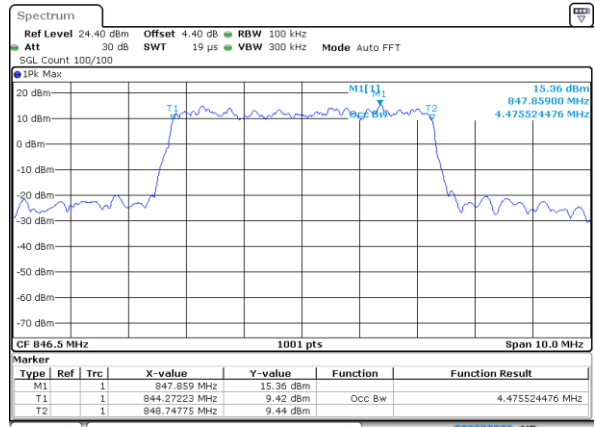

Date: 18 AUG 2018 11:35:12



LTE Band 26

Lowest Channel / 10MHz / QPSK

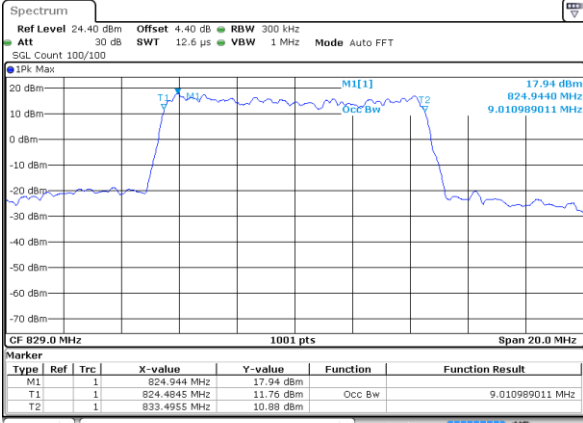

Date: 18 AUG 2018 11:53:27

Lowest Channel / 10MHz / 16QAM

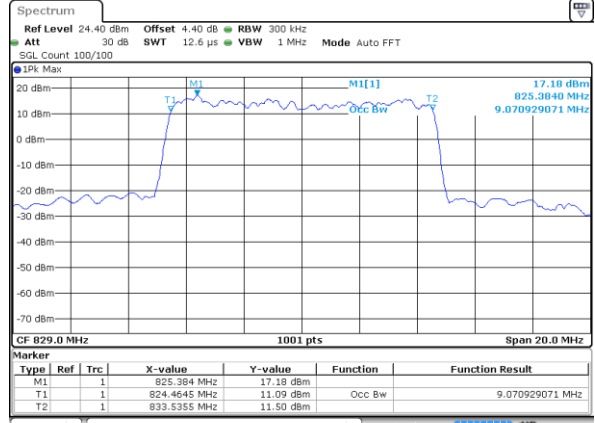

Date: 18 AUG 2018 11:53:47

Middle Channel / 10MHz / QPSK

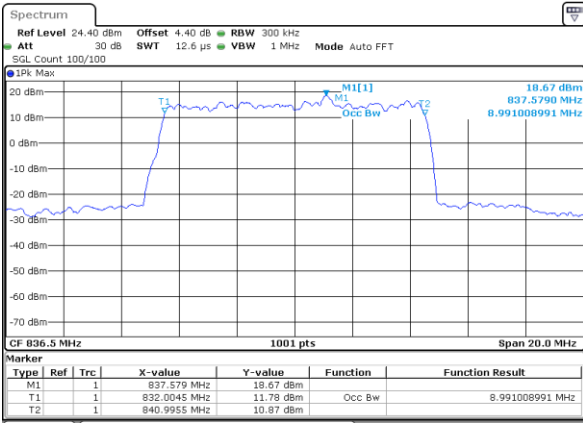

Date: 18 AUG 2018 11:54:26

Middle Channel / 10MHz / 16QAM

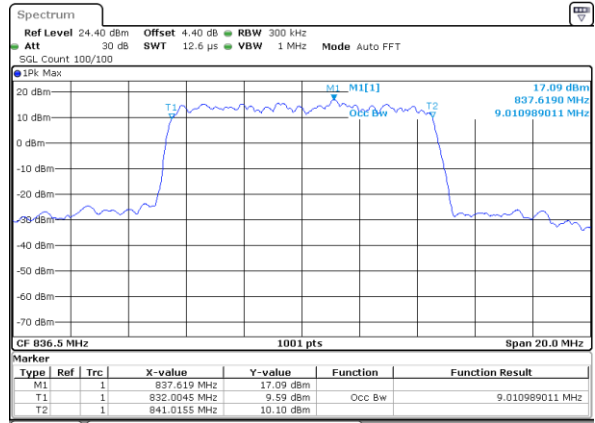

Date: 18 AUG 2018 11:54:45

Highest Channel / 10MHz / QPSK

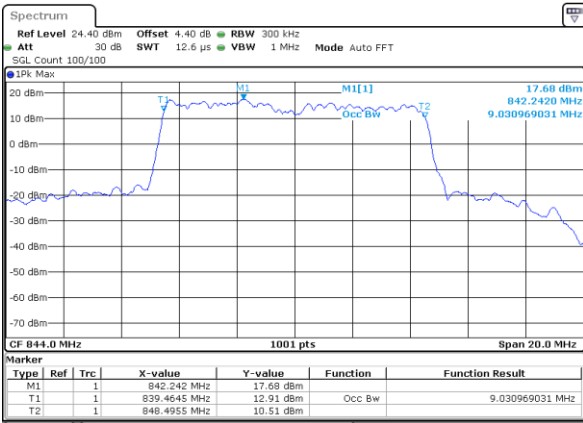

Date: 18 AUG 2018 11:55:35

Highest Channel / 10MHz / 16QAM

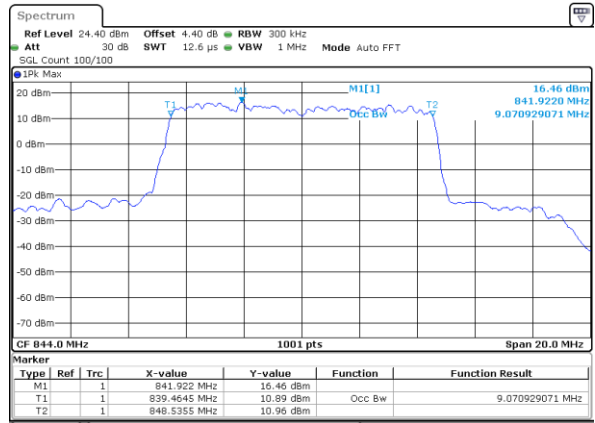

Date: 18 AUG 2018 11:55:55



LTE Band 26

Lowest Channel / 15MHz / QPSK

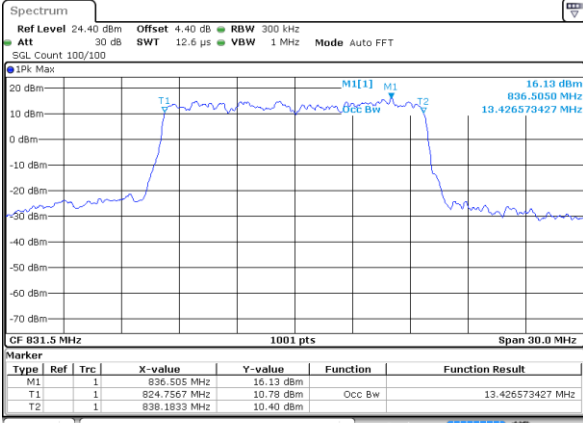

Date: 18 AUG 2018 12:42:40

Lowest Channel / 15MHz / 16QAM

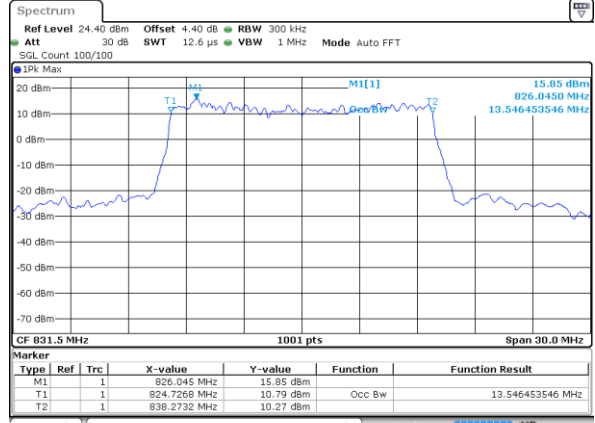

Date: 18 AUG 2018 12:43:00

Middle Channel / 15MHz / QPSK

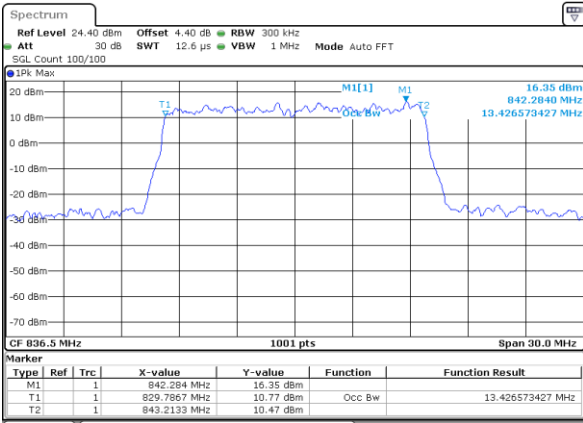

Date: 18 AUG 2018 12:43:48

Middle Channel / 15MHz / 16QAM

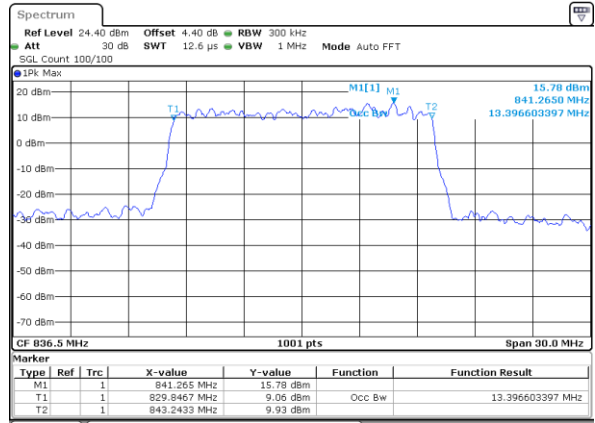

Date: 18 AUG 2018 12:44:22

Highest Channel / 15MHz / QPSK

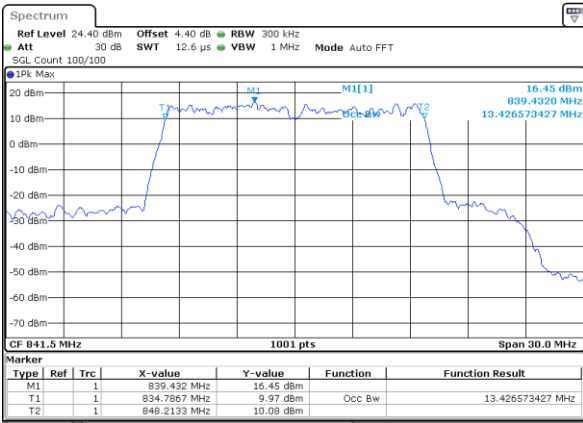

Date: 18 AUG 2018 12:45:15

Highest Channel / 15MHz / 16QAM

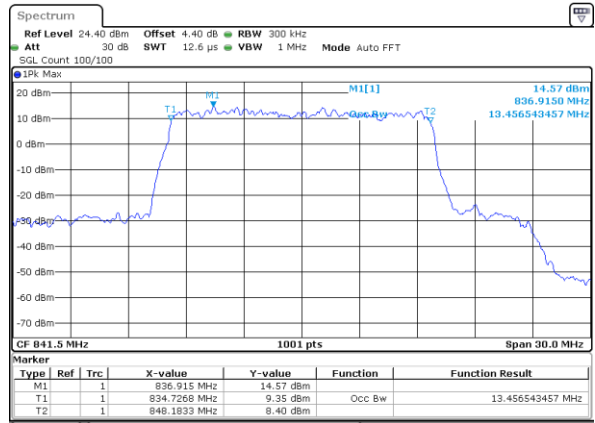

Date: 18 AUG 2018 12:45:35



LTE Band 26

Lowest Channel / 1.4MHz / 64QAM

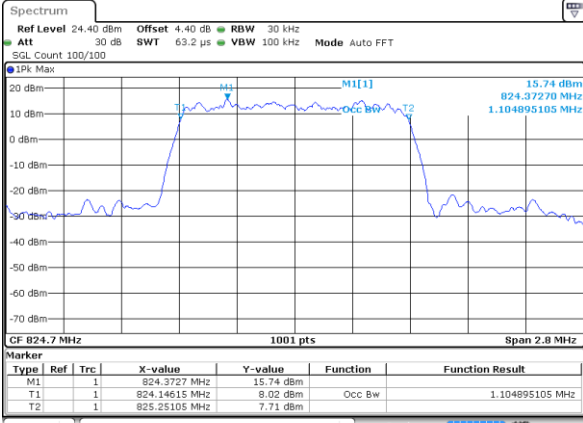

Date: 18 AUG 2018 10:29:16

Lowest Channel / 3MHz / 64QAM

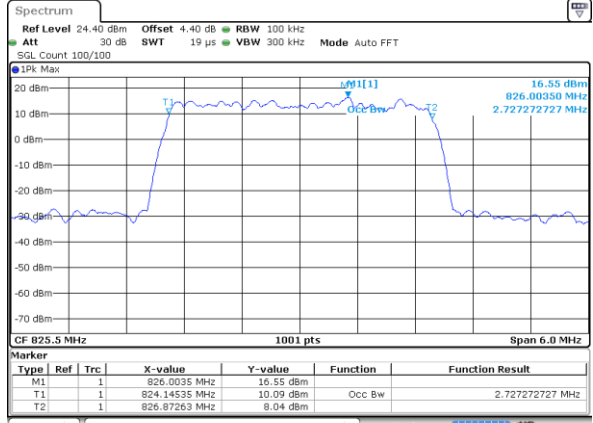

Date: 18 AUG 2018 11:11:25

Middle Channel / 1.4MHz / 64QAM

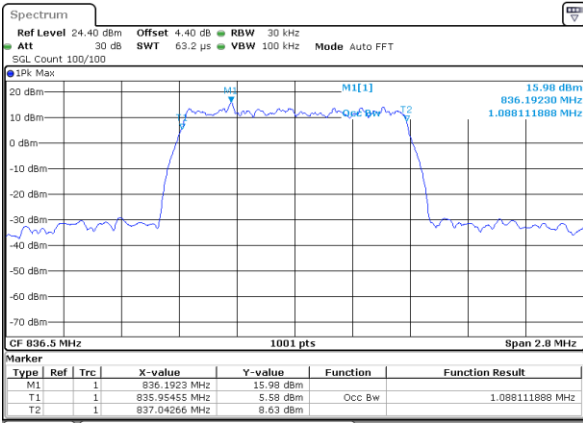

Date: 18 AUG 2018 10:30:14

Middle Channel / 3MHz / 64QAM

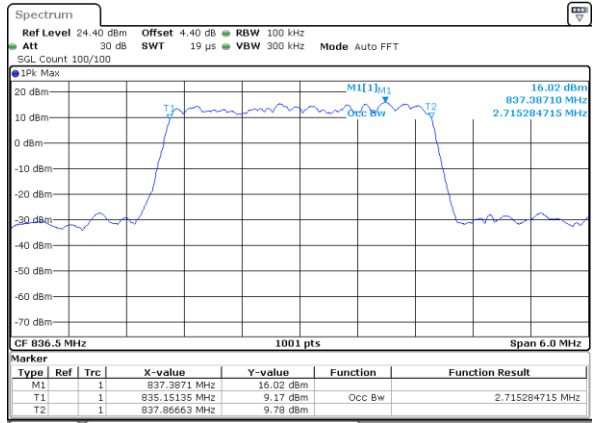

Date: 18 AUG 2018 11:12:36

Highest Channel / 1.4MHz / 64QAM

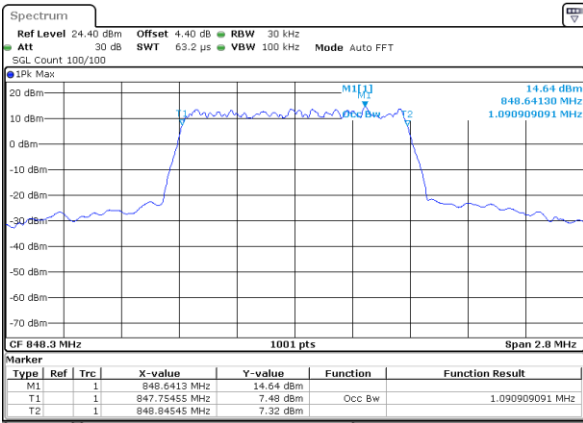

Date: 18 AUG 2018 10:31:42

Highest Channel / 3MHz / 64QAM

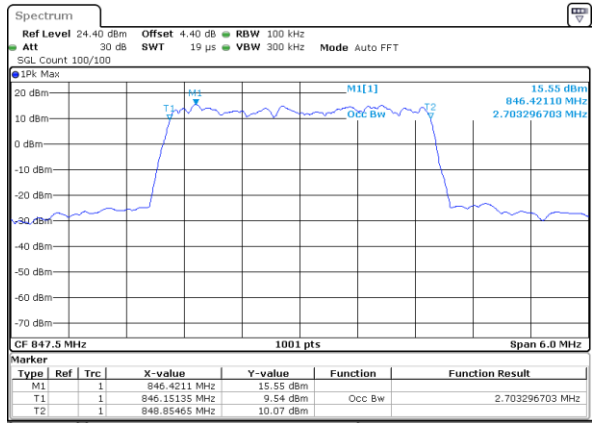

Date: 18 AUG 2018 11:13:40



LTE Band 26

Lowest Channel / 5MHz / 64QAM

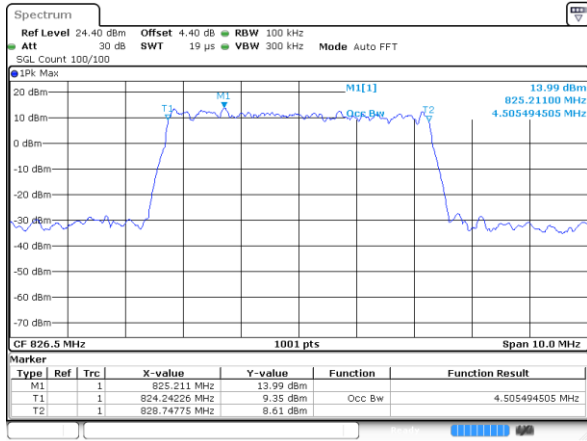

Date: 18 AUG 2018 11:33:34

Lowest Channel / 10MHz / 64QAM

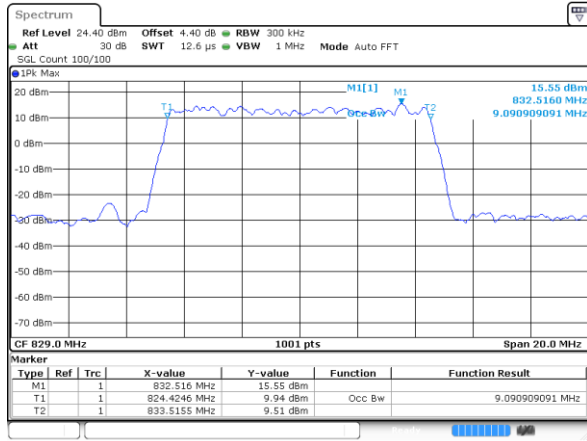

Date: 18 AUG 2018 11:54:05

Middle Channel / 5MHz / 64QAM

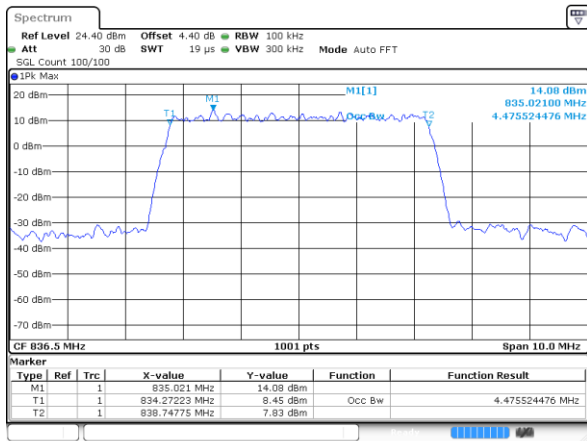

Date: 18 AUG 2018 11:34:32

Middle Channel / 10MHz / 64QAM

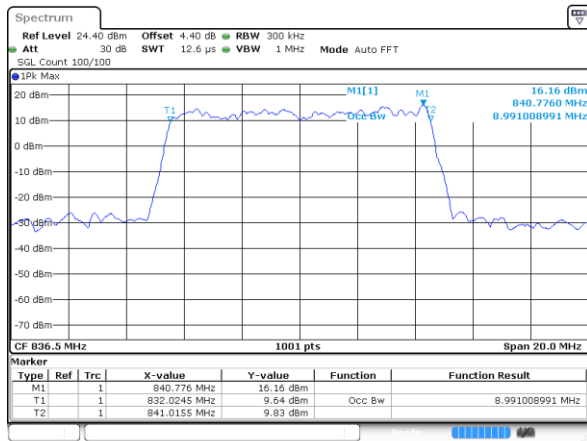

Date: 18 AUG 2018 11:55:04

Highest Channel / 5MHz / 64QAM

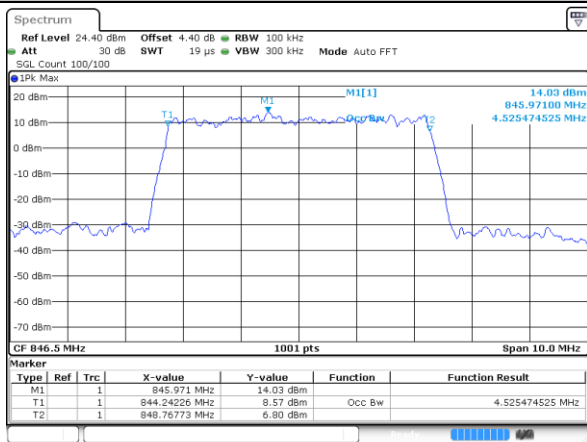

Date: 18 AUG 2018 11:35:31

Highest Channel / 10MHz / 64QAM

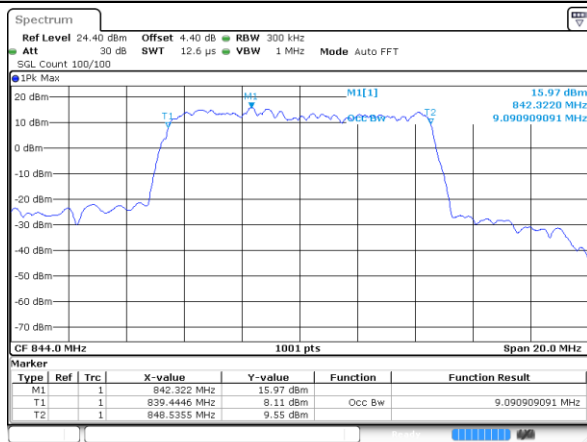

Date: 18 AUG 2018 11:56:16



LTE Band 26

Lowest Channel / 15MHz / 64QAM

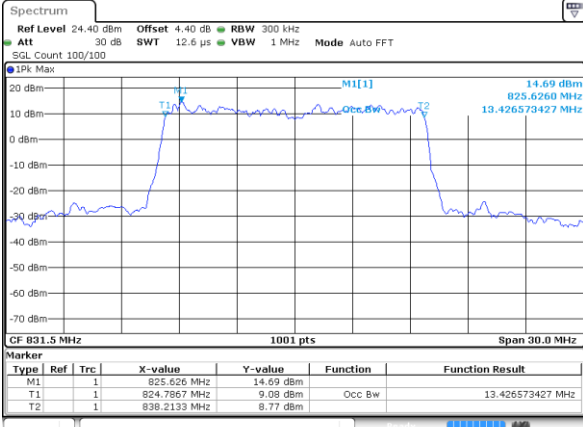

Date: 18 AUG 2018 12:43:21

Middle Channel / 15MHz / 64QAM

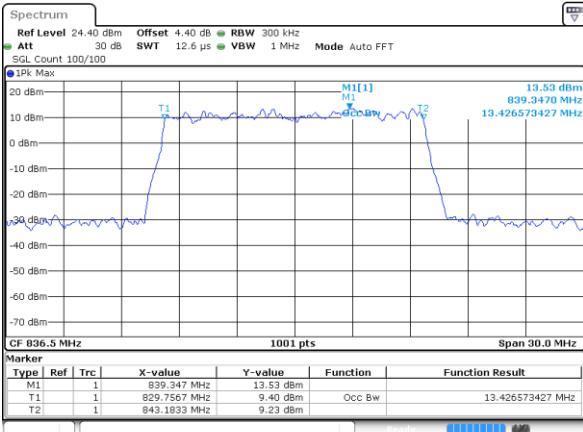

Date: 18 AUG 2018 12:44:42

Highest Channel / 15MHz / 64QAM

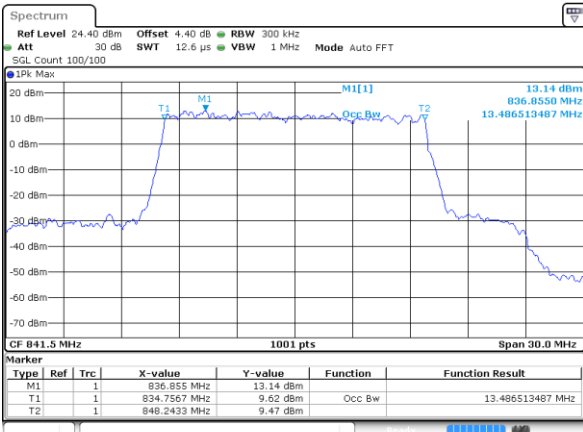

Date: 18 AUG 2018 12:45:56



Conducted Band Edge



LTE Band 26 / 1.4MHz / QPSK

Lowest Band Edge / 1RB



Date: 18 AUG 2018 10:53:49

Highest Band Edge / 1RB



Date: 18 AUG 2018 11:02:47

Lowest Band Edge / Full RB

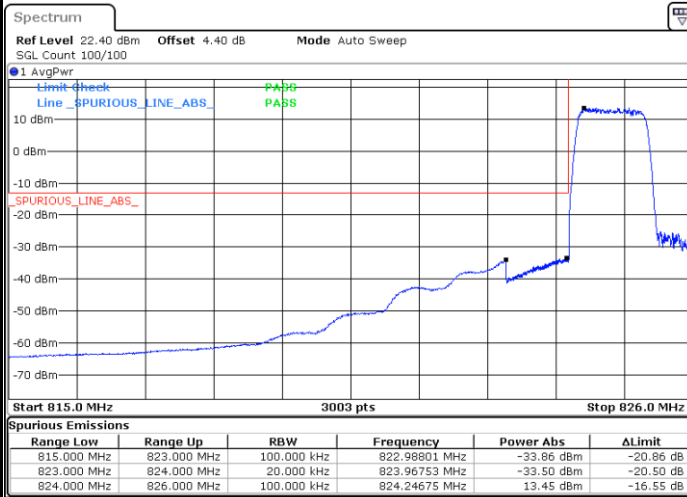

Date: 18 AUG 2018 10:58:09

Highest Band Edge / Full RB

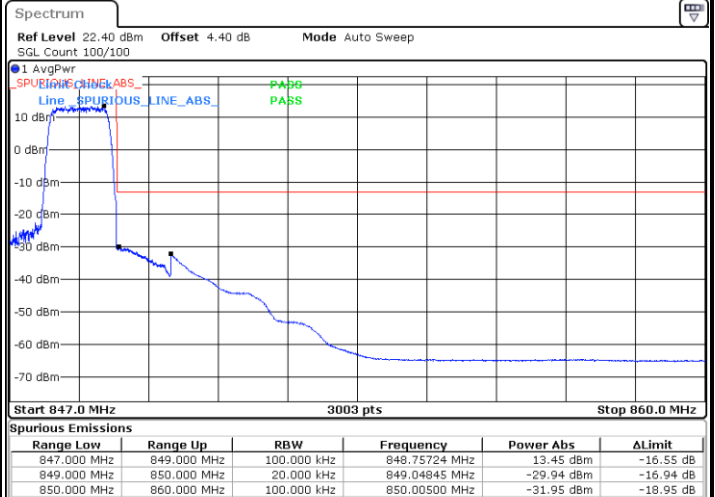

Date: 18 AUG 2018 11:07:17



LTE Band 26 / 1.4MHz / 16QAM

Lowest Band Edge / 1 RB

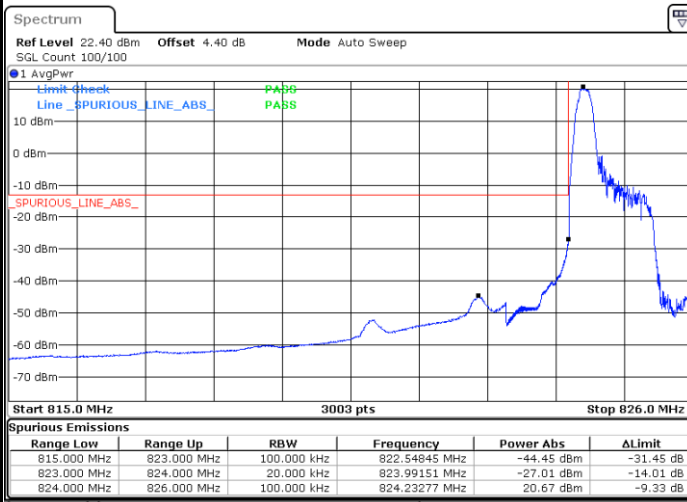

Date: 18 AUG 2018 10:55:19

Highest Band Edge / 1 RB

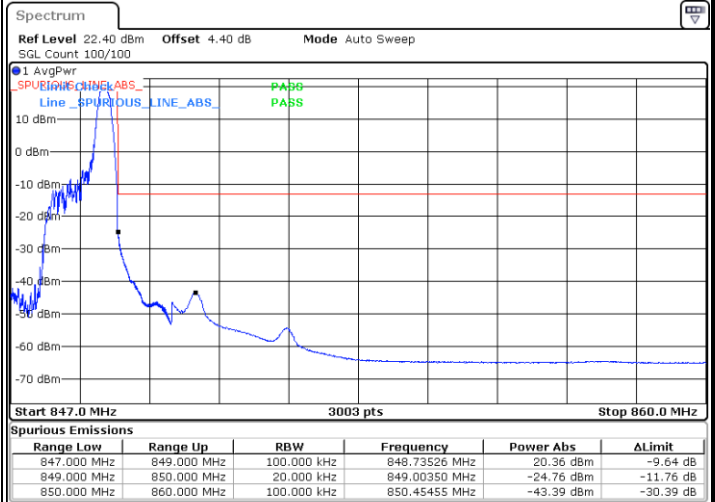

Date: 18 AUG 2018 11:04:18

Lowest Band Edge / Full RB

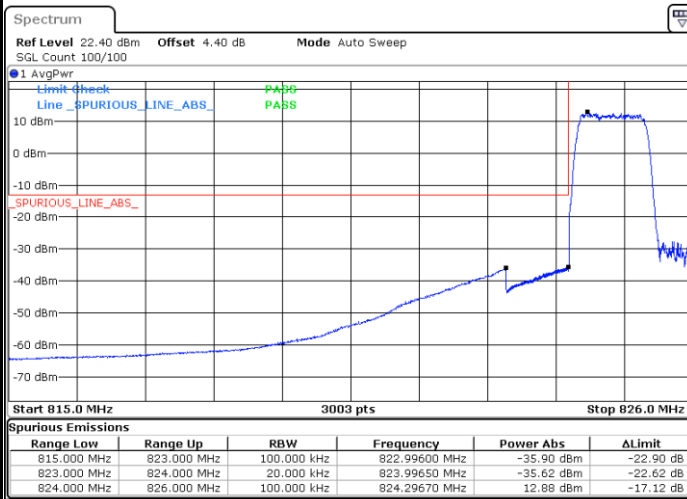

Date: 18 AUG 2018 10:59:33

Highest Band Edge / Full RB

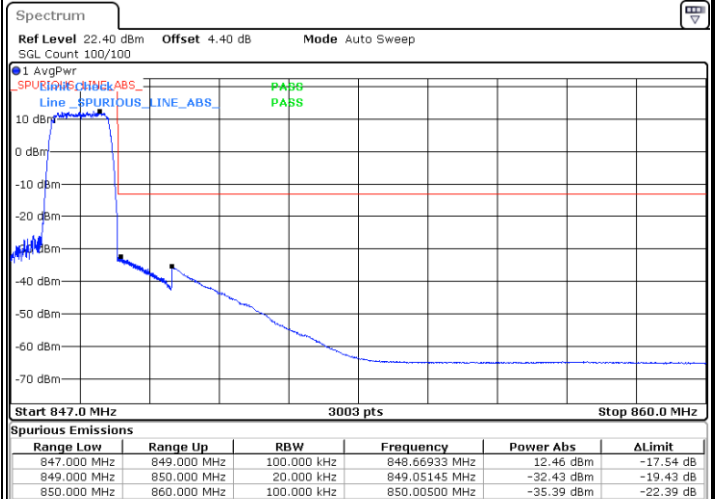

Date: 18 AUG 2018 11:08:48



LTE Band 26 / 3MHz / QPSK

Lowest Band Edge / 1RB

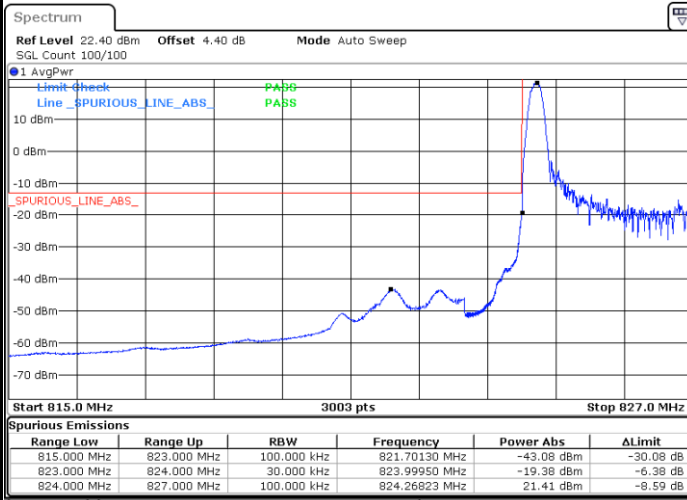

Date: 18 AUG 2018 11:20:33

Highest Band Edge / 1 RB



Date: 18 AUG 2018 11:26:59

Lowest Band Edge / Full RB

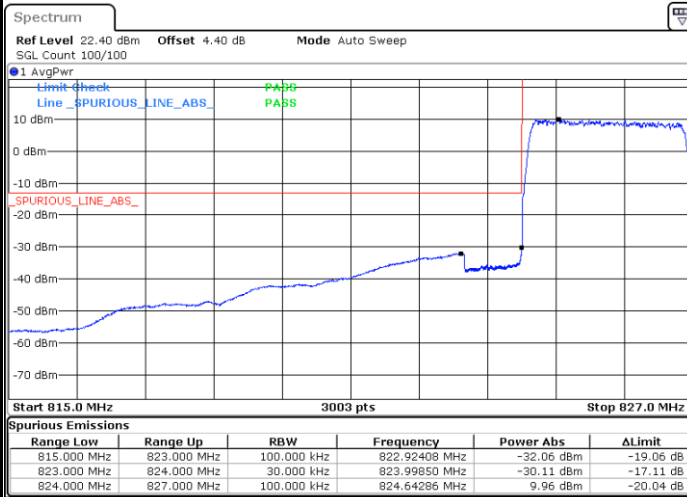

Date: 18 AUG 2018 11:23:45

Highest Band Edge / Full RB

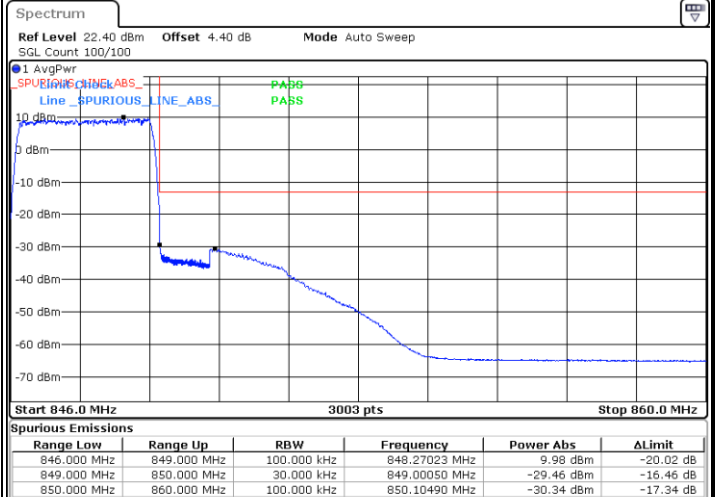

Date: 18 AUG 2018 11:30:02



LTE Band 26 / 3MHz / 16QAM

Lowest Band Edge / 1 RB

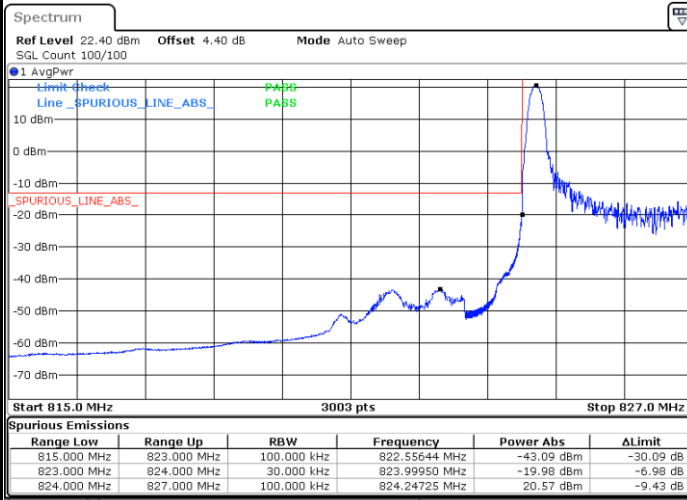

Date: 18 AUG 2018 11:21:30

Highest Band Edge / 1 RB



Date: 18 AUG 2018 11:27:59

Lowest Band Edge / Full RB

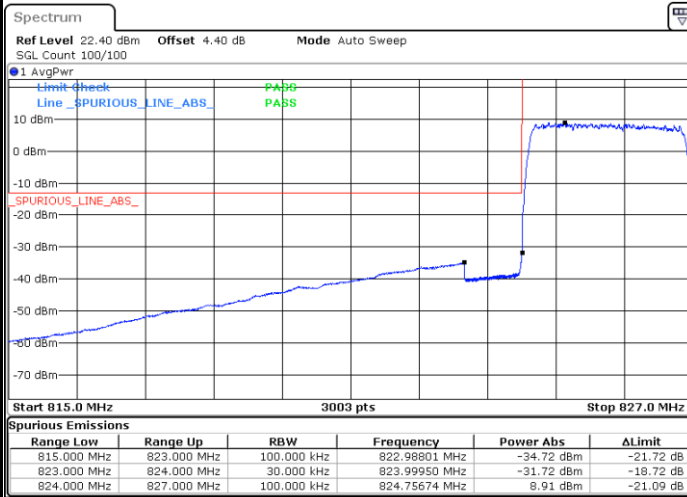

Date: 18 AUG 2018 11:24:43

Highest Band Edge / Full RB



Date: 18 AUG 2018 11:31:12