



中国认可  
国际互认  
检测  
TESTING  
CNAS L0310



# FCC RF Test Report

**Product Name: Smart Phone**

**Model Number: LON-L29**

**Report No: SYBH(Z-RF)031082016-2002**

**FCC ID: QISLON-L29**

**Reliability Laboratory of Huawei Technologies Co.**

**(Global Compliance and Testing Center of Huawei Technologies Co., Ltd)**

Administration Building, Headquarters of Huawei Technologies Co., Ltd., Bantian, Longgang District,  
Shenzhen, 518129, P.R.C

Tel: +86 755 28780808

Fax: +86 755 89652518



## Notice

1. The laboratory has Passed the accreditation by China National Accreditation Service for Conformity Assessment (CNAS). The accreditation number is L0310.
2. The laboratory has Passed the accreditation by The American Association for Laboratory Accreditation (A2LA). The accreditation number is 2174.01.
3. The laboratory has been listed by the US Federal Communications Commission to perform electromagnetic emission measurements. The site recognition number is 97456.
4. The laboratory has been listed by Industry Canada to perform electromagnetic emission measurements. The recognition numbers of test site are 6369A-1.
5. The test report is invalid if not marked with the signatures of the persons responsible for preparing and approving the test report.
6. The test report is invalid if there is any evidence of erasure and/or falsification.
7. The test report is only valid for the test samples.
8. Content of the test report, in part or in full, cannot be used for publicity and/or promotional purposes without prior written approval from the laboratory.
9. The laboratory (Reliability Lab of Huawei Technologies Co., Ltd) is also named as “Global Compliance and Testing Center of Huawei Technologies Co., Ltd”, the both names have coexisted since 2009.



**Applicant:** Huawei Technologies Co., Ltd.  
**Address:** Administration Building, Headquarters of Huawei Technologies Co., Ltd.,  
 Bantian, Longgang District, Shenzhen, 518129, P.R.C

**Date of Receipt Sample:** 2016-09-06  
**Start Date of Test:** 2016-09-10  
**End Date of Test:** 2016-09-30

**Test Result:** Pass

<b>Approved by Senior Engineer:</b>	2016-10-08	Roger Zhang	<i>Roger Zhang</i>
	Date	Name	Signature

<b>Prepared by:</b>	2016-10-08	Wu Tingsi	<i>Wu Tingsi</i>
	Date	Name	Signature



**CONTENT**

1 General Information.....5  
1.1 Applied Standard.....5  
1.2 Test Location .....5  
1.3 Test Environment Condition.....5  
2 Test Summary .....6  
3 Description of the Equipment under Test (EUT).....7  
3.1 General Description .....7  
3.2 EUT Identity .....7  
3.3 Technical Description.....9  
4 General Test Conditions / Configurations ..... 10  
4.1 Test Modes ..... 10  
4.2 EUT Configurations.....10  
4.3 Test Environments ..... 11  
4.4 Antenna requirements..... 11  
4.5 Description of tests..... 12  
4.6 Test Setups..... 14  
4.7 Test Conditions ..... 17  
5 Main Test Instruments ..... 19  
6 Appendixes.....20



## 1 General Information

### 1.1 **Applied Standard**

Applied Rules: 47 CFR FCC Part 2, Subpart J 2014  
47 CFR FCC Part 15, Subpart C 2014

Test Method: FCC KDB 558074 D01 DTS Meas Guidance v03r04  
ANSI C63.10-2013, American National Standard for Testing Unlicensed  
Wireless Devices.

### 1.2 **Test Location**

Test Location: Reliability Laboratory of Huawei Technologies Co., Ltd.  
Address: Administration Building, Headquarters of Huawei Technologies Co., Ltd.,  
Bantian, Longgang District, Shenzhen, 518129, P.R.C

### 1.3 **Test Environment Condition**

Ambient Temperature: 19.5to 25 °C  
Ambient Relative Humidity: 40 to 55 %  
Atmospheric Pressure: Not applicable



## 2 Test Summary

Test Item	FCC Part No.	Requirements	Test Result	Verdict
DTS (6 dB) Bandwidth	15.247(a)(2)	≥ 500 kHz.	Appendix A	Pass
Occupied Bandwidth	---	---	Appendix B	Pass
Duty Cycle	KDB 558074 (6.0)	No limit	Appendix C	Pass
Maximum Conducted Average Output Power	15.247(b)(3)	For directional gain: < 30 dBm – (G[dBi] – 6 [dB]), Average; Otherwise: < 30 dBm, Average.	Appendix D	Pass
Maximum Power Spectral Density Level	15.247(e)	For directional gain: < 8 dBm/3 kHz – (G[dBi] – 6 [dB]), Average. Otherwise: < 8 dBm/3 kHz, Average.	Appendix E	Pass
Band Edges Compliance	15.247(d)	< -30 dBm/100 kHz if total average power ≤ power limit.	Appendix F	Pass
Unwanted Emissions into Non-Restricted Frequency Bands			Appendix G	Pass
Unwanted Emissions into Restricted Frequency Bands (Radiated)	15.247(d) 15.209 (NOTE 1)	FCC Part 15.209 field strength limit;	Appendix H	Pass
AC Power Line Conducted Emissions	15.207	FCC Part 15.207 conducted limit;	Appendix I	Pass

NOTE 1: According to KDB 558074, antenna-port conducted measurements are acceptable as an alternative to radiated measurements for demonstrating compliance to the limits in the restricted frequency bands. If conducted measurements are performed, then proper impedance matching must be ensured and an additional radiated test for cabinet/case emissions will also be required.

NOTE 2: The Appendixes please see No.: SYBH(Z-RF)031082016-2002-A of Appendix for 2.4G WLAN



### 3 Description of the Equipment under Test (EUT)

#### 3.1 General Description

LON-L29 is subscriber equipment in the LTE/ WCDMA/GSM system. The LTE frequency band is Band I,Band II,Band III,Band IV,Band V, Band VII,Band VIII, Band VIII, Band XII,BandXVII, Band XVIII ,Band XIX, Band XX, Band XXVI, Band XXVIII, Band XXIX,Band XXXVIII,BandXXXIX, Band XL and Band XLI. The HSUPA/HSDPA/UMTS frequency band is Band I, Band II, Band IV, Band V, Band VI, Band VIII and Band XIX, The GSM/GPRS/EDGE frequency band includes GSM850 and GSM900 and DCS1800 and PCS1900, The Mobile Phone implements such functions as RF signal receiving/transmitting, LTE/ WCDMA /GSM protocol processing, voice, video, MMS service, GPS, AGPS,NFC and WIFI etc. Externally it provides earphone port (to provide voice service) and dual USIM card interfaces. It also provides Bluetooth module to synchronize data between a PC and the phone, or to use the built-in modem of the phone to access the Internet with a PC, or to exchange data with other Bluetooth devices.

NOTE: Only 2.4G WIFI test data included in this report.











#### 3.2 EUT Identity

NOTE: Unless otherwise noted in the report, the functional boards installed in the units shall be selected from the below list, but not means all the functional boards listed below shall be installed in one unit.

##### 3.2.1 Board

Board		
Description	Hardware Version	Software Version
Main Board	HL1ALONM	M400-L29C432B106

### 3.2.2 Sub-Assembly

Sub-Assembly			
Sub-Assembly Name	Model	Manufacturer	Description
Adapter	HW-050450B00	Huawei Technologies Co., Ltd.	Input Voltage: ~100-240V 5V 0.75A Output Voltage: 5V  2A/4.5A 4.5V  5A Rated Power: 10W/22.5W
Adapter	HW-050450E00	Huawei Technologies Co., Ltd.	Input Voltage: ~100-240V 5V 0.75A Output Voltage: 5V  2A/4.5A 4.5V  5A Rated Power: 10W/22.5W
Adapter	HW-050450U00	Huawei Technologies Co., Ltd.	Input Voltage: ~100-240V 5V 0.75A Output Voltage: 5V  2A/4.5A 4.5V  5A Rated Power: 10W/22.5W
Adapter	HW-050450A00	Huawei Technologies Co., Ltd.	Input Voltage: ~100-240V 5V 0.75A Output Voltage: 5V  2A/4.5A 4.5V  5A Rated Power: 10W/22.5W
Rechargeable Li-ion	HB396689ECW	Huawei Technologies Co., Ltd.	Rated capacity: 3900mAh Nominal Voltage:  +3.82V Charging Voltage:  +4.4V



### 3.3 Technical Description

Characteristics	Description		
IEEE 802.11 WLAN Mode Supported	<input checked="" type="checkbox"/> 802.11b (20 MHz channel bandwidth), <input checked="" type="checkbox"/> 802.11g (20 MHz channel bandwidth) <input checked="" type="checkbox"/> 802.11n (20 MHz channel bandwidth), <input checked="" type="checkbox"/> 802.11n (40 MHz channel bandwidth)		
TX/RX Operating Range	2412-2462 MHz band	$f_c = 2407 \text{ MHz} + N * 5 \text{ MHz}$ , where: <ul style="list-style-type: none"> <li>- <math>f_c</math> = "Operating Frequency" in MHz,</li> <li>- <math>N</math> = "Channel Number" with the range from 1 to 11 for the 20 MHz channel bandwidth,</li> </ul>	
Data Rate	802.11b	1 Mbps, 2 Mbps, 5.5 Mbps, 11 Mbps	
	802.11g	6 Mbps, 9 Mbps, 12 Mbps, 18 Mbps, 24 Mbps, 36 Mbps, 48 Mbps, 54 Mbps	
	802.11n (SISO)	MCS 0 to MCS 7	
Modulation Type	DBPSK/DQPSK/CCK (DSSS), BPSK/QPSK/16QAM/64QAM (OFDM).		
Emission Designator	8M07G7D (for 802.11b mode), 16M1G7D (for 802.11g mod), 17M2G7D (for 802.11n20 mode), 35M8G7D (for 802.11n40 mode)		
TX Power Control	<input type="checkbox"/> Supported, <input checked="" type="checkbox"/> Not Supported		
Standby Mode	<input type="checkbox"/> Supported, <input checked="" type="checkbox"/> Not Supported		
Equipment Type	<input type="checkbox"/> Stand-alone equipment, <input type="checkbox"/> Plug-in radio device, <input checked="" type="checkbox"/> Combined equipment		
Antenna	Description	Isotropic Antenna	
	Type	<input type="checkbox"/> External, <input checked="" type="checkbox"/> Integrated	
	Ports	<input checked="" type="checkbox"/> Ant 1, <input type="checkbox"/> Ant 2, <input type="checkbox"/> Ant 3	
	Smart System	<input checked="" type="checkbox"/> SISO (for 802.11b/g/n), <input type="checkbox"/> MIMO (for 802.11n): 2 Tx & 2 Rx, <input type="checkbox"/> Diversity (for 802.11b/g) :       Tx        Rx	
	Gain	0.3 dBi (per antenna port, max.)	
	Remark	When the EUT is put into service, the practical maximum antenna gain should NOT exceed the value as described above.	
Power Supply	Type	<input checked="" type="checkbox"/> AC/DC Adapter	<input type="checkbox"/> PoE: <input type="checkbox"/> Other:



## 4 General Test Conditions / Configurations

### 4.1 Test Modes

NOTE: Worst cases for each IEEE 802.11 mode are selected to perform tests.

Test Mode	Test Modes Description
11B	IEEE 802.11b with data rate of 1 Mbps using SISO mode.
11G	IEEE 802.11g with data rate of 6 Mbps using SISO mode.
11N20	IEEE 802.11n with data rate of MCS0 and bandwidth of 20 MHz using SISO mode.
11N40	IEEE 802.11n with data rate of MCS0 and bandwidth of 40 MHz using SISO mode.

### 4.2 EUT Configurations

#### 4.2.1 General Configurations

Configuration	Description
Test Antenna Ports	Until otherwise specified, <ul style="list-style-type: none"> <li>- All TX tests are performed at all TX antenna ports of the EUT, and</li> <li>- All RX tests are performed at all RX antenna ports of the EUT.</li> </ul>
Multiple RF Sources	Other than the tested RF source of the EUT, other RF source(s) are disabled or shutdown during measurements.

#### 4.2.2 Customized Configurations

Test Mode	RF Ch.	TX Freq. [MHz]	Ch. BW [MHz]	Power Conf., per Port	Duty cycle [%]
11B	L	Ch No. 1 / 2412 MHz	20	15	99
11B	M	Ch No. 6 / 2437 MHz	20	15	99
11B	H	Ch No. 11 / 2462 MHz	20	15	99
11G	L	Ch No. 1 / 2412 MHz	20	14.5	93
11G	M	Ch No. 6 / 2437 MHz	20	14.5	93
11G	H	Ch No. 11 / 2462 MHz	20	14.5	93
11N20	L	Ch No. 1 / 2412 MHz	20	13.5	93
11N20	M	Ch No. 6 / 2437 MHz	20	13.5	93
11N20	H	Ch No. 11 / 2462 MHz	20	13.5	93
11N40	L	Ch No. 3 / 2422 MHz	40	11	87
11N40	M	Ch No. 6 / 2437 MHz	40	11	87
11N40	H	Ch No. 9 / 2452 MHz	40	11	87



### 4.3 Test Environments

NOTE: The values used in the test report may be stringent than the declared.

Environment Parameter	Selected Values During Tests		
	Temperature	Voltage	Relative Humidity
NTNV	Ambient	3.8VDC	Ambient

### 4.4 Antenna requirements

**Excerpt from §15.203 of the FCC Rules/Regulations:**

“An intentional radiator antenna shall be designed to ensure that no antenna other than that furnished by the responsible party can be used with the device. The use of a permanently attached antenna or of an antenna that uses a unique coupling to the intentional radiator shall be considered sufficient to comply with the provisions of this section.”

The antennas of the **LON-L29** are **permanently attached**.

There are no provisions for connection to an external antenna.

**Conclusion:**

The **EUT FCC ID: QISLON-L29** unit complies with the requirement of §15.203.

**Ch. Frequency (MHz)**

Ch.	Frequency (MHz)
<b>01</b>	<b>2412</b>
.	.
.	.
<b>06</b>	<b>2437</b>
.	.
.	.
<b>11</b>	<b>2462</b>

**Frequency/ Channel Operations**

## 4.5 Description of tests

### 4.5.1 Bandwidth measurement

- (a) Connect EUT test port to spectrum analyzer.
- (b) Set the EUT to transmit maximum output power at 2.4GHz, then set the measured frequency number and test the bandwidth with spectrum analyzer.

### 4.5.2 Duty Cycle measurement

- (a) Connect EUT test port to spectrum analyzer.
- (b) Set the EUT to transmit maximum output power at 2.4GHz, then set the measured frequency number and test the Duty Cycle with spectrum analyzer.

### 4.5.3 Maximum Conducted Average Output Power

- (a) Connect EUT test port to spectrum analyzer.
- (b) Set the EUT to transmit maximum output power at 2.4GHz.
- (c) Then set the EUT to transmit at high, middle and low frequency and measure the conducted output power separately.

### 4.5.4 Band edge spurious emission

- (a) Connect EUT test port to spectrum analyzer
- (b) Set the EUT to transmit maximum output power at 2.4GHz.
- (c) Then set the EUT to transmit at high, low frequency and measure the conducted band edge spurious separately.

### 4.5.5 Conducted RF spurious

- (a) Connect EUT test port to spectrum analyzer
- (b) Set the EUT to transmit maximum output power at 2.4GHz.
- (c) Then set the EUT to transmit at high, middle and low frequency and measure the conducted spurious separately.

### 4.5.6 Power spectral density

- (a) Connect EUT test port to spectrum analyzer
- (b) Set the EUT to transmit maximum output power at 2.4GHz.
- (c) Then set the EUT to transmit at high, middle and low frequency and measure the conducted power spectral density.

### 4.5.7 Radiated spurious emission & spurious in restricted band

The test site semi-anechoic chamber has met the requirement of NSA tolerance 4dB according to the standards: ANSI C63.10 (2013). The EUT was set-up on insulator 80cm above the Ground Plane. The set-up and test methods were according to ANSI C63.10:2013. The Radiated Disturbance measurements were made using a Rohde and Schwarz Test Receiver and control software.

A preliminary scan and a final scan of the emissions were made by using test script of software; the emissions were measured using a Quasi-Peak Detector below 1GHz, Peak Detector and AV Detector

above 1GHz. The maximal emission value was acquired by adjusting the antenna height, polarisation and turntable azimuth in accordance with the software setup. Normally, the height range of antenna was 1m to 4m, and the azimuth range of turntable was 0° to 360°. The receive antenna has two polarizations V and H.

A portable or small unlicensed wireless device shall be placed on a non-metallic test fixture or other nonmetallic support during testing. The supporting fixture shall permit orientation of the EUT in each of three orthogonal (x, y, z) axis positions such that emissions from the EUT are maximized.

The EUT communicates with the BTS simulator through Air interface. The EUT operated on the typical channel.

Measurement bandwidth: 30 MHz – 1000 MHz: 120 kHz

Measurement bandwidth: 1000 MHz – 10<sup>th</sup> Carrier Frequency: 1 MHz

#### **4.5.8 Conducted Emission at Power Port**

The Table-top EUT was placed upon a non-metallic table 0.8 m above the horizontal metal reference ground plane. EUT was connected to LISN and LISN was connected to reference Ground Plane. EUT was 80cm from LISN. The set-up and test methods were according to ANSI C63.10: 2013.

Conducted Disturbance at AC Port measurements were undertaken on the L and N Lines. The emissions were measured using a Quasi-Peak Detector and Average Detector.

The EUT communicates with the BTS simulator through Air interface, the BTS simulator controls the Wireless Modem to transmit the maximum power which defined in specification of product. The Wireless Modem operated on the typical channel.

Measurement bandwidth (RBW) for 150kHz to 30 MHz: 9 kHz;

## 4.6 Test Setups

### 4.6.1 Test Setup 1

The WLAN component's antenna port(s) of the EUT are connected to the measurement instrument per an appropriate attenuator. The EUT is controlled by PC/software to emit the specified signals for the purpose of measurements.

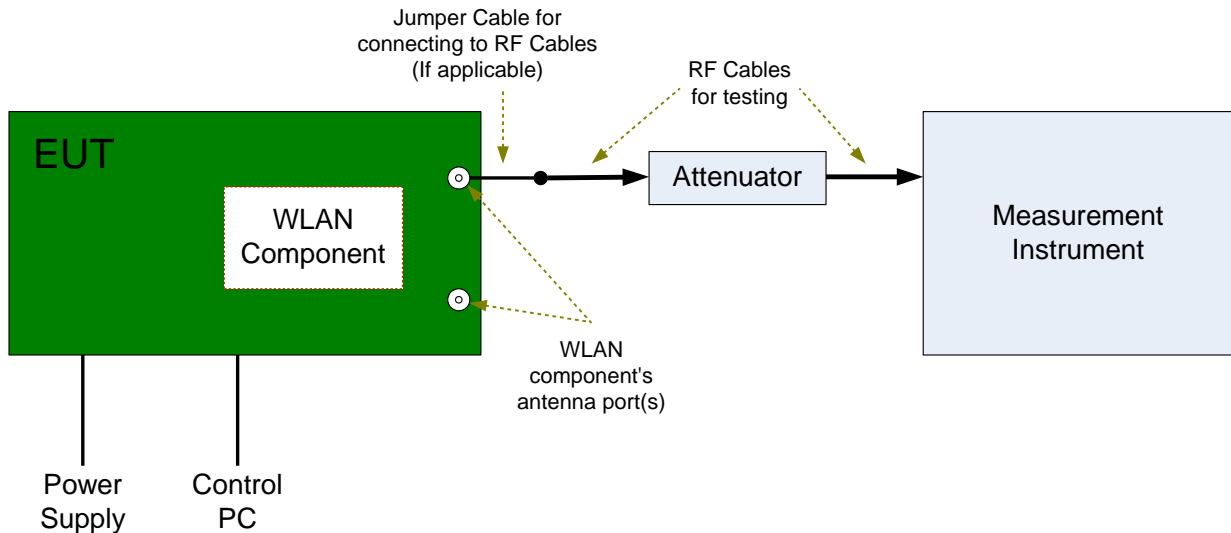

### 4.6.2 Test Setup 2

The test site semi-anechoic chamber has met the requirement of NSA tolerance 4 dB according to the standards: ANSI C63.4. The test distance is 3m. The setup is according to ANSI C63.4 and CAN/CSA-CEI/IEC CISPR 22.

The maximal emission value is acquired by adjusting the antenna height, polarisation and turntable azimuth. Normally, the height range of antenna is 1 m to 4 m, the azimuth range of turntable is 0° to 360°, and the receive antenna has two polarizations Vertical (V) and Horizontal (H).

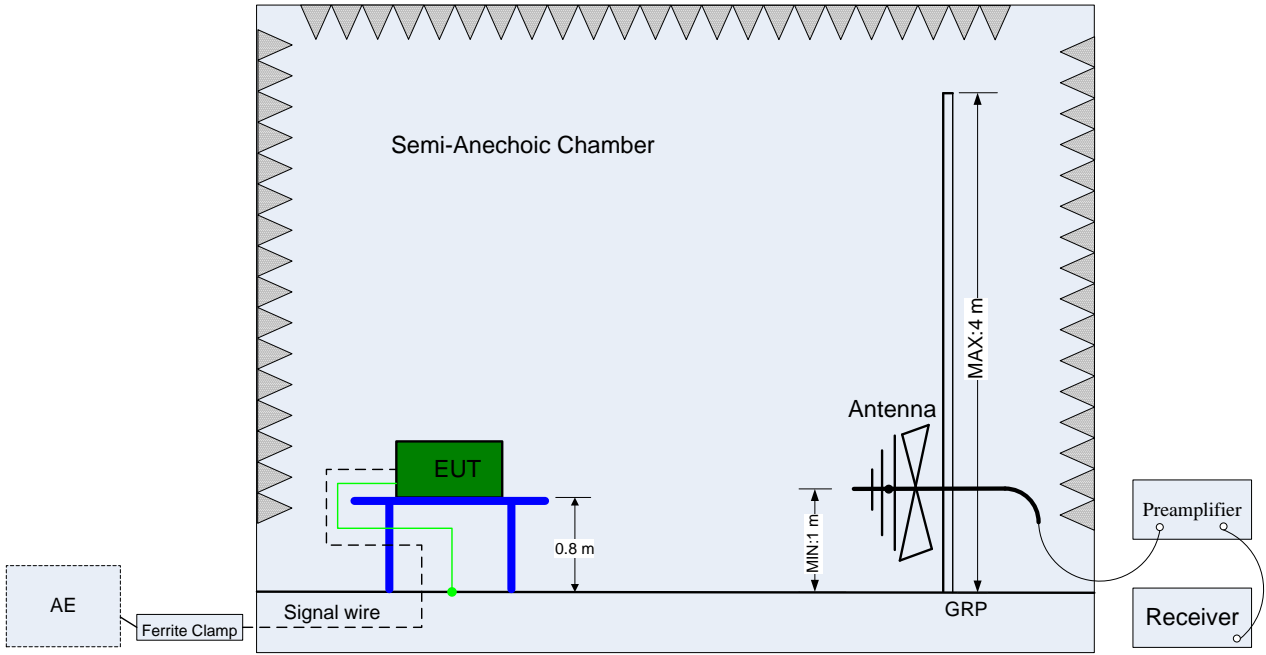

(Below 1 GHz)

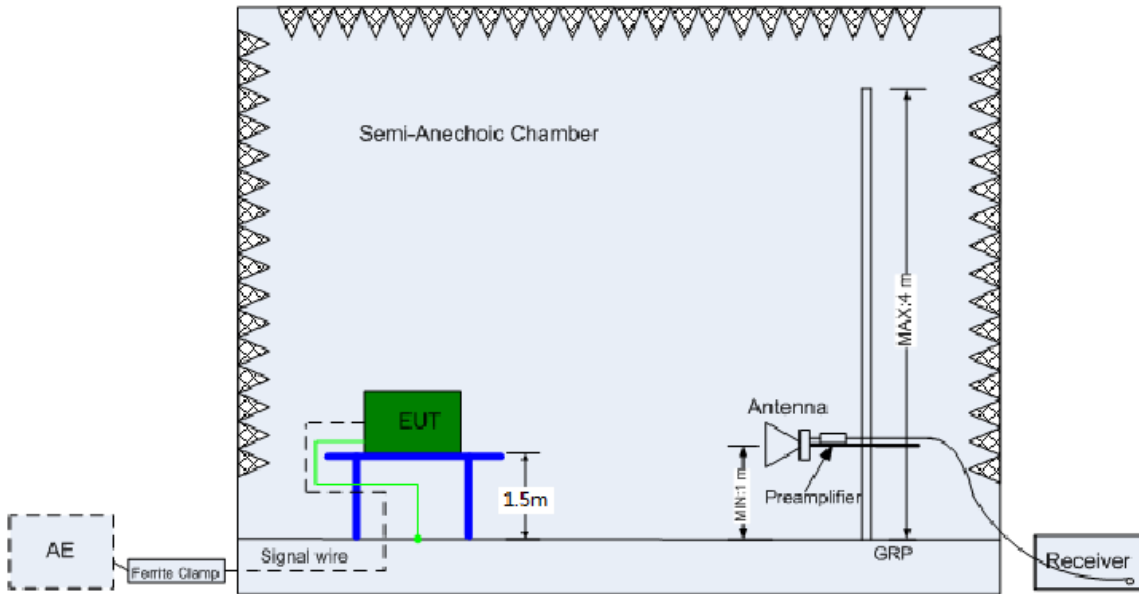

(Above 1 GHz)

### 4.6.3 Test Setup 3

The mains cable of the EUT (maybe per AC/DC Adapter) must be connected to LISN. The LISN shall be placed 0.8 m from the boundary of EUT and bonded to a ground reference plane for LISN mounted on top of the ground reference plane. This distance is between the closest points of the LISN and the EUT. All other units of the EUT and associated equipment shall be at least 0.8 m from the LISN.

Ground connections, where required for safety purposes, shall be connected to the reference ground point of the LISN and, where not otherwise provided or specified by the manufacturer, shall be of same length as the mains cable and run parallel to the mains connection at a separation distance of not more than 0.1 m.

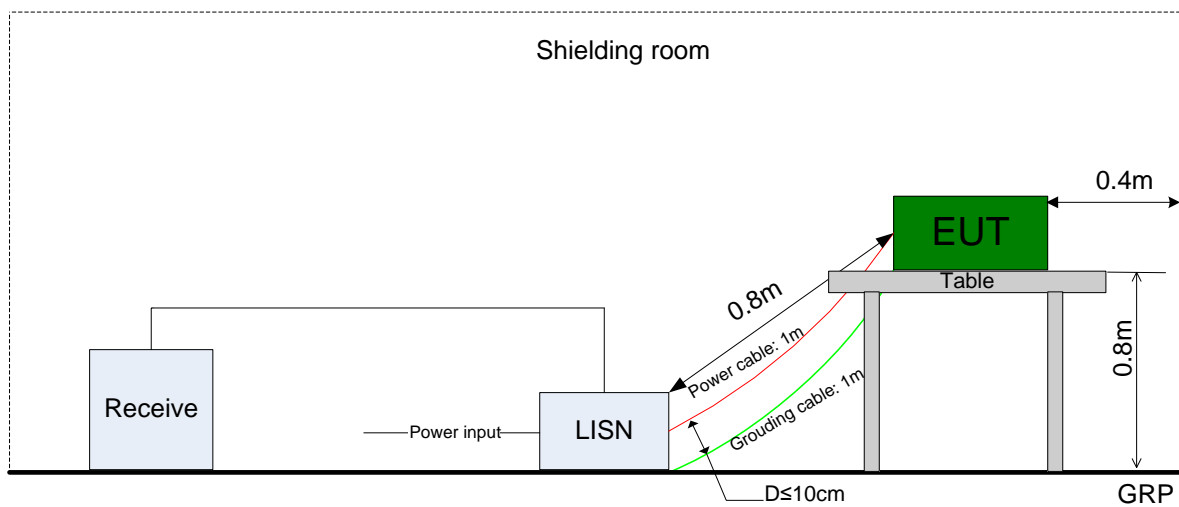

### 4.7 Test Conditions

Test Case	Test Conditions	
	Configuration	Description
DTS (6 dB) Bandwidth	Measurement Method	FCC KDB 558074 §8.1 Option 2.
	Test Environment	NTNV
	Test Setup	Test Setup 1
	EUT Configuration	11B_L, 11B_M, 11B_H 11G_L, 11G_M, 11G_H 11N20_L, 11 N20_M, 11 N20_H 11N40_L, 11 N40_M, 11 N40_H
Occupied Bandwidth	Measurement Method	FCC KDB 558074 §8.2 Option 2.
	Test Environment	NTNV
	Test Setup	Test Setup 1
	EUT Configuration	11B_L, 11B_M, 11B_H 11G_L, 11G_M, 11G_H 11N20_L, 11 N20_M, 11 N20_H 11N40_L, 11 N40_M, 11 N40_H
Maximum Conducted Average Output Power	Measurement Method	FCC KDB 558074 §9.2 .2. 4
	Test Environment	NTNV
	Test Setup	Test Setup 1
	EUT Configuration	11B_L, 11B_M, 11B_H 11G_L, 11G_M, 11G_H 11N20_L, 11 N20_M, 11 N20_H 11N40_L, 11 N40_M, 11 N40_H
Maximum Power Spectral Density Level	Measurement Method	FCC KDB 558074 §10.1 (peak PSD).
	Test Environment	NTNV
	Test Setup	Test Setup 1
	EUT Configuration	11B_L, 11B_M, 11B_H 11G_L, 11G_M, 11G_H 11N20_L, 11 N20_M, 11 N20_H 11N40_L, 11 N40_M, 11 N40_H
Band Edges Compliance	Measurement Method	FCC KDB 558074 §13.0.
	Test Environment	NTNV
	Test Setup	Test Setup 1
	EUT Configuration	11B_L, 11B_M, 11B_H 11G_L, 11G_M, 11G_H 11N20_L, 11 N20_M, 11 N20_H 11N40_L, 11 N40_M, 11 N40_H
Unwanted Emissions into Non-Restricted	Measurement Method	FCC KDB 558074 §11.0
	Test Environment	NTNV
	Test Setup	Test Setup 1



Test Case	Test Conditions	
	Configuration	Description
Frequency Bands	EUT Configuration	11B_L, 11B_M, 11B_H 11G_L, 11G_M, 11G_H 11N20_L, 11 N20_M, 11 N20_H 11N40_L, 11 N40_M, 11 N40_H
Unwanted Emissions into Restricted Frequency Bands (Radiated)	Measurement Method	ANSI C63.10; FCC KDB 558074 §12.1, Radiated
	Test Environment	NTNV
	Test Setup	Test Setup 2
	EUT Placement	<input checked="" type="checkbox"/> Flatwise, <input checked="" type="checkbox"/> Upright, <input checked="" type="checkbox"/> Hung
	EUT Configuration	11B_L, 11B_M, 11B_H 11G_L, 11G_M, 11G_H 11N20_L, 11 N20_M, 11 N20_H 11N40_L, 11 N40_M, 11 N40_H
AC Power Line Conducted Emissions	Measurement Method	Part 15.207
	Test Environment	NTNV
	Test Setup	Test Setup 3
	EUT Configuration	(Worst Conf.).

**5 Main Test Instruments**

Main Test Equipments					
Equipment Name	Manufacturer	Model	Serial Number	Cal Date	Cal- Due
Power supply	KEITHLEY	2303	1342889	2015/9/16	2017/9/15
Wireless Communication Test set	Agilent	N4010A	MY49081592	2015/10/30	2016/10/29
Spectrum Analyzer	Agilent	N9020A	MY52090652	2016/6/29	2017/6/29
Signal Analyzer	R&S	FSQ31	200021	2015/10/30	2016/10/29
Spectrum Analyzer	Agilent	N9030A	MY49431698	2015/10/30	2016/10/29
Temperature Chamber	WEISS	WKL64	56246002940010	2016/1/21	2017/1/20
Signal generator	Agilent	E8257D	MY49281095	2015/10/30	2016/10/29
Vector Signal Generator	R&S	SMU200A	104162	2015/10/30	2016/10/29
Test receiver	R&S	ESU26	100387	2016/6/21	2017/6/20
Test receiver	R&S	ESCI	101163	2015/11/11	2016/11/10
Spectrum analyzer	R&S	FSU3	200474	2016/5/24	2017/5/23
Spectrum analyzer	R&S	FSU43	100144	2015/6/2	2017/6/2
LOOP Antennas(9kHz-30MHz)	R&S	HFH2-Z2	100262	2015/4/30	2017/4/29
LOOP Antennas(9kHz-30MHz)	R&S	HFH2-Z2	100263	2015/4/30	2017/4/29
Trilog Broadband Antenna (30M~3GHz)	SCHWARZBECK	VULB 9163	9163-490	2015/4/30	2017/4/29
Trilog Broadband Antenna (30M~3GHz)	SCHWARZBECK	VULB 9163	9163-520	2015/4/30	2017/4/29
Double-Ridged Waveguide Horn Antenna (1G~18GHz)	R&S	HF907	100304	2015/4/30	2017/4/29
double ridged horn antenna (0.8G-18GHz)	R&S	HF907	100305	2015/4/30	2017/4/29
Pyramidal Horn Antenna(18GHz-26.5GHz)	ETS-Lindgren	Sep-60	5140299	2015/7/15	2017/7/14
Artificial Main Network	R&S	ENV4200	100134	2016/6/2	2017/6/1
Line Impedance Stabilization Network	R&S	ENV216	100382	2016/6/2	2017/6/1
Signal Generator	Agilent	E4438C	MY49071538	2016/3/1	2017/3/1
Software Information					
Test Item	Software Name		Manufacturer	Version	
RE	EMC32		R&S	V9.25.0	
CE	EMC32		R&S	V9.25.0	



## 6 Appendixes

Appendix No.	Description
SYBH(Z-RF)031082016-2002-A	Appendix for 2.4G WLAN

---

END