

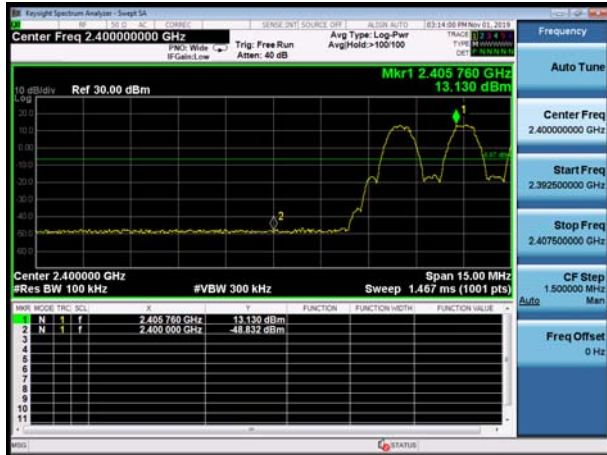

BT UHD BLE 1M GFSK, Carrier frequency (MHz): 2404

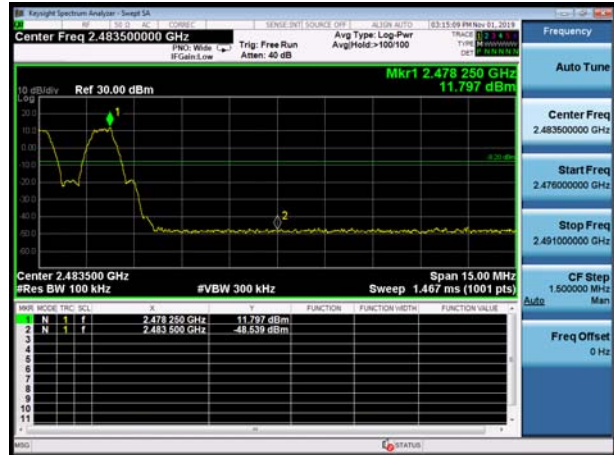

BT UHD BLE 1M GFSK, Carrier frequency (MHz): 2478



BT UHD BLE 2M GFSK, Carrier frequency (MHz): 2404



BT UHD BLE 2M GFSK, Carrier frequency (MHz): 2478

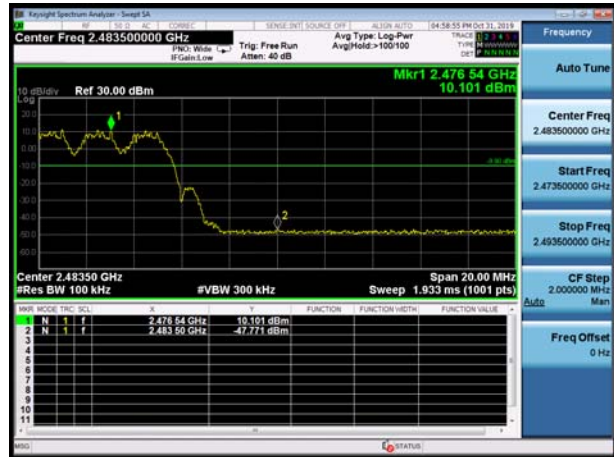

Hopping Off

BT UHD 2M $\pi/4$ -DQPSK, Carrier frequency (MHz): 2404

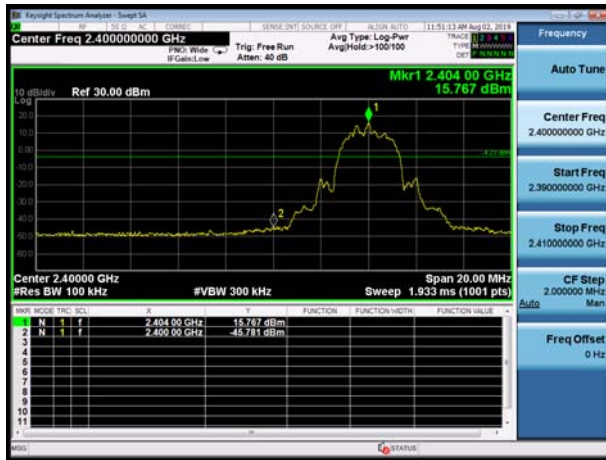

BT UHD 2M $\pi/4$ -DQPSK CH37, Carrier frequency (MHz): 2478

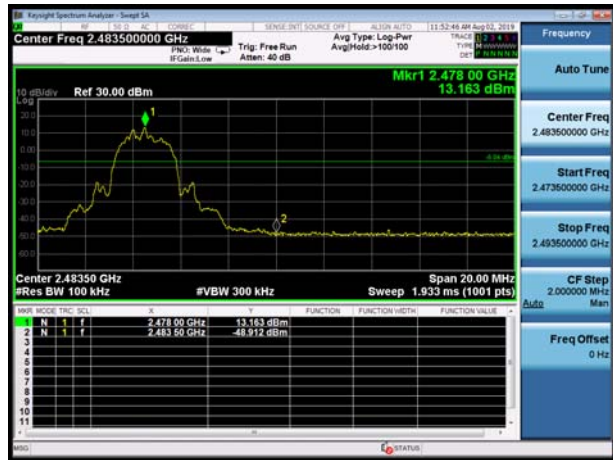

BT UHD 2M 8DPSK, Carrier frequency (MHz): 2404

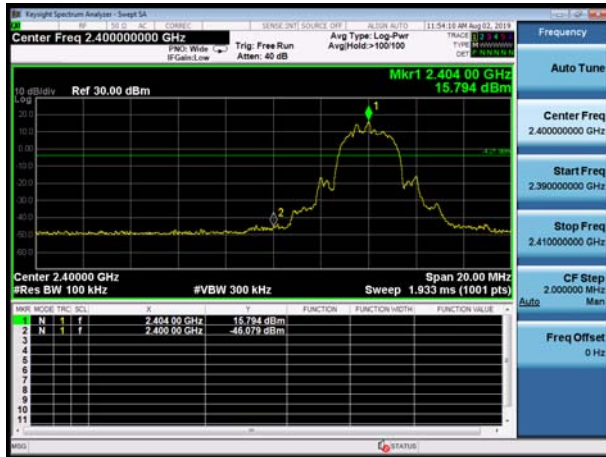

BT UHD 2M 8DPSK CH37, Carrier frequency (MHz): 2478

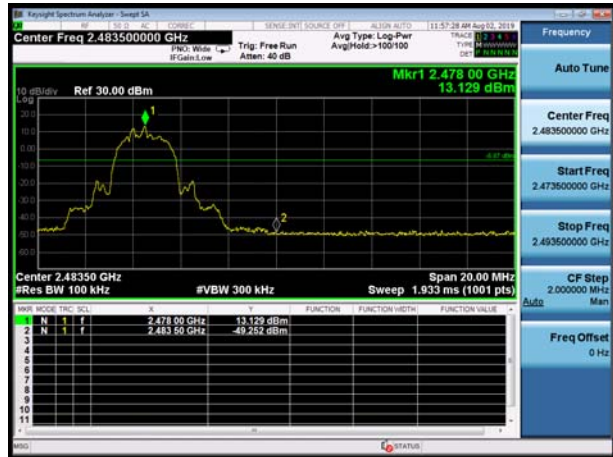

BT UHD 4M $\pi/4$ -DQPSK, Carrier frequency (MHz): 2404



BT UHD 4M $\pi/4$ -DQPSK, Carrier frequency (MHz): 2476





BT UHD BLE 1M GFSK, Carrier frequency (MHz): 2404

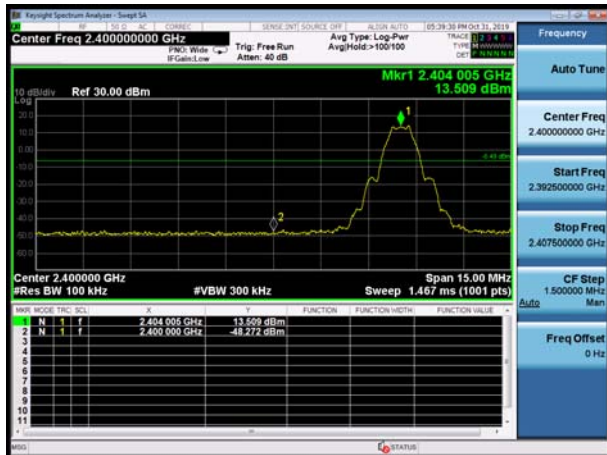

BT UHD BLE 1M GFSK, Carrier frequency (MHz): 2478

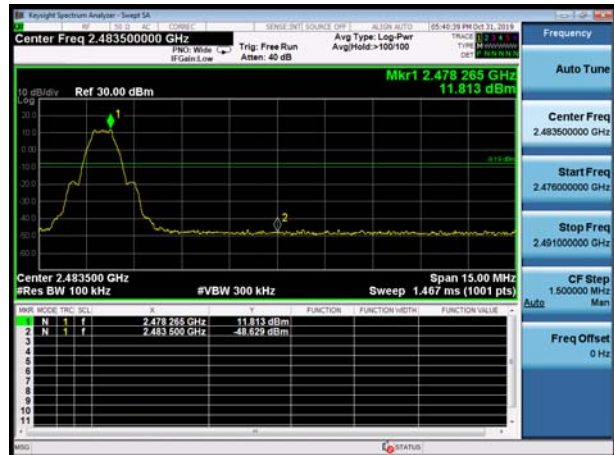

BT UHD BLE 2M GFSK, Carrier frequency (MHz): 2404

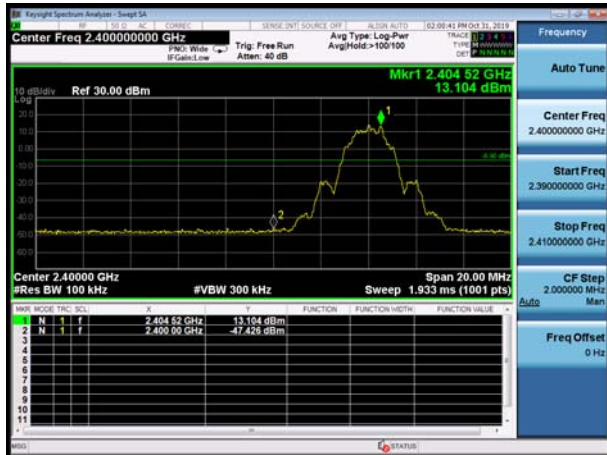

BT UHD BLE 2M GFSK, Carrier frequency (MHz): 2478

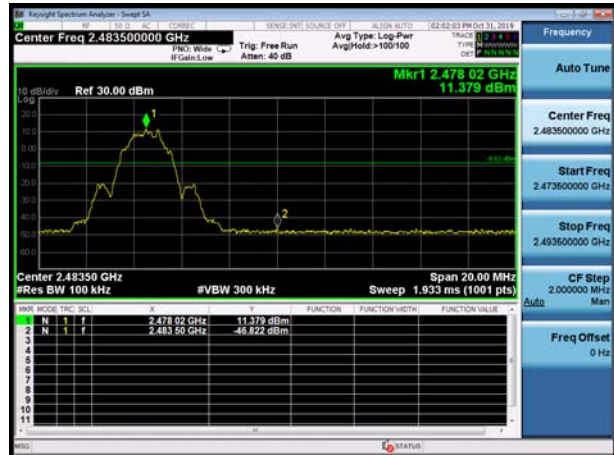

5.6 Number of hopping Frequency

Ambient condition

Temperature	Relative humidity	Pressure
23°C ~25°C	45%~50%	101.5kPa

Method of Measurement

The EUT was connected to the spectrum analyzer and Bluetooth test set via a power splitter with a known loss. RBW is set to 100kHz and VBW is set to 300kHz on spectrum analyzer. Set EUT on Hopping on mode.

Test setup

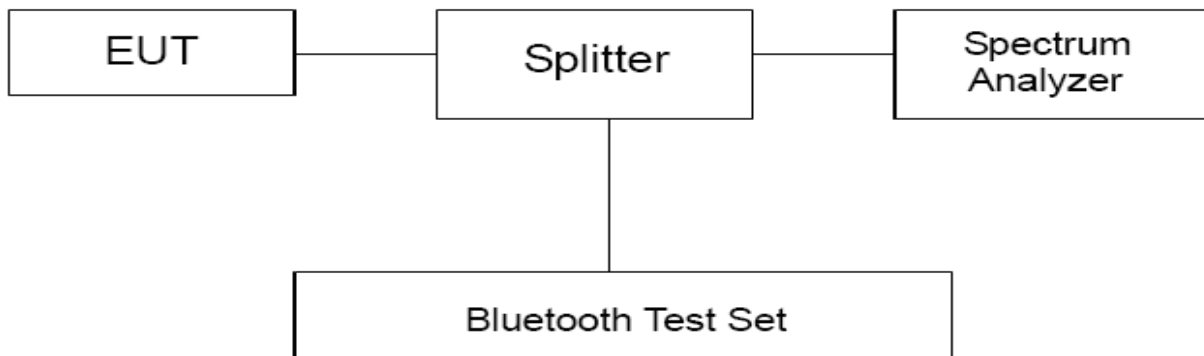

Limits

Rule Part 15.247(a) (1) (iii) specifies that” Frequency hopping systems in the 2400–2483.5 MHz band shall use at least 15 channels.”

Limits	≥ 15 channels
--------	---------------

Test Results:
BT UHD Normal Mode

Mode		Number of hopping channels	conclusion
BT UHD	BT UHD 2M $\pi/4$ -DQPSK	38	PASS
	BT UHD 2M 8DPSK	38	PASS
	BT UHD 4M $\pi/4$ -DQPSK	19	PASS
	BT UHD BLE 1M GFSK	38	PASS
	BT UHD BLE 2M GFSK	38	PASS

BT UHD High Power Mode

Mode		Number of hopping channels	conclusion
BT UHD	BT UHD 2M $\pi/4$ -DQPSK	38	PASS
	BT UHD 2M 8DPSK	38	PASS
	BT UHD 4M $\pi/4$ -DQPSK	19	PASS
	BT UHD BLE 1M GFSK	38	PASS
	BT UHD BLE 2M GFSK	38	PASS

BT UHD Normal Mode

BT UHD 2M $\pi/4$ -DQPSK 2400 MHz – 2483.5 MHz

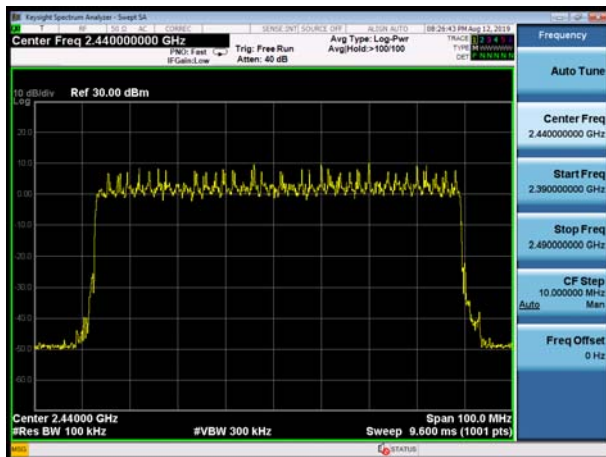

BT UHD 2M 8DPSK 2400 MHz – 2483.5 MHz

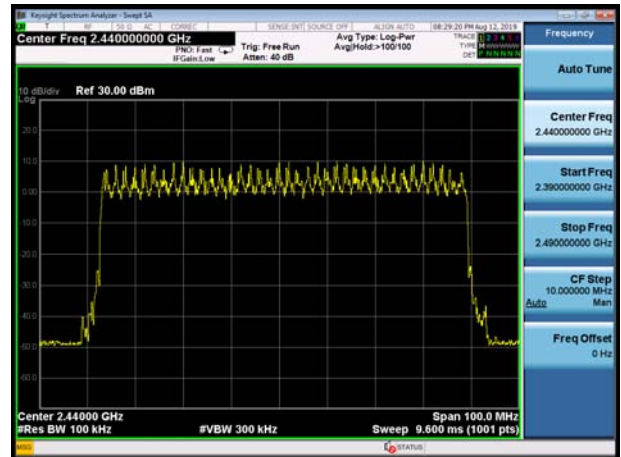

BT UHD 4M $\pi/4$ -DQPSK 2400 MHz – 2483.5 MHz

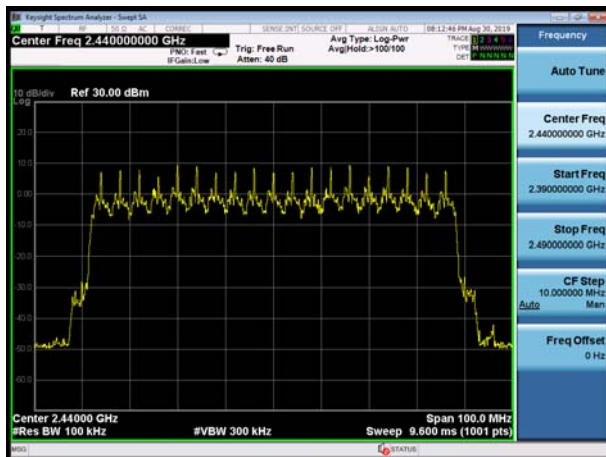

BT UHD BT UHD BLE 1M GFSK 2400 MHz – 2483.5 MHz



BT UHD BT UHD BLE 1M GFSK 2400 MHz – 2483.5 MHz

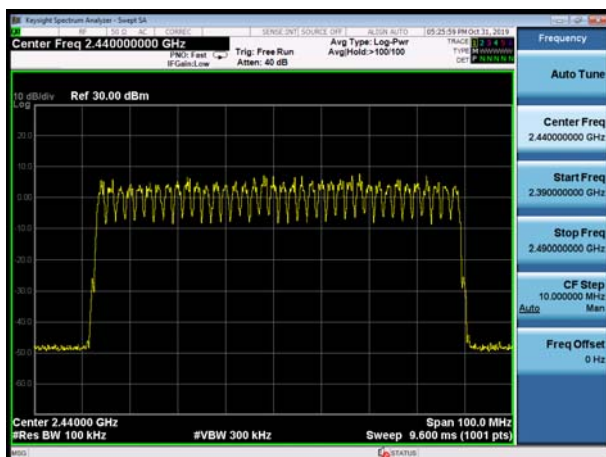

BT UHD High Power Mode

BT UHD 2M $\pi/4$ -DQPSK 2400 MHz – 2483.5 MHz

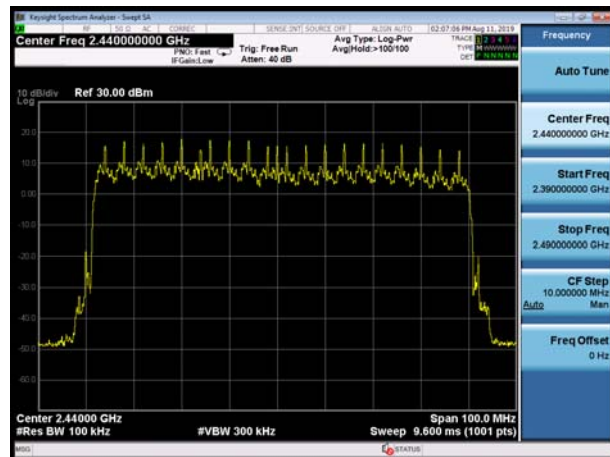

BT UHD 2M 8DPSK 2400 MHz – 2483.5 MHz

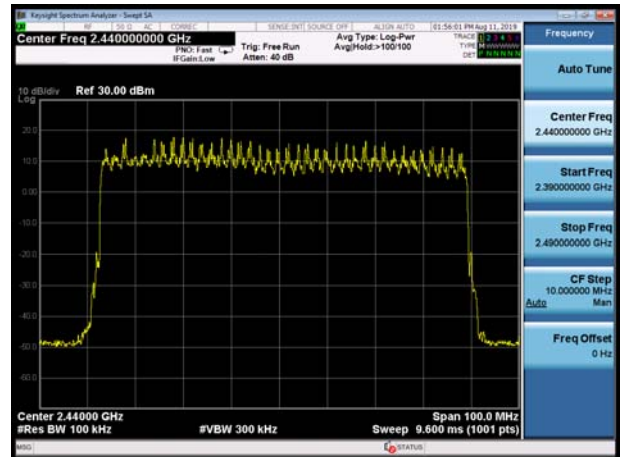

BT UHD 4M $\pi/4$ -DQPSK 2400 MHz – 2483.5 MHz

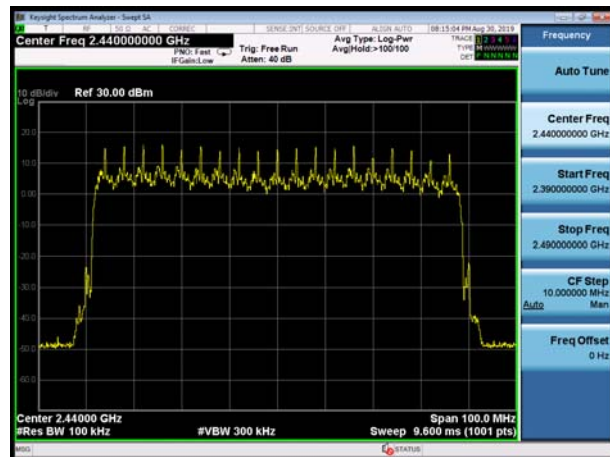

BT UHD BT UHD BLE 1M GFSK 2400 MHz – 2483.5 MHz

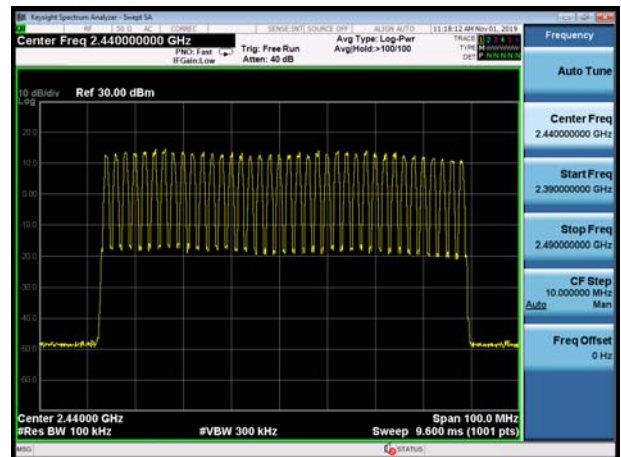

BT UHD BT UHD BLE 1M GFSK 2400 MHz – 2483.5 MHz

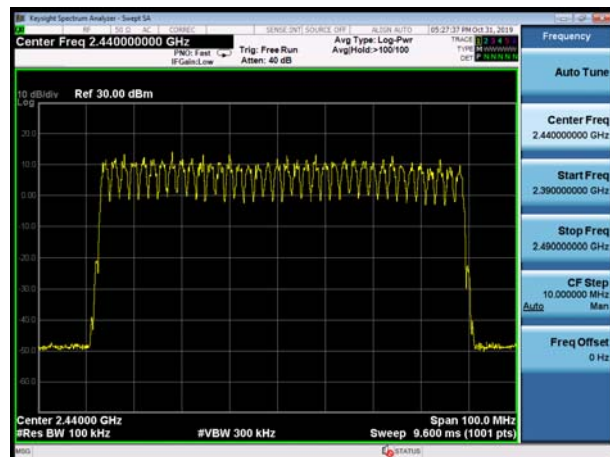

5.7 Spurious RF Conducted Emissions

Ambient condition

Temperature	Relative humidity	Pressure
23°C ~25°C	45%~50%	101.5kPa

Method of Measurement

The EUT was connected to the spectrum analyzer and Bluetooth test set via a power splitter with a known loss. The spectrum analyzer scans from 30MHz to the 10th harmonic of the carrier. The peak detector is used. Set RBW 100kHz and VBW 300 kHz, Sweep is set to ATUO.

The test is in transmitting mode.

Test setup

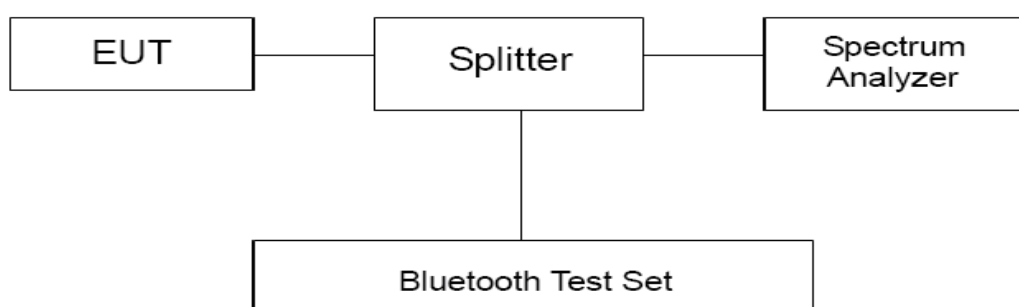

Limits

Rule Part 15.247(d) pacifies that “In any 100 kHz bandwidth outside the frequency band in which the spread spectrum intentional radiator is operating, the radio frequency power that is produced by the intentional radiator shall be at least 20 dB below that in the 100 kHz bandwidth within the band that contains the highest level of the desired power.”

BT UHD Normal Mode

Mode	Carrier frequency (MHz)	Reference value (dBm)	Limit
BT UHD 2M $\pi/4$ -DQPSK	2404	8.31	-11.69
	2440	3.50	-16.50
	2478	5.35	-14.65
BT UHD 2M 8DPSK	2404	8.40	-11.60
	2440	8.94	-11.06
	2478	6.73	-13.27
BT UHD 4M $\pi/4$ -DQPSK	2404	5.62	-14.38
	2440	5.35	-14.65
	2476	7.56	-12.45
BLE 1M GFSK	2404	6.14	-23.86
	2440	6.85	-23.16
	2478	6.47	-23.53
BLE 2M GFSK	2404	3.32	-26.69
	2440	6.26	-23.74
	2478	4.63	-25.37

BT UHD High Power Mode

Mode	Carrier frequency (MHz)	Reference value (dBm)	Limit
BT UHD 2M $\pi/4$ -DQPSK	2404	10.32	-9.68
	2440	9.38	-10.62
	2478	11.01	-8.99
BT UHD 2M 8DPSK	2404	12.41	-7.59
	2440	15.13	-4.87
	2478	13.04	-6.96
BT UHD 4M $\pi/4$ -DQPSK	2404	10.62	-9.38
	2440	13.68	-6.32
	2476	13.49	-6.51
BLE 1M GFSK	2404	13.15	-6.85
	2440	12.47	-7.53
	2478	11.79	-8.22
BLE 2M GFSK	2404	13.37	-6.63
	2440	12.49	-7.51
	2478	9.63	-10.37

Measurement Uncertainty

The assessed measurement uncertainty to ensure 95% confidence level for the normal distribution is with the coverage factor $k = 1.96$.

Frequency	Uncertainty
100kHz-2GHz	0.684 dB
2GHz-26GHz	1.407 dB

Test Results:

The signal beyond the limit is carrier.

BT UHD Normal Mode

BT UHD 2M $\pi/4$ -DQPSK 2404MHz 30MHz to 26.5GHz

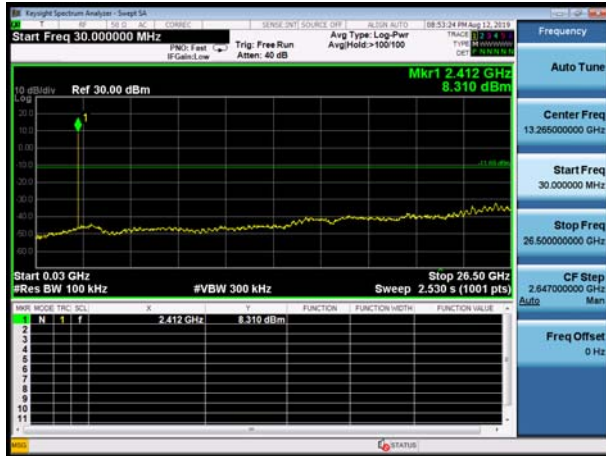

BT UHD 2M 8DPSK 2404MHz 30MHz to 26.5GHz

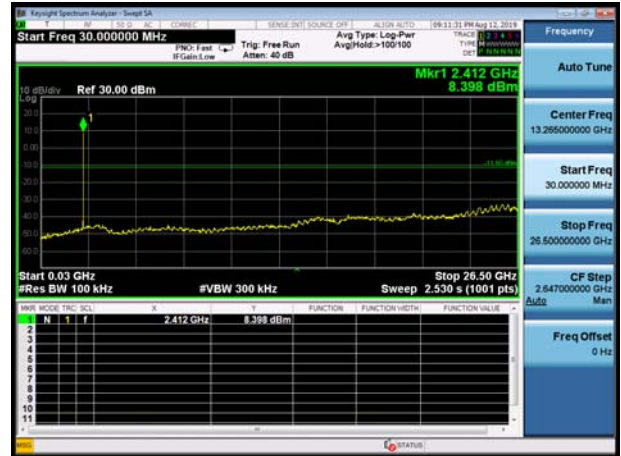

BT UHD 2M $\pi/4$ -DQPSK 2440MHz 30MHz to 26.5GHz

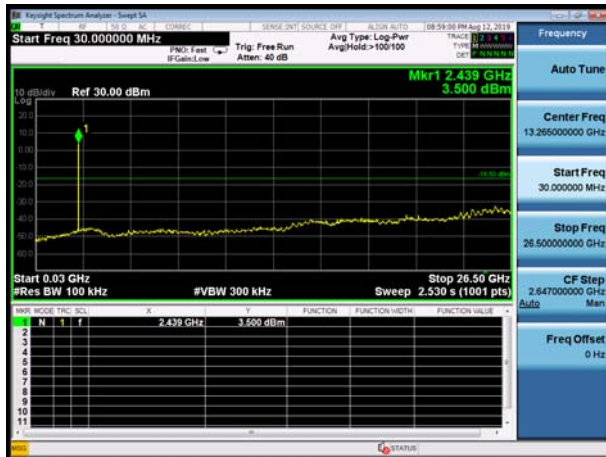

BT UHD 2M 8DPSK 2440MHz 30MHz to 26.5GHz

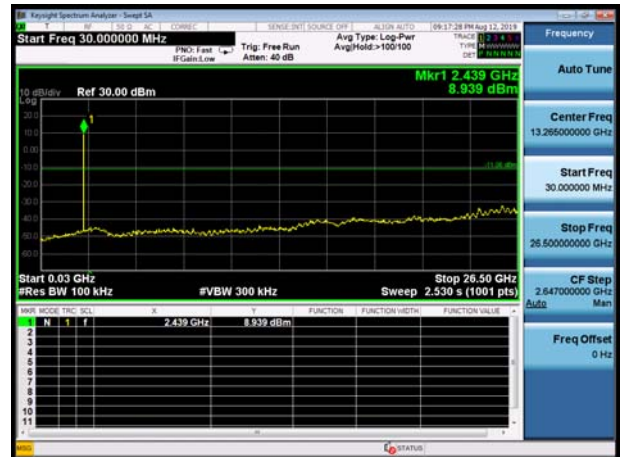

BT UHD 2M $\pi/4$ -DQPSK 2478MHz 30MHz to 26.5GHz

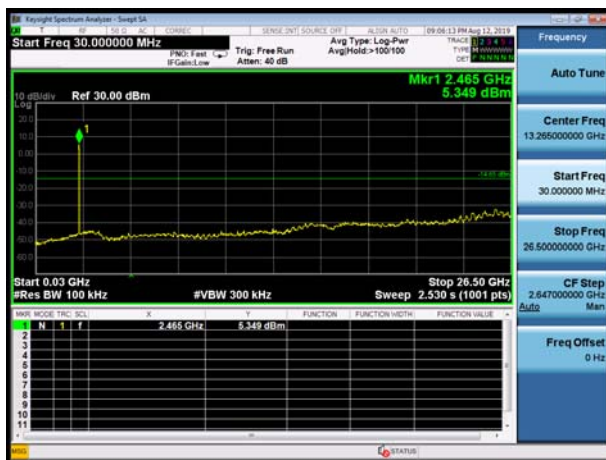

BT UHD 2M 8DPSK 2478MHz 30MHz to 26.5GHz

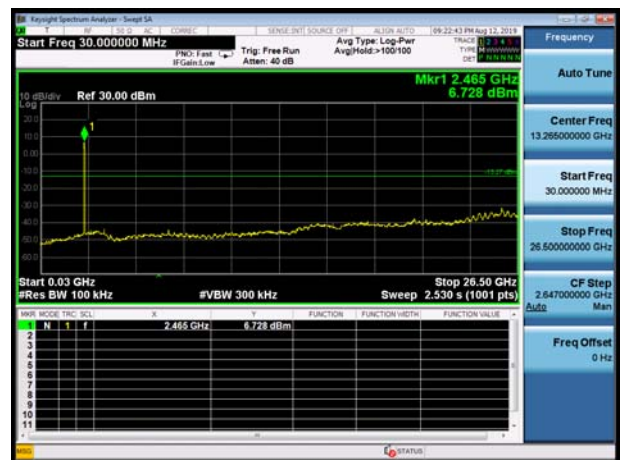

BT UHD 4M $\pi/4$ -DQPSK 2404MHz 30MHz to 26.5GHz

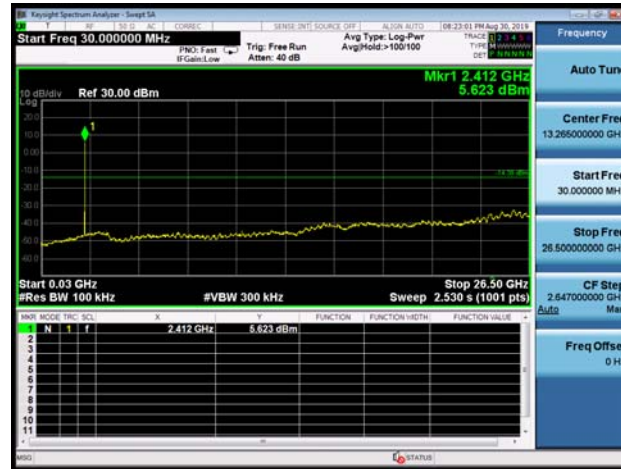

BT UHD 4M $\pi/4$ -DQPSK 2440MHz 30MHz to 26.5GHz

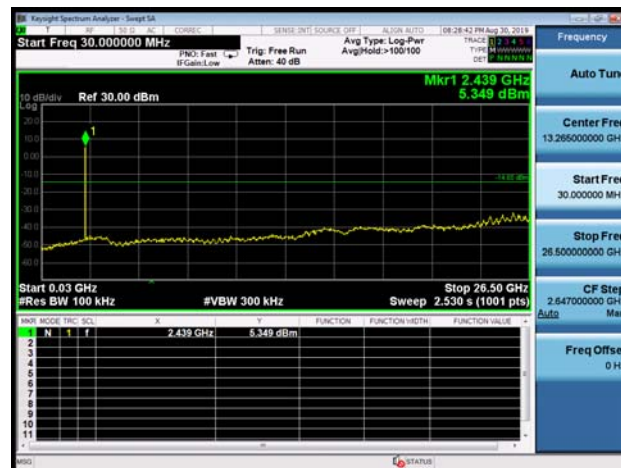

BT UHD 4M $\pi/4$ -DQPSK 2476MHz 30MHz to 26.5GHz

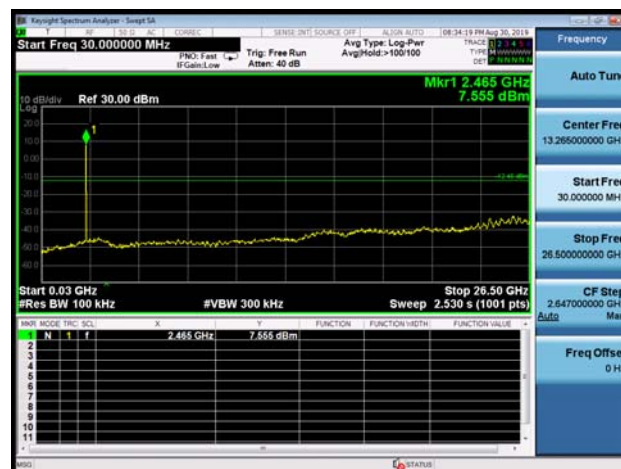



BT UHD BLE 1M GFSK 2404MHz 30MHz to 26.5GHz

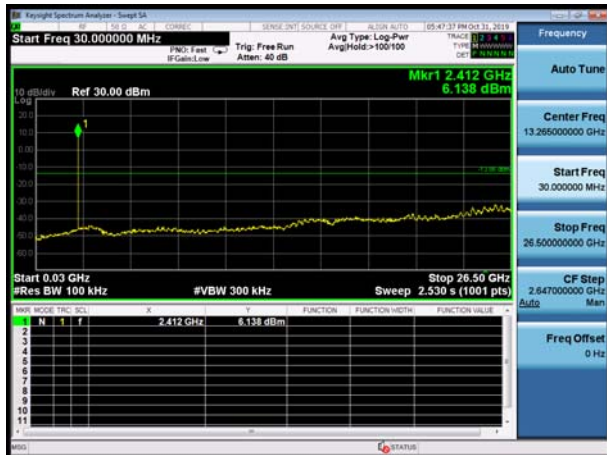

BT UHD BLE 2M GFSK 2404MHz 30MHz to 26.5GHz

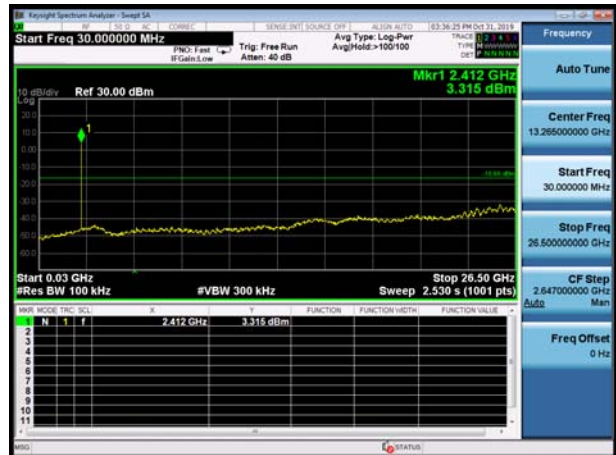

BT UHD BLE 1M GFSK 2440MHz 30MHz to 26.5GHz

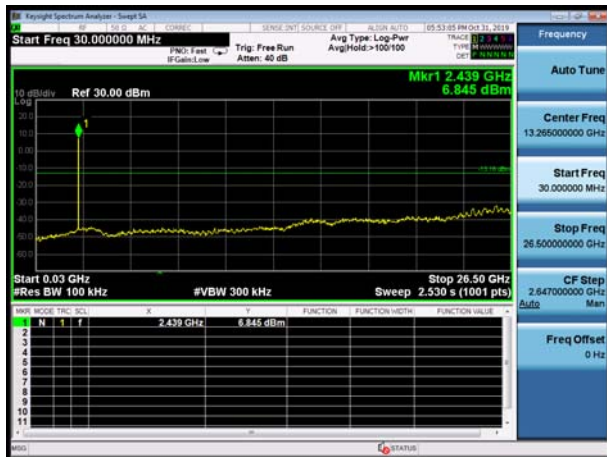

BT UHD BLE 2M GFSK 2440MHz 30MHz to 26.5GHz

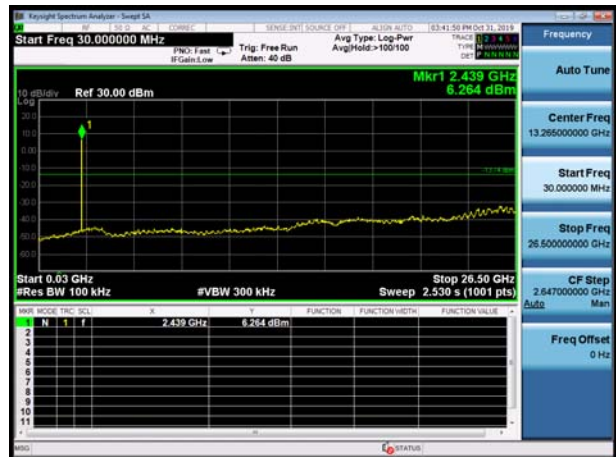

BT UHD BLE 1M GFSK 2478MHz 30MHz to 26.5GHz

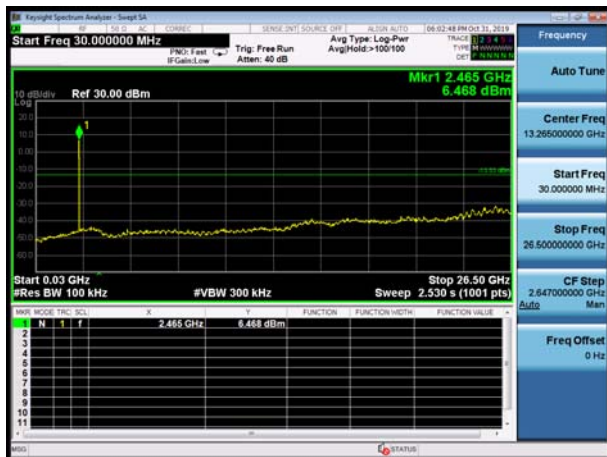

BT UHD BLE 2M GFSK 2478MHz 30MHz to 26.5GHz

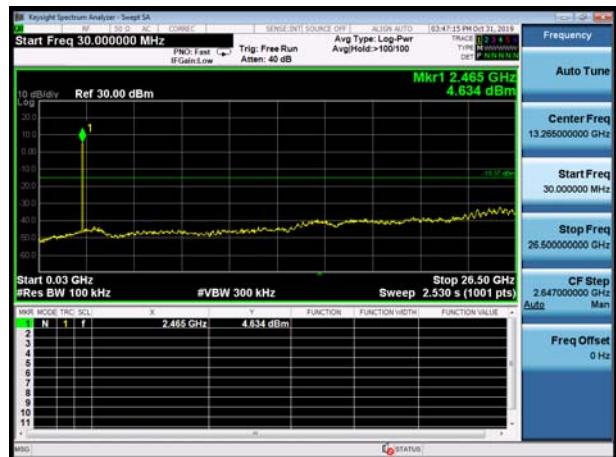

BT UHD High Power Mode

BT UHD 2M $\pi/4$ -DQPSK 2404MHz 30MHz to 26.5GHz

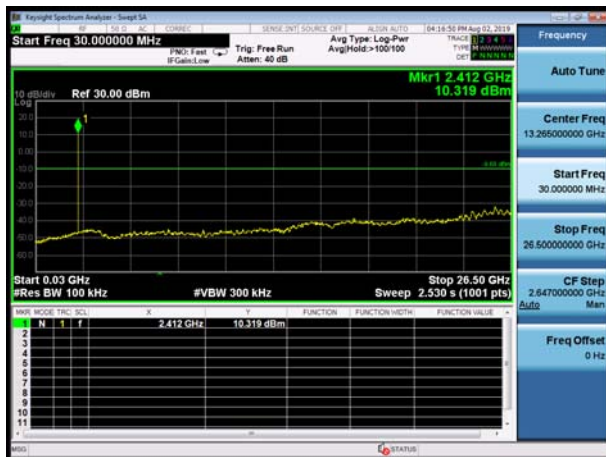

BT UHD 2M 8DPSK 2404MHz 30MHz to 26.5GHz

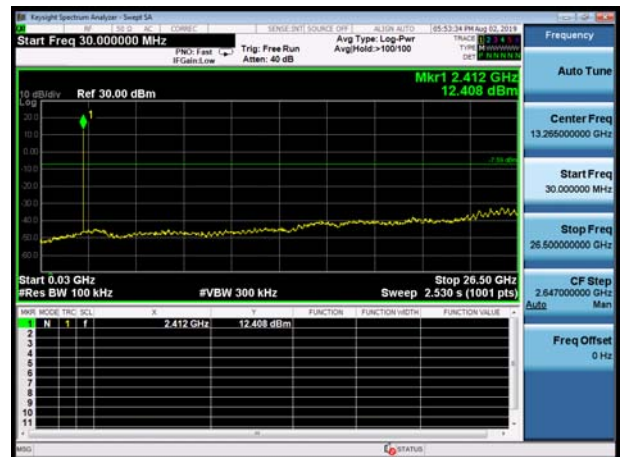

BT UHD 2M $\pi/4$ -DQPSK 2440MHz 30MHz to 26.5GHz

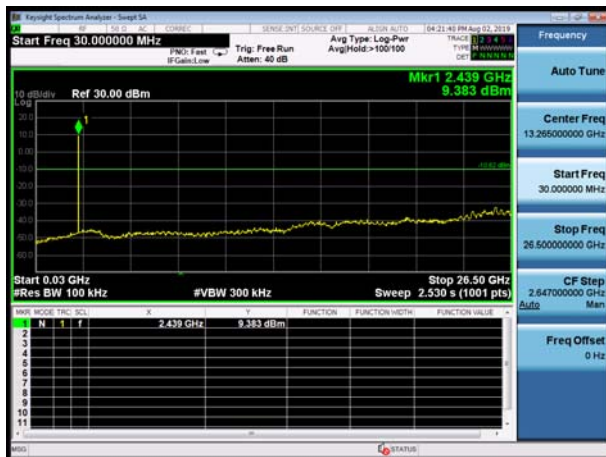

BT UHD 2M 8DPSK 2440MHz 30MHz to 26.5GHz

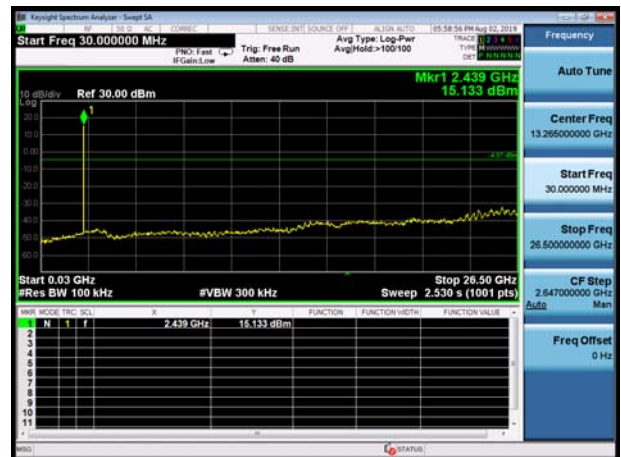

BT UHD 2M $\pi/4$ -DQPSK 2478MHz 30MHz to 26.5GHz

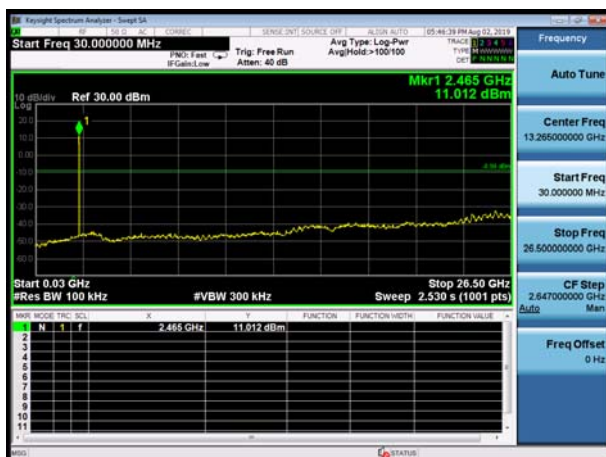

BT UHD 2M 8DPSK 2478MHz 30MHz to 26.5GHz

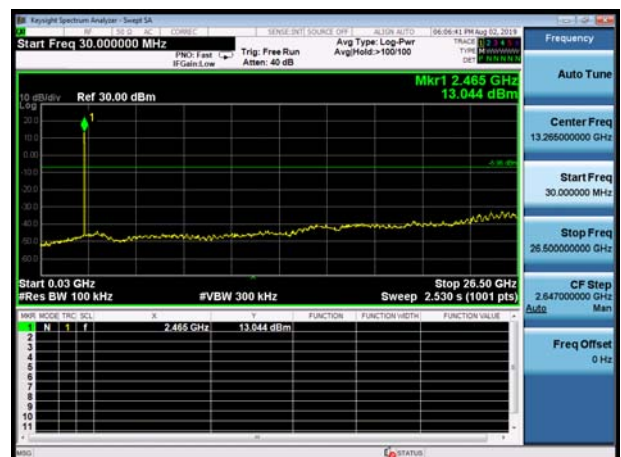

BT UHD 4M $\pi/4$ -DQPSK 2404MHz 30MHz to 26.5GHz

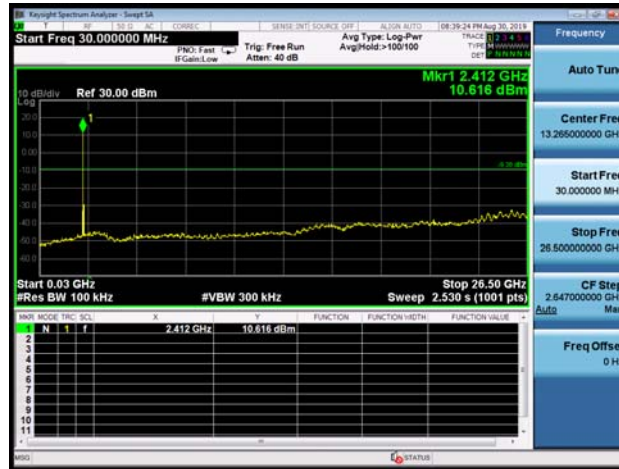

BT UHD 4M $\pi/4$ -DQPSK 2440MHz 30MHz to 26.5GHz

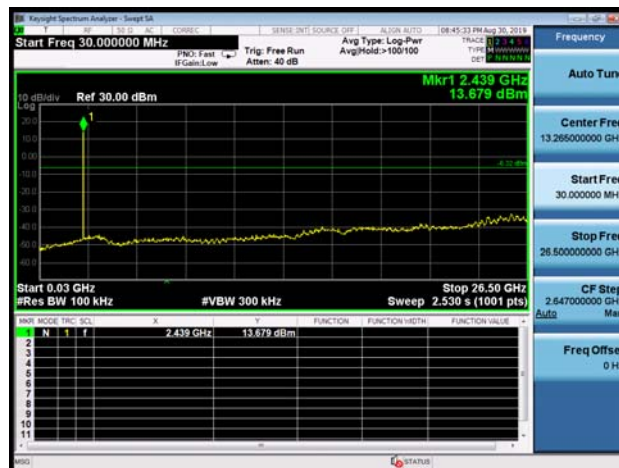

BT UHD 4M $\pi/4$ -DQPSK 2476MHz 30MHz to 26.5GHz

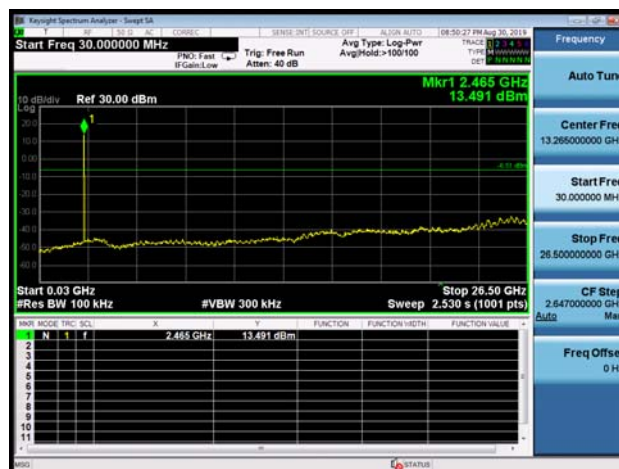



BT UHD BLE 1M GFSK 2404MHz 30MHz to 26.5GHz

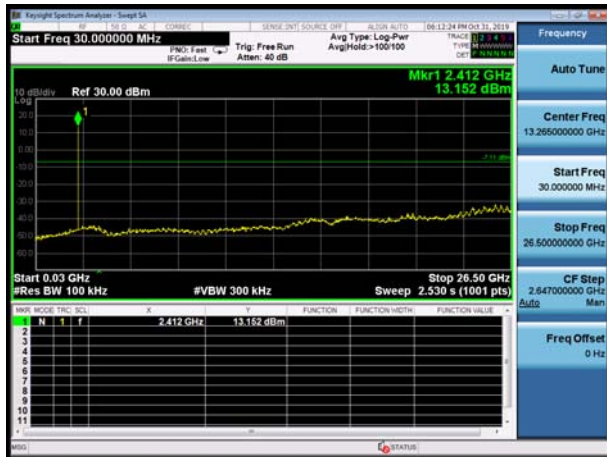

BT UHD BLE 2M GFSK 2404MHz 30MHz to 26.5GHz

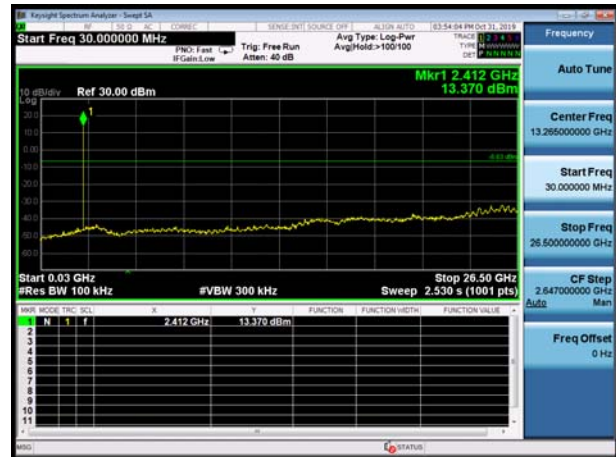

BT UHD BLE 1M GFSK 2440MHz 30MHz to 26.5GHz

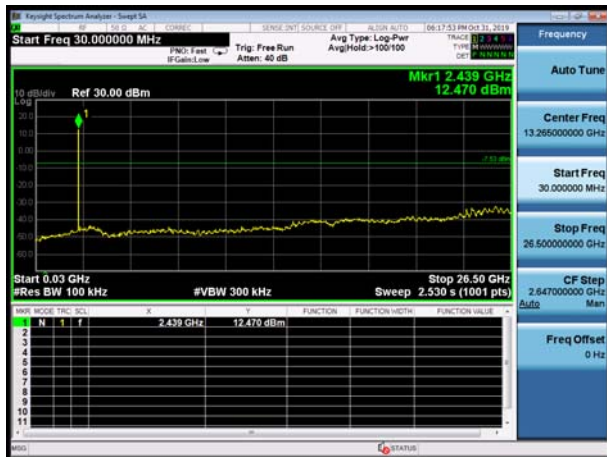

BT UHD BLE 2M GFSK 2440MHz 30MHz to 26.5GHz

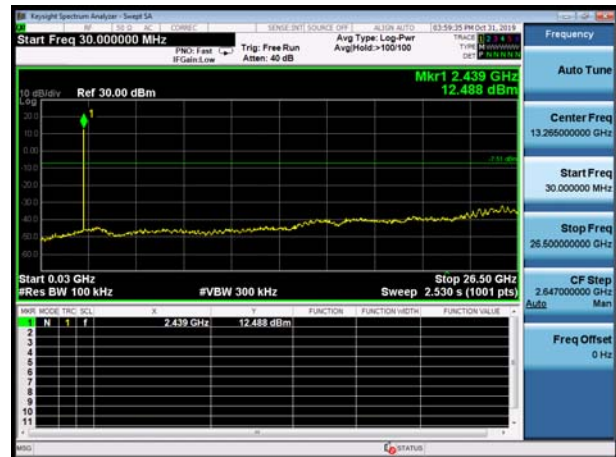

BT UHD BLE 1M GFSK 2478MHz 30MHz to 26.5GHz

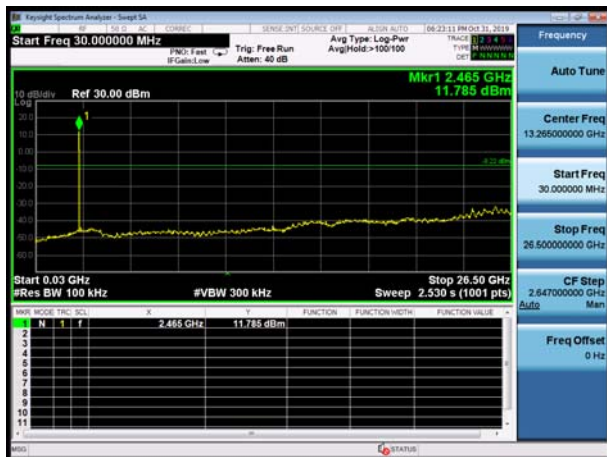

BT UHD BLE 2M GFSK 2478MHz 30MHz to 26.5GHz

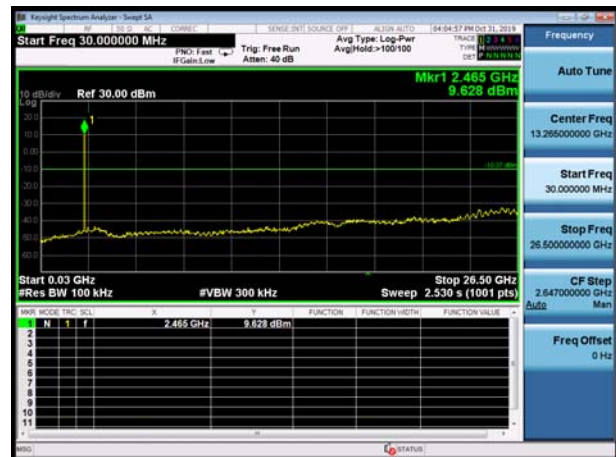

5.8 Unwanted Emission

Ambient condition

Temperature	Relative humidity	Pressure
23°C ~25°C	45%~50%	101.5kPa

Method of Measurement

The test set-up was made in accordance to the general provisions of ANSI C63.10-2013. The Equipment Under Test (EUT) was set up on a non-conductive table in the semi-anechoic chamber. The test was performed at the distance of 3 m between the EUT and the receiving antenna. The radiated emissions measurements were made in a typical installation configuration. Sweep the whole frequency band through the range from 9 kHz to the 10th harmonic of the carrier, and the emissions less than 20 dB below the permissible value are reported.

During the test, below 30MHz, the center of the loop shall be 1 meters; above 30MHz, the height of receive antenna shall be moved from 1 to 4 meters, and the antenna shall be performed under horizontal and vertical polarization. The turntable shall be rotated from 0 to 360 degrees for detecting the maximum of radiated spurious signal level. The measurements shall be repeated with orthogonal polarization of the test antenna. The data of cable loss and antenna factor has been calibrated in full testing frequency range before the testing.

Set the spectrum analyzer in the following:

Below 1GHz (detector: Peak and Quasi-Peak)

RBW=100kHz / VBW=300kHz / Sweep=AUTO

Above 1GHz(detector: Peak):

(a) PEAK: RBW=1MHz VBW=3MHz/ Sweep=AUTO

(b) AVERAGE: RBW=1MHz / VBW=3MHz / Sweep=AUTO

The dwell time per channel of the hopping signal is less than 100 ms, then the reading obtained with the 10 Hz VBW may be further adjusted by a “duty cycle correction factor”, derived from $20\log(\text{dwell time}/100 \text{ ms})$, in an effort to demonstrate compliance with the 15.209 limit.

If the emission is pulsed, modify the unit for continuous operation; use the settings shown above, then correct the reading by subtracting the peak- average correction factor, derived form the appropriate duty cycle calculation.

This setting method can refer to **KDB 558074 D01**.

This mode was measured in the following mode: EUT with cradle and EUT without cradle. The worst emission was found in EUT with cradle mode and the worst case was recorded.

The test is in transmitting mode.

Test setup
9KHz ~ 30MHz

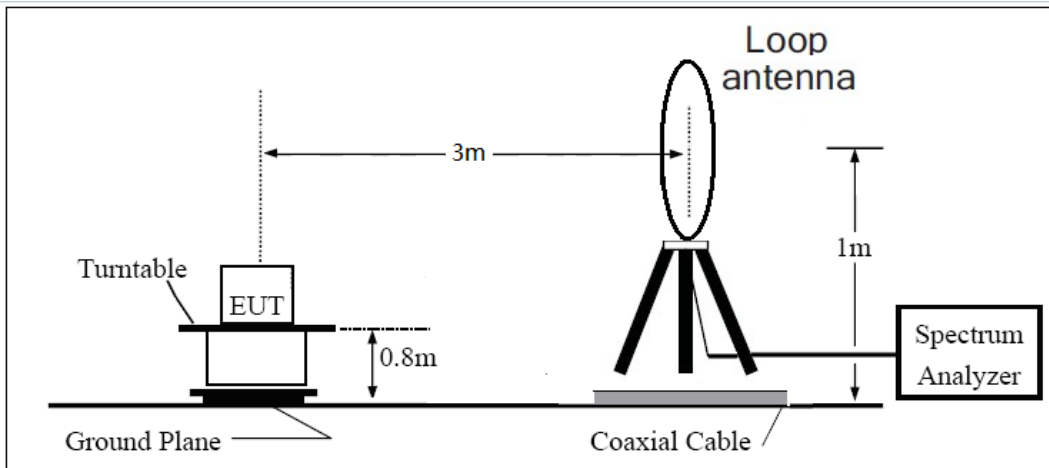

30MHz ~ 1GHz

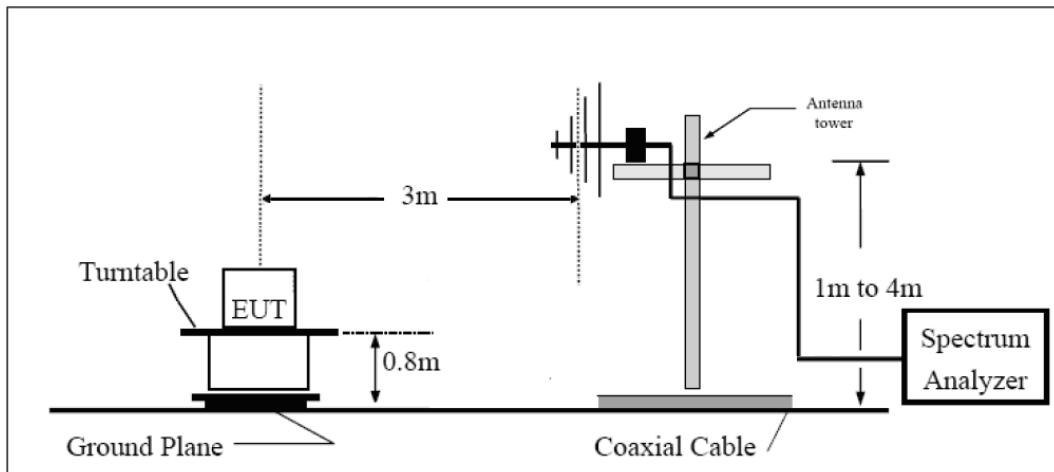

Above 1GHz

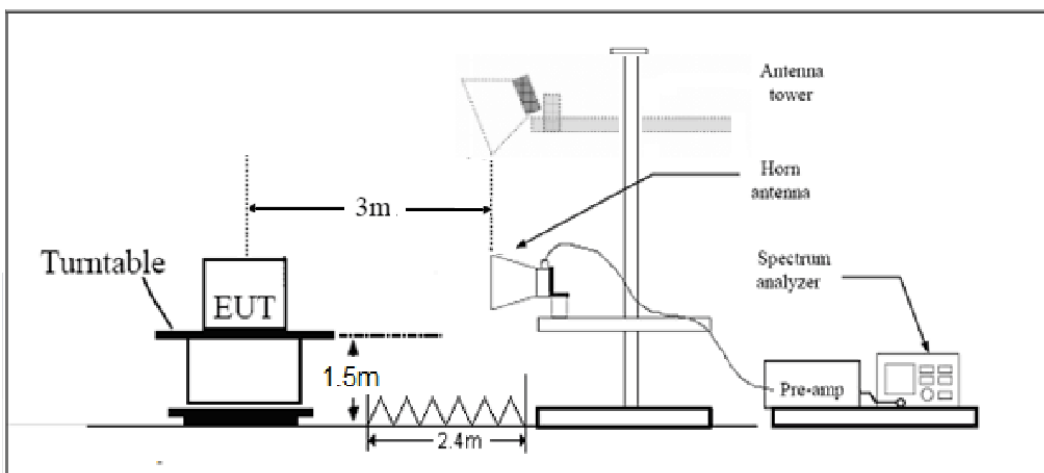

Limits

Rule Part 15.247(d) specifies that “In addition, radiated emissions which fall in the restricted bands, as defined in § 15.205(a), must also comply with the radiated emission limits specified in § 15.209(a) (see § 15.205(c)).”

Limit in restricted band

Frequency of emission (MHz)	Field strength(uV/m)	Field strength(dBuV/m)
0.009–0.490	2400/F(kHz)	/
0.490–1.705	24000/F(kHz)	/
1.705–30.0	30	/
30-88	100	40
88-216	150	43.5
216-960	200	46
Above960	500	54

§15.35(b)

There is also a limit on the radio frequency emissions, as measured using instrumentation with a peak detector function, corresponding to 20 dB above the maximum permitted average limit.

Peak Limit=74dBuV/m

Average Limit=54dBuV/m

Spurious Radiated Emissions are permitted in any of the frequency bands listed below:

MHz	MHz	MHz	GHz
0.090 - 0.110	16.42 - 16.423	399.9 - 410	4.5 - 5.15
¹ 0.495 - 0.505	16.69475 - 16.69525	608 - 614	5.35 - 5.46
2.1735 - 2.1905	16.80425 - 16.80475	960 - 1240	7.25 - 7.75
4.125 - 4.128	25.5 - 25.67	1300 - 1427	8.025 - 8.5
4.17725 - 4.17775	37.5 - 38.25	1435 - 1626.5	9.0 - 9.2
4.20725 - 4.20775	73 - 74.6	1645.5 - 1646.5	9.3 - 9.5
6.215 - 6.218	74.8 - 75.2	1660 - 1710	10.6 - 12.7
6.26775 - 6.26825	108 - 121.94	1718.8 - 1722.2	13.25 - 13.4
6.31175 - 6.31225	123 - 138	2200 - 2300	14.47 - 14.5
8.291 - 8.294	149.9 - 150.05	2310 - 2390	15.35 - 16.2
8.362 - 8.366	156.52475 - 156.52525	2483.5 - 2500	17.7 - 21.4
8.37625 - 8.38675	156.7 - 156.9	2690 - 2900	22.01 - 23.12
8.41425 - 8.41475	162.0125 - 167.17	3260 - 3267	23.6 - 24.0
12.29 - 12.293	167.72 - 173.2	3332 - 3339	31.2 - 31.8
12.51975 - 12.52025	240 - 285	3345.8 - 3358	36.43 - 36.5
12.57675 - 12.57725	322 - 335.4	3600 - 4400	(²)
13.36 - 13.41			

**Measurement Uncertainty**

The assessed measurement uncertainty to ensure 95% confidence level for the normal distribution is with the coverage factor $k = 1.96$.

Frequency	Uncertainty
9KHz-30MHz	3.55 dB
30MHz-200MHz	4.02 dB
200MHz-1GHz	3.28 dB
1-18GHz	3.70 dB
18-26.5GHz	5.78 dB



Test Results:

The signal beyond the limit is carrier.

BT UHD 2M $\pi/4$ -DQPSK 2404MHz: Peak

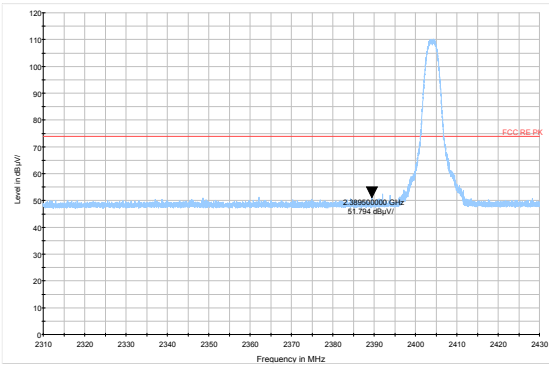

BT UHD 2M $\pi/4$ -DQPSK 2404MHz: Average

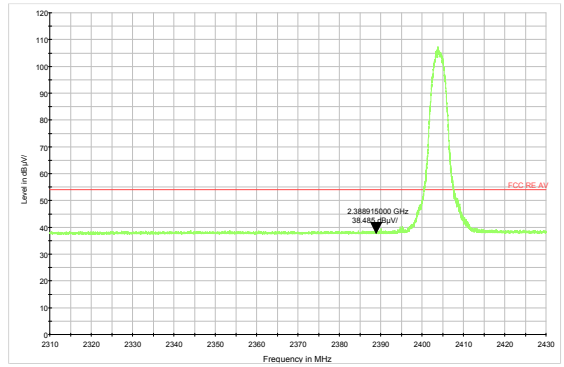

BT UHD 2M $\pi/4$ -DQPSK 2478MHz: Peak

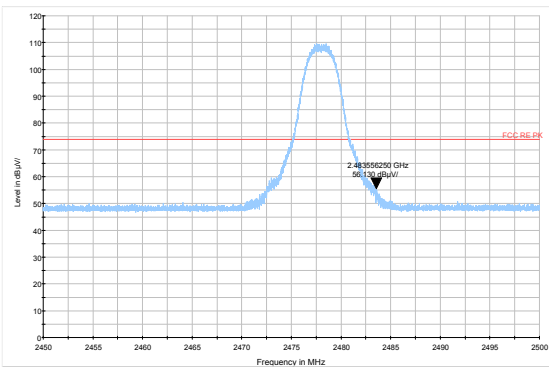

BT UHD 2M $\pi/4$ -DQPSK 2478MHz: Average

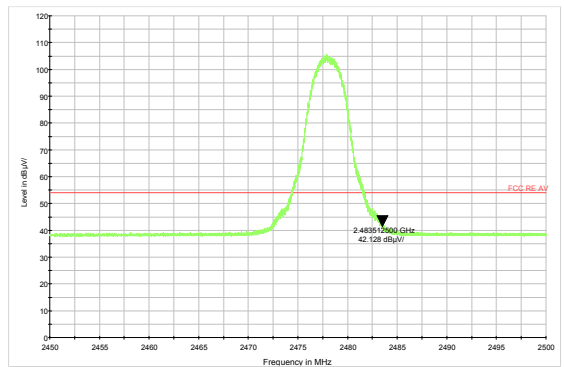

BT UHD 2M 8DPSK_2404MHz: Peak

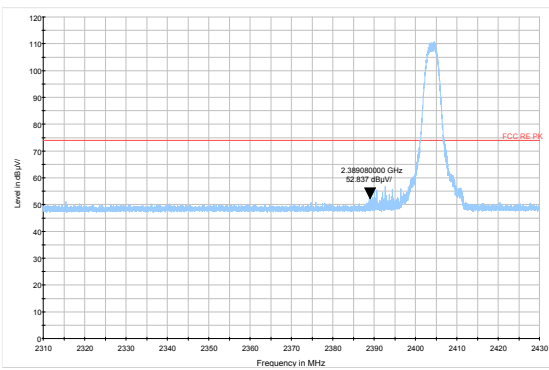

BT UHD 2M 8DPSK_2404MHz: Average

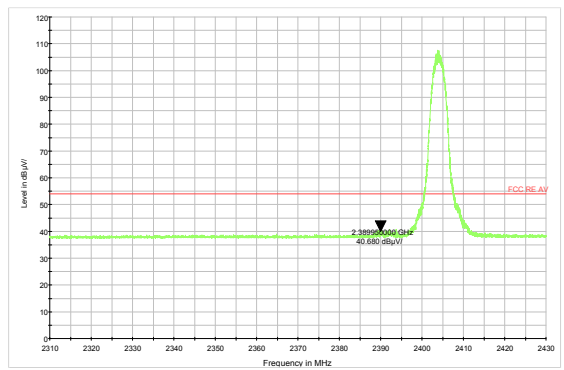



BT UHD 2M 8DPSK_2478MHz: Peak

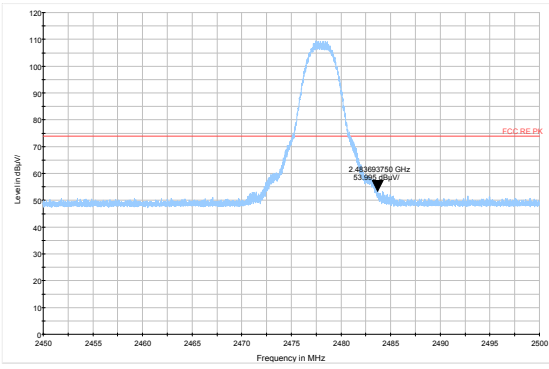

BT UHD 2M 8DPSK_2478MHz: Average

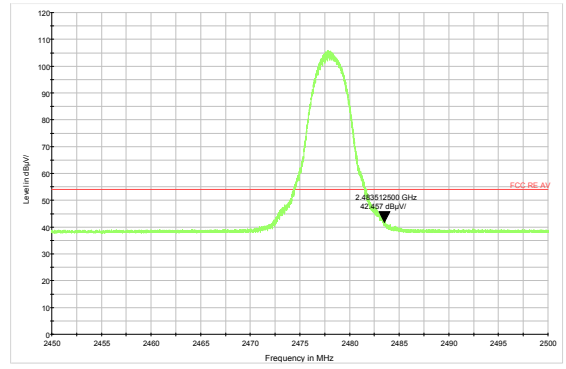

BT UHD 4M π/4-DQPSK 2404MHz: Peak

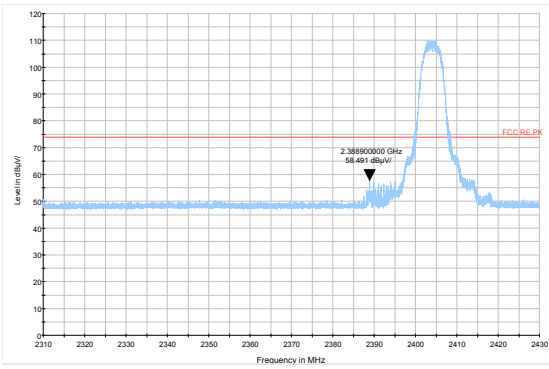

BT UHD 4M π/4-DQPSK 2404MHz: Average

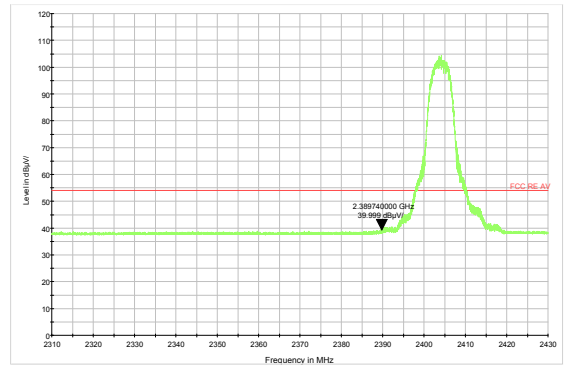

BT UHD 4M π/4-DQPSK 2476MHz: Peak

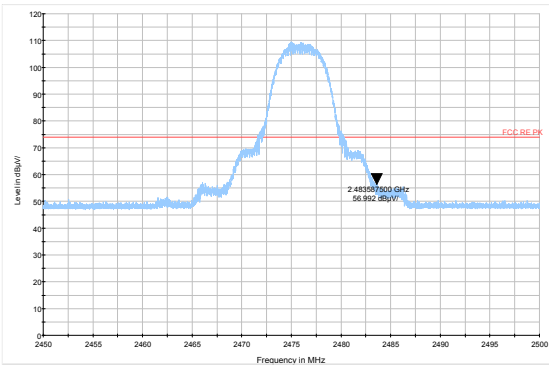

BT UHD 4M π/4-DQPSK 2476MHz: Average

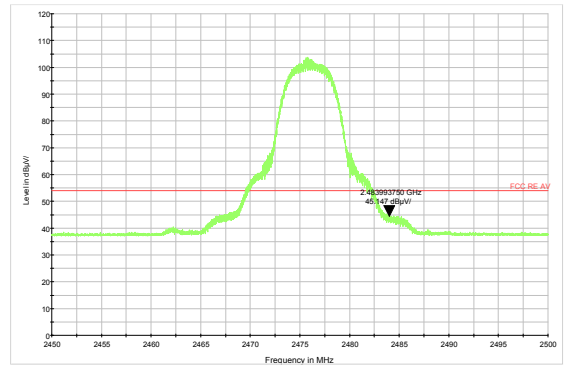

BT UHD BLE 1M GFSK 2404MHz: Peak

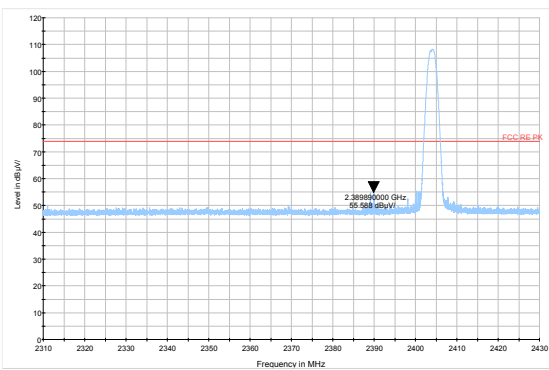

BT UHD BLE 1M GFSK 2404MHz: Average

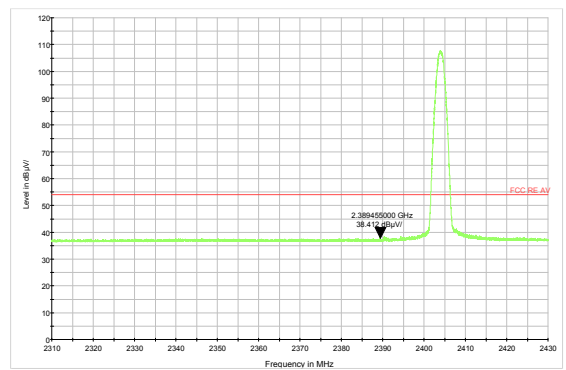



BT UHD BLE 1M GFSK 2478MHz: Peak

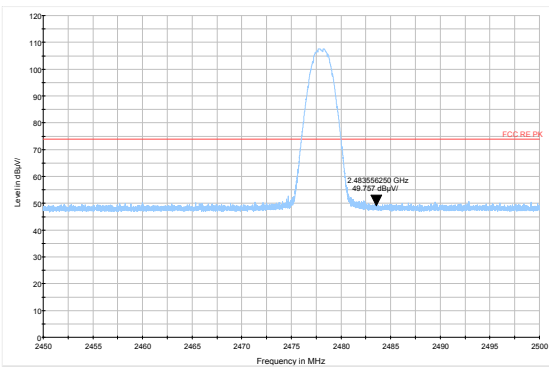

BT UHD BLE 1M GFSK 2478MHz: Average

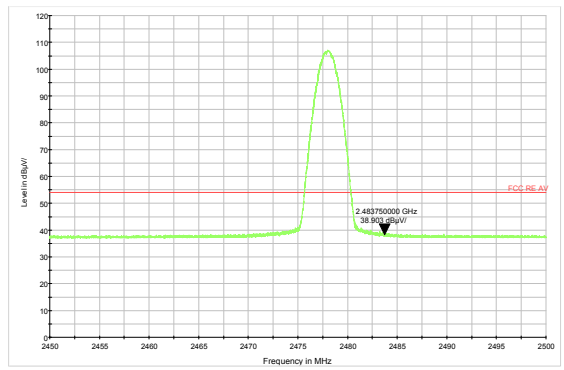

BT UHD BLE 2M GFSK 2404MHz: Peak

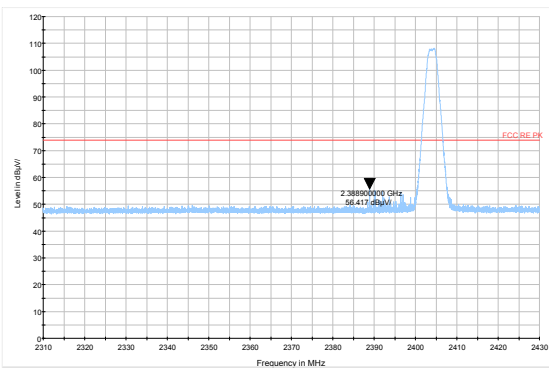

BT UHD BLE 2M GFSK 2404MHz: Average

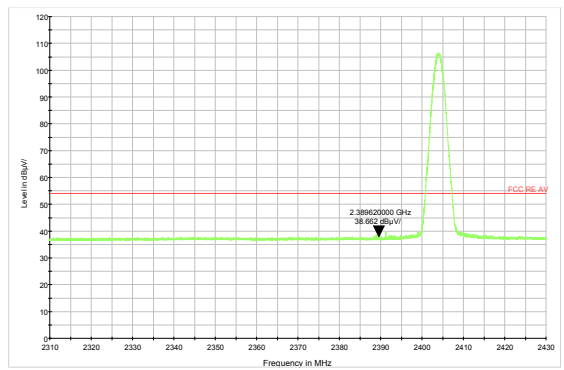

BT UHD BLE 2M GFSK 2478MHz: Peak

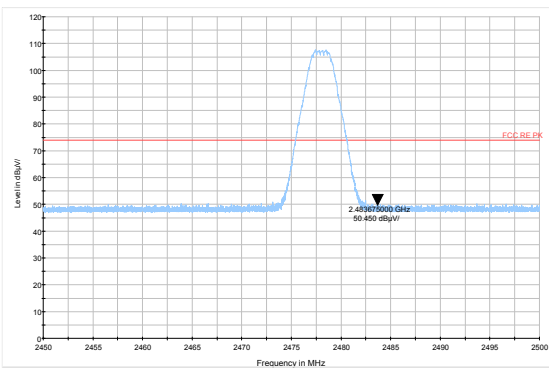

BT UHD BLE 2M GFSK 2478MHz: Average

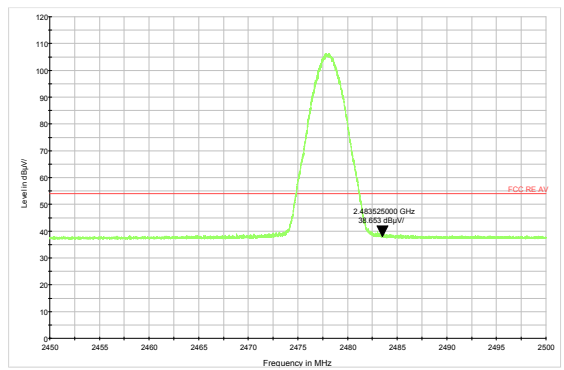

Result of RE

Test result

Sweep the whole frequency band through the range from 9kHz to the 10th harmonic of the carrier, the Emissions in the frequency band 9kHz-30MHz and 18GHz -26.5GHz are more than 20dB below the limit are not reported.

The following graphs display the maximum values of horizontal and vertical by software. For above 1GHz, Blue trace uses the peak detection, Green trace uses the average detection.

During the test, the Radiates Emission from 30MHz to 1GHz was performed in all modes with all channels, **BT UHD High Power Mode BLE 2M GFSK 2404MHz** are selected as the worst condition. The test data of the worst-case condition was recorded in this report.

**Continuous TX mode:
BLE 2M GFSK**

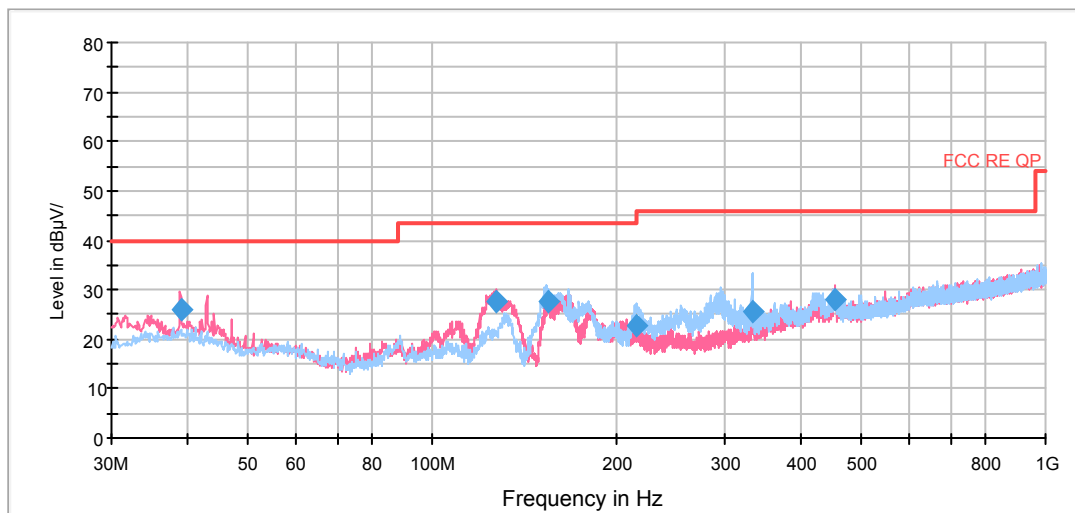

Radiates Emission from 30MHz to 1GHz

Frequency (MHz)	Quasi-Peak (dBuV/m)	Height (cm)	Polarization	Azimuth (deg)	Correct Factor (dB)	Margin (dB)	Limit (dBuV/m)
38.931250	26.2	100.0	V	242.0	16.9	13.8	40.0
127.600000	27.6	100.0	V	21.0	10.5	15.9	43.5
154.517500	27.7	200.0	H	0.0	9.8	15.8	43.5
215.997500	22.7	100.0	H	0.0	12.6	20.8	43.5
332.926250	25.5	100.0	H	0.0	16.7	20.5	46.0
454.293750	27.9	100.0	V	4.0	20.4	18.1	46.0

- Remark: 1. Correction Factor = Antenna factor+ Insertion loss(cable loss+amplifier gain)**
2. Margin = Limit – Quasi-Peak

BT UHD 2M $\pi/4$ -DQPSK -2404MHz

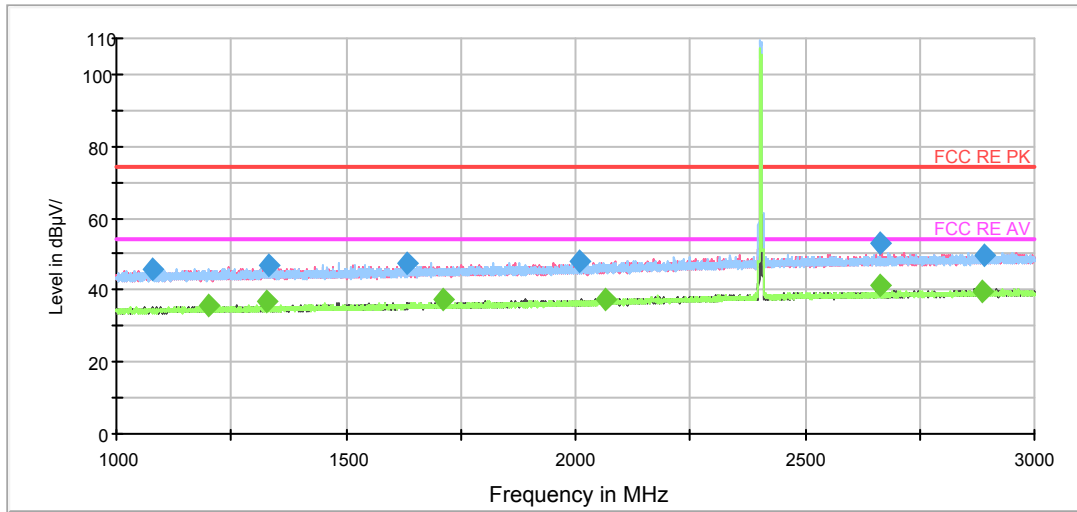

Note: The signal beyond the limit is carrier.
Radiates Emission from 1GHz to 3GHz

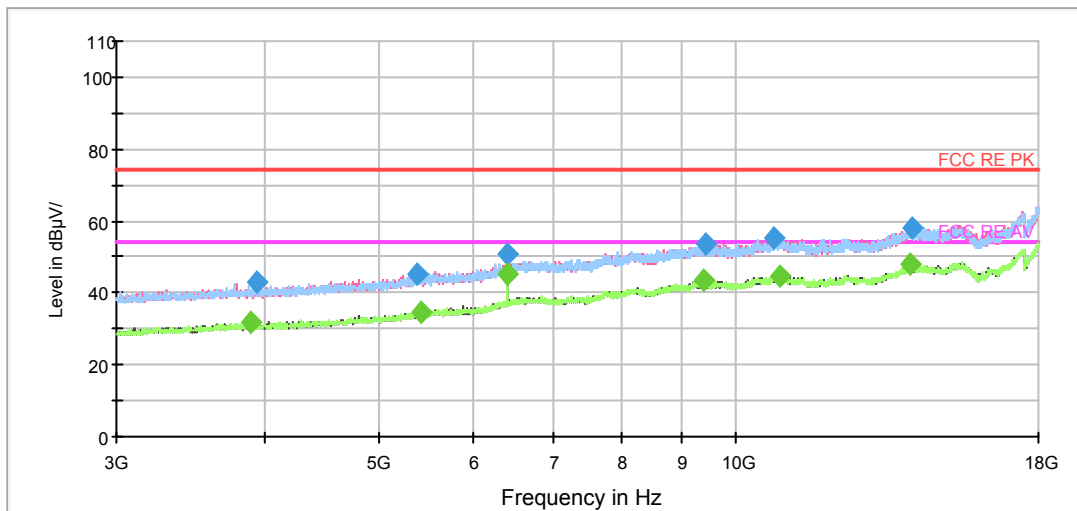

Radiates Emission from 3GHz to 18GHz

Frequency (MHz)	Peak (dBuV/m)	Height (cm)	Polarization	Azimuth (deg)	Correct Factor (dB)	Margin (dB)	Limit (dBuV/m)
1078.750000	45.9	200.0	H	349.0	-1.5	28.1	74.0
1332.000000	46.9	100.0	V	8.0	-0.9	27.1	74.0
1635.250000	47.5	200.0	H	355.0	0.1	26.5	74.0
2008.000000	48.0	200.0	V	0.0	1.1	26.0	74.0
2663.750000	53.0	100.0	V	217.0	3.9	21.0	74.0
2888.750000	49.9	100.0	H	186.0	4.5	24.1	74.0

Remark: 1. Correction Factor = Antenna factor+ Insertion loss (cable loss + amplifier gain)

Frequency (MHz)	Average (dBuV/m)	Height (cm)	Polarization	Azimuth (deg)	Correct Factor (dB)	Margin (dB)	Limit (dBuV/m)
1200.750000	35.6	200.0	H	263.0	-1.2	18.4	54.0
1328.250000	36.8	100.0	V	70.0	-0.9	17.2	54.0
1713.250000	37.3	200.0	H	233.0	0.4	16.7	54.0
2063.750000	37.4	200.0	V	304.0	1.5	16.6	54.0
2663.750000	41.2	100.0	V	217.0	3.9	12.8	54.0
2886.000000	39.6	200.0	V	7.0	4.5	14.4	54.0

Remark: 1. Correction Factor = Antenna factor+ Insertion loss (cable loss + amplifier gain)

BT UHD 2M $\pi/4$ -DQPSK -2440MHz

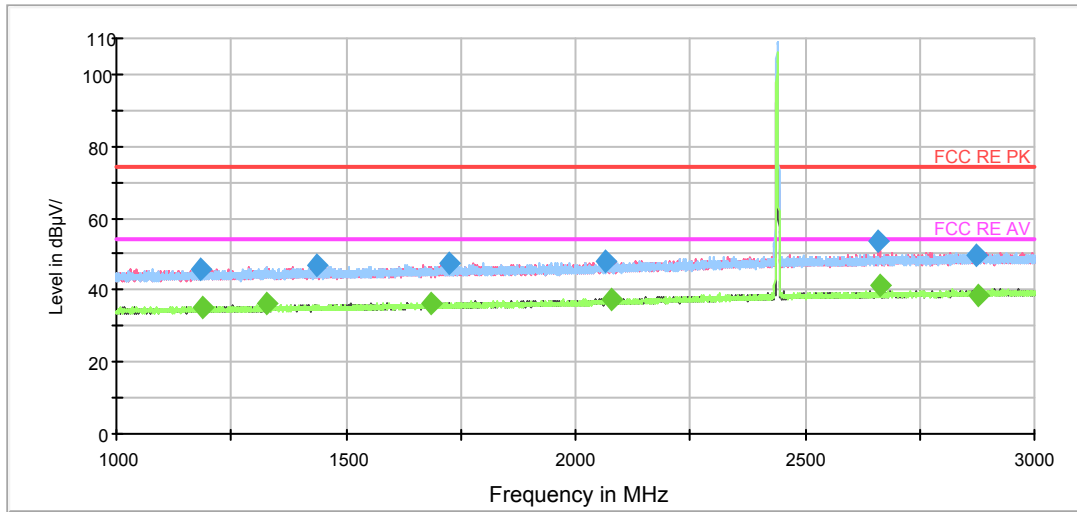

Note: The signal beyond the limit is carrier.
Radiates Emission from 1GHz to 3GHz

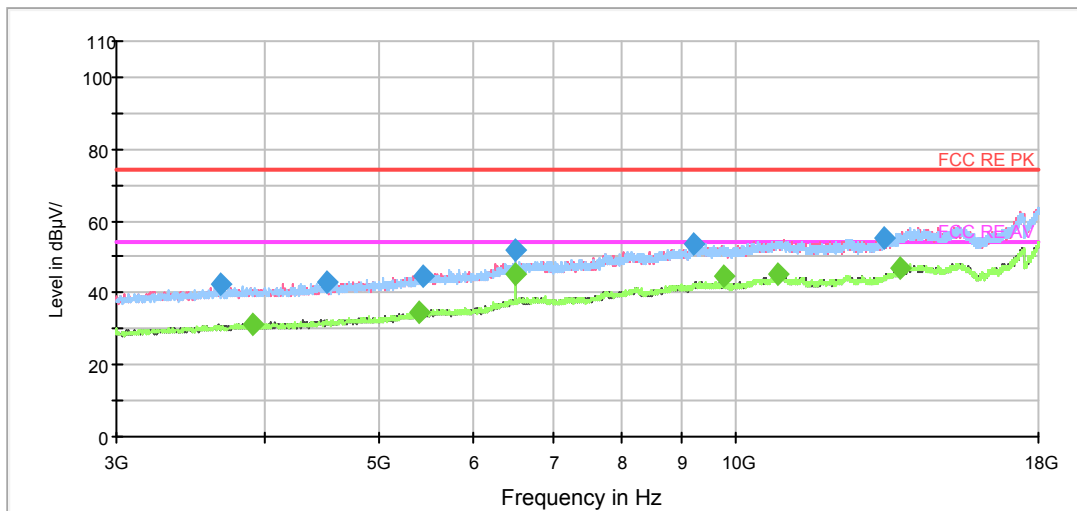

Radiates Emission from 3GHz to 18GHz

Frequency (MHz)	Peak (dBuV/m)	Height (cm)	Polarization	Azimuth (deg)	Correct Factor (dB)	Margin (dB)	Limit (dBuV/m)
1182.500000	46.0	200.0	V	257.0	-1.3	28.0	74.0
1438.750000	46.8	100.0	V	338.0	-0.6	27.2	74.0
1726.750000	47.2	200.0	V	226.0	0.4	26.8	74.0
2066.250000	48.0	100.0	H	1.0	1.5	26.0	74.0
2661.250000	53.4	100.0	V	224.0	3.9	20.6	74.0
2871.250000	49.6	100.0	V	252.0	4.4	24.4	74.0

Remark: 1. Correction Factor = Antenna factor+ Insertion loss (cable loss + amplifier gain)

Frequency (MHz)	Average (dBuV/m)	Height (cm)	Polarization	Azimuth (deg)	Correct Factor (dB)	Margin (dB)	Limit (dBuV/m)
1186.500000	35.4	100.0	V	0.0	-1.3	18.6	54.0
1327.750000	36.4	200.0	V	97.0	-0.9	17.6	54.0
1683.500000	36.5	200.0	H	358.0	0.3	17.5	54.0
2078.750000	37.4	200.0	V	0.0	1.5	16.6	54.0
2663.250000	41.2	100.0	V	214.0	3.9	12.8	54.0
2876.750000	38.6	100.0	V	243.0	4.5	15.4	54.0

Remark: 1. Correction Factor = Antenna factor+ Insertion loss (cable loss + amplifier gain)

BT UHD 2M $\pi/4$ -DQPSK -2478MHz

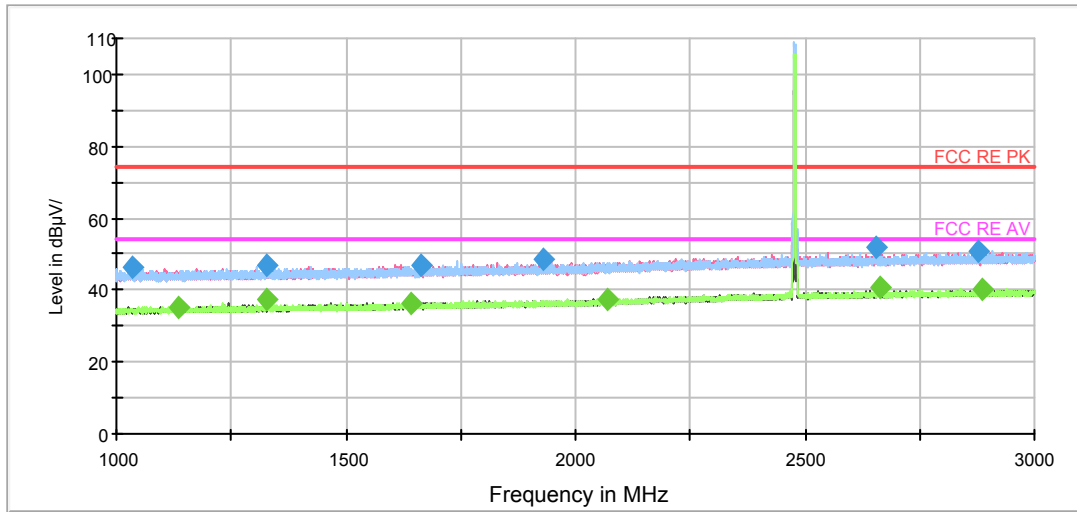

Note: The signal beyond the limit is carrier.
Radiates Emission from 1GHz to 3GHz

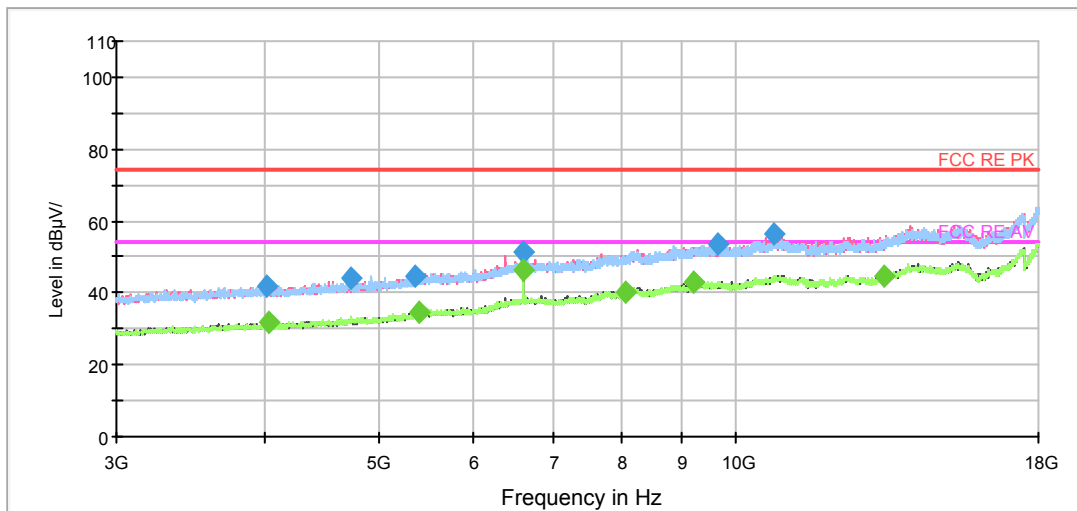

Radiates Emission from 3GHz to 18GHz

Frequency (MHz)	Peak (dBuV/m)	Height (cm)	Polarization	Azimuth (deg)	Correct Factor (dB)	Margin (dB)	Limit (dBuV/m)
1035.500000	46.3	100.0	V	358.0	-1.7	27.7	74.0
1328.750000	46.8	100.0	V	8.0	-0.9	27.2	74.0
1664.750000	46.8	200.0	V	18.0	0.2	27.2	74.0
1929.250000	48.4	200.0	V	170.0	1.0	25.6	74.0
2655.000000	51.9	200.0	V	188.0	3.9	22.1	74.0
2879.250000	50.7	100.0	H	11.0	4.5	23.3	74.0

Remark: 1. Correction Factor = Antenna factor+ Insertion loss (cable loss + amplifier gain)

Frequency (MHz)	Average (dBuV/m)	Height (cm)	Polarization	Azimuth (deg)	Correct Factor (dB)	Margin (dB)	Limit (dBuV/m)
1135.750000	35.4	100.0	V	0.0	-1.3	18.6	54.0
1328.750000	37.2	100.0	V	8.0	-0.9	16.8	54.0
1639.750000	36.5	100.0	H	116.0	0.1	17.5	54.0
2068.500000	37.4	200.0	V	0.0	1.5	16.6	54.0
2665.000000	40.9	200.0	V	216.0	3.9	13.1	54.0
2887.500000	40.0	100.0	H	4.0	4.5	14.0	54.0

Remark: 1. Correction Factor = Antenna factor+ Insertion loss (cable loss + amplifier gain)

BT UHD 2M 8DPSK -2404MHz

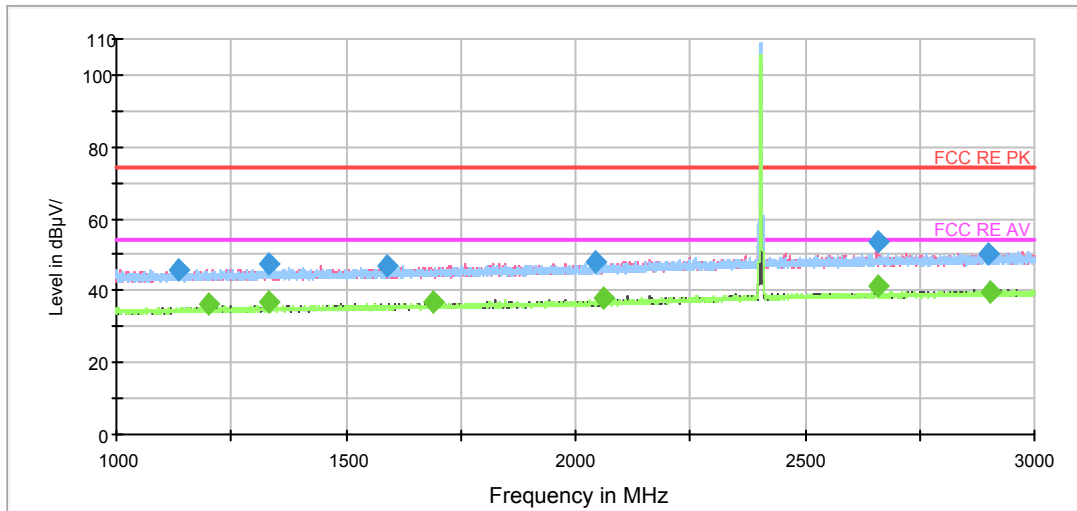

Note: The signal beyond the limit is carrier.
Radiates Emission from 1GHz to 3GHz

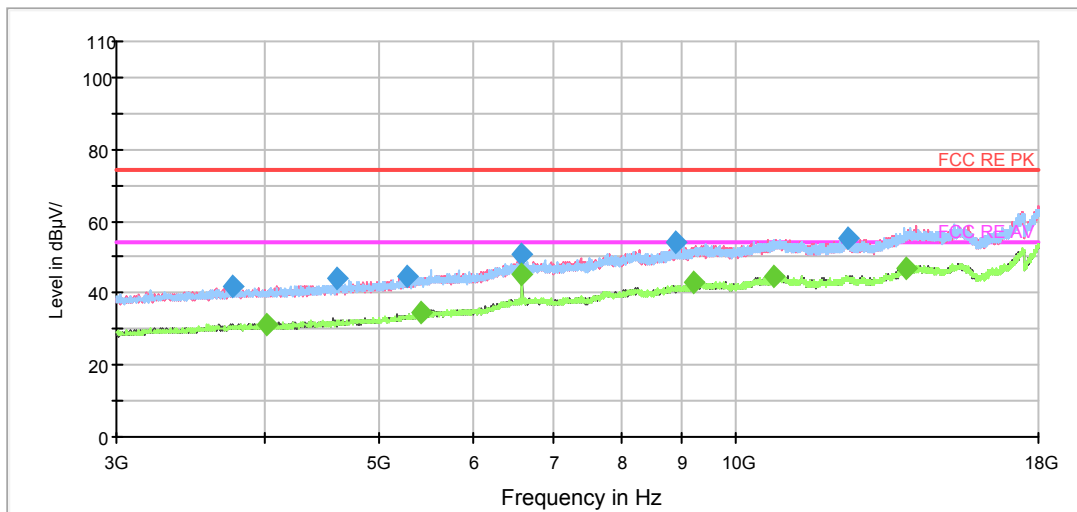

Radiates Emission from 3GHz to 18GHz

Frequency (MHz)	Peak (dBuV/m)	Height (cm)	Polarization	Azimuth (deg)	Correct Factor (dB)	Margin (dB)	Limit (dBuV/m)
1137.500000	46.0	200.0	H	353.0	-1.3	28.0	74.0
1332.750000	47.5	200.0	V	102.0	-0.9	26.5	74.0
1589.250000	47.2	200.0	V	63.0	-0.1	26.8	74.0
2045.250000	48.2	100.0	H	101.0	1.4	25.8	74.0
2659.000000	53.6	100.0	V	223.0	3.9	20.4	74.0
2899.500000	50.1	100.0	V	48.0	4.5	23.9	74.0

Remark: 1. Correction Factor = Antenna factor+ Insertion loss (cable loss + amplifier gain)

Frequency (MHz)	Average (dBuV/m)	Height (cm)	Polarization	Azimuth (deg)	Correct Factor (dB)	Margin (dB)	Limit (dBuV/m)
1199.250000	36.1	200.0	V	192.0	-1.2	17.9	54.0
1332.750000	36.9	200.0	V	102.0	-0.9	17.1	54.0
1688.500000	36.7	200.0	H	0.0	0.4	17.3	54.0
2059.000000	37.8	200.0	H	234.0	1.4	16.2	54.0
2659.250000	41.3	100.0	V	193.0	3.9	12.7	54.0
2902.000000	39.8	200.0	V	351.0	4.5	14.2	54.0

Remark: 1. Correction Factor = Antenna factor+ Insertion loss (cable loss + amplifier gain)

BT UHD 2M 8DPSK -2440MHz

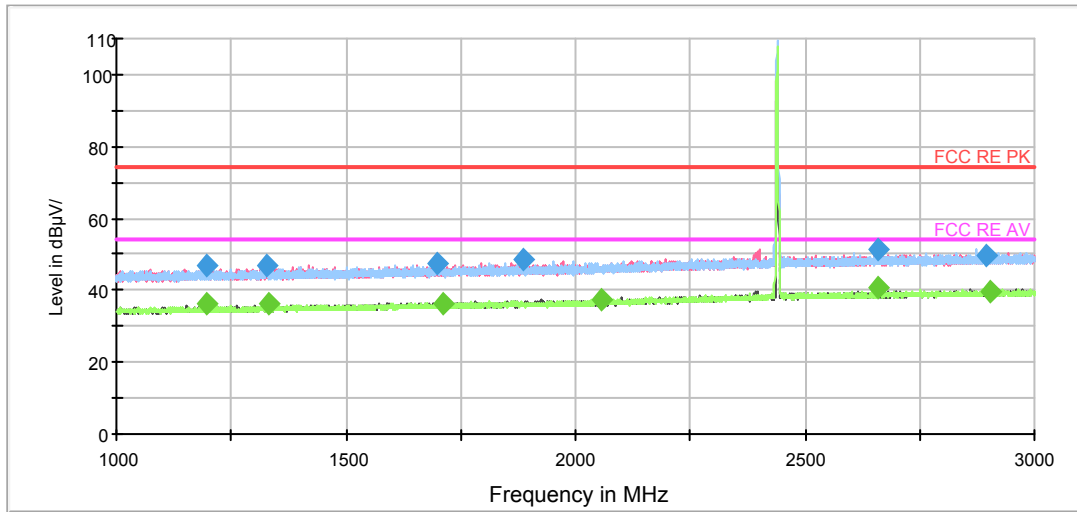

Note: The signal beyond the limit is carrier.
Radiates Emission from 1GHz to 3GHz

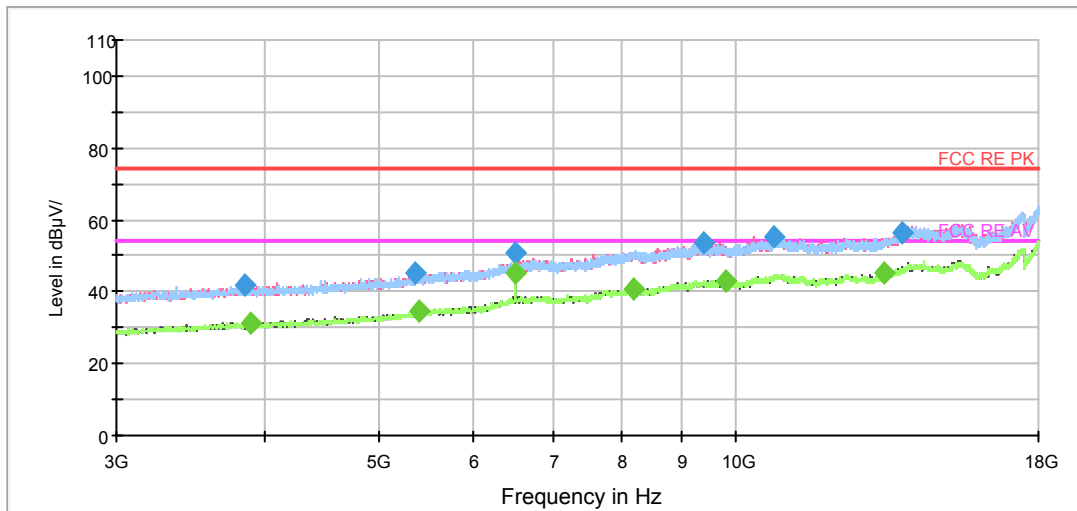

Radiates Emission from 3GHz to 18GHz



Frequency (MHz)	Peak (dBuV/m)	Height (cm)	Polarization	Azimuth (deg)	Correct Factor (dB)	Margin (dB)	Limit (dBuV/m)
1196.750000	46.7	200.0	V	18.0	-1.2	27.3	74.0
1328.250000	46.7	100.0	V	71.0	-0.9	27.3	74.0
1698.750000	47.2	100.0	V	338.0	0.4	26.8	74.0
1888.250000	48.4	200.0	H	302.0	0.8	25.6	74.0
2660.000000	51.4	200.0	V	66.0	3.9	22.6	74.0
2895.000000	49.6	200.0	H	273.0	4.5	24.4	74.0

Remark: 1. Correction Factor = Antenna factor+ Insertion loss (cable loss + amplifier gain)

Frequency (MHz)	Average (dBuV/m)	Height (cm)	Polarization	Azimuth (deg)	Correct Factor (dB)	Margin (dB)	Limit (dBuV/m)
1196.750000	36.1	200.0	V	18.0	-1.2	17.9	54.0
1332.750000	36.1	200.0	V	164.0	-0.9	17.9	54.0
1713.500000	36.5	100.0	H	236.0	0.4	17.5	54.0
2057.750000	37.6	100.0	H	0.0	1.4	16.4	54.0
2658.500000	40.8	100.0	V	194.0	3.9	13.2	54.0
2903.000000	39.5	100.0	V	312.0	4.5	14.5	54.0

Remark: 1. Correction Factor = Antenna factor+ Insertion loss (cable loss + amplifier gain)

BT UHD 2M 8DPSK -2478MHz

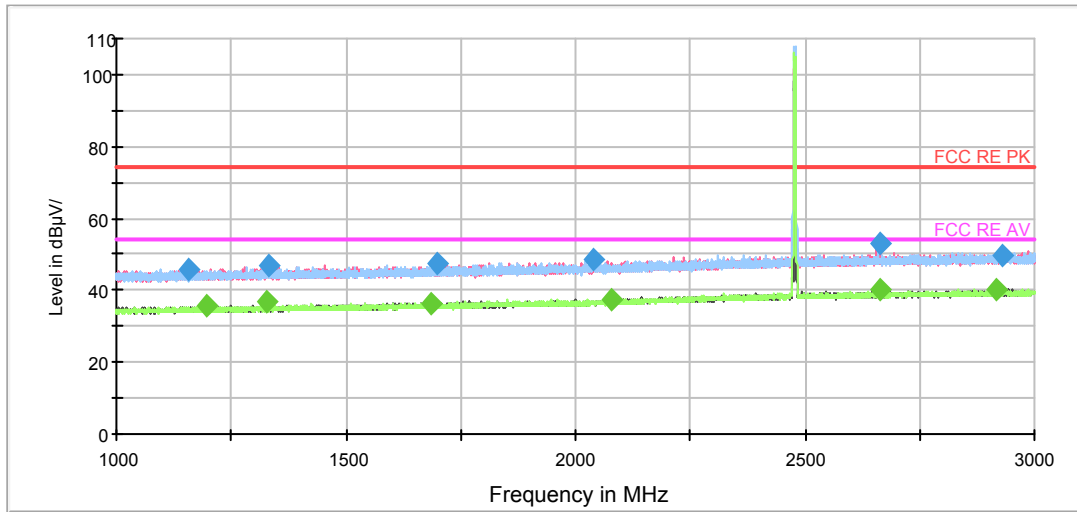

Note: The signal beyond the limit is carrier.
Radiates Emission from 1GHz to 3GHz

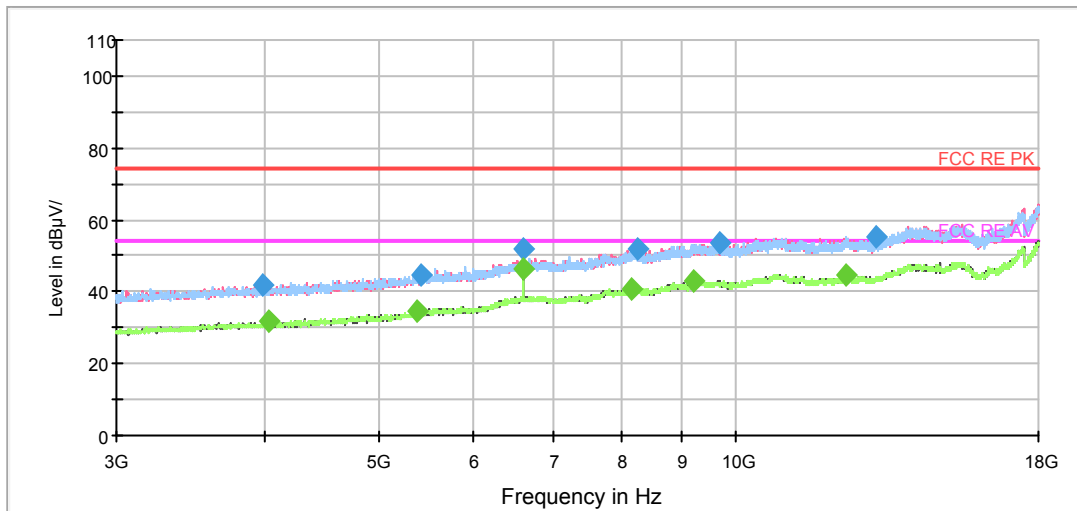

Radiates Emission from 3GHz to 18GHz

Frequency (MHz)	Peak (dBuV/m)	Height (cm)	Polarization	Azimuth (deg)	Correct Factor (dB)	Margin (dB)	Limit (dBuV/m)
1157.500000	46.0	100.0	H	258.0	-1.3	28.0	74.0
1333.500000	46.7	100.0	V	278.0	-0.9	27.3	74.0
1697.500000	47.3	100.0	H	5.0	0.4	26.7	74.0
2038.250000	48.3	200.0	V	8.0	1.3	25.7	74.0
2661.750000	52.8	100.0	V	220.0	3.9	21.2	74.0
2929.500000	49.8	200.0	H	357.0	4.6	24.2	74.0

Remark: 1. Correction Factor = Antenna factor+ Insertion loss (cable loss + amplifier gain)

Frequency (MHz)	Average (dBuV/m)	Height (cm)	Polarization	Azimuth (deg)	Correct Factor (dB)	Margin (dB)	Limit (dBuV/m)
1198.250000	35.8	100.0	V	358.0	-1.2	18.2	54.0
1327.750000	37.1	100.0	V	20.0	-0.9	16.9	54.0
1683.750000	36.5	100.0	V	334.0	0.3	17.5	54.0
2078.250000	37.4	100.0	V	351.0	1.5	16.6	54.0
2664.250000	40.0	200.0	V	179.0	3.9	14.0	54.0
2918.500000	40.5	100.0	V	288.0	4.6	13.5	54.0

Remark: 1. Correction Factor = Antenna factor+ Insertion loss (cable loss + amplifier gain)

BT UHD 4M $\pi/4$ -DQPSK -2404MHz

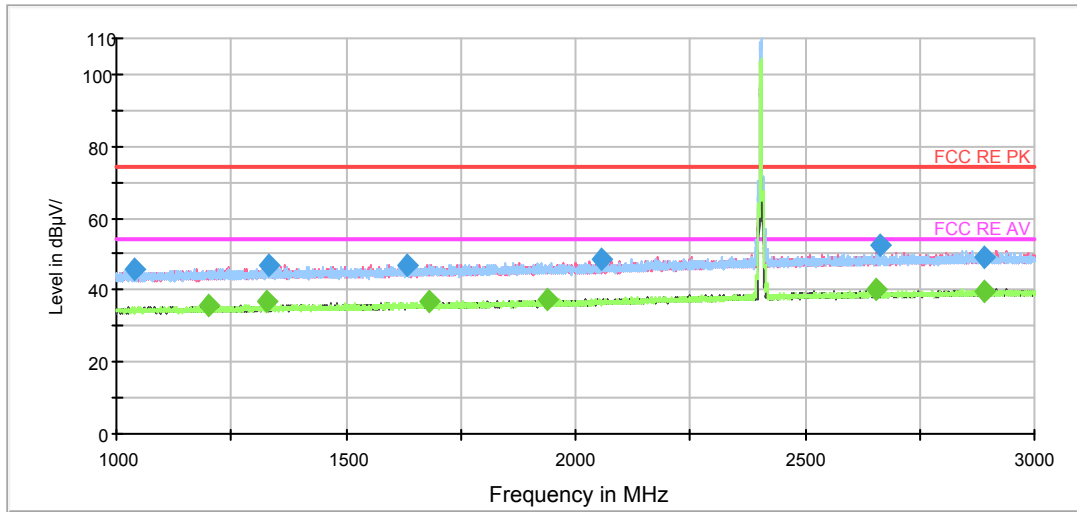

Note: The signal beyond the limit is carrier.
Radiates Emission from 1GHz to 3GHz

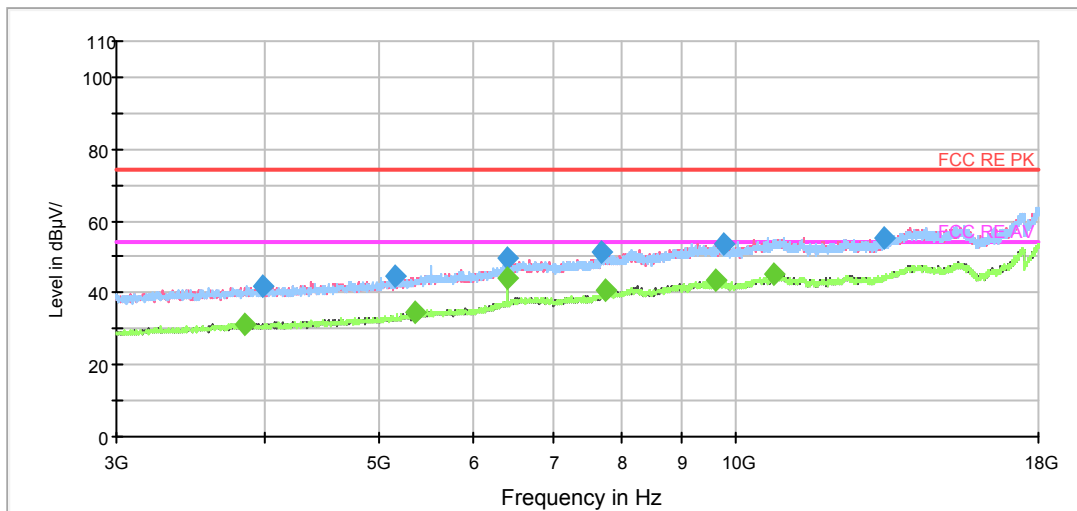

Radiates Emission from 3GHz to 18GHz

Frequency (MHz)	Peak (dBuV/m)	Height (cm)	Polarization	Azimuth (deg)	Correct Factor (dB)	Margin (dB)	Limit (dBuV/m)
1040.000000	46.0	100.0	V	173.0	-1.7	28.0	74.0
1333.250000	47.1	100.0	V	7.0	-0.9	26.9	74.0
1632.750000	47.1	200.0	H	328.0	0.1	26.9	74.0
2057.000000	48.4	200.0	H	132.0	1.4	25.6	74.0
2661.750000	52.5	200.0	V	158.0	3.9	21.5	74.0
2888.750000	49.2	100.0	H	50.0	4.5	24.8	74.0

Remark: 1. Correction Factor = Antenna factor+ Insertion loss (cable loss + amplifier gain)

Frequency (MHz)	Average (dBuV/m)	Height (cm)	Polarization	Azimuth (deg)	Correct Factor (dB)	Margin (dB)	Limit (dBuV/m)
1199.750000	35.5	100.0	H	178.0	-1.2	18.5	54.0
1329.000000	36.7	100.0	V	20.0	-0.9	17.3	54.0
1679.250000	36.6	100.0	H	238.0	0.3	17.4	54.0
1937.750000	37.5	100.0	H	148.0	1.0	16.5	54.0
2655.000000	40.4	100.0	V	233.0	3.9	13.6	54.0
2890.500000	39.5	200.0	V	148.0	4.5	14.5	54.0

Remark: 1. Correction Factor = Antenna factor+ Insertion loss (cable loss + amplifier gain)

BT UHD 4M $\pi/4$ -DQPSK -2440MHz

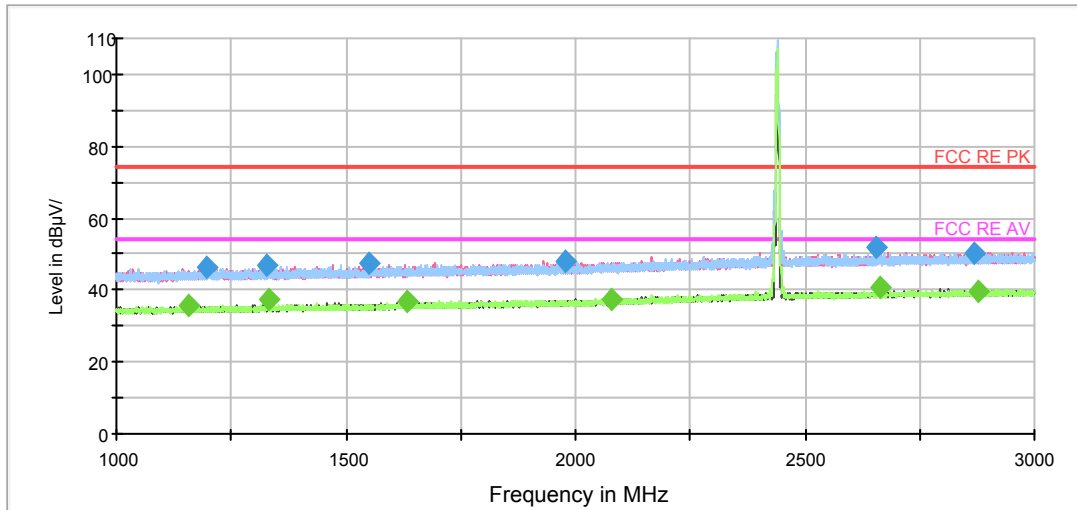

Note: The signal beyond the limit is carrier.
Radiates Emission from 1GHz to 3GHz

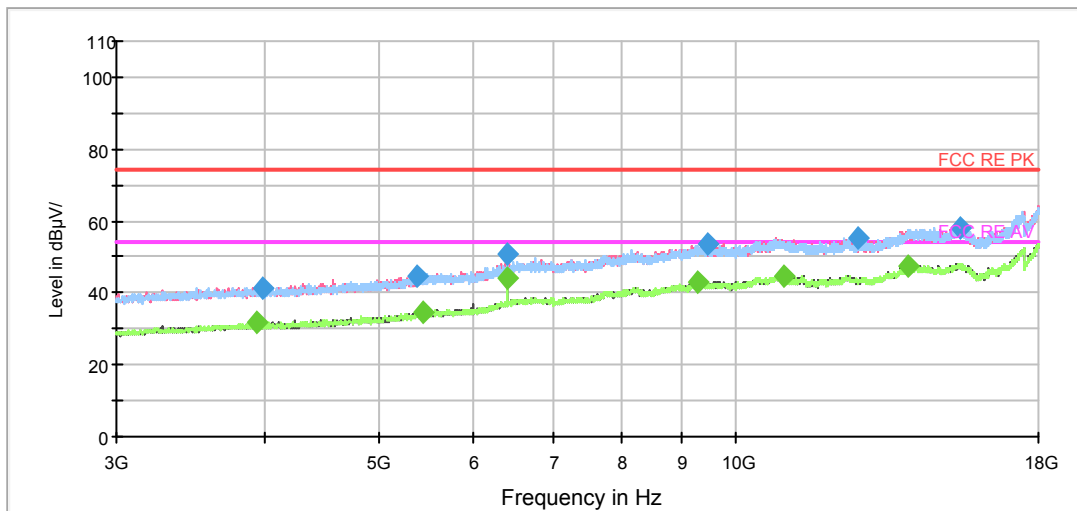

Radiates Emission from 3GHz to 18GHz

Frequency (MHz)	Peak (dBuV/m)	Height (cm)	Polarization	Azimuth (deg)	Correct Factor (dB)	Margin (dB)	Limit (dBuV/m)
1198.500000	46.5	200.0	H	331.0	-1.2	27.5	74.0
1326.500000	46.9	200.0	H	212.0	-0.9	27.1	74.0
1551.000000	47.5	100.0	H	216.0	-0.2	26.5	74.0
1976.750000	47.8	200.0	V	0.0	1.1	26.2	74.0
2656.750000	52.1	100.0	V	221.0	3.9	21.9	74.0
2870.250000	50.1	200.0	H	331.0	4.4	23.9	74.0

Remark: 1. Correction Factor = Antenna factor+ Insertion loss (cable loss + amplifier gain)

Frequency (MHz)	Average (dBuV/m)	Height (cm)	Polarization	Azimuth (deg)	Correct Factor (dB)	Margin (dB)	Limit (dBuV/m)
1158.500000	35.5	100.0	H	15.0	-1.3	18.5	54.0
1331.750000	37.6	200.0	H	241.0	-0.9	16.4	54.0
1633.250000	36.8	200.0	H	344.0	0.1	17.2	54.0
2078.250000	37.6	100.0	H	116.0	1.5	16.4	54.0
2665.750000	40.5	200.0	V	188.0	3.9	13.5	54.0
2876.000000	39.5	200.0	H	212.0	4.5	14.5	54.0

Remark: 1. Correction Factor = Antenna factor+ Insertion loss (cable loss + amplifier gain)

BT UHD 4M $\pi/4$ -DQPSK -2476MHz

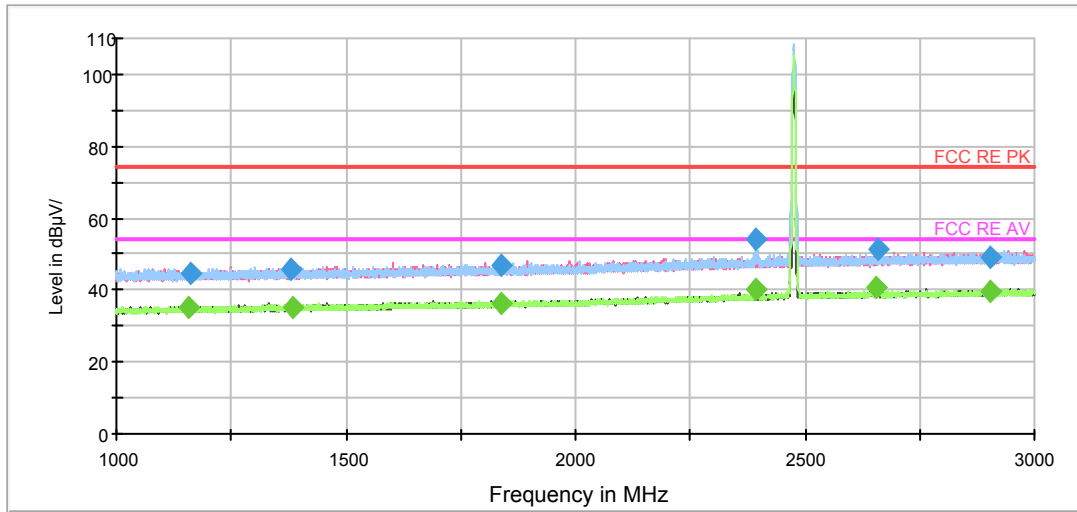

Note: The signal beyond the limit is carrier.
Radiates Emission from 1GHz to 3GHz

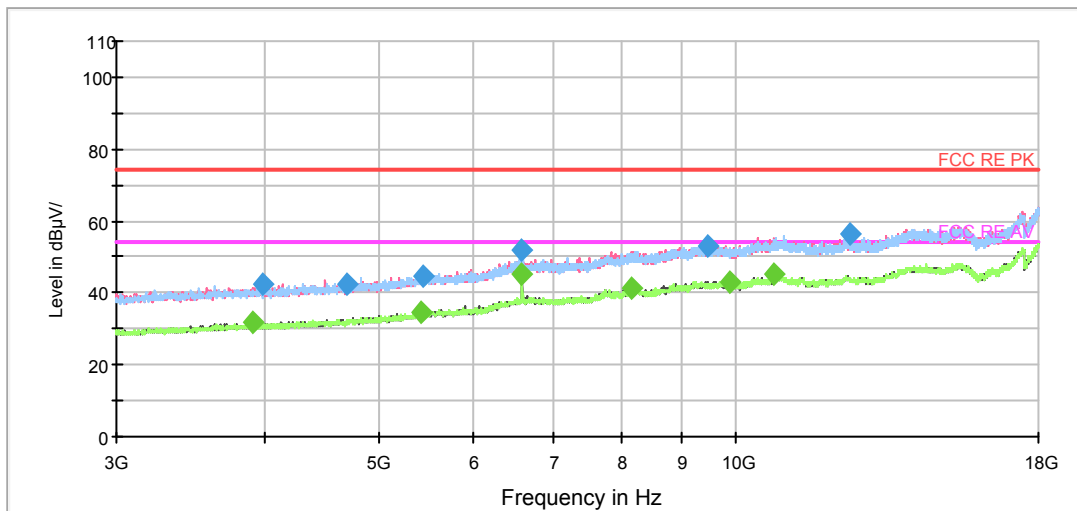

Radiates Emission from 3GHz to 18GHz

Frequency (MHz)	Peak (dBuV/m)	Height (cm)	Polarization	Azimuth (deg)	Correct Factor (dB)	Margin (dB)	Limit (dBuV/m)
1162.250000	44.6	100.0	H	0.0	-1.3	29.4	74.0
1378.000000	45.5	200.0	H	328.0	-0.7	28.5	74.0
1838.000000	46.7	200.0	H	336.0	0.7	27.3	74.0
2394.750000	54.2	100.0	H	147.0	3.2	19.8	74.0
2657.750000	51.5	100.0	V	300.0	3.9	22.5	74.0
2901.750000	49.3	100.0	V	232.0	4.5	24.7	74.0

Remark: 1. Correction Factor = Antenna factor+ Insertion loss (cable loss + amplifier gain)

Frequency (MHz)	Average (dBuV/m)	Height (cm)	Polarization	Azimuth (deg)	Correct Factor (dB)	Margin (dB)	Limit (dBuV/m)
1158.750000	35.2	100.0	H	0.0	-1.3	18.8	54.0
1382.500000	35.4	100.0	V	242.0	-0.7	18.6	54.0
1838.750000	36.4	200.0	V	68.0	0.7	17.6	54.0
2394.750000	40.4	100.0	H	147.0	3.2	13.6	54.0
2656.000000	40.7	100.0	V	222.0	3.9	13.3	54.0
2905.250000	39.8	100.0	H	248.0	4.5	14.2	54.0

Remark: 1. Correction Factor = Antenna factor+ Insertion loss (cable loss + amplifier gain)

BT UHD BLE 1M GFSK -2404MHz

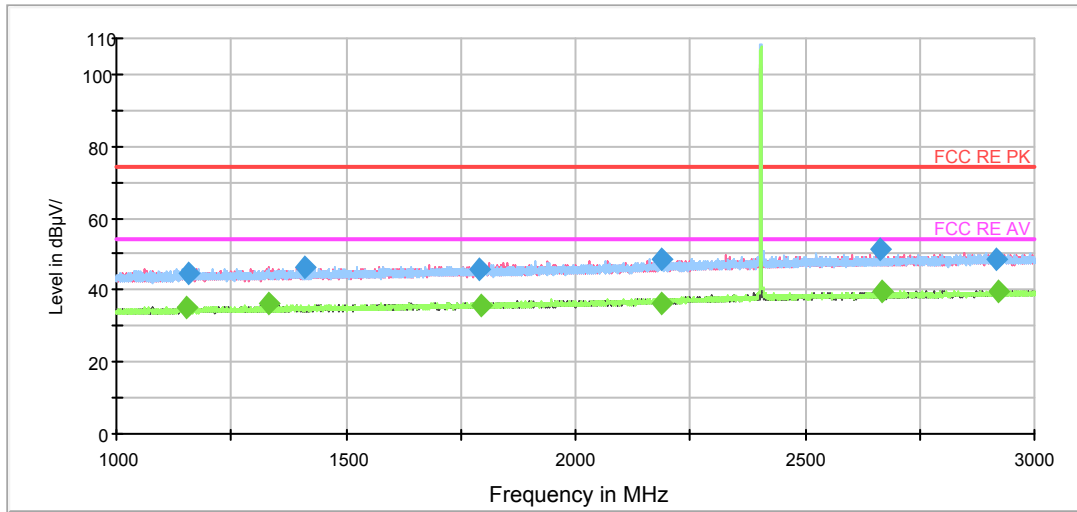

Note: The signal beyond the limit is carrier.
Radiates Emission from 1GHz to 3GHz

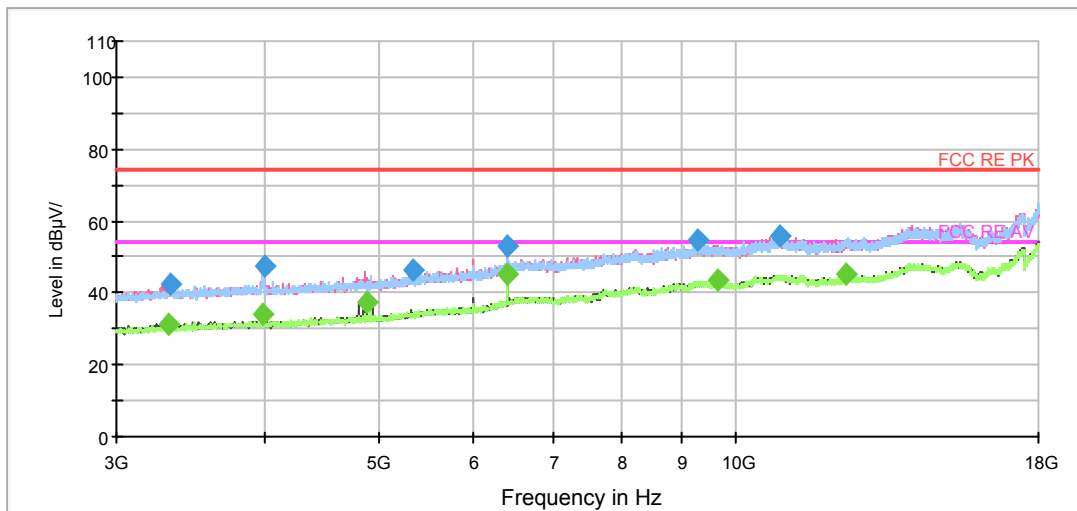

Radiates Emission from 3GHz to 18GHz

Frequency (MHz)	Peak (dBuV/m)	Height (cm)	Polarization	Azimuth (deg)	Correct Factor (dB)	Margin (dB)	Limit (dBuV/m)
1156.250000	44.9	100.0	H	129.0	-1.3	29.1	74.0
1410.750000	46.3	100.0	V	359.0	-0.7	27.7	74.0
1792.000000	45.9	100.0	H	4.0	0.6	28.1	74.0
2189.000000	48.3	200.0	H	314.0	2.2	25.7	74.0
2663.500000	51.6	200.0	V	178.0	3.9	22.4	74.0
2917.000000	48.8	100.0	V	251.0	4.5	25.2	74.0

Remark: 1. Correction Factor = Antenna factor+ Insertion loss (cable loss + amplifier gain)

Frequency (MHz)	Average (dBuV/m)	Height (cm)	Polarization	Azimuth (deg)	Correct Factor (dB)	Margin (dB)	Limit (dBuV/m)
1153.500000	35.0	200.0	H	216.0	-1.3	19.0	54.0
1331.750000	36.4	100.0	V	7.0	-0.9	17.6	54.0
1796.250000	35.6	200.0	V	1.0	0.6	18.4	54.0
2187.250000	36.5	100.0	V	0.0	2.1	17.5	54.0
2669.250000	39.5	100.0	V	356.0	3.9	14.5	54.0
2920.000000	39.5	200.0	V	0.0	4.6	14.5	54.0

Remark: 1. Correction Factor = Antenna factor+ Insertion loss (cable loss + amplifier gain)

BT UHD BLE 1M GFSK -2440MHz

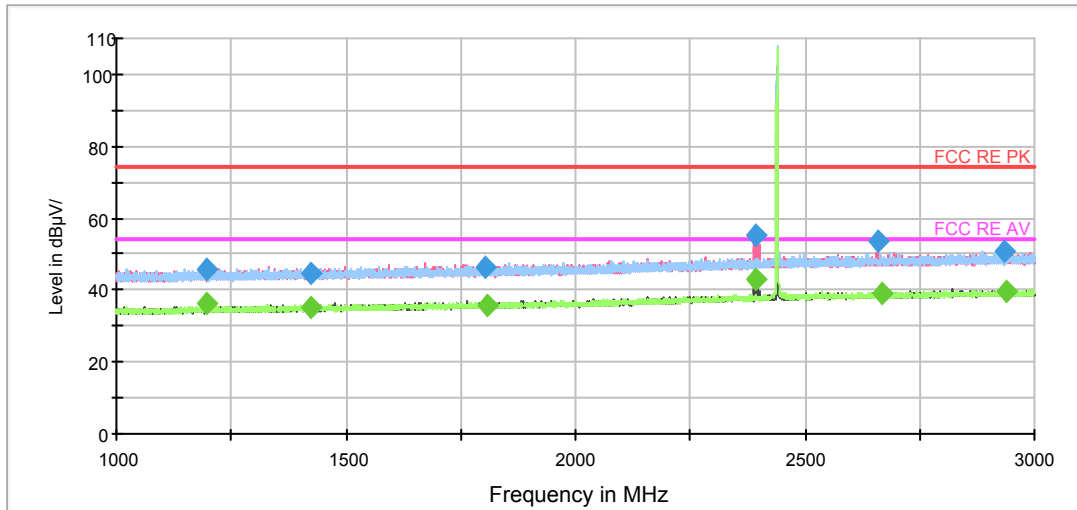

Note: The signal beyond the limit is carrier.
Radiates Emission from 1GHz to 3GHz

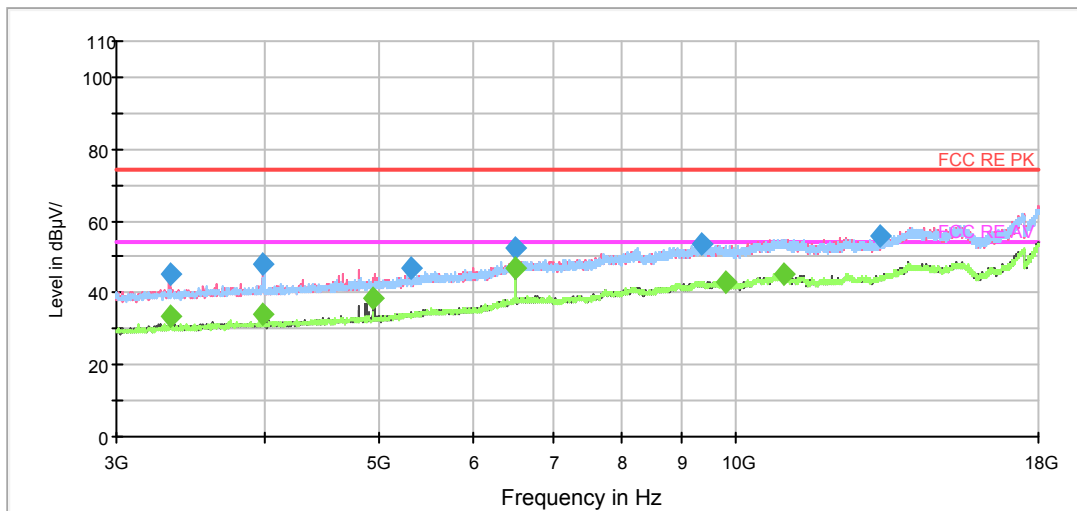

Radiates Emission from 3GHz to 18GHz

Frequency (MHz)	Peak (dBuV/m)	Height (cm)	Polarization	Azimuth (deg)	Correct Factor (dB)	Margin (dB)	Limit (dBuV/m)
1196.750000	45.5	100.0	V	2.0	-1.2	28.5	74.0
1423.500000	44.8	200.0	V	218.0	-0.6	29.2	74.0
1803.750000	46.2	200.0	H	142.0	0.6	27.8	74.0
2391.250000	55.5	200.0	V	352.0	3.2	18.5	74.0
2661.250000	53.7	100.0	V	197.0	3.9	20.3	74.0
2933.250000	51.0	200.0	V	23.0	4.6	23.0	74.0

Remark: 1. Correction Factor = Antenna factor+ Insertion loss (cable loss + amplifier gain)

Frequency (MHz)	Average (dBuV/m)	Height (cm)	Polarization	Azimuth (deg)	Correct Factor (dB)	Margin (dB)	Limit (dBuV/m)
1196.250000	36.5	100.0	V	2.0	-1.2	17.5	54.0
1425.750000	35.4	100.0	V	0.0	-0.6	18.6	54.0
1806.000000	35.9	200.0	V	12.0	0.6	18.1	54.0
2391.250000	42.8	200.0	V	352.0	3.2	11.2	54.0
2668.500000	39.1	200.0	H	122.0	3.9	14.9	54.0
2938.500000	39.5	100.0	H	89.0	4.7	14.5	54.0

Remark: 1. Correction Factor = Antenna factor+ Insertion loss (cable loss + amplifier gain)

BT UHD BLE 1M GFSK -2478MHz

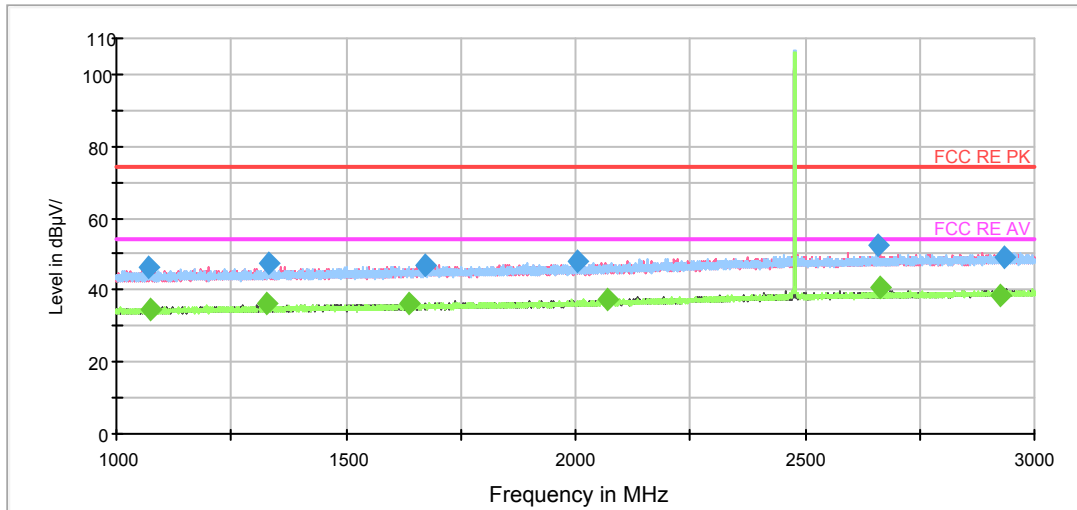

Note: The signal beyond the limit is carrier.
Radiates Emission from 1GHz to 3GHz

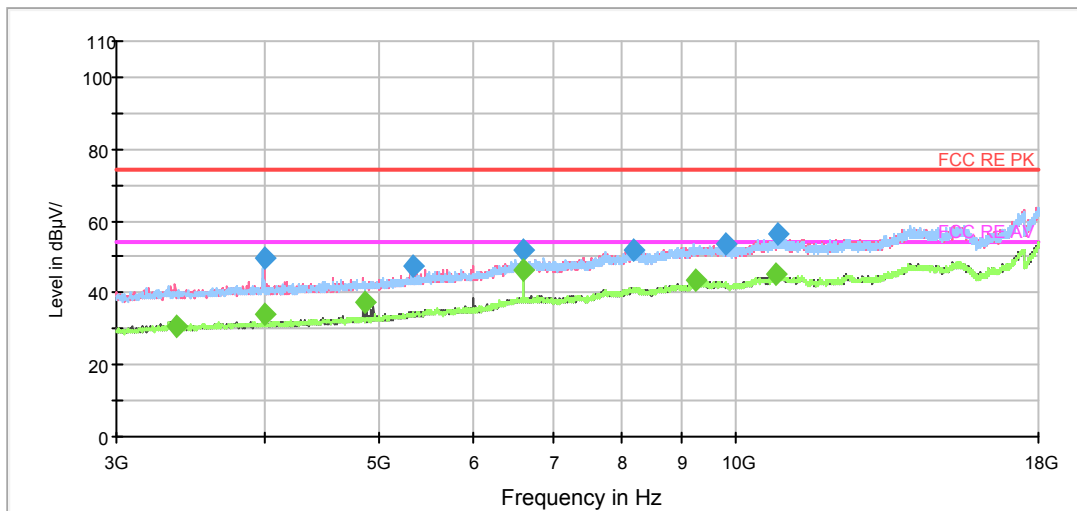

Radiates Emission from 3GHz to 18GHz

Frequency (MHz)	Peak (dBuV/m)	Height (cm)	Polarization	Azimuth (deg)	Correct Factor (dB)	Margin (dB)	Limit (dBuV/m)
1072.000000	46.4	100.0	V	359.0	-1.5	27.6	74.0
1333.250000	47.5	100.0	V	252.0	-0.9	26.5	74.0
1672.750000	46.9	200.0	V	2.0	0.3	27.1	74.0
2003.250000	47.8	200.0	H	315.0	1.1	26.2	74.0
2661.500000	52.3	200.0	V	187.0	3.9	21.7	74.0
2935.750000	49.1	200.0	V	238.0	4.7	24.9	74.0

Remark: 1. Correction Factor = Antenna factor+ Insertion loss (cable loss + amplifier gain)

Frequency (MHz)	Average (dBuV/m)	Height (cm)	Polarization	Azimuth (deg)	Correct Factor (dB)	Margin (dB)	Limit (dBuV/m)
1076.000000	34.4	200.0	V	114.0	-1.5	19.6	54.0
1327.750000	36.3	200.0	V	0.0	-0.9	17.7	54.0
1636.000000	36.4	200.0	V	358.0	0.1	17.6	54.0
2068.500000	37.6	200.0	H	346.0	1.5	16.4	54.0
2662.250000	40.6	100.0	V	202.0	3.9	13.4	54.0
2927.250000	38.6	200.0	V	74.0	4.6	15.4	54.0

Remark: 1. Correction Factor = Antenna factor+ Insertion loss (cable loss + amplifier gain)

BT UHD BLE 2M GFSK -2404MHz

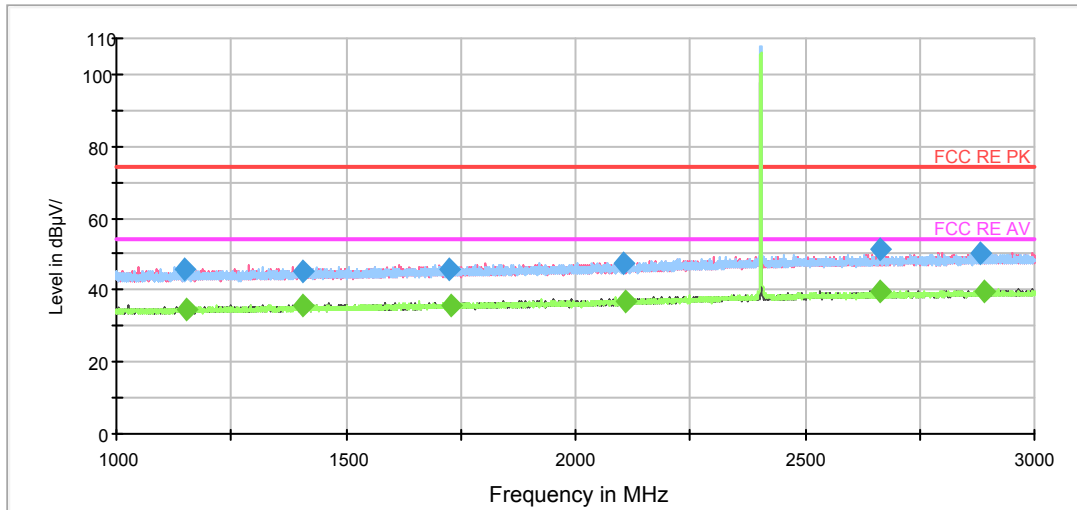

Note: The signal beyond the limit is carrier.
Radiates Emission from 1GHz to 3GHz

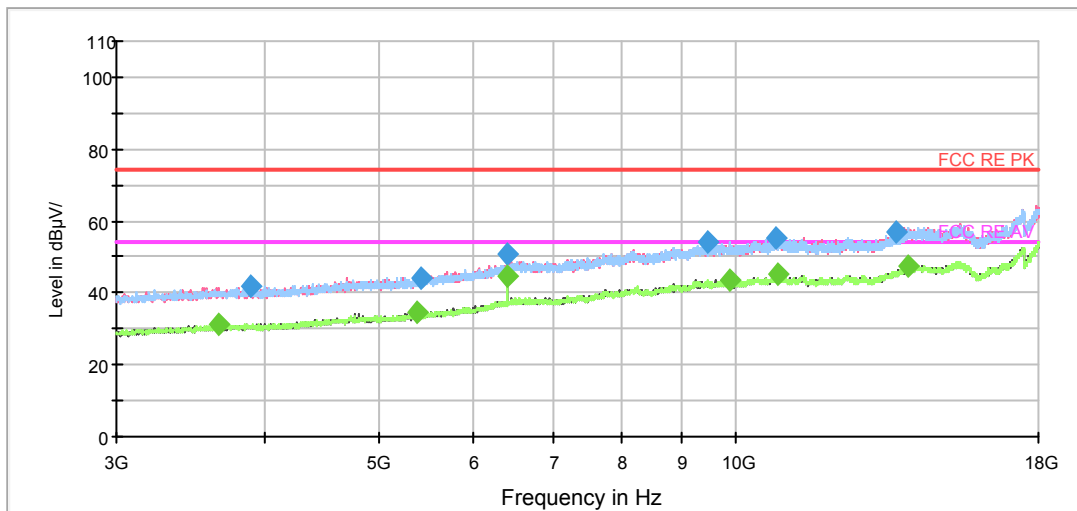

Radiates Emission from 3GHz to 18GHz

Frequency (MHz)	Peak (dBuV/m)	Height (cm)	Polarization	Azimuth (deg)	Correct Factor (dB)	Margin (dB)	Limit (dBuV/m)
1148.000000	45.6	200.0	V	0.0	-1.3	28.4	74.0
1406.000000	45.1	200.0	H	238.0	-0.7	28.9	74.0
1724.250000	45.6	200.0	H	341.0	0.4	28.4	74.0
2103.250000	47.2	100.0	V	203.0	1.7	26.8	74.0
2664.750000	51.3	100.0	V	153.0	3.9	22.7	74.0
2881.750000	50.3	100.0	H	11.0	4.5	23.7	74.0

Remark: 1. Correction Factor = Antenna factor+ Insertion loss (cable loss + amplifier gain)

Frequency (MHz)	Average (dBuV/m)	Height (cm)	Polarization	Azimuth (deg)	Correct Factor (dB)	Margin (dB)	Limit (dBuV/m)
1150.750000	34.7	200.0	H	315.0	-1.3	19.3	54.0
1404.750000	35.5	100.0	H	279.0	-0.7	18.5	54.0
1729.500000	35.6	200.0	V	248.0	0.5	18.4	54.0
2110.750000	37.1	200.0	V	0.0	1.7	16.9	54.0
2664.750000	39.8	100.0	V	153.0	3.9	14.2	54.0
2891.750000	39.4	200.0	V	5.0	4.5	14.6	54.0

Remark: 1. Correction Factor = Antenna factor+ Insertion loss (cable loss + amplifier gain)

BT UHD BLE 2M GFSK -2440MHz

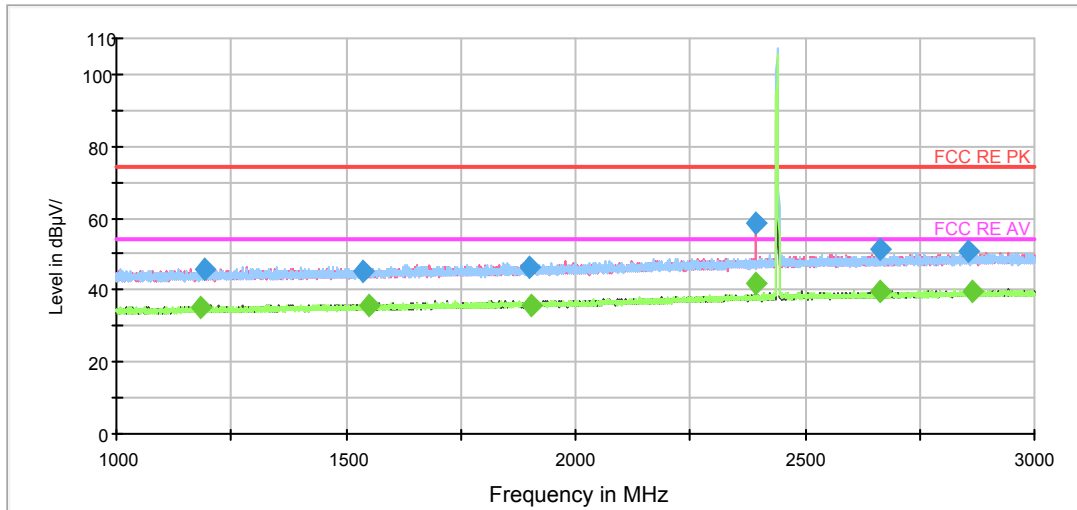

Note: The signal beyond the limit is carrier.
Radiates Emission from 1GHz to 3GHz

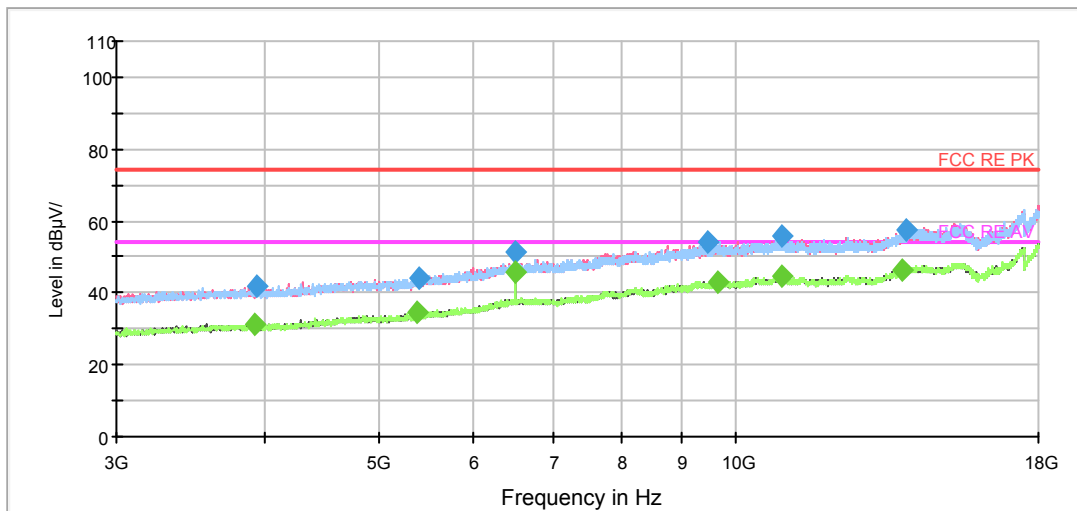

Radiates Emission from 3GHz to 18GHz

Frequency (MHz)	Peak (dBuV/m)	Height (cm)	Polarization	Azimuth (deg)	Correct Factor (dB)	Margin (dB)	Limit (dBuV/m)
1191.250000	46.0	200.0	V	22.0	-1.2	28.0	74.0
1537.000000	45.2	200.0	V	16.0	-0.3	28.8	74.0
1900.500000	46.4	100.0	H	4.0	0.9	27.6	74.0
2392.250000	58.4	200.0	V	352.0	3.2	15.6	74.0
2665.000000	51.4	200.0	V	2.0	3.9	22.6	74.0
2855.250000	50.8	200.0	V	187.0	4.4	23.2	74.0

Remark: 1. Correction Factor = Antenna factor+ Insertion loss (cable loss + amplifier gain)

Frequency (MHz)	Average (dBuV/m)	Height (cm)	Polarization	Azimuth (deg)	Correct Factor (dB)	Margin (dB)	Limit (dBuV/m)
1184.250000	35.0	100.0	H	11.0	-1.3	19.0	54.0
1549.750000	35.9	100.0	V	286.0	-0.2	18.1	54.0
1905.500000	35.9	200.0	V	2.0	0.9	18.1	54.0
2392.250000	41.7	200.0	V	352.0	3.2	12.3	54.0
2665.000000	39.5	100.0	H	167.0	3.9	14.5	54.0
2865.750000	39.7	100.0	V	237.0	4.4	14.3	54.0

Remark: 1. Correction Factor = Antenna factor+ Insertion loss (cable loss + amplifier gain)

BT UHD BLE 2M GFSK -2478MHz

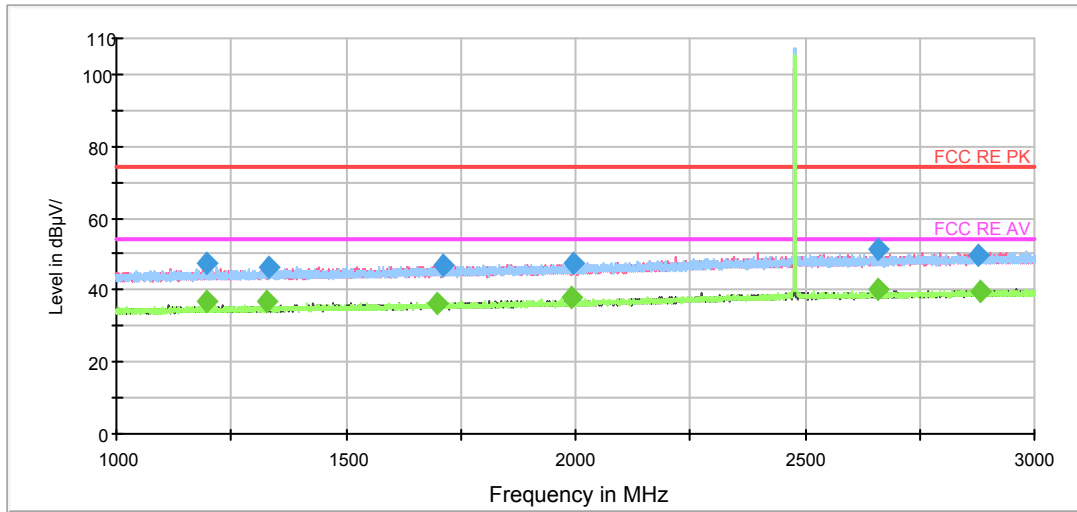

Note: The signal beyond the limit is carrier.
Radiates Emission from 1GHz to 3GHz

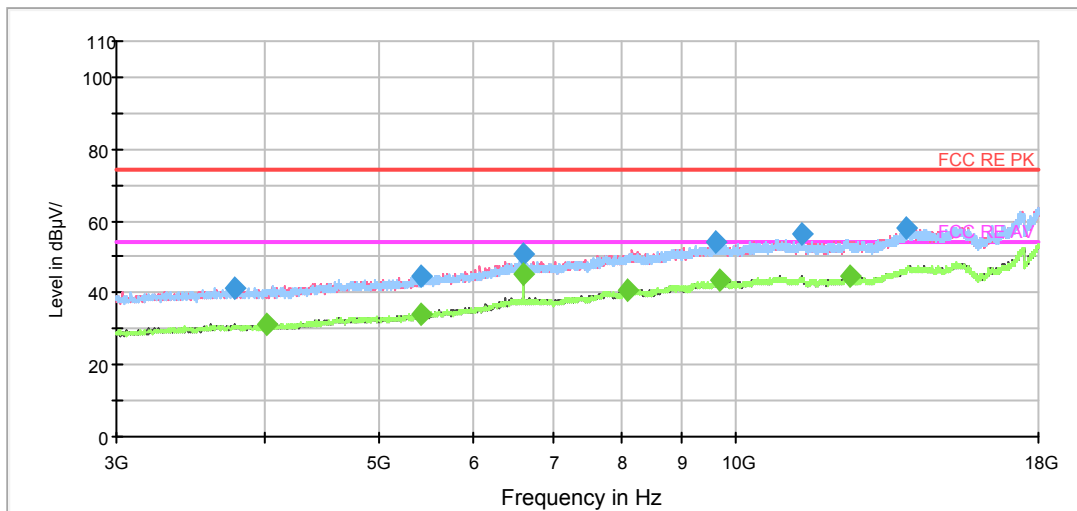

Radiates Emission from 3GHz to 18GHz

Frequency (MHz)	Peak (dBuV/m)	Height (cm)	Polarization	Azimuth (deg)	Correct Factor (dB)	Margin (dB)	Limit (dBuV/m)
1198.500000	47.6	200.0	V	5.0	-1.2	26.4	74.0
1330.500000	46.5	200.0	H	247.0	-0.9	27.5	74.0
1711.000000	46.7	200.0	H	178.0	0.4	27.3	74.0
1995.750000	47.7	200.0	V	280.0	1.1	26.3	74.0
2659.250000	51.3	100.0	V	344.0	3.9	22.7	74.0
2877.500000	49.8	200.0	V	48.0	4.5	24.2	74.0

Remark: 1. Correction Factor = Antenna factor+ Insertion loss (cable loss + amplifier gain)

Frequency (MHz)	Average (dBuV/m)	Height (cm)	Polarization	Azimuth (deg)	Correct Factor (dB)	Margin (dB)	Limit (dBuV/m)
1196.000000	37.0	200.0	V	7.0	-1.2	17.0	54.0
1328.000000	37.0	200.0	V	58.0	-0.9	17.0	54.0
1700.500000	36.5	100.0	H	21.0	0.4	17.5	54.0
1992.000000	37.7	100.0	V	349.0	1.1	16.3	54.0
2657.500000	40.3	100.0	V	223.0	3.9	13.7	54.0
2880.000000	39.5	100.0	H	57.0	4.5	14.5	54.0

Remark: 1. Correction Factor = Antenna factor+ Insertion loss (cable loss + amplifier gain)



During the test, the Radiates Emission from 18GHz to 26.5GHz was performed in all modes with all channels, BT UHD 2M 8DPSK-Channel 0 are selected as the worst condition. The test data of the worst-case condition was recorded in this report.

RE 18-26.5GHz PK+AV

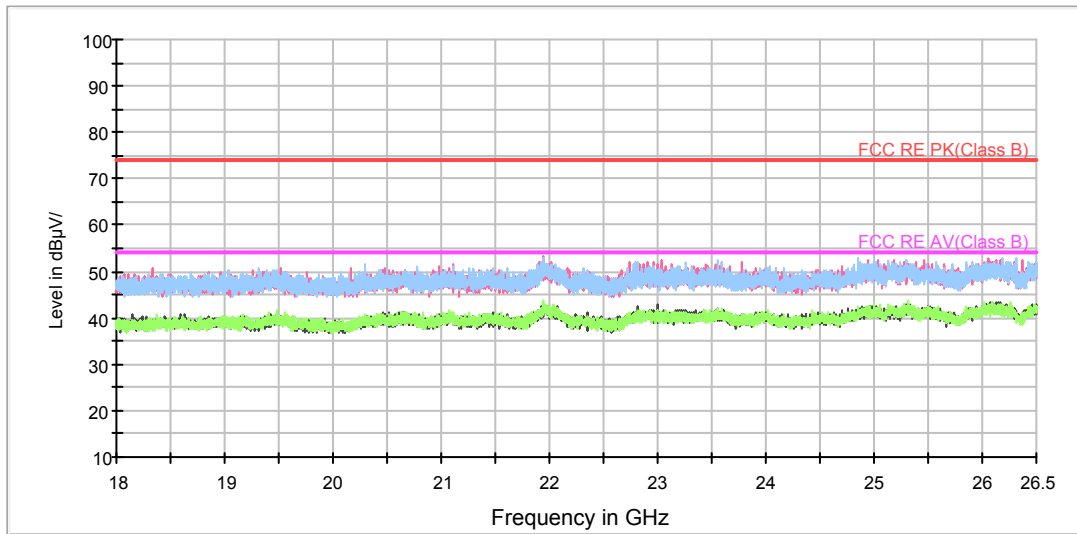

Radiates Emission from 18GHz to 26.5GHz

5.9 Conducted Emission

Ambient condition

Temperature	Relative humidity	Pressure
23°C ~25°C	45%~50%	101.5kPa

Methods of Measurement

The EUT is placed on a non-metallic table of 80cm height above the horizontal metal reference ground plane. During the test, the EUT was operating in its typical mode. The test method is according to ANSI C63.10-2013. Connect the AC power line of the EUT to the L.I.S.N. Use EMI receiver to detect the average and Quasi-peak value. RBW is set to 9 kHz, VBW is set to 30kHz. The measurement result should include both L line and N line.

The test is in transmitting mode.

Test Setup

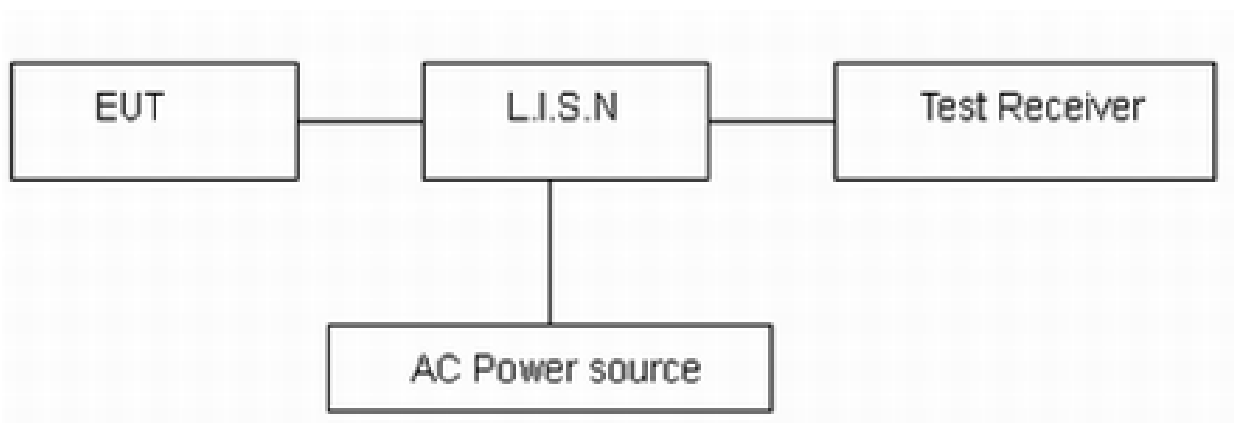

Note: AC Power source is used to 120V/60Hz.

Limits

Frequency (MHz)	Conducted Limits(dBμV)	
	Quasi-peak	Average
0.15 - 0.5	66 to 56 *	56 to 46 *
0.5 - 5	56	46
5 - 30	60	50

*: Decreases with the logarithm of the frequency.

Measurement Uncertainty

The assessed measurement uncertainty to ensure 95% confidence level for the normal distribution is with the coverage factor $k = 1.96$, $U=2.69$ dB.

Test Results:

Following plots, Blue trace uses the peak detection, Green trace uses the average detection. During the test, the Conducted Emission was performed in all modes with all channels, **BT UHD High Power Mode 2M 8DPSK-2404MHz**, are selected as the worst condition. The test data of the worst-case condition was recorded in this report.

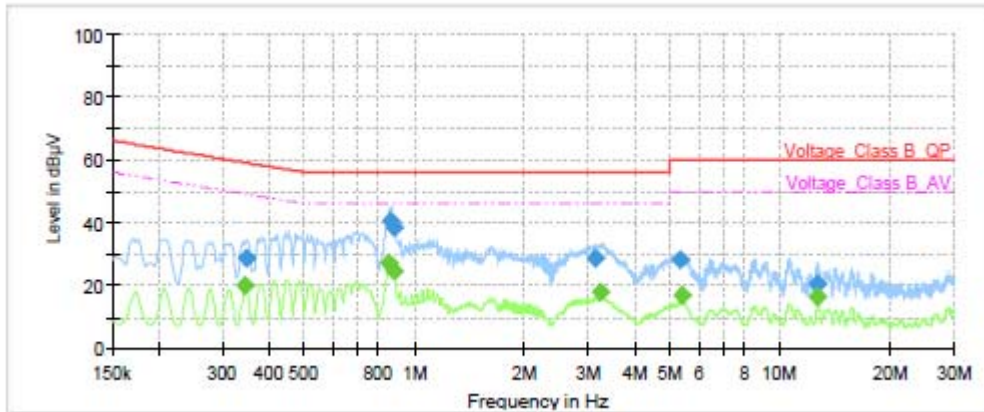

Frequency (MHz)	QuasiPeak (dBµV)	Average (dBµV)	Limit (dBµV)	Margin (dB)	Meas. Time (ms)	Bandwidth (kHz)	Line	Filter	Corr. (dB)
0.35	---	19.80	49.06	29.26	1000.0	9.000	L1	ON	19.18
0.35	28.69	---	59.01	30.32	1000.0	9.000	L1	ON	19.17
0.85	---	26.95	46.00	19.05	1000.0	9.000	L1	ON	19.24
0.87	40.69	---	56.00	15.31	1000.0	9.000	L1	ON	19.24
0.88	---	24.81	46.00	21.19	1000.0	9.000	L1	ON	19.24
0.88	38.23	---	56.00	17.77	1000.0	9.000	L1	ON	19.24
3.12	28.55	---	56.00	27.45	1000.0	9.000	L1	ON	19.09
3.24	---	18.02	46.00	27.98	1000.0	9.000	L1	ON	19.07
5.33	28.24	---	60.00	31.76	1000.0	9.000	L1	ON	19.10
5.42	---	16.99	50.00	33.01	1000.0	9.000	L1	ON	19.10
12.69	20.36	---	60.00	39.64	1000.0	9.000	L1	ON	19.47
12.70	---	16.21	50.00	33.79	1000.0	9.000	L1	ON	19.47

Remark: Correct factor=cable loss + LISN factor

L line

Conducted Emission from 150 KHz to 30 MHz

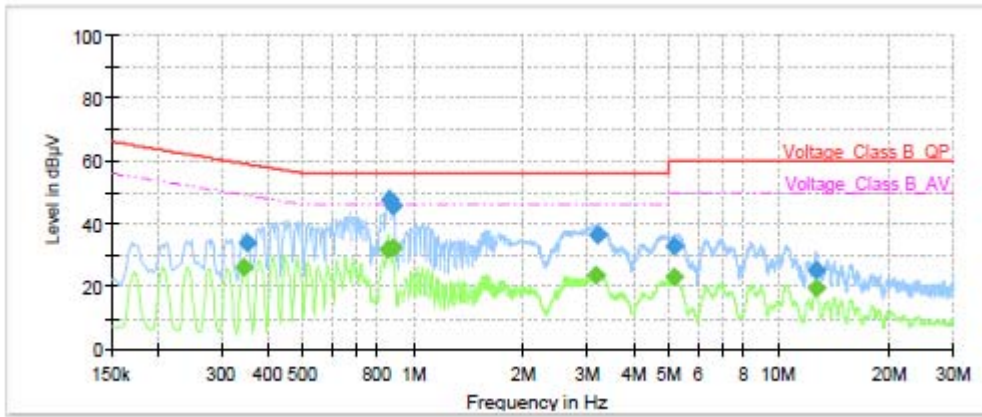

Frequency (MHz)	QuasiPeak (dBµV)	Average (dBµV)	Limit (dBµV)	Margin (dB)	Meas. Time (ms)	Bandwidth (kHz)	Line	Filter	Corr. (dB)
0.34	---	26.23	49.12	22.89	1000.0	9.000	N	ON	19.18
0.35	33.75	---	58.90	25.15	1000.0	9.000	N	ON	19.18
0.86	---	31.75	46.00	14.25	1000.0	9.000	N	ON	19.24
0.86	47.90	---	56.00	8.10	1000.0	9.000	N	ON	19.24
0.88	---	32.15	46.00	13.85	1000.0	9.000	N	ON	19.24
0.88	45.44	---	56.00	10.56	1000.0	9.000	N	ON	19.24
3.17	---	23.52	46.00	22.48	1000.0	9.000	N	ON	19.08
3.21	36.44	---	56.00	19.56	1000.0	9.000	N	ON	19.07
5.18	33.00	---	60.00	27.00	1000.0	9.000	N	ON	19.09
5.18	---	23.00	50.00	27.00	1000.0	9.000	N	ON	19.09
12.64	---	19.58	50.00	30.42	1000.0	9.000	N	ON	19.44
12.66	25.34	---	60.00	34.66	1000.0	9.000	N	ON	19.44

Remark: Correct factor=cable loss + LISN factor

N line

Conducted Emission from 150 KHz to 30 MHz

6 Main Test Instruments

Name	Manufacturer	Type	Serial Number	Calibration Date	Expiration Date
BT Base Station Simulator	R&S	CBT	100271	2019-05-19	2020-05-18
Signal Analyzer	R&S	FSV30	100815	2018-12-16	2019-12-15
EMI Test Receiver	R&S	ESCI	100948	2019-05-19	2020-05-18
Loop Antenna	Schwarzbeck	FMZB1519	1519-047	2017-09-26	2020-09-25
TRILOG Broadband Antenna	Schwarzbeck	VULB 9163	9163-201	2017-11-18	2019-11-17
Double Ridged Waveguide Horn Antenna	R&S	HF907	100126	2018-07-07	2020-07-06
Standard Gain Horn	ETS-Lindgren	3160-09	00102643	2018-06-20	2020-06-19
EMI Test Receiver	R&S	ESR	101667	2019-05-19	2020-05-18
LISN	R&S	ENV216	101171	2016-12-16	2019-12-15
Spectrum Analyzer	Agilent	N9010A	MY47191109	2019-05-19	2020-05-18
RF Cable	Agilent	SMA 15cm	0001	2019-09-13	2019-12-12
Power Splitter	Hua Xiang	SHX-GF2-2-13	10120101	/	/
Software	R&S	EMC32	9.26.0	/	/

*****END OF REPORT *****