



RF TEST REPORT

Applicant Huawei Technologies Co., Ltd.
FCC ID QISLIO-LX9
Product Smart Phone
Model LIO-L29, LIO-L09
Report No. R1907H0137-R5V2
Issue Date January 21, 2020

TA Technology (Shanghai) Co., Ltd. tested the above equipment in accordance with the requirements in **FCC CFR47 Part 15C (2018)**. The test results show that the equipment tested is capable of demonstrating compliance with the requirements as documented in this report.

Performed by: Peng Tao

Approved by: Kai Xu

TA Technology (Shanghai) Co., Ltd.

No.145, Jintang Rd, Tangzhen Industry Park, Pudong Shanghai, China

TEL: +86-021-50791141/2/3

FAX: +86-021-50791141/2/3-8000



TABLE OF CONTENT

- 1. Test Laboratory 4
 - 1.1. Notes of the test report..... 4
 - 1.2. Test facility 4
 - 1.3. Testing Location..... 5
- 2. General Description of Equipment under Test..... 6
- 3. Applied Standards 8
- 4. Test Configuration 9
- 5. Test Case Results 11
 - 5.1. Maximum output power 11
 - 5.2. 6dB Bandwidth 15
 - 5.3. Band Edge 19
 - 5.4. Power Spectral Density 21
 - 5.5. Spurious RF Conducted Emissions..... 33
 - 5.6. Unwanted Emission 37
 - 5.7. Conducted Emission 73
- 6. Main Test Instruments 76



Summary of measurement results

Number	Test Case	Clause in FCC rules	Verdict
1	Maximum conducted output power	15.247(b)(3)	PASS
2	6 dB bandwidth	15.247(a)(2)	PASS
3	Power spectral density	15.247(e)	PASS
4	Band Edge	15.247(d)	PASS
5	Spurious RF Conducted Emissions	15.247(d)	PASS
6	Unwanted Emissions	15.247(d),15.205,15.209	PASS
7	Conducted Emissions	15.207	PASS

Date of Testing: July 20, 2019~ August 11, 2019

Note: This revised report (Report No.: R1907H0137-R5V2) supersedes and replaces the previously issued report (Report No.: R1907H0137-R5V1). Please discard or destroy the previously issued report and dispose of it accordingly.



1. Test Laboratory

1.1. Notes of the test report

This report shall not be reproduced in full or partial, without the written approval of **TA technology (shanghai) co., Ltd.** The results documented in this report apply only to the tested sample, under the conditions and modes of operation as described herein .Measurement Uncertainties were not taken into account and are published for informational purposes only. This report is written to support regulatory compliance of the applicable standards stated above.

1.2. Test facility

FCC (Designation number: CN1179, Test Firm Registration Number: 446626)

TA Technology (Shanghai) Co., Ltd. has been listed on the US Federal Communications Commission list of test facilities recognized to perform electromagnetic emissions measurements.

A2LA (Certificate Number: 3857.01)

TA Technology (Shanghai) Co., Ltd. has been listed by American Association for Laboratory Accreditation to perform electromagnetic emission measurement.



1.3. Testing Location

Company: TA Technology (Shanghai) Co., Ltd.
Address: No.145, Jintang Rd, Tangzhen Industry Park, Pudong
City: Shanghai
Post code: 201201
Country: P. R. China
Contact: Xu Kai
Telephone: +86-021-50791141/2/3
Fax: +86-021-50791141/2/3-8000
Website: <http://www.ta-shanghai.com>
E-mail: xukai@ta-shanghai.com

2. General Description of Equipment under Test

Client Information

Applicant	Huawei Technologies Co., Ltd.
Applicant address	Administration Building, Headquarters of Huawei Technologies Co., Ltd., Bantian, Longgang District, Shenzhen, 518129, P.R.C
Manufacturer	Huawei Technologies Co., Ltd.
Manufacturer address	Administration Building, Headquarters of Huawei Technologies Co., Ltd., Bantian, Longgang District, Shenzhen, 518129, P.R.C

General information

EUT Description			
Model	LIO-L29, LIO-L09		
SN	YDM0119625000032		
Hardware Version	HL1LIONM		
Software Version	5.0.1.103M(C432E103R4P1)		
Power Supply	Battery/AC adapter		
Antenna Type	Internal Antenna		
Antenna Connector	A permanently attached antenna (meet with the standard FCC Part 15.203 requirement)		
Antenna Gain	Channel/frequency (MHz)	Antenna 1 (dBi)	Antenna 2 (dBi)
	1/2412	-1.06	-3.52
	3/2422	-1.06	-3.52
	6/2437	-1.48	-1.66
	9/2452	-0.94	-1.56
	11/2462	-0.94	-1.56
additional beamforming gain	NA		
Test Mode	802.11b 802.11g, 802.11n(HT20/HT40);		
Modulation Type	802.11b: DSSS; 802.11g/n(HT20/HT40): OFDM		
Max. Conducted Power	Wi-Fi 2.4G :19.12dBm		
Operating Frequency Range(s)	802.11b/g/n(HT20): 2412 ~ 2462 MHz 802.11n(HT40): 2422 ~ 2452 MHz		
EUT Accessory			
Battery 1	Manufacturer: HUAWEI Technologies Co., Ltd. (Sunwoda, Murata)		



	Model: HB555591EEW
Battery 2	Manufacturer: HUAWEI Technologies Co., Ltd. (Sunwoda, ATL) Model: HB555591EEW
Battery 3	Manufacturer: HUAWEI Technologies Co., Ltd. (SCUD) Model: HB555591EEW
Earphone 1	Manufacturer: Jiangxi Lianchuang Hongsheng Electronic Co. ,LTD Model: MEND1632B729001
Earphone 2	Manufacturer: Jiangxi Lianchuang Hongsheng Electronic Co. ,LTD Model: MEND1632B729000
Earphone 3	Manufacturer: GoerTek Inc Model: WINDY-C
Earphone 4	Manufacturer: Boluo County Quancheng Electronic Co.,ltd Model: 1331-3301-6001-TC-296
Earphone 5	Manufacturer: Foster Electric Co.,(GuangZhou)LTD.Sales Dep. Model: 618017
<p>Note: The information of the EUT is declared by the manufacturer.</p> <p>2. There is more than one Battery, each one should be applied throughout the compliance test respectively, and however, only the worst case (Battery 1) will be recorded in this report.</p>	

LIO-L29 is dual SIM smart phone. LIO-L09 is single SIM smart phone. The model LIO-L29 and LIO-L09 are identical except for LIO-L09 support single SIM card which deleted by software.

3. Applied Standards

According to the specifications of the manufacturer, it must comply with the requirements of the following standards:

Test standards

- **FCC CFR47 Part 15C (2018) Radio Frequency Devices**
- **ANSI C63.10 (2013)**
- **KDB 558074 D01 15.247 Meas Guidance v05r02**
- **KDB 662911 D01 Multiple Transmitter Output v02r01**

4. Test Configuration

Test Mode

The EUT has been associated with peripherals and configuration operated in a manner tended to maximize its emission characteristics in a typical application.

The radiated emission was measured in the following position: EUT stand-up position (Z axis), lie-down position (X, Y axis). The worst emission was found in lie-down position (X axis) and the loop antenna is vertical, the others are vertical and horizontal. and the worst case was recorded.

In order to find the worst case condition, Pre-tests are needed at the presence of different data rate. Preliminary tests have been done on all the configuration for confirming worst case. Data rate below means worst-case rate of each test item.

Worst-case data rates are shown as following table.

Band	Data Rate		
	Antenna 1	Antenna 2	MIMO
802.11b	1 Mbps	1 Mbps	/
802.11g	6 Mbps	6 Mbps	6 Mbps
802.11n HT20	MCS0	MCS0	MCS8
802.11n HT40	MCS0	MCS0	MCS8



The worst case Antenna mode for each of the following tests for Wi-Fi:

Test Cases	Antenna 1	Antenna 2	MIMO
Maximum conducted output power	O	O	802.11g 802.11n HT20 802.11n HT40
6dB Bandwidth	O	--	--
Band Edge	O	--	--
Power Spectral Density	O	O	802.11g 802.11n HT20 802.11n HT40
Spurious RF Conducted Emissions	O	O	802.11g 802.11n HT20 802.11n HT40
Unwanted Emissions	O	--	--
Conducted Emission	802.11b	O	802.11g 802.11n HT20 802.11n HT40
Note: "O": test all bands			

5. Test Case Results

5.1. Maximum output power

Ambient condition

Temperature	Relative humidity	Pressure
23°C ~25°C	45%~50%	101.5kPa

Methods of Measurement

During the process of the testing, The EUT was connected to Average Power meter with a known loss. The EUT is max power transmission with proper modulation. The signal transmission is continuous.

The conducted Power is measured at each antenna port. The measured results at the various antenna ports are then summed mathematically.

Test Setup

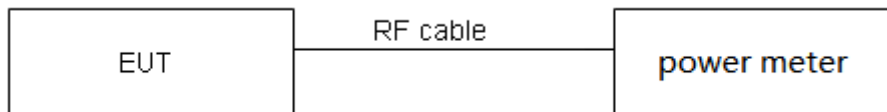

Limits

Rule Part 15.247 (b) (3) specifies that " For systems using digital modulation in the 902–928 MHz, 2400–2483.5 MHz: 1 Watt."

Average Output Power	$\leq 1W$ (30dBm)
----------------------	-------------------

Measurement Uncertainty

The assessed measurement uncertainty to ensure 95% confidence level for the normal distribution is with the coverage factor $k = 2$, $U = 0.44$ dB.

Test Results

Band	T _{on} (ms)	T _(on+off) (ms)	Duty cycle	Duty cycle correction Factor(dB)
802.11b	1.00	1.00	1.00	N/A
802.11g	2.73	2.75	0.99	N/A
802.11n HT20	2.54	2.56	0.99	N/A
802.11n HT40	1.24	1.28	0.97	0.12

Note: when Duty cycle>0.98, Duty cycle correction Factor not required.

SISO Antenna 1

Network Standards	Carrier frequency (MHz)	Average Power Measured	Average Power with duty factor	Limit (dBm)	Conclusion
802.11b	2412	16.32	16.32	30	PASS
	2437	18.64	18.64	30	PASS
	2462	16.41	16.41	30	PASS
802.11g	2412	10.24	10.24	30	PASS
	2437	17.43	17.43	30	PASS
	2462	10.63	10.63	30	PASS
802.11n HT20	2412	10.11	10.11	30	PASS
	2437	17.06	17.06	30	PASS
	2462	10.48	10.48	30	PASS
802.11n HT40	2422	6.78	6.90	30	PASS
	2437	6.85	6.97	30	PASS
	2452	5.27	5.39	30	PASS

Note: Average Power with duty factor = Average Power Measured +Duty cycle correction factor

SISO Antenna 2

Network Standards	Carrier frequency (MHz)	Average Power Measured	Average Power with duty factor	Limit (dBm)	Conclusion
802.11b	2412	16.15	16.15	30	PASS
	2437	17.81	17.81	30	PASS
	2462	15.97	15.97	30	PASS
802.11g	2412	10.13	10.13	30	PASS
	2437	16.79	16.79	30	PASS
	2462	10.06	10.06	30	PASS
802.11n HT20	2412	9.98	9.98	30	PASS
	2437	16.41	16.41	30	PASS
	2462	10.02	10.02	30	PASS
802.11n HT40	2422	6.44	6.56	30	PASS
	2437	6.66	6.78	30	PASS
	2452	5.14	5.26	30	PASS

Note: Average Power with duty factor = Average Power Measured +Duty cycle correction factor

MIMO

Network Standards	Carrier frequency (MHz)	Average Output Power (dBm)					Limit (dBm)	Conclusion
		Antenna 1		Antenna 2		Total Power		
		(dBm)	(mW)	(dBm)	(mW)	(dBm)		
802.11g	2412	10.24	10.24	9.81	9.81	13.04	30	PASS
	2437	16.49	16.49	15.69	15.69	19.12	30	PASS
	2462	10.67	10.67	9.94	9.94	13.33	30	PASS
802.11n HT20	2412	10.06	10.06	9.65	9.65	12.87	30	PASS
	2437	15.98	15.98	15.23	15.23	18.63	30	PASS
	2462	10.53	10.53	9.78	9.78	13.18	30	PASS
802.11n HT40	2422	6.84	6.96	6.27	6.39	9.70	30	PASS
	2437	6.96	7.08	6.43	6.55	9.84	30	PASS
	2452	5.43	5.55	6.13	6.25	8.93	30	PASS

Note: 1. For Total Power, according to KDB 662911 D01 Multiple Transmitter Output v02r01 1),
The Total Power = $10\log(10^{(Power\ antenna1\ in\ dBm/10)} + 10^{(Power\ antenna2\ in\ dBm/10)})$.

2. The manufacturer declared the transmitter output signals is CDD mode. And $N_{SS}=2$. According to KDB 662911 D01 Multiple Transmitter Output v02r01 2)f(i): If all antennas have the same gain, Directional gain = $G_{ANT} + Array\ Gain$,
For power measurements on IEEE 802.11 devices,
Array Gain = 0 dB (i.e., no array gain) for $N_{ANT} \leq 4$;
Array Gain = 0 dB (i.e., no array gain) for channel widths ≥ 40 MHz for any N_{ANT} ;
Array Gain = $5 \log(N_{ANT}/N_{SS})$ dB or 3 dB, whichever is less, for 20-MHz channel widths with $N_{ANT} \geq 5$.

3. If antenna gains are not equal, the user may use either of the following methods to calculate directional gain, provided that each transmit antenna is driven by only one spatial stream: Directional gain may be calculated by using the formulas applicable to equal gain antennas with G_{ANT} set equal to the gain of the antenna having the highest gain.
So directional gain = $G_{ANT} + Array\ Gain = -1.06(CH1/3)/-1.48(CH6)/-0.94(CH9/11) < 6dBi$. So the power limit is 30dBm

5.2. 6dB Bandwidth

Ambient condition

Temperature	Relative humidity	Pressure
23°C ~25°C	45%~50%	101.5kPa

Method of Measurement

The EUT was connected to the spectrum analyzer through an external attenuator (20dB) and a known loss cable. RBW is set to 100 kHz; VBW is set to 300 kHz on spectrum analyzer. Dector=Peak, Trace mode=max hold.

Test Setup

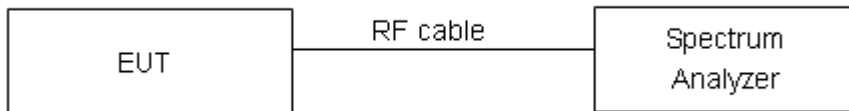

Limits

Rule Part 15.247 (a) (2) specifies that “Systems using digital modulation techniques may operate in the 902–928 MHz, 2400–2483.5 MHz bands. The minimum 6 dB bandwidth shall be at least 500 kHz.”

minimum 6 dB bandwidth	≥ 500 kHz
------------------------	-----------

Measurement Uncertainty

The assessed measurement uncertainty to ensure 95% confidence level for the normal distribution is with the coverage factor $k = 2$, $U = 936$ Hz.

Test Results:

Network Standards	Carrier frequency (MHz)	99% bandwidth (MHz)	Minimum 6 dB bandwidth (MHz)	Limit (kHz)	Conclusion
802.11b	2412	11.637	8.584	500	PASS
	2437	11.612	9.024	500	PASS
	2462	11.705	8.599	500	PASS
802.11g	2412	16.228	15.480	500	PASS
	2437	16.354	15.790	500	PASS
	2462	16.237	15.500	500	PASS
802.11n HT20	2412	17.383	15.330	500	PASS
	2437	17.479	16.160	500	PASS
	2462	17.373	15.650	500	PASS
802.11n HT40	2422	36.030	35.960	500	PASS
	2437	36.169	36.300	500	PASS
	2452	35.972	35.880	500	PASS



802.11b, Carrier frequency (MHz): 2412

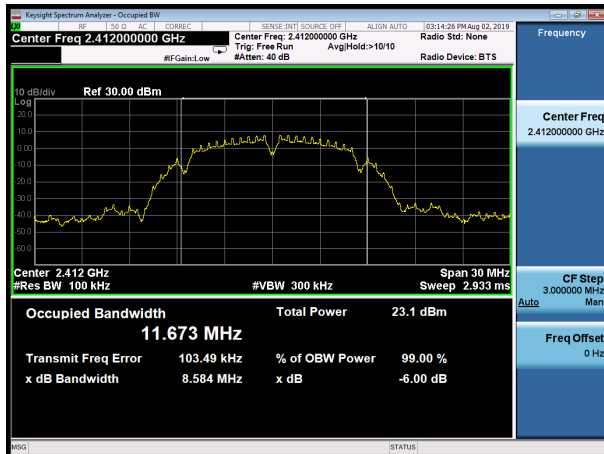

802.11g, Carrier frequency (MHz): 2412

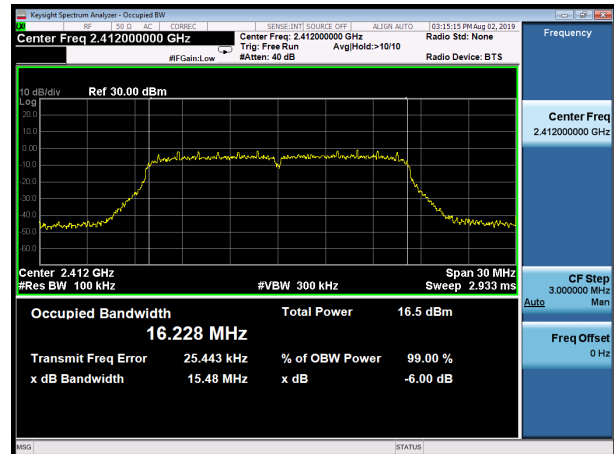

802.11b, Carrier frequency (MHz): 2437

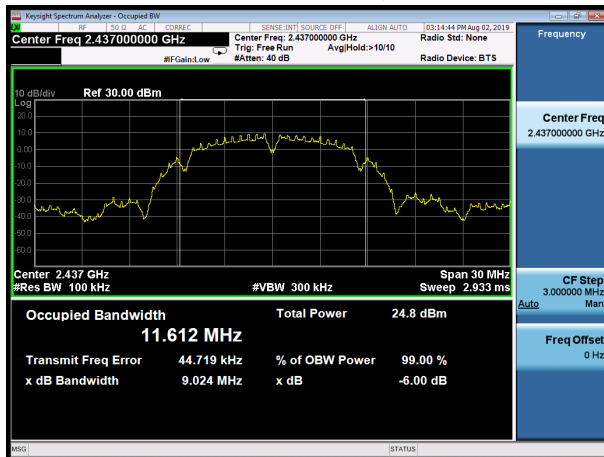

802.11g, Carrier frequency (MHz): 2437

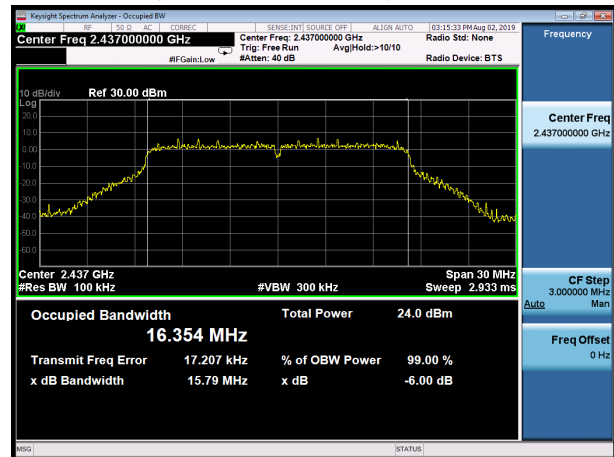

802.11b, Carrier frequency (MHz): 2462

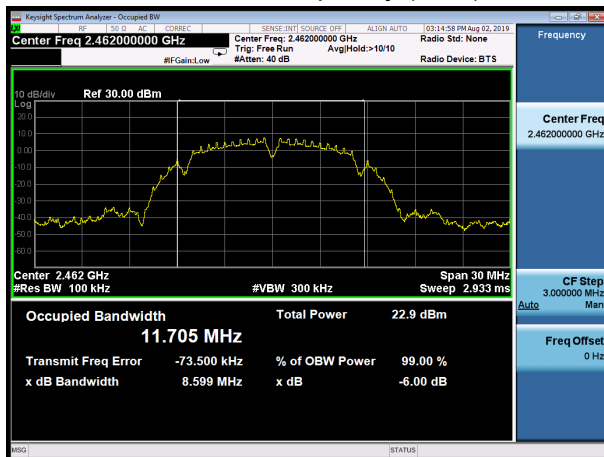

802.11g, Carrier frequency (MHz): 2462

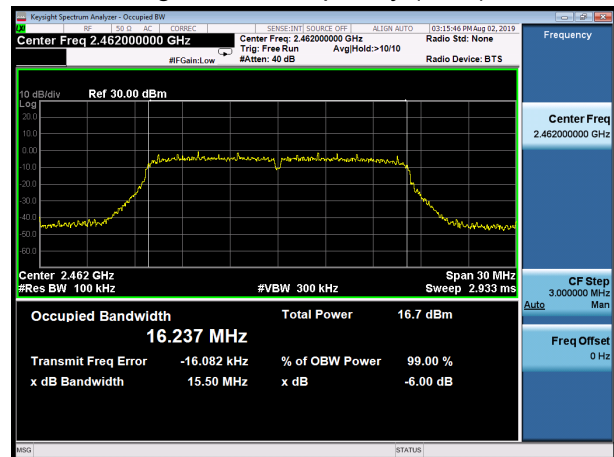



802.11n(HT20), Carrier frequency (MHz): 2412

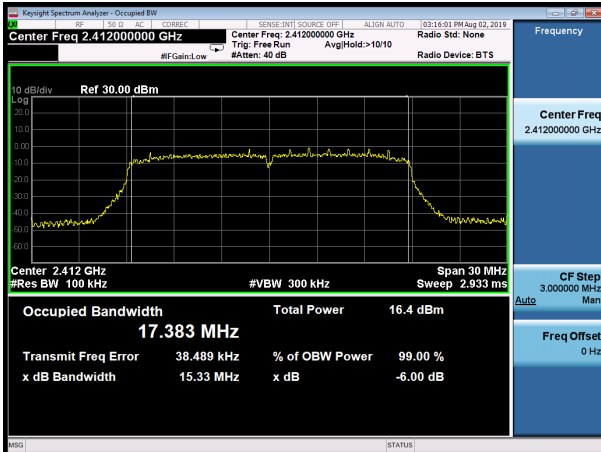

802.11n(HT40), Carrier frequency (MHz): 2422

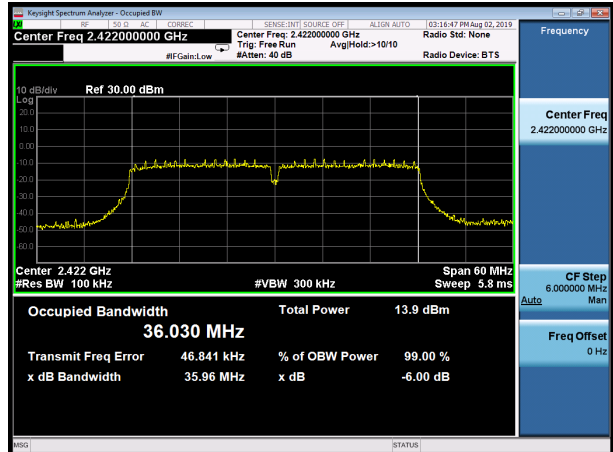

802.11n(HT20), Carrier frequency (MHz): 2437

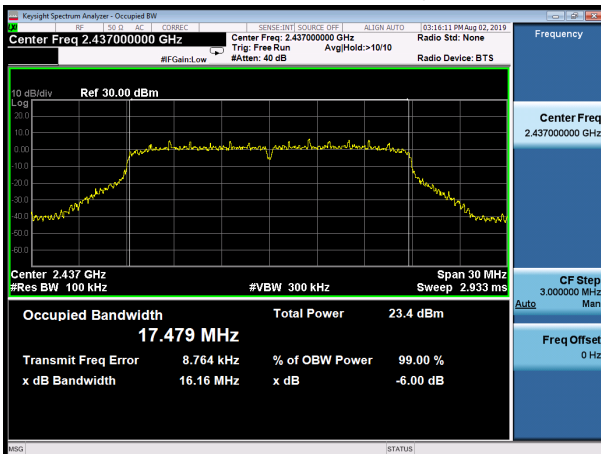

802.11n(HT40), Carrier frequency (MHz): 2437

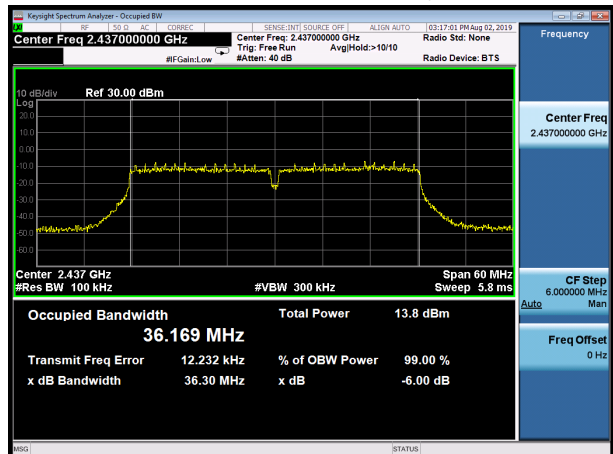

802.11n(HT20), Carrier frequency (MHz): 2462

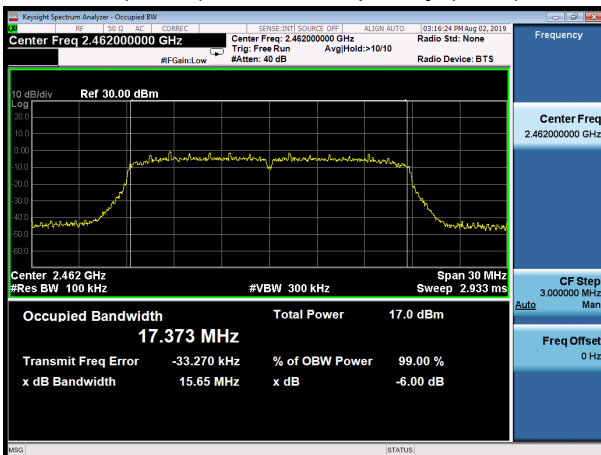

802.11n(HT40), Carrier frequency (MHz): 2452

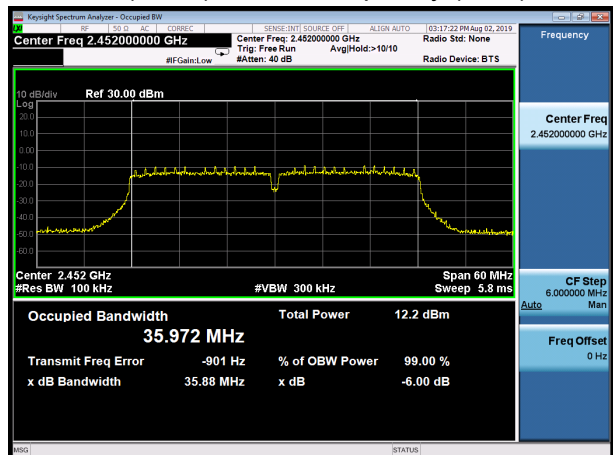

5.3. Band Edge

Ambient condition

Temperature	Relative humidity	Pressure
23°C ~25°C	45%~50%	101.5kPa

Method of Measurement

The EUT was connected to the spectrum analyzer through an external attenuator (20dB) and a known loss cable the band edge of the lowest and highest channels were measured. The peak detector is used and RBW is set to 100 kHz and VBW is set to 300 kHz on spectrum analyzer. Spectrum analyzer plots are included on the following pages.

Test Setup

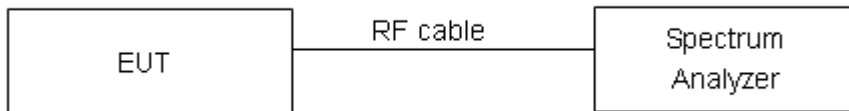

Limits

Rule Part 15.247(d) specifies that “In any 100 kHz bandwidth outside the frequency band in which the spread spectrum or digitally modulated intentional radiator is operating, the radio frequency power that is produced by the intentional radiator shall be at least 20 dB below that in the 100 kHz bandwidth within the band that contains the highest level of the desired power, based on either an RF conducted or a radiated measurement, provided the transmitter demonstrates compliance with the peak conducted power limits.” If the transmitter complies with the conducted power limits based on the use of RMS averaging over a time interval, as permitted under paragraph (b)(3) of this section, the attenuation required under this paragraph shall be 30 dB instead of 20 dB.”

Measurement Uncertainty

The assessed measurement uncertainty to ensure 95% confidence level for the normal distribution is with the coverage factor $k = 1.96$.

Frequency	Uncertainty
2GHz-3GHz	1.407 dB



Test Results: PASS

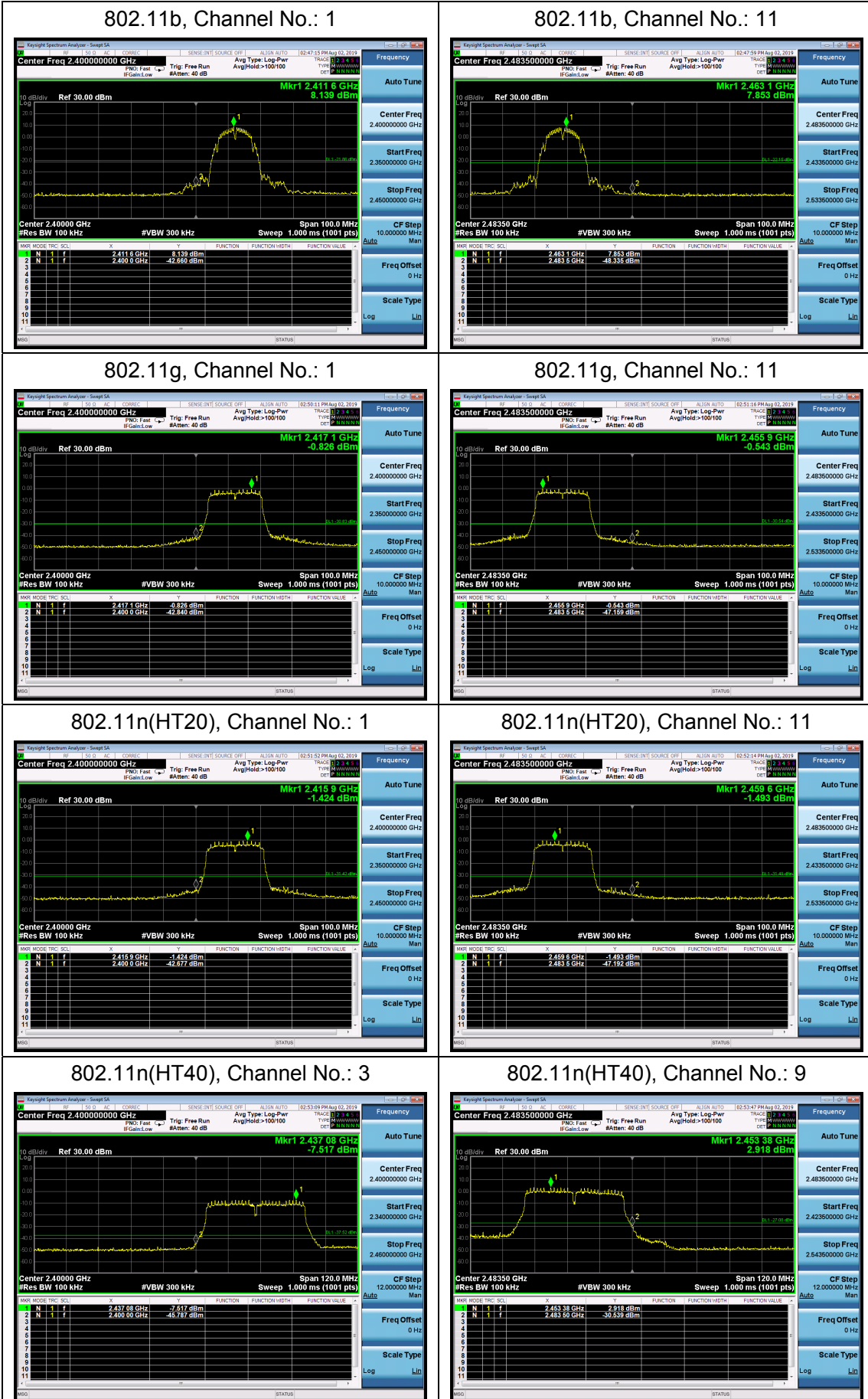

5.4. Power Spectral Density

Ambient condition

Temperature	Relative humidity	Pressure
23°C ~25°C	45%~50%	101.5kPa

Method of Measurement

During the process of the testing, The EUT was connected to Spectrum Analyzer with a known loss. The EUT is max power transmission with proper modulation. Method AVGPS-2 in KDB558074 D01 was used for this test.

The conducted Power is measured at each antenna port. The measured results at the various antenna ports are then summed mathematically.

Test setup

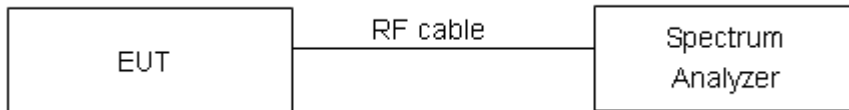

Limits

Rule Part 15.247(e) specifies that” For digitally modulated systems, the power spectral density conducted from the intentional radiator to the antenna shall not be greater than 8 dBm in any 3 kHz band during any time interval of continuous transmission. ”

Limits	≤ 8 dBm / 3kHz
--------	----------------

Measurement Uncertainty

The assessed measurement uncertainty to ensure 95% confidence level for the normal distribution is with the coverage factor $k = 2$, $U = 0.75\text{dB}$.

**Test Results:****SISO Antenna 1**

Network Standards	Channel Number	Read Value (dBm / 3kHz)	Power Spectral Density (dBm / 3kHz)	Limit (dBm / 3kHz)	Conclusion
802.11b	1	-15.75	-15.75	8	PASS
	6	-13.26	-13.26	8	PASS
	11	-15.51	-15.51	8	PASS
802.11g	1	-24.73	-24.73	8	PASS
	6	-17.20	-17.20	8	PASS
	11	-24.42	-24.42	8	PASS
802.11n HT20	1	-24.70	-24.70	8	PASS
	6	-17.72	-17.72	8	PASS
	11	-24.72	-24.72	8	PASS
802.11n HT40	3	-31.47	-31.35	8	PASS
	6	-31.29	-31.16	8	PASS
	9	-33.10	-32.97	8	PASS

Note: Power Spectral Density =Read Value+Duty cycle correction factor

**SISO Antenna 2**

Network Standards	Channel Number	Read Value (dBm / 3kHz)	Power Spectral Density (dBm / 3kHz)	Limit (dBm / 3kHz)	Conclusion
802.11b	1	-15.33	-15.33	8	PASS
	6	-14.61	-14.61	8	PASS
	11	-15.61	-15.61	8	PASS
802.11g	1	-24.06	-24.06	8	PASS
	6	-18.43	-18.43	8	PASS
	11	-24.60	-24.60	8	PASS
802.11n HT20	1	-24.25	-24.25	8	PASS
	6	-19.13	-19.13	8	PASS
	11	-24.89	-24.89	8	PASS
802.11n HT40	3	-31.54	-31.42	8	PASS
	6	-31.68	-31.55	8	PASS
	9	-32.91	-32.78	8	PASS

Note: Power Spectral Density =Read Value+Duty cycle correction factor

MIMO

Network Standards	Channel Number	Power Spectral Density (dBm / 3kHz)					Limit (dBm / 3kHz)	Conclusion
		Antenna 1		Antenna 2		Total PSD (dBm / 3kHz)		
		(dBm / 3kHz)	(mW/ 3kHz)	(dBm / 3kHz)	(mW/ 3kHz)			
802.11g	2412	-24.63	-24.63	-24.53	-24.53	-21.57	8.00	PASS
	2437	-18.54	-18.54	-19.62	-19.62	-16.04	8.00	PASS
	2462	-24.43	-24.43	-25.14	-25.14	-21.76	8.00	PASS
802.11b	1	-24.91	-24.91	-24.81	-24.81	-21.85	8.00	PASS
	6	-18.90	-18.90	-20.25	-20.25	-16.51	8.00	PASS
	11	-24.66	-24.66	-25.19	-25.19	-21.91	8.00	PASS
802.11g	1	-31.52	-31.40	-31.93	-31.81	-28.59	8.00	PASS
	6	-30.94	-30.81	-31.86	-31.73	-28.24	8.00	PASS
	11	-32.96	-32.83	-32.12	-31.99	-29.38	8.00	PASS

Note: 1. For Total PSD, according to KDB 662911 D01 Multiple Transmitter Output v02r01 2)a), the power spectral density = $10 \log(10^{(PSD \text{ antenna1 in dBm}/10)} + 10^{(PSD \text{ antenna2 in dBm}/10)})$

2. The manufacturer declared the transmitter output signals is CDD mode. And $N_{ss}=2$. According to KDB 662911 D01 Multiple Transmitter Output v02r01 2)f)(i): If all antennas have the same gain, Directional gain = $G_{ANT} + \text{Array Gain}$, For power spectral density (PSD) measurements on all devices, Array Gain = $10 \log(N_{ANT}/N_{SS})$ dB=0.

3. If antenna gains are not equal, the user may use either of the following methods to calculate directional gain, provided that each transmit antenna is driven by only one spatial stream: Directional gain may be calculated by using the formulas applicable to equal gain antennas with G_{ANT} set equal to the gain of the antenna having the highest gain. So directional gain = $G_{ANT} + \text{Array Gain} = -1.06$ (CH1/3)/-1.48(CH6)/-0.94(CH9/11)<6dBi. So the power limit is 8dBm



SISO Antenna 1

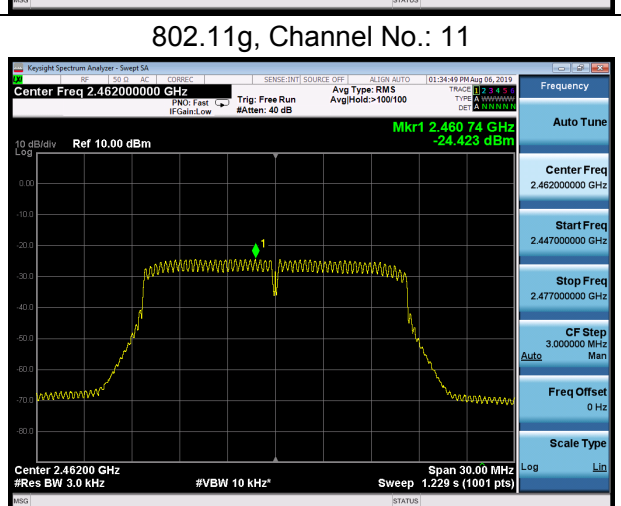
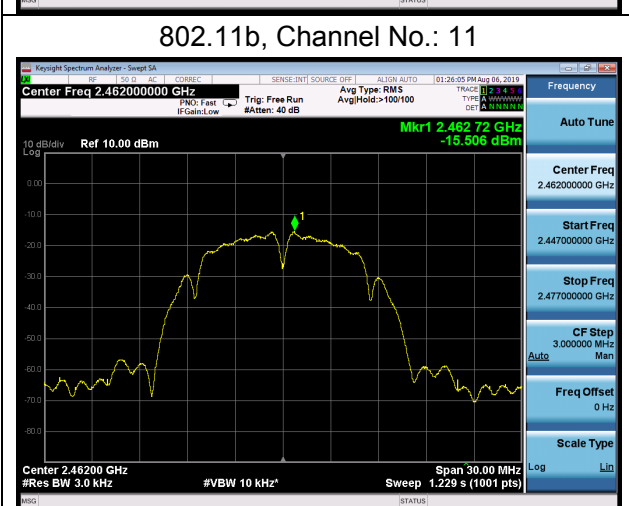
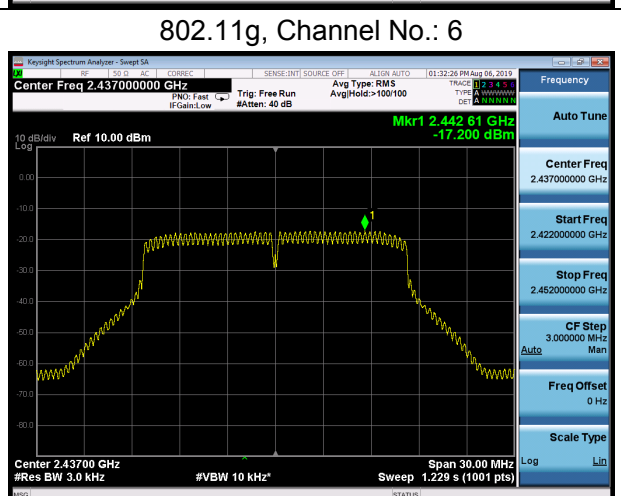
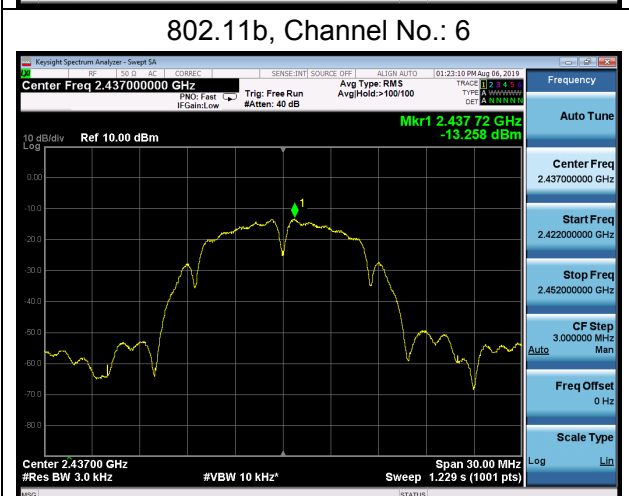
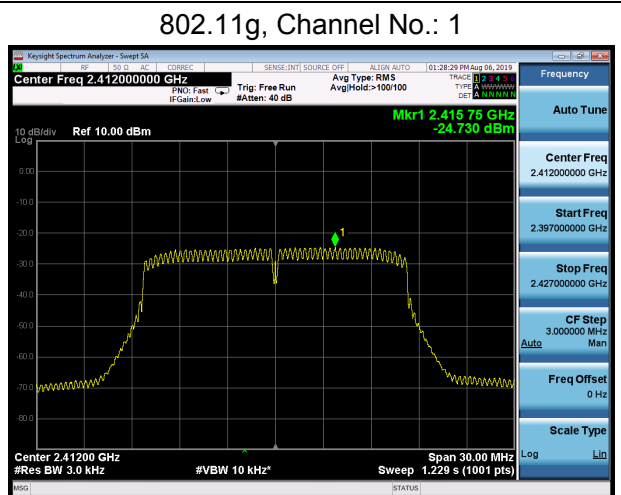
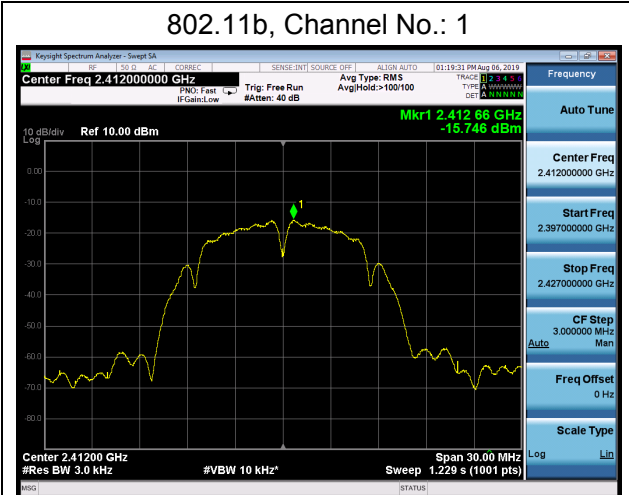



802.11n(HT20), Channel No. 1

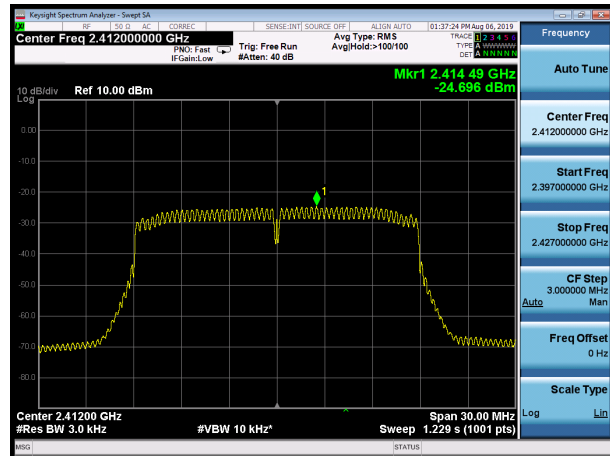

802.11n(HT40), Channel No. 3

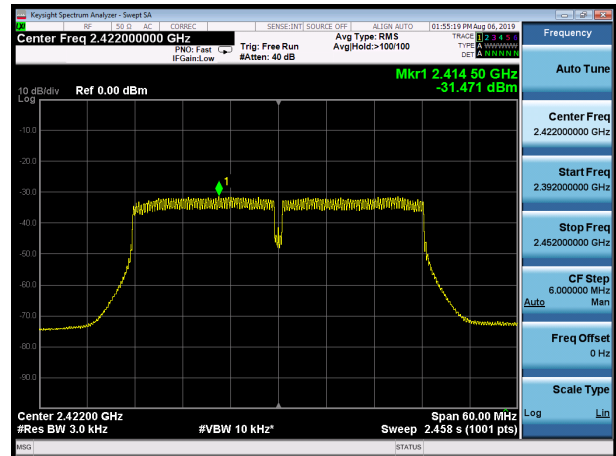

802.11n(HT20), Channel No. 6

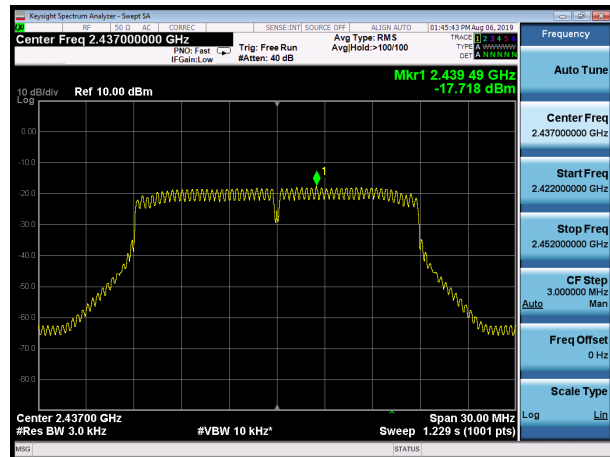

802.11n(HT40), Channel No. 6

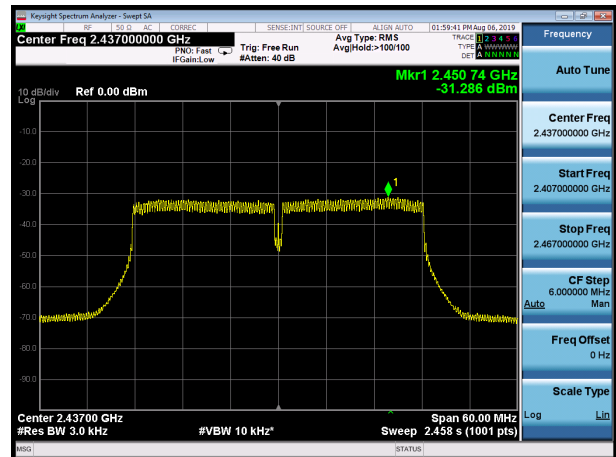

802.11n(HT20), Channel No. 11

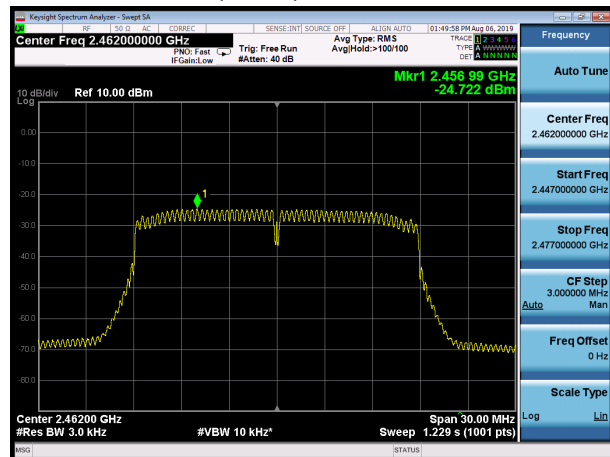

802.11n(HT40), Channel No. 9

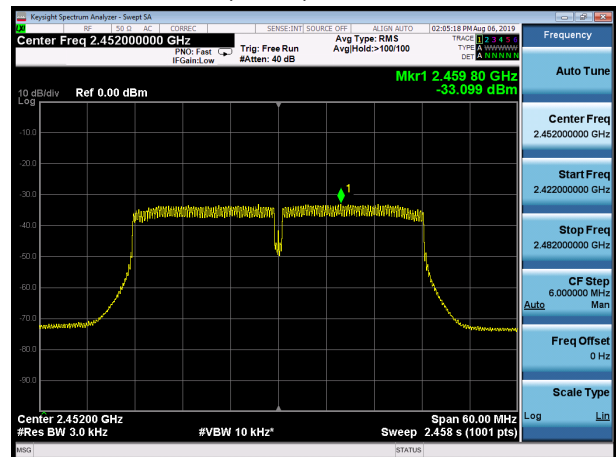



SISO Antenna 2

802.11b, Channel No.: 1



802.11g, Channel No.: 1

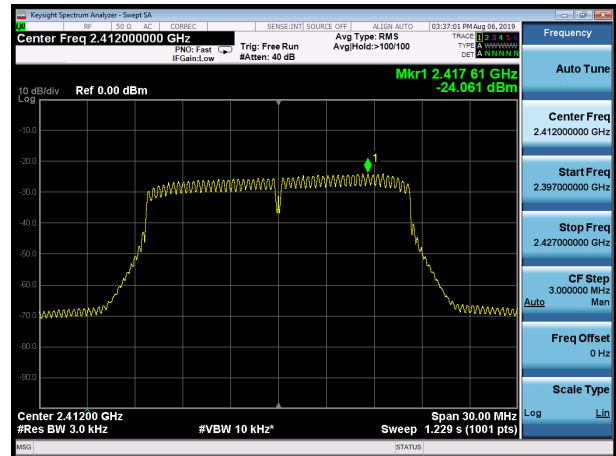

802.11b, Channel No.: 6



802.11g, Channel No.: 6

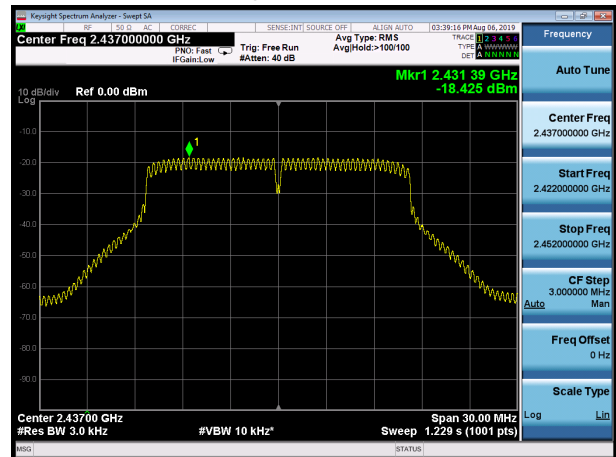

802.11b, Channel No.: 11



802.11g, Channel No.: 11

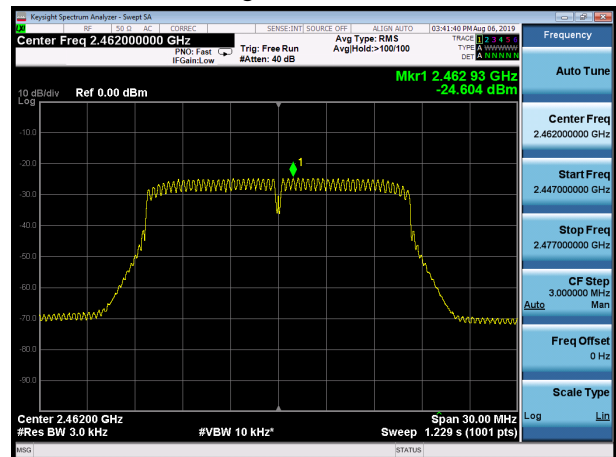



802.11n(HT20), Channel No. 1

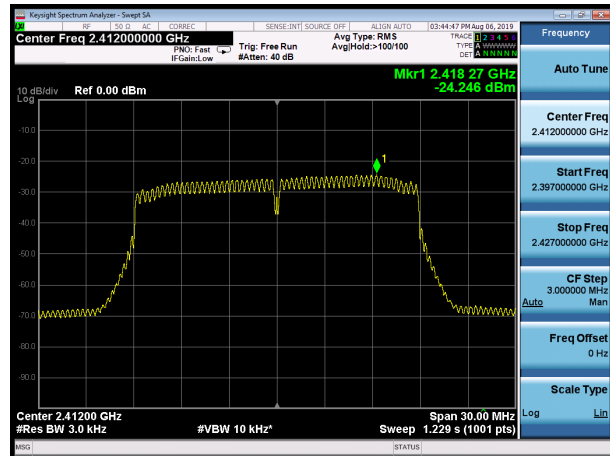

802.11n(HT40), Channel No. 3

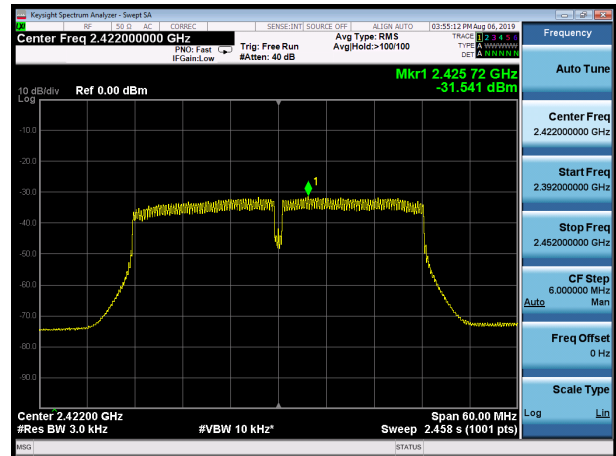

802.11n(HT20), Channel No. 6

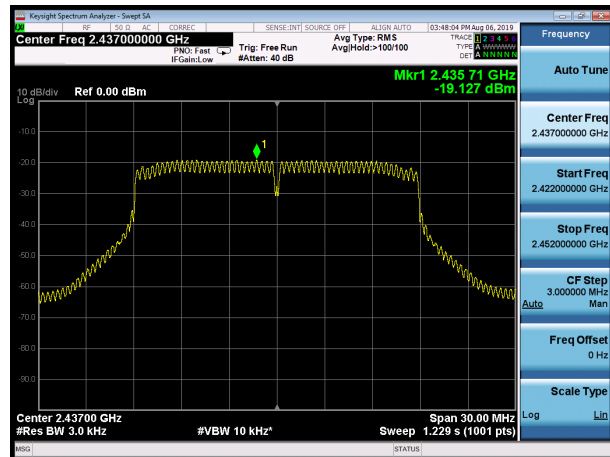

802.11n(HT40), Channel No. 6

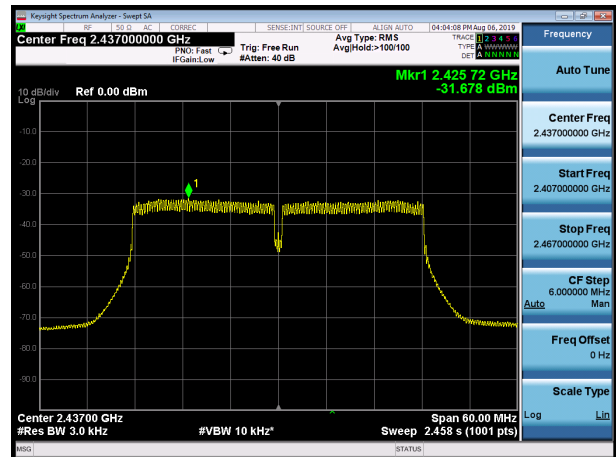

802.11n(HT20), Channel No. 11

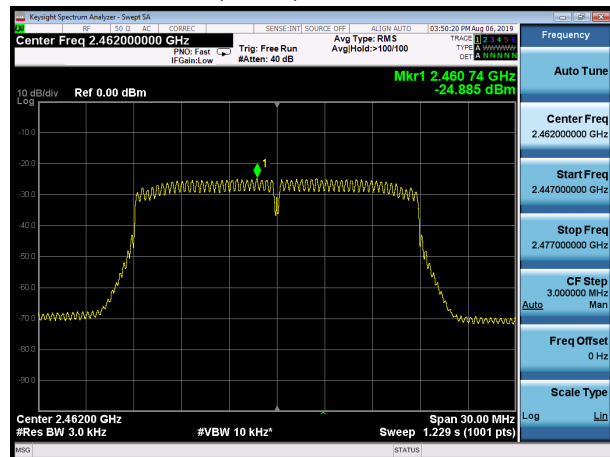

802.11n(HT40), Channel No. 9

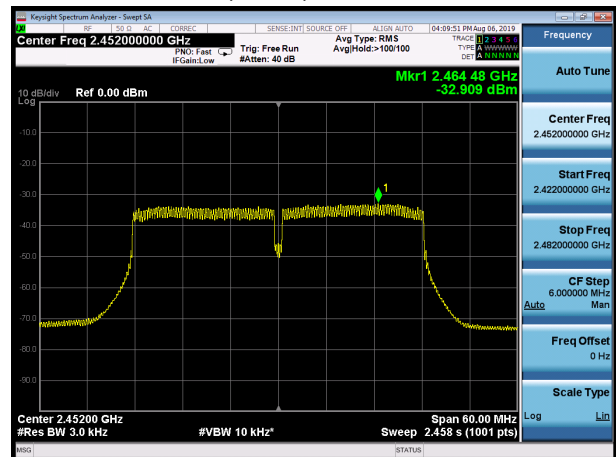



MIMO Antenna 1

802.11g, Channel No.: 1

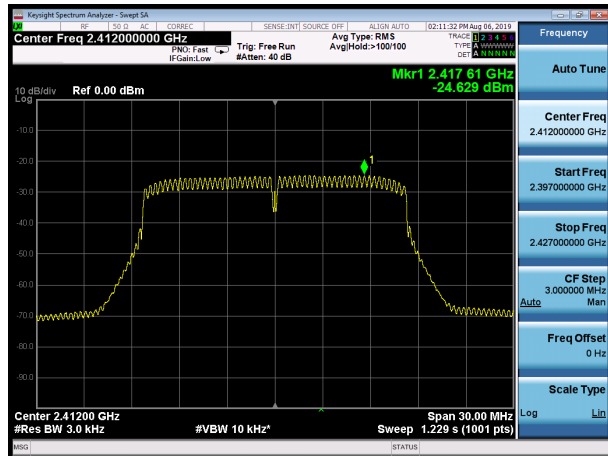

802.11n(HT20), Channel No. 1

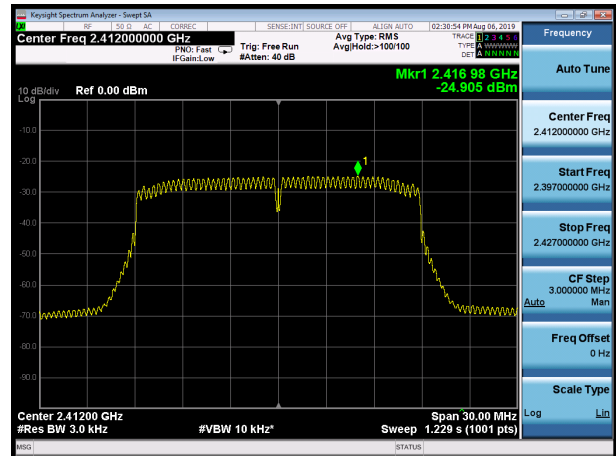

802.11g, Channel No.: 6

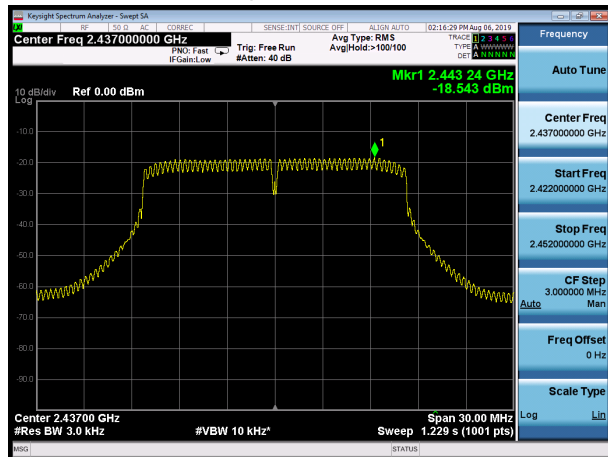

802.11n(HT20), Channel No. 6

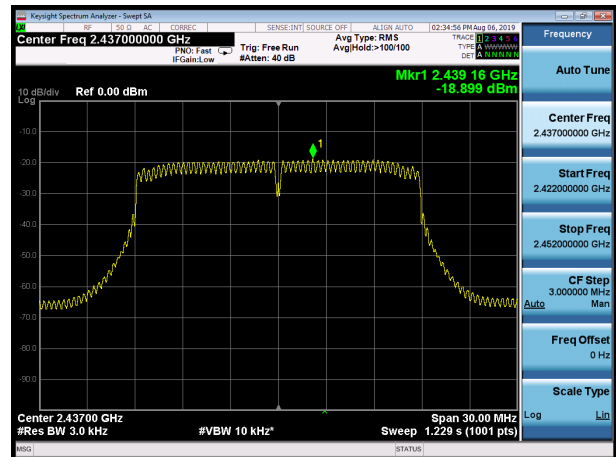

802.11g, Channel No.: 11

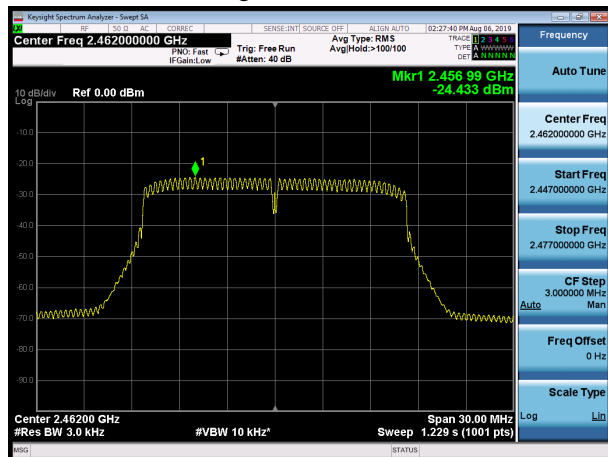

802.11n(HT20), Channel No. 11

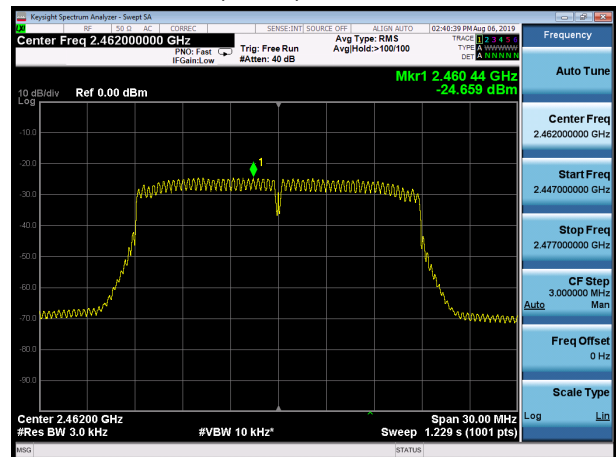



802.11n(HT40), Channel No. 3

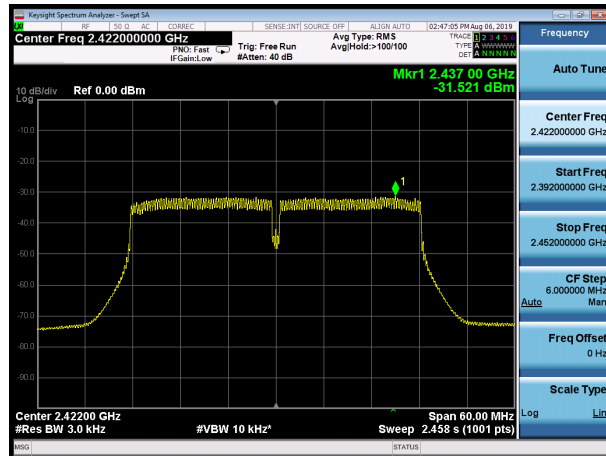

802.11n(HT40), Channel No. 6

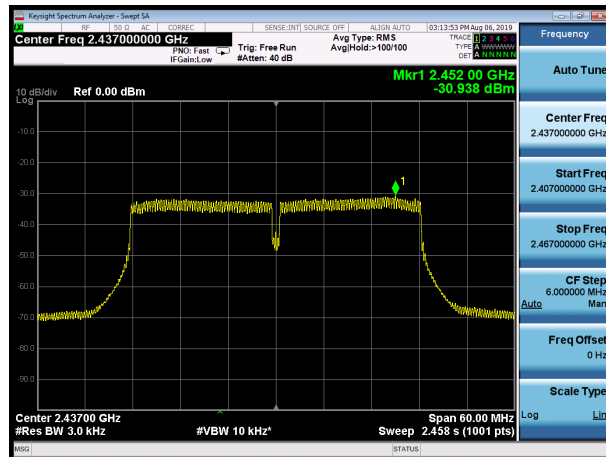

802.11n(HT40), Channel No. 9

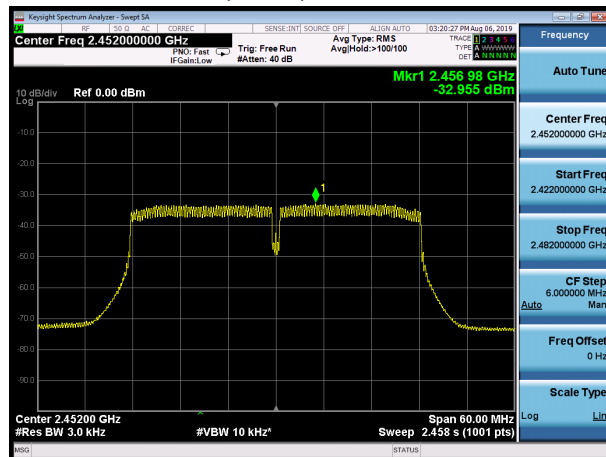



MIMO Antenna 2

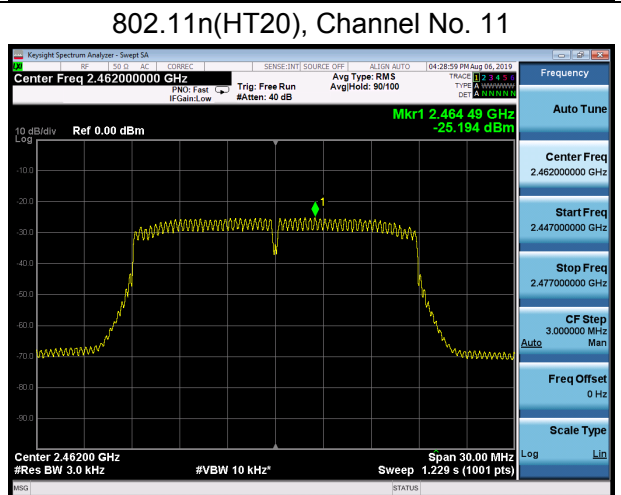
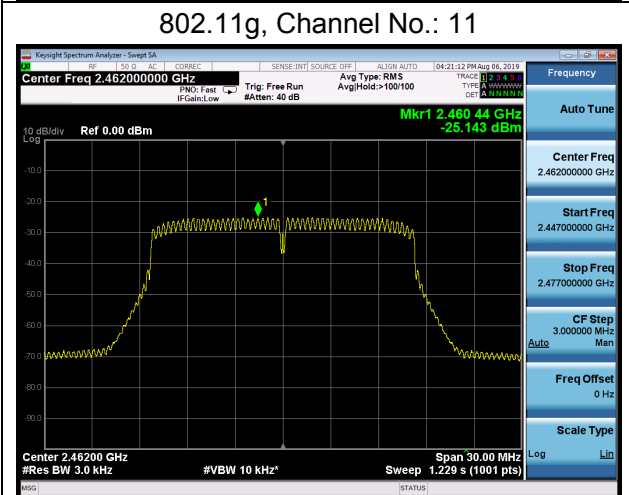
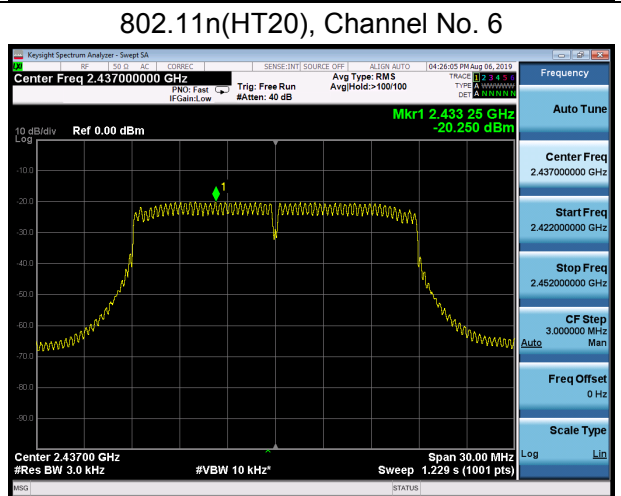
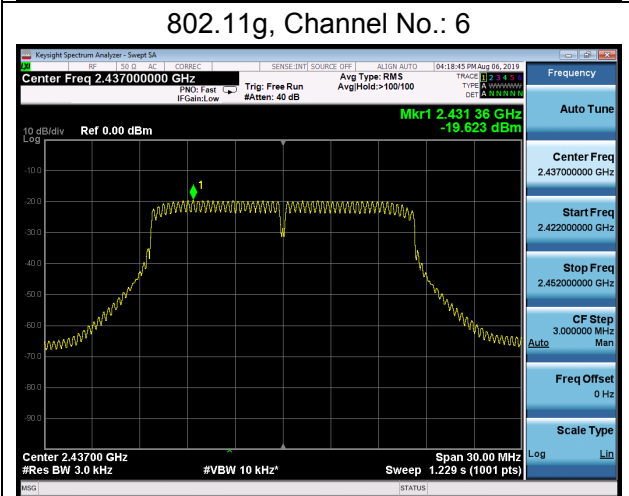
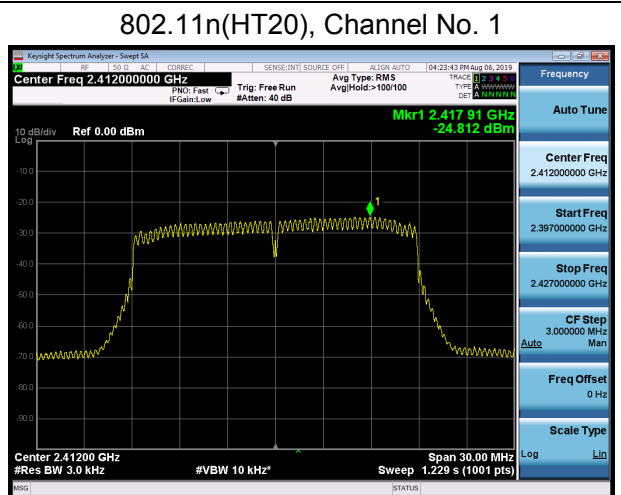
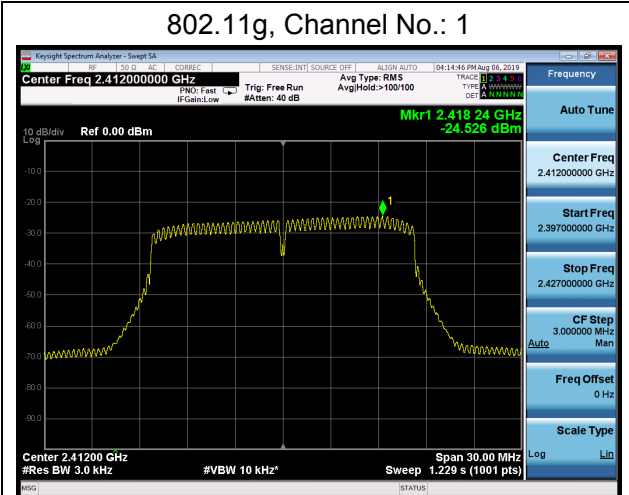

802.11n(HT40), Channel No. 3

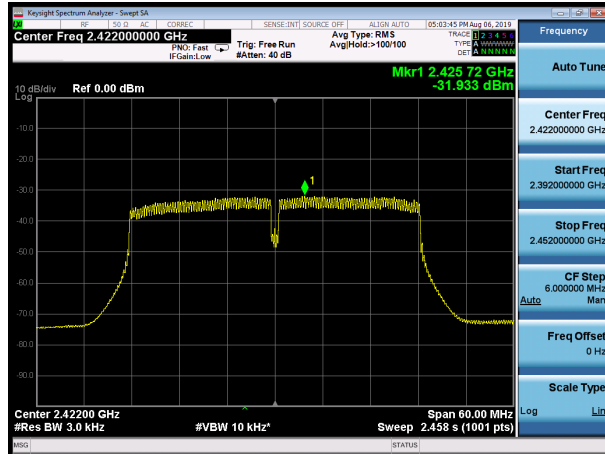

802.11n(HT40), Channel No. 6

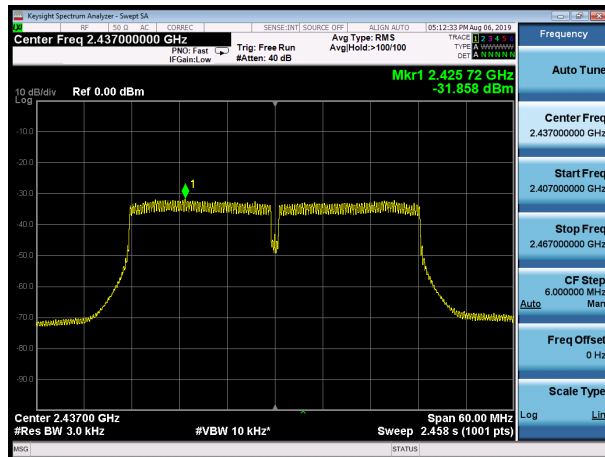

802.11n(HT40), Channel No. 9

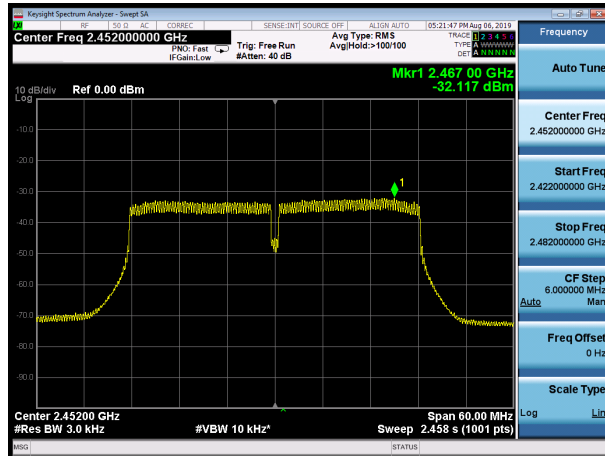

5.5. Spurious RF Conducted Emissions

Ambient condition

Temperature	Relative humidity	Pressure
23°C ~25°C	45%~50%	101.5kPa

Method of Measurement

The EUT was connected to the spectrum analyzer with a known loss. The spectrum analyzer scans from 30MHz to the 10th harmonic of the carrier. The peak detector is used. Set RBW to 100 kHz and VBW to 300 kHz, Sweep is set to ATUO.

The test is in transmitting mode.

Test setup



Limits

Rule Part 15.247(d) pacifies that “In any 100 kHz bandwidth outside the frequency band in which the spread spectrum or digitally modulated intentional radiator is operating, the radio frequency power that is produced by the intentional radiator shall be at least 20 dB below that in the 100 kHz bandwidth within the band that contains the highest level of the desired power, based on either an RF conducted or a radiated measurement, provided the transmitter demonstrates compliance with the peak conducted power limits. If the transmitter complies with the conducted power limits based on the use of RMS averaging over a time interval, as permitted under paragraph (b)(3) of this section, the attenuation required under this paragraph shall be 30 dB instead of 20 dB. ”

Network Standards	Carrier frequency (MHz)	Reference value (dBm)	Limit
802.11b	2412	7.97	-22.03
	2437	9.72	-20.28
	2462	7.73	-22.27
802.11g	2412	-0.77	-30.77
	2437	6.52	-23.48
	2462	-0.94	-30.94
802.11n HT20	2412	-0.68	-30.68
	2437	3.98	-26.02
	2462	-0.63	-30.63
802.11n HT40	2422	-7.65	-37.65
	2437	-7.50	-37.50
	2452	-8.71	-38.71

**Measurement Uncertainty**

The assessed measurement uncertainty to ensure 95% confidence level for the normal distribution is with the coverage factor $k = 1.96$.

Frequency	Uncertainty
100kHz-2GHz	0.684 dB
2GHz-26GHz	1.407 dB



Test Results:

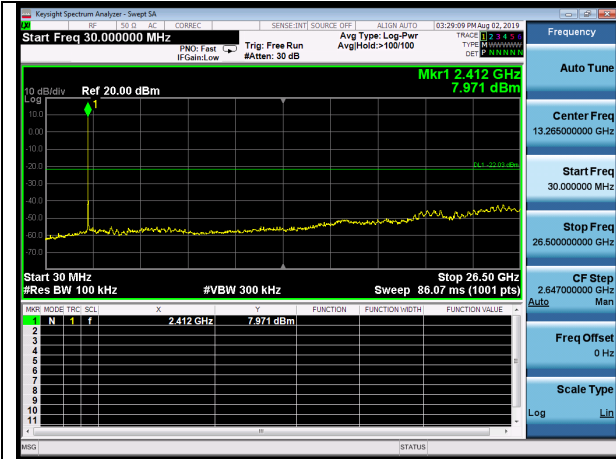

802.11b CH1 30MHz to 26.5GHz

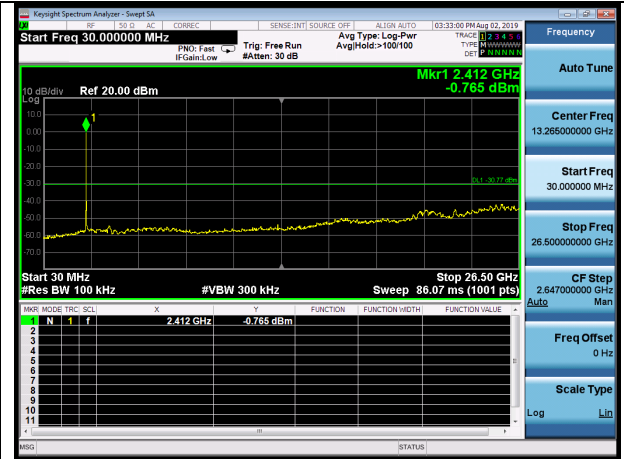

802.11g CH1 30MHz to 26.5GHz

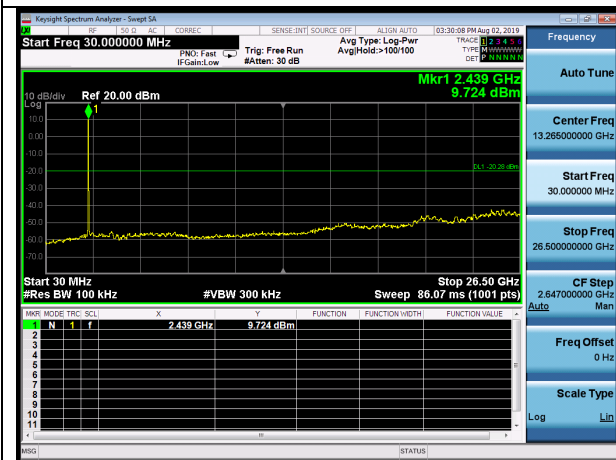

802.11b CH6 30MHz to 26.5GHz

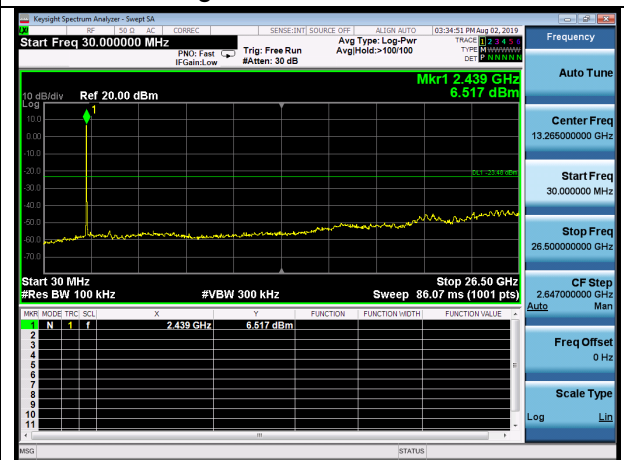

802.11g CH6 30MHz to 26.5GHz

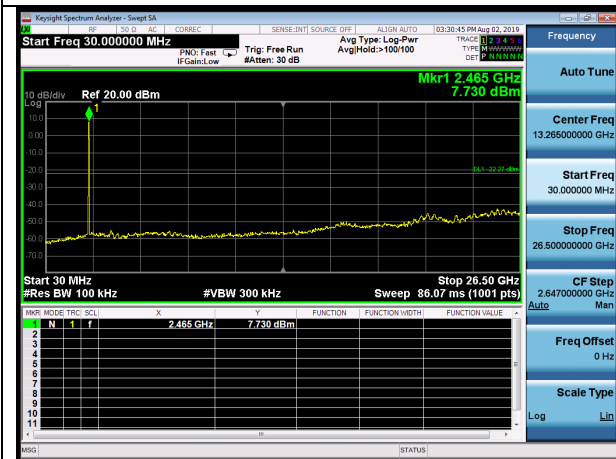

802.11b CH11 30MHz to 26.5GHz

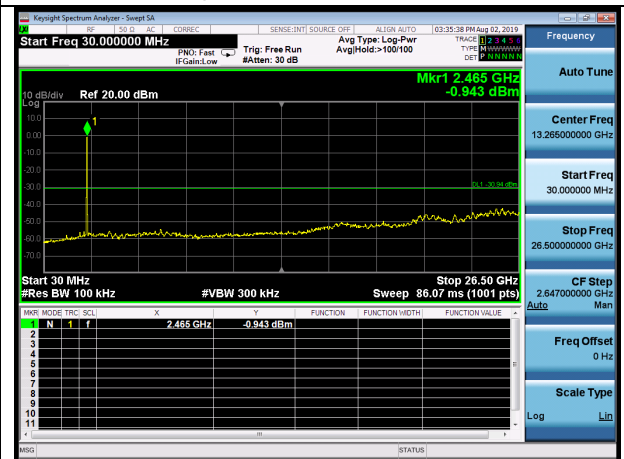

802.11g CH11 30MHz to 26.5GHz

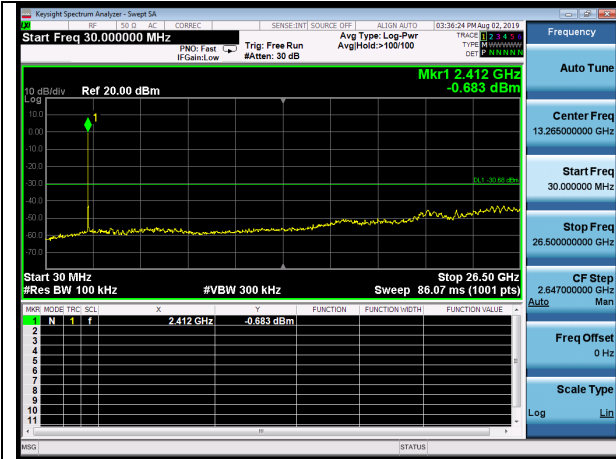

802.11n (HT20) CH1 30MHz to 26.5GHz

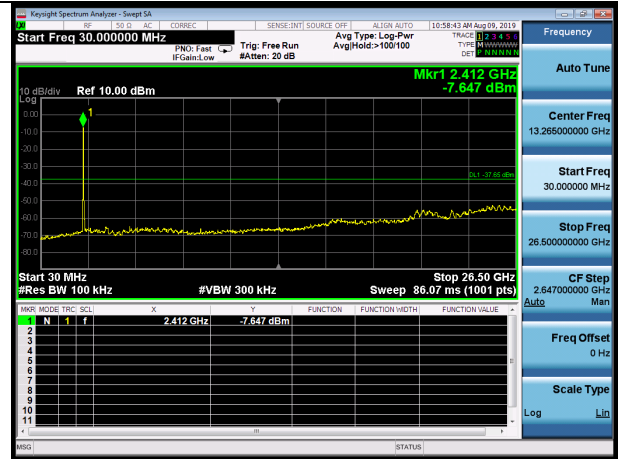

802.11n (HT40) CH3 30MHz to 26.5GHz

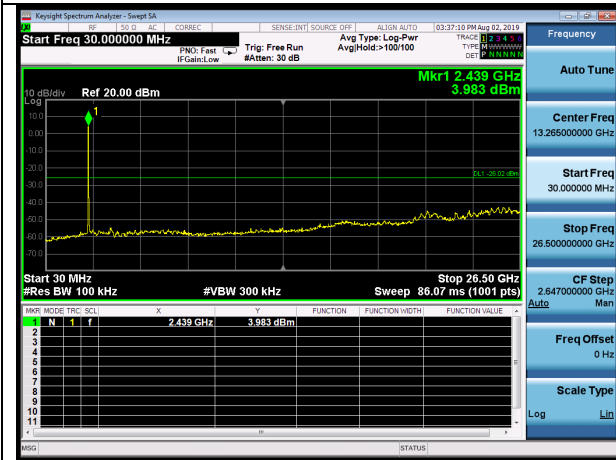

802.11n (HT20) CH6 30MHz to 26.5GHz

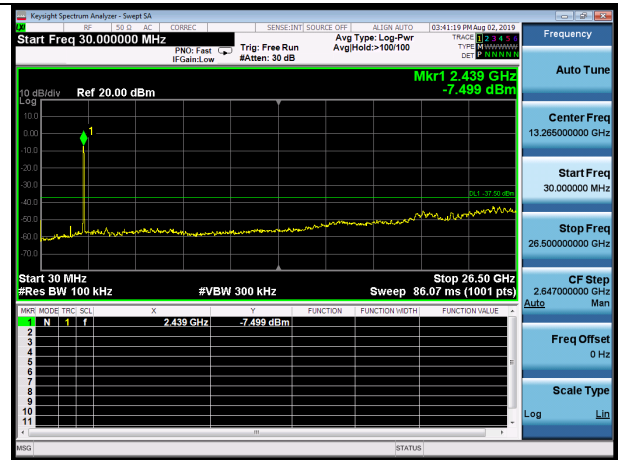

802.11n (HT40) CH6 30MHz to 26.5GHz

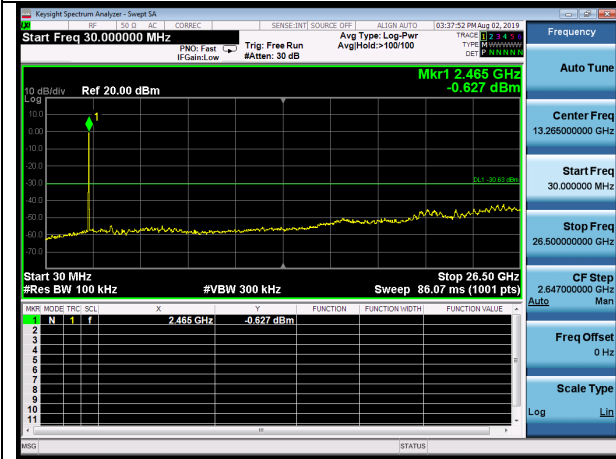

802.11n (HT20) CH11 30MHz to 26.5GHz

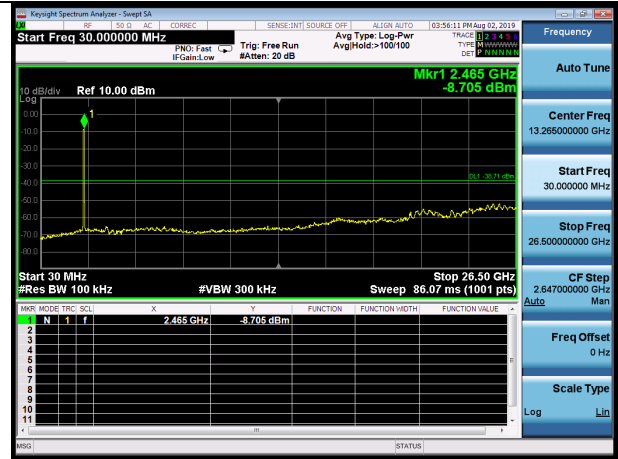

802.11n (HT40) CH9 30MHz to 26.5GHz

5.6. Unwanted Emission

Ambient condition

Temperature	Relative humidity	Pressure
23°C ~25°C	45%~50%	102.5kPa

Method of Measurement

The test set-up was made in accordance to the general provisions of ANSI C63.10-2013.

The Equipment Under Test (EUT) was set up on a non-conductive table in the semi-anechoic chamber. The test was performed at the distance of 3 m between the EUT and the receiving antenna.

The turntable shall be rotated from 0 to 360 degrees for detecting the maximum of radiated spurious signal level. The measurements shall be repeated with orthogonal polarization of the test antenna. The data of cable loss and antenna factor has been calibrated in full testing frequency range before the testing. Sweep the Restricted Band and the emissions less than 20 dB below the permissible value are reported.

The radiated emissions measurements were made in a typical installation configuration.

Sweep the whole frequency band through the range from 9 kHz to the 10th harmonic of the carrier, and the emissions less than 20 dB below the permissible value are reported.

This method refer to ANSI C63.10-2013.

The procedure for peak unwanted emissions measurements above 1000 MHz is as follows:

I) Peak emission levels are measured by setting the instrument as follows:

- 1) RBW = 1 MHz.
- 2) VBW \geq [3 \times RBW]
- 3) Detector = peak.
- 4) Sweep time = auto.
- 5) Trace mode = max hold.
- 6) Allow sweeps to continue until the trace stabilizes. Note that if the transmission is not continuous, then the time required for the trace to stabilize will increase by a factor of approximately 1 / D, where D is the duty cycle.

II) Average emission levels are measured by setting the instrument as follows:

- a) RBW = 1 MHz.
- b) VBW \geq [3 \times RBW].
- c) Detector = RMS (power averaging), if [span / (# of points in sweep)] \leq RBW / 2. Satisfying this condition can require increasing the number of points in the sweep or reducing the span. If the condition is not satisfied, then the detector mode shall be set to peak.
- d) Averaging type = power (i.e., rms) (As an alternative, the detector and averaging type may be set for linear voltage averaging. Some instruments require linear display mode to use linear voltage



averaging. Log or dB averaging shall not be used.)

e) Sweep time = auto.

f) Perform a trace average of at least 100 traces if the transmission is continuous. If the transmission is not continuous, then the number of traces shall be increased by a factor of $1 / D$, where D is the duty cycle. For example, with 50% duty cycle, at least 200 traces shall be averaged. (If a specific emission is demonstrated to be continuous—i.e., 100% duty cycle—then rather than turning ON and OFF with the transmit cycle, at least 100 traces shall be averaged.)

g) If tests are performed with the EUT transmitting at a duty cycle less than 98%, then a correction factor shall be added to the measurement results prior to comparing with the emission limit, to compute the emission level that would have been measured had the test been performed at 100% duty cycle. The correction factor is computed as follows:

1) If power averaging (rms) mode was used in the preceding step e), then the correction factor is $[10 \log (1 / D)]$, where D is the duty cycle. For example, if the transmit duty cycle was 50%, then 3 dB shall be added to the measured emission levels.

2) If linear voltage averaging mode was used in the preceding step e), then the correction factor is $[20 \log (1 / D)]$, where D is the duty cycle. For example, if the transmit duty cycle was 50%, then 6 dB shall be added to the measured emission levels.

3) If a specific emission is demonstrated to be continuous (100% duty cycle) rather than turning ON and OFF with the transmit cycle, then no duty cycle correction is required for that emission.

The test is in transmitting mode.

Test setup

9KHz ~ 30MHz

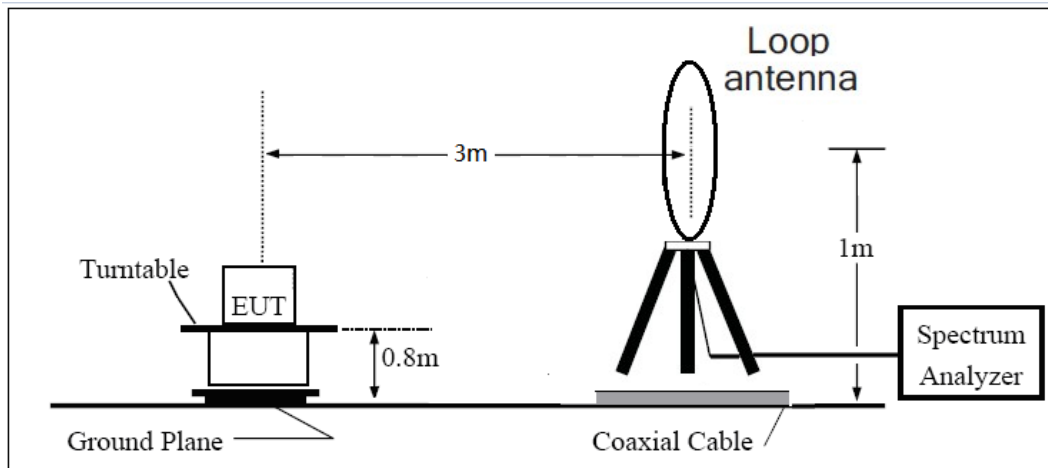

30MHz ~ 1GHz

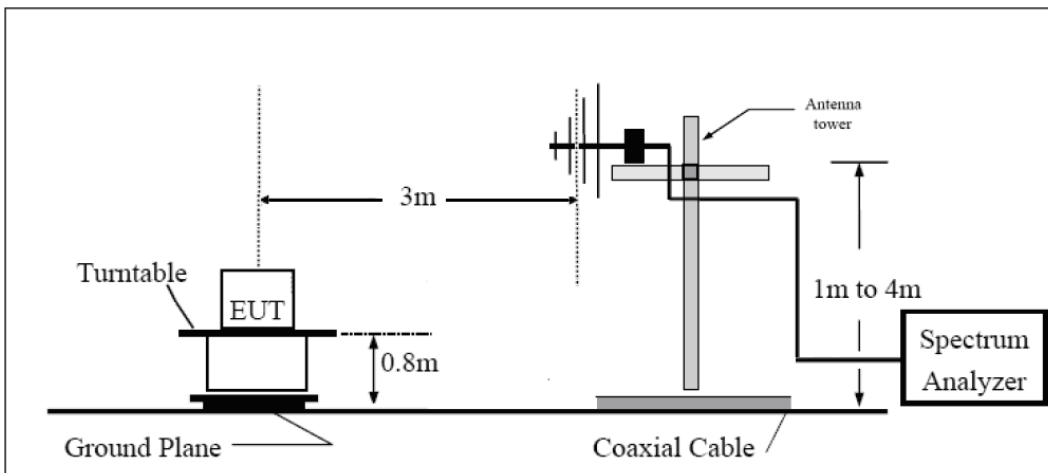

Above 1GHz

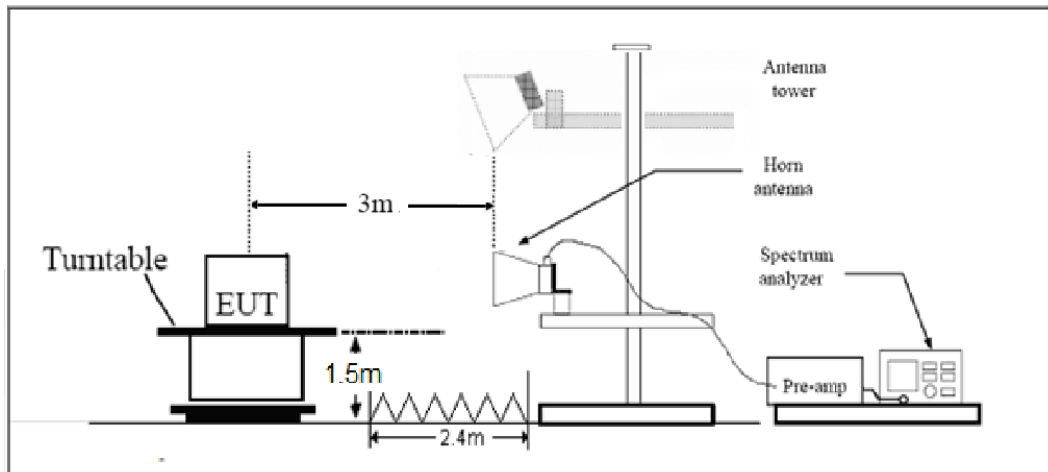

Note: Area side:2.4mX3.6m

**Limits**

Rule Part 15.247(d) specifies that "In addition, radiated emissions which fall in the restricted bands, as defined in § 15.205(a), must also comply with the radiated emission limits specified in § 15.209(a) (see § 15.205(c))."

Limit in restricted band

Frequency of emission (MHz)	Field strength(uV/m)	Field strength(dBuV/m)
0.009–0.490	2400/F(kHz)	/
0.490–1.705	24000/F(kHz)	/
1.705–30.0	30	/
30-88	100	40
88-216	150	43.5
216-960	200	46
Above960	500	54

§15.35(b)

There is also a limit on the radio frequency emissions, as measured using instrumentation with a peak detector function, corresponding to 20 dB above the maximum permitted average limit.

Peak Limit=74 dBuV/m

Average Limit=54 dBuV/m

Spurious Radiated Emissions are permitted in any of the frequency bands listed below:

MHz	MHz	MHz	GHz
0.090 - 0.110	16.42 - 16.423	399.9 - 410	4.5 - 5.15
¹ 0.495 - 0.505	16.69475 - 16.69525	608 - 614	5.35 - 5.46
2.1735 - 2.1905	16.80425 - 16.80475	960 - 1240	7.25 - 7.75
4.125 - 4.128	25.5 - 25.67	1300 - 1427	8.025 - 8.5
4.17725 - 4.17775	37.5 - 38.25	1435 - 1626.5	9.0 - 9.2
4.20725 - 4.20775	73 - 74.6	1645.5 - 1646.5	9.3 - 9.5
6.215 - 6.218	74.8 - 75.2	1660 - 1710	10.6 - 12.7
6.26775 - 6.26825	108 - 121.94	1718.8 - 1722.2	13.25 - 13.4
6.31175 - 6.31225	123 - 138	2200 - 2300	14.47 - 14.5
8.291 - 8.294	149.9 - 150.05	2310 - 2390	15.35 - 16.2
8.362 - 8.366	156.52475 - 156.52525	2483.5 - 2500	17.7 - 21.4
8.37625 - 8.38675	156.7 - 156.9	2690 - 2900	22.01 - 23.12
8.41425 - 8.41475	162.0125 - 167.17	3260 - 3267	23.6 - 24.0
12.29 - 12.293	167.72 - 173.2	3332 - 3339	31.2 - 31.8
12.51975 - 12.52025	240 - 285	3345.8 - 3358	36.43 - 36.5
12.57675 - 12.57725	322 - 335.4	3600 - 4400	(²)
13.36 - 13.41			

**Measurement Uncertainty**

The assessed measurement uncertainty to ensure 95% confidence level for the normal distribution is with the coverage factor $k = 1.96$.

Frequency	Uncertainty
9KHz-30MHz	3.55 dB
30MHz-200MHz	4.02 dB
200MHz-1GHz	3.28 dB
1-18GHz	3.70 dB
18-26.5GHz	5.78 dB



Test Results:

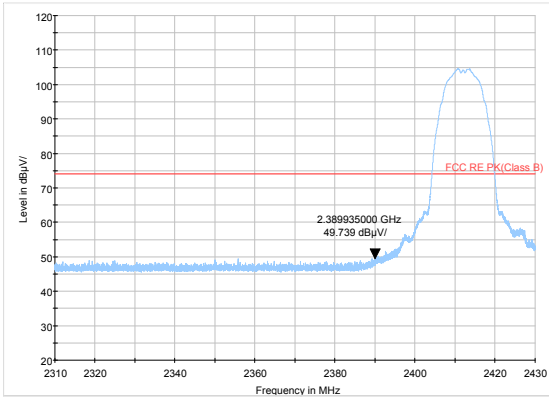

802.11b-Channel 1 Peak

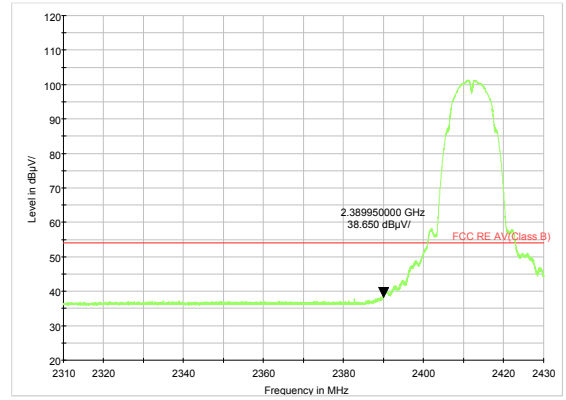

802.11b-Channel 1 Average

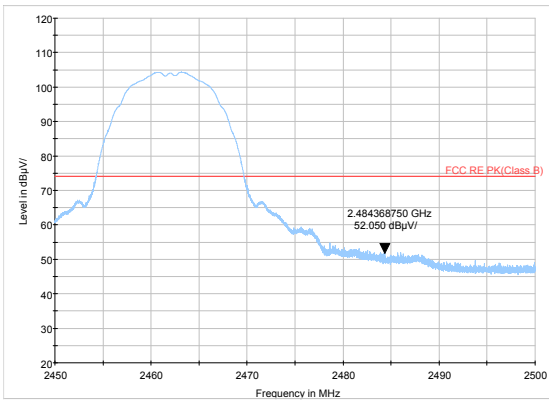

802.11b-Channel 11 Peak

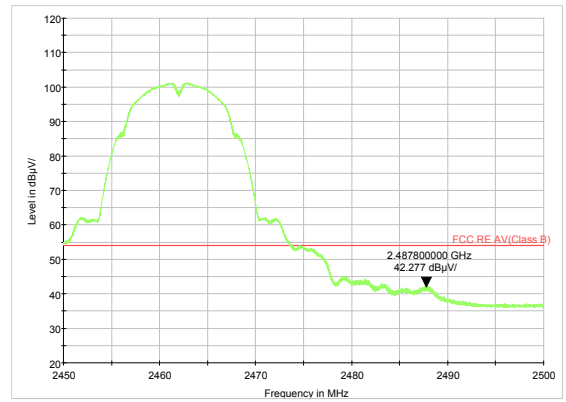

802.11b-Channel 11 Average

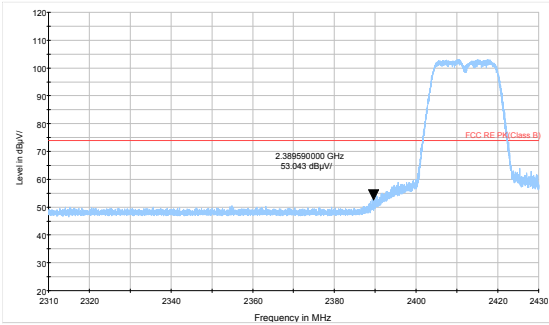

802.11g-Channel 1 Peak

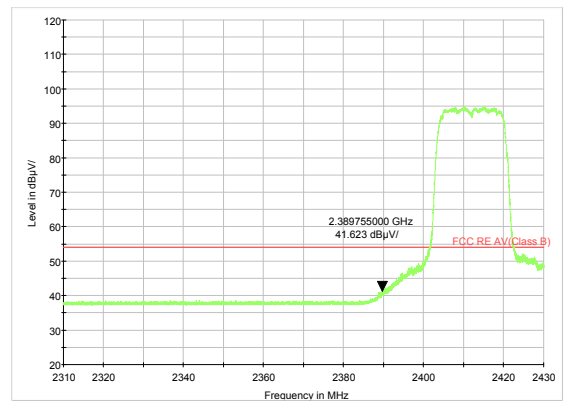

802.11g-Channel 1 Average

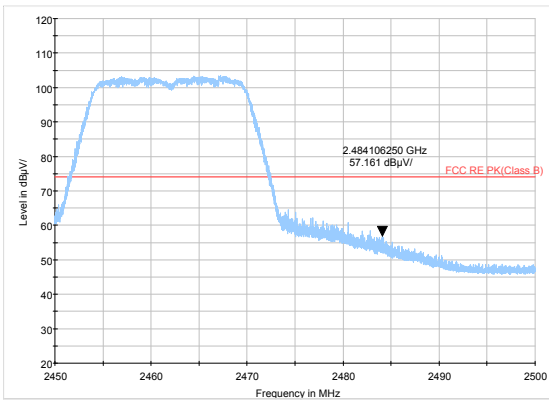

802.11g-Channel 11 Peak

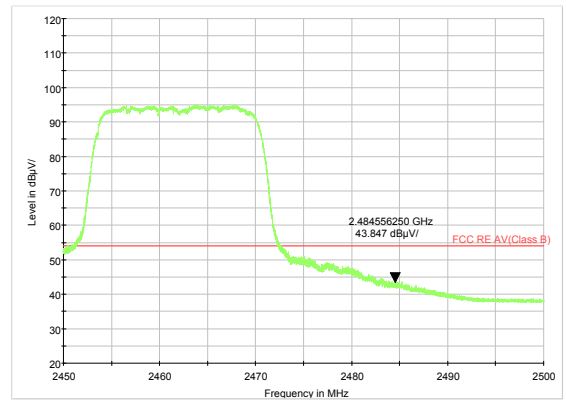

802.11g-Channel 11 Average

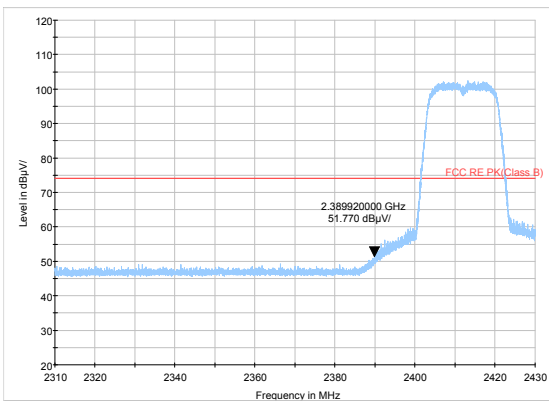

802.11n HT20 -Channel 1 Peak

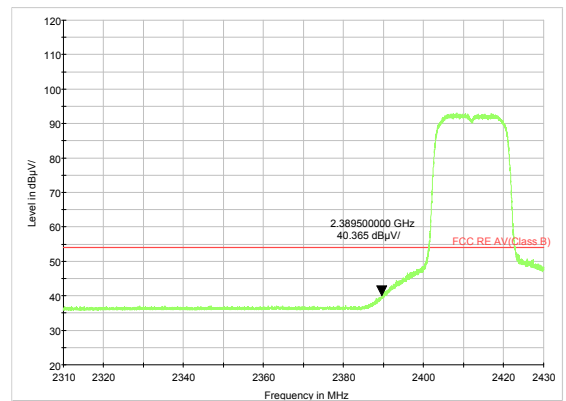

802.11n HT20 -Channel 1 Average

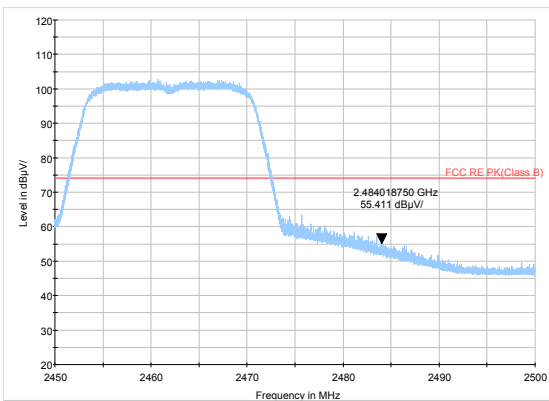

802.11n HT20 -Channel 11 Peak

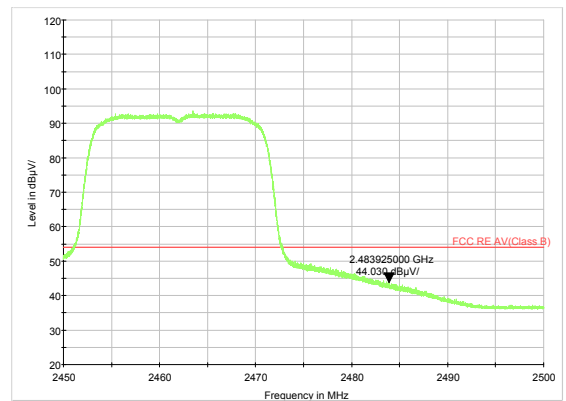

802.11n HT20 -Channel 11 Average

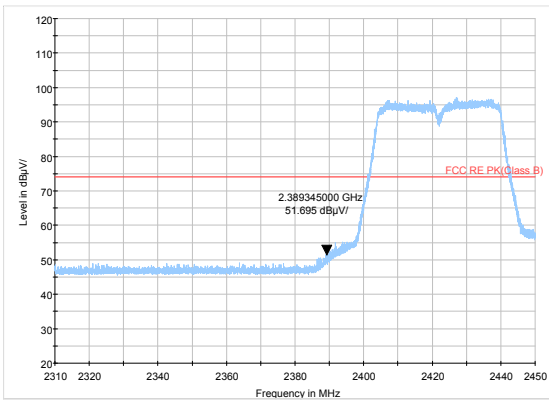

802.11n HT40 -Channel 3 Peak

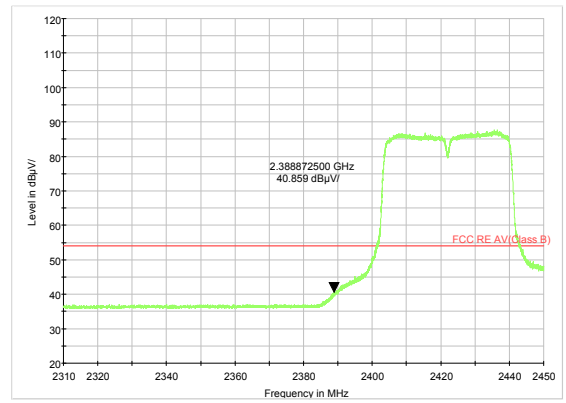

802.11n HT40 -Channel 3 Average

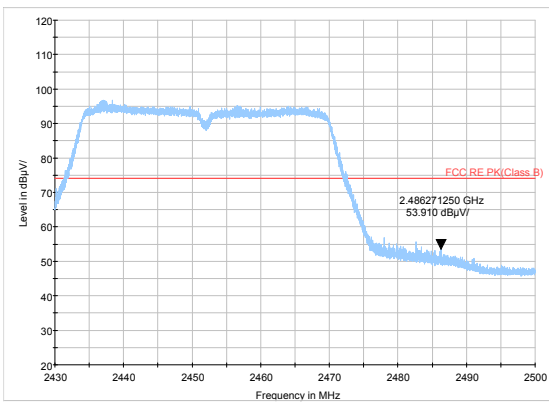

802.11n HT40 -Channel 9 Peak

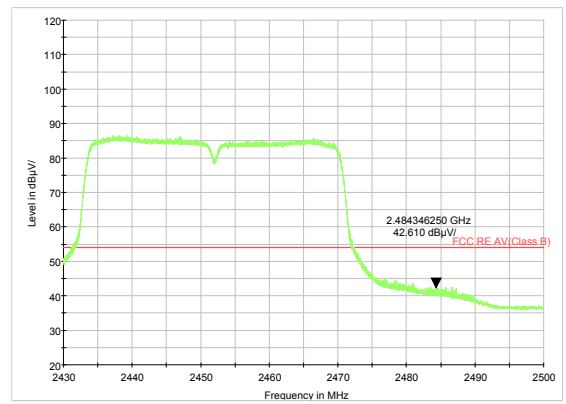

802.11n HT40 -Channel 9 Average

Result of RE

Test result

Sweep the whole frequency band through the range from 9kHz to the 10th harmonic of the carrier, the Emissions in the frequency band 9kHz-30MHz and 18GHz-26.5GHz are more than 20dB below the limit are not reported.

The following graphs display the maximum values of horizontal and vertical by software. For above 1GHz, Blue trace uses the peak detection, Green trace uses the average detection.

After the pretest, MIMO was selected as the worst.

During the test, the Radiates Emission from 30MHz to 1GHz was performed in all modes with all channels, 802.11g CH6 are selected as the worst condition. The test data of the worst-case condition was recorded in this report.

Continuous TX mode:

FCC RE 9K-90KHz AV

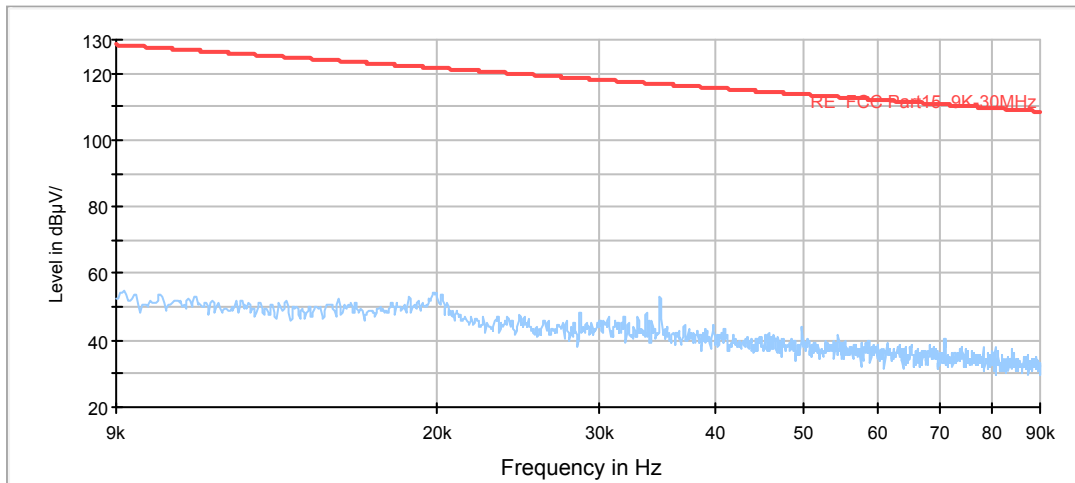

Radiates Emission from 9KHz to 90KHz

FCC RE 90K-110KHz QP

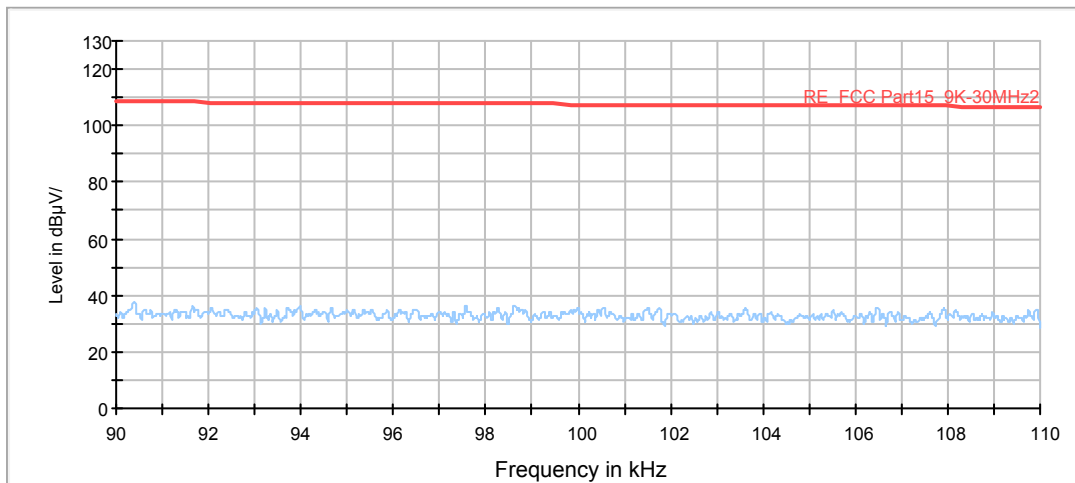

Radiates Emission from 90KHz to 110KHz

FCC RE 110K-490KHz AV

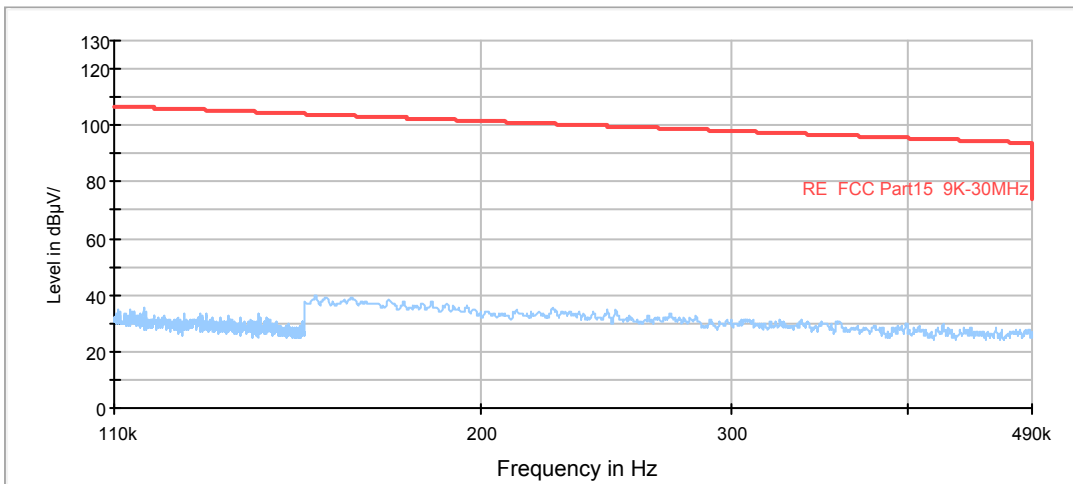

Radiates Emission from 110KHz to 490KHz

FCC RE 490K-30MHz QP

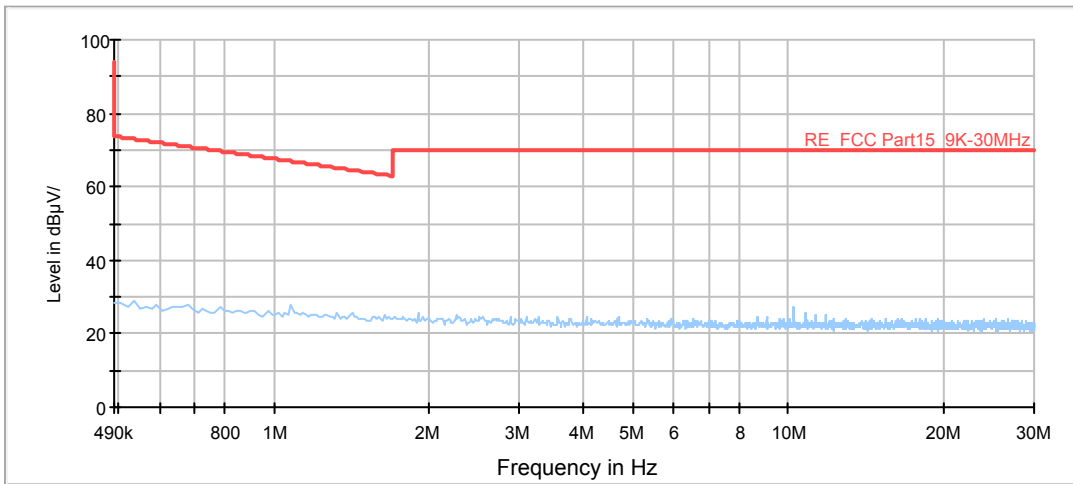

Radiates Emission from 490KHz to 30MHz

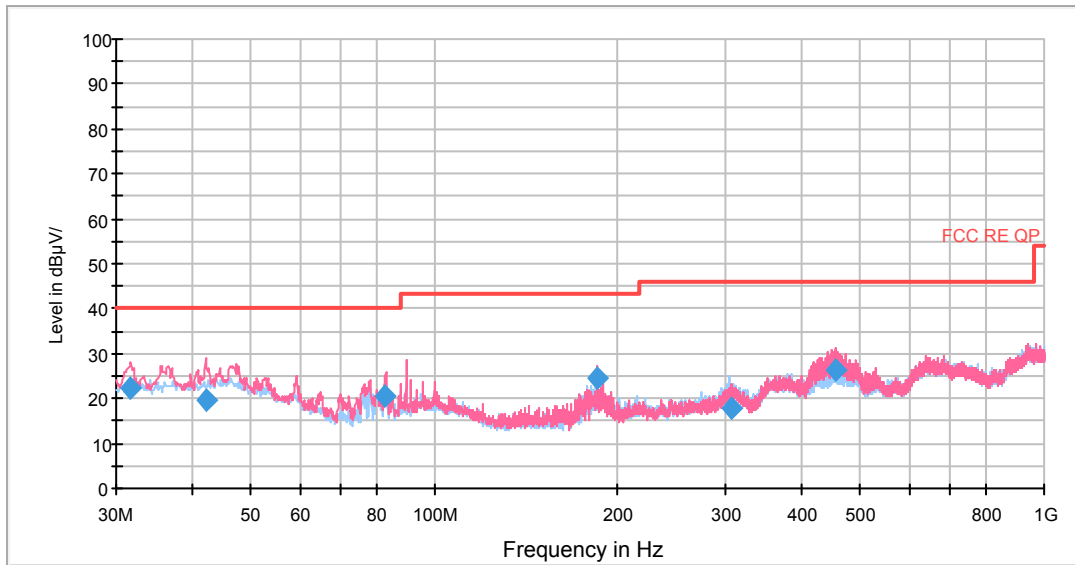

Radiates Emission from 30MHz to 1GHz

Frequency (MHz)	Quasi-Peak (dBuV/m)	Height (cm)	Polarization	Azimuth (deg)	Correct Factor (dB)	Margin (dB)	Limit (dBuV/m)
31.618256	22.5	100.0	V	95.0	-3.1	17.5	40.0
42.219688	19.5	125.0	V	26.0	-4.3	20.5	40.0
82.979731	20.6	100.0	V	109.0	-11.9	19.4	40.0
184.249425	24.6	100.0	V	174.0	-13.0	18.9	43.5
306.076500	18.0	100.0	H	310.0	-8.5	28.0	46.0
455.415250	26.3	100.0	V	182.0	-6.9	19.7	46.0

Remark: 1. Correction Factor = Antenna factor+ Insertion loss(cable loss+amplifier gain)
 2. Margin = Limit – Quasi-Peak

802.11b CH1

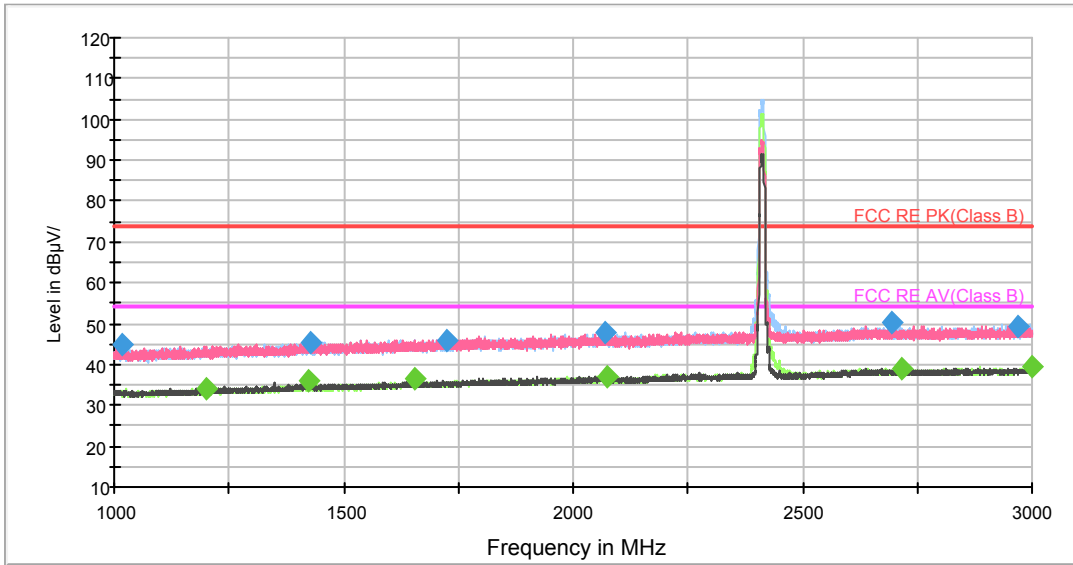

Note: The signal beyond the limit is carrier.
Radiates Emission from 1GHz to 3GHz

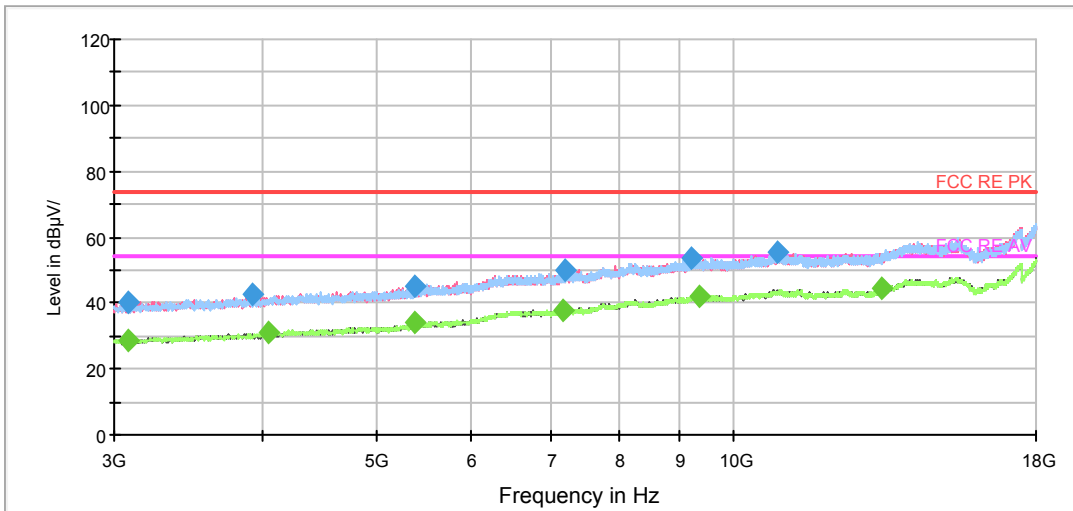

Radiates Emission from 3GHz to 18GHz



Frequency (MHz)	Peak (dBuV/m)	Height (cm)	Polarization	Azimuth (deg)	Correct Factor (dB)	Margin (dB)	Limit (dBuV/m)
1015.500000	44.7	100.0	H	265.0	-0.5	29.3	74.0
1429.000000	45.4	200.0	V	163.0	2.0	28.6	74.0
1723.250000	46.0	100.0	V	163.0	3.1	28.0	74.0
2069.000000	47.9	100.0	V	9.0	4.4	26.1	74.0
2695.500000	50.1	200.0	V	259.0	7.0	23.9	74.0
2967.750000	49.5	100.0	H	0.0	8.1	24.5	74.0

Remark: 1. Correction Factor = Antenna factor+ Insertion loss (cable loss + amplifier gain)

Frequency (MHz)	Average (dBuV/m)	Height (cm)	Polarization	Azimuth (deg)	Correct Factor (dB)	Margin (dB)	Limit (dBuV/m)
1199.750000	34.3	100.0	V	290.0	0.7	19.7	54.0
1422.500000	35.8	200.0	V	126.0	2.0	18.2	54.0
1656.250000	36.4	100.0	H	296.0	2.8	17.6	54.0
2074.750000	37.0	100.0	V	91.0	4.4	17.0	54.0
2717.250000	39.0	100.0	H	243.0	7.1	15.0	54.0
2999.000000	39.4	200.0	V	206.0	8.2	14.6	54.0

Remark: 1. Correction Factor = Antenna factor+ Insertion loss (cable loss + amplifier gain)

802.11b CH6

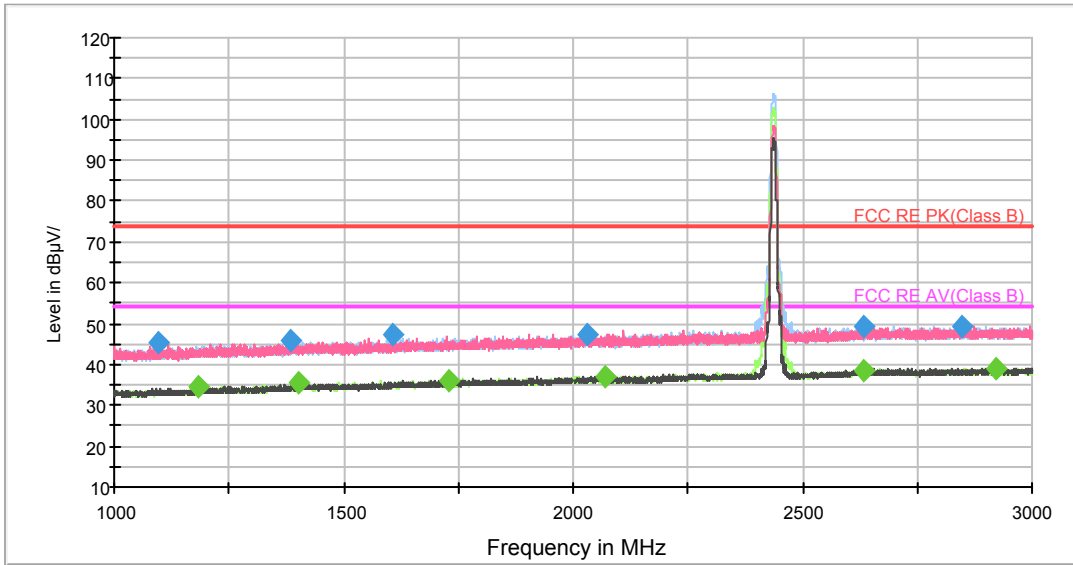

Note: The signal beyond the limit is carrier.
Radiates Emission from 1GHz to 3GHz

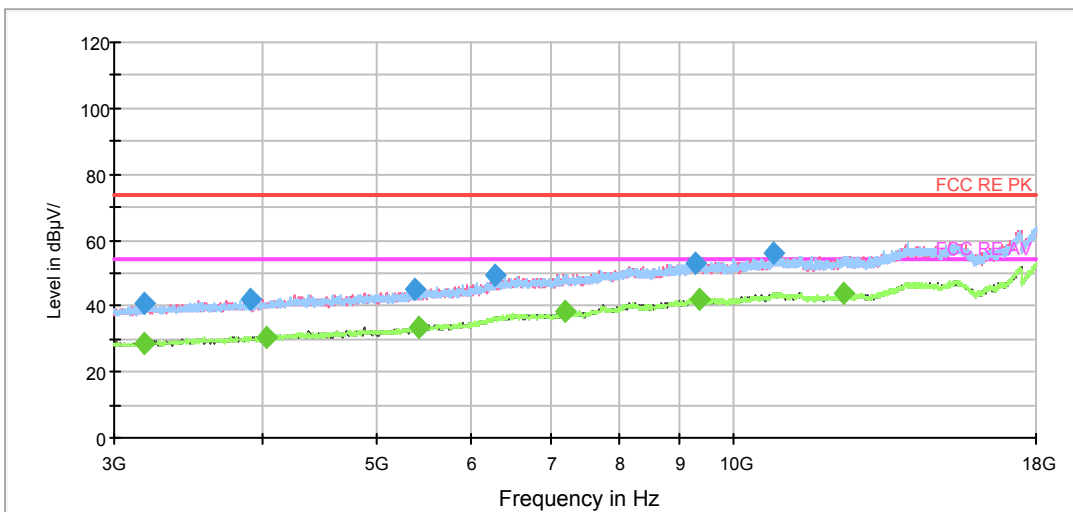

Radiates Emission from 3GHz to 18GHz



Frequency (MHz)	Peak (dBuV/m)	Height (cm)	Polarization	Azimuth (deg)	Correct Factor (dB)	Margin (dB)	Limit (dBuV/m)
1097.500000	45.2	100.0	V	73.0	0.1	28.8	74.0
1385.000000	45.7	100.0	H	53.0	1.7	28.3	74.0
1609.000000	47.3	200.0	V	81.0	2.6	26.7	74.0
2032.000000	47.4	200.0	V	117.0	4.4	26.6	74.0
2632.000000	49.2	100.0	H	338.0	6.8	24.8	74.0
2848.250000	49.4	100.0	V	6.0	7.5	24.6	74.0

Remark: 1. Correction Factor = Antenna factor+ Insertion loss (cable loss + amplifier gain)

Frequency (MHz)	Average (dBuV/m)	Height (cm)	Polarization	Azimuth (deg)	Correct Factor (dB)	Margin (dB)	Limit (dBuV/m)
1182.500000	34.3	200.0	V	89.0	0.6	19.7	54.0
1403.500000	35.4	100.0	H	226.0	1.9	18.6	54.0
1731.000000	36.0	100.0	V	169.0	3.1	18.0	54.0
2067.750000	37.2	200.0	V	139.0	4.4	16.8	54.0
2631.750000	38.5	100.0	H	287.0	6.8	15.5	54.0
2919.250000	39.1	100.0	H	219.0	7.8	14.9	54.0

Remark: 1. Correction Factor = Antenna factor+ Insertion loss (cable loss + amplifier gain)

802.11b CH11

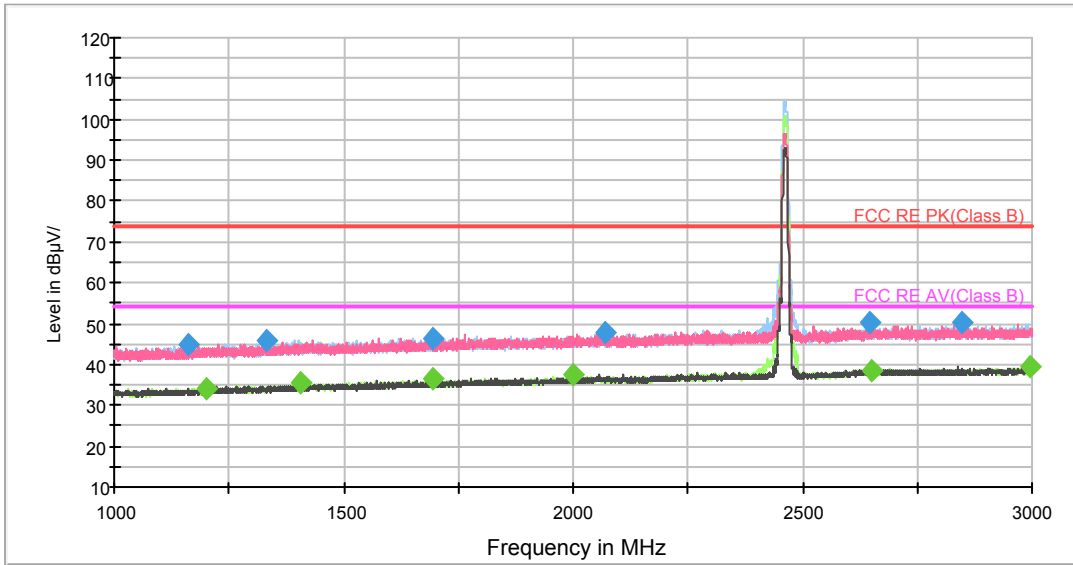

Note: The signal beyond the limit is carrier.
Radiates Emission from 1GHz to 3GHz

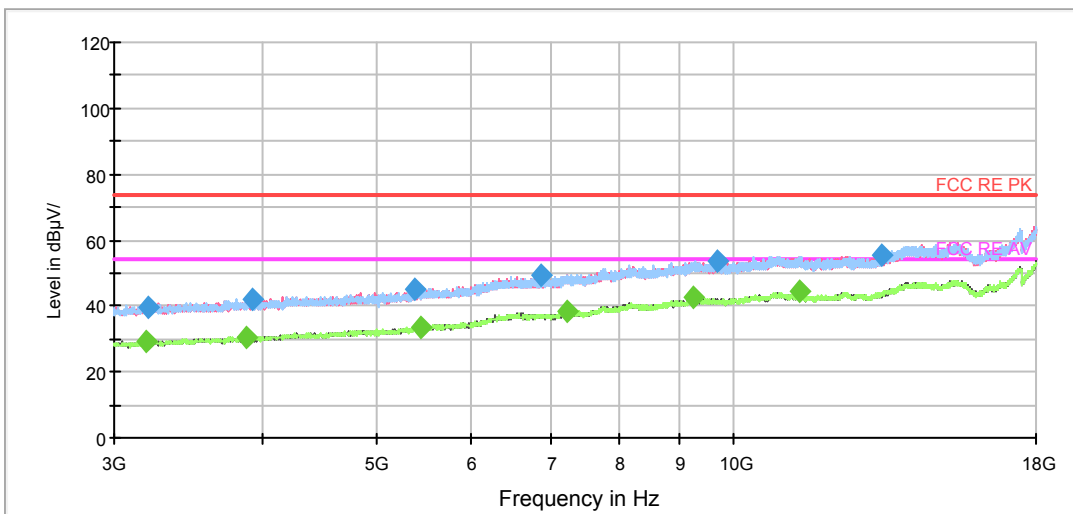

Radiates Emission from 3GHz to 18GHz



Frequency (MHz)	Peak (dBuV/m)	Height (cm)	Polarization	Azimuth (deg)	Correct Factor (dB)	Margin (dB)	Limit (dBuV/m)
1163.000000	44.7	100.0	H	189.0	0.5	29.3	74.0
1331.000000	46.0	200.0	H	263.0	1.4	28.0	74.0
1693.750000	46.5	100.0	H	226.0	3.0	27.5	74.0
2069.250000	47.9	100.0	H	93.0	4.4	26.1	74.0
2645.750000	50.0	200.0	H	212.0	6.9	24.0	74.0
2849.000000	50.0	200.0	V	255.0	7.6	24.0	74.0

Remark: 1. Correction Factor = Antenna factor+ Insertion loss (cable loss + amplifier gain)

Frequency (MHz)	Average (dBuV/m)	Height (cm)	Polarization	Azimuth (deg)	Correct Factor (dB)	Margin (dB)	Limit (dBuV/m)
1200.250000	34.2	100.0	V	218.0	0.8	19.8	54.0
1406.250000	35.4	100.0	H	12.0	1.9	18.6	54.0
1696.500000	36.4	100.0	V	127.0	3.0	17.6	54.0
2000.750000	37.4	200.0	V	14.0	4.3	16.6	54.0
2652.750000	38.7	100.0	H	0.0	6.9	15.3	54.0
2994.000000	39.3	100.0	V	218.0	8.2	14.7	54.0

Remark: 1. Correction Factor = Antenna factor+ Insertion loss (cable loss + amplifier gain)



802.11g CH1

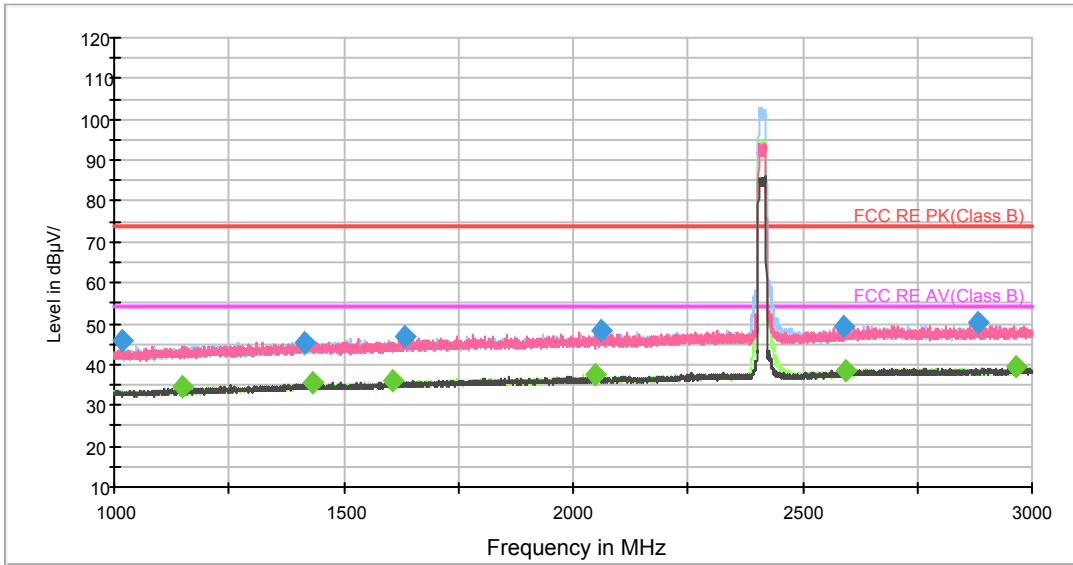

Note: The signal beyond the limit is carrier.
Radiates Emission from 1GHz to 3GHz

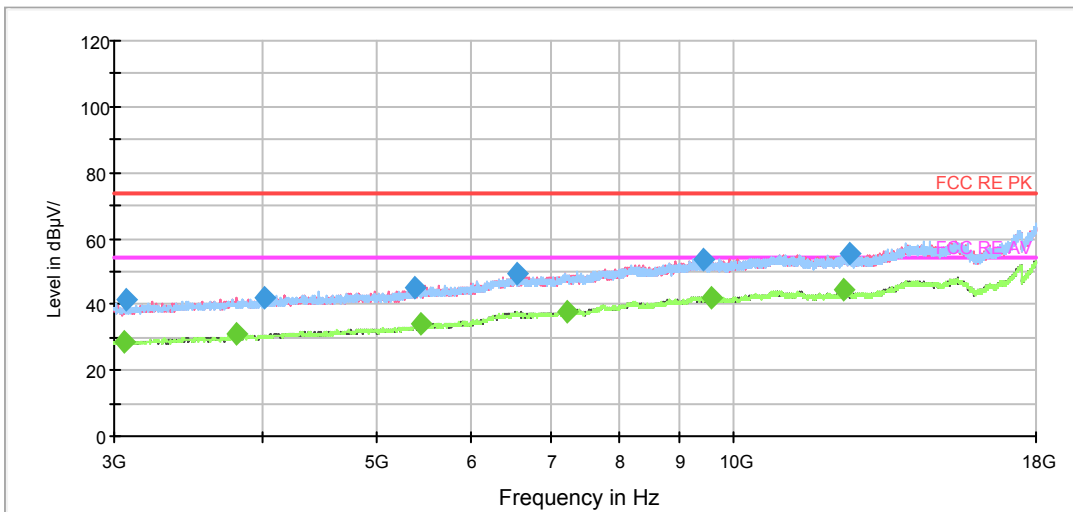

Radiates Emission from 3GHz to 18GHz



Frequency (MHz)	Peak (dBuV/m)	Height (cm)	Polarization	Azimuth (deg)	Correct Factor (dB)	Margin (dB)	Limit (dBuV/m)
1016.500000	45.6	100.0	V	120.0	-0.5	28.4	74.0
1415.750000	45.6	200.0	H	87.0	1.9	28.4	74.0
1632.250000	46.9	100.0	H	273.0	2.7	27.1	74.0
2062.750000	48.2	200.0	V	158.0	4.4	25.8	74.0
2590.750000	49.4	100.0	V	75.0	6.6	24.6	74.0
2883.750000	50.1	100.0	H	0.0	7.7	23.9	74.0

Remark: 1. Correction Factor = Antenna factor+ Insertion loss (cable loss + amplifier gain)

Frequency (MHz)	Average (dBuV/m)	Height (cm)	Polarization	Azimuth (deg)	Correct Factor (dB)	Margin (dB)	Limit (dBuV/m)
1149.500000	34.6	100.0	V	16.0	0.4	19.4	54.0
1433.000000	35.6	100.0	V	68.0	2.0	18.4	54.0
1607.000000	36.1	100.0	H	340.0	2.6	17.9	54.0
2048.500000	37.5	100.0	V	173.0	4.4	16.5	54.0
2595.250000	38.5	200.0	V	8.0	6.6	15.5	54.0
2963.000000	39.3	100.0	H	304.0	8.0	14.7	54.0

Remark: 1. Correction Factor = Antenna factor+ Insertion loss (cable loss + amplifier gain)

802.11g CH6

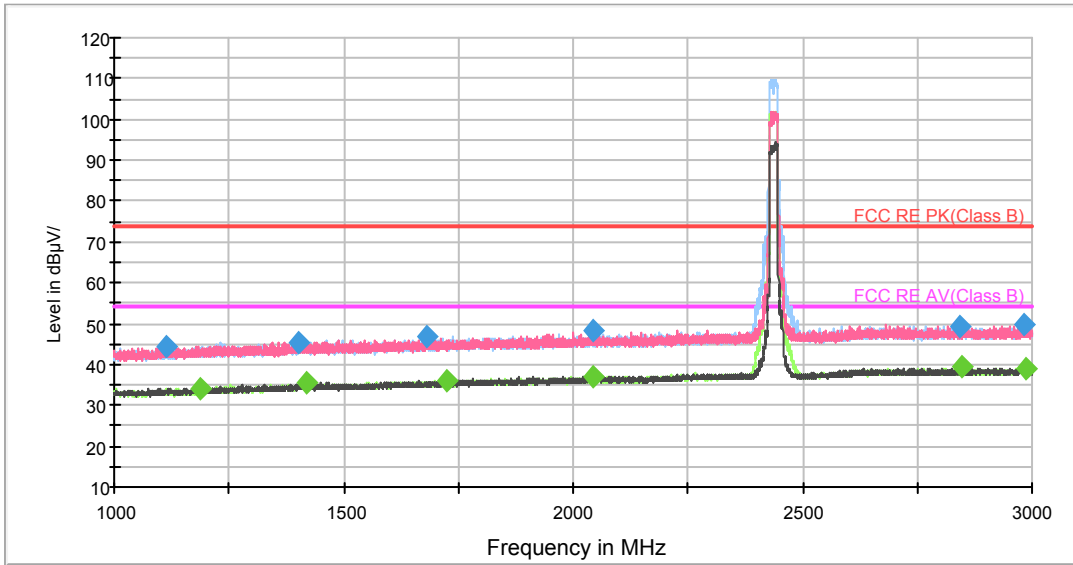

Note: The signal beyond the limit is carrier.
Radiates Emission from 1GHz to 3GHz

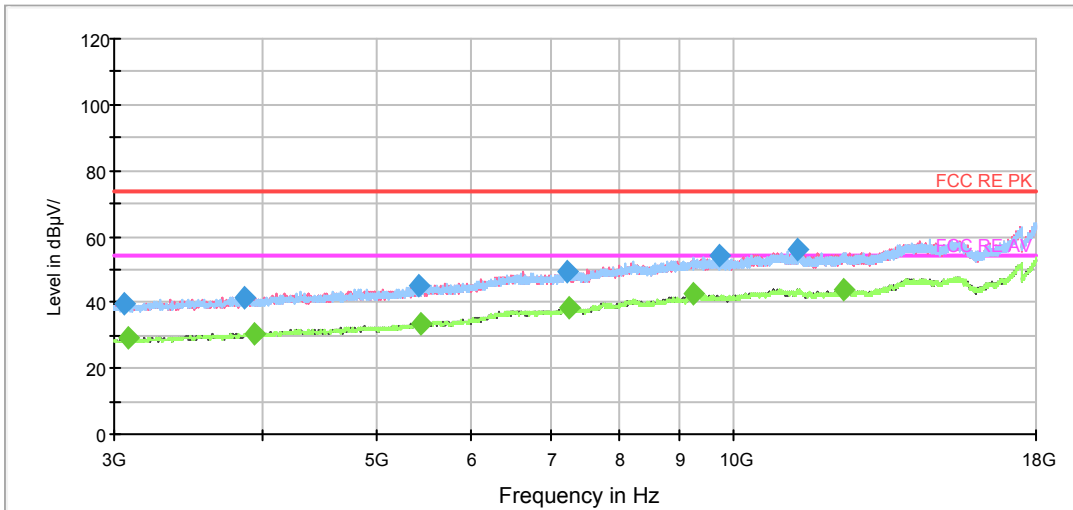

Radiates Emission from 3GHz to 18GHz



Frequency (MHz)	Peak (dBuV/m)	Height (cm)	Polarization	Azimuth (deg)	Correct Factor (dB)	Margin (dB)	Limit (dBuV/m)
1113.500000	44.6	100.0	H	340.0	0.2	29.4	74.0
1399.750000	45.5	200.0	H	0.0	1.8	28.5	74.0
1680.000000	46.6	100.0	V	252.0	2.9	27.4	74.0
2043.500000	48.4	200.0	V	43.0	4.4	25.6	74.0
2842.000000	49.3	100.0	V	149.0	7.5	24.7	74.0
2983.250000	49.9	200.0	H	302.0	8.1	24.1	74.0

Remark: 1. Correction Factor = Antenna factor+ Insertion loss (cable loss + amplifier gain)

Frequency (MHz)	Average (dBuV/m)	Height (cm)	Polarization	Azimuth (deg)	Correct Factor (dB)	Margin (dB)	Limit (dBuV/m)
1189.750000	34.3	200.0	V	51.0	0.7	19.7	54.0
1419.000000	35.4	200.0	V	111.0	1.9	18.6	54.0
1722.750000	36.1	100.0	H	355.0	3.1	17.9	54.0
2044.250000	37.3	100.0	H	0.0	4.4	16.7	54.0
2845.750000	39.3	100.0	V	14.0	7.5	14.7	54.0
2988.000000	39.1	100.0	V	344.0	8.2	14.9	54.0

Remark: 1. Correction Factor = Antenna factor+ Insertion loss (cable loss + amplifier gain)



802.11g CH11

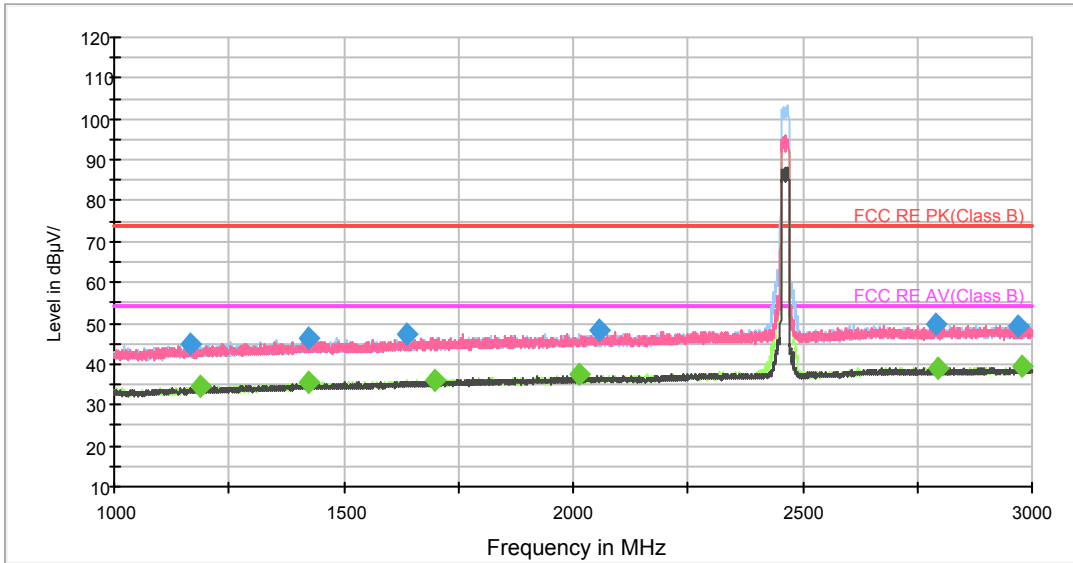

Note: The signal beyond the limit is carrier.

Radiates Emission from 1GHz to 3GHz

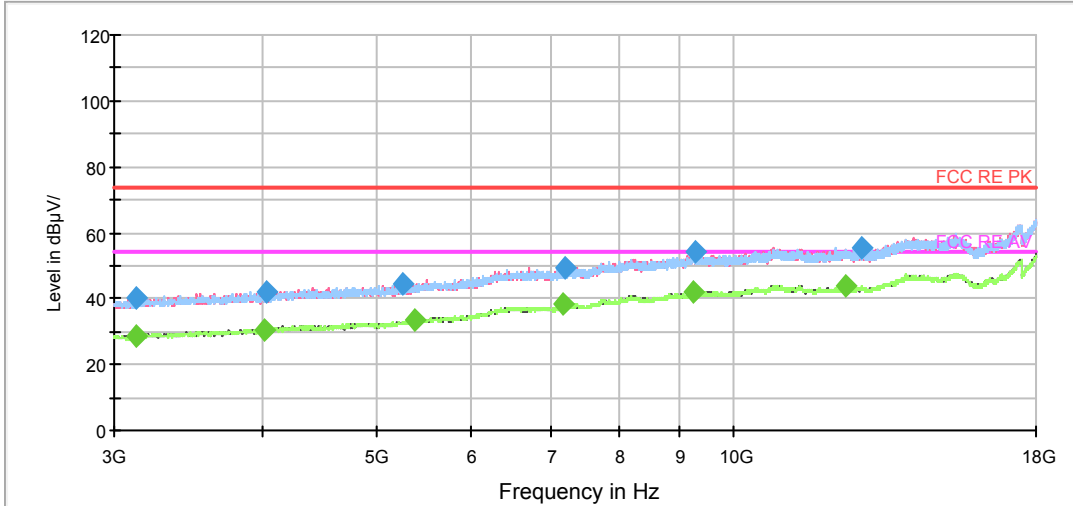

Radiates Emission from 3GHz to 18GHz



Frequency (MHz)	Peak (dBuV/m)	Height (cm)	Polarization	Azimuth (deg)	Correct Factor (dB)	Margin (dB)	Limit (dBuV/m)
1165.000000	44.8	100.0	H	302.0	0.5	29.2	74.0
1422.250000	46.2	100.0	H	243.0	2.0	27.8	74.0
1636.250000	47.2	100.0	H	287.0	2.7	26.8	74.0
2056.250000	48.5	100.0	H	287.0	4.4	25.5	74.0
2791.250000	49.7	100.0	H	184.0	7.4	24.3	74.0
2971.500000	49.4	100.0	V	28.0	8.1	24.6	74.0

Remark: 1. Correction Factor = Antenna factor+ Insertion loss (cable loss + amplifier gain)

Frequency (MHz)	Average (dBuV/m)	Height (cm)	Polarization	Azimuth (deg)	Correct Factor (dB)	Margin (dB)	Limit (dBuV/m)
1188.750000	34.7	100.0	H	116.0	0.7	19.3	54.0
1422.250000	35.4	100.0	V	51.0	2.0	18.6	54.0
1700.000000	36.1	100.0	V	0.0	3.0	17.9	54.0
2015.000000	37.3	100.0	H	123.0	4.3	16.7	54.0
2793.000000	39.0	100.0	H	0.0	7.4	15.0	54.0
2978.000000	39.3	100.0	H	332.0	8.1	14.7	54.0

Remark: 1. Correction Factor = Antenna factor+ Insertion loss (cable loss + amplifier gain)

802.11n (HT20) CH1

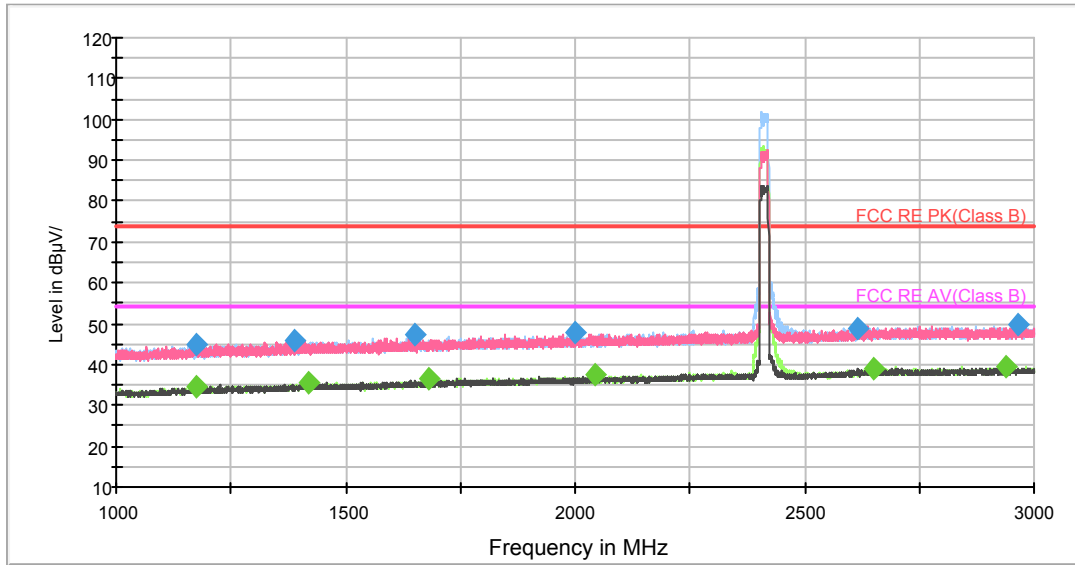

Note: The signal beyond the limit is carrier.
Radiates Emission from 1GHz to 3GHz

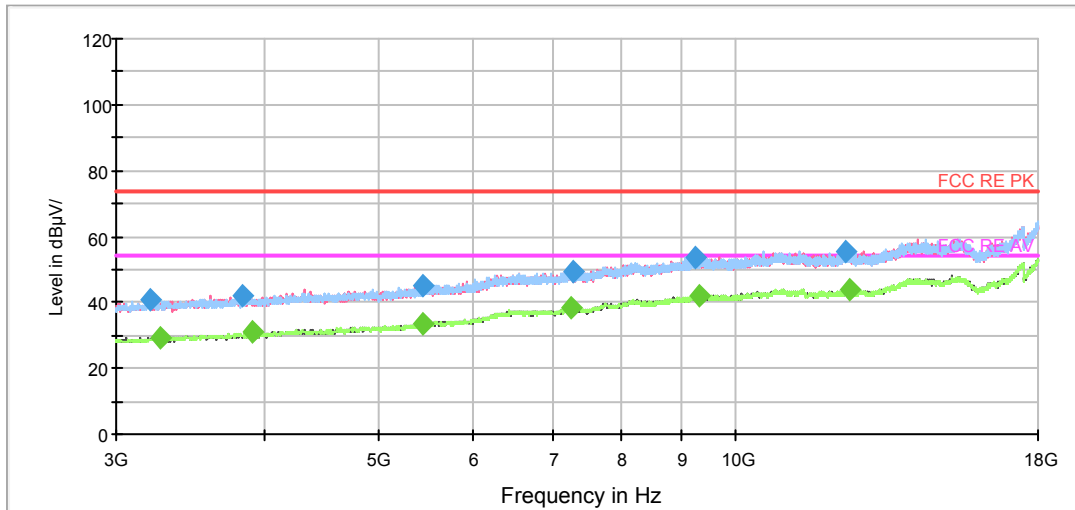

Radiates Emission from 3GHz to 18GHz



Frequency (MHz)	Peak (dBuV/m)	Height (cm)	Polarization	Azimuth (deg)	Correct Factor (dB)	Margin (dB)	Limit (dBuV/m)
1173.000000	45.0	100.0	V	298.0	0.6	29.0	74.0
1387.750000	46.1	100.0	V	148.0	1.8	27.9	74.0
1650.500000	47.5	200.0	H	226.0	2.8	26.5	74.0
1998.750000	47.9	200.0	V	89.0	4.3	26.1	74.0
2615.250000	48.7	100.0	V	67.0	6.7	25.3	74.0
2965.500000	49.6	100.0	V	8.0	8.1	24.4	74.0

Remark: 1. Correction Factor = Antenna factor+ Insertion loss (cable loss + amplifier gain)

Frequency (MHz)	Average (dBuV/m)	Height (cm)	Polarization	Azimuth (deg)	Correct Factor (dB)	Margin (dB)	Limit (dBuV/m)
1174.000000	34.5	100.0	V	156.0	0.6	19.5	54.0
1419.750000	35.6	100.0	V	340.0	1.9	18.4	54.0
1679.750000	36.4	200.0	H	336.0	2.9	17.6	54.0
2044.250000	37.3	100.0	H	344.0	4.4	16.7	54.0
2649.750000	39.1	200.0	V	164.0	6.9	14.9	54.0
2938.250000	39.7	100.0	H	33.0	7.9	14.3	54.0

Remark: 1. Correction Factor = Antenna factor+ Insertion loss (cable loss + amplifier gain)

802.11n (HT20) CH6

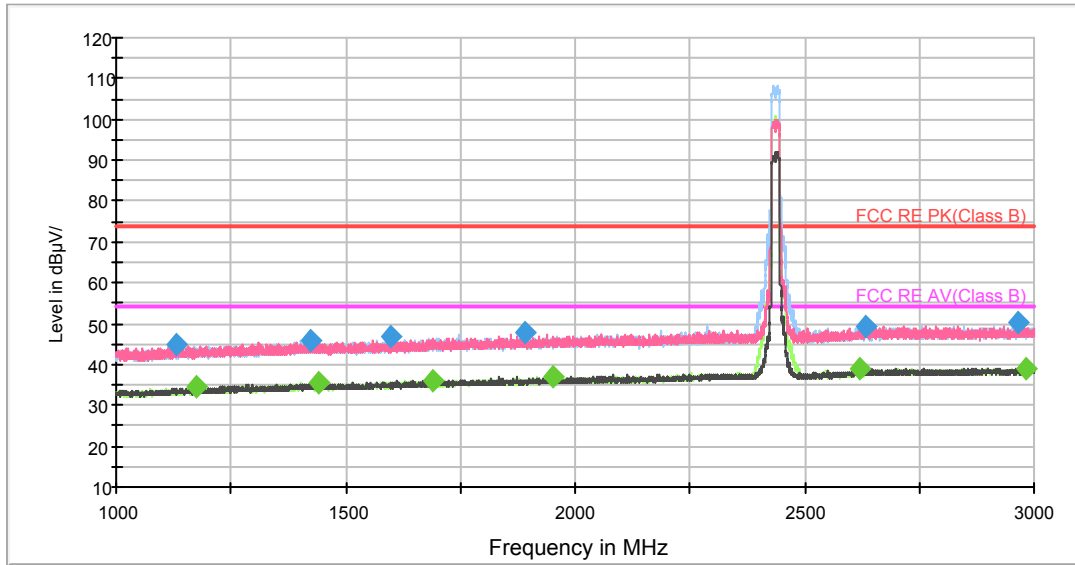

Note: The signal beyond the limit is carrier.
Radiates Emission from 1GHz to 3GHz

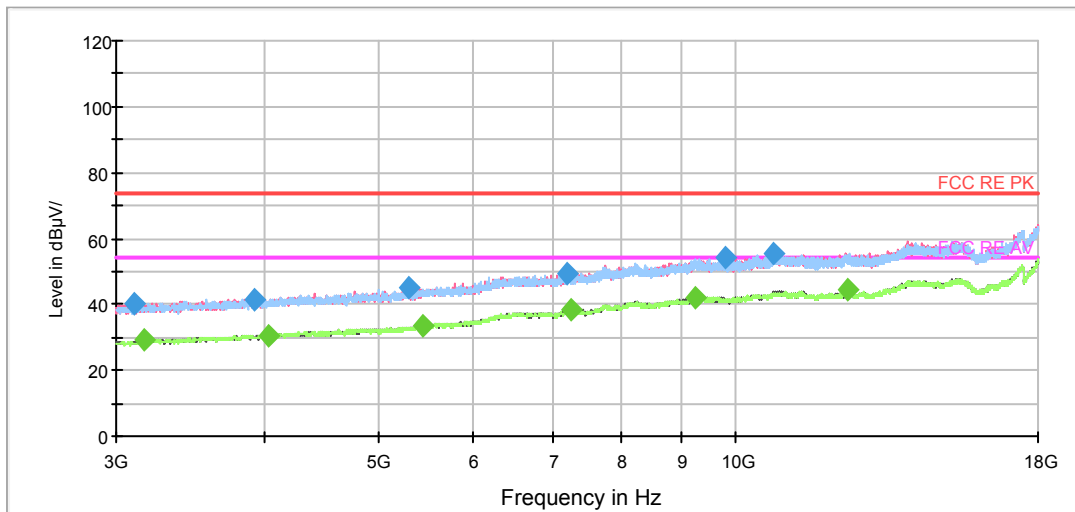

Radiates Emission from 3GHz to 18GHz



Frequency (MHz)	Peak (dBuV/m)	Height (cm)	Polarization	Azimuth (deg)	Correct Factor (dB)	Margin (dB)	Limit (dBuV/m)
1129.000000	44.9	100.0	V	103.0	0.3	29.1	74.0
1423.500000	45.8	200.0	H	310.0	2.0	28.2	74.0
1598.750000	46.8	100.0	V	111.0	2.5	27.2	74.0
1889.250000	47.9	200.0	H	109.0	3.7	26.1	74.0
2633.750000	49.3	200.0	H	124.0	6.8	24.7	74.0
2964.250000	50.3	100.0	H	326.0	8.0	23.7	74.0

Remark: 1. Correction Factor = Antenna factor+ Insertion loss (cable loss + amplifier gain)

Frequency (MHz)	Average (dBuV/m)	Height (cm)	Polarization	Azimuth (deg)	Correct Factor (dB)	Margin (dB)	Limit (dBuV/m)
1173.750000	34.4	100.0	H	214.0	0.6	19.6	54.0
1440.250000	35.8	200.0	H	154.0	2.0	18.2	54.0
1688.750000	36.2	100.0	V	12.0	2.9	17.8	54.0
1952.000000	37.1	200.0	V	57.0	4.0	16.9	54.0
2618.250000	38.7	100.0	V	252.0	6.7	15.3	54.0
2983.750000	39.1	100.0	H	200.0	8.1	14.9	54.0

Remark: 1. Correction Factor = Antenna factor+ Insertion loss (cable loss + amplifier gain)

802.11n (HT20) CH11

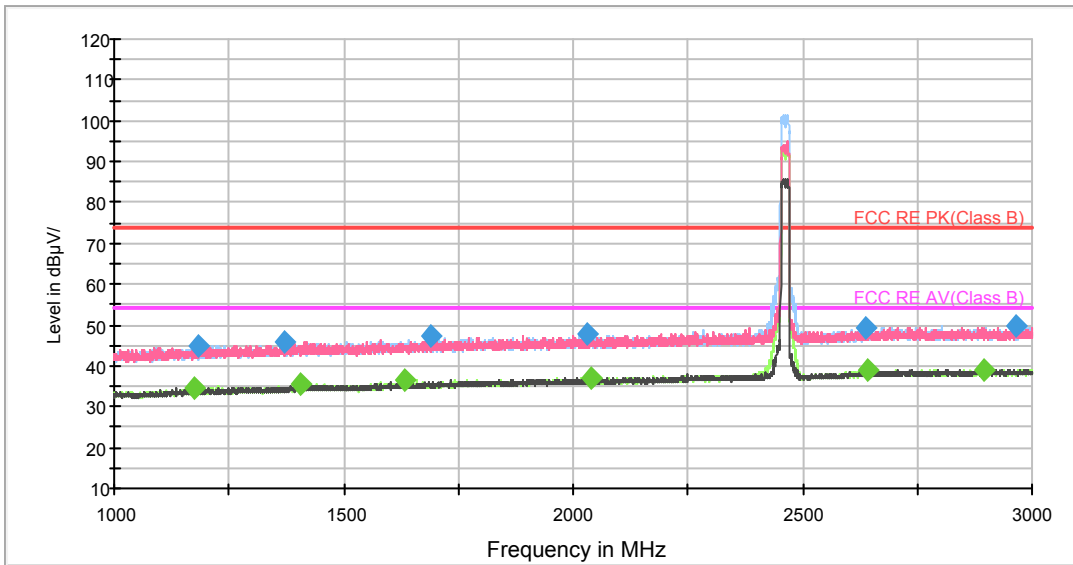

Note: The signal beyond the limit is carrier.
Radiates Emission from 1GHz to 3GHz

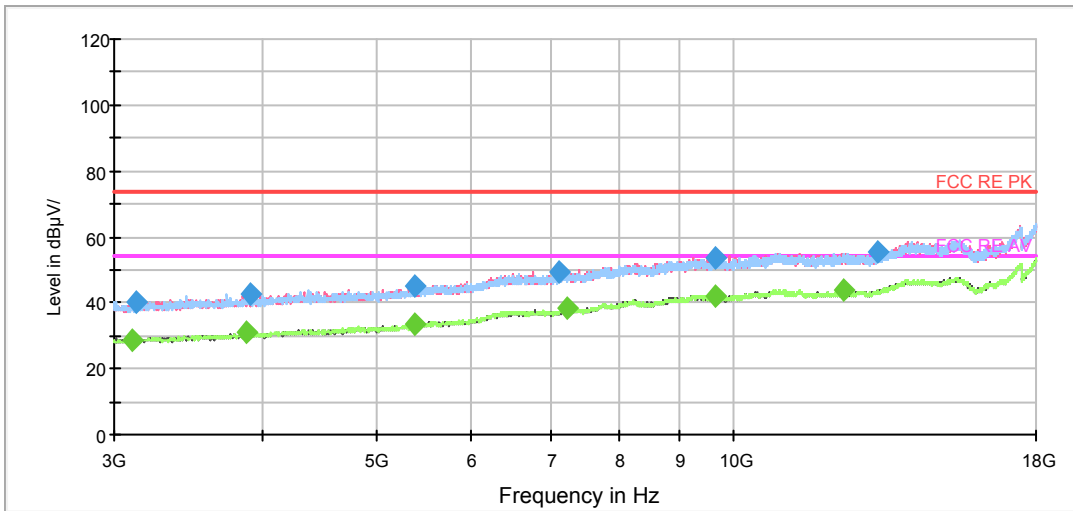

Radiates Emission from 3GHz to 18GHz



Frequency (MHz)	Peak (dBuV/m)	Height (cm)	Polarization	Azimuth (deg)	Correct Factor (dB)	Margin (dB)	Limit (dBuV/m)
1184.000000	45.1	100.0	V	177.0	0.7	28.9	74.0
1373.000000	45.9	100.0	V	177.0	1.6	28.1	74.0
1691.250000	47.4	200.0	H	300.0	2.9	26.6	74.0
2028.750000	47.8	100.0	V	108.0	4.4	26.2	74.0
2636.750000	49.5	100.0	H	86.0	6.8	24.5	74.0
2963.250000	49.7	100.0	H	330.0	8.0	24.3	74.0

Remark: 1. Correction Factor = Antenna factor+ Insertion loss (cable loss + amplifier gain)

Frequency (MHz)	Average (dBuV/m)	Height (cm)	Polarization	Azimuth (deg)	Correct Factor (dB)	Margin (dB)	Limit (dBuV/m)
1176.000000	34.6	100.0	V	184.0	0.6	19.4	54.0
1408.250000	35.6	100.0	H	190.0	1.9	18.4	54.0
1634.000000	36.6	100.0	H	190.0	2.7	17.4	54.0
2039.500000	37.2	200.0	V	24.0	4.4	16.8	54.0
2640.750000	38.8	100.0	V	9.0	6.9	15.2	54.0
2894.500000	39.2	200.0	V	207.0	7.7	14.8	54.0

Remark: 1. Correction Factor = Antenna factor+ Insertion loss (cable loss + amplifier gain)



802.11n (HT40) CH3

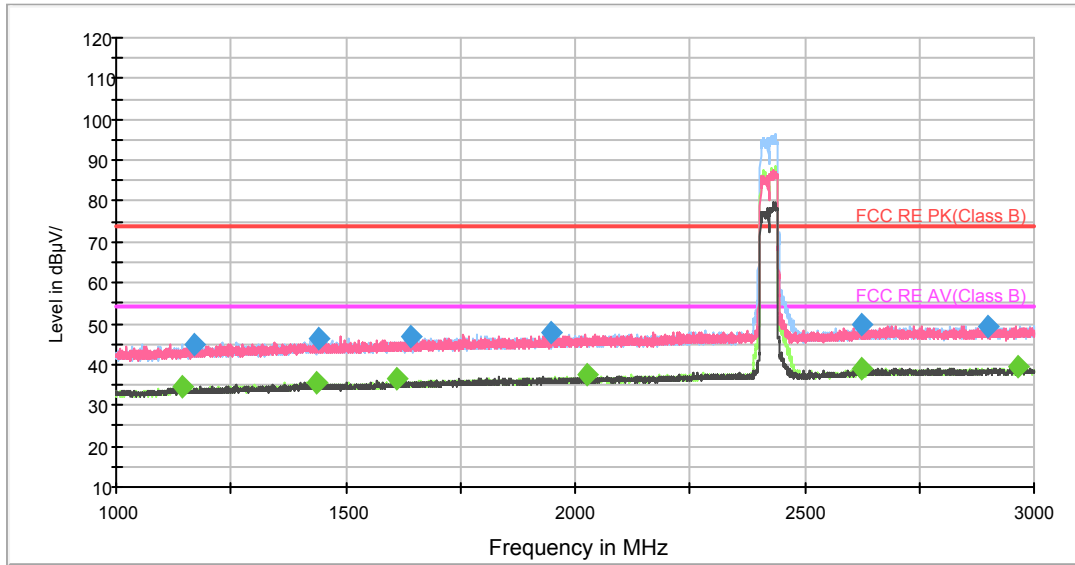

Note: The signal beyond the limit is carrier.
Radiates Emission from 1GHz to 3GHz

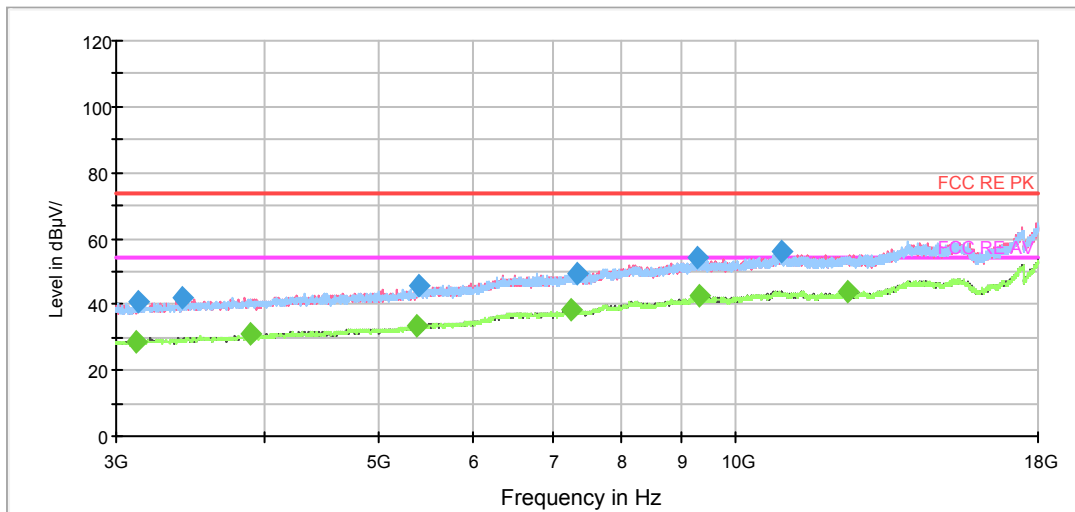

Radiates Emission from 3GHz to 18GHz



Frequency (MHz)	Peak (dBuV/m)	Height (cm)	Polarization	Azimuth (deg)	Correct Factor (dB)	Margin (dB)	Limit (dBuV/m)
1168.250000	45.0	200.0	V	0.0	0.6	29.0	74.0
1439.500000	46.1	100.0	V	30.0	2.0	27.9	74.0
1640.250000	46.7	100.0	V	30.0	2.8	27.3	74.0
1948.000000	47.7	100.0	V	38.0	4.0	26.3	74.0
2622.750000	49.7	100.0	V	239.0	6.7	24.3	74.0
2899.250000	49.4	100.0	V	67.0	7.7	24.6	74.0

Remark: 1. Correction Factor = Antenna factor+ Insertion loss (cable loss + amplifier gain)

Frequency (MHz)	Average (dBuV/m)	Height (cm)	Polarization	Azimuth (deg)	Correct Factor (dB)	Margin (dB)	Limit (dBuV/m)
1143.500000	34.6	100.0	H	147.0	0.4	19.4	54.0
1438.000000	35.6	200.0	H	139.0	2.0	18.4	54.0
1611.000000	36.4	100.0	V	133.0	2.6	17.6	54.0
2027.750000	37.3	200.0	V	149.0	4.3	16.7	54.0
2623.750000	38.8	100.0	V	149.0	6.8	15.2	54.0
2965.750000	39.4	100.0	H	220.0	8.1	14.6	54.0

Remark: 1. Correction Factor = Antenna factor+ Insertion loss (cable loss + amplifier gain)



802.11n (HT40) CH6

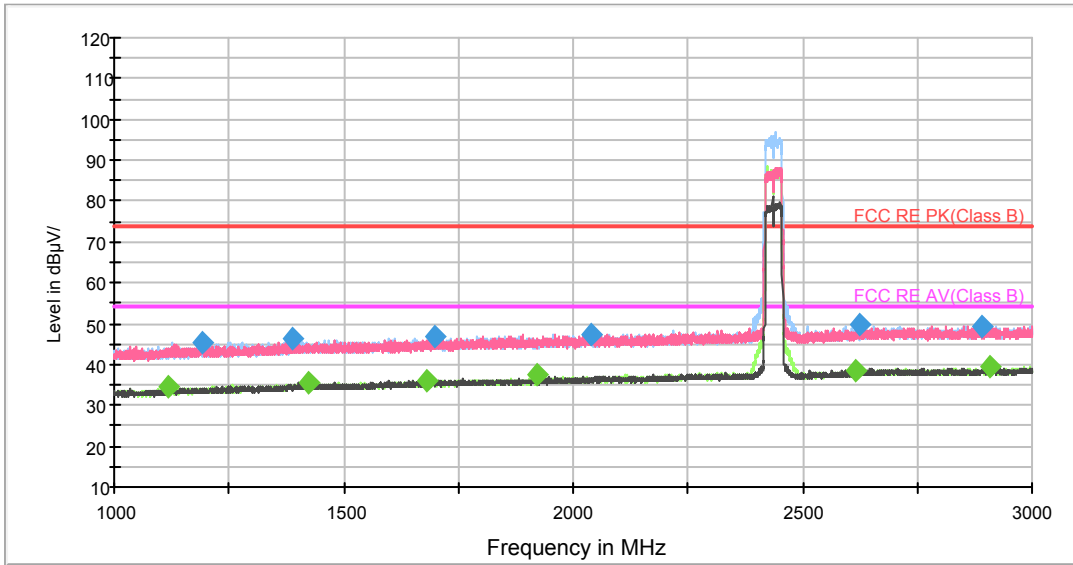

Note: The signal beyond the limit is carrier.
Radiates Emission from 1GHz to 3GHz

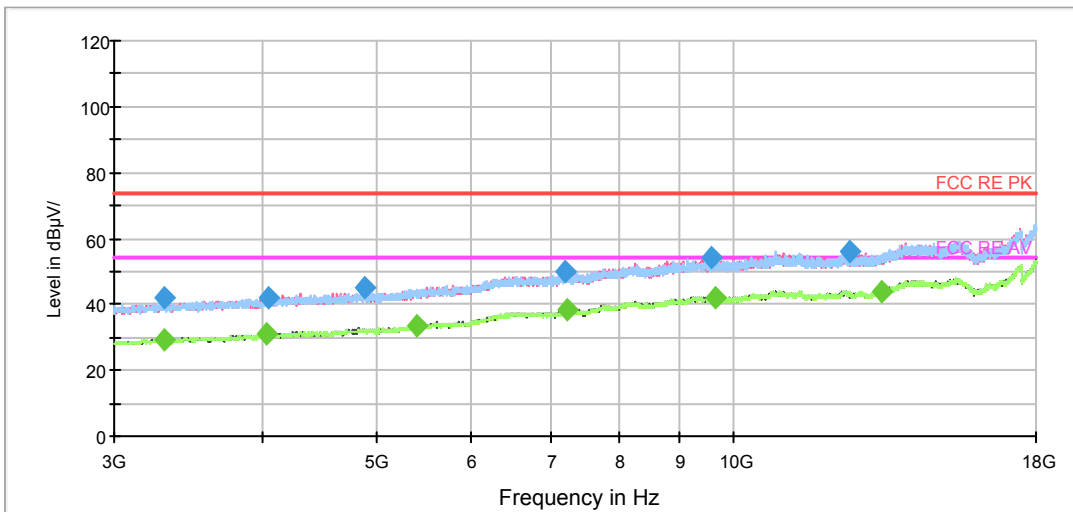

Radiates Emission from 3GHz to 18GHz



Frequency (MHz)	Peak (dBuV/m)	Height (cm)	Polarization	Azimuth (deg)	Correct Factor (dB)	Margin (dB)	Limit (dBuV/m)
1193.250000	45.2	100.0	V	16.0	0.7	28.8	74.0
1389.750000	46.2	100.0	V	208.0	1.8	27.8	74.0
1698.000000	46.6	100.0	H	334.0	3.0	27.4	74.0
2039.750000	47.5	200.0	V	24.0	4.4	26.5	74.0
2626.250000	49.7	200.0	H	334.0	6.8	24.3	74.0
2891.000000	49.2	100.0	H	289.0	7.7	24.8	74.0

Remark: 1. Correction Factor = Antenna factor+ Insertion loss (cable loss + amplifier gain)

Frequency (MHz)	Average (dBuV/m)	Height (cm)	Polarization	Azimuth (deg)	Correct Factor (dB)	Margin (dB)	Limit (dBuV/m)
1119.750000	34.3	100.0	V	253.0	0.2	19.7	54.0
1421.500000	35.6	100.0	H	192.0	2.0	18.4	54.0
1681.250000	36.1	200.0	V	111.0	2.9	17.9	54.0
1920.250000	37.5	100.0	V	178.0	3.9	16.5	54.0
2617.750000	38.6	200.0	H	146.0	6.7	15.4	54.0
2909.000000	39.4	100.0	H	319.0	7.8	14.6	54.0

Remark: 1. Correction Factor = Antenna factor+ Insertion loss (cable loss + amplifier gain)



802.11n (HT40) CH9

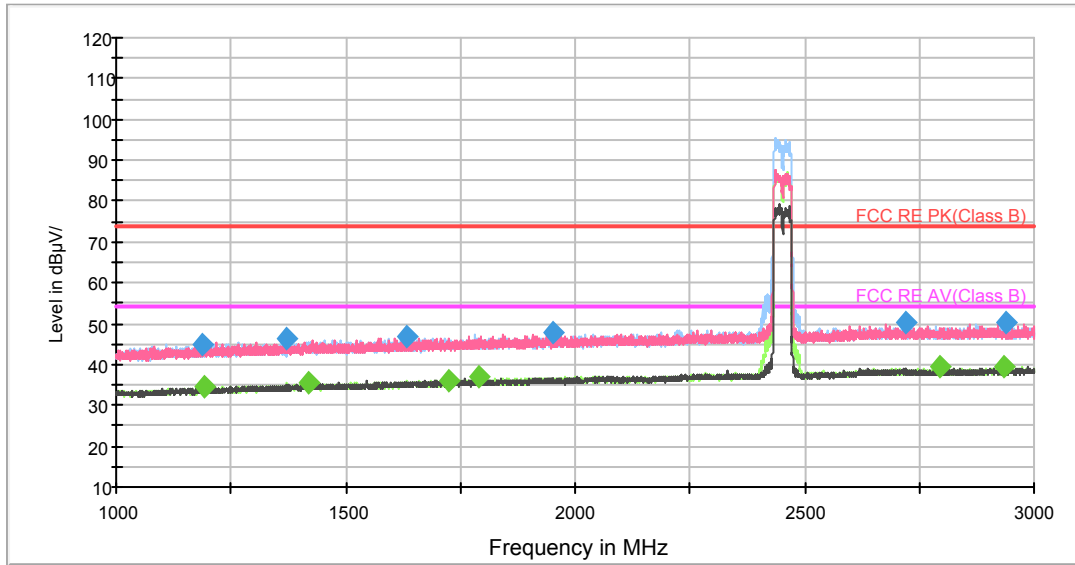

Note: The signal beyond the limit is carrier.
Radiates Emission from 1GHz to 3GHz

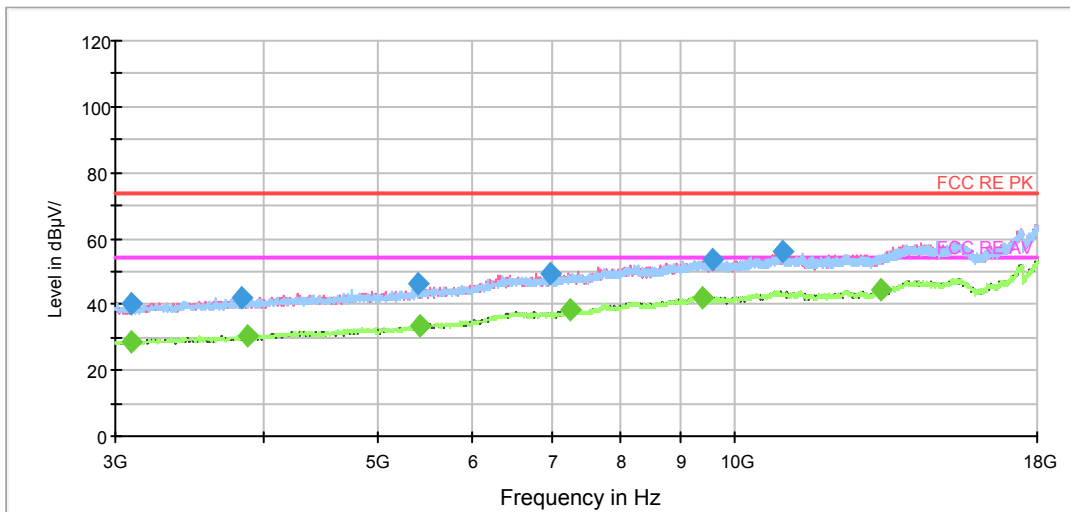

Radiates Emission from 3GHz to 18GHz



Frequency (MHz)	Peak (dBuV/m)	Height (cm)	Polarization	Azimuth (deg)	Correct Factor (dB)	Margin (dB)	Limit (dBuV/m)
1189.500000	45.1	200.0	H	218.0	0.7	28.9	74.0
1373.250000	46.1	200.0	H	0.0	1.6	27.9	74.0
1631.500000	46.9	100.0	V	328.0	2.7	27.1	74.0
1952.500000	47.7	100.0	V	72.0	4.0	26.3	74.0
2721.500000	50.2	100.0	V	349.0	7.1	23.8	74.0
2938.250000	50.2	200.0	H	323.0	7.9	23.8	74.0

Remark: 1. Correction Factor = Antenna factor+ Insertion loss (cable loss + amplifier gain)

Frequency (MHz)	Average (dBuV/m)	Height (cm)	Polarization	Azimuth (deg)	Correct Factor (dB)	Margin (dB)	Limit (dBuV/m)
1193.250000	34.4	100.0	V	197.0	0.7	19.6	54.0
1418.750000	35.7	100.0	V	219.0	1.9	18.3	54.0
1724.250000	36.0	100.0	H	189.0	3.1	18.0	54.0
1791.250000	37.2	100.0	V	244.0	3.4	16.8	54.0
2793.500000	39.6	200.0	H	62.0	7.4	14.4	54.0
2933.000000	39.6	200.0	H	278.0	7.9	14.4	54.0

Remark: 1. Correction Factor = Antenna factor+ Insertion loss (cable loss + amplifier gain)



During the test, the Radiates Emission from 18GHz to 26.5GHz was performed in all modes with all channels, 802.11g CH6 are selected as the worst condition. The test data of the worst-case condition was recorded in this report.

RE 18-26.5GHz PK+AV

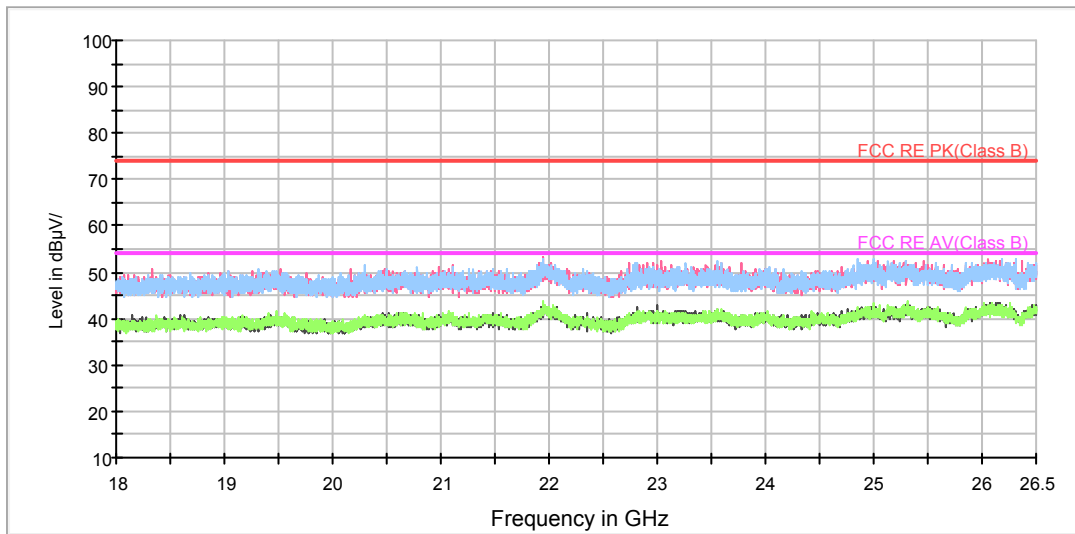

Radiates Emission from 18GHz to 26.5GHz

5.7. Conducted Emission

Ambient condition

Temperature	Relative humidity	Pressure
23°C ~25°C	45%~50%	101.5kPa

Methods of Measurement

The EUT is placed on a non-metallic table of 80cm height above the horizontal metal reference ground plane. During the test, the EUT was operating in its typical mode. The test method is according to ANSI C63.10-2013. Connect the AC power line of the EUT to the L.I.S.N. Use EMI receiver to detect the average and Quasi-peak value. RBW is set to 9 kHz, VBW is set to 30kHz. The measurement result should include both L line and N line.

The test is in transmitting mode.

Test Setup

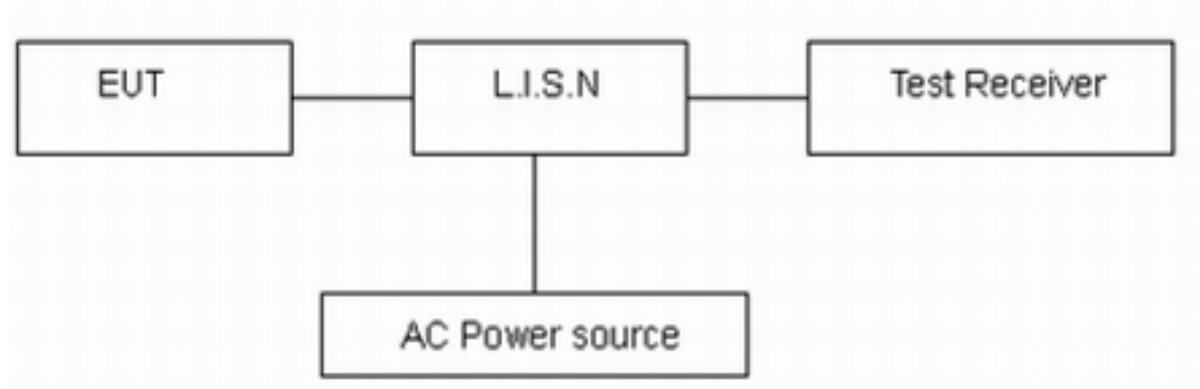

Note: AC Power source is used to change the voltage 110V/60Hz.

Limits

Frequency (MHz)	Conducted Limits(dBμV)	
	Quasi-peak	Average
0.15 - 0.5	66 to 56 *	56 to 46 *
0.5 - 5	56	46
5 - 30	60	50

*: Decreases with the logarithm of the frequency.

Measurement Uncertainty

The assessed measurement uncertainty to ensure 95% confidence level for the normal distribution is with the coverage factor $k = 1.96$, $U = 2.69$ dB.

Test Results:

Following plots, Blue trace uses the peak detection and Green trace uses the average detection. During the test, the Conducted Emission was performed in all modes (WIFI 2.4G /BLE) with all channels, 802.11g CH6 are selected as the worst condition. The test data of the worst-case condition was recorded in this report.

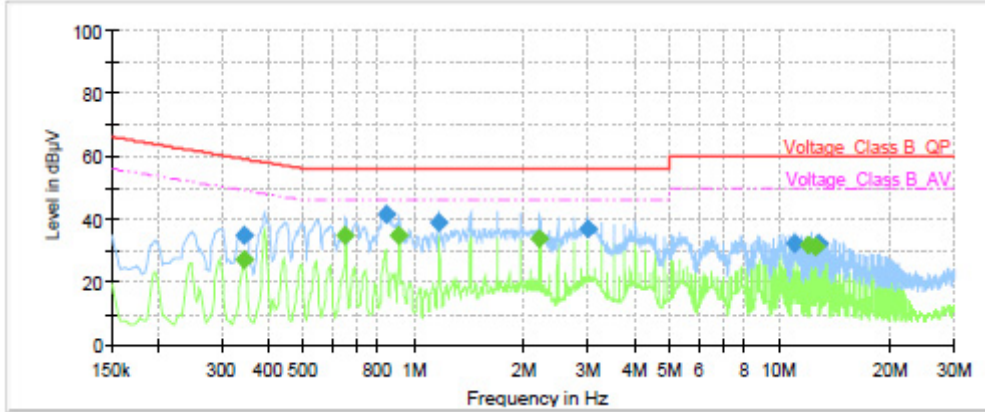

Frequency (MHz)	QuasiPeak (dBµV)	Average (dBµV)	Limit (dBµV)	Margin (dB)	Meas. Time (ms)	Bandwidth (kHz)	Line	Filter	Corr. (dB)
0.34	---	27.17	49.12	21.95	1000.0	9.000	L1	ON	19.18
0.35	34.67	---	59.06	24.39	1000.0	9.000	L1	ON	19.18
0.65	---	35.07	46.00	10.93	1000.0	9.000	L1	ON	19.28
0.84	41.67	---	56.00	14.33	1000.0	9.000	L1	ON	19.24
0.91	---	34.92	46.00	11.08	1000.0	9.000	L1	ON	19.24
1.17	38.82	---	56.00	17.18	1000.0	9.000	L1	ON	19.23
2.22	---	33.93	46.00	12.07	1000.0	9.000	L1	ON	19.07
3.00	36.67	---	56.00	19.33	1000.0	9.000	L1	ON	19.11
10.95	32.33	---	60.00	27.67	1000.0	9.000	L1	ON	19.36
11.99	---	31.69	50.00	18.31	1000.0	9.000	L1	ON	19.40
12.51	---	31.35	50.00	18.65	1000.0	9.000	L1	ON	19.44
12.77	32.46	---	60.00	27.54	1000.0	9.000	L1	ON	19.49

L line Conducted Emission from 150 KHz to 30 MHz

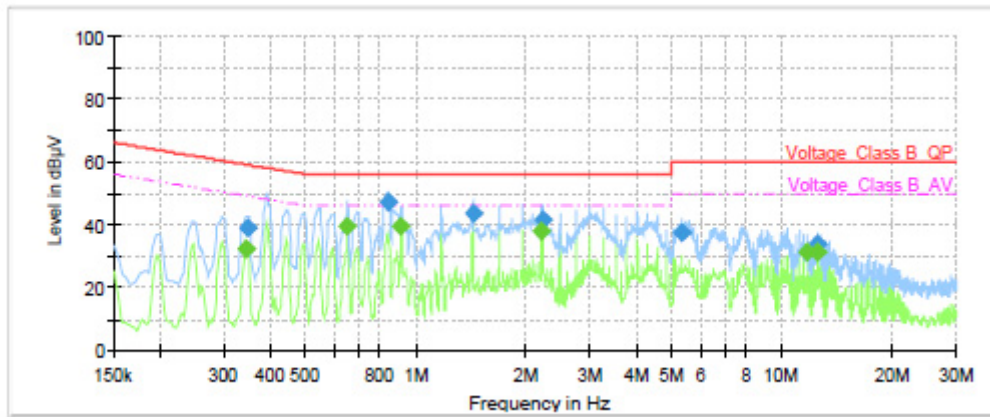

Frequency (MHz)	QuasiPeak (dBµV)	Average (dBµV)	Limit (dBµV)	Margin (dB)	Meas. Time (ms)	Bandwidth (kHz)	Line	Filter	Corr. (dB)
0.35	---	32.46	49.06	16.60	1000.0	9.000	N	ON	19.18
0.35	38.90	---	59.01	20.11	1000.0	9.000	N	ON	19.17
0.65	---	39.63	46.00	6.37	1000.0	9.000	N	ON	19.28
0.84	47.26	---	56.00	8.74	1000.0	9.000	N	ON	19.24
0.91	---	39.45	46.00	6.55	1000.0	9.000	N	ON	19.24
1.43	43.76	---	56.00	12.24	1000.0	9.000	N	ON	19.18
2.22	---	37.74	46.00	8.26	1000.0	9.000	N	ON	19.07
2.22	41.72	---	56.00	14.28	1000.0	9.000	N	ON	19.07
5.34	37.63	---	60.00	22.37	1000.0	9.000	N	ON	19.10
11.73	---	31.27	50.00	18.73	1000.0	9.000	N	ON	19.38
12.51	---	31.12	50.00	18.88	1000.0	9.000	N	ON	19.42
12.51	33.71	---	60.00	26.29	1000.0	9.000	N	ON	19.42

N line Conducted Emission from 150 KHz to 30 MHz



6. Main Test Instruments

Name	Manufacturer	Type	Serial Number	Calibration Date	Expiration Date
Spectrum Analyzer	R&S	FSV30	100815	2018-12-16	2019-12-15
EMI Test Receiver	R&S	ESCI	100948	2019-05-19	2020-05-18
Loop Antenna	SCHWARZBECK	FMZB1519	1519-047	2017-09-26	2019-09-25
TRILOG Broadband Antenna	Schwarzbeck	VULB 9163	9163-201	2017-11-18	2019-11-17
Double Ridged Waveguide Horn Antenna	R&S	HF907	100126	2018-07-07	2020-07-06
Standard Gain Horn	ETS-Lindgren	3160-09	00102643	2018-06-20	2020-06-19
EMI Test Receiver	R&S	ESR	101667	2019-05-19	2020-05-18
LISN	R&S	ENV216	101171	2016-12-16	2019-12-15
Spectrum Analyzer	Agilent	N9010A	MY47191109	2019-05-19	2020-05-18
Power Meter	R&S	NRP	104306	2019-05-19	2020-05-18
Power Sensor	R&S	NRP-Z21	104799	2019-05-19	2020-05-18
20dB Attenuator	Star River Highlight	UCL-TS2S-20	18013001	2018-12-16	2019-12-15
RF Cable	Agilent	SMA 15cm	0001	2019-06-14	2019-09-13
Software	R&S	EMC32	9.26.0	/	/

*****END OF REPORT *****