



中国认可
国际互认
检测
TESTING
CNAS L0310



IC SAR Compliance Test Report

Product Name: Smart Watch

Model: LEO-BX9

Report No.: SYBH(Z-SAR)012012017-3

IC: 6369A-LEOBX9

	APPROVED (Lab Manager)	PREPARED (Test Engineer)
BY	<i>Wei Huanbin</i>	<i>Sun Shanbin</i>
DATE	2017-01-23	2017-01-23

Reliability Laboratory of Huawei Technologies Co., Ltd.

(Global Compliance and Testing Center of Huawei Technologies Co., Ltd)

※ ※ **Notice** ※ ※

1. The laboratory has passed the accreditation by China National Accreditation Service for Conformity Assessment (CNAS). The accreditation number is L0310.
2. The laboratory has passed the accreditation by The American Association for Laboratory Accreditation (A2LA). The accreditation number is 2174.01 & 2174.02 & 2174.03
3. The laboratory (Reliability Lab of Huawei Technologies Co., Ltd) is also named “Global Compliance and Testing Center of Huawei Technologies Co., Ltd”, the both names have coexisted since 2009.
4. The test report is invalid if not marked with the signatures of the persons responsible for preparing and approving the test report.
5. The test report is invalid if there is any evidence of erasure and/or falsification.
6. The test report is only valid for the test samples.
7. Content of the test report, in part or in full, cannot be used for publicity and/or promotional purposes without prior written approval from the laboratory.

Table of Contents

1	General Information.....	5
1.1	Statement of Compliance	5
1.2	RF exposure limits	6
1.3	EUT Description.....	7
1.3.1	General Description	8
1.4	Test specification(s).....	9
1.5	Testing laboratory	9
1.6	Applicant and Manufacturer.....	9
1.7	Application details	9
1.8	Ambient Condition.....	9
2	SAR Measurement System	10
2.1	SAR Measurement Set-up.....	10
2.2	Test environment	11
2.3	Data Acquisition Electronics description.....	11
2.4	Probe description	12
2.5	Phantom description	13
2.6	Device holder description	14
2.7	Test Equipment List	15
3	SAR Measurement Procedure	16
3.1	Scanning procedure.....	16
3.2	Spatial Peak SAR Evaluation	17
3.3	Data Storage and Evaluation.....	18
4	System Verification Procedure	20
4.1	Tissue Verification.....	20
4.2	System Check.....	22
4.3	System check Procedure	22
5	SAR measurement variability and uncertainty	23
5.1	SAR measurement variability	23
5.2	SAR measurement uncertainty.....	24
6	SAR Test Configuration.....	28
6.1	Test Positions Configuration	28
6.1.1	10-g Extremity Exposure Condition	28
6.1.2	Next-to-Mouth Exposure Condition.....	28
6.2	WiFi Test Configuration	29
6.2.1	Initial Test Position Procedure	29
6.2.2	Initial Test Configuration Procedure	29
6.2.3	Sub Test Configuration Procedure	29
6.2.4	WiFi 2.4G SAR Test Procedures	30
7	SAR Measurement Results	31
7.1	Conducted power measurements.....	31
7.1.1	Conducted power measurements of WiFi 2.4G.....	31
7.1.2	Conducted power measurements of BT	31
7.2	SAR measurement Results	32
7.2.1	SAR measurement Result of WiFi 2.4G	33
7.2.2	SAR measurement Result of BT.....	34
7.3	Multiple Transmitter Evaluation	35
7.3.1	Stand-alone SAR test exclusion	36
7.3.2	Simultaneous Transmission Possibilities.....	36
	Appendix A. System Check Plots.....	37
	Appendix B. SAR Measurement Plots.....	37
	Appendix C. Calibration Certificate	37
	Appendix D. Photo documentation.....	37

※ ※ **Modified History** ※ ※

REV.	DESCRIPTION	ISSUED DATE	REMARK
Rev.1.0	Initial Test Report Release	2017-01-23	Sun Shanbin

1 General Information

1.1 Statement of Compliance

The maximum results of Specific Absorption Rate (SAR) found during testing is as below Table 1.

Band	Max Reported SAR(W/kg)	
	1-g Next-to-Mouth(10mm)	10-g Extremity (0mm)
WiFi 2.4G	0.29	0.12
BT	NA	0.07

Table 1:Summary of test result

Note:

The device is in compliance with Specific Absorption Rate(SAR) for general population/uncontrolled exposure limits according to the FCC rule §2.1093, the ANSI C95.1:1992/IEEE C95.1:1991, the NCRP Report Number 86 for uncontrolled environment, according to the Industry Canada Radio Standards Specification RSS-102 for General Population/Uncontrolled exposure, and had been tested in accordance with the measurement methods and procedures specified in IEEE Std 1528-2013.

1.2 RF exposure limits

Human Exposure	Uncontrolled Environment General Population	Controlled Environment Occupational
Spatial Peak SAR* (Brain/Body/Arms/Legs)	1.60 W/kg	8.00 W/kg
Spatial Average SAR** (Whole Body)	0.08 W/kg	0.40 W/kg
Spatial Peak SAR*** (Hands/Feet/Ankle/Wrist)	4.00 W/kg	20.00 W/kg

Table 2: RF exposure limits

The limit applied in this test report is shown in **bold** letters

Notes:

- * The Spatial Peak value of the SAR averaged over any 1 gram of tissue (defined as a tissue volume in the shape of a cube) and over the appropriate averaging time.
- ** The Spatial Average value of the SAR averaged over the whole body.
- *** The Spatial Peak value of the SAR averaged over any 10 grams of tissue (defined as a tissue volume in the shape of a cube) and over the appropriate averaging time.

Uncontrolled Environments are defined as locations where there is the exposure of individuals who have no knowledge or control of their exposure.

Controlled Environments are defined as locations where there is exposure that may be incurred by persons who are aware of the potential for exposure, (i.e. as a result of employment or occupation).

1.3 EUT Description

Device Information:			
Product Name:	Smart Watch		
Model:	LEO-BX9		
IC:	6369A-LEOBX9		
SN:	TKQ0116B19000124(1#) YGV0116B15000114(2#)		
Device Type :	Portable device		
Device Phase:	Identical Prototype		
Exposure Category:	Uncontrolled environment / general population		
Hardware Version :	EA1LEOUM		
Software Version :	sawshark-userdebug7.1.1NFF47		
Antenna Type :	Internal antenna		
Device Operating Configurations:			
Supporting Mode(s)	WiFi 2.4G, BT,NFC		
Test Modulation	WiFi(DSSS/OFDM),BT(GFSK)		
Operating Frequency Range(s)	Band	Tx (MHz)	Rx (MHz)
	BT	2400-2483.5	2400-2483.5
	WiFi 2.4G	2400-2483.5	2400-2483.5
	NFC	/	13.56
Test Channels (low-mid-high):	802.11b/g/n 20M:1-6-11		
	BT:0-19-39-78		

Table 3:Device information and operating configuration

1.3.1 General Description

LEO-BX9 is a smart watch based on Android wear OS; it can be communicated with mobile phone via Bluetooth. Watch also support MP3 player function, voice communication, alarm clock, gyro sensor, intelligent user can judge the state of motion, with PPG measurement of heart rate and supports IP68 dustproof and waterproof level.

The WiFi/BT frequency is 2.4GHz.

Battery information:

Name	Manufacture	Serials number	Description
Rechargeable Li-ion	Desay	NA	Battery Model: HB512627ECW Rated capacity: 410mAh Nominal Voltage: $\overline{\overline{\overline{\quad}}}$ +3.82V

1.4 Test specification(s)

ANSI C95.1:1992	Safety Levels with Respect to Human Exposure to Radio Frequency Electromagnetic Fields, 3 kHz – 300 GHz.(IEEE Std C95.1-1991)
IEEE Std 1528-2013	Recommended Practice for Determining the Peak Spatial-Average Specific Absorption Rate (SAR) in the Human Head from Wireless Communications Devices: Measurement Techniques
RSS-102	Radio Frequency Exposure Compliance of Radiocommunication Apparatus (All Frequency Bands (Issue 5 of March 2015)
KDB447498 D01	General RF Exposure Guidance v06
KDB248227 D01	SAR Guidance for IEEE 802 11 Wi-Fi SAR v02r02
KDB865664 D01	SAR measurement 100 MHz to 6 GHz v01r04
KDB865664 D02	SAR Reporting v01r02
KDB690783 D01	SAR Listings on Grants v01r03

1.5 Testing laboratory

Test Site	The Reliability Laboratory of Huawei Technologies Co., Ltd.
Test Location	Section G1,Huawei Base Bantian, Longgang District, Shenzhen 518129, P.R. China
Telephone	+86 755 28780808
Fax	+86 755 89652518
State of accreditation	The Test laboratory (area of testing) is accredited according to ISO/IEC 17025. CNAS Registration number: L0310 A2LA TESTING CERT #2174.01 & 2174.02 & 2174.03

1.6 Applicant and Manufacturer

Company Name	HUAWEI TECHNOLOGIES CO., LTD
Address	Administration Building, Headquarters of Huawei Technologies Co., Ltd., Bantian, Longgang District, Shenzhen, 518129, P.R.C

1.7 Application details

Start Date of test	2017-01-13
End Date of test	2017-01-13

1.8 Ambient Condition

Ambient temperature	20°C – 24°C
Relative Humidity	30% – 70%

2 SAR Measurement System

2.1 SAR Measurement Set-up

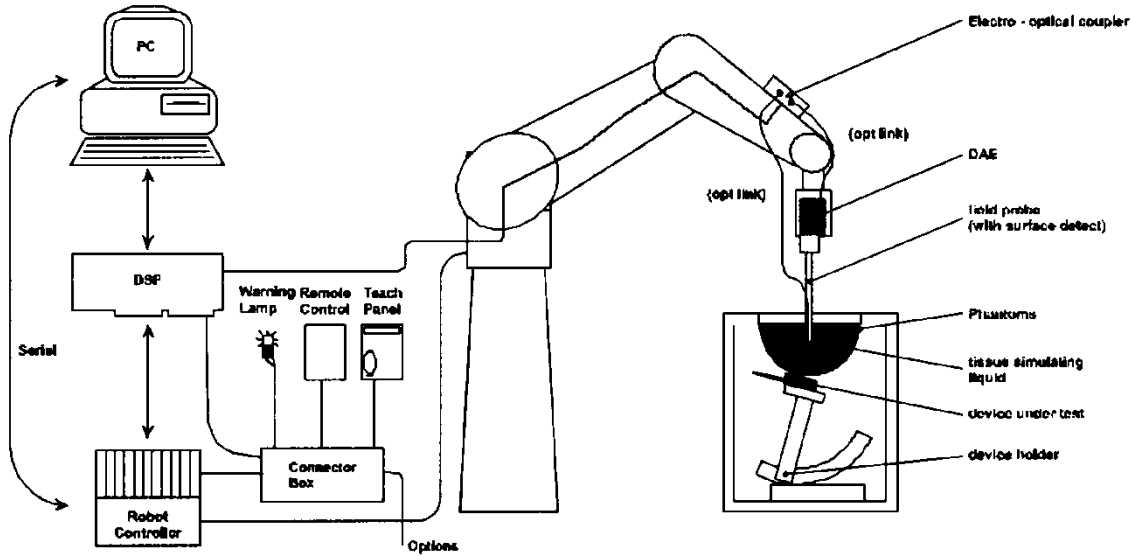

The DASY5 system for performing compliance tests consists of the following items:

- A standard high precision 6-axis robot (Stäubli RX family) with controller and software. An arm extension for accommodating the data acquisition electronics (DAE).
- A dosimetric probe, i.e. an isotropic E-field probe optimized and calibrated for usage in tissue simulating liquid. The probe is equipped with an optical surface detector system.
- A data acquisition electronic (DAE) which performs the signal amplification, signal multiplexing, AD-conversion, offset measurements, mechanical surface detection, collision detection, etc. The unit is battery powered with standard or rechargeable batteries. The signal is optically transmitted to the EOC.
- A unit to operate the optical surface detector which is connected to the EOC.
- The Electro-Optical Coupler (EOC) performs the conversion from the optical into a digital electric signal of the DAE. The EOC is connected to the DASY5 measurement server.
- The DASY5 measurement server, which performs all real-time data evaluation for field measurements and surface detection, controls robot movements and handles safety operation. A computer operating Windows 7.
- DASY5 software and SEMCAD data evaluation software.
- Remote control with teach panel and additional circuitry for robot safety such as warning lamps, etc.
- The generic twin phantom enabling the testing of left-hand and right-hand usage.
- The device holder for handheld mobile phones.
- Tissue simulating liquid mixed according to the given recipes.
- System check dipoles allowing to validate the proper functioning of the system.

2.2 Test environment

The DASY5 measurement system is placed at the head end of a room with dimensions: 5 x 2.5 x 3 m³, the SAM phantom is placed in a distance of 75 cm from the side walls and 1.1m from the rear wall. Above the test system a 1.5 x 1.5 m² array of pyramid absorbers is installed to reduce reflections from the ceiling.

Picture 1 of the photo documentation shows a complete view of the test environment.

The system allows the measurement of SAR values larger than 0.005 mW/g.

2.3 Data Acquisition Electronics description

The data acquisition electronics (DAE) consist of a highly sensitive electrometer-grade preamplifier with auto-zeroing, a channel and gain-switching multiplexer, a fast 16 bit AD-converte and a command decoder with a control logic unit. Transmission to the measurement server is accomplished through an optical downlink for data and status information, as well as an optical uplink for commands and the clock.

The mechanical probe mounting device includes two different sensor systems for frontal and sideways probe contacts. They are used for mechanical surface detection and probe collision detection.

DAE4

Input Impedance	200MOhm	
The Inputs	symmetrical and floating	
Common mode rejection	above 80 dB	

2.4 Probe description

These probes are specially designed and calibrated for use in liquids with high permittivities. They should not be used in air, since the spherical isotropy in air is poor (± 2 dB). The dosimetric probes have special calibrations in various liquids at different frequencies.

Isotropic E-Field Probe ES3DV3 for Dosimetric Measurements

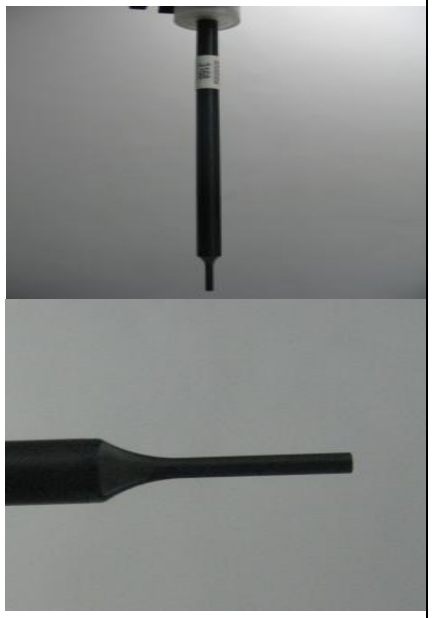
Construction	Symmetrical design with triangular core Interleaved sensors Built-in shielding against static charges PEEK enclosure material (resistant to organic solvents, e.g., DGBE)	
Calibration	ISO/IEC 17025 calibration service available.	
Frequency	10 MHz to 4 GHz; Linearity: ± 0.2 dB (30 MHz to 4 GHz)	
Directivity	± 0.2 dB in HSL (rotation around probe axis) ± 0.3 dB in tissue material (rotation normal to probe axis)	
Dynamic range	5 μ W/g to > 100 mW/g; Linearity: ± 0.2 dB	
Dimensions	Overall length: 337 mm (Tip: 20 mm) Tip diameter: 3.9 mm (Body: 12 mm) Distance from probe tip to dipole centers: 2.0 mm	
Application	General dosimetry up to 4 GHz Dosimetry in strong gradient fields Compliance tests of mobile phones	

Isotropic E-Field Probe EX3DV4 for Dosimetric Measurements

Construction	Symmetrical design with triangular core Built-in shielding against static charges PEEK enclosure material (resistant to organic solvents, e.g., DGBE)	
Calibration	ISO/IEC 17025 calibration service available.	
Frequency	10 MHz to >6 GHz; Linearity: ± 0.2 dB (30 MHz to 6 GHz)	
Directivity	± 0.3 dB in HSL (rotation around probe axis) ± 0.5 dB in tissue material (rotation normal to probe axis)	
Dynamic range	10 μ W/g to > 100 mW/g; Linearity: ± 0.2 dB (noise: typically < 1 μ W/g)	
Dimensions	Overall length: 337 mm (Tip: 20 mm) Tip diameter: 2.5 mm (Body: 12 mm) Typical distance from probe tip to dipole centers: 1 mm	
Application	High precision dosimetric measurements in any exposure scenario (e.g., very strong gradient fields). Only probe which enables compliance testing for frequencies up to 6 GHz with precision of better 30%	

2.5 Phantom description

SAM Twin Phantom

Shell Thickness	2mm±0.2mm;The ear region:6.0±0.2mm	
Filling Volume	Approximately 25 liters	
Dimensions	Length:1000mm; Width:500mm; Height: adjustable feet	
Measurement Areas	Left hand Right hand Flat phantom	

The bottom plate contains three pairs of bolts for locking the device holder. The device holder positions are adjusted to the standard measurement positions in the three sections. A white cover is provided to cover the phantom during off-periods to prevent water evaporation and changes in the liquid parameters. Free space scans of devices on top of this phantom cover are possible. Three reference marks are provided on the phantom counter. These reference marks are used to teach the absolute phantom position relative to the robot.

The following figure shows the definition of reference point:

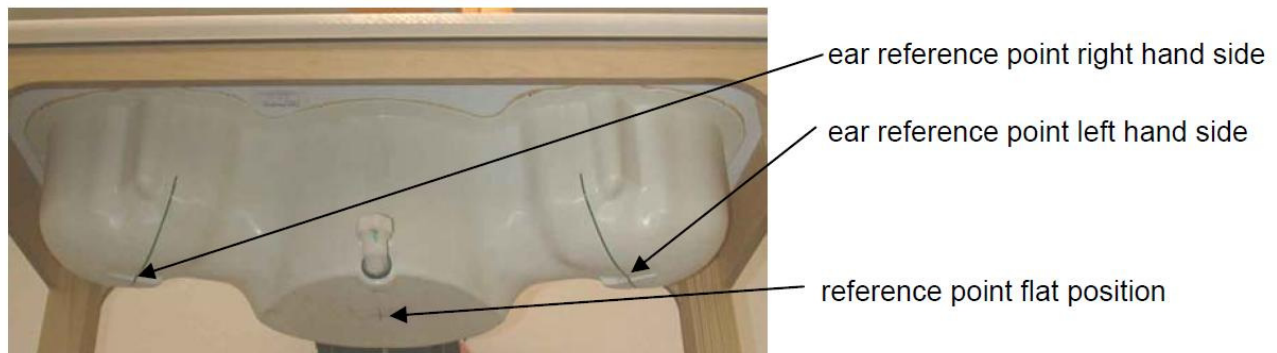

ELI4 Phantom

Shell Thickness	2mm±0.2mm	
Filling Volume	Approximately 30 liters	
Dimensions	Major axis:600mm; Minor axis:400mm;	
Measurement Areas	Flat phantom	

The ELI4 phantom is intended for compliance testing of handheld and body-mounted wireless devices in the frequency range of 30MHz to 6GHz. ELI4 is fully compatible with the latest draft of the standard IEC 62209-2 and all known tissue simulating liquids.

The phantom shell material is resistant to all ingredients used in the tissue-equivalent liquid recipes. The shell of the phantom including ear spacers is constructed from low permittivity and low loss material, with a relative permittivity $2 \leq \epsilon_r \leq 5$ at ≤ 3 GHz, $3 \leq \epsilon_r \leq 4$ at > 3 GHz and a loss tangent ≤ 0.05 .

2.6 Device holder description

The DASY5 device holder has two scales for device rotation (with respect to the body axis) and the device inclination (with respect to the line between the ear openings). The plane between the ear openings and the mouth tip has a rotation angle of 65° . The bottom plate contains three pair of bolts for locking the device holder. The device holder positions are adjusted to the standard measurement positions in the three sections. This device holder is used for standard mobile phones or PDA's only. If necessary an additional support of polystyrene material is used.



The DASY device holder is constructed of low-loss POM material having the following dielectric parameters: relative permittivity $\epsilon = 3$ and loss tangent $\sigma = 0.02$. The amount of dielectric material has been reduced in the closest vicinity of the device, since measurements have suggested that the influence of the clamp on the test results could thus be lowered.

The device holder permits the device to be positioned with a tolerance of $\pm 1^\circ$ in the tilt angle.

Larger DUT's (e.g. notebooks) cannot be tested using this device holder. Instead a support of bigger polystyrene cubes and thin polystyrene plates is used to position the DUT in all relevant positions to find and measure spots with maximum SAR values.

Therefore those devices are normally only tested at the flat part of the SAM.

2.7 Test Equipment List

This table gives a complete overview of the SAR measurement equipment.

Devices used during the test described are marked

	Manufacturer	Device	Type	Serial number	Date of last calibration)*	Valid period
<input checked="" type="checkbox"/>	SPEAG	Dosimetric E-Field Probe	EX3DV4	7381	2016-09-29	One year
<input type="checkbox"/>	SPEAG	835 MHz Dipole	D835V2	4d126	2015-07-23	Three years
<input type="checkbox"/>	SPEAG	900 MHz Dipole	D900V2	1d192	2016-02-02	Three years
<input type="checkbox"/>	SPEAG	1750 MHz Dipole	D1750V2	1145	2016-02-02	Three years
<input type="checkbox"/>	SPEAG	1900 MHz Dipole	D1900V2	5d143	2014-09-23	Three years
<input type="checkbox"/>	SPEAG	2000 MHz Dipole	D2000V2	1036	2015-11-25	Three years
<input type="checkbox"/>	SPEAG	2300 MHz Dipole	D2300V2	1020	2015-09-21	Three years
<input checked="" type="checkbox"/>	SPEAG	2450 MHz Dipole	D2450V2	978	2016-02-08	Three years
<input type="checkbox"/>	SPEAG	2600 MHz Dipole	D2600V2	1119	2016-02-03	Three years
<input type="checkbox"/>	SPEAG	5GHz Dipole	D5GHzV2	1155	2015-04-27	Three years
<input checked="" type="checkbox"/>	SPEAG	Data acquisition electronics	DAE4	1492	2016-09-28	One year
<input checked="" type="checkbox"/>	SPEAG	Software	DASY 5	N/A	NCR	NCR
<input type="checkbox"/>	SPEAG	Twin Phantom	SAM1	TP-1475	NCR	NCR
<input type="checkbox"/>	SPEAG	Twin Phantom	SAM2	TP-1474	NCR	NCR
<input type="checkbox"/>	SPEAG	Twin Phantom	SAM3	TP-1597	NCR	NCR
<input type="checkbox"/>	SPEAG	Twin Phantom	SAM4	TP-1620	NCR	NCR
<input checked="" type="checkbox"/>	SPEAG	Twin Phantom	SAM5	TP-1894	NCR	NCR
<input checked="" type="checkbox"/>	SPEAG	Twin Phantom	SAM6	TP-1892	NCR	NCR
<input type="checkbox"/>	SPEAG	Flat Phantom	ELI 5.0	TP-1111	NCR	NCR
<input type="checkbox"/>	R & S	Universal Radio Communication Tester	CMU 200	113989	2016-05-12	One year
<input type="checkbox"/>	R & S	WideBand Radio Communication Tester	CMW 500	126855	2016-07-07	One year
<input checked="" type="checkbox"/>	Agilent	Wireless Connectivity Test Set	N4010A	MY49081592	2016-08-05	One year
<input checked="" type="checkbox"/>	Agilent	Network Analyser	E5071B	MY42404956	2016-05-24	One year
<input checked="" type="checkbox"/>	Agilent	Dielectric Probe Kit	85070E	2484	NCR	NCR
<input checked="" type="checkbox"/>	Agilent	Signal Generator	E4438C	MY49071538	2016-03-01	One year
<input checked="" type="checkbox"/>	MINI-CIRCUITS	Amplifier	ZHL-42W	QA1402001	NCR	NCR
<input checked="" type="checkbox"/>	AR	Directional Coupler	DC7144M1	31190	2016-05-13	One year
<input checked="" type="checkbox"/>	Agilent	Power Meter	E4417A	MY54100027	2016-03-31	One year
<input checked="" type="checkbox"/>	Agilent	Power Meter Sensor	E9321A	MY54130007	2016-03-31	One year
<input checked="" type="checkbox"/>	Agilent	Power Meter Sensor	E9321A	MY54130001	2016-03-31	One year

Note:

- 1) Per KDB865664D01 requirements for dipole calibration, the test laboratory has adopted three-year extended calibration interval. Each measured dipole is expected to evaluate with the following criteria at least on annual interval in Appendix C.
 - a) There is no physical damage on the dipole;
 - b) System check with specific dipole is within 10% of calibrated value;
 - c) The most recent return-loss result, measured at least annually, deviates by no more than 20% from the previous measurement.
 - d) The most recent measurement of the real or imaginary parts of the impedance, measured at least annually is within 5Ω from the previous measurement.
- 2) Network analyzer probe calibration against air, distilled water and a shorting block performed before measuring liquid parameters.
- 3) *All the equipments are within the valid period when the tests are performed.

3 SAR Measurement Procedure

3.1 Scanning procedure

The DASY5 installation includes predefined files with recommended procedures for measurements and system check. They are read-only document files and destined as fully defined but unmeasured masks. All test positions (head or body-worn) are tested with the same configuration of test steps differing only in the grid definition for the different test positions.

- The “reference” and “drift” measurements are located at the beginning and end of the batch process. They measure the field drift at one single point in the liquid over the complete procedure. The indicated drift is mainly the variation of the DUT’s output power and should vary max. +/- 5 %.
- The “surface check” measurement tests the optical surface detection system of the DASY5 system by repeatedly detecting the surface with the optical and mechanical surface detector and comparing the results. The output gives the detecting heights of both systems, the difference between the two systems and the standard deviation of the detection repeatability. Air bubbles or refraction in the liquid due to separation of the sugar-water mixture gives poor repeatability (above $\pm 0.1\text{mm}$). To prevent wrong results tests are only executed when the liquid is free of air bubbles. The difference between the optical surface detection and the actual surface depends on the probe and is specified with each probe. (It does not depend on the surface reflectivity or the probe angle to the surface within $\pm 30^\circ$.)
- The “area scan” measures the SAR above the DUT or verification dipole on a parallel plane to the surface. It is used to locate the approximate location of the peak SAR with 2D spline interpolation. The robot performs a stepped movement along one grid axis while the local electrical field strength is measured by the probe. The probe is touching the surface of the SAM during acquisition of measurement values. The standard scan uses large grid spacing for faster measurement. Standard grid spacing for head measurements is 15 mm in x- and y- dimension ($\leq 2\text{GHz}$), 12 mm in x- and y- dimension (2-4 GHz) and 10mm in x- and y- dimension (4-6GHz). If a finer resolution is needed, the grid spacing can be reduced. Grid spacing and orientation have no influence on the SAR result. For special applications where the standard scan method does not find the peak SAR within the grid, e.g. mobile phones with flip cover, the grid can be adapted in orientation. Results of this coarse scan are shown in Appendix B.
- A “zoom scan” measures the field in a volume around the 2D peak SAR value acquired in the previous “coarse” scan. This is a fine grid with maximum scan spatial resolution: $\Delta x_{\text{zoom}}, \Delta y_{\text{zoom}} \leq 2\text{GHz} - \leq 8\text{mm}$, 2-4GHz - $\leq 5\text{ mm}$ and 4-6 GHz- $\leq 4\text{mm}$; $\Delta z_{\text{zoom}} \leq 3\text{GHz} - \leq 5\text{ mm}$, 3-4 GHz- $\leq 4\text{mm}$ and 4-6GHz- $\leq 2\text{mm}$ where the robot additionally moves the probe along the z-axis away from the bottom of the Phantom. DASY is also able to perform repeated zoom scans if more than 1 peak is found during area scan. In this document, the evaluated peak 1g and 10g averaged SAR values are shown in the 2D-graphics in Appendix B. Test results relevant for the specified standard (see chapter 1.4.) are shown in table form in chapter 7.2.
- A Z-axis scan measures the total SAR value at the x-and y-position of the maximum SAR value found during the cube scan. The probe is moved away in z-direction from the bottom of the SAM phantom in 2 mm steps. This measurement shows the continuity of the liquid and can - depending in the field strength – also show the liquid depth. A z-axis scan of the measurement with maximum SAR value is shown in Appendix B.

The following table summarizes the area scan and zoom scan resolutions per FCC KDB 865664D01:

Frequency	Maximun Area Scan resolution ($\Delta x_{area}, \Delta y_{area}$)	Maximun Zoom Scan spatial resolution ($\Delta x_{zoom}, \Delta y_{zoom}$)	Maximun Zoom Scan spatial resolution			Minimum zoom scan volume (x,y,z)
			Uniform Grid	Graded Grad		
			$\Delta z_{zoom}(n)$	$\Delta z_{zoom}(1)^*$	$\Delta z_{zoom}(n>1)^*$	
≤2GHz	≤15mm	≤8mm	≤5mm	≤4mm	$\leq 1.5 * \Delta z_{zoom}(n-1)$	≥30mm
2-3GHz	≤12mm	≤5mm	≤5mm	≤4mm	$\leq 1.5 * \Delta z_{zoom}(n-1)$	≥30mm
3-4GHz	≤12mm	≤5mm	≤4mm	≤3mm	$\leq 1.5 * \Delta z_{zoom}(n-1)$	≥28mm
4-5GHz	≤10mm	≤4mm	≤3mm	≤2.5mm	$\leq 1.5 * \Delta z_{zoom}(n-1)$	≥25mm
5-6GHz	≤10mm	≤4mm	≤2mm	≤2mm	$\leq 1.5 * \Delta z_{zoom}(n-1)$	≥22mm

3.2 Spatial Peak SAR Evaluation

The spatial peak SAR - value for 1 and 10 g is evaluated after the Cube measurements have been done. The basis of the evaluation are the SAR values measured at the points of the fine cube grid consisting of 5 x 5 x 7 points(with 8mm horizontal resolution) or 7 x 7 x 7 points(with 5mm horizontal resolution) or 8 x 8 x 7 points(with 4mm horizontal resolution). The algorithm that finds the maximal averaged volume is separated into three different stages.

- The data between the dipole center of the probe and the surface of the phantom are extrapolated. This data cannot be measured since the center of the dipole is 2.7 mm away from the tip of the probe and the distance between the surface and the lowest measuring point is about 1 mm (see probe calibration sheet). The extrapolated data from a cube measurement can be visualized by selecting 'Graph Evaluated'.
- The maximum interpolated value is searched with a straight-forward algorithm. Around this maximum the SAR - values averaged over the spatial volumes (1g or 10 g) are computed using the 3d-spline interpolation algorithm. If the volume cannot be evaluated (i.e., if a part of the grid was cut off by the boundary of the measurement area) the evaluation will be started on the corners of the bottom plane of the cube.
- All neighboring volumes are evaluated until no neighboring volume with a higher average value is found.

Extrapolation

The extrapolation is based on a least square algorithm [W. Gander, Computermathematik, p.168-180]. Through the points in the first 3 cm along the z-axis, polynomials of order four are calculated. These polynomials are then used to evaluate the points between the surface and the probe tip. The points, calculated from the surface, have a distance of 1 mm from each other.

Interpolation

The interpolation of the points is done with a 3d-Spline. The 3d-Spline is composed of three one-dimensional splines with the "Not a knot"-condition [W. Gander, Computermathematik, p.141-150] (x, y and z -direction) [Numerical Recipes in C, Second Edition, p.123ff].

Volume Averaging

At First the size of the cube is calculated. Then the volume is integrated with the trapezoidal algorithm. 8000 points (20x20x20) are interpolated to calculate the average.

Advanced Extrapolation

DASY5 uses the advanced extrapolation option which is able to compansate boundary effects on E-field probes.

3.3 Data Storage and Evaluation

Data Storage

The DASY5 software stores the acquired data from the data acquisition electronics as raw data (in microvolt readings from the probe sensors), together with all necessary software parameters for the data evaluation (probe calibration data, liquid parameters and device frequency and modulation data) in measurement files with the extension "DAE4". The software evaluates the desired unit and format for output each time the data is visualized or exported. This allows verification of the complete software setup even after the measurement and allows correction of incorrect parameter settings. For example, if a measurement has been performed with a wrong crest factor parameter in the device setup, the parameter can be corrected afterwards and the data can be re-evaluated.

The measured data can be visualized or exported in different units or formats, depending on the selected probe type ([V/m], [A/m], [°C], [mW/g], [mW/cm²], [dBrel], etc.). Some of these units are not available in certain situations or show meaningless results, e.g., a SAR output in a lossless media will always be zero. Raw data can also be exported to perform the evaluation with other software packages.

Data Evaluation by SEMCAD

The SEMCAD software automatically executes the following procedures to calculate the field units from the microvolt readings at the probe connector. The parameters used in the evaluation are stored in the configuration modules of the software:

Probe parameters:	- Sensitivity	Norm _i , a _{i0} , a _{i1} , a _{i2}
	- Conversion factor	ConvF _i
	- Diode compression point	Dcpi
Device parameters:	- Frequency	f
	- Crest factor	cf
Media parameters:	- Conductivity	σ
	- Density	ρ

These parameters must be set correctly in the software. They can be found in the component documents or they can be imported into the software from the configuration files issued for the DASY5 components. In the direct measuring mode of the multimeter option, the parameters of the actual system setup are used. In the scan visualization and export modes, the parameters stored in the corresponding document files are used.

The first step of the evaluation is a linearization of the filtered input signal to account for the compression characteristics of the detector diode. The compensation depends on the input signal, the diode type and the DC-transmission factor from the diode to the evaluation electronics.

If the exciting field is pulsed, the crest factor of the signal must be known to correctly compensate for peak power. The formula for each channel can be given as:

$$V_i = U_i + U_i^2 \cdot cf/dcpi$$

with V_i = compensated signal of channel i ($i = x, y, z$)
 U_i = input signal of channel i ($i = x, y, z$)
 cf = crest factor of exciting field (DASY parameter)
 $dcpi$ = diode compression point (DASY parameter)

From the compensated input signals the primary field data for each channel can be

evaluated:

$$\begin{aligned} \text{E-field probes:} & \quad E_i = (V_i / \text{Norm}_i \cdot \text{ConvF})^{1/2} \\ \text{H-field probes:} & \quad H_i = (V_i)^{1/2} \cdot (a_{i0} + a_{i1}f + a_{i2}f^2)/f \end{aligned}$$

with V_i = compensated signal of channel i (i = x, y, z)
 Norm_i = sensor sensitivity of channel i (i = x, y, z)
 [mV/(V/m)²] for E-field Probes
 ConvF = sensitivity enhancement in solution
 a_{ij} = sensor sensitivity factors for H-field probes
 f = carrier frequency [GHz]
 E_i = electric field strength of channel i in V/m
 H_i = magnetic field strength of channel i in A/m

The RSS value of the field components gives the total field strength (Hermitian magnitude):

$$E_{\text{tot}} = (E_x^2 + E_y^2 + E_z^2)^{1/2}$$

The primary field data are used to calculate the derived field units.

$$\text{SAR} = (E_{\text{tot}}^2 \cdot \sigma) / (\rho \cdot 1000)$$

with SAR = local specific absorption rate in mW/g
 E_{tot} = total field strength in V/m
 σ = conductivity in [mho/m] or [Siemens/m]
 ρ = equivalent tissue density in g/cm³

Note that the density is normally set to 1 (or 1.06), to account for actual brain density rather than the density of the simulation liquid. The power flow density is calculated assuming the excitation field to be a free space field.

$$P_{\text{pwe}} = E_{\text{tot}}^2 / 3770 \quad \text{or} \quad P_{\text{pwe}} = H_{\text{tot}}^2 \cdot 37.7$$

with P_{pwe} = equivalent power density of a plane wave in mW/cm²
 E_{tot} = total electric field strength in V/m
 H_{tot} = total magnetic field strength in A/m

4 System Verification Procedure

4.1 Tissue Verification

The simulating liquids should be checked at the beginning of a series of SAR measurements to determine if the dielectric parameters are within the tolerances of the specified target values. The measured conductivity and relative permittivity should be within $\pm 5\%$ of the target values.

The following materials are used for producing the tissue-equivalent materials.

Ingredients (% of weight)	Head Tissue						
	750	835	1750	1900	2300	2450	2600
Frequency Band (MHz)	750	835	1750	1900	2300	2450	2600
Water	39.2	41.45	52.64	55.242	62.82	62.7	55.242
Salt (NaCl)	2.7	1.45	0.36	0.306	0.51	0.5	0.306
Sugar	57.0	56.0	0.0	0.0	0.0	0.0	0.0
HEC	0.0	1.0	0.0	0.0	0.0	0.0	0.0
Bactericide	0.0	0.1	0.0	0.0	0.0	0.0	0.0
Triton X-100	0.0	0.0	0.0	0.0	0.0	0.0	0.0
DGBE	0.0	0.0	47.0	44.542	36.67	36.8	44.452
Ingredients (% of weight)	Body Tissue						
	750	835	1750	1900	2300	2450	2600
Frequency Band (MHz)	750	835	1750	1900	2300	2450	2600
Water	50.3	52.4	69.91	69.91	73.32	73.2	64.493
Salt (NaCl)	1.60	1.40	0.13	0.13	0.06	0.04	0.024
Sugar	47.0	45.0	0.0	0.0	0.0	0.0	0.0
HEC	0.0	1.0	0.0	0.0	0.0	0.0	0.0
Bactericide	0.0	0.1	0.0	0.0	0.0	0.0	0.0
Triton X-100	0.0	0.0	0.0	0.0	0.0	0.0	0.0
DGBE	0.0	0.0	29.96	29.96	26.62	26.7	32.252

Table 4: Tissue Dielectric Properties

Salt: 99+% Pure Sodium Chloride; Sugar: 98+% Pure Sucrose; Water: De-ionized, 16M Ω + resistivity
 HEC: Hydroxyethyl Cellulose; DGBE: 99+% Di(ethylene glycol) butyl ether, [2-(2-butoxyethoxy)ethanol]
 Triton X-100(ultra pure): Polyethylene glycol mono [4-(1,1,3,3-tetramethylbutyl)phenyl]ether

Simulating Head Liquid for 5G(HBBL3500-5800MHz), Manufactured by SPEAG:

Ingredients	(% by weight)
Water	50-65%
Mineral oil	10-30%
Emulsifiers	8-25%
Sodium salt	0-1.5%

Simulating Body Liquid for 5G(MBBL3500-5800MHz), Manufactured by SPEAG:

Ingredients	(% by weight)
Water	60-80%
Esters, Emulsifiers, Inhibitors	20-40%
Sodium salt	0-1.5%

Tissue Type	Measured Frequency (MHz)	Target Tissue		Measured Tissue		Deviation (Within +/-5%)		Liquid Temp.	Test Date
		ϵ_r	σ (S/m)	ϵ_r	σ (S/m)	$\Delta\epsilon_r$	$\Delta\sigma$		
2450MHz Head	2410	39.30	1.76	39.79	1.791	1.25%	1.76%	21.5°C	2017/1/13
	2435	39.20	1.79	39.70	1.815	1.28%	1.40%		
	2450	39.20	1.80	39.64	1.830	1.12%	1.67%		
	2460	39.20	1.81	39.60	1.840	1.02%	1.66%		
2450MHz Body	2410	52.80	1.91	53.77	1.917	1.84%	0.37%	21.5°C	2017/1/13
	2435	52.70	1.94	53.73	1.934	1.95%	-0.31%		
	2450	52.70	1.95	53.70	1.946	1.90%	-0.21%		
	2460	52.70	1.96	53.70	1.955	1.90%	-0.26%		

Table 5: Measured Tissue Parameter

Note: 1) The dielectric parameters of the tissue-equivalent liquid should be measured under similar ambient conditions and within 2°C of the conditions expected during the SAR evaluation to satisfy protocol requirements.

2) KDB 865664 was ensured to be applied for probe calibration frequencies greater than or equal to 50MHz of the EUT frequencies.

3) The above measured tissue parameters were used in the DASY software to perform interpolation via the DASY software to determine actual dielectric parameters at the test frequencies. The SAR test plots may slightly differ from the table above since the DASY rounds to three significant digits.

4.2 System Check

The system check is performed for verifying the accuracy of the complete measurement system and performance of the software. The system check is performed with tissue equivalent material according to IEEE P1528 (described above). The following table shows system check results for all frequency bands and tissue liquids used during the tests(Graphic Plot(s) see Appendix A).

System Check	Target SAR (1W)		Measured SAR (Normalized to 1W)		Deviation (Within +/-10%)		Liquid Temp.	Test Date
	1-g (W/kg)	10-g (W/kg)	1-g (W/kg)	10-g (W/kg)	Δ 1-g	Δ 10-g		
2450MHz Head	53.30	24.90	51.20	24.40	-3.94%	-2.01%	21.5°C	2017/1/13
2450MHz Body	52.10	24.70	49.20	23.64	-5.57%	-4.29%	21.5°C	2017/1/13

Table 6: System Check Results

4.3 System check Procedure

The system check is performed by using a system check dipole which is positioned parallel to the planar part of the SAM phantom at the reference point. The distance of the dipole to the SAM phantom is determined by a plexiglass spacer. The dipole is connected to the signal source consisting of signal generator and amplifier via a directional coupler, N-connector cable and adaption to SMA. It is fed with a power of 250 mW(below 5GHz) or 100mW(above 5GHz). To adjust this power a power meter is used. The power sensor is connected to the cable before the system check to measure the power at this point and do adjustments at the signal generator. At the outputs of the directional coupler both return loss as well as forward power are controlled during the system check to make sure that emitted power at the dipole is kept constant. This can also be checked by the power drift measurement after the test (result on plot).

System check results have to be equal or near the values determined during dipole calibration (target SAR in table above) with the relevant liquids and test system.

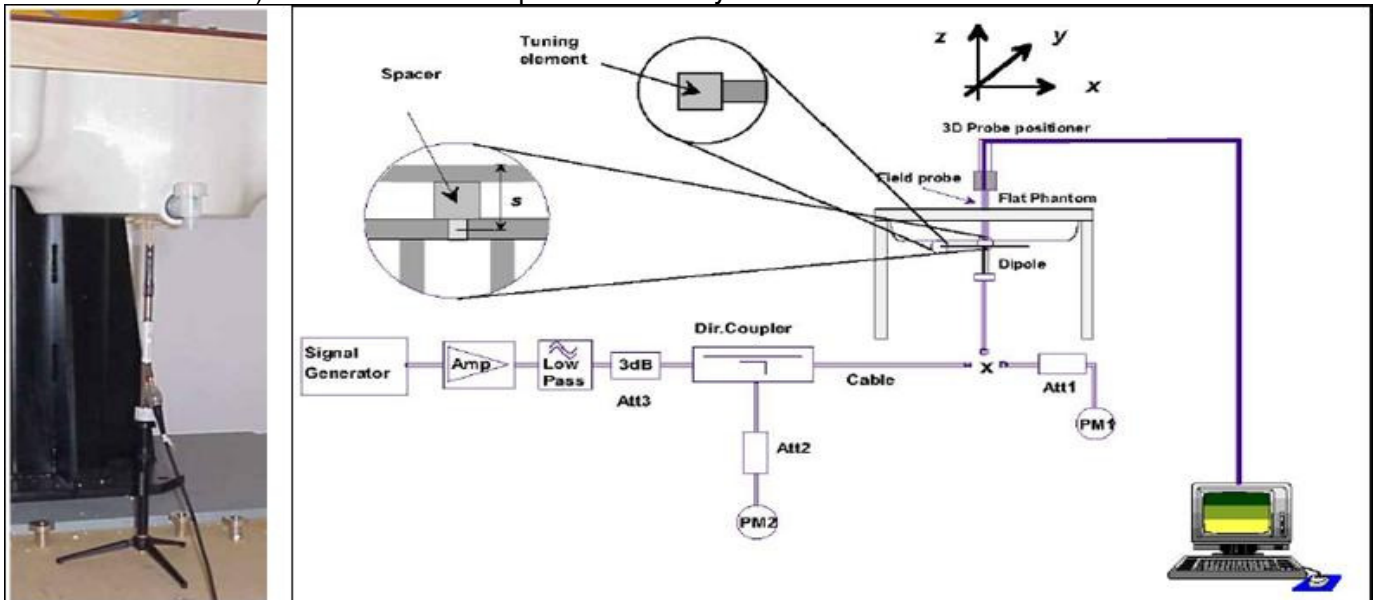

5 SAR measurement variability and uncertainty

5.1 SAR measurement variability

Per KDB865664 D01 SAR measurement 100 MHz to 6 GHz v01r04, SAR measurement variability must be assessed for each frequency band, which is determined by the SAR probe calibration point and tissue-equivalent medium used for the device measurements. The additional measurements are repeated after the completion of all measurements requiring the same head or body tissue-equivalent medium in a frequency band. The test device should be returned to ambient conditions (normal room temperature) with the battery fully charged before it is re-mounted on the device holder for the repeated measurement(s) to minimize any unexpected variations in the repeated results.

- 1) Repeated measurement is not required when the original highest measured SAR is < 0.80 W/kg; steps 2) through 4) do not apply.
- 2) When the original highest measured SAR is ≥ 0.80 W/kg, repeat that measurement once.
- 3) Perform a second repeated measurement only if the ratio of largest to smallest SAR for the original and first repeated measurements is > 1.20 or when the original or repeated measurement is ≥ 1.45 W/kg (~ 10% from the 1-g SAR limit).
- 4) Perform a third repeated measurement only if the original, first or second repeated measurement is ≥ 1.5 W/kg and the ratio of largest to smallest SAR for the original, first and second repeated measurements is > 1.20 .

The same procedures should be adapted for measurements according to extremity and occupational exposure limits by applying a factor of 2.5 for extremity exposure and a factor of 5 for occupational exposure to the corresponding SAR thresholds.

The detailed repeated measurement results are shown in Section 7.2.

5.2 SAR measurement uncertainty

The following uncertainty components are identified in accordance with IEEE 1528-2013:

Uncertainty component	Clause	Tol. (± %)	Prob. Dist.	Divisor	c_i (1-g)	c_i (10-g)	1 g u_i (± %)	10 g u_i (± %)	v_i^2 or v_{eff}
Measurement System									
Probe calibration	E.2.1	6.0%	N	1	1	1	6.00%	6.00%	∞
Axial isotropy	E.2.2	4.7%	R	√3	0.7	0.7	1.9%	1.9%	∞
Hemispherical isotropy	E.2.2	9.6%	R	√3	0.7	0.7	3.9%	3.9%	∞
Boundary effects	E.2.3	1.0%	R	√3	1	1	0.6%	0.6%	∞
Linearity	E.2.4	4.7%	R	√3	1	1	2.7%	2.7%	∞
System Detection limits	E.2.4	1.0%	R	√3	1	1	0.6%	0.6%	∞
Modulation response	E.2.5	2.4%	R	√3	1	1	1.4%	1.4%	∞
Readout Electronics	E.2.6	0.3%	N	1	1	1	0.3%	0.3%	∞
Response time	E.2.7	0.8%	R	√3	1	1	0.5%	0.5%	∞
Integration time	E.2.8	2.6%	R	√3	1	1	1.5%	1.5%	∞
RF ambient conditions—noise	E.6.1	3.0%	R	√3	1	1	1.7%	1.7%	∞
RF ambient conditions—reflections	E.6.1	3.0%	R	√3	1	1	1.7%	1.7%	∞
Probe positioner mechanical tolerance	E.6.2	0.4%	R	√3	1	1	0.2%	0.2%	∞
Probe positioning with respect to phantom shell	E.6.3	2.9%	N	√3	1	1	1.7%	1.7%	∞
Max. SAR evaluation	E.5	2.0%	N	√3	1	1	1.2%	1.2%	∞
Test Sample Related									
Device positioning	E.4.2	2.9%	N	1	1	1	2.9%	2.9%	71
Device holder	E.4.1	3.6%	N	1	1	1	3.6%	3.6%	5
Output power variation—SAR drift measurement	E.2.9	5.0%	R	√3	1	1	2.9%	2.9%	∞
SAR scaling	E.6.5	0.0%	R	√3	1	1	0.0%	0.0%	∞
Phantom and Set-up									
Phantom shell uncertainty	E.3.1	4.0%	R	√3	1	1	2.3%	2.3%	∞
Uncertainty in SAR correction for deviations in permittivity and conductivity	E.3.2	1.9%	N	1	1	0.84	1.9%	1.6%	∞
Liquid conductivity measurement	E.3.3	2.5%	N	1	0.78	0.71	2.0%	1.8%	∞
Liquid permittivity measurement	E.3.3	2.5%	N	1	0.23	0.26	0.6%	0.7%	∞
Liquid conductivity—temperature uncertainty	E.3.4	3.4%	R	√3	0.78	0.71	1.5%	1.4%	∞
Liquid permittivity—temperature uncertainty	E.3.4	0.4%	R	√3	0.23	0.26	0.1%	0.1%	∞
Combined Uncertainty							10.8%	10.8%	/
Expanded Std. Uncertainty (K=2)							21.6%	21.5%	/

Table 7: Measurement uncertainties applicable for frequencies less than 3GHz

Uncertainty component	Clause	Tol. (± %)	Prob. Dist.	Divisor	c _i (1-g)	c _i (10-g)	1 g ui (± %)	10 g ui (± %)	v _i ² or v _{eff}
Measurement System									
Probe calibration	E.2.1	6.55%	N	1	1	1	6.55%	6.55%	∞
Axial isotropy	E.2.2	4.7%	R	√3	0.7	0.7	1.9%	1.9%	∞
Hemispherical isotropy	E.2.2	9.6%	R	√3	0.7	0.7	3.9%	3.9%	∞
Boundary effects	E.2.3	2.0%	R	√3	1	1	1.2%	1.2%	∞
Linearity	E.2.4	4.7%	R	√3	1	1	2.7%	2.7%	∞
System Detection limits	E.2.4	1.0%	R	√3	1	1	0.6%	0.6%	∞
Modulation response	E.2.5	2.4%	R	√3	1	1	1.4%	1.4%	∞
Readout Electronics	E.2.6	0.3%	N	1	1	1	0.3%	0.3%	∞
Response time	E.2.7	0.8%	R	√3	1	1	0.5%	0.5%	∞
Integration time	E.2.8	2.6%	R	√3	1	1	1.5%	1.5%	∞
RF ambient conditions—noise	E.6.1	3.0%	R	√3	1	1	1.7%	1.7%	∞
RF ambient conditions—reflections	E.6.1	3.0%	R	√3	1	1	1.7%	1.7%	∞
Probe positioner mechanical tolerance	E.6.2	0.8%	R	√3	1	1	0.5%	0.5%	∞
Probe positioning with respect to phantom shell	E.6.3	6.7%	N	√3	1	1	3.9%	3.9%	∞
Max. SAR evaluation	E.5	4.0%	N	√3	1	1	2.3%	2.3%	∞
Test Sample Related									
Device positioning	E.4.2	2.9%	N	1	1	1	2.9%	2.9%	71
Device holder	E.4.1	3.6%	N	1	1	1	3.6%	3.6%	5
Output power variation—SAR drift measurement	E.2.9	5.0%	R	√3	1	1	2.9%	2.9%	∞
SAR scaling	E.6.5	0.0%	R	√3	1	1	0.0%	0.0%	∞
Phantom and Set-up									
Phantom shell uncertainty	E.3.1	4.0%	R	√3	1	1	2.3%	2.3%	∞
Uncertainty in SAR correction for deviations in permittivity and conductivity	E.3.2	1.9%	N	1	1	0.84	1.9%	1.6%	∞
Liquid conductivity measurement	E.3.3	4.2%	N	1	0.78	0.71	3.3%	3.0%	∞
Liquid permittivity measurement	E.3.3	4.1%	N	1	0.23	0.26	0.9%	1.1%	∞
Liquid conductivity—temperature uncertainty	E.3.4	2.5%	N	1	0.78	0.71	2.0%	1.8%	∞
Liquid permittivity—temperature uncertainty	E.3.4	2.5%	N	1	0.23	0.26	0.6%	0.7%	∞
Combined Uncertainty							11.9%	11.8%	/
Expanded Std. Uncertainty (K=2)							23.8%	23.7%	/

Table 8: Measurement uncertainties applicable for frequencies up to 6GHz

The following uncertainty components are identified in accordance with IEC/EN62209:

Uncertainty component	Clause	Tol. (± %)	Prob. Dist.	Divisor	c _i (1-g)	c _i (10-g)	1 g u _i (± %)	10 g u _i (± %)	v _i ² or v _{eff}
Measurement System									
Probe calibration	7.2.1	6.0%	N	1	1	1	6.00%	6.00%	∞
Axial isotropy	7.2.1.2	4.7%	R	√3	0.7	0.7	1.9%	1.9%	∞
Hemispherical isotropy	7.2.1.2	9.6%	R	√3	0.7	0.7	3.9%	3.9%	∞
Boundary effects	7.2.1.5	1.0%	R	√3	1	1	0.6%	0.6%	∞
Probe linearity	7.2.1.3	4.7%	R	√3	1	1	2.7%	2.7%	∞
System Detection limits	7.2.1.4	1.0%	R	√3	1	1	0.6%	0.6%	∞
Readout Electronics	7.2.1.6	0.3%	N	1	1	1	0.3%	0.3%	∞
Response time	7.2.1.7	0.8%	R	√3	1	1	0.5%	0.5%	∞
Integration time	7.2.1.8	2.6%	R	√3	1	1	1.5%	1.5%	∞
RF ambient conditions—noise	7.2.3.6	3.0%	R	√3	1	1	1.7%	1.7%	∞
RF ambient conditions—reflections	7.2.3.6	3.0%	R	√3	1	1	1.7%	1.7%	∞
Probe positioned	7.2.2.1	0.4%	R	√3	1	1	0.2%	0.2%	∞
Probe positioning	7.2.2.3	2.9%	N	√3	1	1	1.7%	1.7%	∞
Max. SAR evaluation	7.2.4	1.0%	N	√3	1	1	0.6%	0.6%	∞
Test Sample Related									
Device positioning	7.2.2.4	2.9%	N	1	1	1	2.9%	2.9%	71
Device holder	7.2.2.4.2	3.6%	N	1	1	1	3.6%	3.6%	∞
Power drift	7.2.3.5	5.0%	R	√3	1	1	2.9%	2.9%	∞
Phantom and Set-up									
Phantom uncertainty	7.2.2.2	4.0%	R	√3	1	1	2.3%	2.3%	∞
Liquid conductivity (target)	7.2.3.3	5.0%	R	√3	0.64	0.43	1.8%	1.2%	∞
Liquid conductivity (meas.)	7.2.3.3	2.5%	N	1	0.64	0.43	1.6%	1.1%	∞
Liquid permittivity (target)	7.2.3.4	5.0%	R	√3	0.6	0.49	1.7%	1.4%	∞
Liquid permittivity (meas.)	7.2.3.4	2.5%	N	1	0.6	0.49	1.5%	1.2%	∞
Combined Uncertainty							11.0%	10.8%	/
Expanded Std. Uncertainty (K=2)							22.0%	21.5%	/

Table 9: Measurement uncertainties applicable for frequencies less than 3GHz

Uncertainty component	Clause	Tol. (± %)	Prob. Dist.	Divisor	c_i (1-g)	c_i (10-g)	1 g u_i (± %)	10 g u_i (± %)	v_i^2 or v_{eff}
Measurement System									
Probe calibration	7.2.1	6.55%	N	1	1	1	6.55%	6.55%	∞
Axial isotropy	7.2.1.2	4.7%	R	√3	0.7	0.7	1.9%	1.9%	∞
Hemispherical isotropy	7.2.1.2	9.6%	R	√3	0.7	0.7	3.9%	3.9%	∞
Boundary effects	7.2.1.5	2.0%	R	√3	1	1	1.2%	1.2%	∞
Probe linearity	7.2.1.3	4.7%	R	√3	1	1	2.7%	2.7%	∞
System Detection limits	7.2.1.4	1.0%	R	√3	1	1	0.6%	0.6%	∞
Readout Electronics	7.2.1.6	0.3%	N	1	1	1	0.3%	0.3%	∞
Response time	7.2.1.7	0.8%	R	√3	1	1	0.5%	0.5%	∞
Integration time	7.2.1.8	2.6%	R	√3	1	1	1.5%	1.5%	∞
RF ambient conditions—noise	7.2.3.6	3.0%	R	√3	1	1	1.7%	1.7%	∞
RF ambient conditions—reflections	7.2.3.6	3.0%	R	√3	1	1	1.7%	1.7%	∞
Probe positioned	7.2.2.1	0.8%	R	√3	1	1	0.5%	0.5%	∞
Probe positioning	7.2.2.3	6.7%	N	√3	1	1	3.9%	3.9%	∞
Max. SAR evaluation	7.2.4	4.0%	N	√3	1	1	2.3%	2.3%	∞
Test Sample Related									
Device positioning	7.2.2.4	2.9%	N	1	1	1	2.9%	2.9%	71
Device holder	7.2.2.4.2	2.9%	N	1	1	1	3.6%	3.6%	∞
Power drift	7.2.3.5	5.0%	R	√3	1	1	2.9%	2.9%	∞
Phantom and Set-up									
Phantom uncertainty	7.2.2.2	4.0%	R	√3	1	1	2.3%	2.3%	∞
Liquid conductivity (target)	7.2.3.3	5.0%	R	√3	0.64	0.43	1.8%	1.2%	∞
Liquid conductivity (meas.)	7.2.3.3	2.5%	N	1	0.64	0.43	1.6%	1.1%	∞
Liquid permittivity (target)	7.2.3.4	5.0%	R	√3	0.6	0.49	1.7%	1.4%	∞
Liquid permittivity (meas.)	7.2.3.4	2.5%	N	1	0.6	0.49	1.5%	1.2%	∞
Combined Uncertainty							12.1%	11.9%	/
Expanded Std. Uncertainty (K=2)							24.2%	23.7%	/

Table 10: Measurement uncertainties applicable for frequencies up to 6GHz

6 SAR Test Configuration

6.1 Test Positions Configuration

Per KDB 447498 D01, transmitters that are built-in within a wrist watch or similar wrist-worn devices typically operate in speaker mode for voice communication, with the device worn on the wrist and positioned next to the mouth. Next to the mouth exposure requires 1-g SAR, and the wrist-worn condition requires 10-g extremity SAR. The 10-g extremity and 1-g SAR test exclusions may be applied to the wrist and face exposure conditions. When SAR evaluation is required, next to the mouth use is evaluated with the front of the device positioned at 10 mm from a flat phantom filled with head tissue-equivalent medium. The wrist bands should be strapped together to represent normal use conditions. SAR for wrist exposure is evaluated with the back of the devices positioned in direct contact against a flat phantom fill with body tissue-equivalent medium. The wrist bands should be unstrapped and touching the phantom. The space introduced by the watch or wrist bands and the phantom must be representative of actual use conditions.

6.1.1 10-g Extremity Exposure Condition

Per KDB447498 D01, the wrist watch requires extremity 10 gram SAR testing for the wrist (4.0 W/kg limit) with the back of the device in direct contact with the flat phantom. The strap shall be opened so that it is divided into two parts as shown in Figure below. The device shall be positioned directly against the phantom surface with the strap straightened as much as possible and the back of the device towards the phantom. If the strap cannot normally be opened to allow placing in direct contact with the phantom surface, it may be necessary to break the strap of the device but ensuring to not damage the antenna.

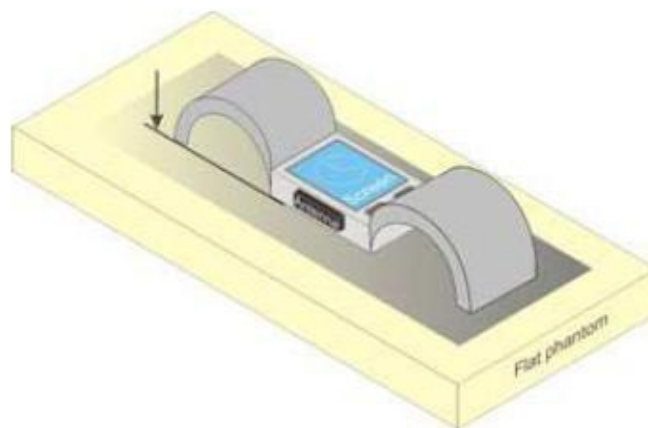

Figure – Test position for Limb-worn device

For this device, the rigid wrist band is non-metallic. The wrist bands don't contain any electronic circuitry and antenna inside. So for Limbs Exposure Condition, the watch is tested with bands taken off using the flat phantom. The back side of the watch can be positioned in direct contact against a flat phantom after wrist band taken off. It can be ensured that it will not damage the antenna.

6.1.2 Next-to-Mouth Exposure Condition

The device also has a speaker mode, so head SAR testing (1.6 W/kg limit) of the front face of the device at a distance of 10mm from the flat phantom is appropriate per section 6.2 of FCC KDB Publication 447498 D01.

6.2 WiFi Test Configuration

For WiFi SAR testing, a communication link is set up with the testing software for WiFi mode test. During the test, at the each test frequency channel, the EUT is operated at the RF continuous emission mode. The test procedures in KDB 248227D01 are applied.

6.2.1 Initial Test Position Procedure

For exposure condition with multiple test position, such as handsets operating next to the ear, devices with hotspot mode or UMPC mini-tablet, procedures for initial test position can be applied. Using the transmission mode determined by the DSSS procedure or initial test configuration, area scans are measured for all position in an exposure condition. The test position with the highest extrapolated (peak) SAR is used as the initial test position. When reported SAR for the initial test position is $\leq 0.4\text{W/kg}$, no additional testing for the remaining test position is required. Otherwise, SAR is evaluated at the subsequent highest peak SAR position until the reported SAR result is $\leq 0.8\text{W/kg}$ or all test position are measured. For all positions/configurations tested using the initial test position and subsequent test positions, when the *reported* SAR is $> 0.8\text{W/kg}$, SAR is measured for these test positions/configurations on the subsequent next highest measured output power channel(s) until the *reported* SAR is $\leq 1.2\text{W/kg}$ or all required channels are tested.

6.2.2 Initial Test Configuration Procedure

An initial test configuration is determined for OFDM transmission modes according to the channel bandwidth, modulation and data rate combination(s) with the highest maximum output power specified for production units in each standalone and aggregated frequency band. SAR is measured using the highest measured maximum output power channel. For configurations with the same specified or measured maximum output power, additional transmission mode and test channel selection procedures are required (see section 5.3.2 of KDB 248227D01). SAR test reduction of subsequent highest output test channels is based on the *reported* SAR of the initial test configuration.

For next to the ear, hotspot mode and UMC mini-tablet exposure configurations where multiple test positions are required, the initial test position procedure is applied to minimize the number of test positions required for SAR measurement using the initial test configuration transmission mode. For fixed exposure conditions that do not have multiple SAR test positions, SAR is measured in the transmission mode determined by the initial test configuration.

When the *reported* SAR of the initial test configuration is $> 0.8\text{W/kg}$, SAR measurement is required for the subsequent next highest measured output power channel(s) in the initial test configuration until the *reported* SAR is $\leq 1.2\text{W/kg}$ or all required channels are tested.

6.2.3 Sub Test Configuration Procedure

SAR measurement requirements for the remaining 802.11 transmission mode configurations that have not been tested in the initial test configuration are determined separately for each standalone and aggregated frequency band, in each exposure condition, according to the maximum output power specified for production units.

When the highest reported SAR for the initial test configuration, according to the initial test position or fixed exposure position requirements, is adjusted by the ratio of the subsequent test configuration to initial test configuration specified maximum output power and the adjusted SAR is $\leq 1.2\text{W/kg}$, SAR is not required for that subsequent test configuration.

6.2.4 WiFi 2.4G SAR Test Procedures

Separate SAR procedures are applied to DSSS and OFDM configurations in the 2.4 GHz band to simplify DSSS test requirements. For 802.11b DSSS SAR measurements, DSSS SAR procedure applies to fixed exposure test position and initial test position procedure applies to multiple exposure test positions.

A) 802.11b DSSS SAR Test Requirements

SAR is measured for 2.4 GHz 802.11b DSSS using either a fixed test position or, when applicable, the initial test position procedure. SAR test reduction is determined according to the following:

- 1) When the *reported* SAR of the highest measured maximum output power channel (section 3.1 of of KDB 248227D01) for the exposure configuration is ≤ 0.8 W/kg, no further SAR testing is required for 802.11b DSSS in that exposure configuration.
- 2) When the *reported* SAR is > 0.8 W/kg, SAR is required for that exposure configuration using the next highest measured output power channel. When any *reported* SAR is > 1.2 W/kg, SAR is required for the third channel; i.e., all channels require testing.

B) 2.4GHz 802.11g/n OFDM SAR Test Exclusion Requirements

When SAR measurement is required for 2.4 GHz 802.11g/n OFDM configurations, the measurement and test reduction procedures for OFDM are applied (section 5.3 of of KDB 248227D01). SAR is not required for the following 2.4 GHz OFDM conditions.

- 1) When KDB Publication 447498 SAR test exclusion applies to the OFDM configuration.
- 2) When the highest *reported* SAR for DSSS is adjusted by the ratio of OFDM to DSSS specified maximum output power and the adjusted SAR is ≤ 1.2 W/kg.

C) SAR Test Requirements for OFDM configurations

When SAR measurement is required for 802.11 g/n OFDM configurations, each standalone and frequency aggregated band is considered separately for SAR test reduction. In applying the initial test configuration and subsequent test configuration procedures, the 802.11 transmission configuration with the highest specified maximum output power and the channel within a test configuration with the highest measured maximum output power should be clearly distinguished to apply the procedures.

7 SAR Measurement Results

7.1 Conducted power measurements

7.1.1 Conducted power measurements of WiFi 2.4G

Mode	Channel	Frequency (MHz)	Data Rate (Mbps)	Tune-up	Average Power (dBm)	SAR Test (Yes/No)
802.11b	1	2412	1	17.00	15.35	Yes
	6	2437		17.00	15.42	Yes
	11	2462		17.00	15.20	Yes
802.11g	1	2412	6	14.00	/	No
	6	2437		14.00	/	No
	11	2462		14.00	/	No
802.11n 20M	1	2412	6.5	13.00	/	No
	6	2437		13.00	/	No
	11	2462		13.00	/	No

Table 11: Conducted power measurement results of WiFi 2.4G.

Note: The Average conducted power of WiFi is measured with RMS detector.

7.1.2 Conducted power measurements of BT

BT 2450	Tune-up	Average Conducted Power (dBm)		
		0CH	39CH	78CH
DH5	17.00	15.05	15.22	15.75
2DH5	14.00	13.31	13.52	13.79
3DH5	14.00	13.42	13.53	13.65
BT 2450	Tune-up	Average Conducted Power (dBm)		
		0CH	19CH	39CH
BLE	10.00	5.86	6.50	5.90

Table 12: Conducted power measurement results of BT

Note: The conducted power of BT is measured with RMS detector.

7.2 SAR measurement Results

General Notes:

- 1) Per KDB447498 D01, all SAR measurement results are scaled to the maximum tune-up tolerance limit to demonstrate SAR compliance.
- 2) Per KDB447498 D01, testing of other required channels within the operating mode of a frequency band is not required when the reported 1-g or 10-g SAR for the mid-band or highest output power channel is:
 - $\leq 0.8\text{W/kg}$ for 1-g or 2.0W/kg for 10-g respectively, when the transmission band is $\leq 100\text{MHz}$.
 - $\leq 0.6\text{ W/kg}$ or 1.5 W/kg , for 1-g or 10-g respectively, when the transmission band is between 100 MHz and 200 MHz.
 - $\leq 0.4\text{ W/kg}$ or 1.0 W/kg , for 1-g or 10-g respectively, when the transmission band is $\geq 200\text{ MHz}$.When the maximum output power variation across the required test channels is $> \frac{1}{2}\text{ dB}$, instead of the middle channel, the highest output power channel must be used.
- 3) Per KDB865664 D01, for each frequency band, repeated SAR measurement is required only when the measured SAR is $\geq 0.8\text{W/kg}$; if the deviation among the repeated measurement is $\leq 20\%$, and the measured SAR $< 1.45\text{W/kg}$, only one repeated measurement is required.
- 4) Per KDB865664 D02, SAR plot is only required for the highest measured SAR in each exposure configuration, wireless mode and frequency band combination; Plots are also required when the measured SAR is $> 1.5\text{ W/kg}$, or $> 7.0\text{ W/kg}$ for occupational exposure. The published RF exposure KDB procedures may require additional plots; for example, to support SAR to peak location separation ratio test exclusion and/or volume scan post-processing (Refer to appendix B for detailed SAR plots).

WiFi Notes:

Per KDB248227D01:

- 1) When reported SAR for the initial test position is $\leq 0.4\text{W/kg}$, no additional testing for the remaining test position is required. Otherwise, SAR is evaluated at the subsequent highest peak SAR position until the reported SAR result is $\leq 0.8\text{W/kg}$ or all test position are measured. For all positions/configurations tested using the initial test position and subsequent test positions, when the *reported* SAR is $> 0.8\text{ W/kg}$, SAR is measured for these test positions/configurations on the subsequent next highest measured output power channel(s) until the *reported* SAR is $\leq 1.2\text{ W/kg}$ or all required channels are tested.
- 2) The highest SAR measured for the initial test position or initial test configuration should be used to determine SAR test exclusion according to the sum of 1-g SAR and SAR peak to location ratio provisions in KDB 447498. In addition, a test lab may also choose to perform standalone SAR measurements for test positions and 802.11 configurations that are not required by the initial test position or initial test configuration procedures and apply the results to determine simultaneous transmission SAR test exclusion, according to sum of 1-g and SAR peak to location ratio requirements to reduce the number of simultaneous transmission SAR measurements.
- 3) For WiFi 2.4G, SAR is measured for 2.4 GHz 802.11b DSSS using the initial test position procedure. SAR is not required for the 2.4 GHz 802.11g/n OFDM conditions when KDB Publication 447498 SAR test exclusion applies to the OFDM configuration or when the highest reported SAR for DSSS is adjusted by the ratio of OFDM to DSSS specified maximum output power and the adjusted SAR is $\leq 1.2\text{ W/kg}$.

BT Notes:

- 1) Speaker mode for voice communication is not applicable for BT. So Next-to-Mouth Exposure SAR test for BT is not required.

7.2.1 SAR measurement Result of WiFi 2.4G

Test Position and Dist.	Wrist-band	Test channel /Freq. (MHz)	Test Mode	SAR Value (W/kg)		Power Drift (dB)	Conducted Power (dBm)	Tune-up Power (dBm)	Scaled 1-g SAR (W/kg)	SAR Plot.
				Area Scan 1-g	Zoom Scan 1-g					
Front side 10mm	LEO-BX9 test data									
	Non-Metallic	6/2437	802.11 b	0.197	0.165	0.03	15.42	17.00	0.237	/
	Non-Metallic	1/2412	802.11 b	0.213	0.196	-0.12	15.35	17.00	0.287	Yes
	Non-Metallic	11/2462	802.11 b	0.149	0.146	0.07	15.20	17.00	0.221	/

Table 13: Next to Mouth Exposure SAR test results of WiFi 2.4G (1.6W/kg Limit)

Test Position and Dist.	Wrist-band	Test channel /Freq. (MHz)	Test Mode	SAR Value (W/kg)		Power Drift (dB)	Conducted Power (dBm)	Tune-up Power (dBm)	Scaled 10-g SAR (W/kg)	SAR Plot.
				Area Scan 10-g	Zoom Scan 10-g					
Back side 0mm	LEO-BX9 test data									
	Non-Metallic	6/2437	802.11 b	0.067	0.078	0.03	15.42	17.00	0.112	Yes

Table 14: 10-g Extremity Exposure SAR test results of WiFi 2.4G (4.0W/kg Limit)

According to KDB248227 D01, The reported SAR must be scaled to 100% transmission duty factor to determine compliance at maximum tune-up tolerance limit. The scaled reported SAR is presented as below.

Test Position and Dist.	Wrist-band	Test channel /Freq. (MHz)	Test Mode	Scaled SAR1-g (W/kg)	Actual duty factor	Maximum duty factor	Reported SAR _{1-g} (W/kg)
Front side 10mm	LEO-BX9 test data						
	Non-Metallic	6/2437	802.11 b	0.237	97.49%	100%	0.244
	Non-Metallic	1/2412	802.11 b	0.287	97.49%	100%	0.294
	Non-Metallic	11/2462	802.11 b	0.221	97.49%	100%	0.227

Test Position and Dist.	Wrist-band	Test channel /Freq. (MHz)	Test Mode	Scaled SAR10-g (W/kg)	Actual duty factor	Maximum duty factor	Reported SAR _{10-g} (W/kg)
Back side 0mm	LEO-BX9 test data						
	Non-Metallic	6/2437	802.11 b	0.112	97.49%	100%	0.115

Mode	Tune-up (dBm)	Tune-up (mW)	Highest Reported SAR(W/kg)	Adjusted SAR (W/kg)	SAR test
802.11b	17.00	50.12	0.294	/	Yes
802.11g	14.00	25.12	/	0.147	No
802.11n 20M	13.00	19.95	/	0.117	No

Note: Per KDB248227D01, for SAR test of WiFi 2.4G,

- 1) SAR is measured for 2.4 GHz 802.11b DSSS using the initial test position procedure.
- 2) As the highest *reported* SAR for DSSS is adjusted by the ratio of OFDM 802.11g/n to DSSS specified maximum output power and the adjusted SAR is < 1.2 W/kg, so SAR for 802.11g/n is not required.

7.2.2 SAR measurement Result of BT

Test Position and Dist.	Wrist-band	Test channel /Freq. (MHz)	Test Mode	SAR Value (W/kg)		Power Drift (dB)	Condu-cted Power (dBm)	Tune-up Power (dBm)	Report-ed 10-g SAR (W/kg)	SAR Plot
				1-g	10-g					
Back side 0mm	LEO-BX9 test data									
	Non-Metallic	78/2480	DH5	0.119	0.050	0.13	15.75	17.00	0.066	Yes

Table 15: 10-g Extremity Exposure SAR test results of BT (4.0W/kg Limit)

7.3 Multiple Transmitter Evaluation

The following tables list information which is relevant for the decision if a simultaneous transmit evaluation is necessary according to FCC KDB 447498D01 General RF Exposure Guidance v06.

The location of the antennas inside the device is shown as below picture:

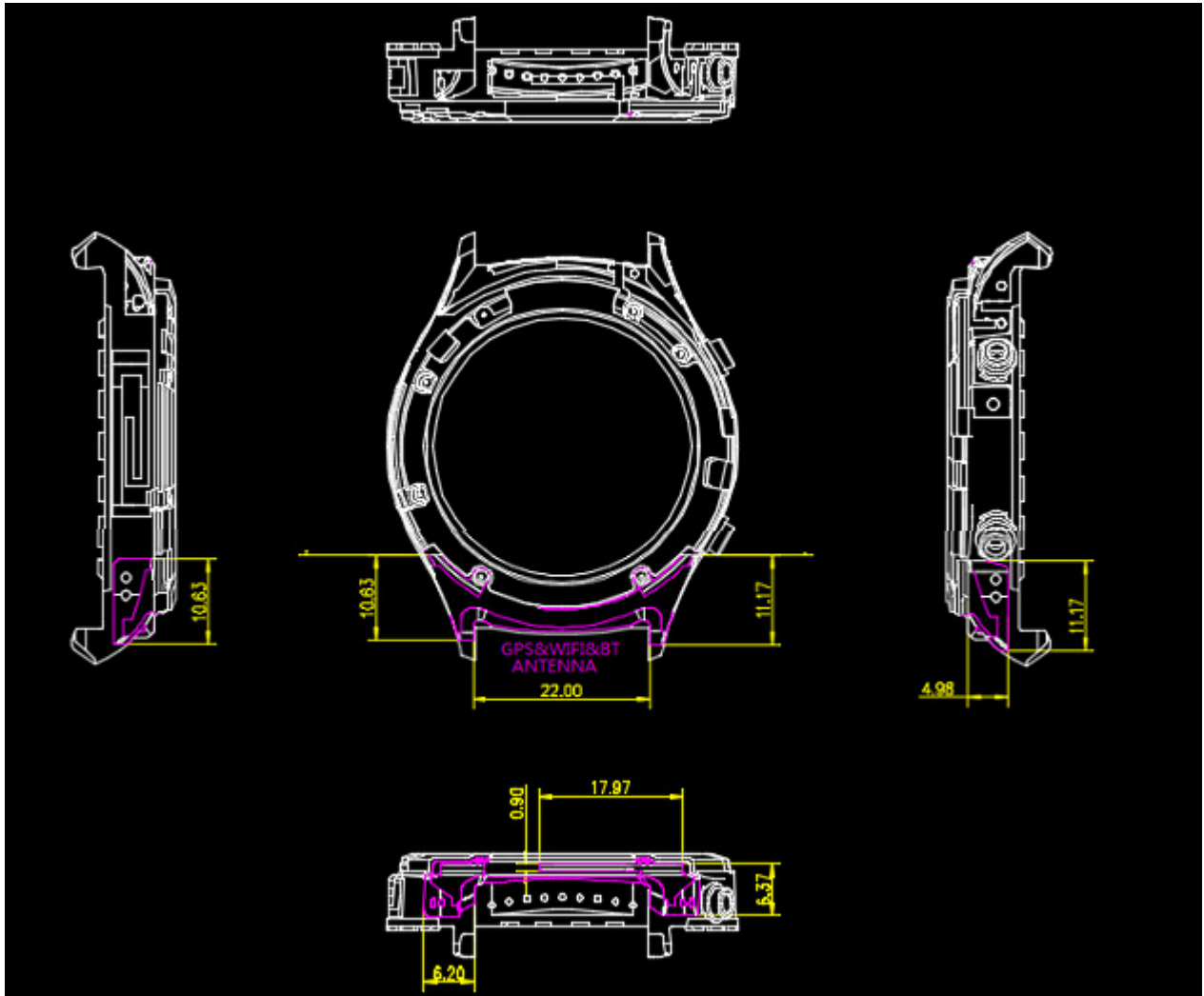

Note:

- 1) The NFC antenna does not have the transmitter function
- 2) WiFi and BT share the same antenna.

7.3.1 Stand-alone SAR test exclusion

Per RSS-102 Issue 5(2015) standard, SAR evaluation is required if the separation distance between the user and/or bystander and the antenna and/or radiating element of the device is less than or equal to 20 cm, except when the device operates at or below the applicable output power level (adjusted for tune-up tolerance) for the specified separation distance defined in the following Table:

Frequency (MHz)	Exemption Limits (mW)				
	At separation distance of ≤ 5 mm	At separation distance of 10 mm	At separation distance of 15 mm	At separation distance of 20 mm	At separation distance of 25 mm
≤ 300	71 mW	101 mW	132 mW	162 mW	193 mW
450	52 mW	70 mW	88 mW	106 mW	123 mW
835	17 mW	30 mW	42 mW	55 mW	67 mW
1900	7 mW	10 mW	18 mW	34 mW	60 mW
2450	4 mW	7 mW	15 mW	30 mW	52 mW
3500	2 mW	6 mW	16 mW	32 mW	55 mW
5800	1 mW	6 mW	15 mW	27 mW	41 mW

Table 16: SAR evaluation – Exemption limits for routine evaluation(RSS-102 Issue 5)

Output power level shall be the higher of the maximum conducted or equivalent isotropically radiated power (e.i.r.p.) source-based, time-averaged output power.

Mode	Position	P_{max} (dBm)*	Gain (dBi)	Distance (mm)	f (GHz)	Pmax (mW)	SAR Exclusion threshold (mW)***	SAR test exclusion
WiFi 2.4G	Next to mouth	17.00	-5.0	10	2.450	50.1	7	No
WiFi 2.4G	10g Extremity	17.00	-5.0	<5	2.450	50.1	10	No
BT	10g Extremity	17.00	-5.0	<5	2.450	50.1	10	No

Table 17: Standalone SAR test exclusion for WiFi 2.4G/BT

Note:

- 1)* - Per RSS-102 Issue 5, output power level shall be the higher of the maximum conducted or equivalent isotropically radiated power (e.i.r.p.) source-based, time-averaged output power.
- 2)** The test separation distance for this device is <5 mm, so a distance of 5 mm is applied to determine SAR test exclusion per RSS-102 Issue 5.
- 3) *** product specific 10-g SAR Test Exclusion Power Thresholds are 2.5 times higher than the 1-g SAR Test Exclusion Thresholds per RSS-102 Issue 5.
- 4) Speaker mode for voice communication is not applicable for BT. So Next-to-Mouth Exposure SAR test for BT is not required.

7.3.2 Simultaneous Transmission Possibilities

The device only has one WiFi /BT Tx antenna. The device does not support simultaneous WiFi and BT, because they share the same antenna. So Simultaneous Transmission SAR is not required.

Appendix A. System Check Plots

(Pls See Appendix No.: SYBH(Z-SAR)012012017-3A, total: 3 pages)

Appendix B. SAR Measurement Plots

(Pls See Appendix No.: SYBH(Z-SAR)012012017-3B, total: 4 pages)

Appendix C. Calibration Certificate

(Pls See Appendix No.: SYBH(Z-SAR)012012017-3C, total: 53 pages)

Appendix D. Photo documentation

(Pls See Appendix No.: SYBH(Z-SAR)012012017-3D, total: 4 pages)

End