



RF TEST REPORT

Applicant Huawei Technologies Co., Ltd.
FCC ID QISKSA-LX3
Product Smart Phone
Brand HONOR
Model KSA-LX3
Report No. R1903H0046-R3
Issue Date April 12, 2019

TA Technology (Shanghai) Co., Ltd. tested the above equipment in accordance with the requirements in **FCC CFR47 Part 2 (2019)/ FCC CFR47 Part 27C (2019)**. The test results show that the equipment tested is capable of demonstrating compliance with the requirements as documented in this report.

Performed by: Peng Tao

Approved by: Kai Xu

TA Technology (Shanghai) Co., Ltd.

No.145, Jintang Rd, Tangzhen Industry Park, Pudong Shanghai, China

TEL: +86-021-50791141/2/3

FAX: +86-021-50791141/2/3-8000

Table of Contents

1	Test Laboratory	4
1.1	Notes of the Test Report	4
1.2	Test facility	4
1.3	Testing Location	5
2	General Description of Equipment under Test	6
3	Applied Standards	8
4	Test Configuration	9
5	Test Case Results	11
5.1	RF Power Output	11
5.2	Effective Isotropic Radiated Power	17
5.3	Occupied Bandwidth	22
5.4	Band Edge Compliance	36
5.5	Peak-to-Average Power Ratio (PAPR)	53
5.6	Frequency Stability	56
5.7	Spurious Emissions at Antenna Terminals	63
5.8	Radiates Spurious Emission	82
6	Main Test Instruments	88
	ANNEX A: Product Change Description	89

Summary of Measurement Results

Number	Test Case	Clause in FCC rules	Verdict
1	RF power output	2.1046	Refer to the Original
2	Effective Isotropic Radiated power	27.50(d)(4) /27.50(h)(2)- Mobile and other user stations	Refer to the Original
3	Occupied Bandwidth	2.1049	Refer to the Original
4	Band Edge Compliance	27.53(h) /27.53(m)	Refer to the Original
5	Peak-to-Average Power Ratio	27.50(d)/KDB971168 D01(5.7)	Refer to the Original
6	Frequency Stability	2.1055 / 27.54	Refer to the Original
7	Spurious Emissions at Antenna Terminals	2.1051 27.53(h) /27.53(m)	Refer to the Original
8	Radiates Spurious Emission	2.1053 /27.53(h) /27.53(m)	Refer to the Original
Date of Testing: March 17, 2019 ~ March 29, 2019			
Note: PASS: The EUT complies with the essential requirements in the standard. FAIL: The EUT does not comply with the essential requirements in the standard.			

KSA-LX3 (Report No:R1903H0046-R3) is a variant model of AMN-LX3 (Report No: R1903H0043-R3). Test values duplicated from Original for variant. There is no test for variant in this report. The detailed product change description please refers to the ANNEX A.

1 Test Laboratory

1.1 Notes of the Test Report

This report shall not be reproduced in full or partial, without the written approval of **TA technology (shanghai) co., Ltd.** The results documented in this report apply only to the tested sample, under the conditions and modes of operation as described herein .Measurement Uncertainties were not taken into account and are published for informational purposes only. This report is written to support regulatory compliance of the applicable standards stated above.

1.2 Test facility

CNAS (accreditation number: L2264)

TA Technology (Shanghai) Co., Ltd. has obtained the accreditation of China National Accreditation Service for Conformity Assessment (CNAS).

FCC (Designation number: CN1179, Test Firm Registration Number: 446626)

TA Technology (Shanghai) Co., Ltd. has been listed on the US Federal Communications Commission list of test facilities recognized to perform electromagnetic emissions measurements.

IC (recognition number is 8510A)

TA Technology (Shanghai) Co., Ltd. has been listed by industry Canada to perform electromagnetic emission measurement.

VCCI (recognition number is C-4595, T-2154, R-4113, G-10766)

TA Technology (Shanghai) Co., Ltd. has been listed by industry Japan to perform electromagnetic emission measurement.

A2LA (Certificate Number: 3857.01)

TA Technology (Shanghai) Co., Ltd. has been listed by American Association for Laboratory Accreditation to perform electromagnetic emission measurement.

1.3 Testing Location

Company: TA Technology (Shanghai) Co., Ltd.
Address: No.145, Jintang Rd, Tangzhen Industry Park, Pudong Shanghai, China
City: Shanghai
Post code: 201201
Country: P. R. China
Contact: Xu Kai
Telephone: +86-021-50791141/2/3
Fax: +86-021-50791141/2/3-8000
Website: <http://www.ta-shanghai.com>
E-mail: xukai@ta-shanghai.com

2 General Description of Equipment under Test

Client Information

Applicant	Huawei Technologies Co., Ltd.
Applicant address	Administration Building, Headquarters of Huawei Technologies Co., Ltd., Bantian, Longgang District Shenzhen 518129 P.R.China
Manufacturer	Huawei Technologies Co., Ltd.
Manufacturer address	Administration Building, Headquarters of Huawei Technologies Co., Ltd., Bantian, Longgang District Shenzhen 518129 P.R.China

General information

EUT Description			
Model	KSA-LX3		
IMEI	IMEI 1: 866698040023628 IMEI 2: 866698040028825		
Hardware Version	HL1AMNM		
Software Version	5.0.1.37(C900E20R1P2)		
Power Supply	Battery/AC adapter		
Antenna Type	Internal Antenna		
Antenna Gain	WCDMA Band IV: -0.41dBi LTE Band 4: -0.41dBi LTE Band 7: -0.37dBi		
Test Mode(s)	WCDMA Band IV; LTE Band 4; LTE Band 7		
Test Modulation	(WCDMA)QPSK, 16QAM; (LTE)QPSK 16QAM;		
HSDPA UE Category	14		
HSUPA UE Category	7		
DC-HSDPA UE Category	24		
HSPA+ UE Category	7		
LTE Category	4		
Maximum E.I.R.P./ E.R.P.	WCDMA Band IV:	21.57dBm	
	LTE Band 4:	21.43dBm	
	LTE Band 7:	20.40dBm	
Rated Power Supply Voltage:	3.82V		
Extreme Voltage	Minimum: 3.6V Maximum: 4.4V		
Extreme Temperature	Lowest: -10°C Highest: +55°C		
Operating Frequency Range(s)	Mode	Tx (MHz)	Rx (MHz)
	WCDMA Band IV	1710 ~ 1755	2110 ~ 2155
	LTE Band 4	1710 ~ 1755	2110 ~ 2155
	LTE Band 7	2500 ~ 2570	2620 ~ 2690

EUT Accessory	
Adapter 1	Manufacturer: HuaweiTechnologies Co., Ltd. (SHENZHEN HUNTKEY ELECTRIC CO., LTD.) Model: HW-050100U01
Adapter 2	Manufacturer: HuaweiTechnologies Co., Ltd. (HUIZHOU BYD ELECTRONIC CO., LTD.) Model: HW-050100U01
Adapter 3	Manufacturer: HuaweiTechnologies Co., Ltd. (Dongguan Phitek Electronics Co., Ltd.) Model: HW-050100U01
Battery 1	Manufacturer: HuaweiTechnologies Co., Ltd. (Sunwoda Electronic Co.,LTD) Model: HB405979ECW
Battery 2	Manufacturer: HuaweiTechnologies Co., Ltd. (SCUD (Fujian) Electronics Co., LTD.) Model: HB405979ECW
Battery 3	Manufacturer: HuaweiTechnologies Co., Ltd. (Desay Battery Electronic Co.,LTD) Model: HB405979ECW
Earphone 1	Manufacturer: Jiangxi Lianchuang Hongsheng Electronic Co. ,LTD Model: MEND1532B528A02
Earphone 2	Manufacturer: Boluo County Quancheng Electronic Co.,Ltd. Model: 1293-3283-3.5MM-322
USB Cable 1	Manufacturer: HONGLIN TECHNOLOGY CO.,LTD. Model: 130-26654
USB Cable 2	Manufacturer: Dongguan Ming Ji Electronics Co.,Ltd. Model: 203-0786-0
USB Cable 3	Manufacturer: Luxshare Precision industry Co., Ltd. Model: L99U2013-CS-H
USB Cable 4	Manufacturer: NingBo Broad Telecommunication Co., Ltd. Model: WA0007
<p>Note: 1. The information of the EUT is declared by the manufacturer.</p> <p>2. There are more than one Adapter, Battery, Earphone and USB Cable, each one should be applied throughout the compliance test respectively, however, only the worst case (Adapter 2, Battery 2 and USB Cable 2) will be recorded in this report.</p>	

3 Applied Standards

According to the specifications of the manufacturer, it must comply with the requirements of the following standards:

Test standards

FCC CFR47 Part 2 (2019)

FCC CFR47 Part 27C (2019)

ANSI C63.26 (2015)

KDB 971168 D01 Power Meas License Digital Systems v03r01

4 Test Configuration

There is more than one SIM card slot, each one should be applied throughout the compliance test respectively, and however, only the worst case (SIM 1) will be recorded in this report

Radiated measurements are performed by rotating the EUT in three different orthogonal test planes. EUT stand-up position (Z axis), lie-down position (X, Y axis). Receiver antenna polarization (horizontal and vertical), the worst emission was found in position (X axis, horizontal polarization) and the worst case was recorded.

All mode and data rates and positions and RB size and modulations were investigated. Subsequently, only the worst case emissions are reported.

The following testing in WCDMA/LTE is set based on the maximum RF Output Power.

The following testing in different Bandwidth is set to detail in the following table:

Test modes are chosen to be reported as the worst case configuration below for WCDMA Band IV:

Test items	Modes/Modulation
	WCDMA Band IV
RF power output	RMC HSDPA/HSUPA DC-HSDPA HSPA+
Effective Isotropic Radiated power	RMC
Occupied Bandwidth	RMC
Band Edge Compliance	RMC
Peak-to-Average Power Ratio	RMC
Frequency Stability	RMC
Spurious Emissions at Antenna Terminals	RMC
Radiates Spurious Emission	RMC

Test modes are chosen to be reported as the worst case configuration below for LTE Band 4/7:

Test items	Modes	Bandwidth (MHz)						Modulation		RB			Test Channel		
		1.4	3	5	10	15	20	QPSK	16QAM	1	50%	100%	L	M	H
RF power output	LTE 4	O	O	O	O	O	O	O	O	O	O	O	O	O	O
	LTE 7	-	-	O	O	O	O	O	O	O	O	O	O	O	O
Effective Isotropic Radiated power	LTE 4	O	O	O	O	O	O	O	O	-	-	O	O	O	O
	LTE 7	-	-	O	O	O	O	O	O	-	-	O	O	O	O
Occupied Bandwidth	LTE 4	O	O	O	O	O	O	O	O	-	-	O	O	O	O
	LTE 7	-	-	O	O	O	O	O	O	-	-	O	O	O	O
Band Edge Compliance	LTE 4	O	O	O	O	O	O	O	O	O	-	O	O	-	O
	LTE 7	-	-	O	O	O	O	O	O	O	-	O	O	-	O
Peak-to-Average Power Ratio	LTE 4	O	O	O	O	O	O	O	O	-	-	O	O	O	O
	LTE 7	-	-	O	O	O	O	O	O	-	-	O	O	O	O
Frequency Stability	LTE 4	O	O	O	O	O	O	O	O	O	O	O	O	O	O
	LTE 7	-	-	O	O	O	O	O	O	O	O	O	O	O	O
Spurious Emissions at Antenna Terminals	LTE 4	O	O	O	O	O	O	O	-	O	-	-	O	O	O
	LTE 7	-	-	O	O	O	O	O	-	O	-	-	O	O	O
Radiates Spurious Emission	LTE 4	O	-	O	-	-	O	O	-	O	-	-	O	O	O
	LTE 7	-	-	O	-	-	O	O	-	O	-	-	-	O	-
Note	1. The mark "O" means that this configuration is chosen for testing. 2. The mark "-" means that this configuration is not testing.														

5 Test Case Results

5.1 RF Power Output

Ambient condition

Temperature	Relative humidity	Pressure
23°C ~25°C	45%~50%	101.5kPa

Methods of Measurement

During the process of the testing, The EUT is controlled by the Base Station Simulator to ensure max power transmission and proper modulation.

Test Setup

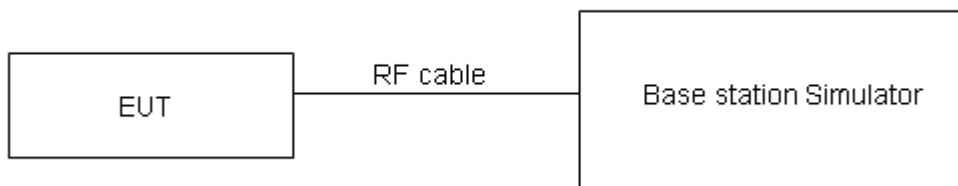

The loss between RF output port of the EUT and the input port of the tester has been taken into consideration.

Limits

No specific RF power output requirements in part 2.1046.

Measurement Uncertainty

The assessed measurement uncertainty to ensure 95% confidence level for the normal distribution is with the coverage factor $k = 2$, $U=0.4$ dB.

Test Results

WCDMA Band IV		AV Conducted Power(dBm)		
		Channel 1312	Channel 1413	Channel 1513
		1712.4 (MHz)	1732.6 (MHz)	1752.6(MHz)
RMC	12.2k	20.42	20.37	20.34
	64k	20.43	20.36	20.31
	144k	20.44	20.38	20.32
	384k	20.41	20.39	20.36
HSDPA	Sub - Test 1	19.88	19.79	19.78
	Sub - Test 2	19.87	19.81	19.75
	Sub - Test 3	19.34	19.31	19.27
	Sub - Test 4	19.35	19.32	19.25
HSUPA	Sub - Test 1	19.84	19.78	19.73
	Sub - Test 2	18.83	18.76	18.72
	Sub - Test 3	19.30	19.24	19.21
	Sub - Test 4	18.76	18.73	18.69
	Sub - Test 5	19.77	19.71	19.67
DC-HSDPA	Sub - Test 1	19.76	19.73	19.68
	Sub - Test 2	19.75	19.72	19.67
	Sub - Test 3	19.33	19.21	19.18
	Sub - Test 4	19.32	19.20	19.17
HSPA+	16QAM	19.31	19.28	19.24

LTE Band 4				AV Conducted Power(dBm)		
Bandwidth	Modulation	RB size	RB offset	Channel/Frequency (MHz)		
				19957/1710.7	20175/1732.5	20393/1754.3
1.4MHz	QPSK	1	0	20.18	20.10	20.11
		1	2	20.37	20.28	20.31
		1	5	19.97	19.94	19.96
		3	0	20.30	20.22	20.24
		3	2	20.21	20.30	20.33
		3	3	20.20	20.18	20.26
		6	0	20.32	20.25	20.24
	16QAM	1	0	20.47	20.38	20.62
		1	2	20.56	20.51	20.48
		1	5	20.10	20.39	20.11
		3	0	20.39	20.12	20.32
		3	2	20.28	20.25	20.20
		3	3	20.23	20.26	20.21
		6	0	20.33	20.23	20.34
Bandwidth	Modulation	RB size	RB offset	Channel/Frequency (MHz)		
				19965/1711.5	20175/1732.5	20385/1753.5
3MHz	QPSK	1	0	20.20	20.14	20.14
		1	7	20.40	20.33	20.35
		1	14	20.00	19.99	20.00
		8	0	20.38	20.32	20.35
		8	4	20.31	20.36	20.43
		8	7	20.28	20.27	20.34
		15	0	20.35	20.29	20.27
	16QAM	1	0	20.50	20.40	20.65
		1	7	20.59	20.56	20.51
		1	14	20.12	20.43	20.14
		8	0	20.48	20.22	20.42
		8	4	20.37	20.36	20.30
		8	7	20.31	20.36	20.32
		15	0	20.36	20.27	20.37
Bandwidth	Modulation	RB size	RB offset	Channel/Frequency (MHz)		
				19975/1712.5	20175/1732.5	20375/1752.5
5MHz	QPSK	1	0	20.17	20.12	20.10
		1	13	20.38	20.29	20.32
		1	24	19.97	19.94	19.96
		12	0	20.35	20.27	20.31
		12	6	20.29	20.34	20.38
		12	13	20.26	20.25	20.30
		25	0	20.33	20.28	20.25



Bandwidth	Modulation	RB size	RB offset	Channel/Frequency (MHz)		
				20000/1715	20175/1732.5	20350/1750
	16QAM	1	0	20.47	20.36	20.62
		1	13	20.56	20.54	20.48
		1	24	20.09	20.41	20.10
		12	0	20.46	20.18	20.39
		12	6	20.34	20.31	20.26
		12	13	20.28	20.31	20.28
		25	0	20.34	20.23	20.32
Bandwidth	Modulation	RB size	RB offset	Channel/Frequency (MHz)		
				20025/1717.5	20175/1732.5	20325/1747.5
10MHz	QPSK	1	0	20.19	20.13	20.13
		1	25	20.41	20.34	20.36
		1	49	19.99	19.98	19.97
		25	0	20.38	20.32	20.35
		25	13	20.32	20.39	20.42
		25	25	20.28	20.29	20.36
		50	0	20.41	20.30	20.29
	16QAM	1	0	20.49	20.39	20.64
		1	25	20.59	20.58	20.51
		1	49	20.12	20.43	20.13
		25	0	20.49	20.23	20.43
		25	13	20.36	20.35	20.29
		25	25	20.31	20.36	20.32
		50	0	20.37	20.28	20.36
Bandwidth	Modulation	RB size	RB offset	Channel/Frequency (MHz)		
				20050/1720	20175/1732.5	20300/1745
15MHz	QPSK	1	0	20.18	20.09	20.11
		1	38	20.39	20.33	20.34
		1	74	19.96	19.93	19.95
		36	0	20.36	20.28	20.32
		36	18	20.29	20.34	20.38
		36	39	20.25	20.26	20.31
		75	0	20.39	20.26	20.24
	16QAM	1	0	20.44	20.37	20.62
		1	38	20.57	20.55	20.49
		1	74	20.09	20.39	20.10
		36	0	20.46	20.21	20.40
		36	18	20.33	20.30	20.25
		36	39	20.29	20.32	20.29
		75	0	20.34	20.23	20.32
Bandwidth	Modulation	RB size	RB offset	Channel/Frequency (MHz)		
				20050/1720	20175/1732.5	20300/1745
20MHz	QPSK	1	0	20.15	20.05	20.08
		1	50	20.38	20.29	20.31



		1	99	19.94	19.92	19.92
		50	0	20.33	20.23	20.28
		50	25	20.27	20.30	20.35
		50	50	20.22	20.21	20.27
		100	0	20.36	20.21	20.20
	16QAM	1	0	20.42	20.33	20.57
		1	50	20.53	20.53	20.45
		1	99	20.07	20.36	20.08
		50	0	20.43	20.17	20.37
		50	25	20.30	20.28	20.22
		50	50	20.26	20.27	20.25
		100	0	20.32	20.19	20.29

LTE Band 7				Conducted Power(dBm)		
Bandwidth	Modulation	RB size	RB offset	Channel/Frequency (MHz)		
				20775/2502.5	21100/2535	21425/2567.5
5MHz	QPSK	1	0	18.40	18.55	18.23
		1	13	18.82	18.97	18.52
		1	24	18.51	18.41	18.26
		12	0	18.58	18.86	18.52
		12	6	18.77	18.91	18.48
		12	13	18.75	18.81	18.46
		25	0	18.65	18.87	18.53
	16QAM	1	0	18.66	18.95	18.42
		1	13	18.90	18.96	18.73
		1	24	18.78	18.94	18.71
		12	0	18.51	18.74	18.53
		12	6	18.69	18.88	18.52
		12	13	18.73	18.84	18.54
		25	0	18.65	18.79	18.49
Bandwidth	Modulation	RB size	RB offset	Channel/Frequency (MHz)		
				20800/2505	21100/2535	21400/2565
10MHz	QPSK	1	0	18.42	18.56	18.26
		1	25	18.85	19.02	18.50
		1	49	18.53	18.44	18.29
		25	0	18.61	18.91	18.56
		25	13	18.80	18.96	18.52
		25	25	18.77	18.85	18.51
		50	0	18.73	18.89	18.57
	16QAM	1	0	18.68	18.98	18.44
		1	25	18.93	19.00	18.76
		1	49	18.81	18.96	18.74



Bandwidth	Modulation	RB size	RB offset	Channel/Frequency (MHz)		
				20825/2507.5	21100/2535	21375/2562.5
		25	0	18.54	18.79	18.57
		25	13	18.71	18.92	18.56
		25	25	18.76	18.89	18.61
		50	0	18.68	18.84	18.53
15MHz	QPSK	1	0	18.41	18.52	18.24
		1	38	18.83	19.01	18.53
		1	74	18.50	18.39	18.25
		36	0	18.59	18.87	18.53
		36	18	18.77	18.91	18.48
		36	39	18.74	18.82	18.47
		75	0	18.71	18.85	18.52
	16QAM	1	0	18.63	18.96	18.42
		1	38	18.91	18.97	18.74
		1	74	18.78	18.92	18.71
		36	0	18.51	18.77	18.54
		36	18	18.68	18.87	18.52
		36	39	18.74	18.85	18.54
		75	0	18.65	18.79	18.49
Bandwidth	Modulation	RB size	RB offset	Channel/Frequency (MHz)		
				20850/2510	21100/2535	21350/2560
20MHz	QPSK	1	0	18.38	18.48	18.21
		1	50	18.82	18.97	18.51
		1	99	18.48	18.38	18.22
		50	0	18.56	18.82	18.49
		50	25	18.75	18.87	18.45
		50	50	18.71	18.77	18.43
		100	0	18.68	18.80	18.48
	16QAM	1	0	18.61	18.92	18.37
		1	50	18.87	18.95	18.70
		1	99	18.76	18.89	18.69
		50	0	18.48	18.73	18.51
		50	25	18.65	18.85	18.49
		50	50	18.71	18.80	18.50
		100	0	18.63	18.75	18.46

5.2 Effective Isotropic Radiated Power

Ambient condition

Temperature	Relative humidity	Pressure
23°C ~25°C	45%~50%	101.5kPa

Methods of Measurement

1. The testing follows FCC KDB 971168 D01 v03r01 Section 5.8 and ANSI C63.26 (2015).
 - a) Connect the equipment as illustrated. Mount the equipment with the manufacturer specified antenna in a vertical orientation on a manufacturer specified mounting surface located on a non-conducting rotating platform of a RF anechoic chamber (preferred) or a standard radiation site.
 - b) Key the transmitter, then rotate the EUT 360° azimuthally and record spectrum analyzer power level (LVL) measurements at angular increments that are sufficiently small to permit resolution of all peaks. If a standard radiation test site is used, raise and lower the test antenna to obtain a maximum reading at each angular increment. (Note: several batteries may be needed to offset the effect of battery voltage droop, which should not exceed 5% of the manufactured specified battery voltage during transmission).
 - c) Replace the transmitter under test with a vertically polarized half-wave dipole (or an antenna whose gain is known relative to an ideal half-wave dipole). The center of the antenna should be at the same location as the center of the antenna under test.
 - d) Connect the antenna to a signal generator with a known output power and record the path loss (in dB) as LOSS. If a standard radiation test site is used, raise and lower the test antenna to obtain a maximum reading. $LOSS = \text{Generator Output Power (dBm)} - \text{Analyzer reading (dBm)}$
 - e) Determine the effective radiated output power at each angular position from the readings in steps b) and d) using the following equation: $ERP \text{ (dBm)} = LVL \text{ (dBm)} + LOSS \text{ (dB)}$
 - f) The maximum ERP is the maximum value determined in the preceding step.
 - g) When calculating ERP, in addition to knowing the antenna radiation and matching characteristics, it is necessary to know the loss values of all elements (e.g. transmission line attenuation, mismatches, filters, combiners) interposed between the point where transmitter output power is measured, and the point where power is applied to the antenna. ERP can then be calculated as follows:
 $EIRP \text{ (dBm)} = \text{Output Power (dBm)} - \text{Losses (dB)} + \text{Antenna Gain (dBi)}$
 where: dBd refers to gain relative to an ideal dipole.
 $EIRP \text{ (dBm)} = ERP \text{ (dBm)} + 2.15 \text{ (dB.)}$

The RB allocation refers to section 5.1, using the maximum output power configuration.

Test setup

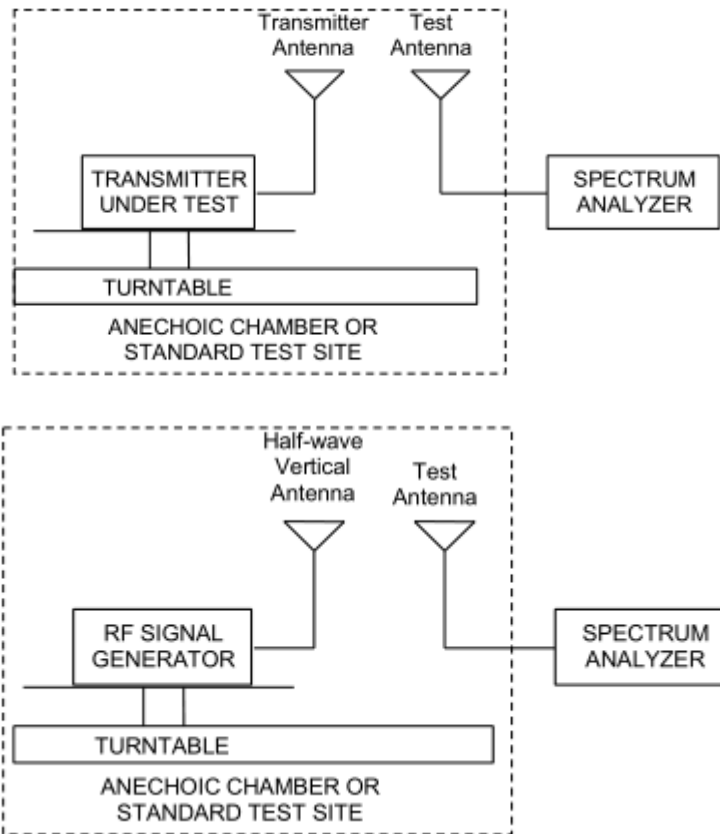

Note: Area side:2.4mX3.6m

**Limits**

Rule Part 27.50(d) (4) specifies that “Fixed, mobile and portable (hand-held) stations operating in the 1710–1755 MHz band are limited to 1 watt EIRP”

Rule Part 27.50(h) (2) specifies that “Mobile and other user stations. Mobile stations are limited to 2.0 watts EIRP. All user stations are limited to 2.0 watts transmitter output power.”

Part 27.50(d)(4)Limit	$\leq 1 \text{ W}$ (30 dBm)
Part 27.50(h)(2) Limit	$\leq 2 \text{ W}$ (33 dBm)

Measurement Uncertainty

The assessed measurement uncertainty to ensure 95% confidence level for the normal distribution is with the coverage factor $k = 2$, $U = 1.19 \text{ dB}$

Test Results

The measurement is performed for both of horizontal and vertical antenna Polarization, and only the data of worst mode is recorded in this report.

Mode	Channel	Frequency (MHz)	Polarization	EIRP (dBm)	Limit (dBm)	Conclusion
WCDMA Band IV	Low	1712.4	Horizontal	21.56	30	Pass
	Mid	1732.6	Horizontal	21.48	30	Pass
	High	1752.6	Horizontal	21.57	30	Pass

LTE Band 4						
Bandwidth	Channel	Frequency (MHz)	Polarization	EIRP (dBm)	Limit (dBm)	Conclusion
1.4 MHz (QPSK)	Low	1710.7	Horizontal	20.55	30	Pass
	Mid	1732.5	Horizontal	20.84	30	Pass
	High	1754.3	Horizontal	20.91	30	Pass
3 MHz (QPSK)	Low	1711.5	Horizontal	21.12	30	Pass
	Mid	1732.5	Horizontal	21.16	30	Pass
	High	1753.5	Horizontal	21.35	30	Pass
5 MHz (QPSK)	Low	1712.5	Horizontal	21.43	30	Pass
	Mid	1732.5	Horizontal	21.36	30	Pass
	High	1752.5	Horizontal	21.41	30	Pass
10 MHz (QPSK)	Low	1715	Horizontal	21.31	30	Pass
	Mid	1732.5	Horizontal	20.98	30	Pass
	High	1750	Horizontal	21.13	30	Pass
15 MHz (QPSK)	Low	1717.5	Horizontal	21.09	30	Pass
	Mid	1732.5	Horizontal	21.12	30	Pass
	High	1747.5	Horizontal	21.32	30	Pass
20 MHz (QPSK)	Low	1720	Horizontal	21.25	30	Pass
	Mid	1732.5	Horizontal	21.16	30	Pass
	High	1745	Horizontal	21.33	30	Pass
1.4 MHz (16QAM)	Low	1710.7	Horizontal	20.09	30	Pass
	Mid	1732.5	Horizontal	20.35	30	Pass
	High	1754.3	Horizontal	20.35	30	Pass
3 MHz (16QAM)	Low	1711.5	Horizontal	20.45	30	Pass
	Mid	1732.5	Horizontal	20.63	30	Pass
	High	1753.5	Horizontal	20.69	30	Pass
5 MHz (16QAM)	Low	1712.5	Horizontal	20.93	30	Pass
	Mid	1732.5	Horizontal	20.87	30	Pass
	High	1752.5	Horizontal	20.95	30	Pass
10 MHz (16QAM)	Low	1715	Horizontal	20.90	30	Pass
	Mid	1732.5	Horizontal	20.28	30	Pass
	High	1750	Horizontal	20.70	30	Pass



15 MHz (16QAM)	Low	1717.5	Horizontal	20.47	30	Pass
	Mid	1732.5	Horizontal	20.64	30	Pass
	High	1747.5	Horizontal	20.59	30	Pass
20 MHz (16QAM)	Low	1720	Horizontal	20.76	30	Pass
	Mid	1732.5	Horizontal	20.58	30	Pass
	High	1745	Horizontal	20.80	30	Pass

LTE Band 7						
Band width	Channel	Frequency (MHz)	Polarization	EIRP (dBm)	Limit (dBm)	Conclusion
5 MHz (QPSK)	Low	2502.5	Horizontal	19.42	33	Pass
	Mid	2535	Horizontal	19.89	33	Pass
	High	2567.5	Horizontal	19.88	33	Pass
10 MHz (QPSK)	Low	2505	Horizontal	20.12	33	Pass
	Mid	2535	Horizontal	19.99	33	Pass
	High	2565	Horizontal	20.23	33	Pass
15 MHz (QPSK)	Low	2507.5	Horizontal	19.67	33	Pass
	Mid	2535	Horizontal	19.82	33	Pass
	High	2562.5	Horizontal	19.87	33	Pass
20 MHz (QPSK)	Low	2510	Horizontal	19.34	33	Pass
	Mid	2535	Horizontal	19.76	33	Pass
	High	2560	Horizontal	20.40	33	Pass
5 MHz (16QAM)	Low	2502.5	Horizontal	18.75	33	Pass
	Mid	2535	Horizontal	19.36	33	Pass
	High	2567.5	Horizontal	19.22	33	Pass
10 MHz (16QAM)	Low	2505	Horizontal	19.62	33	Pass
	Mid	2535	Horizontal	19.50	33	Pass
	High	2565	Horizontal	19.77	33	Pass
15 MHz (16QAM)	Low	2507.5	Horizontal	19.26	33	Pass
	Mid	2535	Horizontal	19.12	33	Pass
	High	2562.5	Horizontal	19.44	33	Pass
20 MHz (16QAM)	Low	2510	Horizontal	18.72	33	Pass
	Mid	2535	Horizontal	19.28	33	Pass
	High	2560	Horizontal	19.67	33	Pass

5.3 Occupied Bandwidth

Ambient condition

Temperature	Relative humidity	Pressure
23°C ~25°C	45%~50%	101.5kPa

Method of Measurement

The EUT was connected to Spectrum Analyzer and Base Station Simulator via power Splitter. The occupied bandwidth is measured using spectrum analyzer.

RBW is set to 51 kHz, VBW is set to 160 kHz for WCDMA Band IV.

RBW is set to 51 kHz, VBW is set to 160 kHz for LTE Band 4 (1.4MHz).

RBW is set to 100 kHz, VBW is set to 300 kHz for LTE Band 4 (3MHz).

RBW is set to 100 kHz, VBW is set to 300 kHz for LTE Band 4/7 (5MHz).

RBW is set to 300 kHz, VBW is set to 1MHz for LTE Band 4/7 (10MHz).

RBW is set to 300 kHz, VBW is set to 1MHz for LTE Band 4/7 (15MHz/20MHz).

99% power and -26dBc occupied bandwidths are recorded. Spectrum analyzer plots are included on the following pages.

Test Setup

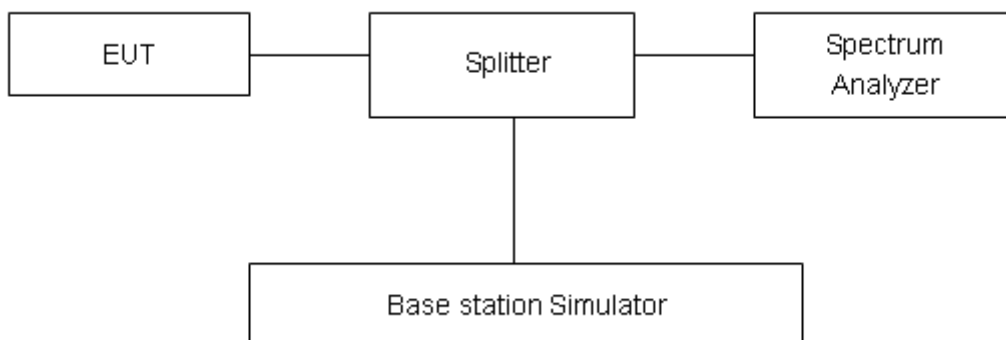

Limits

No specific occupied bandwidth requirements in part 2.1049.

Measurement Uncertainty

The assessed measurement uncertainty to ensure 95% confidence level for the normal distribution is with the coverage factor $k = 2$, $U=624\text{Hz}$.

Test Result

Mode	Channel	Frequency (MHz)	99% Power Bandwidth(MHz)	-26dBc Bandwidth(MHz)
WCDMA Band IV (RMC)	1312	1712.4	4.1615	4.671
	1413	1732.6	4.1603	4.655
	1513	1752.6	4.1718	4.706

LTE Band 4						
RB	Modulation	Bandwidth (MHz)	Channel	Frequency (MHz)	99% Power Bandwidth(MHz)	-26dBc Bandwidth(MHz)
100%	QPSK	1.4	19957	1710.7	1.1130	1.340
			20175	1732.5	1.1183	1.343
			20393	1754.3	1.1326	1.327
		3	19965	1711.5	2.7275	3.004
			20175	1732.5	2.7352	2.982
			20385	1753.5	2.7305	3.004
		5	19975	1712.5	4.5153	4.955
			20175	1732.5	4.5069	4.957
			20375	1752.5	4.4962	4.906
		10	20000	1715	9.0278	10.000
			20175	1732.5	9.0264	9.934
			20350	1750	9.0647	9.904
		15	20025	1717.5	13.4960	14.620
			20175	1732.5	13.4750	14.660
			20325	1747.5	13.4680	14.580
		20	20050	1720	17.8760	19.080
			20175	1732.5	17.9450	19.090
			20300	1745	17.9220	19.300
	16QAM	1.4	19957	1710.7	1.1203	1.319
			20175	1732.5	1.1139	1.321
			20393	1754.3	1.1181	1.336
		3	19965	1711.5	2.7206	3.017
			20175	1732.5	2.7237	3.000
			20385	1753.5	2.7181	3.004
5		19975	1712.5	4.4938	4.924	
		20175	1732.5	4.5147	4.953	
		20375	1752.5	4.5086	4.933	
10		20000	1715	9.0297	9.865	
		20175	1732.5	9.0272	9.901	



		20350	1750	9.0315	9.887
	15	20025	1717.5	13.4820	14.670
		20175	1732.5	13.4800	14.670
		20325	1747.5	13.4650	14.540
	20	20050	1720	17.9660	19.180
		20175	1732.5	17.9650	19.510
		20300	1745	17.8550	19.260

LTE Band 7						
RB	Modulation	Bandwidth (MHz)	Channel	Frequency (MHz)	99% Power Bandwidth(MHz)	-26dBc Bandwidth(MHz)
100%	QPSK	5	20775	2502.5	4.5140	4.946
			21100	2535	4.5155	4.915
			21425	2567.5	4.5093	4.948
		10	20800	2505	9.0409	9.986
			21100	2535	9.0081	9.941
			21400	2565	9.0324	9.899
		15	20825	2507.5	13.4590	14.540
			21100	2535	13.4550	14.560
			21375	2562.5	13.4920	14.790
		20	20850	2510	17.9140	19.160
			21100	2535	17.8970	19.200
			21350	2560	17.9330	19.240
	16QAM	5	20775	2502.5	4.4946	4.903
			21100	2535	4.5157	4.955
			21425	2567.5	4.5204	4.936
		10	20800	2505	9.0297	9.896
			21100	2535	9.0177	9.888
			21400	2565	9.0316	9.927
		15	20825	2507.5	13.4670	14.690
			21100	2535	13.4950	14.610
			21375	2562.5	13.4950	14.650
		20	20850	2510	17.8970	19.150
			21100	2535	17.9310	19.240
			21350	2560	17.9040	19.200

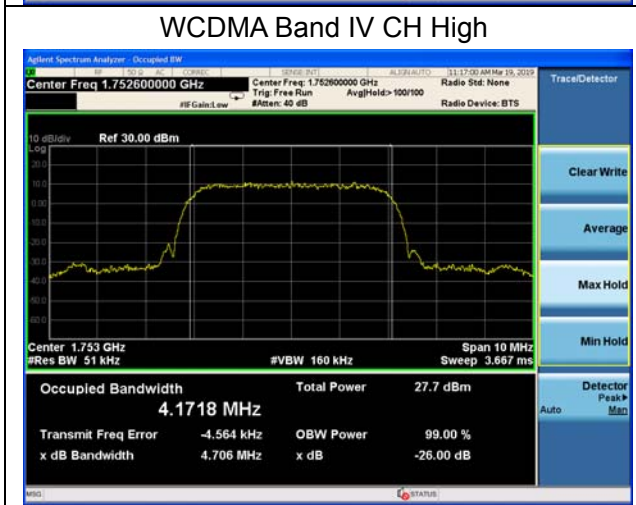
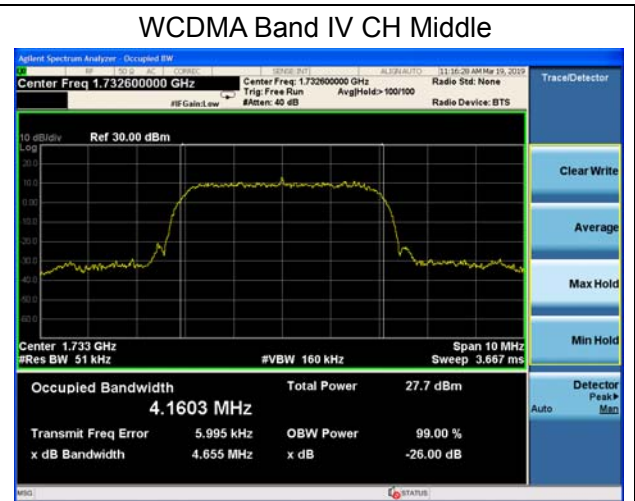
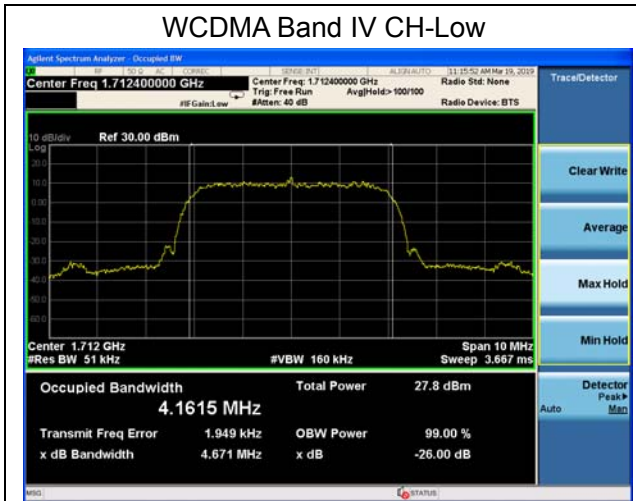

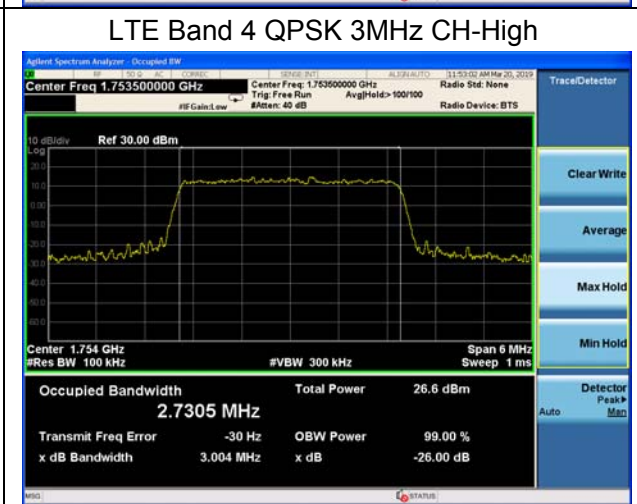
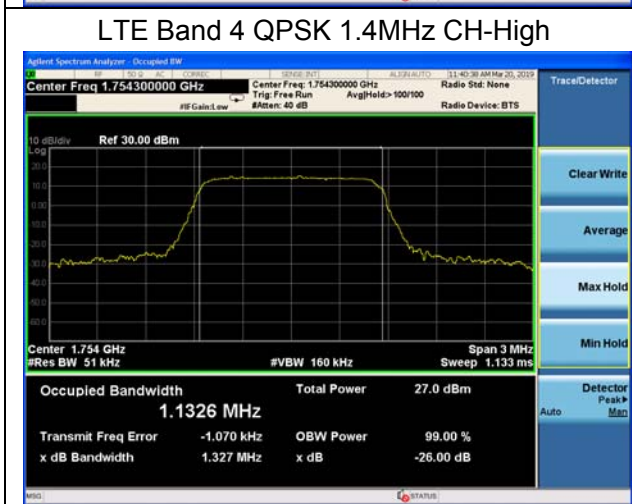
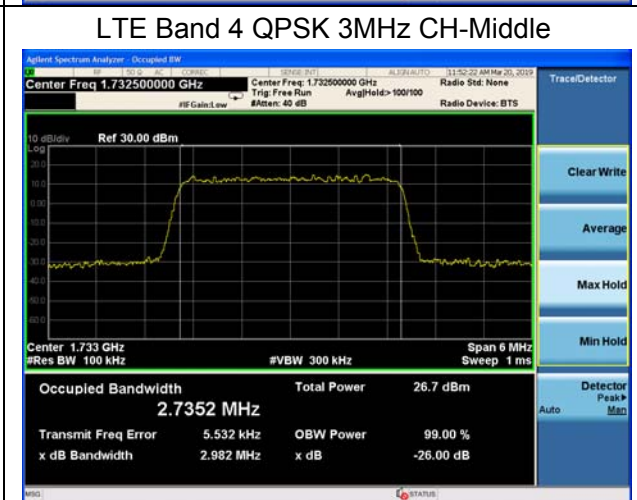
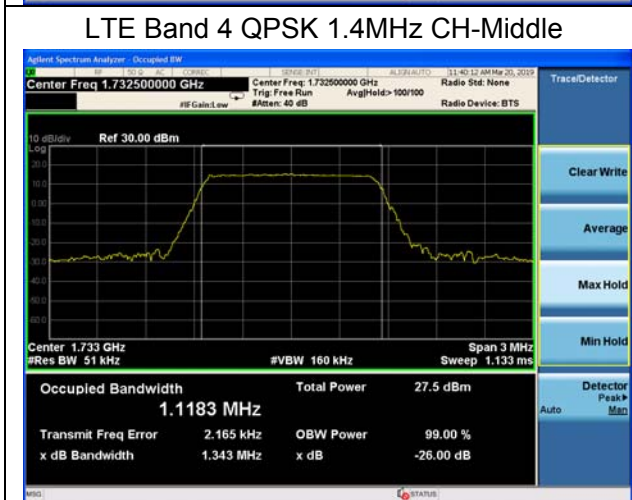
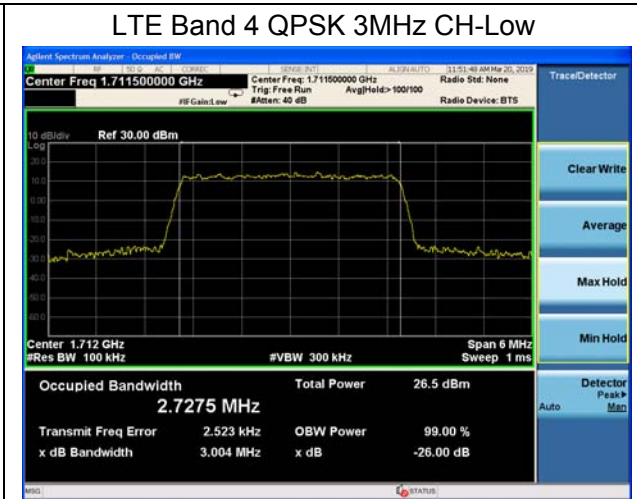
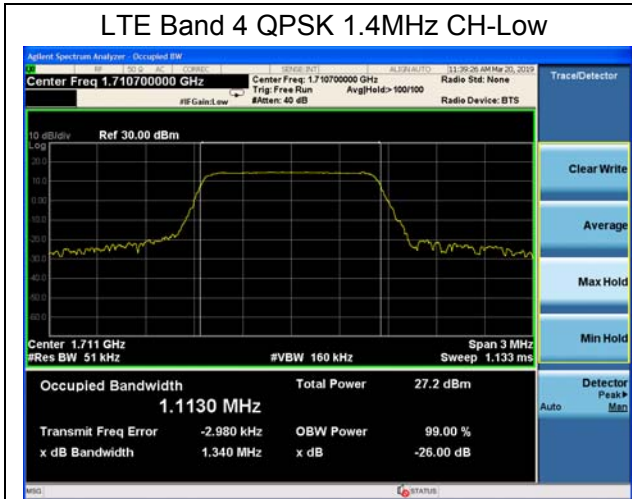

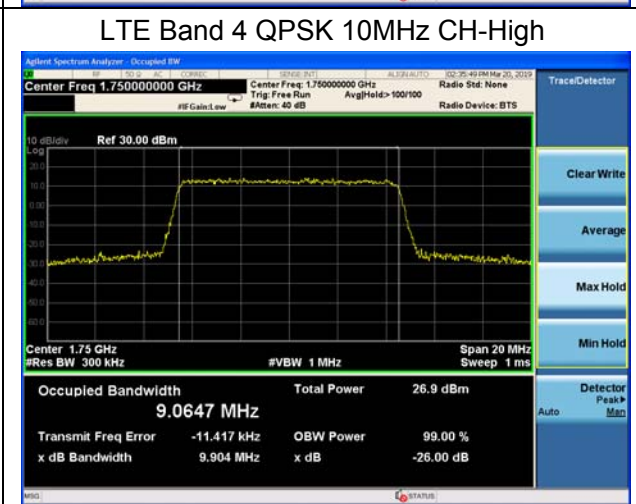
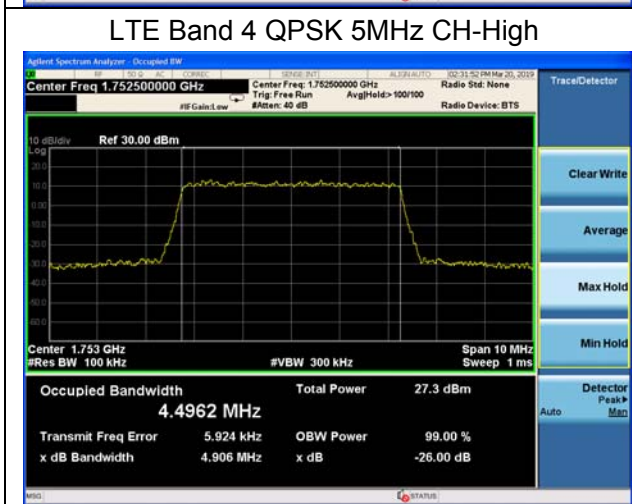
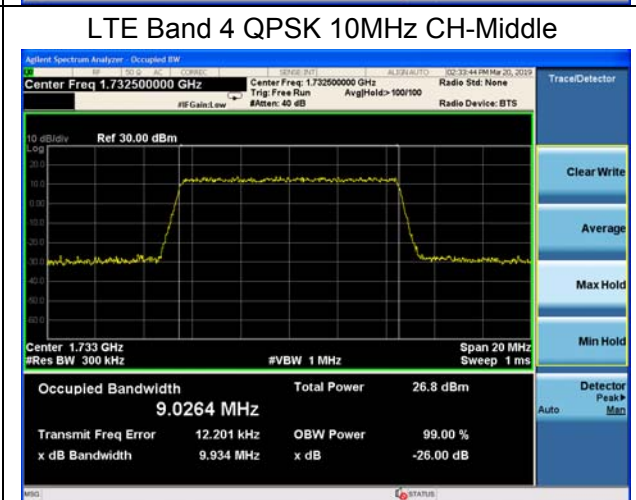
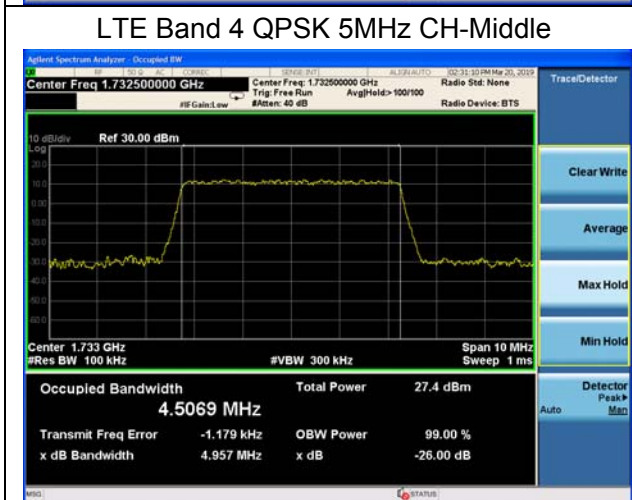
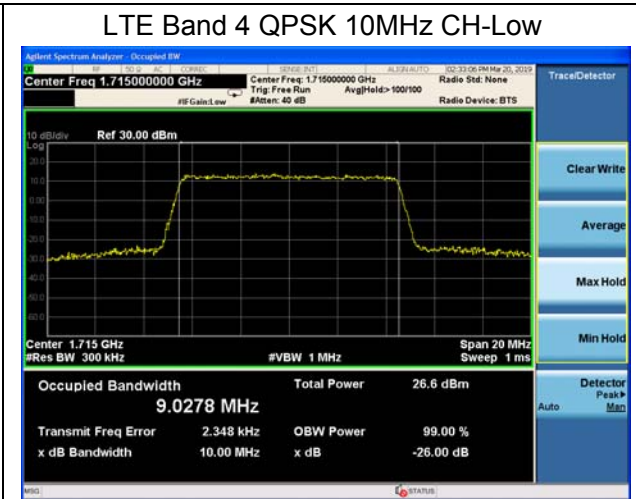
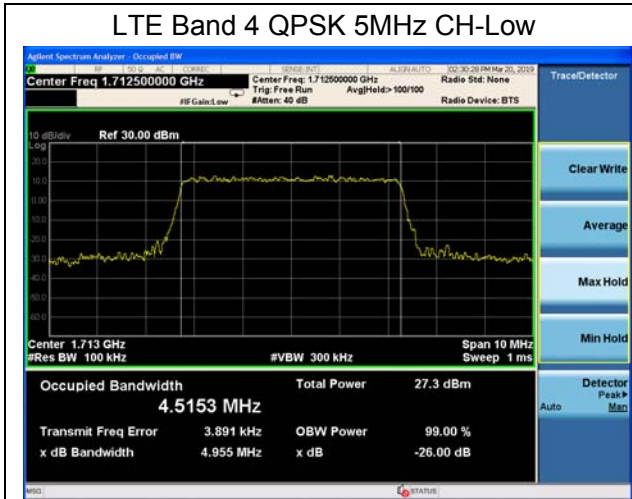

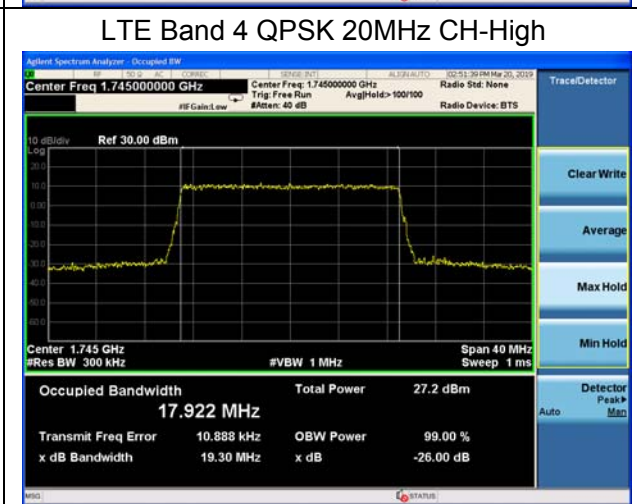
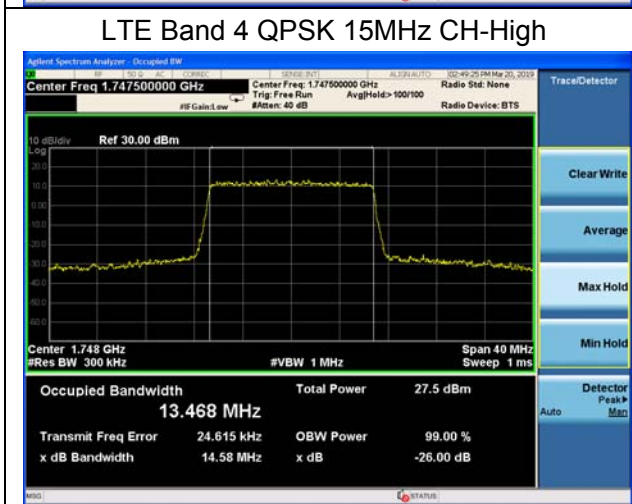
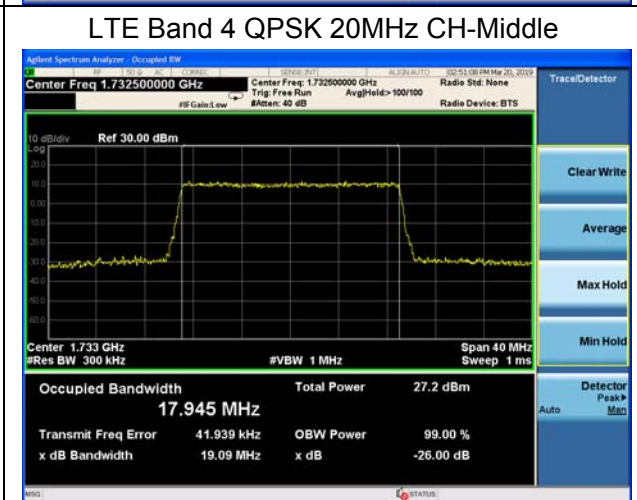
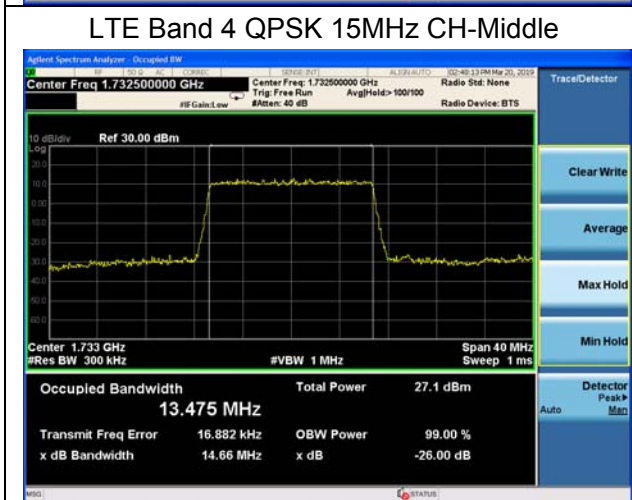
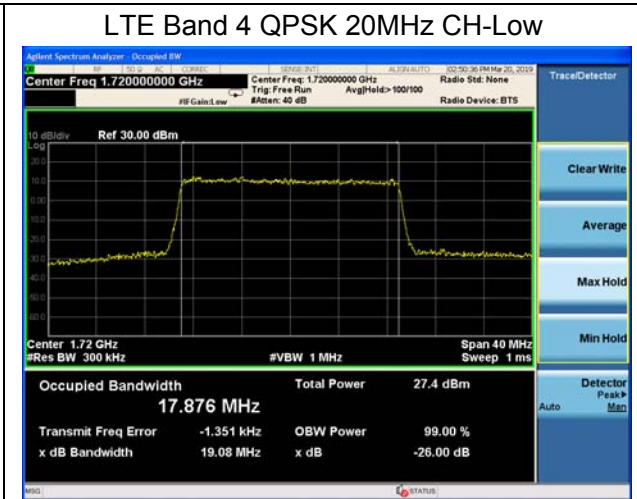
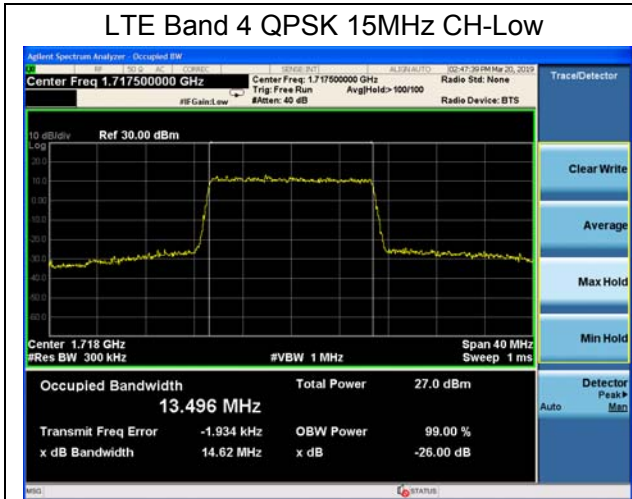

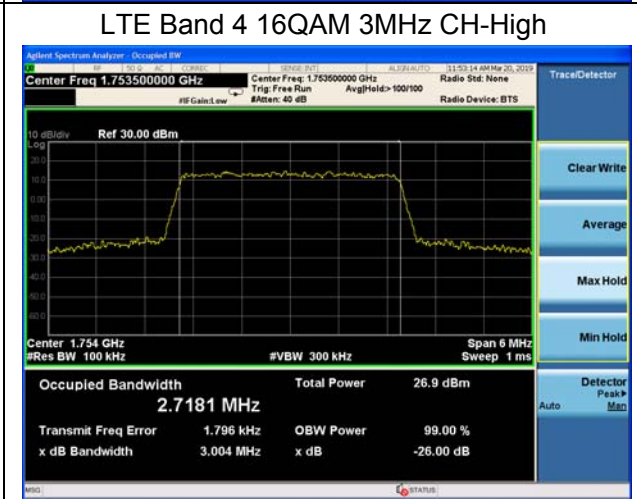
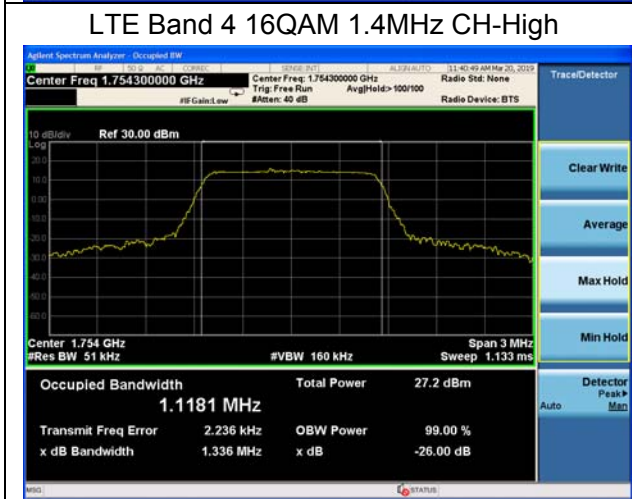
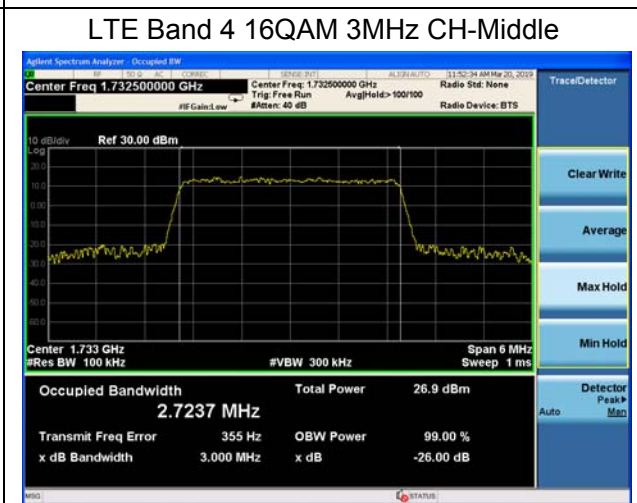
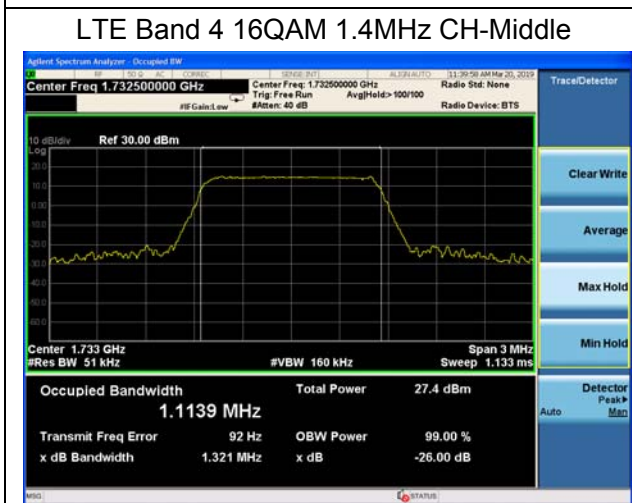
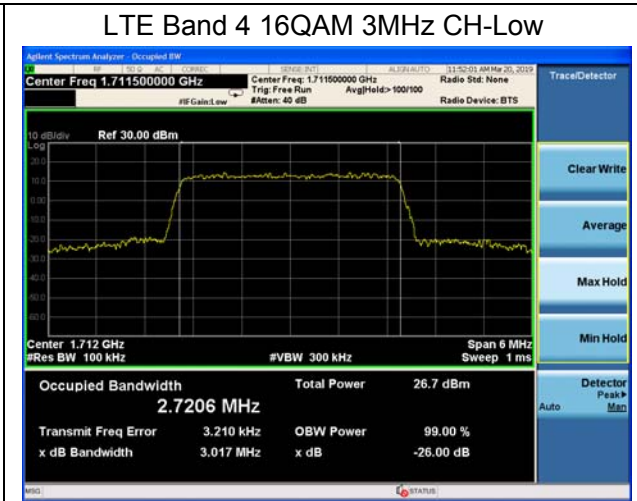
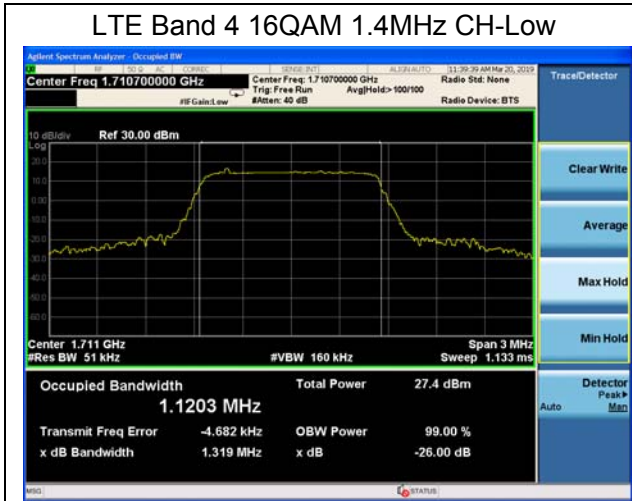

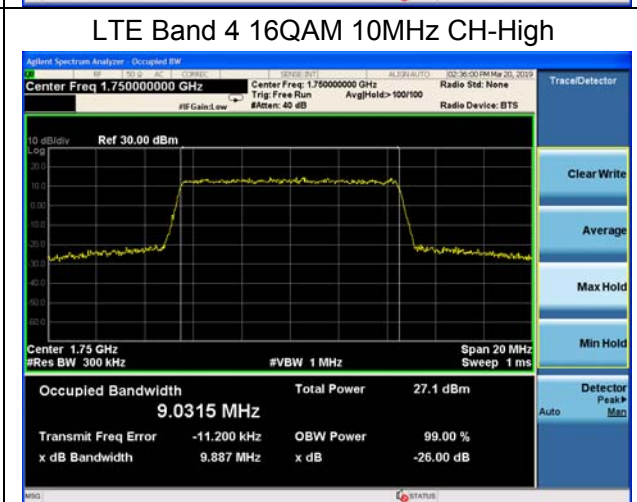
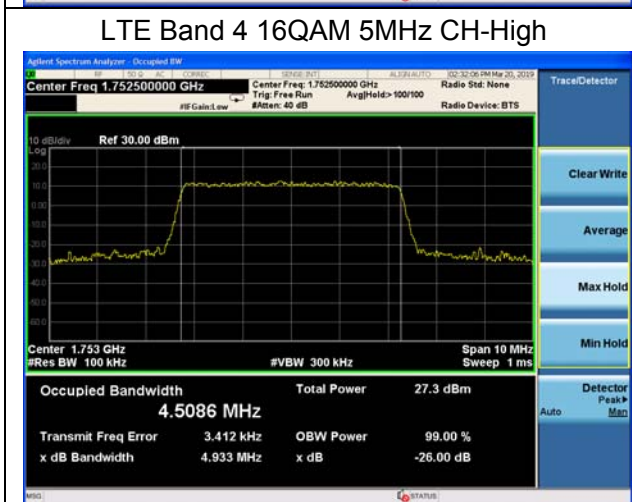
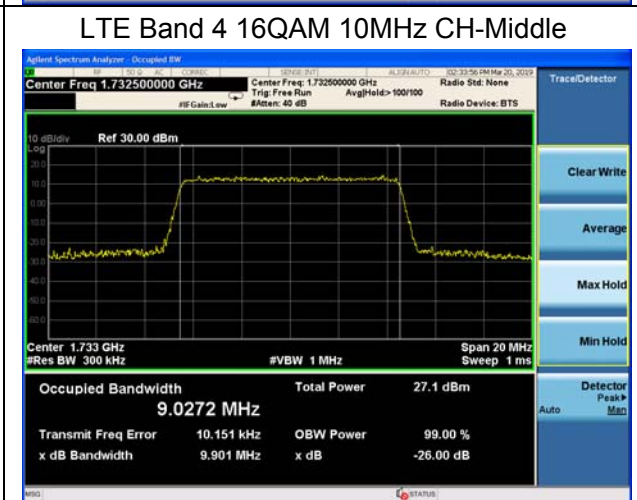
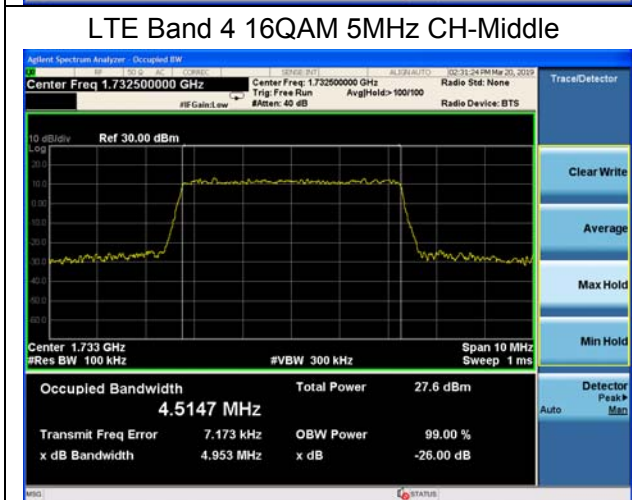
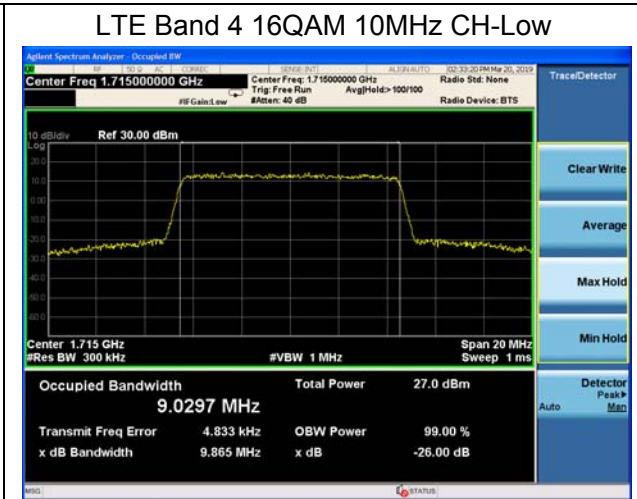
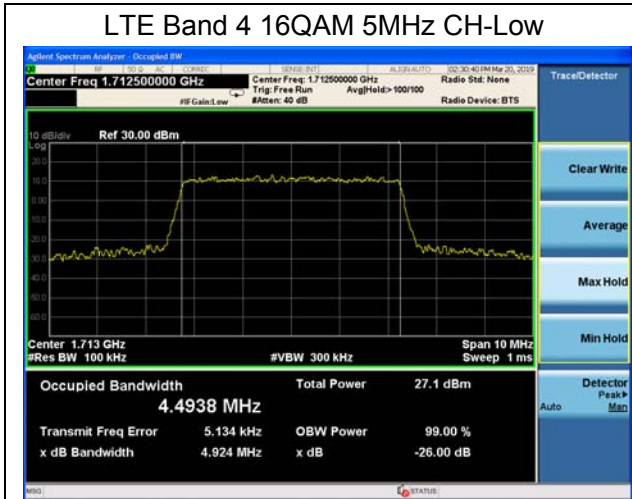

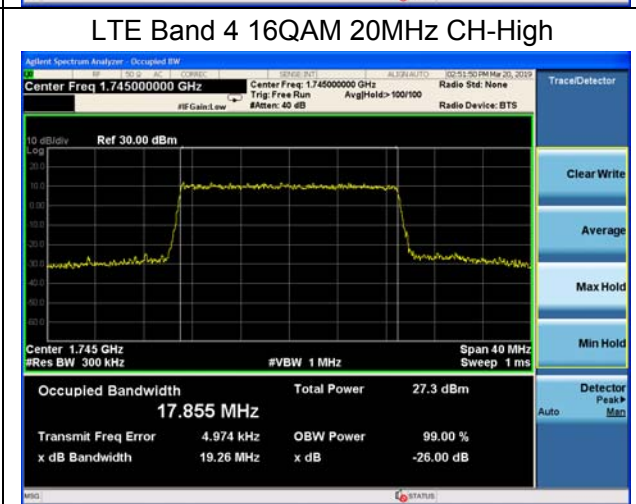
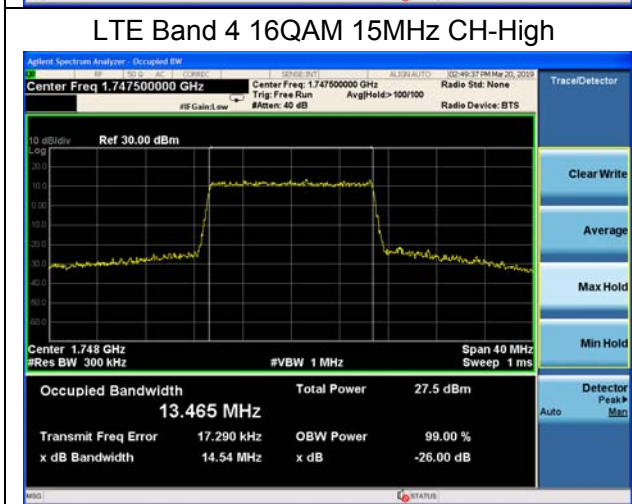
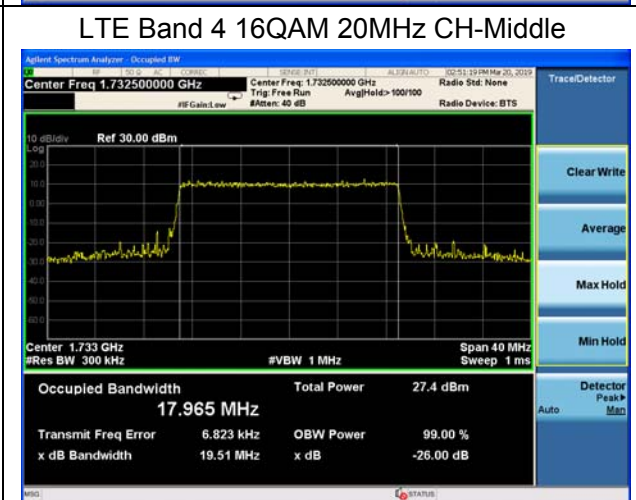
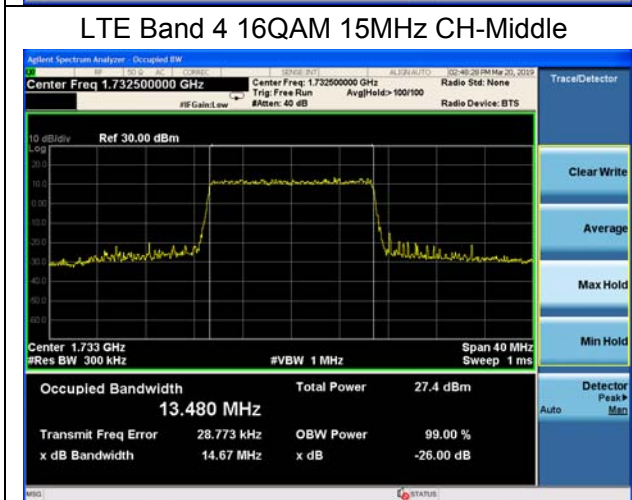
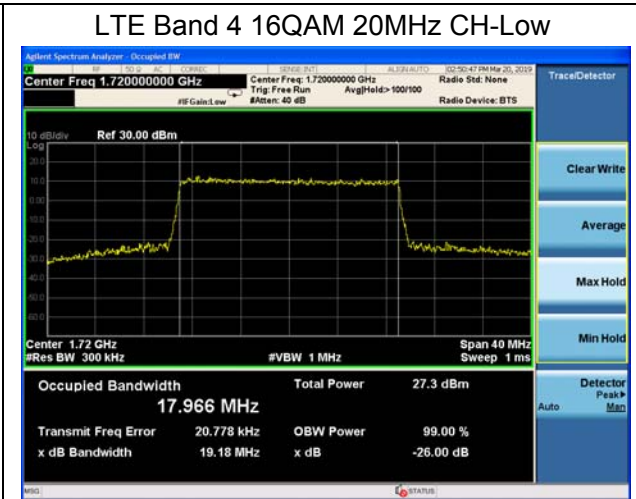
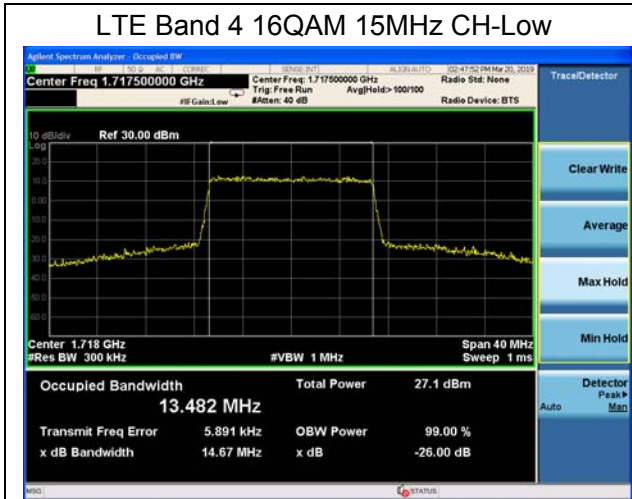

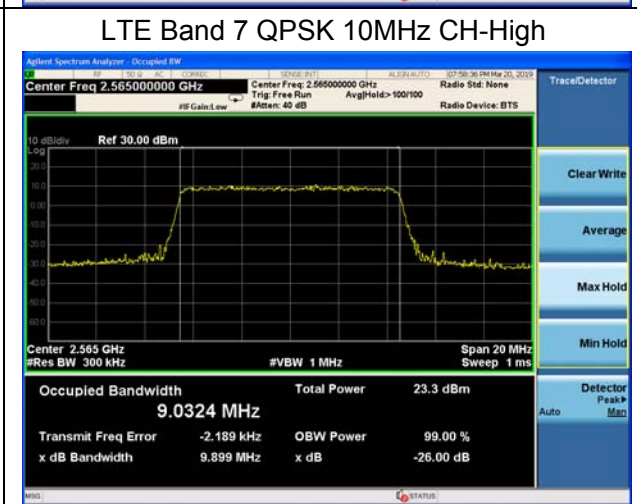
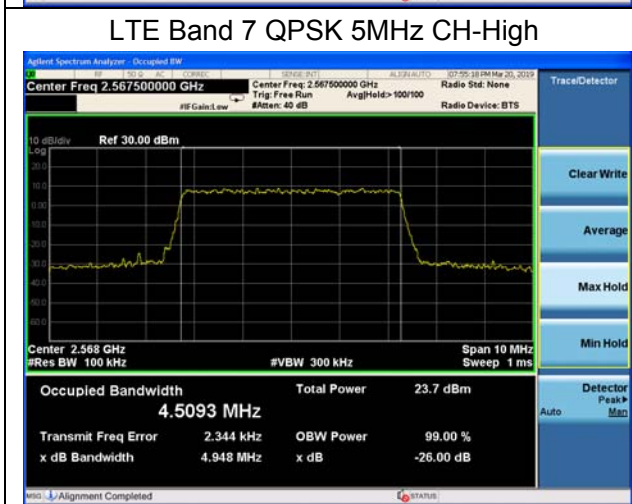
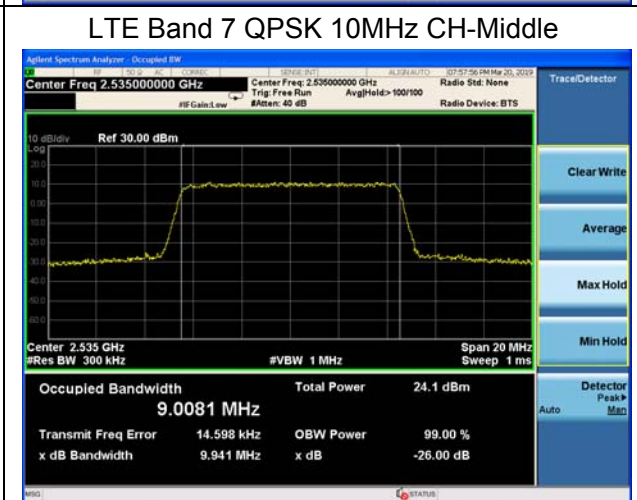
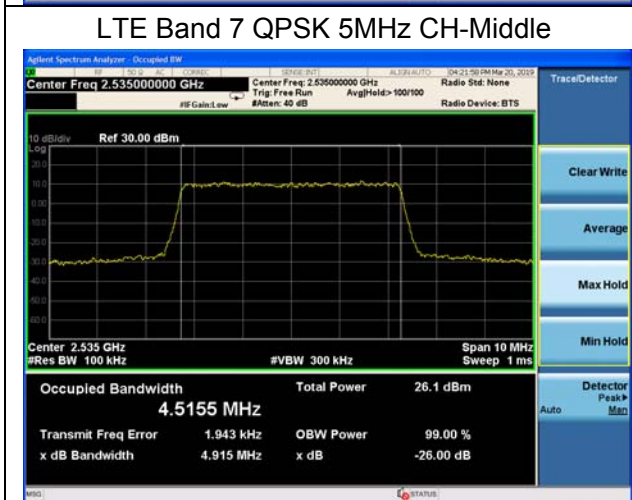
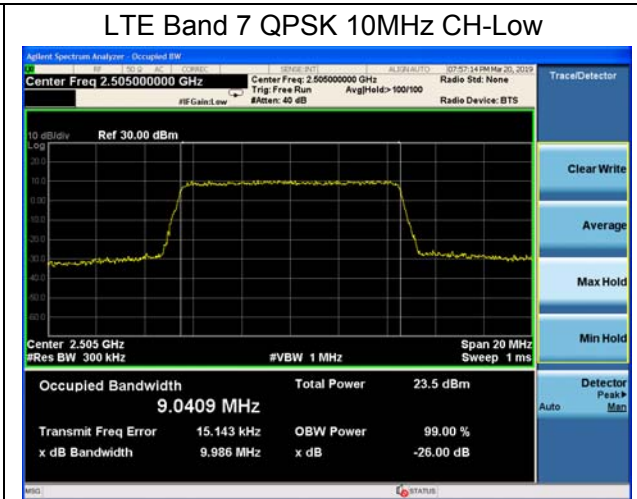
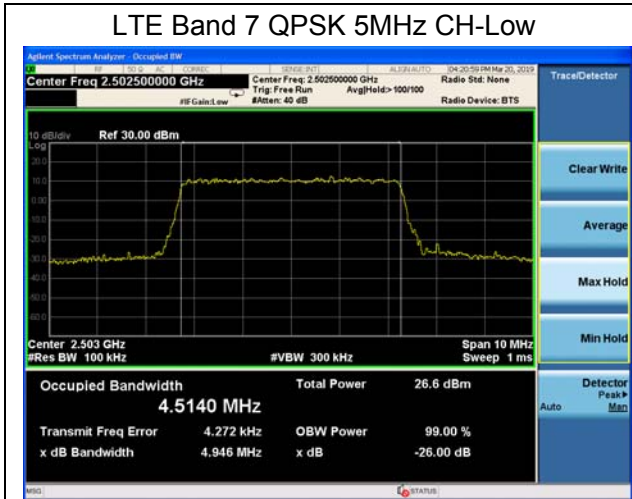

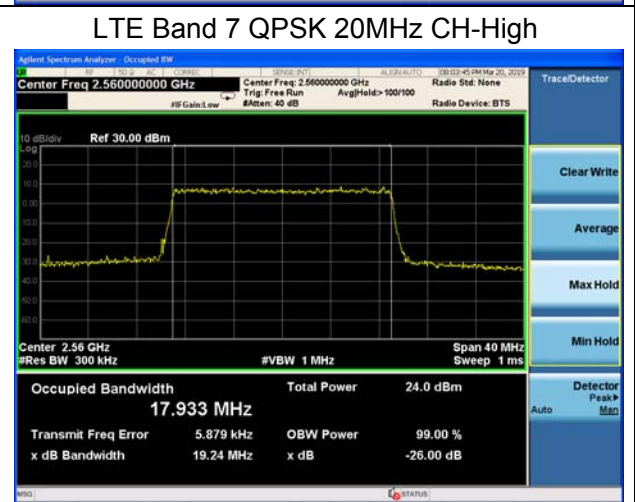
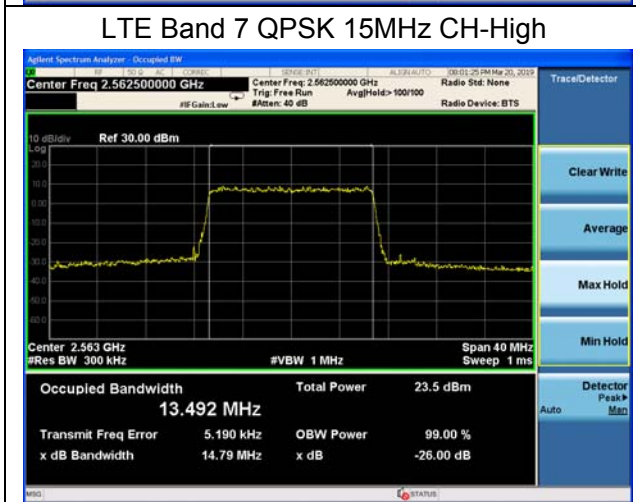
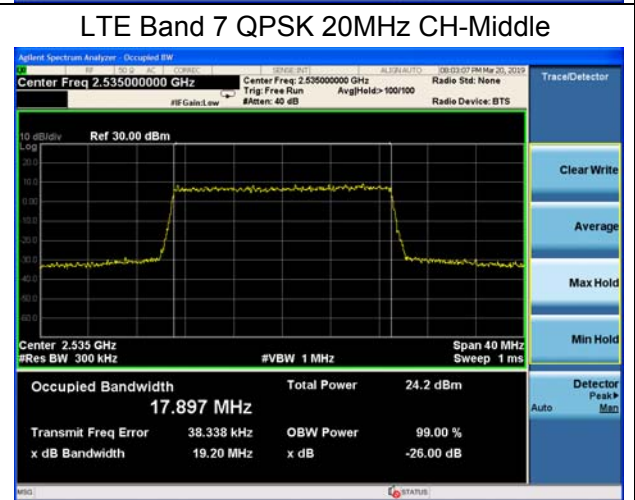
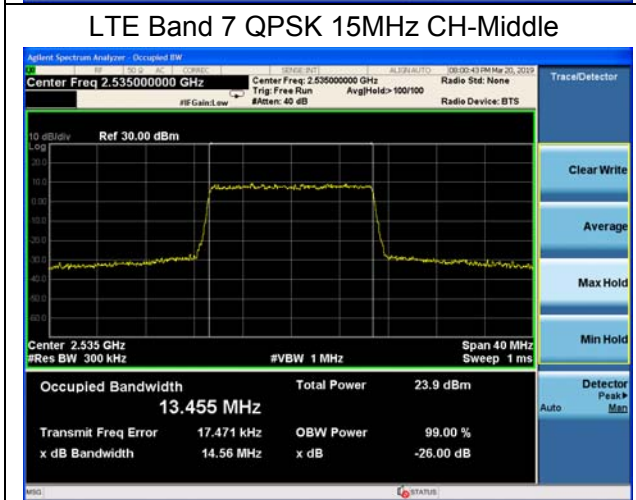
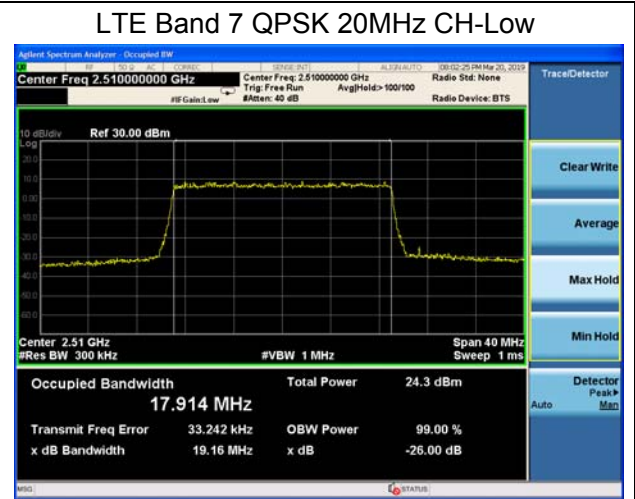
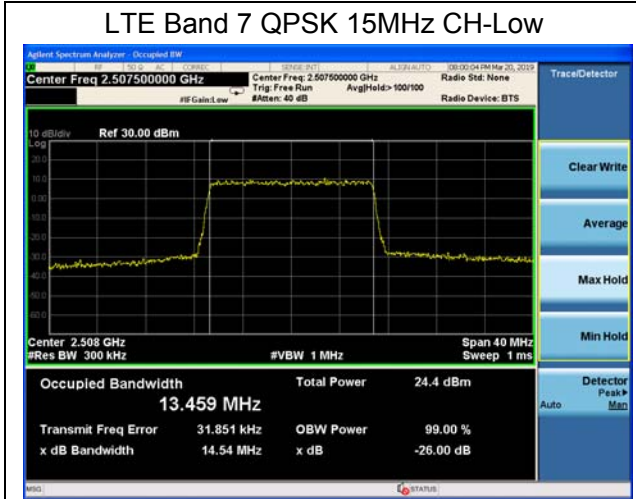

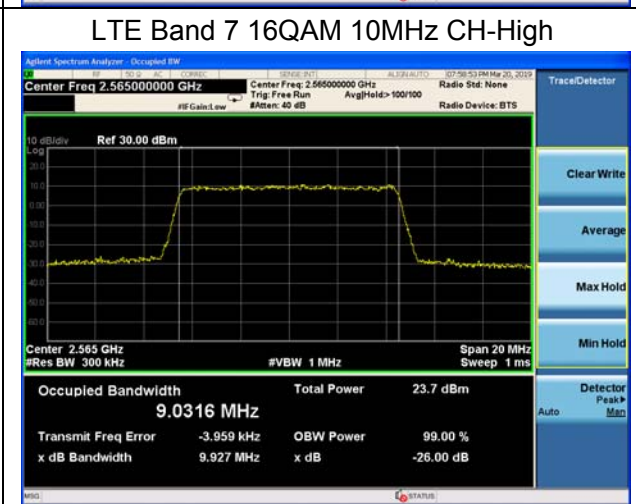
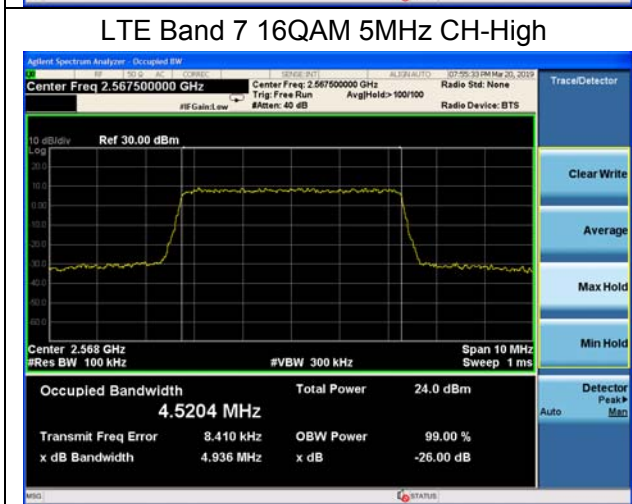
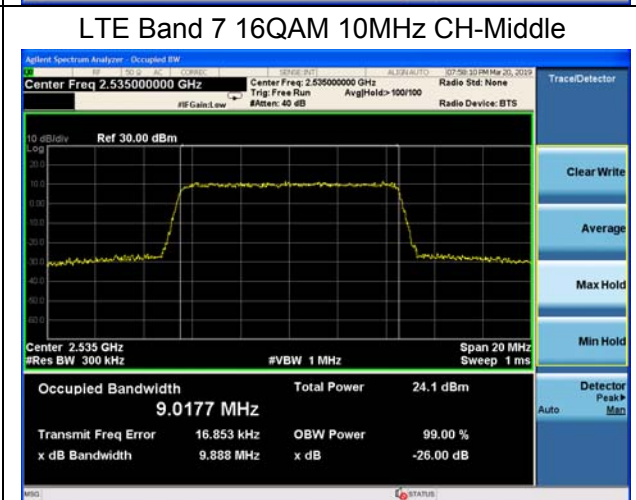
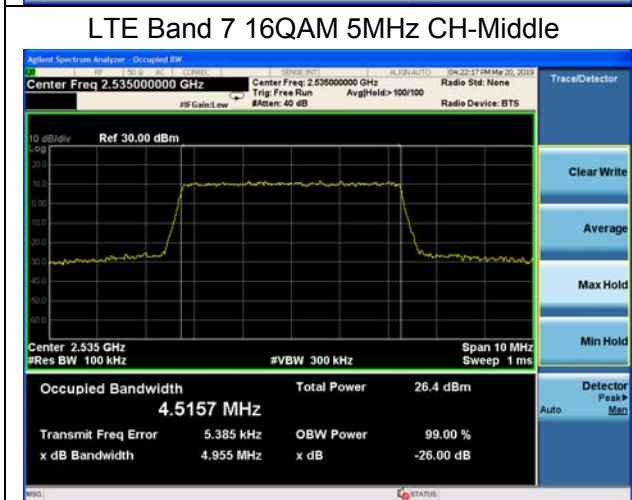
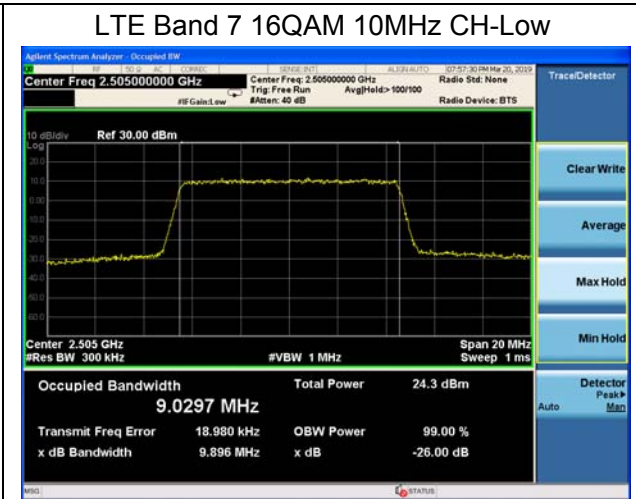
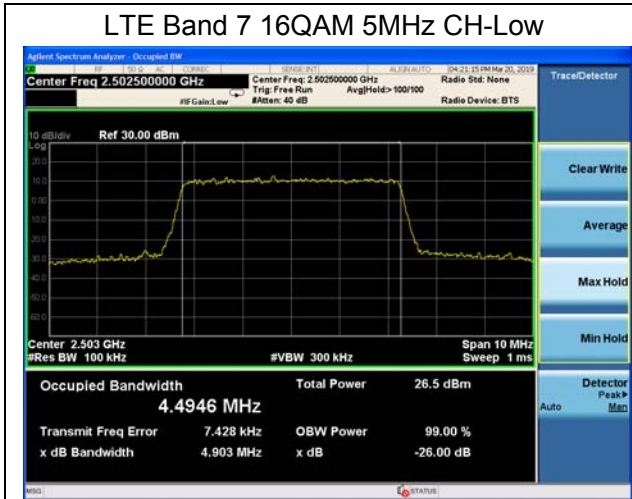

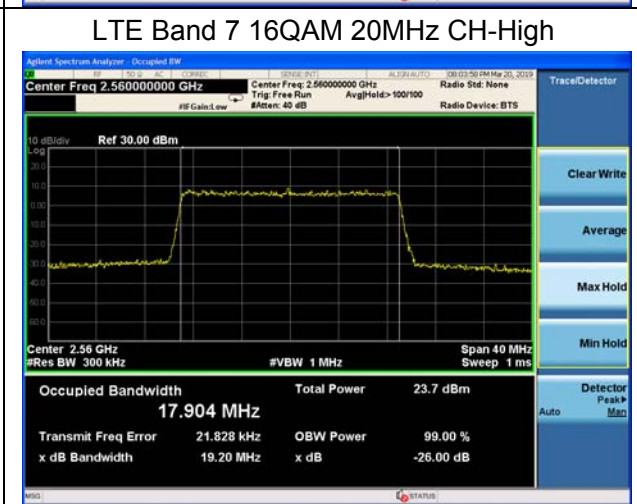
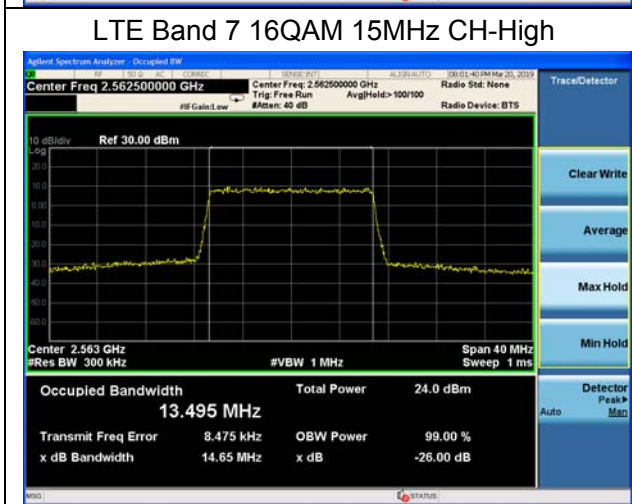
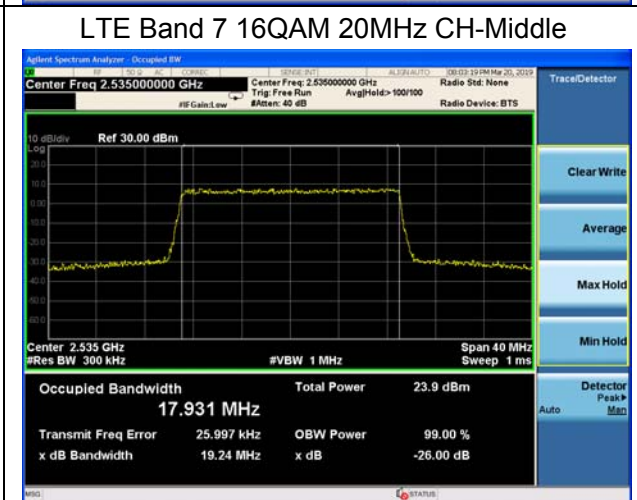
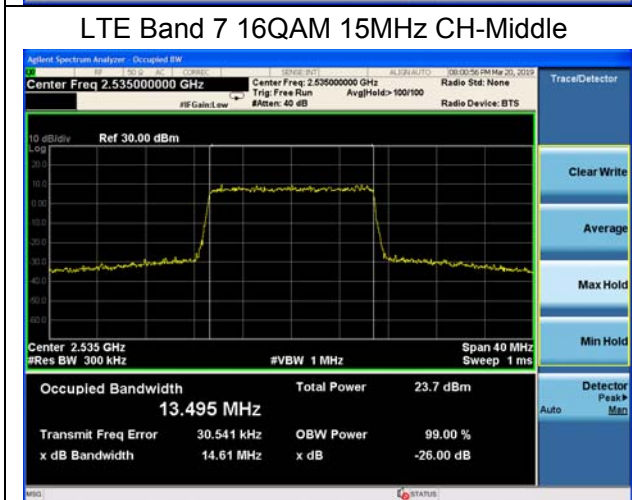
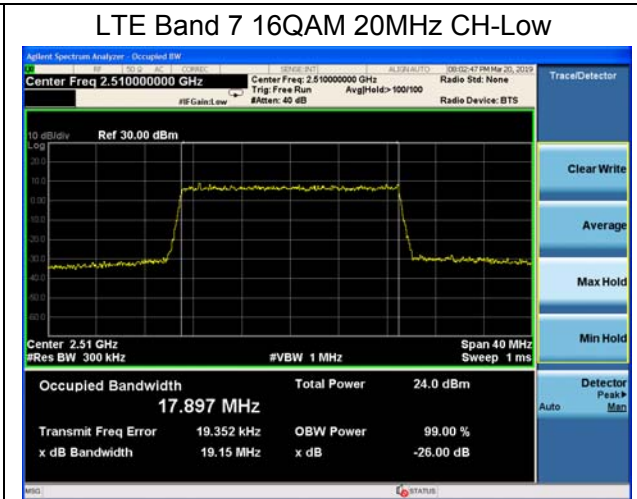
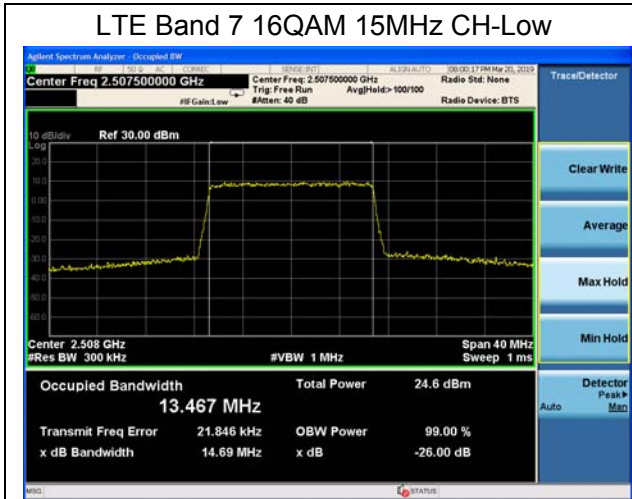

5.4 Band Edge Compliance

Ambient condition

Temperature	Relative humidity	Pressure
23°C ~25°C	45%~50%	101.5kPa

Method of Measurement

The EUT was connected to Spectrum Analyzer and Base Station Simulator via power Splitter. The band edge of the lowest and highest channels were measured.

The testing follows KDB 971168 D01 v03r01 Section 6.0

- 1.The EUT was connected to spectrum analyzer and system simulator via a power divider.
2. The band edges of low and high channels for the highest RF powers were measured.
3. RBW is set to 51 kHz, VBW is set to 160kHz for WCDMA Band IV.
 RBW is set to 15 kHz, VBW is set to 51 kHz for LTE Band 4 (1.4MHz).
 RBW is set to 30 kHz, VBW is set to 100 kHz for LTE Band 4 (3MHz).
 RBW is set to 51 kHz, VBW is set to 160kHz for LTE Band 4 (5MHz).
 RBW is set to 100 kHz, VBW is set to 300 kHz for LTE Band 4 (10MHz).
 RBW is set to 150 kHz, VBW is set to 510 kHz for LTE Band 4 (15MHz).
 RBW is set to 200 kHz, VBW is set to 620 kHz for LTE Band 4 (20MHz).
 RBW is set to 50 kHz, VBW is set to 200kHz for LTE Band 7 (5MHz).
 RBW is set to 100 kHz, VBW is set to 300 kHz for LTE Band 7 (10MHz).
 RBW is set to 200 kHz, VBW is set to 1 MHz for LTE Band 7 (15MHz/20MHz)on spectrum analyzer.
4. Set spectrum analyzer with RMS detector.
5. The RF fundamental frequency should be excluded against the limit line in the operating frequency band.
6. Checked that all the results comply with the emission limit line.

Test Setup

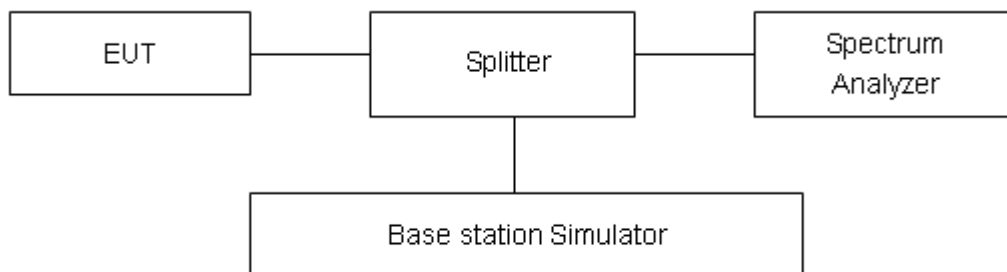

Limits

Rule Part 27.53(h) specifies that “ for operations in the 1695-1710 MHz, 1710-1755 MHz, 1755-1780



MHz, 1915-1920 MHz, 1995-2000 MHz, 2000-2020 MHz, 2110-2155 MHz, 2155-2180 MHz, and 2180-2200 bands, the power of any emission outside a licensee's frequency block shall be attenuated below the transmitter power (P) in watts by at least $43 + 10 \log_{10}(P)$ dB"

Rule Part 27.53(m) (4) specifies that "for BRS and EBS stations. For mobile digital stations, the attenuation factor shall be not less than $40 + 10 \log(P)$ dB on all frequencies between the channel edge and 5 megahertz from the channel edge, $43 + 10 \log(P)$ dB on all frequencies between 5 megahertz and X megahertz from the channel edge, and $55 + 10 \log(P)$ dB on all frequencies more than X megahertz from the channel edge, where X is the greater of 6 megahertz or the actual emission bandwidth as defined in paragraph (m)(4) of this section. In addition, the attenuation factor shall not be less that $43 + 10 \log(P)$ dB on all frequencies between 2490.5 MHz and 2496 MHz and $55 + 10 \log(P)$ dB at or below 2490.5 MHz. Mobile Satellite Service licensees operating on frequencies below 2495 MHz may also submit a documented interference complaint against BRS licensees operating on channel BRS Channel 1 on the same terms and conditions as adjacent channel BRS or EBS licensees.

Example:

The limit line is derived from $43 + 10 \log(P)$ dB below the transmitter power P(Watts)
= P(W)- $[43 + 10 \log(P)]$ (dB)
= $[30 + 10 \log(P)]$ (dBm) - $[43 + 10 \log(P)]$ (dB) = -13dBm.

Measurement Uncertainty

The assessed measurement uncertainty to ensure 95% confidence level for the normal distribution is with the coverage factor $k = 1.96$, $U=0.684$ dB.

Test Result

All the test traces in the plots shows the test results clearly.



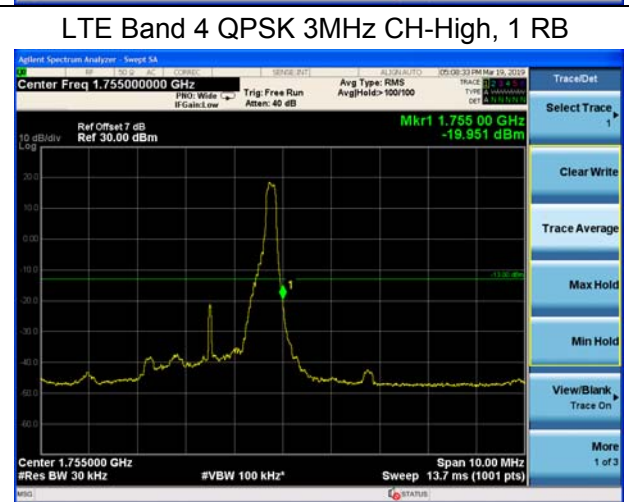
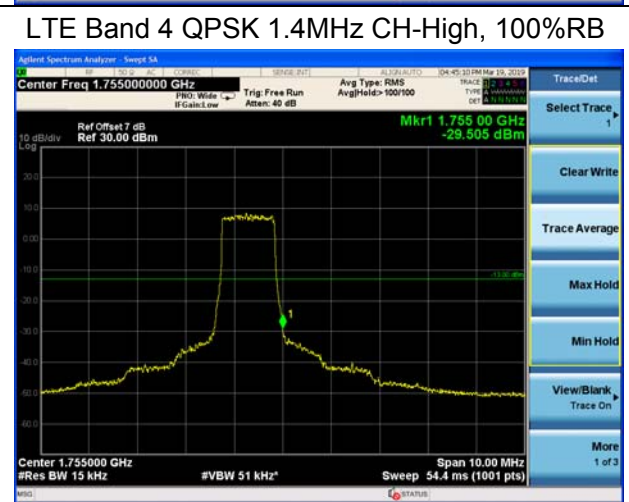
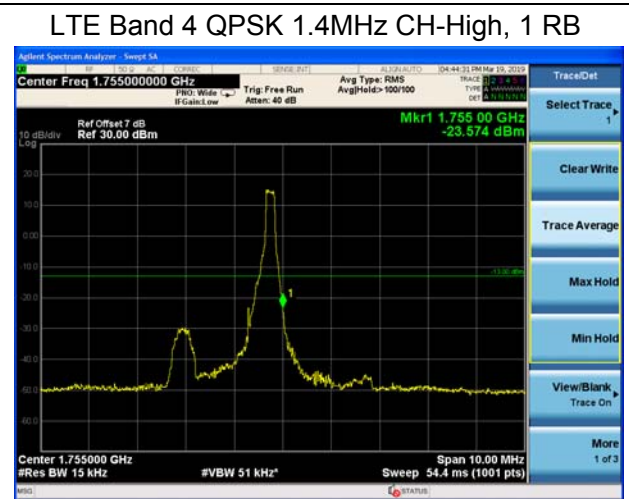
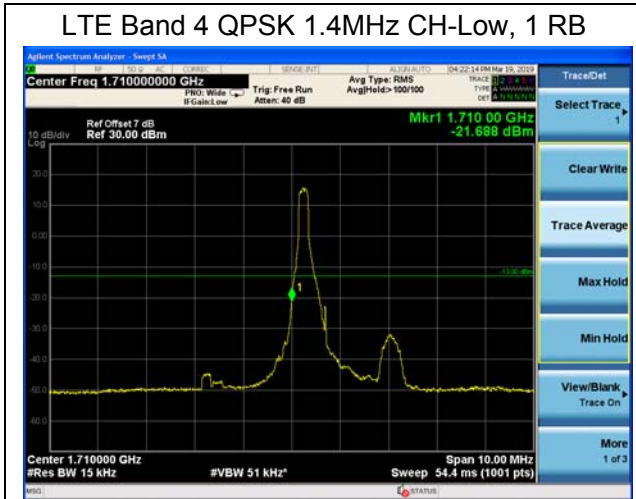

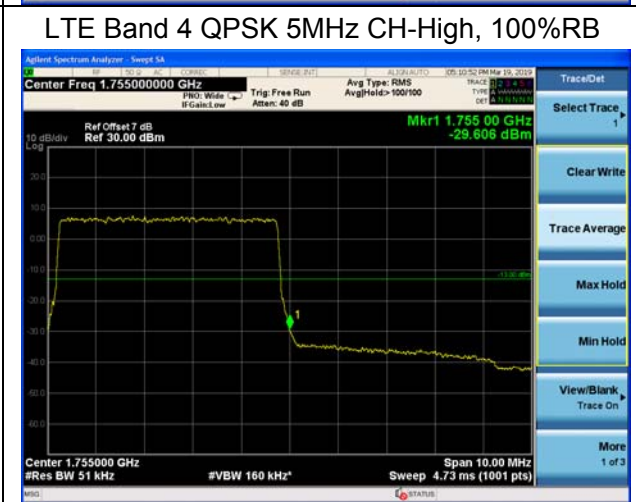
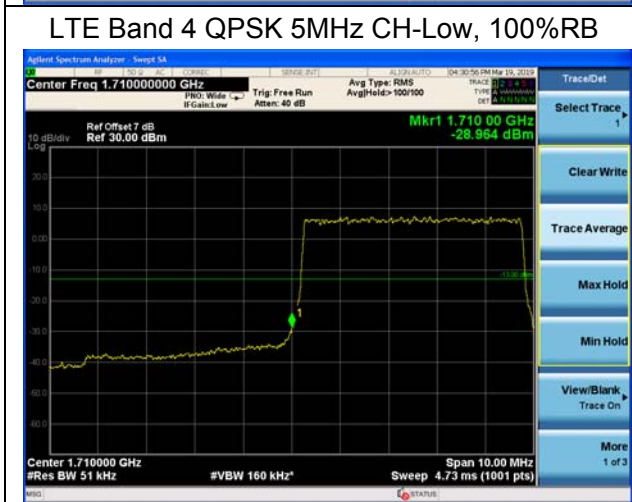
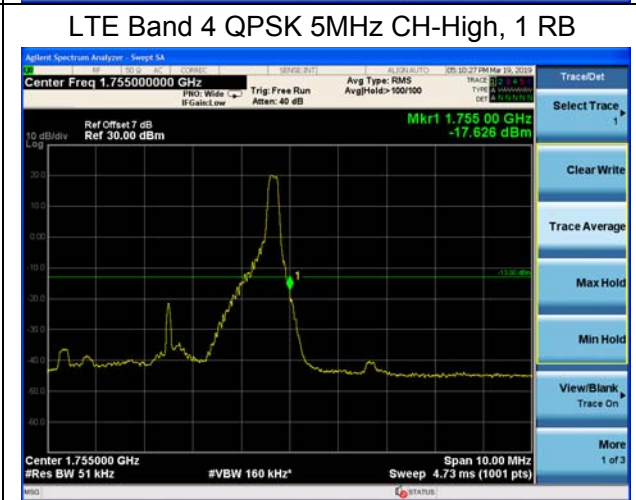
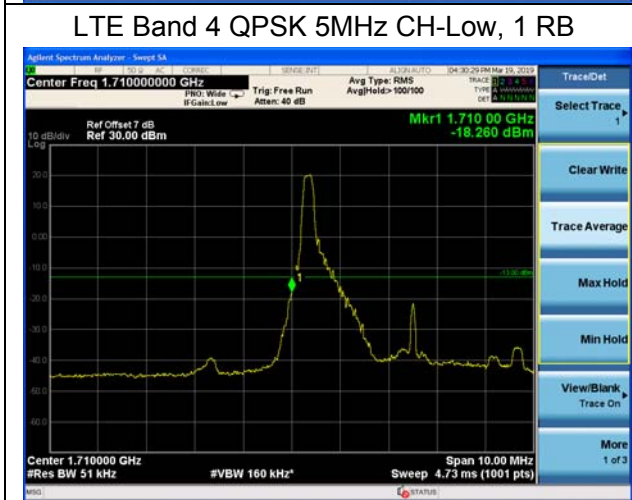
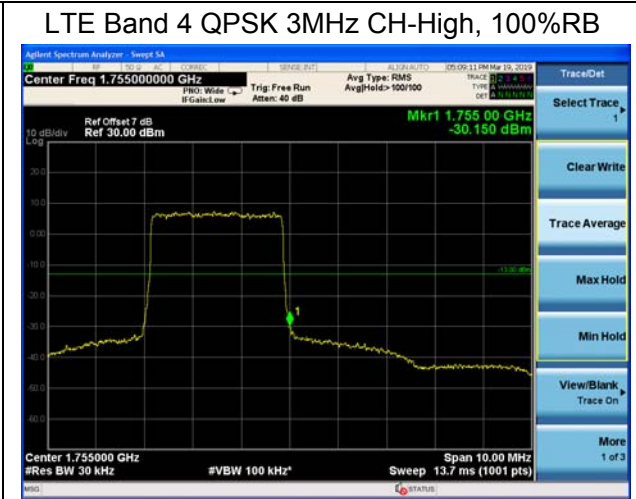
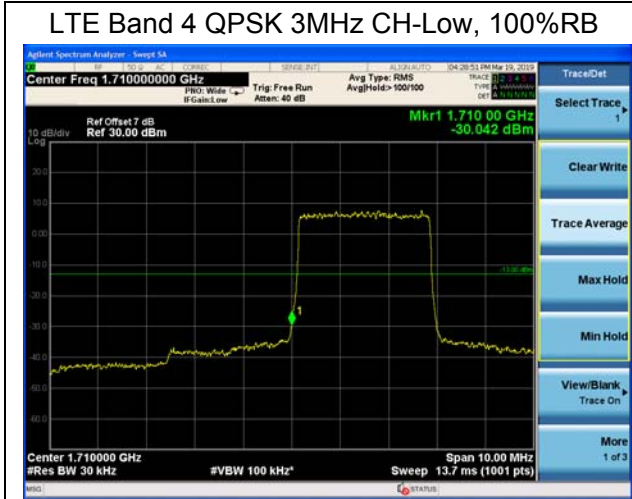

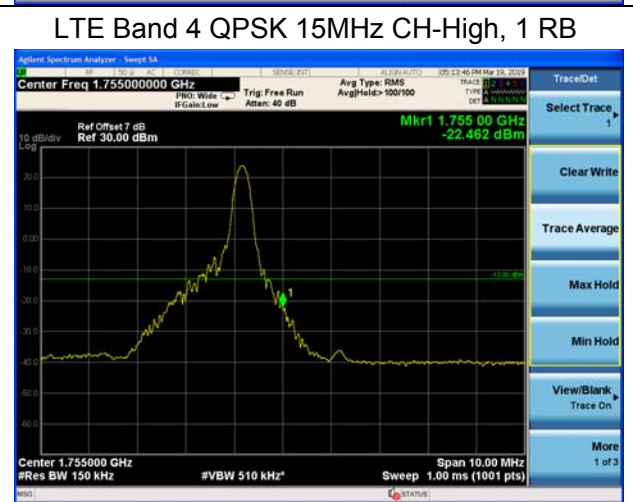
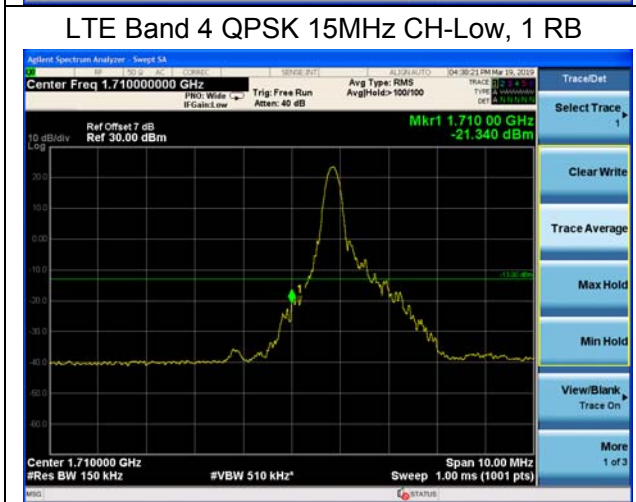
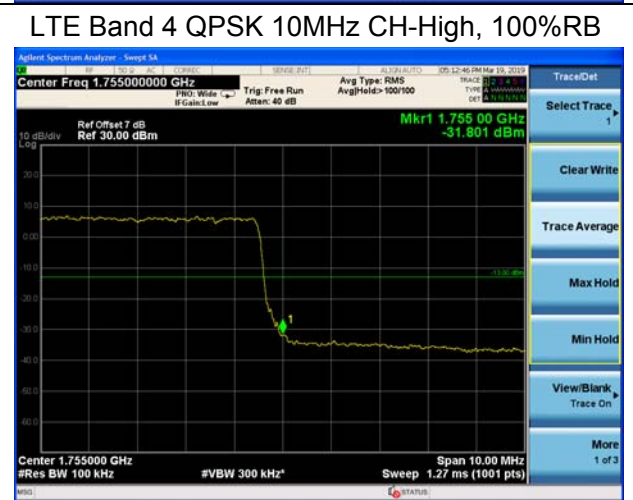
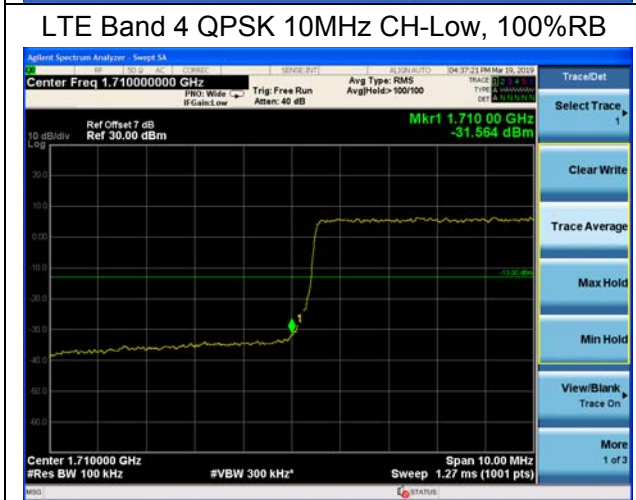
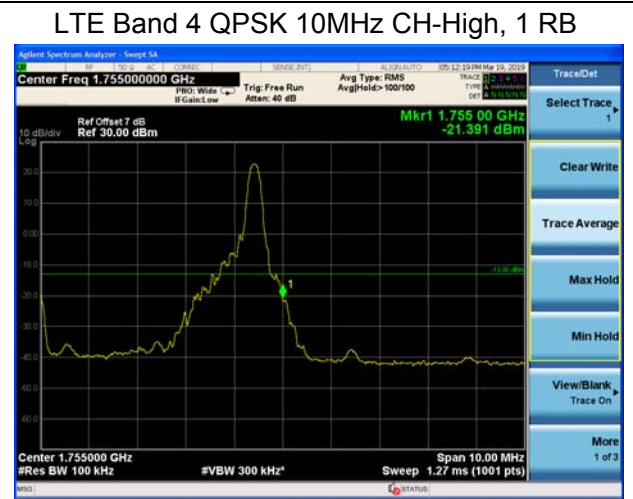
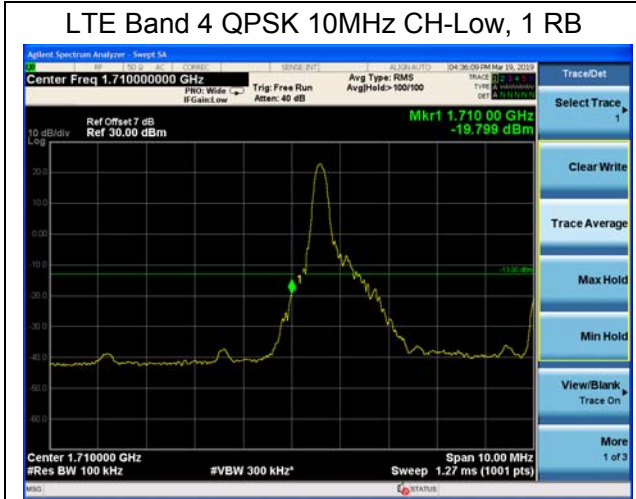

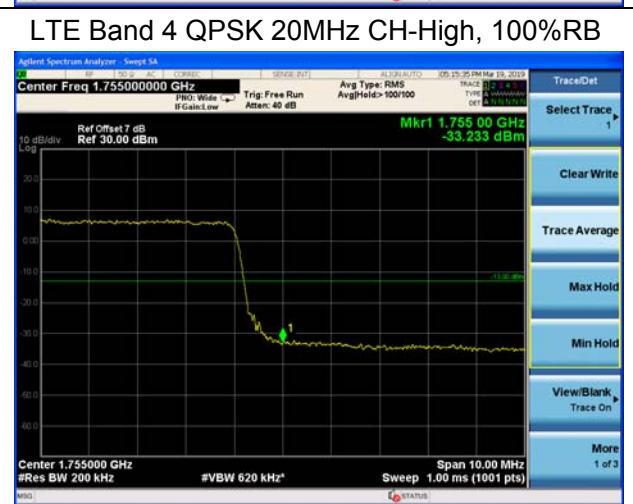
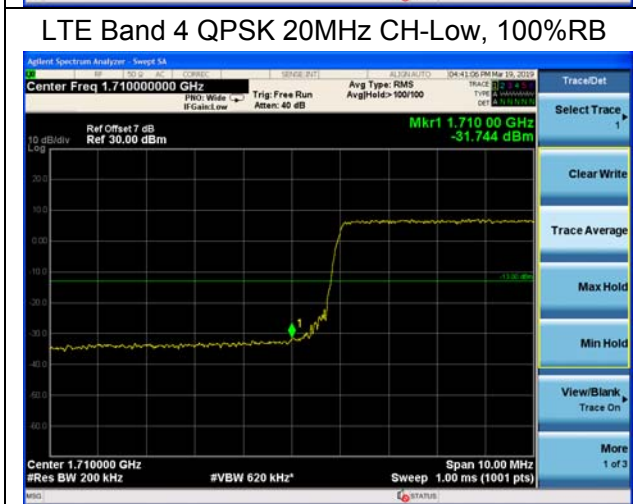
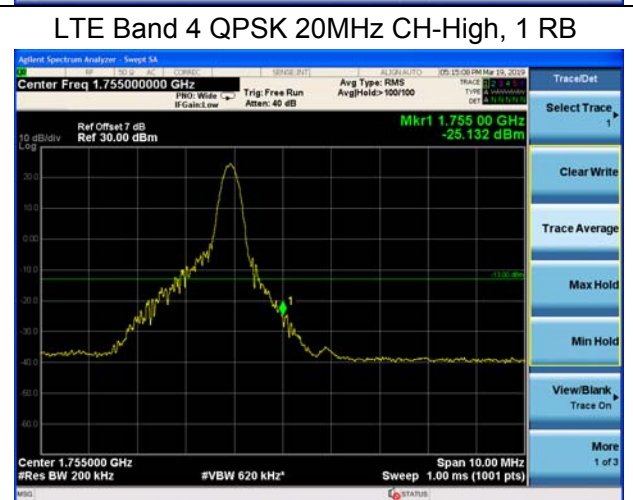
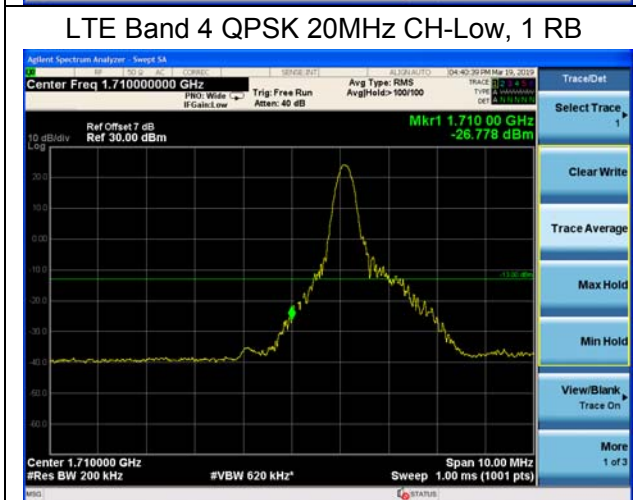
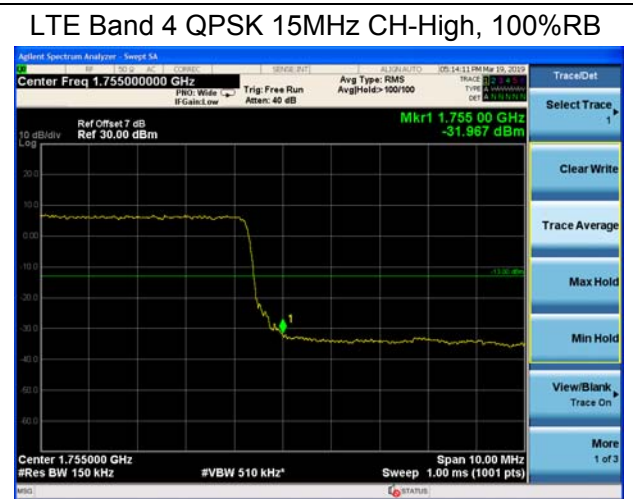
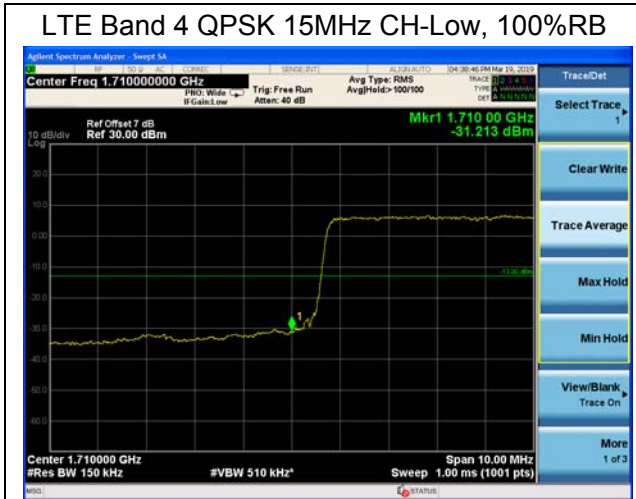

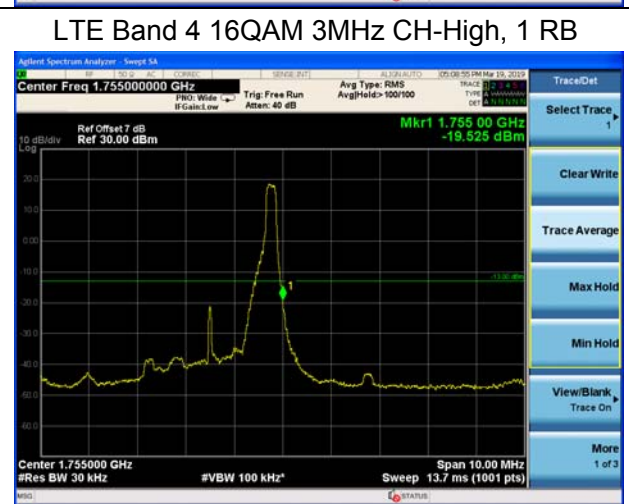
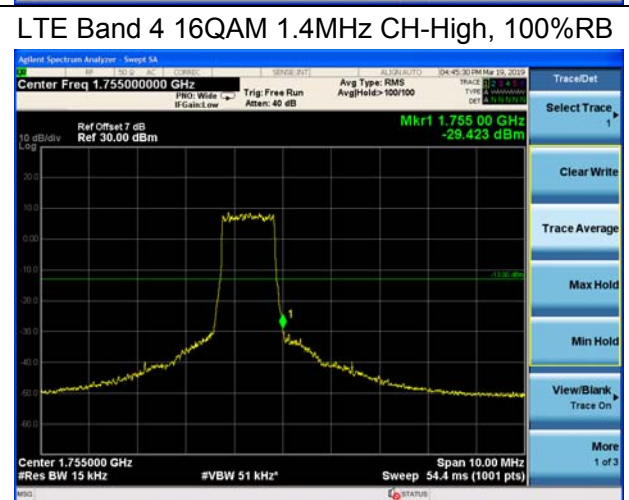
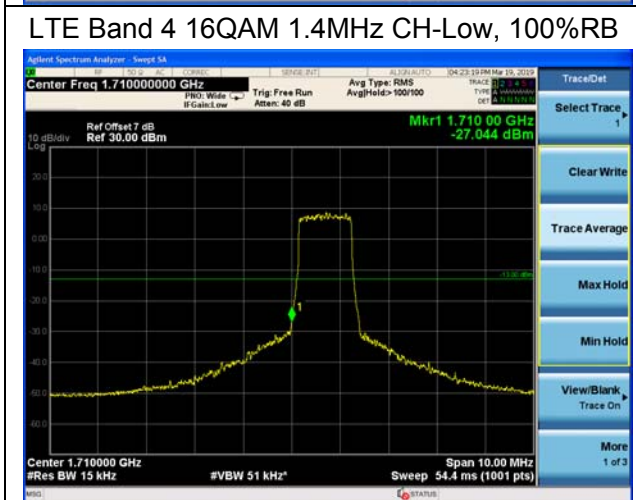
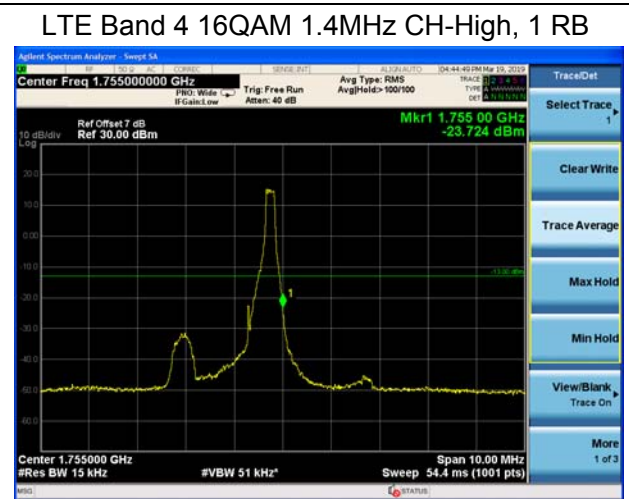
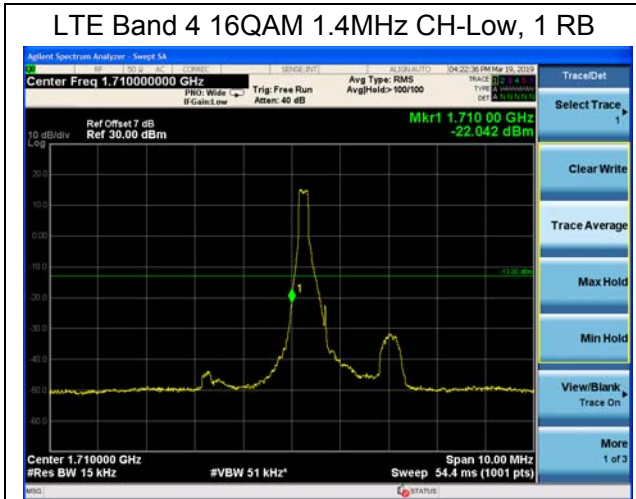

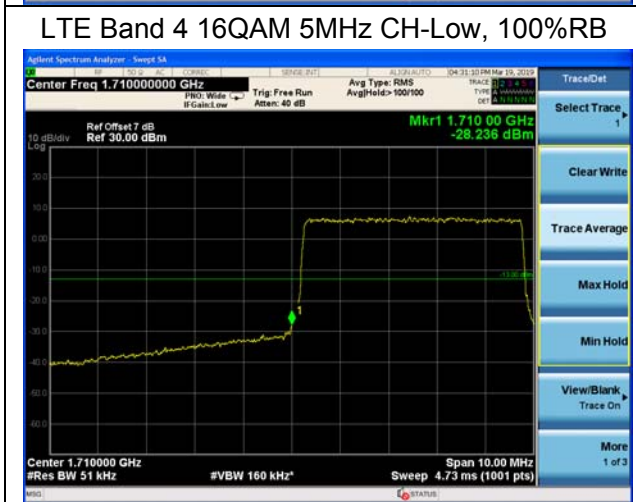
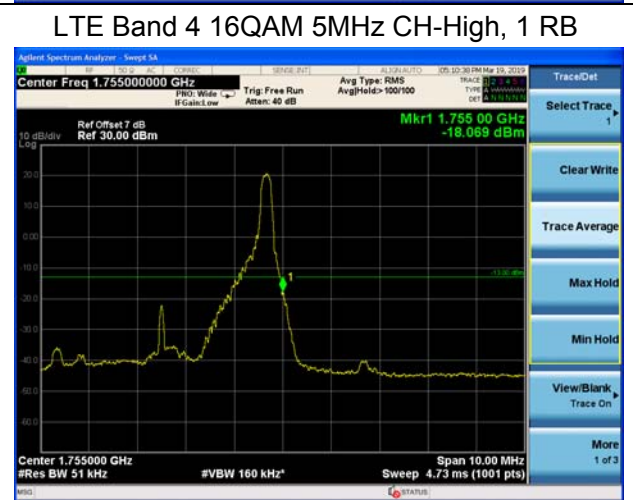
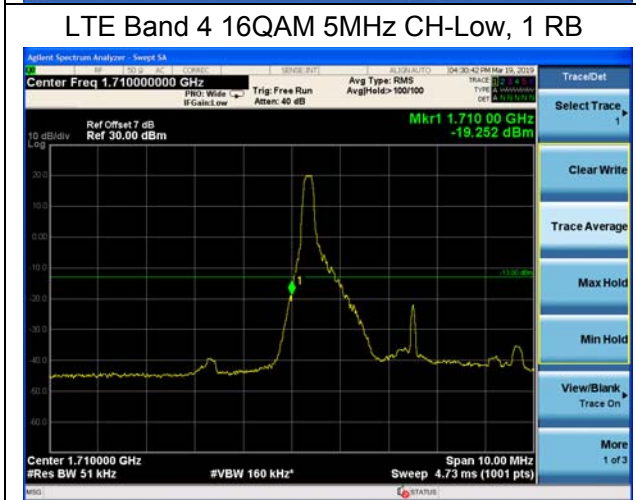
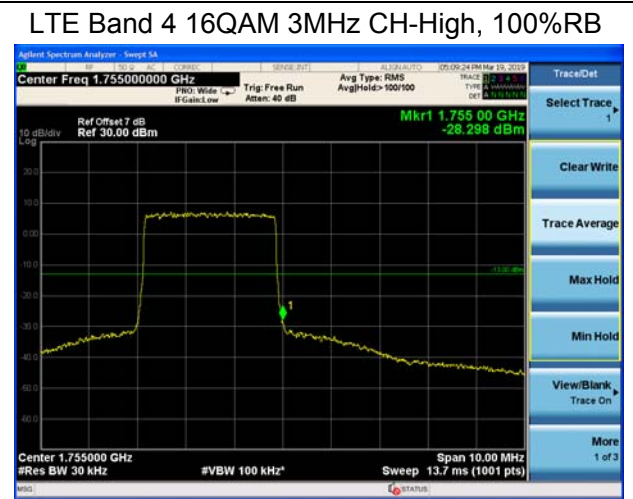
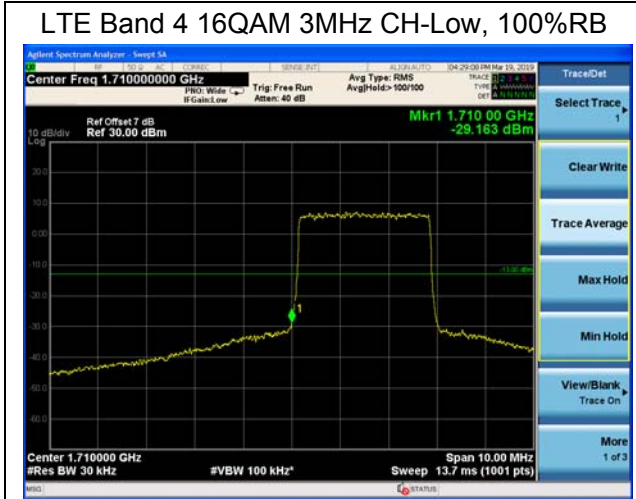

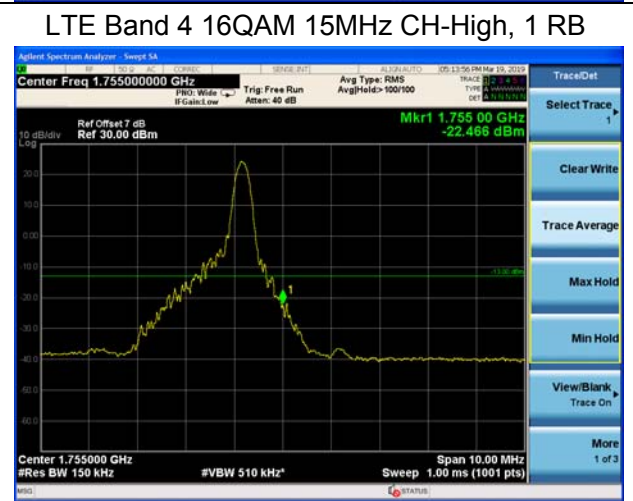
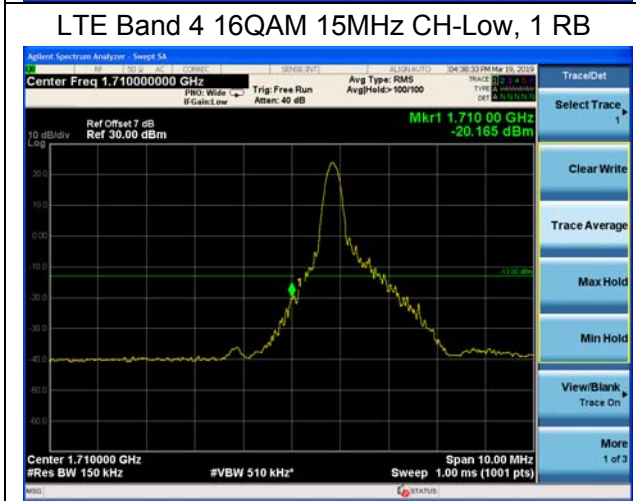
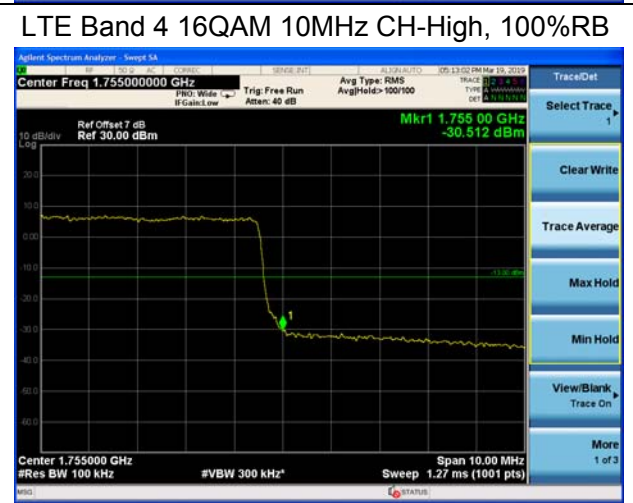
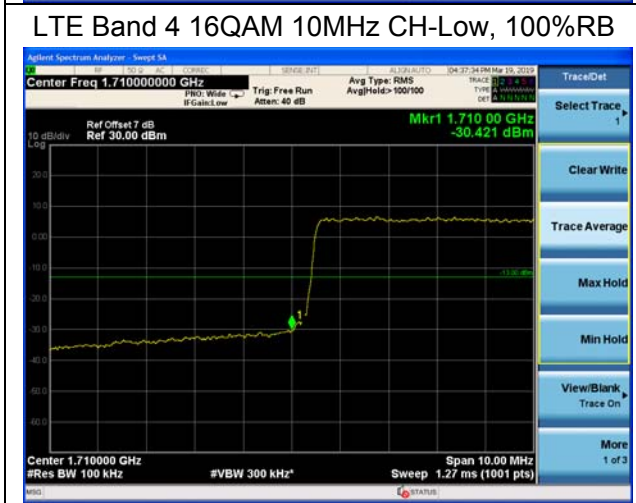
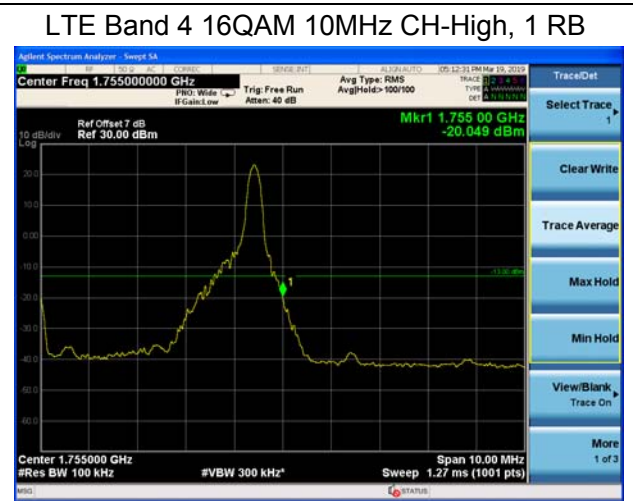
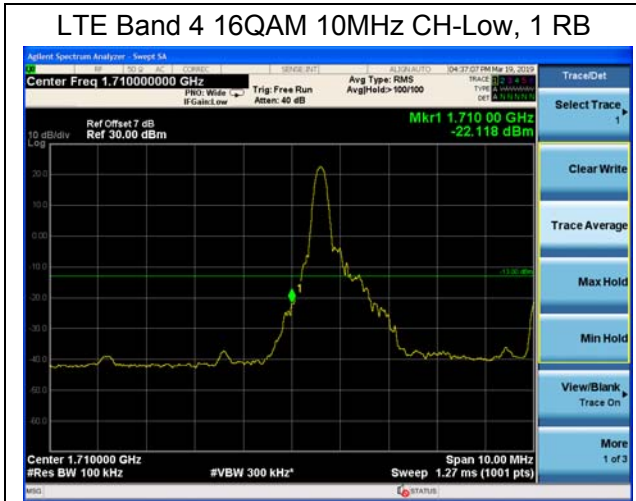

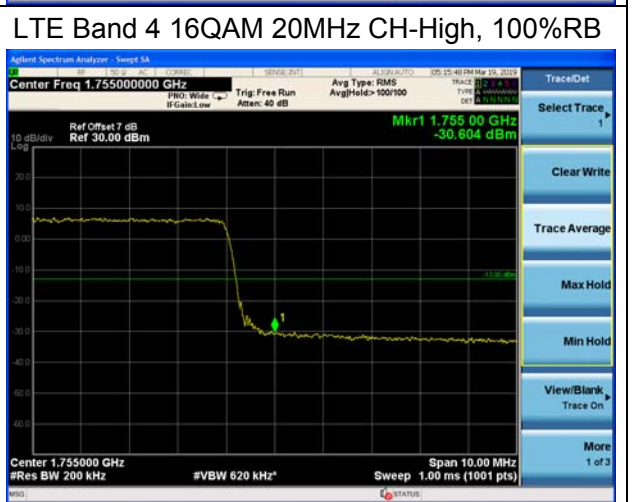
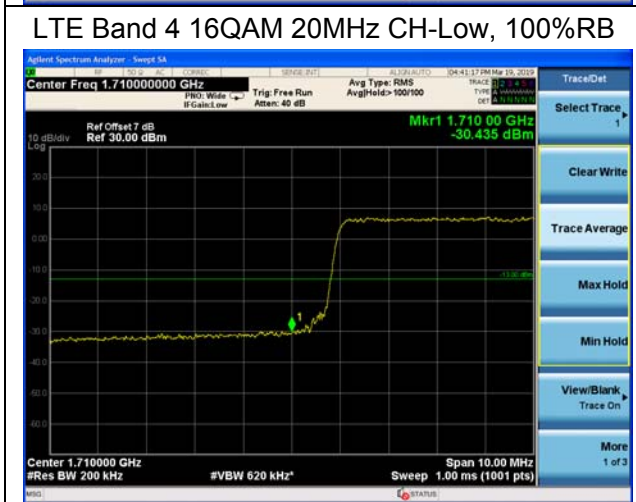
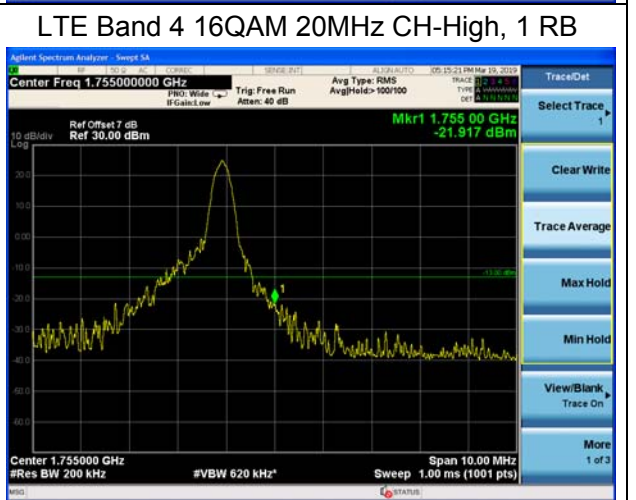
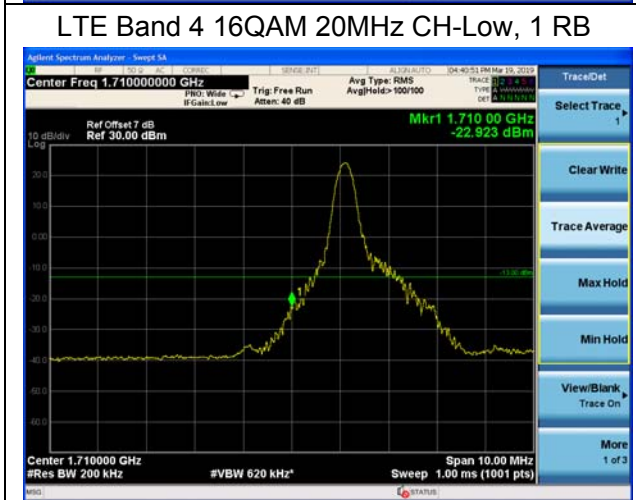
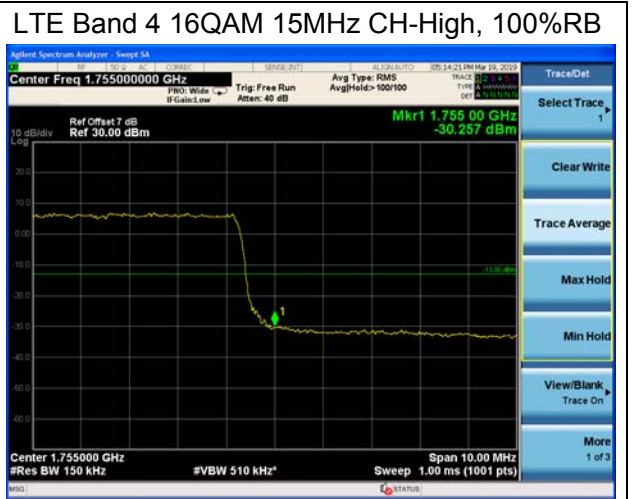
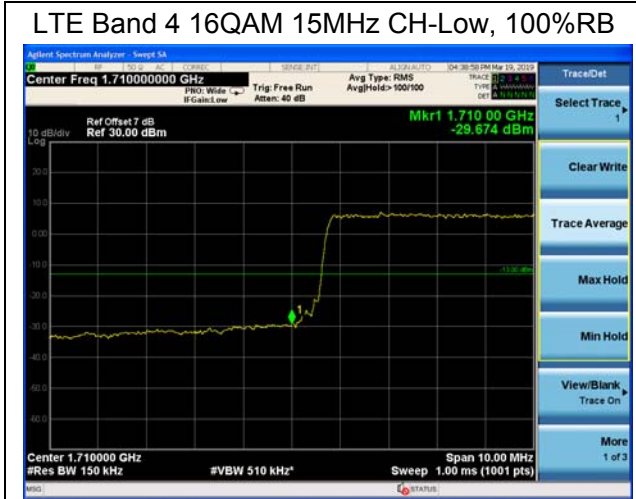



LTE Band 7 QPSK 5MHz CH-Low, 1 RB

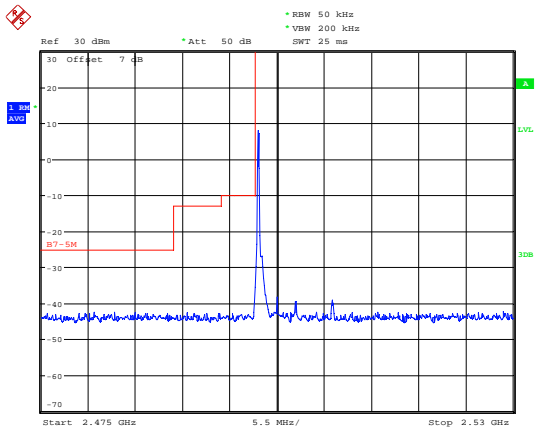

Date: 24.MAR.2019 17:21:39

LTE Band 7 QPSK 5MHz CH-High, 1 RB

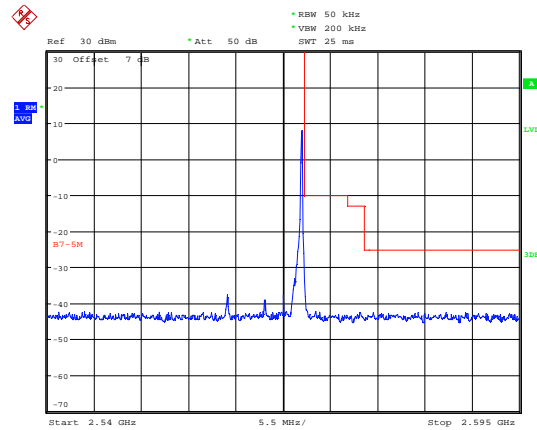

Date: 24.MAR.2019 17:29:22

LTE Band 7 QPSK 5MHz CH-Low, 100%RB

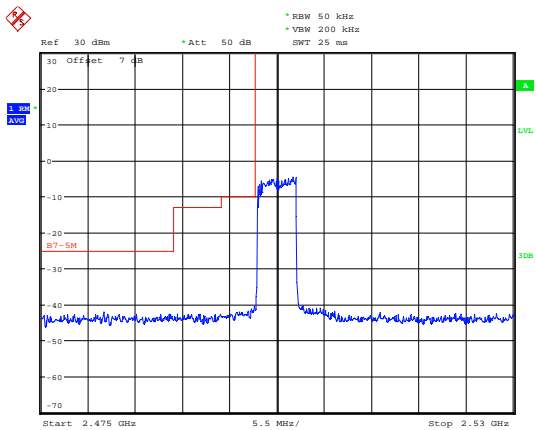

Date: 24.MAR.2019 17:22:02

LTE Band 7 QPSK 5MHz CH-High, 100%RB

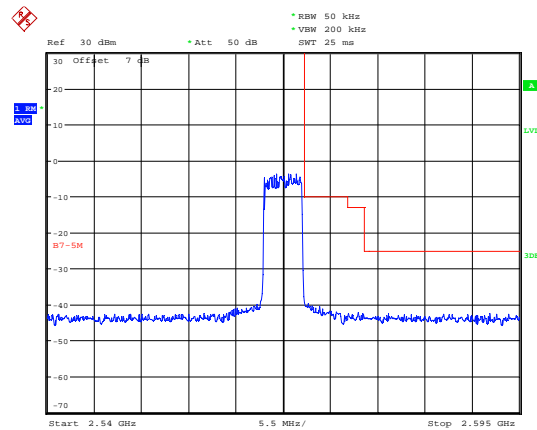

Date: 24.MAR.2019 17:29:45

LTE Band 7 QPSK 10MHz CH-Low, 1 RB

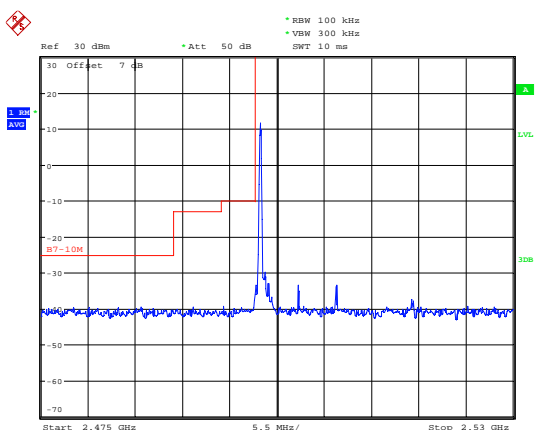

Date: 24.MAR.2019 17:23:14

LTE Band 7 QPSK 10MHz CH-High, 1 RB

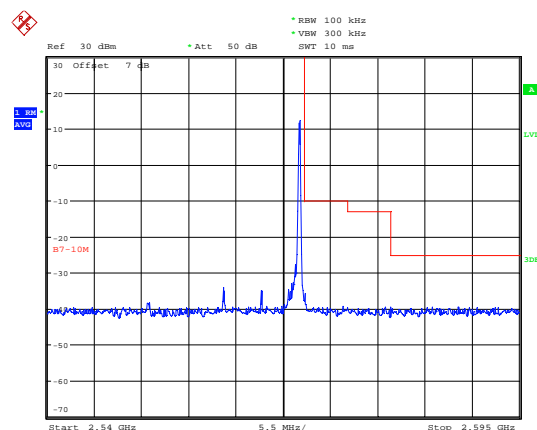

Date: 24.MAR.2019 17:30:47



LTE Band 7 QPSK 10MHz CH-Low, 100%RB

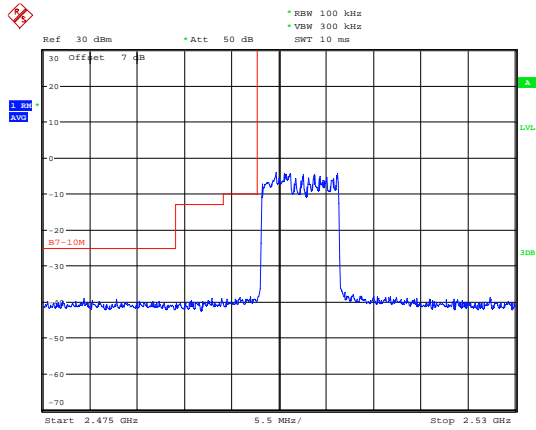

Date: 24.MAR.2019 17:23:34

LTE Band 7 QPSK 10MHz CH-High, 100%RB

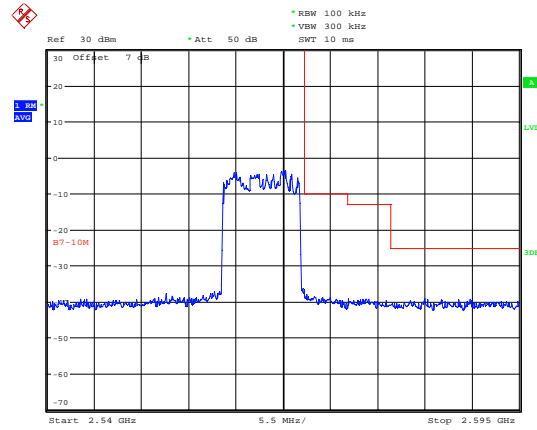

Date: 24.MAR.2019 17:31:06

LTE Band 7 QPSK 15MHz CH-Low, 1 RB

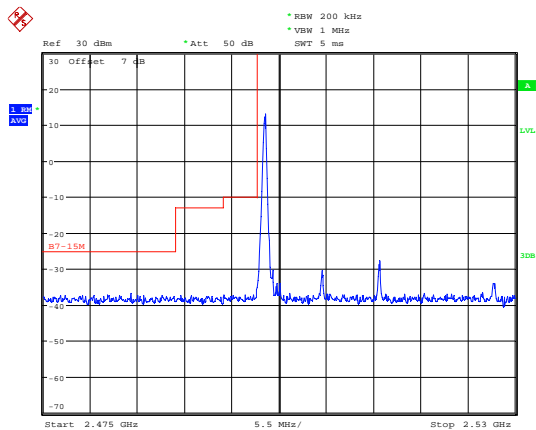

Date: 24.MAR.2019 17:24:39

LTE Band 7 QPSK 15MHz CH-High, 1 RB

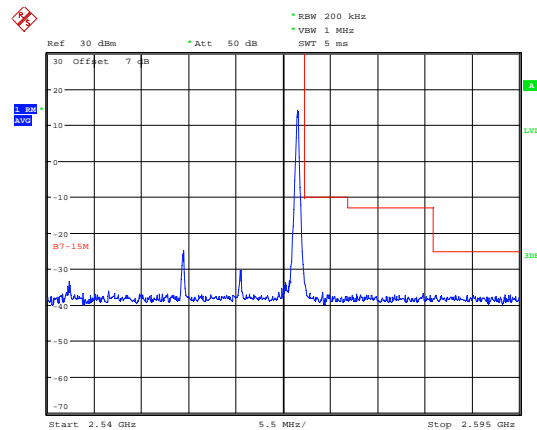

Date: 24.MAR.2019 17:32:10

LTE Band 7 QPSK 15MHz CH-Low, 100%RB

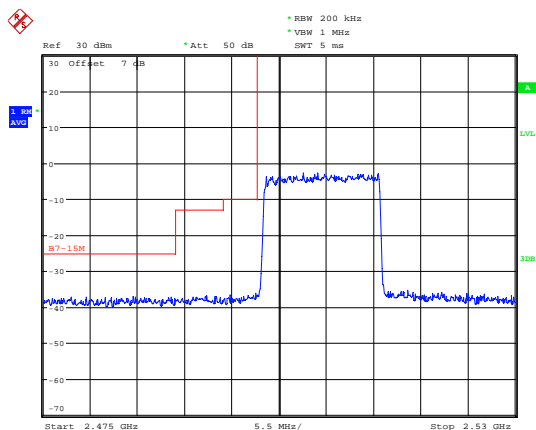

Date: 24.MAR.2019 17:25:00

LTE Band 7 QPSK 15MHz CH-High, 100%RB

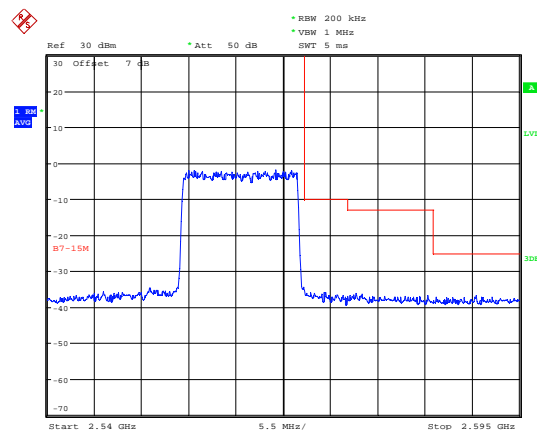

Date: 24.MAR.2019 17:32:29



LTE Band 7 QPSK 20MHz CH-Low, 1 RB

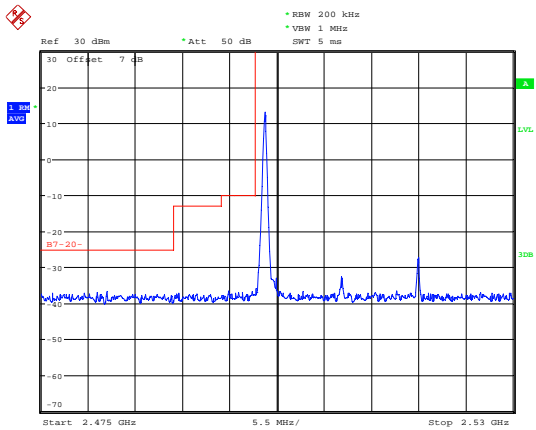

Date: 24.MAR.2019 17:25:56

LTE Band 7 QPSK 20MHz CH-High, 1 RB

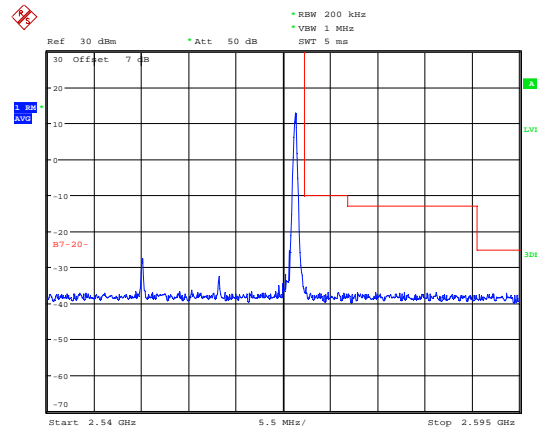

Date: 24.MAR.2019 17:27:25

LTE Band 7 QPSK 20MHz CH-Low, 100%RB

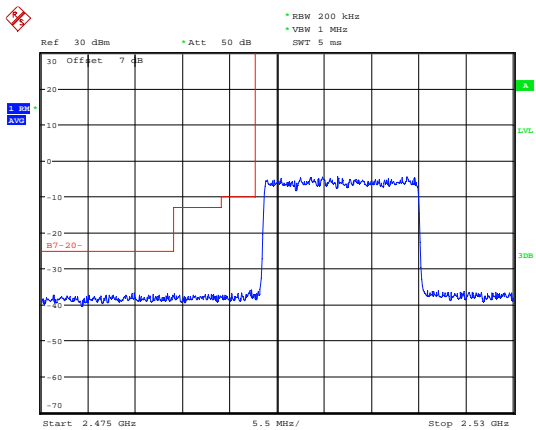

Date: 24.MAR.2019 17:26:17

LTE Band 7 QPSK 20MHz CH-High, 100%RB

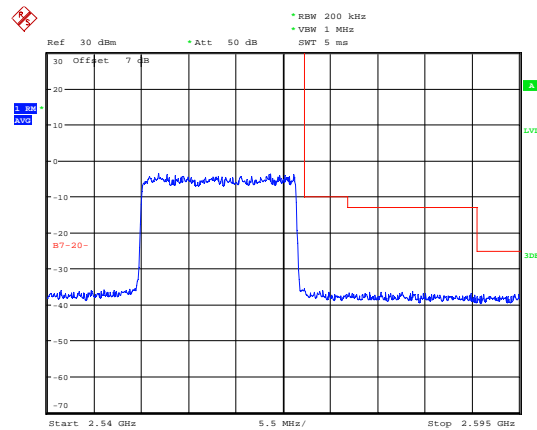

Date: 24.MAR.2019 17:27:53

LTE Band 7 16QAM 5MHz CH-Low, 1 RB

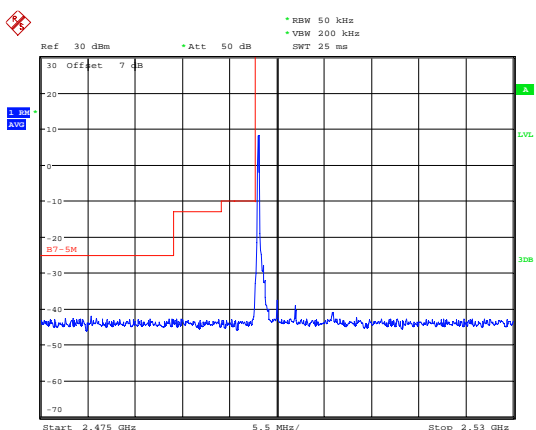

Date: 24.MAR.2019 17:21:50

LTE Band 7 16QAM 5MHz CH-High, 1 RB

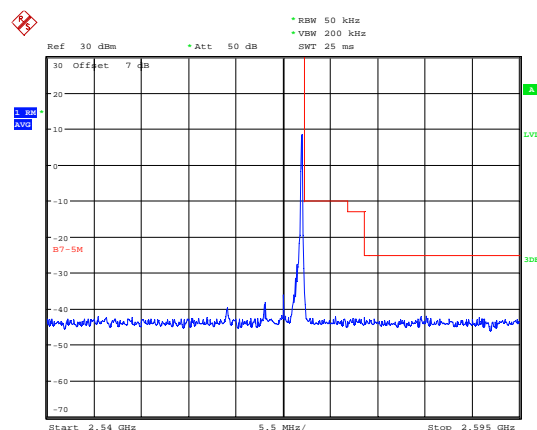

Date: 24.MAR.2019 17:29:31

LTE Band 7 16QAM 5MHz CH-Low, 100%RB

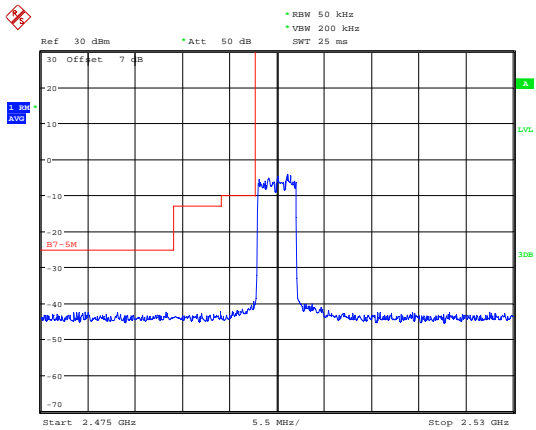

Date: 24.MAR.2019 17:22:11

LTE Band 7 16QAM 5MHz CH-High, 100%RB

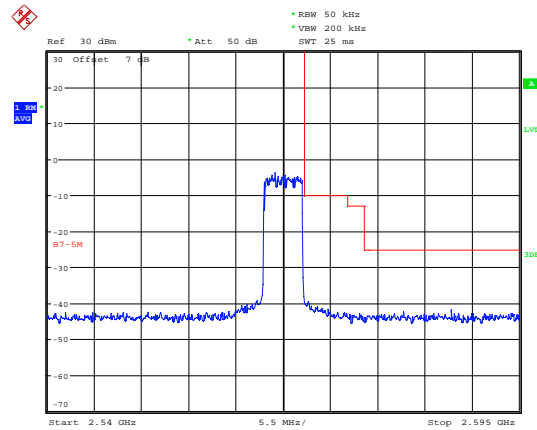

Date: 24.MAR.2019 17:29:53

LTE Band 7 16QAM 10MHz CH-Low, 1 RB

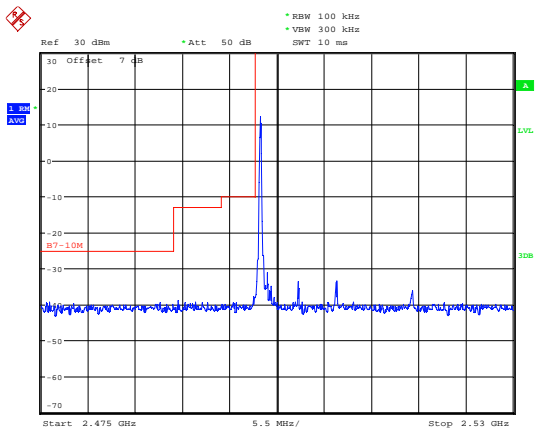

Date: 24.MAR.2019 17:23:22

LTE Band 7 16QAM 10MHz CH-High, 1 RB

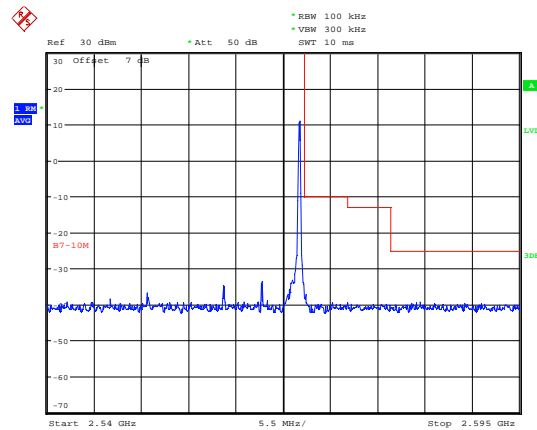

Date: 24.MAR.2019 17:30:56

LTE Band 7 16QAM 10MHz CH-Low, 100%RB

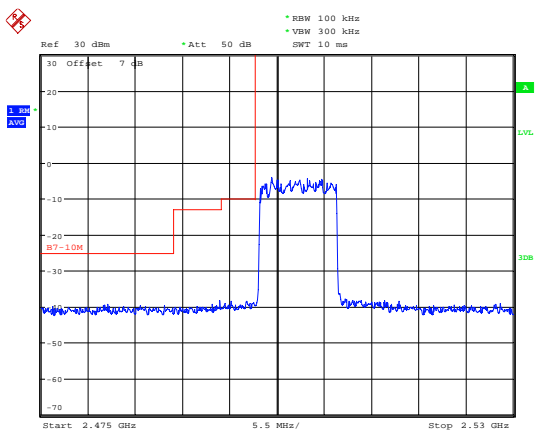

Date: 24.MAR.2019 17:23:43

LTE Band 7 16QAM 10MHz CH-High, 100%RB

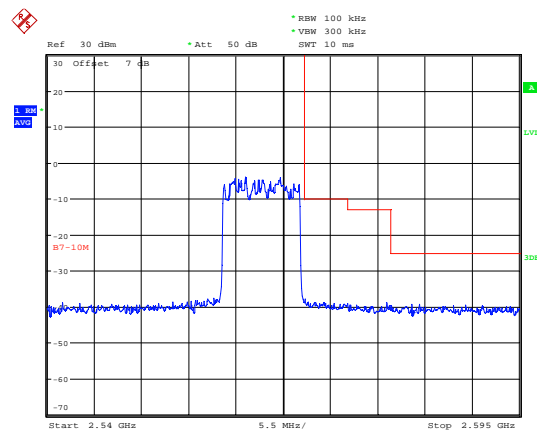

Date: 24.MAR.2019 17:31:15

LTE Band 7 16QAM 15MHz CH-Low, 1 RB

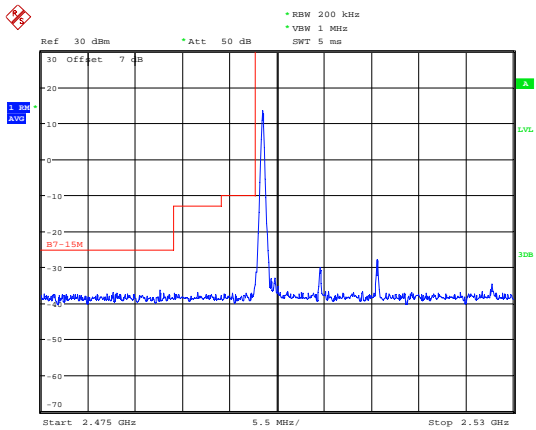

Date: 24.MAR.2019 17:24:49

LTE Band 7 16QAM 15MHz CH-High, 1 RB

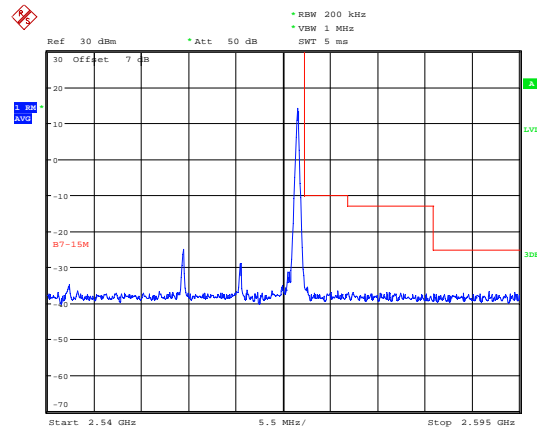

Date: 24.MAR.2019 17:32:19

LTE Band 7 16QAM 15MHz CH-Low, 100%RB

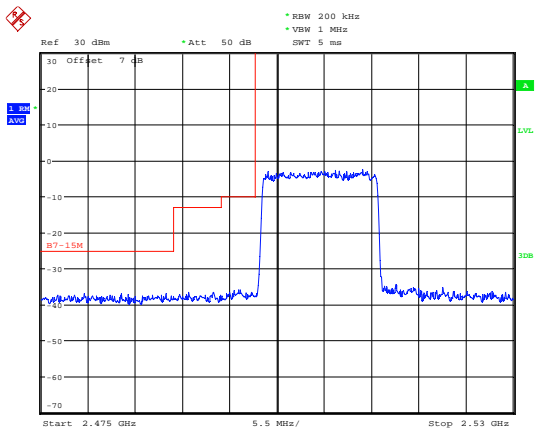

Date: 24.MAR.2019 17:25:14

LTE Band 7 16QAM 15MHz CH-High, 100%RB

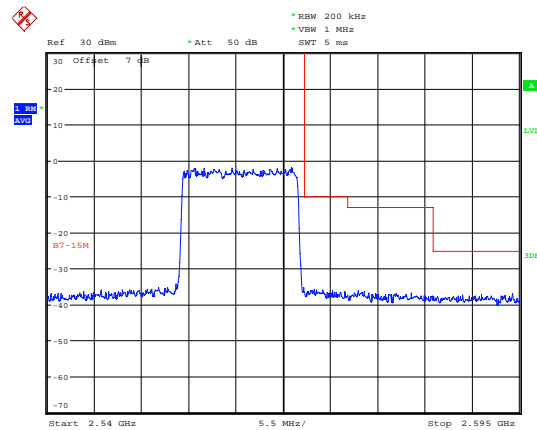

Date: 24.MAR.2019 17:32:38

LTE Band 7 16QAM 20MHz CH-Low, 1 RB

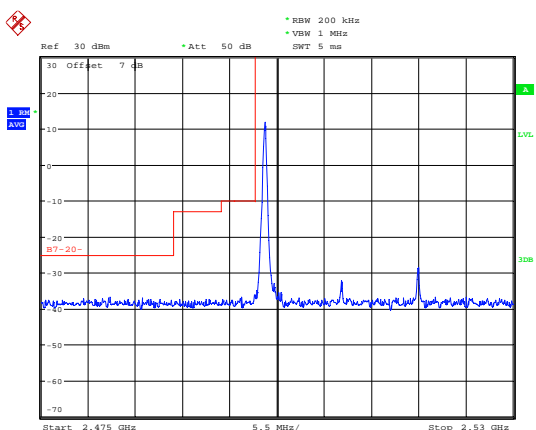

Date: 24.MAR.2019 17:26:06

LTE Band 7 16QAM 20MHz CH-High, 1 RB

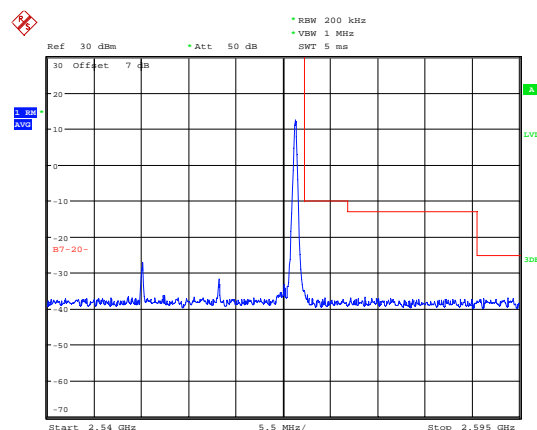

Date: 24.MAR.2019 17:27:42



LTE Band 7 16QAM 20MHz CH-Low, 100%RB

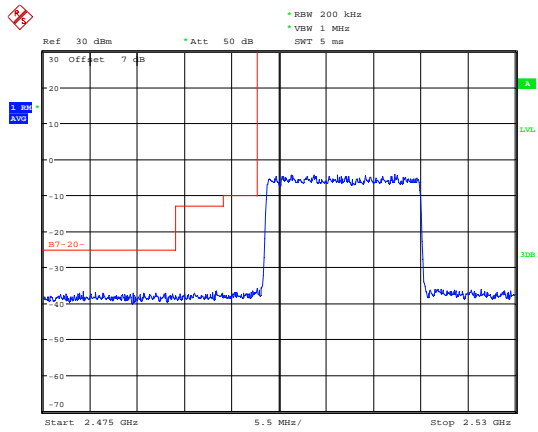

Date: 24.MAR.2019 17:26:27

LTE Band 7 16QAM 20MHz CH-High, 100%RB

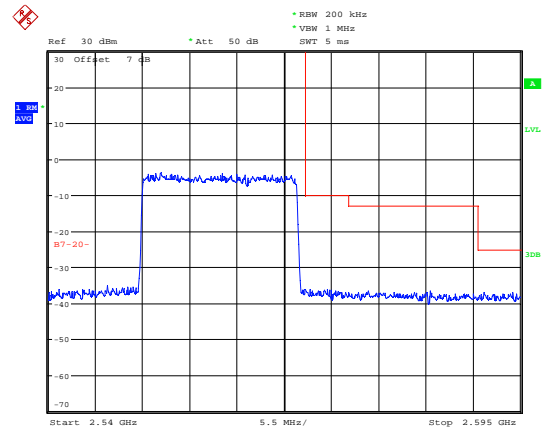

Date: 24.MAR.2019 17:28:02

5.5 Peak-to-Average Power Ratio (PAPR)

Ambient condition

Temperature	Relative humidity	Pressure
23°C ~25°C	45%~50%	101.5kPa

Methods of Measurement

Measure the total peak power and record as Ppk. And measure the total average power and record as PAvg. Both the peak and average power levels must be expressed in the same logarithmic units (e.g., dBm). Determine the PAPR from:

$$PAPR (dB) = Ppk (dBm) - PAvg (dBm).$$

Test Setup

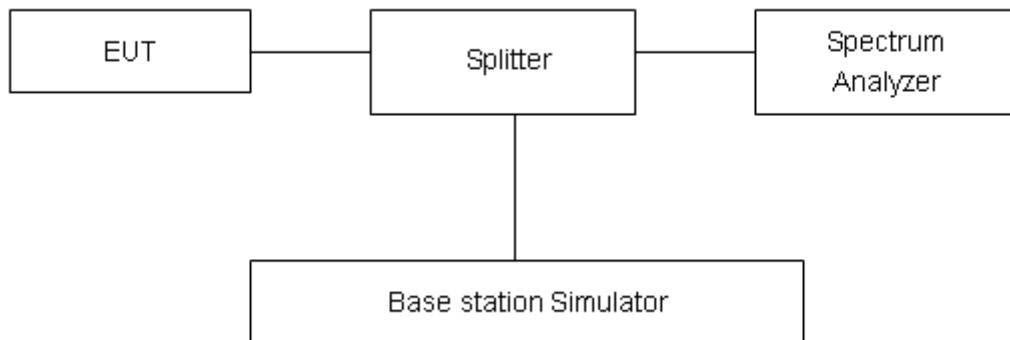

Limits

Rule Part 27.50(d)(5) Equipment employed must be authorized in accordance with the provisions of 24.51. Power measurements for transmissions by stations authorized under this section may be made either in accordance with a Commission-approved average power technique or in compliance with paragraph (d)(6) of this section. In measuring transmissions in this band using an average power technique, the peak-to-average ratio (PAR) of the transmission may not exceed 13 dB.

Measurement Uncertainty

The assessed measurement uncertainty to ensure 95% confidence level for the normal distribution is with the coverage factor k = 2, U= 0.4 dB.

Test Results

WCDMA Band IV	Channel	Frequency (MHz)	Peak (dBm)	Avg (dBm)	PAPR (dB)	Limit (dB)	Conclusion
RMC	1312	1712.4	21.81	18.75	3.06	≤13	PASS
	1413	1732.6	22.06	18.93	3.13	≤13	PASS
	1513	1752.6	22.04	18.95	3.09	≤13	PASS

LTE Band 4								
Modulation	Bandwidth (MHz)	Channel	Frequency (MHz)	Peak (dBm)	Avg (dBm)	PAPR (dB)	Limit (dB)	Conclusion
QPSK	1.4	19957	1710.7	24.14	18.95	5.19	≤13	PASS
		20175	1732.5	24.71	19.18	5.53	≤13	PASS
		20393	1754.3	24.21	18.89	5.32	≤13	PASS
	3	19965	1711.5	24.30	18.93	5.37	≤13	PASS
		20175	1732.5	24.44	18.85	5.59	≤13	PASS
		20385	1753.5	24.41	19.07	5.34	≤13	PASS
	5	19975	1712.5	24.39	19.00	5.39	≤13	PASS
		20175	1732.5	24.53	18.84	5.69	≤13	PASS
		20375	1752.5	24.29	18.78	5.51	≤13	PASS
	10	20000	1715	24.57	19.19	5.38	≤13	PASS
		20175	1732.5	24.25	18.62	5.63	≤13	PASS
		20350	1750	24.54	19.00	5.54	≤13	PASS
	15	20025	1717.5	24.29	18.60	5.69	≤13	PASS
		20175	1732.5	24.10	18.15	5.95	≤13	PASS
		20325	1747.5	24.58	18.68	5.90	≤13	PASS
20	20050	1720	24.23	18.49	5.74	≤13	PASS	
	20175	1732.5	24.59	18.91	5.68	≤13	PASS	
	20300	1745	24.74	19.05	5.69	≤13	PASS	
16QAM	1.4	19957	1710.7	24.71	18.98	5.73	≤13	PASS
		20175	1732.5	25.46	19.27	6.19	≤13	PASS
		20393	1754.3	24.79	18.90	5.89	≤13	PASS
	3	19965	1711.5	24.88	18.97	5.91	≤13	PASS
		20175	1732.5	24.91	18.69	6.22	≤13	PASS
		20385	1753.5	25.13	19.14	5.99	≤13	PASS
	5	19975	1712.5	24.80	19.01	5.79	≤13	PASS
		20175	1732.5	25.11	18.92	6.19	≤13	PASS
		20375	1752.5	24.79	18.80	5.99	≤13	PASS
	10	20000	1715	24.75	18.91	5.84	≤13	PASS
		20175	1732.5	24.94	18.74	6.20	≤13	PASS
		20350	1750	25.10	19.01	6.09	≤13	PASS



	15	20025	1717.5	24.52	18.58	5.94	≤13	PASS
		20175	1732.5	24.56	18.31	6.25	≤13	PASS
		20325	1747.5	24.90	18.71	6.19	≤13	PASS
	20	20050	1720	24.77	18.76	6.01	≤13	PASS
		20175	1732.5	25.15	18.94	6.21	≤13	PASS
		20300	1745	25.30	19.10	6.20	≤13	PASS

LTE Band 7								
Modulation	Bandwidth (MHz)	Channel	Frequency (MHz)	Peak (dBm)	Avg (dBm)	PAPR (dB)	Limit (dB)	Conclusion
QPSK	5	20775	2502.5	22.54	16.94	5.60	≤13	PASS
		21100	2535	22.49	16.96	5.53	≤13	PASS
		21425	2567.5	22.34	16.82	5.52	≤13	PASS
	10	20800	2505	22.53	16.99	5.54	≤13	PASS
		21100	2535	22.55	17.05	5.50	≤13	PASS
		21400	2565	22.40	16.91	5.49	≤13	PASS
	15	20825	2507.5	23.13	17.25	5.88	≤13	PASS
		21100	2535	22.96	17.15	5.81	≤13	PASS
		21375	2562.5	22.92	17.06	5.86	≤13	PASS
	20	20850	2510	22.76	17.16	5.60	≤13	PASS
		21100	2535	22.81	17.24	5.57	≤13	PASS
		21350	2560	22.73	17.09	5.64	≤13	PASS
16QAM	5	20775	2502.5	23.18	16.96	6.22	≤13	PASS
		21100	2535	23.11	16.98	6.13	≤13	PASS
		21425	2567.5	23.13	16.86	6.27	≤13	PASS
	10	20800	2505	23.24	17.01	6.23	≤13	PASS
		21100	2535	23.25	17.01	6.24	≤13	PASS
		21400	2565	23.28	16.95	6.33	≤13	PASS
	15	20825	2507.5	23.59	17.28	6.31	≤13	PASS
		21100	2535	23.43	17.17	6.26	≤13	PASS
		21375	2562.5	177.43	171.07	6.36	≤13	PASS
	20	20850	2510	23.58	17.23	6.35	≤13	PASS
		21100	2535	23.51	17.24	6.27	≤13	PASS
		21350	2560	23.22	16.90	6.32	≤13	PASS

5.6 Frequency Stability

Ambient condition

Temperature	Relative humidity	Pressure
23°C ~25°C	45%~50%	101.5kPa

Method of Measurement

Frequency Stability (Temperature Variation)

The temperature inside the climate chamber is varied from -30°C to +55°C in 10°C step size.

(1) With all power removed, the temperature was decreased to -10°C and permitted to stabilize for three hours.

(2) Measure the carrier frequency with the test equipment in a “call mode”. These measurements should be made within 1 minute of powering up the mobile station, to prevent significant self warming.

(3) Repeat the above measurements at 10°C increments from -30°C to +55°C. Allow at least 1.5 hours at each temperature, un-powered, before making measurements.

Frequency Stability (Voltage Variation)

The frequency stability shall be measured with variation of primary supply voltage as follows:

(1) Vary primary supply voltage from 85 to 115 percent of the nominal value for other than hand carried battery equipment.

(2) For hand carried, battery powered equipment, reduce primary supply voltage to the battery-operating end point which shall be specified by the manufacturer.

This transceiver is specified to operate with an input voltage of between 3.6 V and 4.4 V, with a nominal voltage of 3.82V.

Test setup

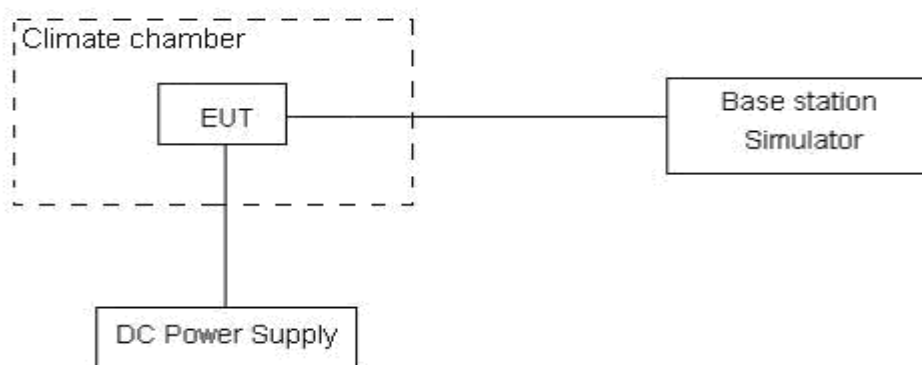

Limits

The frequency stability shall be sufficient to ensure that the fundamental emissions stay within the authorized bands of operation.

Measurement Uncertainty

The assessed measurement uncertainty to ensure 99.75% confidence level for the normal distribution is with the coverage factor $k = 3$, $U=0.01\text{ppm}$.

Test Result

WCDMA Band IV						
Condition		Freq.Error (Hz)	Freq.Error (Hz)	Frequency Stability (ppm)	Frequency Stability (ppm)	Verdict
Temperature	Voltage					
Normal (25°C)	Normal	14.72	12.80	0.00783	0.00681	PASS
Extreme (55°C)		3.70	15.94	0.00197	0.00848	PASS
Extreme (50°C)		15.86	15.74	0.00844	0.00837	PASS
Extreme (40°C)		13.62	7.78	0.00724	0.00414	PASS
Extreme (30°C)		6.08	2.76	0.00324	0.00147	PASS
Extreme (20°C)		14.18	9.23	0.00754	0.00491	PASS
Extreme (10°C)		3.17	6.92	0.00169	0.00368	PASS
Extreme (0°C)		3.44	11.24	0.00183	0.00598	PASS
Extreme (-10°C)		16.58	11.24	0.00882	0.00598	PASS
Extreme (-20°C)		7.09	8.51	0.00377	0.00453	PASS
Extreme (-30°C)		11.54	2.14	0.00614	0.00114	PASS
25°C		LV	12.63	14.71	0.00672	0.00783
	HV	10.26	11.72	0.00546	0.00623	PASS

LTE Band 4, BANDWIDTH 1.4MHz						
Condition		Freq.Error (Hz)	Freq.Error (Hz)	Frequency Stability (ppm)	Frequency Stability (ppm)	Verdict
Temperature	Voltage	16QAM	QPSK	16QAM	QPSK	
Normal (25°C)	Normal	13.20	3.71	0.00702	0.00198	PASS
Extreme (55°C)		9.25	17.58	0.00492	0.00935	PASS
Extreme (50°C)		6.93	12.87	0.00369	0.00684	PASS
Extreme (40°C)		5.41	12.83	0.00288	0.00682	PASS
Extreme (30°C)		8.80	13.46	0.00468	0.00716	PASS
Extreme (20°C)		17.49	10.15	0.00930	0.00540	PASS
Extreme (10°C)		17.59	5.74	0.00936	0.00305	PASS
Extreme (0°C)		15.48	14.78	0.00823	0.00786	PASS
Extreme (-10°C)		8.54	5.92	0.00454	0.00315	PASS
Extreme (-20°C)		10.25	3.81	0.00545	0.00203	PASS
Extreme (-30°C)		11.31	11.25	0.00602	0.00599	PASS
25°C		LV	16.17	8.36	0.00860	0.00445
	HV	12.31	2.88	0.00655	0.00153	PASS

LTE Band 4, BANDWIDTH 3MHz						
Condition		Freq.Error (Hz)	Freq.Error (Hz)	Frequency Stability (ppm)	Frequency Stability (ppm)	Verdict
BANDWIDTH	3MHz					
Temperature	Voltage	16QAM	QPSK	16QAM	QPSK	
Normal (25°C)	Normal	6.30	2.62	0.00335	0.00140	PASS
Extreme (55°C)		14.78	4.70	0.00786	0.00250	PASS
Extreme (50°C)		12.81	1.87	0.00682	0.00100	PASS
Extreme (40°C)		7.91	4.93	0.00421	0.00262	PASS
Extreme (30°C)		6.64	13.82	0.00353	0.00735	PASS
Extreme (20°C)		15.09	13.95	0.00803	0.00742	PASS
Extreme (10°C)		17.72	7.56	0.00942	0.00402	PASS
Extreme (0°C)		3.80	5.47	0.00202	0.00291	PASS
Extreme (-10°C)		3.61	11.11	0.00192	0.00591	PASS
Extreme (-20°C)		12.71	3.61	0.00676	0.00192	PASS
Extreme (-30°C)		14.62	14.21	0.00778	0.00756	PASS
25°C	LV	13.09	8.82	0.00696	0.00469	PASS
	HV	1.82	1.69	0.00097	0.00090	PASS

LTE Band 4, BANDWIDTH 5MHz						
Condition		Freq.Error (Hz)	Freq.Error (Hz)	Frequency Stability (ppm)	Frequency Stability (ppm)	Verdict
Temperature	Voltage	16QAM	QPSK	16QAM	QPSK	
Normal (25°C)	Normal	8.41	5.28	0.00447	0.00281	
Extreme (55°C)		5.93	17.93	0.00315	0.00954	PASS
Extreme (50°C)		13.10	4.27	0.00697	0.00227	PASS
Extreme (40°C)		7.23	14.75	0.00385	0.00785	PASS
Extreme (30°C)		18.00	10.63	0.00957	0.00566	PASS
Extreme (20°C)		16.15	9.85	0.00859	0.00524	PASS
Extreme (10°C)		17.89	1.39	0.00952	0.00074	PASS
Extreme (0°C)		9.08	17.16	0.00483	0.00913	PASS
Extreme (-10°C)		3.44	6.30	0.00183	0.00335	PASS
Extreme (-20°C)		12.53	12.84	0.00666	0.00683	PASS
Extreme (-30°C)		6.65	10.19	0.00354	0.00542	PASS
25°C	LV	6.94	10.66	0.00369	0.00567	PASS
	HV	2.54	11.21	0.00135	0.00596	PASS

LTE Band 4, BANDWIDTH 10MHz						
Condition		Freq.Error (Hz)	Freq.Error (Hz)	Frequency Stability (ppm)	Frequency Stability (ppm)	Verdict
Temperature	Voltage	16QAM	QPSK	16QAM	QPSK	
Normal (25°C)	Normal	1.31	13.76	0.00070	0.00732	PASS
Extreme (55°C)		13.49	5.58	0.00717	0.00297	PASS
Extreme (50°C)		7.88	14.99	0.00419	0.00797	PASS
Extreme (40°C)		15.15	5.54	0.00806	0.00295	PASS
Extreme (30°C)		8.95	12.79	0.00476	0.00680	PASS
Extreme (20°C)		17.51	5.90	0.00932	0.00314	PASS
Extreme (10°C)		3.39	8.88	0.00181	0.00472	PASS
Extreme (0°C)		8.56	13.08	0.00455	0.00696	PASS
Extreme (-10°C)		8.46	10.52	0.00450	0.00559	PASS
Extreme (-20°C)		8.24	10.89	0.00438	0.00579	PASS
Extreme (-30°C)		14.66	10.55	0.00780	0.00561	PASS
25°C	LV	14.92	17.96	0.00794	0.00955	PASS
	HV	4.28	5.22	0.00228	0.00278	PASS

LTE Band 4, BANDWIDTH 15MHz						
Condition		Freq.Error (Hz)	Freq.Error (Hz)	Frequency Stability (ppm)	Frequency Stability (ppm)	Verdict
BANDWIDTH	15MHz					
Temperature	Voltage	16QAM	QPSK	16QAM	QPSK	
Normal (25°C)	Normal	14.11	16.59	0.00751	0.00882	PASS
Extreme (55°C)		10.19	14.40	0.00542	0.00766	PASS
Extreme (50°C)		14.85	2.20	0.00790	0.00117	PASS
Extreme (40°C)		11.54	12.86	0.00614	0.00684	PASS
Extreme (30°C)		6.64	10.88	0.00353	0.00579	PASS
Extreme (20°C)		8.95	16.40	0.00476	0.00872	PASS
Extreme (10°C)		13.23	12.80	0.00704	0.00681	PASS
Extreme (0°C)		17.27	14.22	0.00918	0.00756	PASS
Extreme (-10°C)		9.43	11.99	0.00502	0.00638	PASS
Extreme (-20°C)		1.05	5.87	0.00056	0.00312	PASS
Extreme (-30°C)		13.08	2.69	0.00696	0.00143	PASS
25°C	LV	17.86	9.20	0.00950	0.00489	PASS
	HV	2.09	12.13	0.00111	0.00645	PASS

LTE Band 4, BANDWIDTH 20MHz						
Condition		Freq.Error (Hz)	Freq.Error (Hz)	Frequency Stability (ppm)	Frequency Stability (ppm)	Verdict
BANDWIDTH	20MHz					
Temperature	Voltage	16QAM	QPSK	16QAM	QPSK	
Normal (25°C)	Normal	1.11	2.61	0.00059	0.00139	PASS
Extreme (55°C)		17.82	17.20	0.00948	0.00915	PASS
Extreme (50°C)		6.31	5.12	0.00335	0.00272	PASS
Extreme (40°C)		12.68	3.26	0.00674	0.00173	PASS
Extreme (30°C)		1.93	13.96	0.00103	0.00742	PASS
Extreme (20°C)		17.25	3.27	0.00917	0.00174	PASS
Extreme (10°C)		15.41	8.77	0.00819	0.00467	PASS
Extreme (0°C)		11.83	8.96	0.00629	0.00477	PASS
Extreme (-10°C)		1.68	11.65	0.00089	0.00620	PASS
Extreme (-20°C)		11.42	4.18	0.00607	0.00223	PASS
Extreme (-30°C)		2.74	9.22	0.00146	0.00490	PASS
25°C	LV	17.22	11.15	0.00916	0.00593	PASS
	HV	15.72	16.74	0.00836	0.00891	PASS

LTE Band 7, BANDWIDTH 5MHz						
Condition		Freq.Error (Hz)	Freq.Error (Hz)	Frequency Stability (ppm)	Frequency Stability (ppm)	Verdict
BANDWIDTH	5MHz					
Temperature	Voltage	16QAM	QPSK	16QAM	QPSK	
Normal (25°C)	Normal	10.81	2.25	0.00575	0.00119	PASS
Extreme (55°C)		5.54	17.77	0.00295	0.00945	PASS
Extreme (50°C)		12.00	17.46	0.00638	0.00929	PASS
Extreme (40°C)		16.32	3.00	0.00868	0.00160	PASS
Extreme (30°C)		5.89	8.64	0.00313	0.00460	PASS
Extreme (20°C)		5.21	12.88	0.00277	0.00685	PASS
Extreme (10°C)		1.97	12.28	0.00105	0.00653	PASS
Extreme (0°C)		1.62	15.74	0.00086	0.00837	PASS
Extreme (-10°C)		7.49	5.67	0.00398	0.00302	PASS
Extreme (-20°C)		7.09	17.86	0.00377	0.00950	PASS
Extreme (-30°C)		5.40	12.02	0.00287	0.00639	PASS
25°C	LV	9.15	10.40	0.00487	0.00553	PASS
	HV	3.00	15.89	0.00160	0.00845	PASS

LTE Band 7, BANDWIDTH 10MHz						
Condition		Freq.Error (Hz)	Freq.Error (Hz)	Frequency Stability (ppm)	Frequency Stability (ppm)	Verdict
BANDWIDTH	5MHz					
Temperature	Voltage	16QAM	QPSK	16QAM	QPSK	
Normal (25°C)	Normal	1.74	5.22	0.00093	0.00278	PASS
Extreme (55°C)		9.86	6.61	0.00525	0.00352	PASS
Extreme (50°C)		8.73	9.03	0.00464	0.00480	PASS
Extreme (40°C)		17.04	2.09	0.00906	0.00111	PASS
Extreme (30°C)		11.89	7.75	0.00632	0.00412	PASS
Extreme (20°C)		6.36	3.68	0.00338	0.00196	PASS
Extreme (10°C)		13.40	10.71	0.00713	0.00570	PASS
Extreme (0°C)		6.13	2.78	0.00326	0.00148	PASS
Extreme (-10°C)		4.11	9.27	0.00219	0.00493	PASS
Extreme (-20°C)		2.89	14.22	0.00153	0.00756	PASS
Extreme (-30°C)		1.23	17.30	0.00065	0.00920	PASS
25°C		LV	13.78	13.38	0.00733	0.00712
	HV	8.55	8.96	0.00455	0.00477	PASS

LTE Band 7, BANDWIDTH 15MHz						
Condition		Freq.Error (Hz)	Freq.Error (Hz)	Frequency Stability (ppm)	Frequency Stability (ppm)	Verdict
BANDWIDTH	5MHz					
Temperature	Voltage	16QAM	QPSK	16QAM	QPSK	
Normal (25°C)	Normal	16.83	7.91	0.00895	0.00421	PASS
Extreme (55°C)		9.57	4.63	0.00509	0.00246	PASS
Extreme (50°C)		16.35	7.83	0.00870	0.00417	PASS
Extreme (40°C)		3.11	14.31	0.00165	0.00761	PASS
Extreme (30°C)		10.73	3.85	0.00571	0.00205	PASS
Extreme (20°C)		3.29	16.45	0.00175	0.00875	PASS
Extreme (10°C)		2.14	7.70	0.00114	0.00409	PASS
Extreme (0°C)		6.02	6.25	0.00320	0.00333	PASS
Extreme (-10°C)		8.50	11.46	0.00452	0.00609	PASS
Extreme (-20°C)		10.93	11.57	0.00582	0.00616	PASS
Extreme (-30°C)		3.16	15.90	0.00168	0.00846	PASS
25°C		LV	9.79	6.01	0.00521	0.00320
	HV	15.64	3.62	0.00832	0.00192	PASS

LTE Band 7, BANDWIDTH 20MHz						
Condition		Freq.Error (Hz)	Freq.Error (Hz)	Frequency Stability (ppm)	Frequency Stability (ppm)	Verdict
BANDWIDTH	5MHz					
Temperature	Voltage	16QAM	QPSK	16QAM	QPSK	
Normal (25°C)	Normal	6.94	3.40	0.00369	0.00181	PASS
Extreme (55°C)		7.33	2.49	0.00390	0.00133	PASS
Extreme (50°C)		7.68	7.04	0.00408	0.00374	PASS
Extreme (40°C)		13.03	6.37	0.00693	0.00339	PASS
Extreme (30°C)		10.78	2.06	0.00574	0.00110	PASS
Extreme (20°C)		1.42	12.66	0.00076	0.00674	PASS
Extreme (10°C)		17.86	13.88	0.00950	0.00738	PASS
Extreme (0°C)		13.80	12.15	0.00734	0.00646	PASS
Extreme (-10°C)		12.49	11.32	0.00664	0.00602	PASS
Extreme (-20°C)		6.08	2.62	0.00324	0.00139	PASS
Extreme (-30°C)		8.14	10.04	0.00433	0.00534	PASS
25°C		LV	12.30	12.02	0.00654	0.00639
	HV	2.79	6.12	0.00148	0.00325	PASS

5.7 Spurious Emissions at Antenna Terminals

Ambient condition

Temperature	Relative humidity	Pressure
23°C ~25°C	45%~50%	101.5kPa

Method of Measurement

The EUT was connected to Spectrum Analyzer and Base Station Simulator via power Splitter. The measurement is carried out using a spectrum analyzer. The spectrum analyzer scans from 9kHz to the 10th harmonic of the carrier. The peak detector is used.

RBW is set to 100kHz, VBW is set to 300kHz for 30MHz~1GHz

RBW is set to 1MHz, VBW is set to 3MHz for above 1GHz, Sweep is set to ATUO.

Of those disturbances below (limit – 20 dB), the mark is not required for the EUT.

The modulation mode and RB allocation refer to section 5.1, using the maximum output power configuration.

Test setup

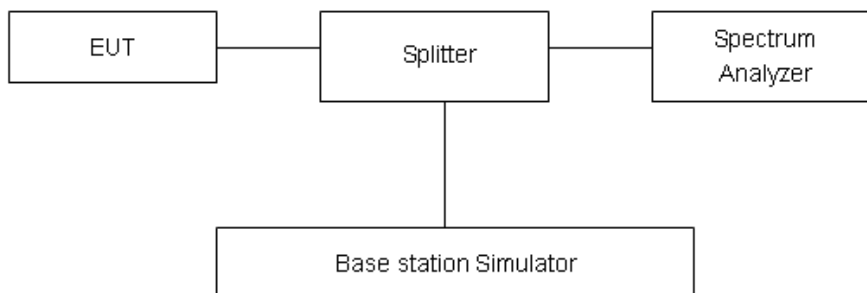

Limits

Rule Part 27.53(h) specifies that “for operations in the 1695-1710 MHz, 1710-1755 MHz, 1755-1780 MHz, 1915-1920 MHz, 1995-2000 MHz, 2000-2020 MHz, 2110-2155 MHz, 2155-2180 MHz, and 2180-2200 bands, the power of any emission outside a licensee's frequency block shall be attenuated below the transmitter power (P) in watts by at least $43 + 10 \log_{10}(P)$ dB..”

Rule Part 27.53(m) $55 + 10 \log(P)$ dB on all frequencies more than X megahertz from the channel edge, where X is the greater of 6 megahertz or the actual emission bandwidth as defined in paragraph (m)(4) of this section.

Part 27.53(h) Limit	-13 dBm
Part 27.53(m) Limit	-25 dBm

**Measurement Uncertainty**

The assessed measurement uncertainty to ensure 99.75% confidence level for the normal distribution is with the coverage factor $k = 1.96$.

Frequency	Uncertainty
9kHz-1GHz	0.684 dB
1GHz-27GHz	1.407 dB

Test Result

Sweep the whole frequency band through the range from 9kHz to the 10th harmonic of the carrier, the emissions more than 20 dB below the limit are not reported.

The signal beyond the limit is carrier.

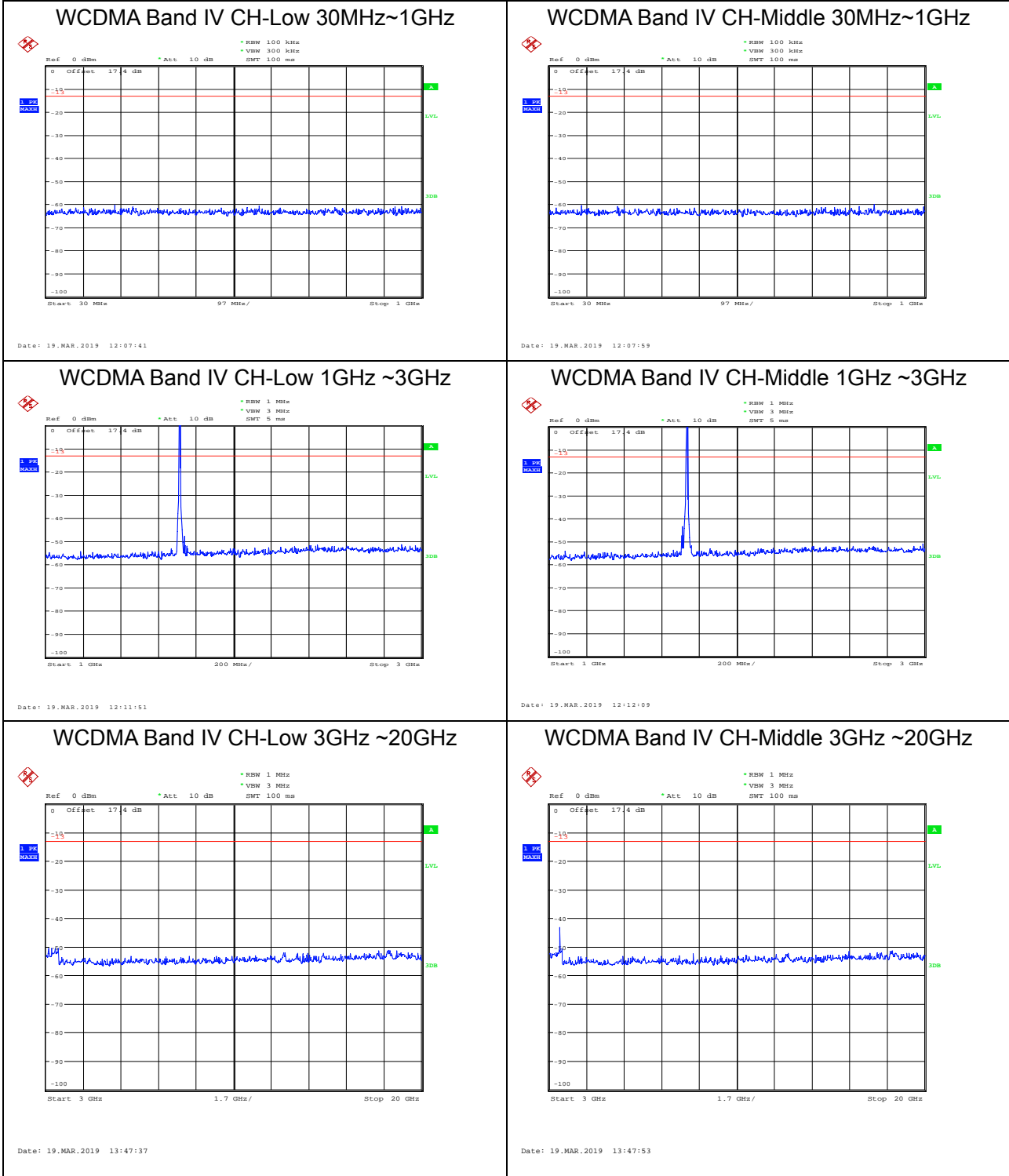



WCDMA Band IV CH-High 30MHz~1GHz

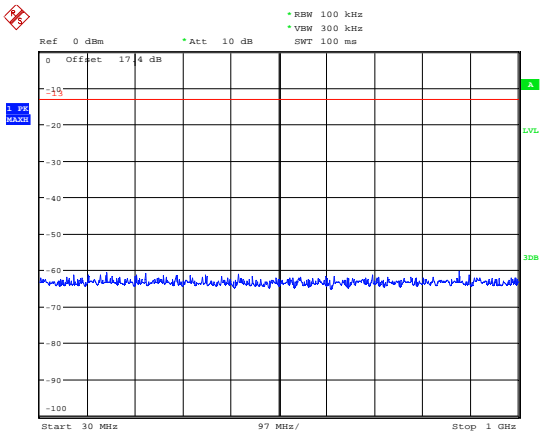

Date: 19.MAR.2019 12:08:18

WCDMA Band IV CH-High 1GHz ~3GHz

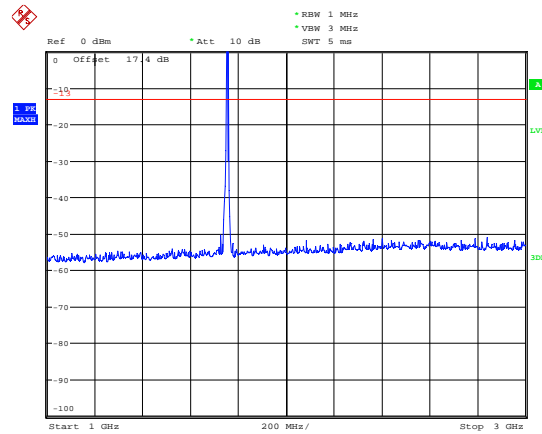

Date: 19.MAR.2019 12:12:35

WCDMA Band IV CH-High 3GHz ~20GHz

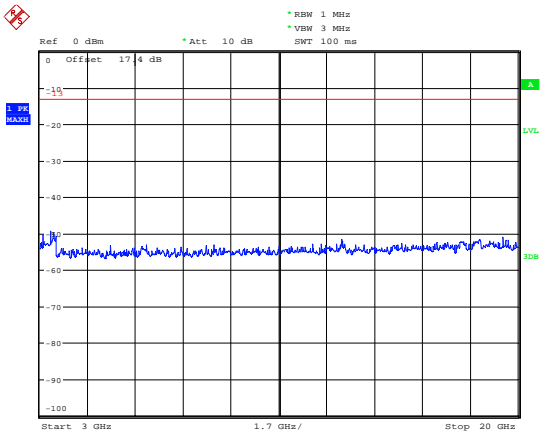

Date: 19.MAR.2019 13:48:11

LTE Band 4 1.4MHz CH-Low 30MHz~1GHz

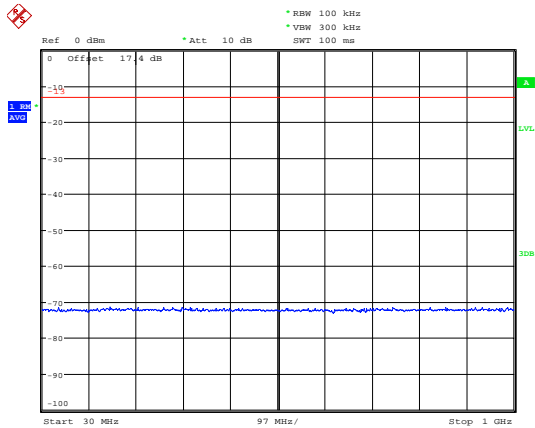

Date: 24.MAR.2019 10:23:09

LTE Band 4 1.4MHz CH-Middle 30MHz~1GHz

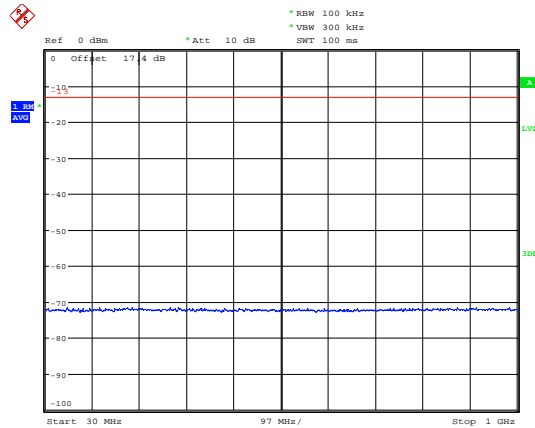

Date: 24.MAR.2019 10:23:27

LTE Band 4 1.4MHz CH-Low 1GHz~3GHz

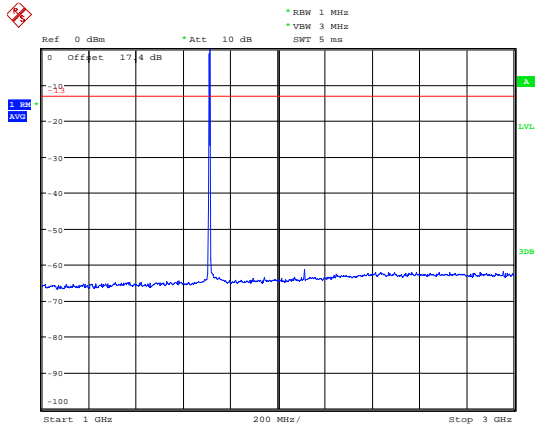

Date: 24.MAR.2019 10:27:58

LTE Band 4 1.4MHz CH-Middle 1GHz~3GHz

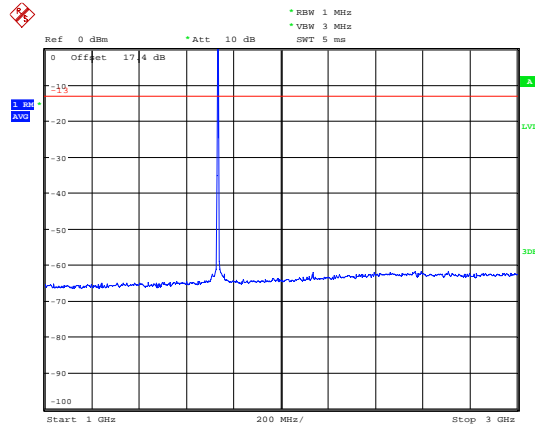

Date: 24.MAR.2019 10:28:10

LTE Band 4 1.4MHz CH-Low 3GHz~20GHz

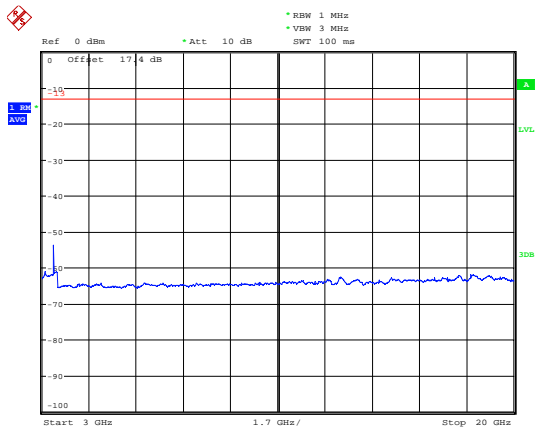

Date: 24.MAR.2019 15:13:31

LTE Band 4 1.4MHz CH-Middle 3GHz~20GHz

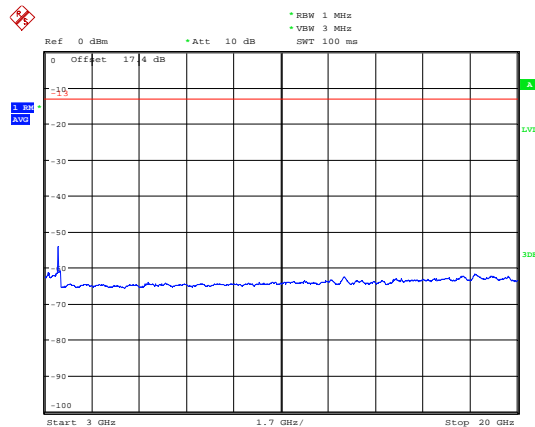

Date: 24.MAR.2019 15:13:55



LTE Band 4 1.4MHz CH-High 30MHz~1GHz

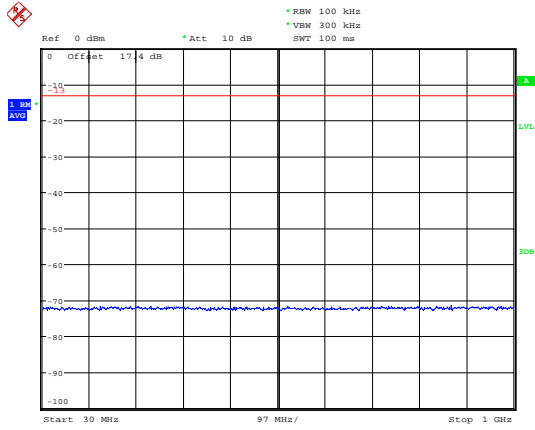

Date: 24.MAR.2019 10:23:41

LTE Band 4 3MHz CH-Low 30MHz~1GHz

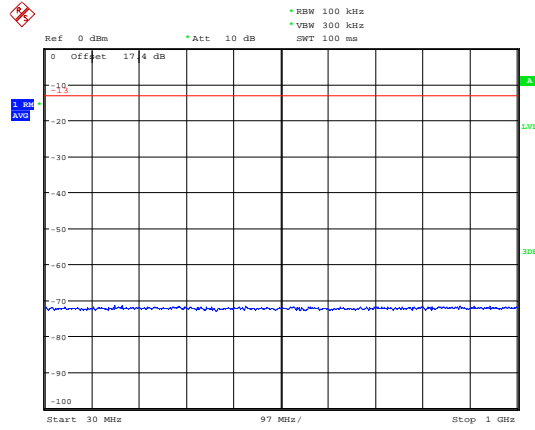

Date: 24.MAR.2019 10:23:56

LTE Band 4 1.4MHz CH-High 1GHz~3GHz

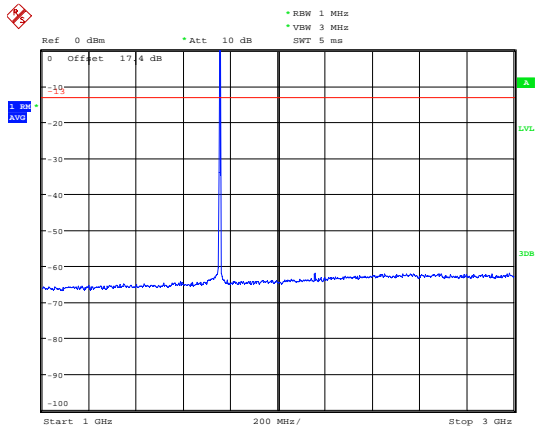

Date: 24.MAR.2019 10:28:24

LTE Band 4 3MHz CH-Low 1GHz~3GHz

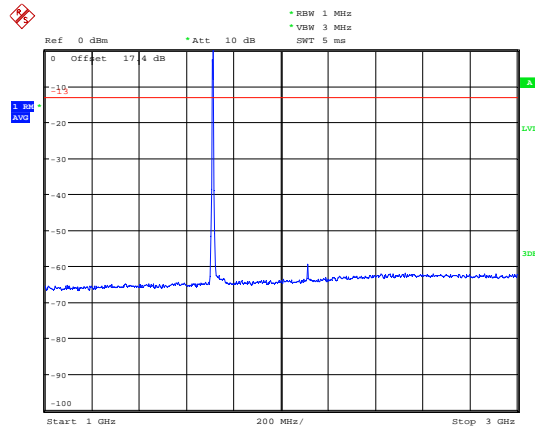

Date: 24.MAR.2019 10:28:50

LTE Band 4 1.4MHz CH-High 3GHz~20GHz

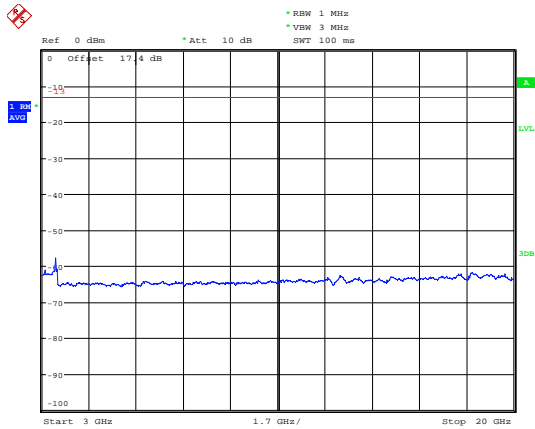

Date: 24.MAR.2019 15:14:11

LTE Band 4 3MHz CH-Low 3GHz~20GHz

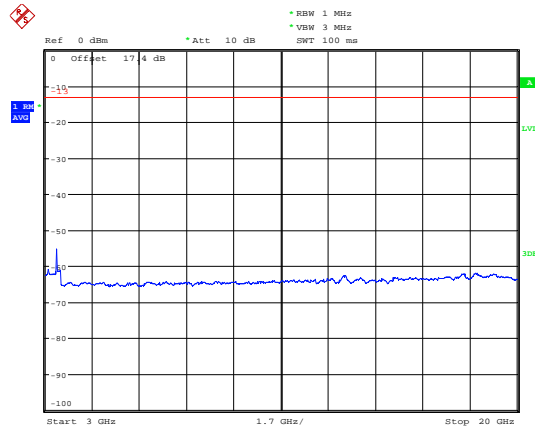

Date: 24.MAR.2019 15:14:44

LTE Band 4 3MHz CH-Middle 30MHz~1GHz

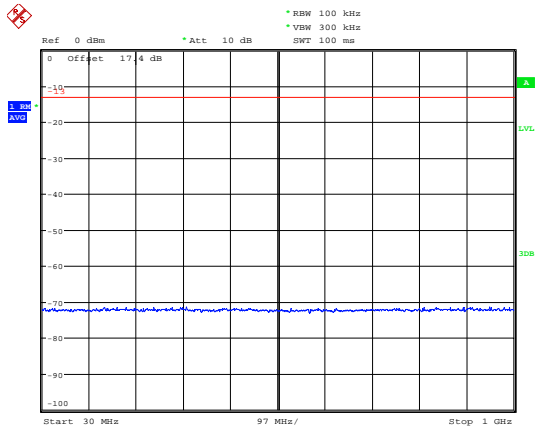

Date: 24.MAR.2019 10:24:06

LTE Band 4 3MHz CH-High 30MHz~1GHz

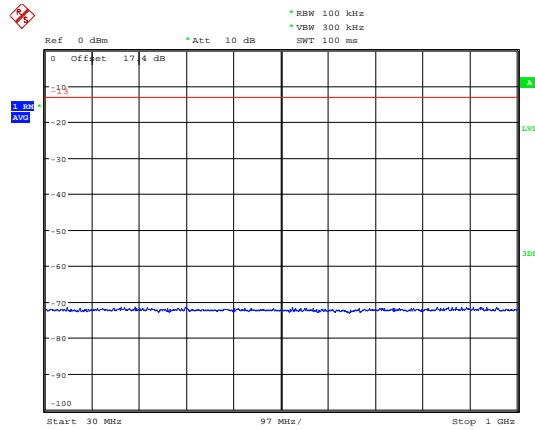

Date: 24.MAR.2019 10:24:23

LTE Band 4 3MHz CH-Middle 1GHz~3GHz

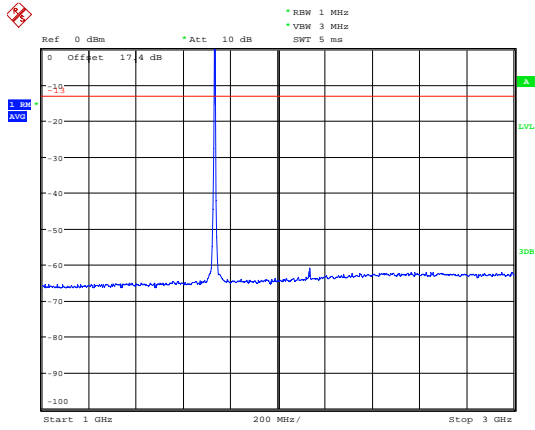

Date: 24.MAR.2019 10:29:12

LTE Band 4 3MHz CH-High 1GHz~3GHz

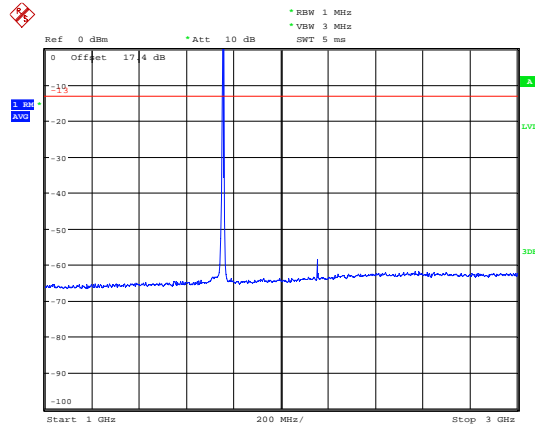

Date: 24.MAR.2019 10:29:25

LTE Band 4 3MHz CH-Middle 3GHz~20GHz

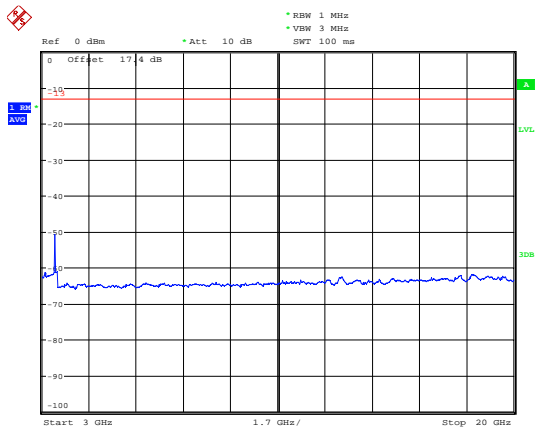

Date: 24.MAR.2019 15:14:56

LTE Band 4 3MHz CH-High 3GHz~20GHz

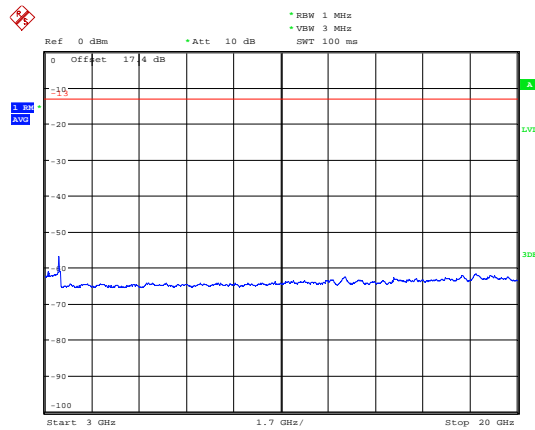

Date: 24.MAR.2019 15:15:16



LTE Band 4 5MHz CH-Low 30MHz~1GHz

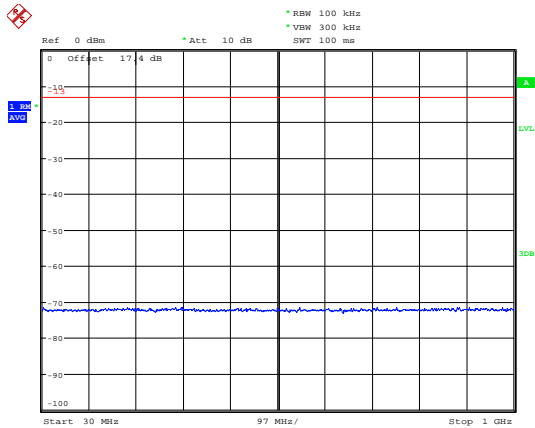

Date: 24.MAR.2019 10:24:37

LTE Band 4 5MHz CH-Middle 30MHz~1GHz

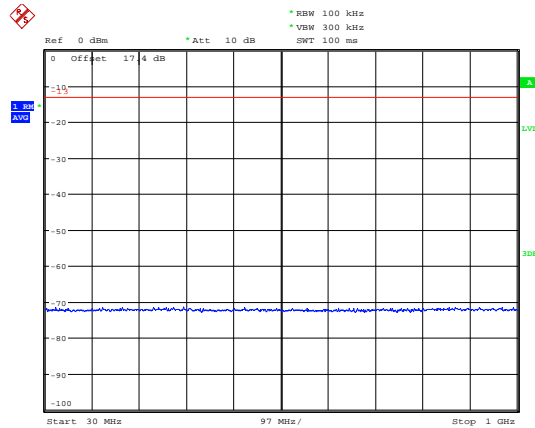

Date: 24.MAR.2019 10:24:47

LTE Band 4 5MHz CH-Low 1GHz~3GHz

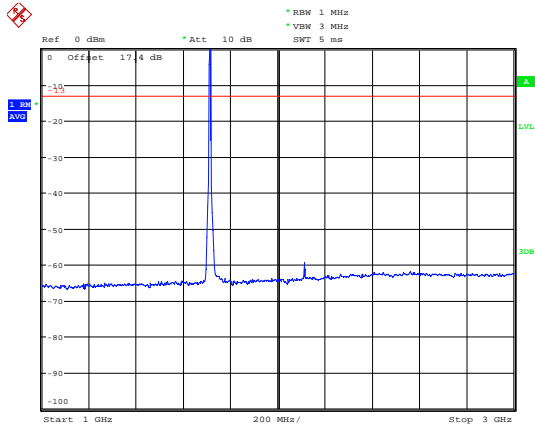

Date: 24.MAR.2019 10:29:46

LTE Band 4 5MHz CH-Middle 1GHz~3GHz

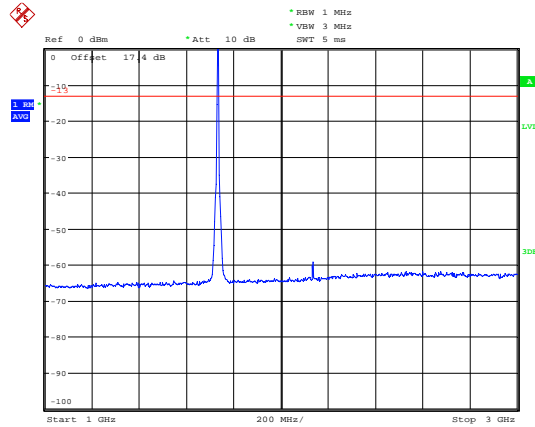

Date: 24.MAR.2019 10:29:57

LTE Band 4 5MHz CH-Low 3GHz~20GHz

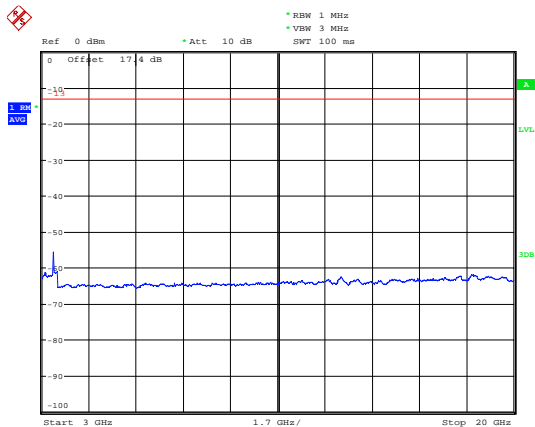

Date: 24.MAR.2019 15:15:44

LTE Band 4 5MHz CH-Middle 3GHz~20GHz

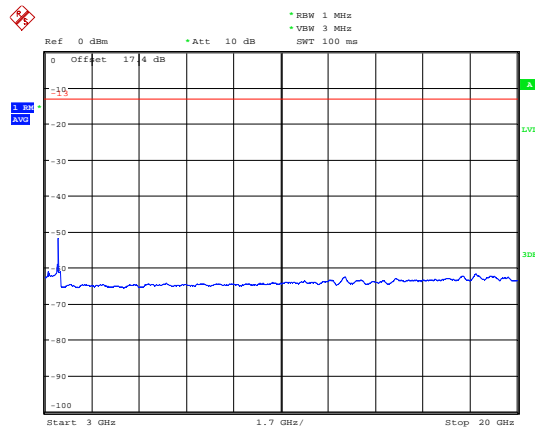

Date: 24.MAR.2019 15:16:00

LTE Band 4 5MHz CH-High 30MHz~1GHz

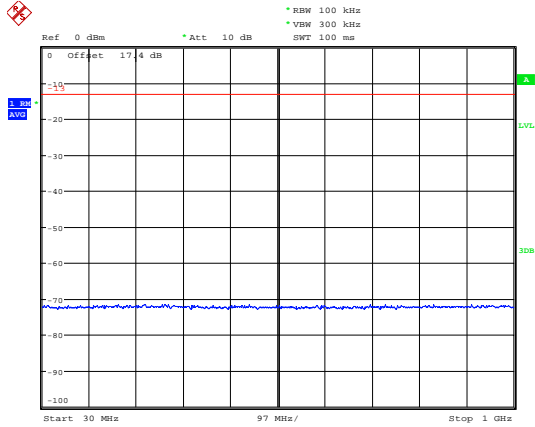

Date: 24.MAR.2019 10:24:57

LTE Band 4 10MHz CH-Low 30MHz~1GHz

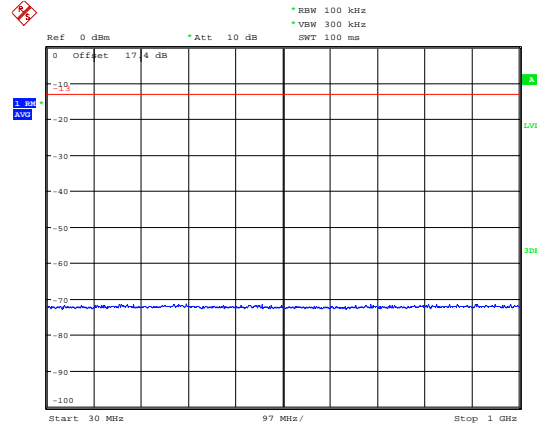

Date: 24.MAR.2019 10:25:13

LTE Band 4 5MHz CH-High 1GHz~3GHz

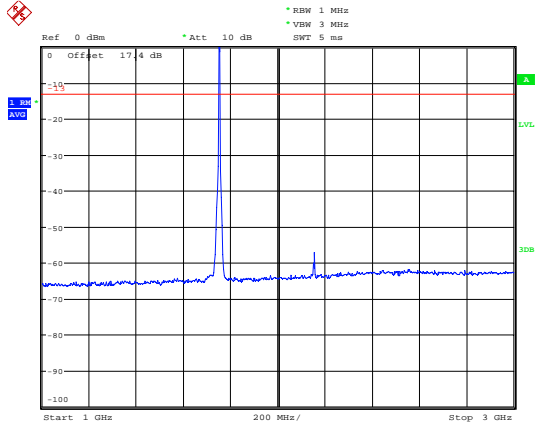

Date: 24.MAR.2019 10:30:18

LTE Band 4 10MHz CH-Low 1GHz~3GHz

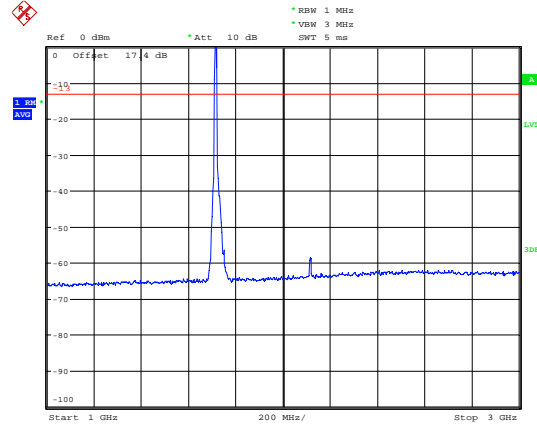

Date: 24.MAR.2019 10:30:36

LTE Band 4 5MHz CH-High 3GHz~20GHz

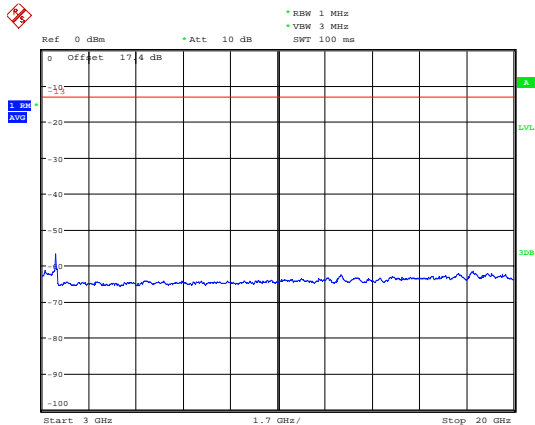

Date: 24.MAR.2019 15:16:13

LTE Band 4 10MHz CH-Low 3GHz~20GHz

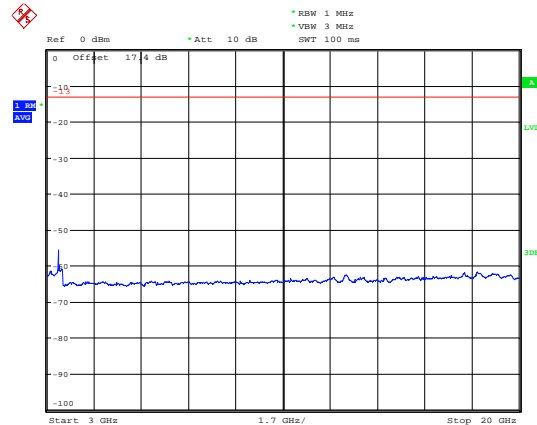

Date: 24.MAR.2019 15:16:35

LTE Band 4 10MHz CH-Middle 30MHz~1GHz

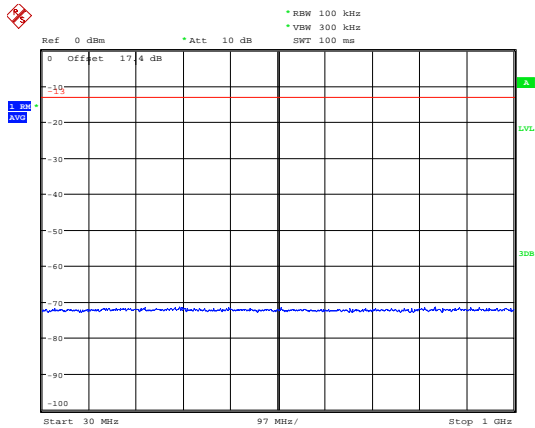

Date: 24.MAR.2019 10:25:36

LTE Band 4 10MHz CH-High 30MHz~1GHz

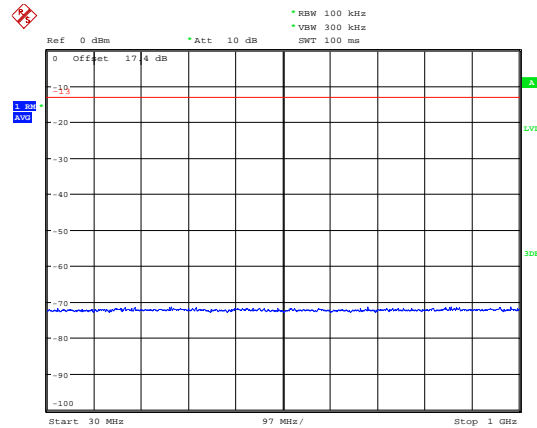

Date: 24.MAR.2019 10:25:48

LTE Band 4 10MHz CH-Middle 1GHz~3GHz

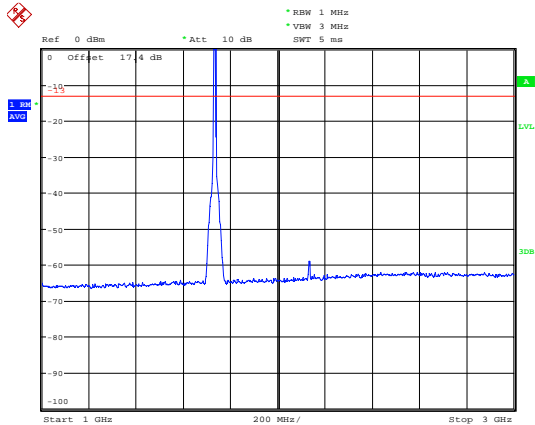

Date: 24.MAR.2019 10:30:57

LTE Band 4 10MHz CH-High 1GHz~3GHz

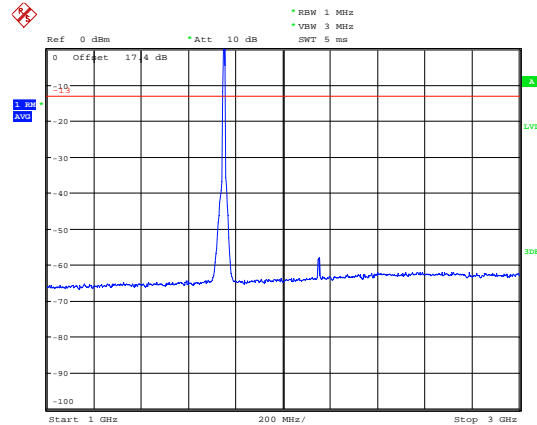

Date: 24.MAR.2019 10:31:11

LTE Band 4 10MHz CH-Middle 3GHz~20GHz

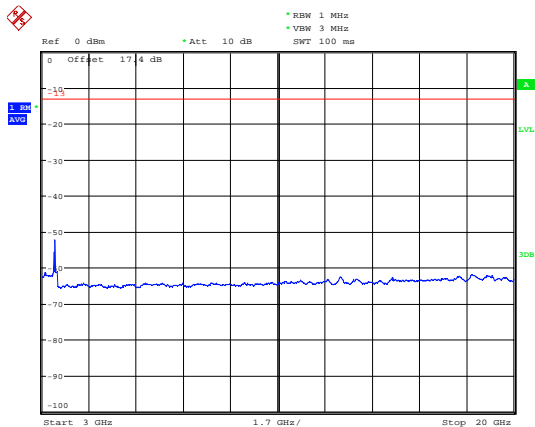

Date: 24.MAR.2019 15:16:49

LTE Band 4 10MHz CH-High 3GHz~20GHz

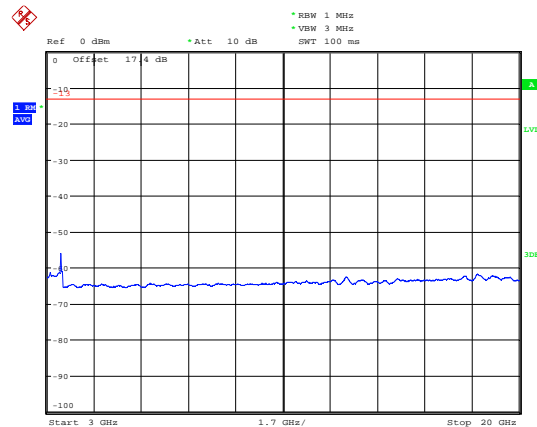

Date: 24.MAR.2019 15:17:13



LTE Band 4 15MHz CH-Low 30MHz~1GHz

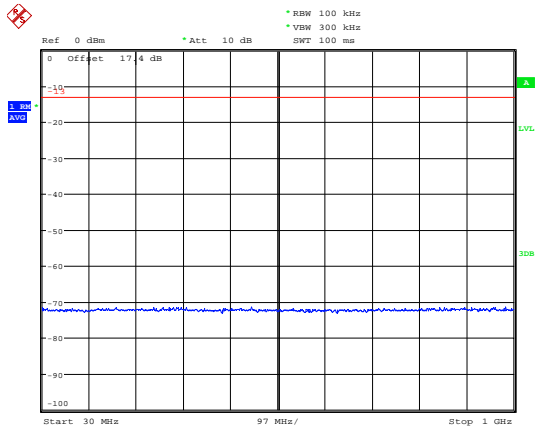

Date: 24.MAR.2019 10:26:02

LTE Band 4 15MHz CH-Middle 30MHz~1GHz

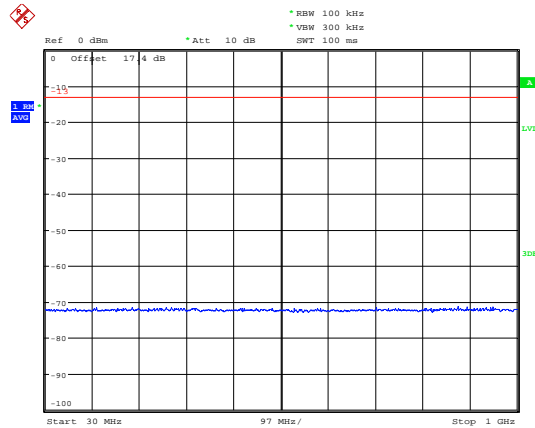

Date: 24.MAR.2019 10:26:32

LTE Band 4 15MHz CH-Low 1GHz~3GHz

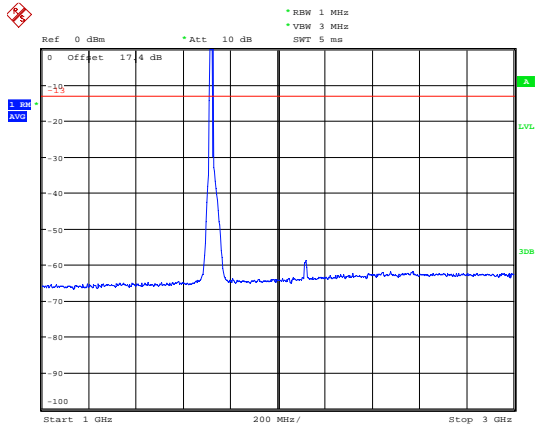

Date: 24.MAR.2019 10:31:33

LTE Band 4 15MHz CH-Middle 1GHz~3GHz

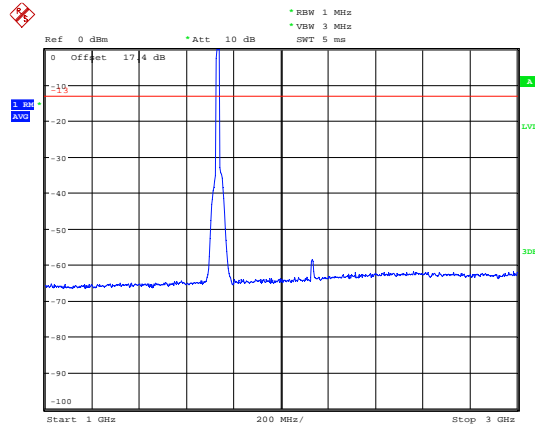

Date: 24.MAR.2019 10:31:43

LTE Band 4 15MHz CH-Low 3GHz~20GHz

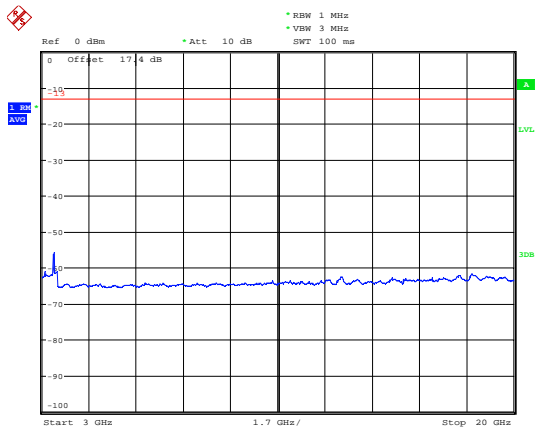

Date: 24.MAR.2019 15:17:41

LTE Band 4 15MHz CH-Middle 3GHz~20GHz

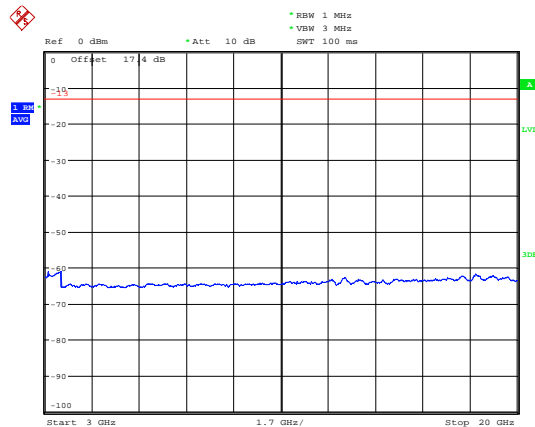

Date: 24.MAR.2019 15:17:55



LTE Band 4 15MHz CH-High 30MHz~1GHz

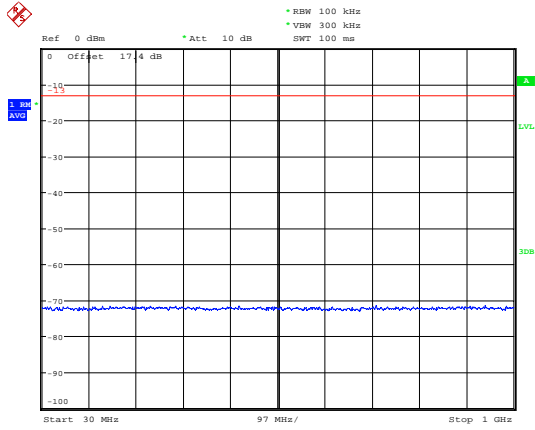

Date: 24.MAR.2019 10:26:51

LTE Band 4 20MHz CH-Low 30MHz~1GHz

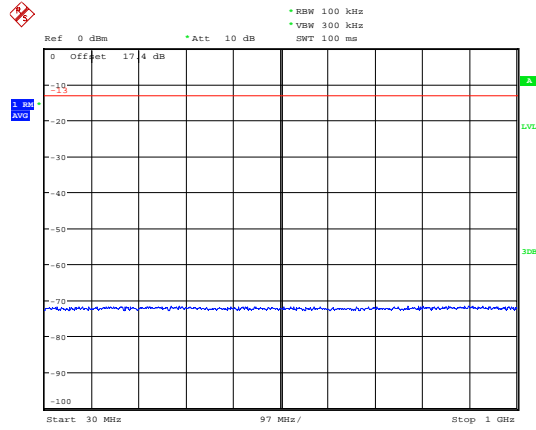

Date: 24.MAR.2019 10:27:09

LTE Band 4 15MHz CH-High 1GHz~3GHz

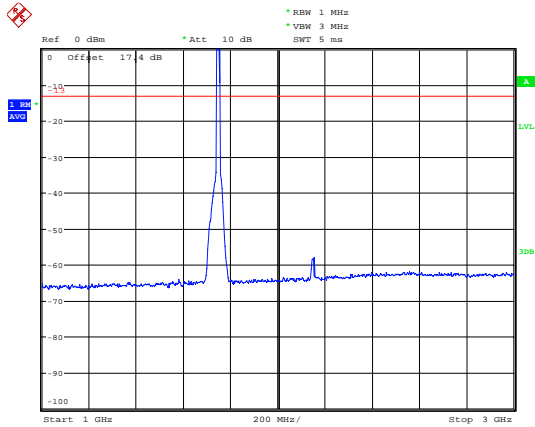

Date: 24.MAR.2019 10:32:09

LTE Band 4 20MHz CH-Low 1GHz~3GHz

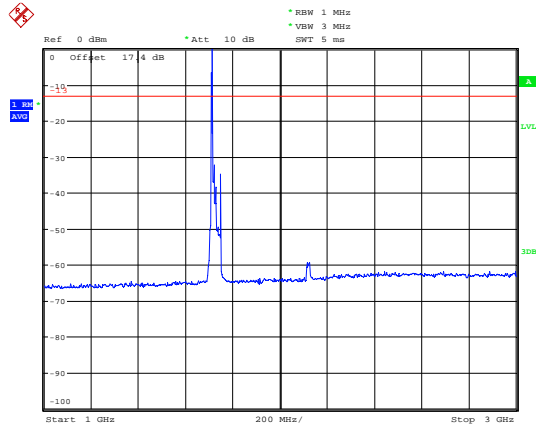

Date: 24.MAR.2019 10:32:26

LTE Band 4 15MHz CH-High 3GHz~20GHz

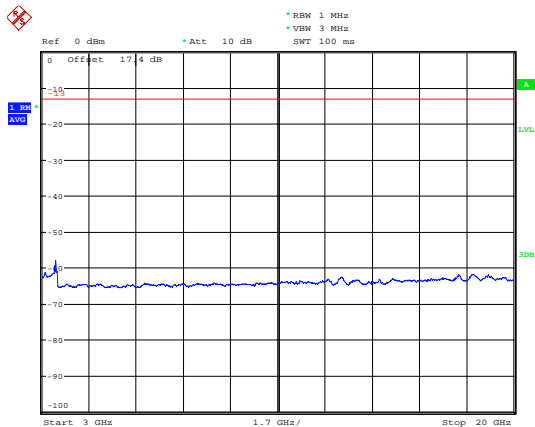

Date: 24.MAR.2019 15:18:19

LTE Band 4 20MHz CH-Low 3GHz~20GHz

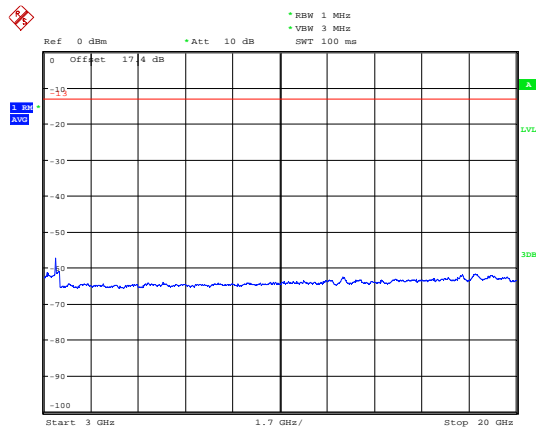

Date: 24.MAR.2019 15:18:50



LTE Band 4 20MHz CH-Middle 30MHz~1GHz

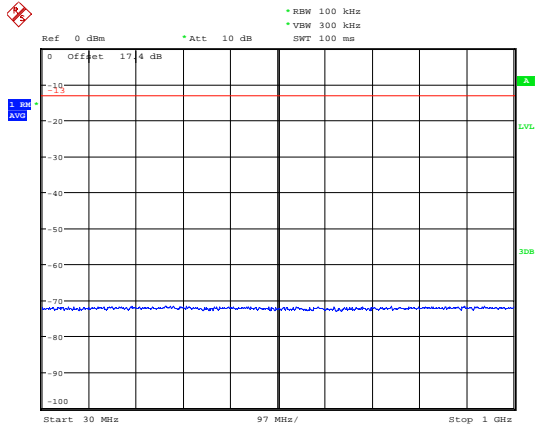

Date: 24.MAR.2019 10:27:18

LTE Band 4 20MHz CH-High 30MHz~1GHz

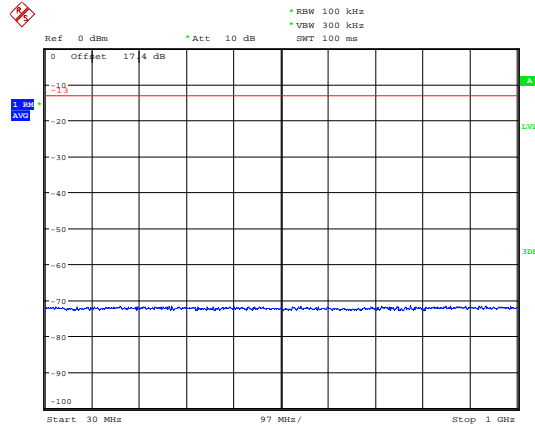

Date: 24.MAR.2019 10:27:30

LTE Band 4 20MHz CH-Middle 1GHz~3GHz

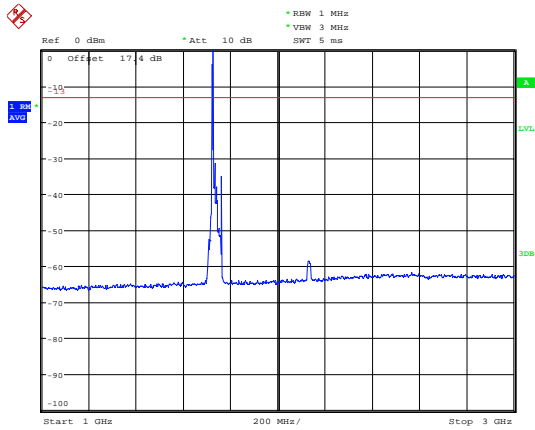

Date: 24.MAR.2019 10:32:36

LTE Band 4 20MHz CH-High 1GHz~3GHz

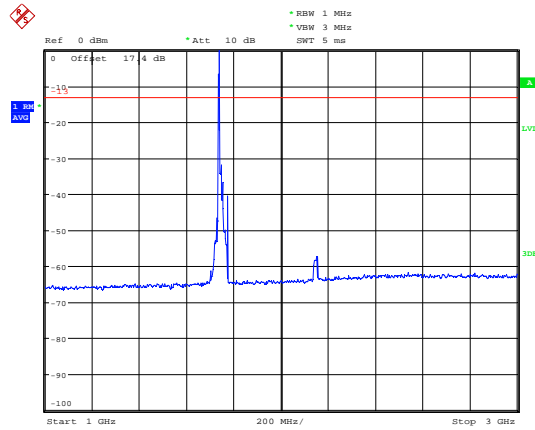

Date: 24.MAR.2019 10:32:48

LTE Band 4 20MHz CH-Middle 3GHz~20GHz

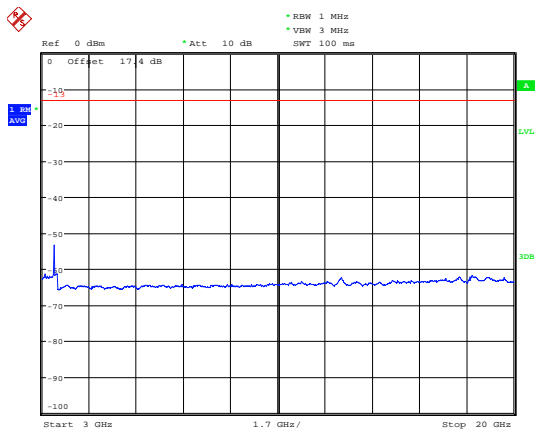

Date: 24.MAR.2019 15:19:04

LTE Band 4 20MHz CH-High 3GHz~20GHz

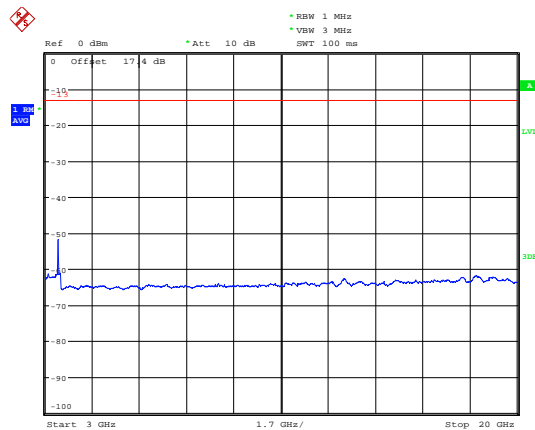

Date: 24.MAR.2019 15:19:16



LTE Band 7 5MHz CH-Low 30MHz~1GHz

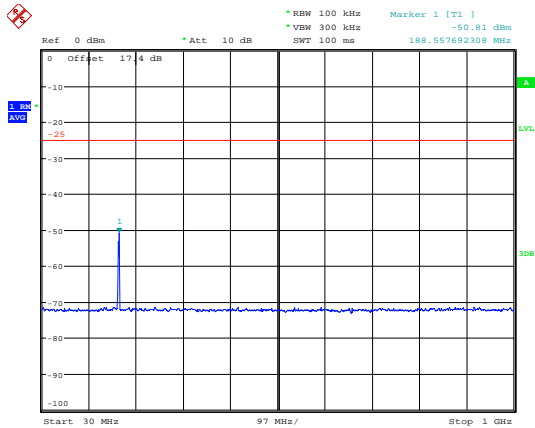

Date: 24.MAR.2019 17:07:19

LTE Band 7 5MHz CH-Middle 30MHz~1GHz

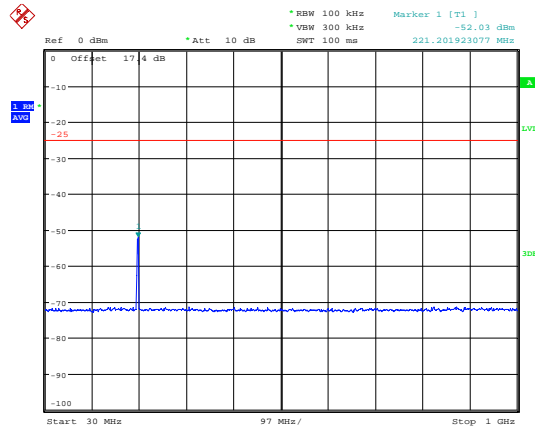

Date: 24.MAR.2019 17:07:45

LTE Band 7 5MHz CH-Low 1GHz~3GHz

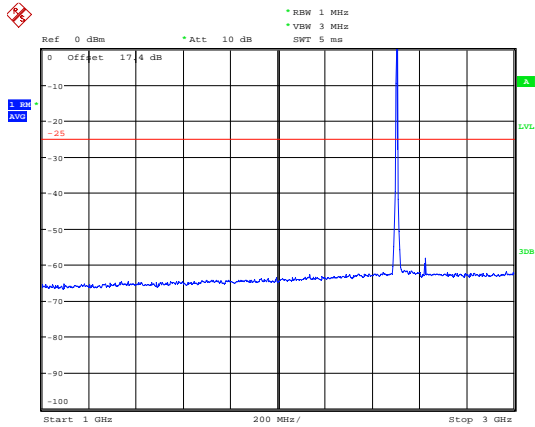

Date: 24.MAR.2019 17:14:21

LTE Band 7 5MHz CH-Middle 1GHz~3GHz

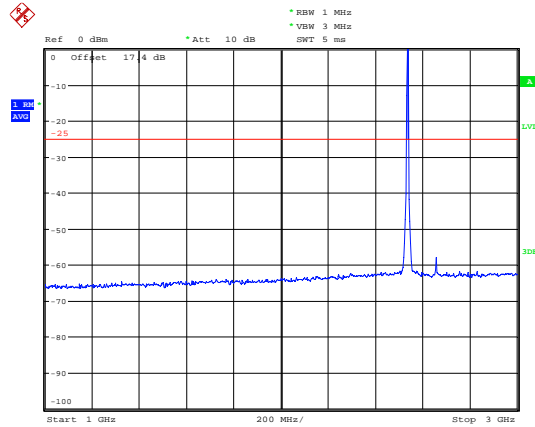

Date: 24.MAR.2019 17:14:32

LTE Band 7 5MHz CH-Low 3GHz~26GHz

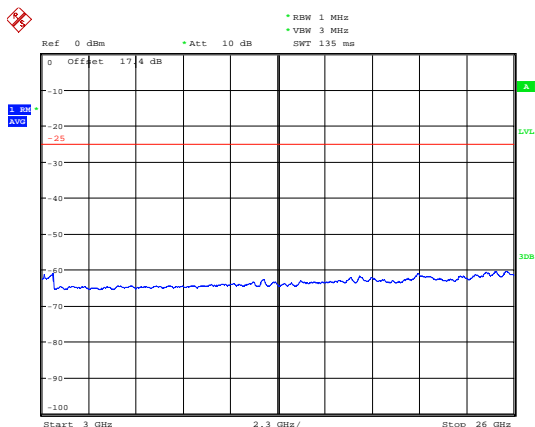

Date: 24.MAR.2019 17:15:57

LTE Band 7 5MHz CH-Middle 3GHz~26GHz

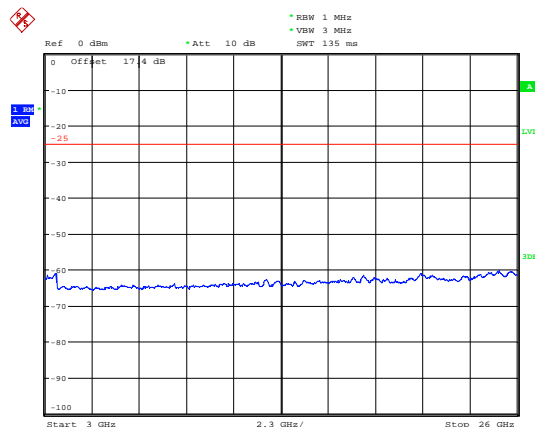

Date: 24.MAR.2019 17:15:42



LTE Band 7 5MHz CH-High 30MHz~1GHz

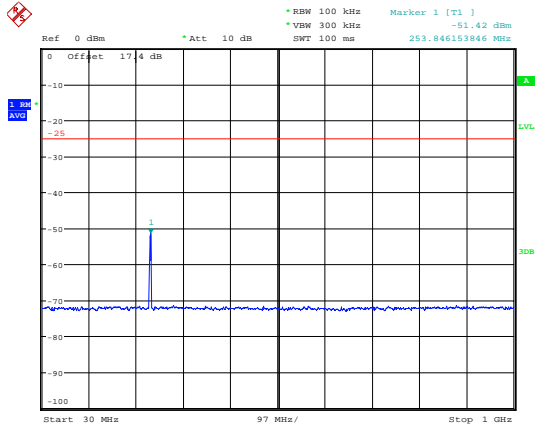

Date: 24.MAR.2019 17:08:34

LTE Band 7 10MHz CH-Low 30MHz~1GHz

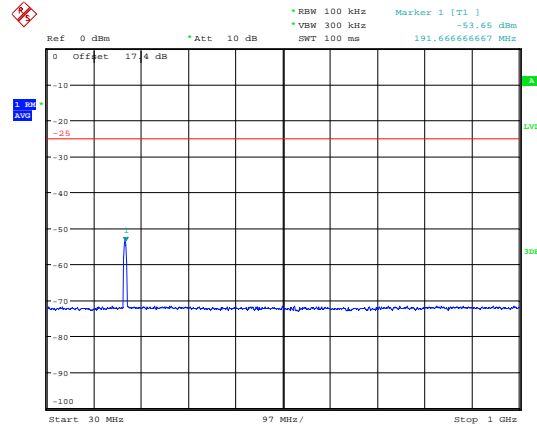

Date: 24.MAR.2019 17:08:57

LTE Band 7 5MHz CH-High 1GHz~3GHz

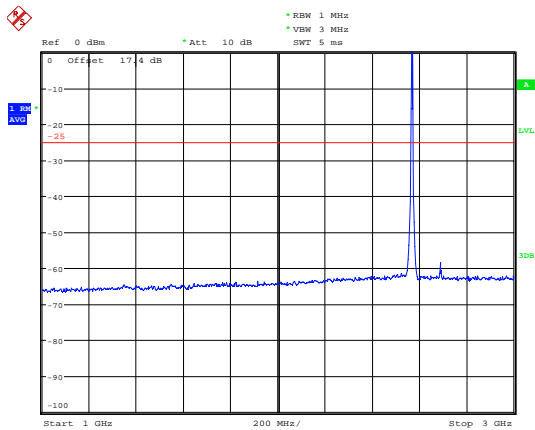

Date: 24.MAR.2019 17:14:44

LTE Band 7 10MHz CH-Low 1GHz~3GHz

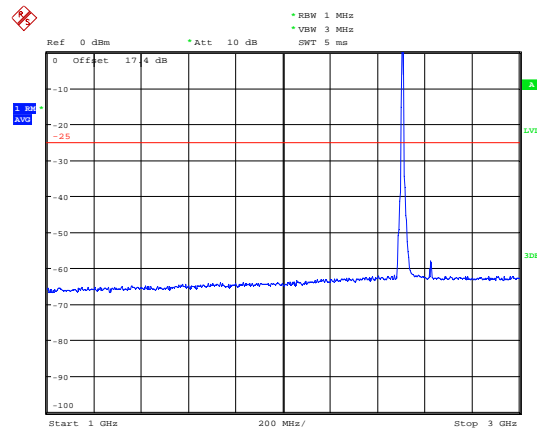

Date: 24.MAR.2019 17:13:40

LTE Band 7 5MHz CH-High 3GHz~26GHz

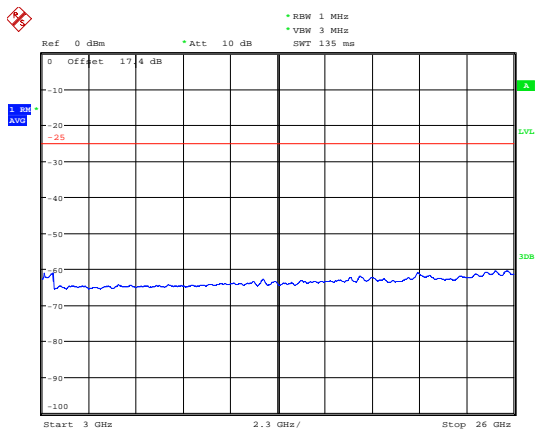

Date: 24.MAR.2019 17:15:30

LTE Band 7 10MHz CH-Low 3GHz~26GHz

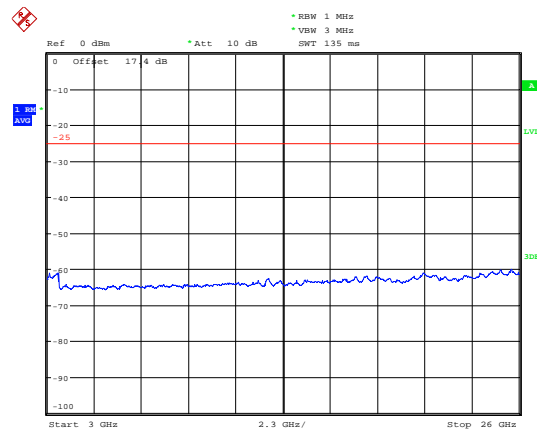

Date: 24.MAR.2019 17:16:15

LTE Band 7 10MHz CH-Middle 30MHz~1GHz

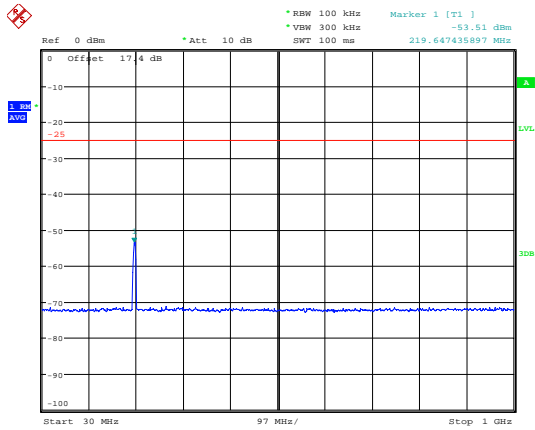

Date: 24.MAR.2019 17:09:16

LTE Band 7 10MHz CH-High 30MHz~1GHz

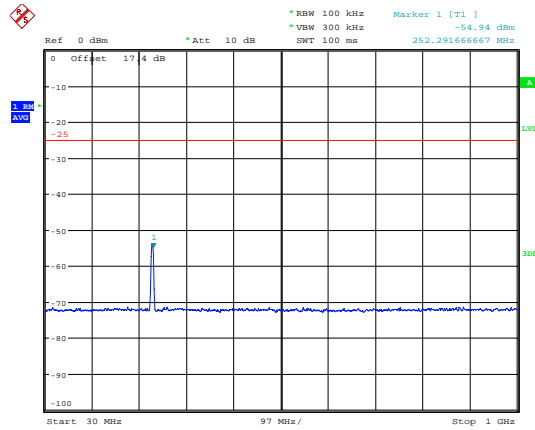

Date: 24.MAR.2019 17:09:35

LTE Band 7 10MHz CH-Middle 1GHz~3GHz

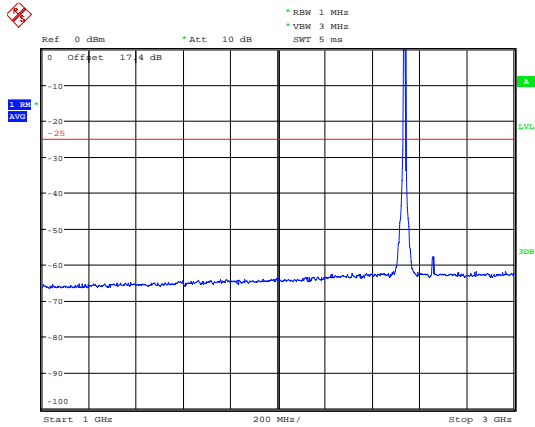

Date: 24.MAR.2019 17:13:51

LTE Band 7 10MHz CH-High 1GHz~3GHz

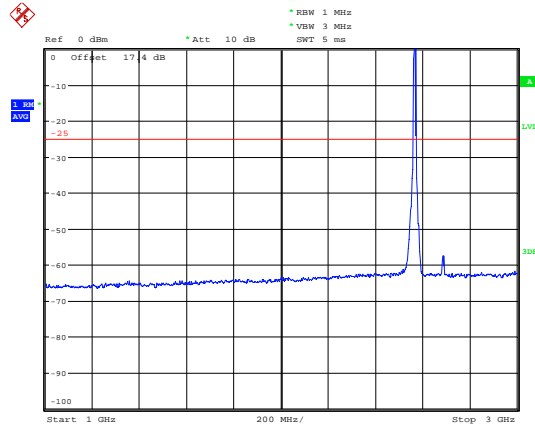

Date: 24.MAR.2019 17:14:03

LTE Band 7 10MHz CH-Middle 3GHz~26GHz

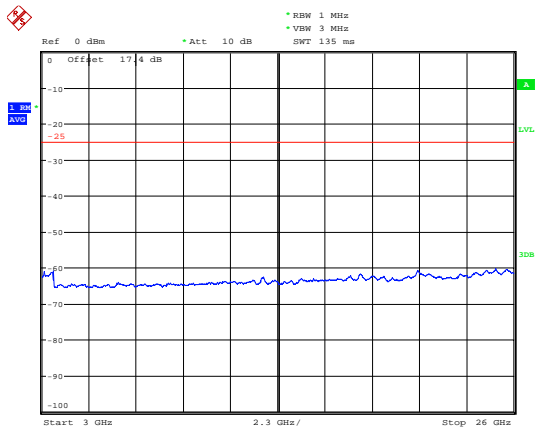

Date: 24.MAR.2019 17:16:29

LTE Band 7 10MHz CH-High 3GHz~26GHz

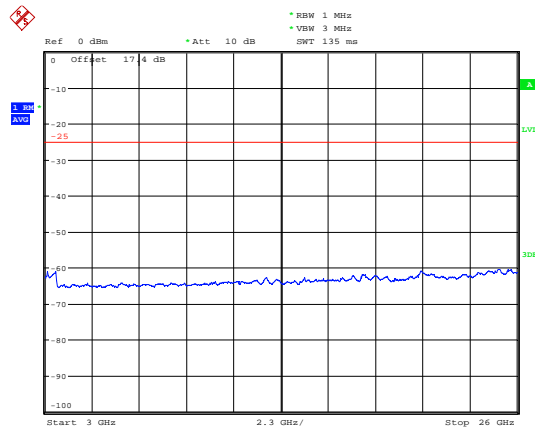

Date: 24.MAR.2019 17:16:53

LTE Band 7 15MHz CH-Low 30MHz~1GHz

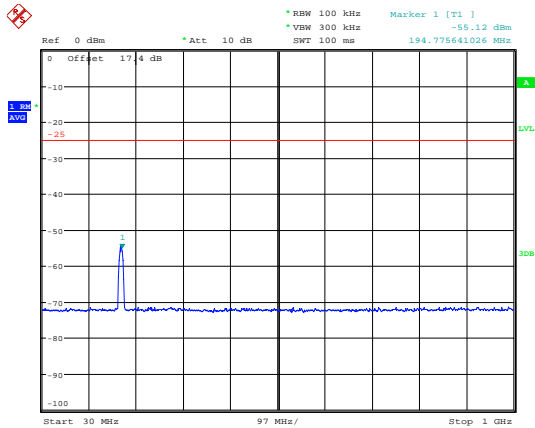

Date: 24.MAR.2019 17:09:56

LTE Band 7 15MHz CH-Middle 30MHz~1GHz

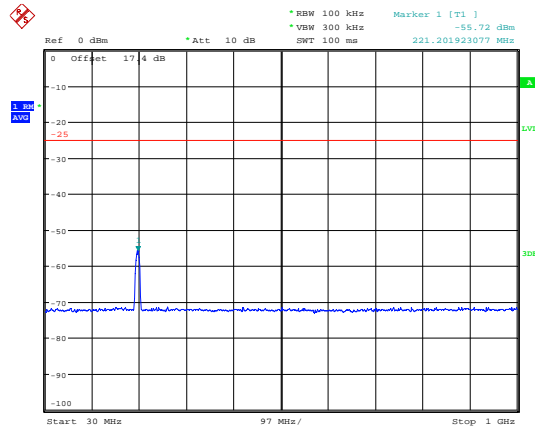

Date: 24.MAR.2019 17:10:15

LTE Band 7 15MHz CH-Low 1GHz~3GHz

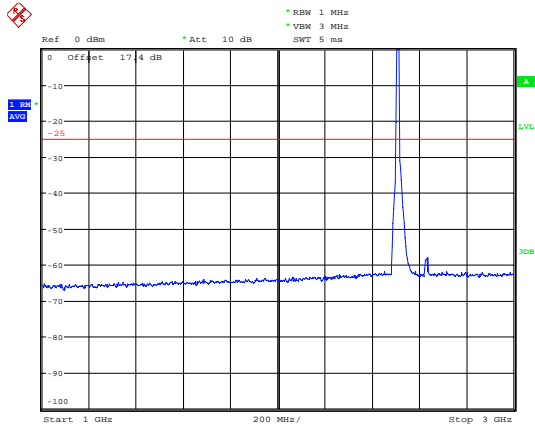

Date: 24.MAR.2019 17:12:54

LTE Band 7 15MHz CH-Middle 1GHz~3GHz

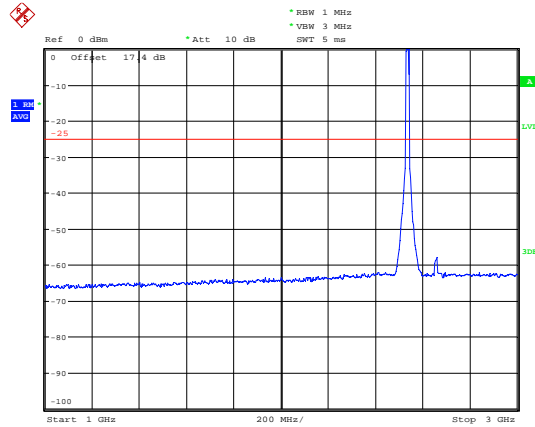

Date: 24.MAR.2019 17:13:05

LTE Band 7 15MHz CH-Low 3GHz~26GHz

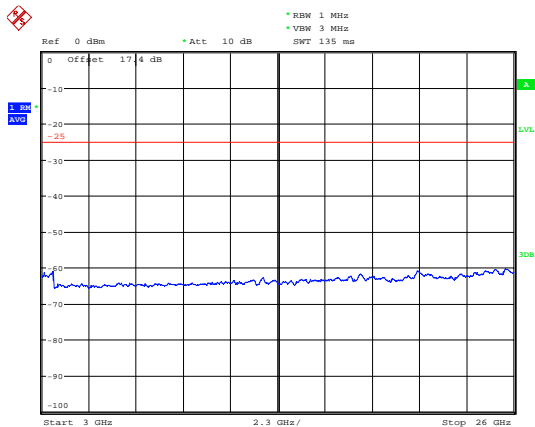

Date: 24.MAR.2019 17:17:15

LTE Band 7 15MHz CH-Middle 3GHz~26GHz

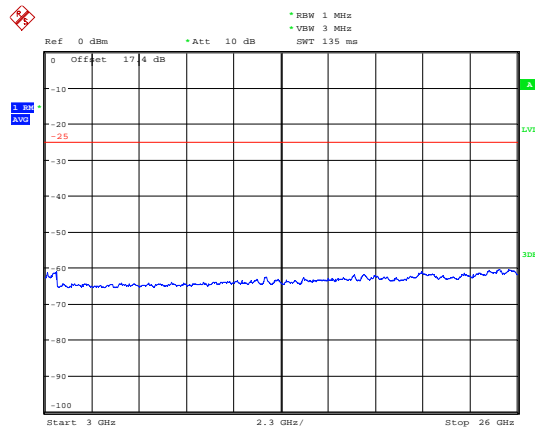

Date: 24.MAR.2019 17:17:28



LTE Band 7 15MHz CH-High 30MHz~1GHz

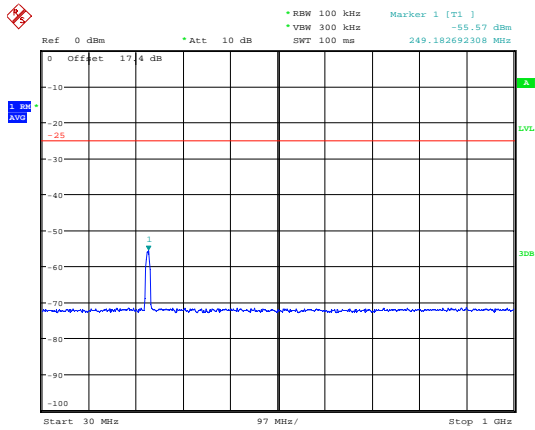

Date: 24.MAR.2019 17:10:30

LTE Band 7 20MHz CH-Low 30MHz~1GHz

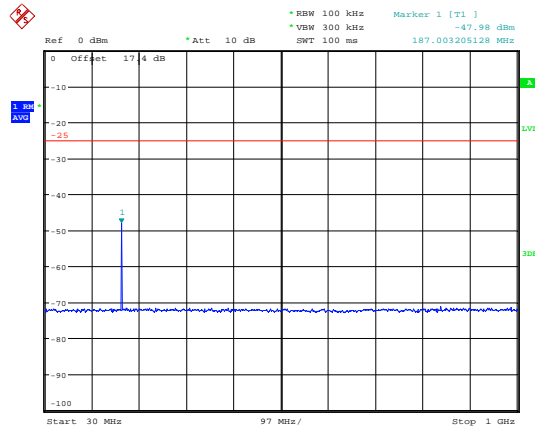

Date: 24.MAR.2019 17:11:05

LTE Band 7 15MHz CH-High 1GHz~3GHz

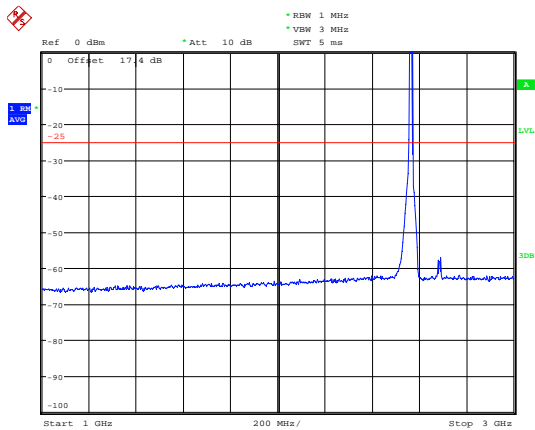

Date: 24.MAR.2019 17:13:17

LTE Band 7 20MHz CH-Low 1GHz~3GHz

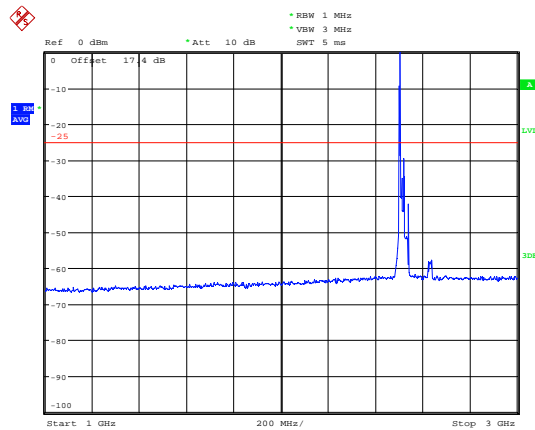

Date: 24.MAR.2019 17:12:29

LTE Band 7 15MHz CH-High 3GHz~26GHz

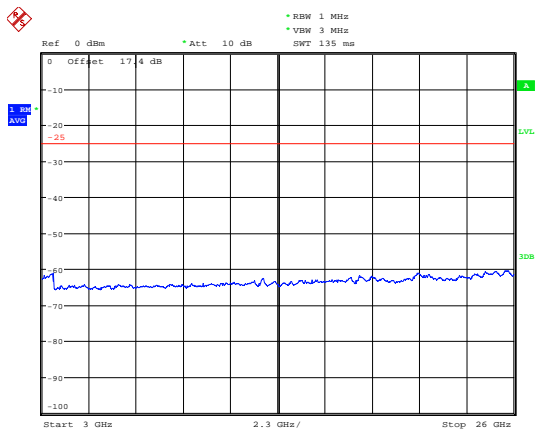

Date: 24.MAR.2019 17:17:41

LTE Band 7 20MHz CH-Low 3GHz~26GHz

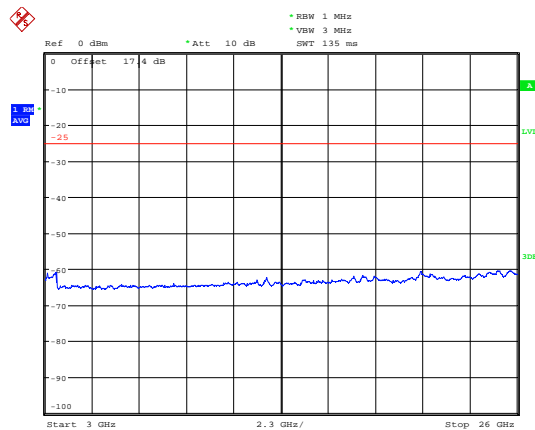

Date: 24.MAR.2019 17:18:01

LTE Band 7 20MHz CH-Middle 30MHz~1GHz

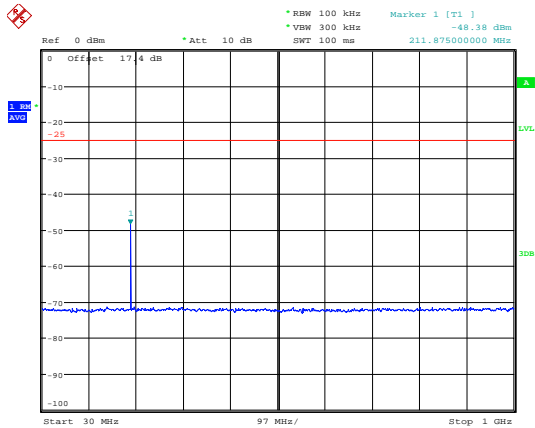

Date: 24.MAR.2019 17:11:24

LTE Band 7 20MHz CH-High 30MHz~1GHz

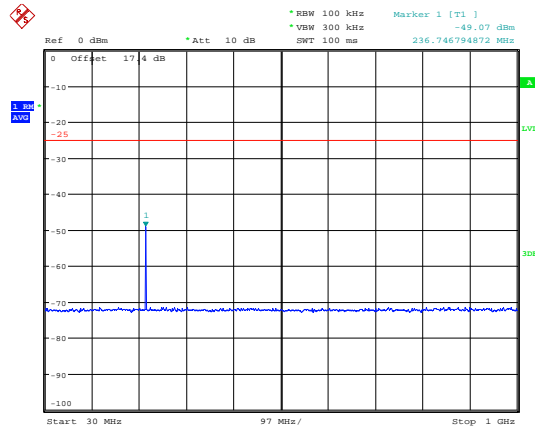

Date: 24.MAR.2019 17:11:38

LTE Band 7 20MHz CH-Middle 1GHz~3GHz

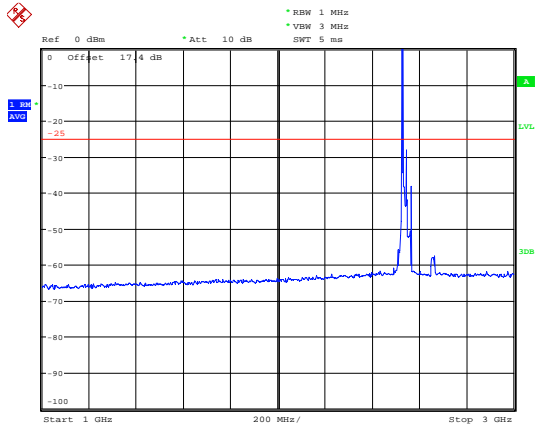

Date: 24.MAR.2019 17:12:17

LTE Band 7 20MHz CH-High 1GHz~3GHz

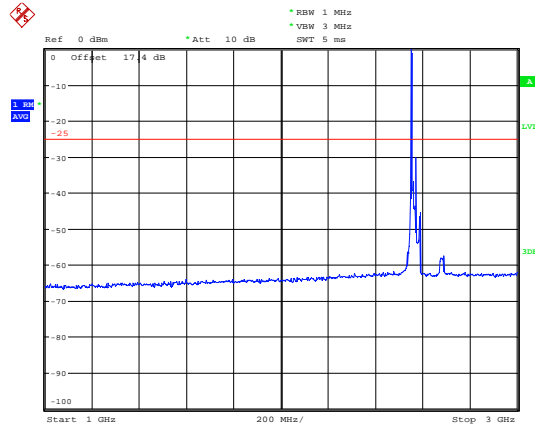

Date: 24.MAR.2019 17:12:06

LTE Band 7 20MHz CH-Middle 3GHz~26GHz

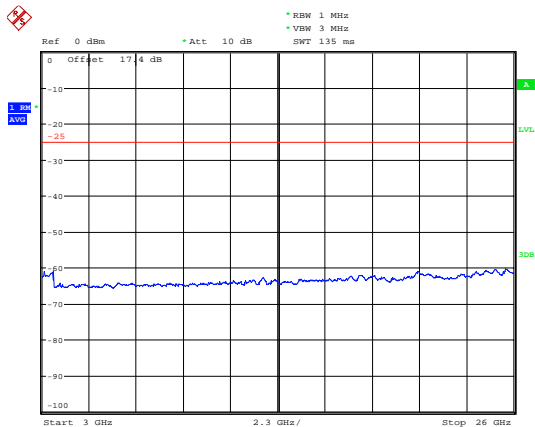

Date: 24.MAR.2019 17:18:11

LTE Band 7 20MHz CH-High 3GHz~26GHz

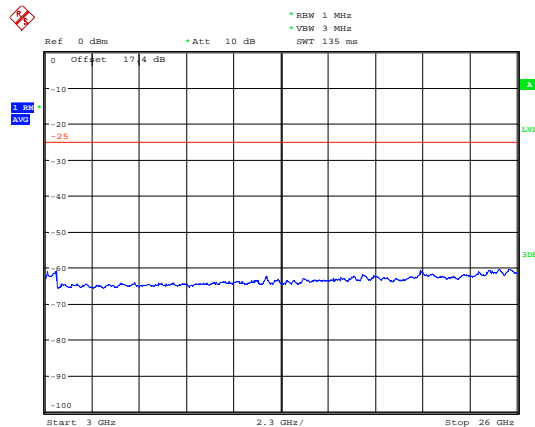

Date: 24.MAR.2019 17:18:24

5.8 Radiates Spurious Emission

Ambient condition

Temperature	Relative humidity	Pressure
23°C ~25°C	45%~50%	101.5kPa

Method of Measurement

- The testing follows FCC KDB 971168 D01 v03r01 Section 5.8 and ANSI C63.26 (2015).
- Below 1GHz: The EUT is placed on a turntable 0.8 meters above the ground in the chamber, 3 meter away from the antenna. The maximal emission value is acquired by adjusting the antenna height, polarisation and turntable azimuth. Normally, the height range of antenna is 1 m to 4 m, the azimuth range of turntable is 0° to 360°, and the receive antenna has two polarizations Vertical (V) and Horizontal (H). Above 1GHz: (Note: the FCC's permission to use 1.5m as an alternative per TCBC Conf call of Dec. 2, 2014.) The EUT is placed on a turntable 1.5 meters above the ground in the chamber, 3 meter away from the antenna. The maximal emission value is acquired by adjusting the antenna height, polarisation and turntable azimuth. Normally, the height range of antenna is 1 m to 4 m, the azimuth range of turntable is 0° to 360°, and the receive antenna has two polarizations Vertical (V) and Horizontal (H).
- A loop antenna, A log-periodic antenna or horn antenna shall be substituted in place of the EUT. The log-periodic antenna will be driven by a signal generator and the level will be adjusted till the same power value on the spectrum analyzer or receiver. The level of the spurious emissions can be calculated through the level of the signal generator, cable loss, the gain of the substitution antenna and the reading of the spectrum analyzer or receiver.
- The EUT is then put into continuously transmitting mode at its maximum power level during the test. Set Test Receiver or Spectrum RBW=200Hz,VBW=600Hz for 9kHz150kHz , RBW=10kHz, VBW=30kHz 150kHz-30MHz ,RBW=100kHz,VBW=300kHz for 30MHz to 1GHz and RBW=1MHz, VBW=3MHz for above 1GHz And the maximum value of the receiver should be recorded as (Pr).
- The EUT shall be replaced by a substitution antenna. In the chamber, an substitution antenna for the frequency band of interest is placed at the reference point of the chamber. An RF Signal source for the frequency band of interest is connected to the substitution antenna with a cable that has been constructed to not interfere with the radiation pattern of the antenna. A power (PMea) is applied to the input of the substitution antenna, and adjust the level of the signal generator output until the value of the receiver reach the previously recorded (Pr). The power of signal source (PMea) is recorded. The test should be performed by rotating the test item and adjusting the receiving antenna polarization.
- A amplifier should be connected to the Signal Source output port. And the cable should be connect between the Amplifier and the Substitution Antenna. The cable loss (Pcl) ,the Substitution Antenna Gain (Ga) and the Amplifier Gain (PAg) should be recorded after test.
- The measurement results are obtained as described below:
 $Power(EIRP)=PMea- PAg - Pcl + Ga$
 The measurement results are amend as described below:
 $Power(EIRP)=PMea- Pcl + Ga$
- This value is EIRP since the measurement is calibrated using an antenna of known gain (2.15 dBi) and known input power. ERP can be calculated from EIRP by subtracting the gain of the dipole, ERP

= EIRP-2.15dBi.

The modulation mode and RB allocation refer to section 5.1, using the maximum output power configuration.

Test setup

9KHz ~ 30MHz

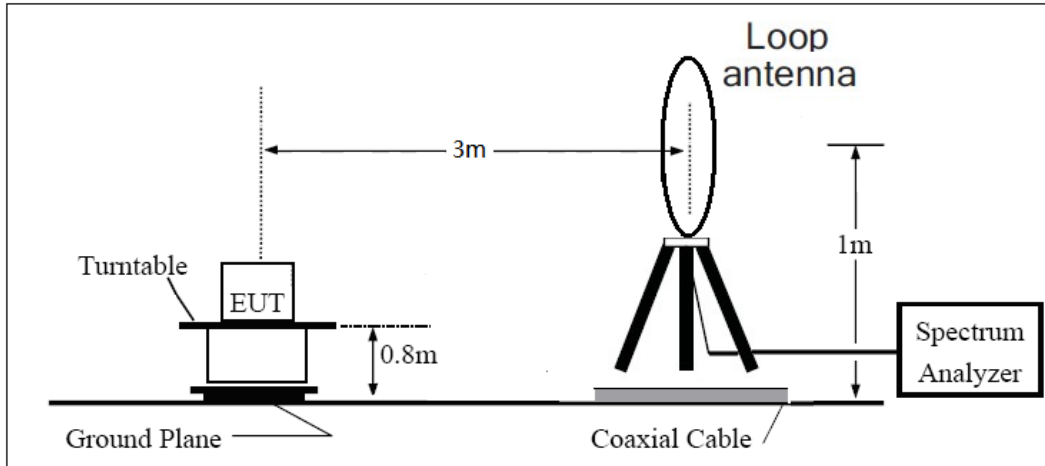

30MHz ~ 1GHz

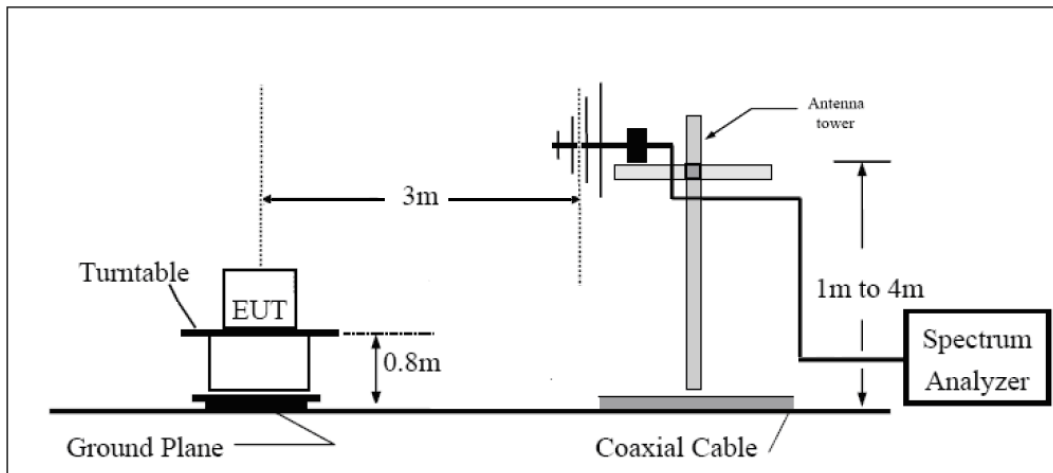

Above 1GHz

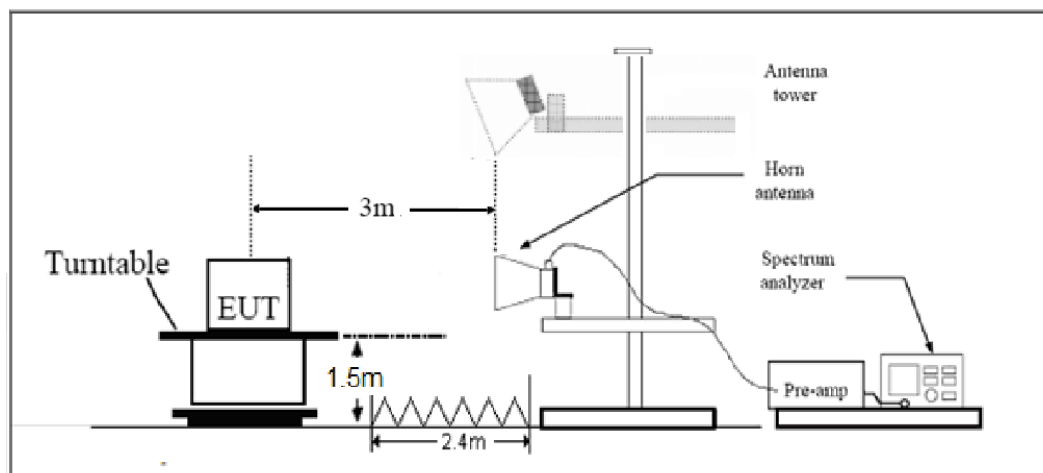

Note: Area side:2.4mX3.6m



Limits

Rule Part 27.53(h) specifies that “for operations in the 1695-1710 MHz, 1710-1755 MHz, 1755-1780 MHz, 1915-1920 MHz, 1995-2000 MHz, 2000-2020 MHz, 2110-2155 MHz, 2155-2180 MHz, and 2180-2200 bands, the power of any emission outside a licensee's frequency block shall be attenuated below the transmitter power (P) in watts by at least $43 + 10 \log_{10}(P)$ dB.”

Rule Part 27.53(m) $55 + 10 \log(P)$ dB on all frequencies more than X megahertz from the channel edge, where X is the greater of 6 megahertz or the actual emission bandwidth as defined in paragraph (m)(4) of this section.

Part 27.53(h) Limit	-13 dBm
Part 27.53(m) Limit	-25 dBm

Measurement Uncertainty

The assessed measurement uncertainty to ensure 95% confidence level for the normal distribution is with the coverage factor $k = \pm 1.96$, $U = \pm 3.55$ dB.

Test Result

Sweep the whole frequency band through the range from 9kHz to the 10th harmonic of the carrier, the emissions below the noise floor will not be recorded in the report.

WCDMA Band IV CH-Middle

Harmonic	Frequency (MHz)	SG (dBm)	Cable Loss (dB)	Gain (dBi)	Antenna Polarization	EIRP Level (dBm)	Limit (dBm)	Margin (dB)	Azimuth (deg)
2	3462.8	-58.95	2.6	10.75	Horizontal	-50.80	-13.00	37.80	0
3	5201.3	-63.35	2.4	11.05	Horizontal	-54.70	-13.00	41.70	90
4	6925.1	-57.55	4.5	11.15	Horizontal	-50.90	-13.00	37.90	225
5	8663.0	-54.35	5.1	11.35	Horizontal	-48.10	-13.00	35.10	135
6	10395.6	-53.55	5.3	11.95	Horizontal	-46.90	-13.00	33.90	180
7	12128.2	-53.95	5.5	13.55	Horizontal	-45.90	-13.00	32.90	45
8	13860.8	-50.90	6.3	13.75	Horizontal	-43.45	-13.00	30.45	225
9	15593.4	-53.69	6.7	13.85	Horizontal	-46.54	-13.00	33.54	315
10	17326.0	-50.71	6.8	14.25	Horizontal	-43.26	-13.00	30.26	0

Note: 1. The other Spurious RF Radiated emissions level is no more than noise floor.
2. The worst emission was found in the antenna is Horizontal position.

LTE Band 4 QPSK 1.4MHz CH-Middle, RB 1

Harmonic	Frequency (MHz)	SG (dBm)	Cable Loss (dB)	Gain (dBi)	Antenna Polarization	EIRP Level (dBm)	Limit (dBm)	Margin (dB)	Azimuth (deg)
2	3464.3	-57.16	2.6	10.75	Horizontal	-49.01	-13.00	36.01	135
3	5197.5	-61.94	2.4	11.05	Horizontal	-53.29	-13.00	40.29	315
4	6930.0	-56.81	4.5	11.15	Horizontal	-50.16	-13.00	37.16	225
5	8662.5	-53.54	5.1	11.35	Horizontal	-47.29	-13.00	34.29	90
6	10395.0	-52.41	5.3	11.95	Horizontal	-45.76	-13.00	32.76	0
7	12127.5	-51.85	5.5	13.55	Horizontal	-43.80	-13.00	30.80	45
8	13860.0	-50.54	6.3	13.75	Horizontal	-43.09	-13.00	30.09	180
9	15592.5	-51.87	6.7	13.85	Horizontal	-44.72	-13.00	31.72	135
10	17325.0	-50.55	6.8	14.25	Horizontal	-43.10	-13.00	30.10	225

Note: 1. The other Spurious RF Radiated emissions level is no more than noise floor.
2. The worst emission was found in the antenna is Horizontal position.

LTE Band 4 QPSK 5MHz CH-Middle, RB 1

Harmonic	Frequency (MHz)	SG (dBm)	Cable Loss (dB)	Gain (dBi)	Antenna Polarization	EIRP Level (dBm)	Limit (dBm)	Margin (dB)	Azimuth (deg)
2	3460.5	-57.70	2.6	10.75	Horizontal	-49.55	-13.00	36.55	90
3	5191.5	-61.87	2.4	11.05	Horizontal	-53.22	-13.00	40.22	180
4	6930.0	-56.59	4.5	11.15	Horizontal	-49.94	-13.00	36.94	45
5	8662.5	-54.33	5.1	11.35	Horizontal	-48.08	-13.00	35.08	0
6	10395.0	-51.76	5.3	11.95	Horizontal	-45.11	-13.00	32.11	270
7	12127.5	-53.11	5.5	13.55	Horizontal	-45.06	-13.00	32.06	135
8	13860.0	-50.37	6.3	13.75	Horizontal	-42.92	-13.00	29.92	225
9	15592.5	-52.90	6.7	13.85	Horizontal	-45.75	-13.00	32.75	90
10	17325.0	-50.55	6.8	14.25	Horizontal	-43.10	-13.00	30.10	0

Note: 1.The other Spurious RF Radiated emissions level is no more than noise floor.
2. The worst emission was found in the antenna is Horizontal position.

LTE Band 4 QPSK 20MHz CH-Middle, RB 1

Harmonic	Frequency (MHz)	SG (dBm)	Cable Loss (dB)	Gain (dBi)	Antenna Polarization	EIRP Level (dBm)	Limit (dBm)	Margin (dB)	Azimuth (deg)
2	3447.0	-59.40	2.6	10.75	Horizontal	-51.25	-13.00	38.25	45
3	5170.5	-60.84	2.4	11.05	Horizontal	-52.19	-13.00	39.19	180
4	6930.0	-56.30	4.5	11.15	Horizontal	-49.65	-13.00	36.65	135
5	8662.5	-54.18	5.1	11.35	Horizontal	-47.93	-13.00	34.93	225
6	10395.0	-51.52	5.3	11.95	Horizontal	-44.87	-13.00	31.87	90
7	12127.5	-53.48	5.5	13.55	Horizontal	-45.43	-13.00	32.43	180
8	13860.0	-47.86	6.3	13.75	Horizontal	-40.41	-13.00	27.41	180
9	15592.5	-52.74	6.7	13.85	Horizontal	-45.59	-13.00	32.59	135
10	17325.0	-49.95	6.8	14.25	Horizontal	-42.50	-13.00	29.50	225

Note: 1.The other Spurious RF Radiated emissions level is no more than noise floor.
2. The worst emission was found in the antenna is Horizontal position.

LTE Band 7 QPSK 5MHz CH-Middle, RB 1

Harmonic	Frequency (MHz)	SG (dBm)	Cable Loss (dB)	Gain (dBi)	Antenna Polarization	EIRP Level (dBm)	Limit (dBm)	Margin (dB)	Azimuth (deg)
2	5070.0	-59.71	2.00	9.15	Horizontal	-52.56	-25.00	27.56	180
3	7605.0	-52.61	2.50	11.35	Horizontal	-43.76	-25.00	18.76	135
4	10140.0	-50.28	4.20	12.05	Horizontal	-42.43	-25.00	17.43	225
5	12675.0	-52.30	5.20	12.85	Horizontal	-44.65	-25.00	19.65	90
6	15210.0	-54.85	5.50	14.23	Horizontal	-46.12	-25.00	21.12	180
7	17745.0	-51.87	5.70	14.15	Horizontal	-43.42	-25.00	18.42	135
8	20280.0	--	--	--	--	--	--	--	--
9	22815.0	--	--	--	--	--	--	--	--
10	25350.0	--	--	--	--	--	--	--	--

Note: 1.The other Spurious RF Radiated emissions level is no more than noise floor.
 2. The worst emission was found in the antenna is Horizontal position.

LTE Band 7 QPSK 20MHz CH-Middle, RB 1

Harmonic	Frequency (MHz)	SG (dBm)	Cable Loss (dB)	Gain (dBi)	Antenna Polarization	EIRP Level (dBm)	Limit (dBm)	Margin (dB)	Azimuth (deg)
2	5070.0	-60.97	2.00	10.15	Horizontal	-52.82	-25.00	27.82	135
3	7605.0	-53.37	2.50	11.35	Horizontal	-44.52	-25.00	19.52	225
4	10140.0	-50.00	4.20	12.05	Horizontal	-42.15	-25.00	17.15	90
5	12675.0	-53.38	5.20	14.85	Horizontal	-43.73	-25.00	18.73	180
6	15210.0	-54.17	5.50	13.23	Horizontal	-46.44	-25.00	21.44	45
7	17745.0	-49.90	5.70	12.15	Horizontal	-43.45	-25.00	18.45	0
8	20280.0	--	--	--	--	--	--	--	--
9	22815.0	--	--	--	--	--	--	--	--
10	25350.0	--	--	--	--	--	--	--	--

Note: 1.The other Spurious RF Radiated emissions level is no more than noise floor.
 2. The worst emission was found in the antenna is Horizontal position.

6 Main Test Instruments

Name	Manufacturer	Type	Serial Number	Calibration Date	Expiration Date
Base Station Simulator	R&S	CMW500	113824	2018-05-20	2019-05-19
Power Splitter	Hua Xiang	SHX-GF2-2-13	10120101	/	/
Spectrum Analyzer	Key sight	N9010A	MY50210259	2018-05-20	2019-05-19
Signal Analyzer	R&S	FSV30	100815	2018-12-16	2019-12-15
Loop Antenna	SCHWARZBECK	FMZB1519	1519-047	2017-09-26	2019-09-25
Trilog Antenna	SCHWARZBECK	VUBL 9163	9163-201	2017-11-18	2019-11-17
Horn Antenna	R&S	HF907	100126	2018-07-07	2020-07-06
Horn Antenna	ETS-Lindgren	3160-09	00102643	2018-06-20	2020-06-19
Signal generator	R&S	SMB 100A	102594	2018-05-20	2019-05-19
Climatic Chamber	ESPEC	SU-242	93000506	2017-12-17	2020-12-16
Preamplifier	R&S	SCU18	102327	2018-05-20	2019-05-19
MOB COMMS DC SUPPLY	Keysight	66319D	MY43004105	2018-05-21	2019-05-20
RF Cable	Agilent	SMA 15cm	0001	2019-03-15	2019-06-14
Software	R&S	EMC32	9.26.0	/	/

*****END OF REPORT *****

ANNEX A: Product Change Description

Huawei Technologies Co., Ltd.

Difference Declaration Letter

Article 1: Difference description:

The difference between model AMN-LX3 and model KSA-LX3 is show in the below table:

	Model	AMN-LX3	KSA-LX3
Licensed Frequency	LTE BAND	the same	the same
	UMTS BAND	the same	the same
	GSM	the same	the same
	IC	the same	the same
	Antenna	the same	the same
	RF conducted power	the same	the same
Unlicensed Frequency	Bluetooth	the same	the same
	2.4G Wi-Fi	the same	the same
	IC	the same	the same
	Antenna	the same	the same
Hardware	NFC	Not support	Not support
	MIC	the same	the same
	Ram / Rom	the same	the same
	Camera	the same	the same
	PCB	the same	the same
	USB Port	the same	the same
	SIM	the same	the same
RF	RF	the same	the same
Appearance	Dimension	the same	Only the rear camera has a different curved appearance
	Color	the same	the same
Accessory	Battery	the same	the same
	Charger	the same	the same
	USB label	the same	the same
	Earphone	the same	the same