



RF TEST REPORT

Applicant Huawei Technologies Co., Ltd.
FCC ID QISKSA-LX3
Product Smart Phone
Brand HONOR
Model KSA-LX3
Report No. R1903H0046-R2
Issue Date April 12, 2019

TA Technology (Shanghai) Co., Ltd. tested the above equipment in accordance with the requirements in **FCC CFR47 Part 2 (2019)/ FCC CFR 47 Part 24E (2019)**. The test results show that the equipment tested is capable of demonstrating compliance with the requirements as documented in this report.

Performed by: Peng Tao

Approved by: Kai Xu

TA Technology (Shanghai) Co., Ltd.

No.145, Jintang Rd, Tangzhen Industry Park, Pudong Shanghai, China

TEL: +86-021-50791141/2/3

FAX: +86-021-50791141/2/3-8000



TABLE OF CONTENT

| | |
|---|-----------|
| 1. Test Laboratory | 4 |
| 1.1. Notes of the test report..... | 4 |
| 1.2. Test facility..... | 4 |
| 1.3. Testing Location | 5 |
| 2. General Description of Equipment under Test..... | 6 |
| 3. Applied Standards..... | 8 |
| 4. Test Configuration..... | 9 |
| 5. Test Case Results..... | 11 |
| 5.1. RF Power Output..... | 11 |
| 5.2. Effective Isotropic Radiated Power | 16 |
| 5.3. Occupied Bandwidth | 20 |
| 5.4. Band Edge Compliance..... | 31 |
| 5.5. Peak-to-Average Power Ratio (PAPR) | 42 |
| 5.6. Frequency Stability | 45 |
| 5.7. Spurious Emissions at Antenna Terminals | 51 |
| 5.8. Radiates Spurious Emission | 64 |
| 6. Main Test Instruments | 70 |
| ANNEX A: Product Change Description | 71 |

Summary of measurement results

| No. | Test Case | Clause in FCC rules | Verdict |
|---|---|-------------------------------|-----------------------|
| 1 | RF power output | 2.1046 | Refer to the Original |
| 2 | Effective Isotropic Radiated power | 24.232(c) | Refer to the Original |
| 3 | Occupied Bandwidth | 2.1049 | Refer to the Original |
| 4 | Band Edge Compliance | 2.1051 /24.238(a) | Refer to the Original |
| 5 | Peak-to-Average Power Ratio | 24.232/KDB 971168 D01(5.7) | Refer to the Original |
| 6 | Frequency Stability | 2.1055 / 24.235 | Refer to the Original |
| 7 | Spurious Emissions at Antenna Terminals | 2.1051 / 24.238(a) | Refer to the Original |
| 8 | Radiates Spurious Emission | 2.1053 / 24.238(a) | Refer to the Original |
| Date of Testing: March 17, 2019 ~ March 29, 2019 | | | |
| Note: PASS: The EUT complies with the essential requirements in the standard. FAIL: The EUT does not comply with the essential requirements in the standard. | | | |

KSA-LX3 (Report No:R1903H0046-R2) is a variant model of AMN-LX3 (Report No: R1903H0043-R2). Test values duplicated from Original for variant. There is no test for variant in this report. The detailed product change description please refers to the ANNEX A.

1. Test Laboratory

1.1. Notes of the test report

This report shall not be reproduced in full or partial, without the written approval of **TA technology (shanghai) co., Ltd.** The results documented in this report apply only to the tested sample, under the conditions and modes of operation as described herein. Measurement Uncertainties were not taken into account and are published for informational purposes only. This report is written to support regulatory compliance of the applicable standards stated above.

1.2. Test facility

CNAS (accreditation number: L2264)

TA Technology (Shanghai) Co., Ltd. has obtained the accreditation of China National Accreditation Service for Conformity Assessment (CNAS).

FCC (Designation number: CN1179, Test Firm Registration Number: 446626)

TA Technology (Shanghai) Co., Ltd. has been listed on the US Federal Communications Commission list of test facilities recognized to perform electromagnetic emissions measurements.

IC (recognition number is 8510A)

TA Technology (Shanghai) Co., Ltd. has been listed by industry Canada to perform electromagnetic emission measurement.

VCCI (recognition number is C-4595, T-2154, R-4113, G-10766)

TA Technology (Shanghai) Co., Ltd. has been listed by industry Japan to perform electromagnetic emission measurement.

A2LA (Certificate Number: 3857.01)

TA Technology (Shanghai) Co., Ltd. has been listed by American Association for Laboratory Accreditation to perform electromagnetic emission measurement.



1.3. Testing Location

Company: TA Technology (Shanghai) Co., Ltd.
Address: No.145, Jintang Rd, Tangzhen Industry Park, Pudong
City: Shanghai
Post code: 201201
Country: P. R. China
Contact: Xu Kai
Telephone: +86-021-50791141/2/3
Fax: +86-021-50791141/2/3-8000
Website: <http://www.ta-shanghai.com>
E-mail: xukai@ta-shanghai.com

2. General Description of Equipment under Test

Client Information

| | |
|----------------------|--|
| Applicant | Huawei Technologies Co., Ltd. |
| Applicant address | Administration Building, Headquarters of Huawei Technologies Co., Ltd., Bantian, Longgang District Shenzhen 518129 P.R.China |
| Manufacturer | Huawei Technologies Co., Ltd. |
| Manufacturer address | Administration Building, Headquarters of Huawei Technologies Co., Ltd., Bantian, Longgang District Shenzhen 518129 P.R.China |

General information

| EUT Description | | | |
|------------------------------|---|-------------|-------------|
| Model | KSA-LX3 | | |
| IMEI | IMEI 1: 866698040023628 IMEI 2: 866698040028825 | | |
| Hardware Version | HL1AMNM | | |
| Software Version | 5.0.1.37(C900E20R1P2) | | |
| Power Supply | Battery/AC adapter | | |
| Antenna Type | Internal Antenna | | |
| Antenna Gain | GSM1900: 0.57dBi WCDMA Band II: 0.57dBi LTE Band 2: 0.57dBi | | |
| Test Mode(s) | GSM1900; WCDMA Band II; LTE Band 2 | | |
| Test Modulation | (GSM)GMSK,8PSK; (WCDMA)QPSK,16QAM; (LTE)QPSK,16QAM | | |
| GPRS Multislot Class | 12 | | |
| EGPRS Multislot Class | 12 | | |
| HSDPA UE Category | 14 | | |
| HSUPA UE Category | 7 | | |
| DC-HSDPA UE Category | 24 | | |
| HSPA+ UE Category | 7 | | |
| LTE Category | 4 | | |
| Maximum E.I.R.P | GSM 1900: | 29.72dBm | |
| | WCDMA Band II: | 24.16dBm | |
| | LTE Band 2: | 24.10dBm | |
| Rated Power Supply Voltage | 3.82V | | |
| Extreme Voltage | Minimum: 3.6V Maximum: 4.4V | | |
| Extreme Temperature | Lowest: -10°C Highest: +55°C | | |
| Operating Frequency Range(s) | Band | Tx (MHz) | Rx (MHz) |
| | GSM1900 | 1850 ~ 1910 | 1930 ~ 1990 |



| | | | |
|--|--|-------------|-------------|
| | WCDMA Band II | 1850 ~ 1910 | 1930 ~ 1990 |
| | LTE Band 2 | 1850 ~ 1910 | 1930 ~ 1990 |
| EUT Accessory | | | |
| Adapter 1 | Manufacturer: HuaweiTechnologies Co., Ltd. (SHENZHEN HUNTKEY ELECTRIC CO., LTD.) Model: HW-050100U01 | | |
| Adapter 2 | Manufacturer: HuaweiTechnologies Co., Ltd. (HUIZHOU BYD ELECTRONIC CO., LTD.) Model: HW-050100U01 | | |
| Adapter 3 | Manufacturer: HuaweiTechnologies Co., Ltd. (Dongguan Phitek Electronics Co., Ltd.) Model: HW-050100U01 | | |
| Battery 1 | Manufacturer: HuaweiTechnologies Co., Ltd. (Sunwoda Electronic Co.,LTD) Model: HB405979ECW | | |
| Battery 2 | Manufacturer: HuaweiTechnologies Co., Ltd. (SCUD (Fujian) Electronics Co., LTD.) Model: HB405979ECW | | |
| Battery 3 | Manufacturer: HuaweiTechnologies Co., Ltd. (Desay Battery Electronic Co.,LTD) Model: HB405979ECW | | |
| Earphone 1 | Manufacturer: Jiangxi Lianchuang Hongsheng Electronic Co.,LTD Model: MEND1532B528A02 | | |
| Earphone 2 | Manufacturer: Boluo County Quancheng Electronic Co.,Ltd. Model: 1293-3283-3.5MM-322 | | |
| USB Cable 1 | Manufacturer: HONGLIN TECHNOLOGY CO.,LTD. Model: 130-26654 | | |
| USB Cable 2 | Manufacturer: Dongguan Ming Ji Electronics Co.,Ltd. Model: 203-0786-0 | | |
| USB Cable 3 | Manufacturer: Luxshare Precision industry Co., Ltd. Model: L99U2013-CS-H | | |
| USB Cable 4 | Manufacturer: NingBo Broad Telecommunication Co., Ltd. Model: WA0007 | | |
| <p>Note: 1. The information of the EUT is declared by the manufacturer.</p> <p>2. There are more than one Adapter, Battery, Earphone and USB Cable, each one should be applied throughout the compliance test respectively, however, only the worst case (Adapter 2, Battery 2 and USB Cable 2) will be recorded in this report.</p> | | | |



3. Applied Standards

According to the specifications of the manufacturer, it must comply with the requirements of the following standards:

FCC CFR47 Part 2 (2019)

FCC CFR 47 Part 24E (2019)

ANSI C63.26 (2015)

KDB 971168 D01 Power Meas License Digital Systems v03r01

4. Test Configuration

There is more than one SIM card slot, each one should be applied throughout the compliance test respectively, and however, only the worst case (SIM 1) will be recorded in this report

Radiated measurements are performed by rotating the EUT in three different orthogonal test planes. EUT stand-up position (Z axis), lie-down position (X, Y axis). Receiver antenna polarization (horizontal and vertical), the worst emission was found in position (X axis, horizontal polarization) and the worst case was recorded.

All mode and data rates and positions and RB size and modulations were investigated. Subsequently, only the worst case emissions are reported.

The following testing in GSM/WCDMA/LTE is set based on the maximum RF Output Power.

Test modes are chosen to be reported as the worst case configuration below:

| Test items | Modes/Modulation | |
|---|--|---|
| | GSM 1900 | WCDMA Band II |
| RF power output | GSM GPRS EGPRS | RMC HSDPA/HSUPA DC-HSDPA HSPA+ |
| Effective Isotropic Radiated power | GSM GPRS(1Tx slot) EGPRS(1Tx slot) | RMC |
| Occupied Bandwidth | GSM GPRS(1Tx slot) EGPRS(1Tx slot) | RMC |
| Band Edge Compliance | GSM GPRS(1Tx slot) EGPRS(1Tx slot) | RMC |
| Peak-to-Average Power Ratio | GSM GPRS(1Tx slot) EGPRS(1Tx slot) | RMC |
| Frequency Stability | GSM GPRS(1Tx slot) EGPRS(1Tx slot) | RMC |
| Spurious Emissions at Antenna Terminals | GSM | RMC |
| Radiates Spurious Emission | GSM | RMC |



Test modes are chosen to be reported as the worst case configuration below for LTE Band 2:

| Test items | Bandwidth (MHz) | | | | | | Modulation | | RB | | | Test Channel | | |
|------------------------------------|---|---|---|----|----|----|------------|-------|----|-----|------|--------------|---|---|
| | 1.4 | 3 | 5 | 10 | 15 | 20 | QPSK | 16QAM | 1 | 50% | 100% | L | M | H |
| RF power output | ○ | ○ | ○ | ○ | ○ | ○ | ○ | ○ | ○ | ○ | ○ | ○ | ○ | ○ |
| Effective Isotropic Radiated power | ○ | ○ | ○ | ○ | ○ | ○ | ○ | ○ | ○ | ○ | ○ | ○ | ○ | ○ |
| Occupied Bandwidth | ○ | ○ | ○ | ○ | ○ | ○ | ○ | ○ | - | - | ○ | ○ | ○ | ○ |
| Band Edge Compliance | ○ | ○ | ○ | ○ | ○ | ○ | ○ | ○ | ○ | - | ○ | ○ | - | ○ |
| Peak-to-Average Power Ratio | ○ | ○ | ○ | ○ | ○ | ○ | ○ | ○ | - | - | ○ | ○ | ○ | ○ |
| Frequency Stability | ○ | ○ | ○ | ○ | ○ | ○ | ○ | ○ | ○ | ○ | ○ | ○ | ○ | ○ |
| Conducted Spurious Emissions | ○ | ○ | ○ | ○ | ○ | ○ | ○ | - | ○ | - | - | ○ | ○ | ○ |
| Radiates Spurious Emission | ○ | - | ○ | - | - | ○ | ○ | - | ○ | - | - | - | ○ | - |
| Note | 1. The mark "○" means that this configuration is chosen for testing. 2. The mark "-" means that this configuration is not testing. | | | | | | | | | | | | | |

5. Test Case Results

5.1.RF Power Output

Ambient condition

| Temperature | Relative humidity | Pressure |
|-------------|-------------------|----------|
| 23°C ~25°C | 45%~50% | 101.5kPa |

Methods of Measurement

During the process of the testing, The EUT is controlled by the Base Station Simulator to ensure max power transmission and proper modulation.

Test Setup

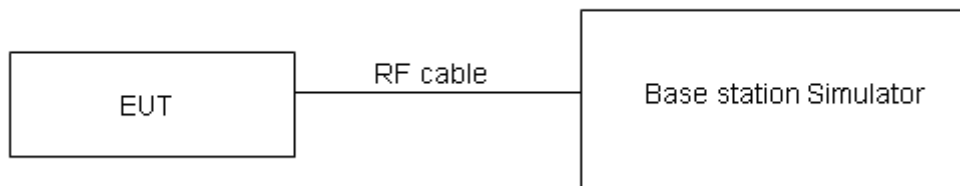

The loss between RF output port of the EUT and the input port of the tester has been taken into consideration.

Limits

No specific RF power output requirements in part 2.1046.

Measurement Uncertainty

The assessed measurement uncertainty to ensure 95% confidence level for the normal distribution is with the coverage factor $k = 2$, $U = 0.4$ dB.



Test Results

| GSM 1900 | | Conducted Power(dBm) | | |
|----------------------|----------|----------------------|-------------|-------------|
| | | Channel 512 | Channel 661 | Channel 810 |
| | | 1850.2(MHz) | 1880(MHz) | 1909.8(MHz) |
| GSM | Results | 27.61 | 27.56 | 27.48 |
| GPRS/EGPRS (GMSK) | 1TXslot | 27.60 | 27.55 | 27.48 |
| | 2TXslots | 24.68 | 24.66 | 24.59 |
| | 3TXslots | 22.97 | 22.98 | 22.92 |
| | 4TXslots | 21.69 | 21.67 | 21.60 |
| EGPRS (8PSK) | 1TXslot | 25.72 | 25.91 | 25.84 |
| | 2TXslots | 23.04 | 23.02 | 22.96 |
| | 3TXslots | 21.50 | 21.47 | 21.41 |
| | 4TXslots | 19.60 | 19.74 | 19.51 |

| WCDMA Band II | | Conducted Power(dBm) | | |
|---------------|--------------|----------------------|--------------|--------------|
| | | Channel 9262 | Channel 9400 | Channel 9538 |
| | | 1852.4(MHz) | 1880(MHz) | 1907.6(MHz) |
| RMC | 12.2k | 20.70 | 20.55 | 20.63 |
| | 64k | 20.69 | 20.56 | 20.61 |
| | 144k | 20.72 | 20.53 | 20.64 |
| | 384k | 20.73 | 20.52 | 20.65 |
| HSDPA | Sub - Test 1 | 20.16 | 19.97 | 20.07 |
| | Sub - Test 2 | 20.15 | 19.99 | 20.04 |
| | Sub - Test 3 | 19.62 | 19.49 | 19.56 |
| | Sub - Test 4 | 19.63 | 19.50 | 19.54 |
| HSUPA | Sub - Test 1 | 20.12 | 19.96 | 20.02 |
| | Sub - Test 2 | 19.11 | 18.94 | 19.01 |
| | Sub - Test 3 | 19.58 | 19.42 | 19.50 |
| | Sub - Test 4 | 19.04 | 18.91 | 18.98 |
| | Sub - Test 5 | 20.05 | 19.89 | 19.96 |
| DC-HSDPA | Sub - Test 1 | 20.04 | 19.91 | 19.97 |
| | Sub - Test 2 | 20.03 | 19.90 | 19.96 |
| | Sub - Test 3 | 19.61 | 19.39 | 19.47 |
| | Sub - Test 4 | 19.60 | 19.38 | 19.46 |
| HSPA+ | 16QAM | 19.59 | 19.46 | 19.53 |



| LTE Band 2 | | | | Conducted Power(dBm) | | |
|------------|------------|---------|-----------|-------------------------|------------|--------------|
| Bandwidth | Modulation | RB size | RB offset | Channel/Frequency (MHz) | | |
| | | | | 18607/1850.7 | 18900/1880 | 19193/1909.3 |
| 1.4MHz | QPSK | 1 | 0 | 20.06 | 19.92 | 19.92 |
| | | 1 | 2 | 20.37 | 20.10 | 20.26 |
| | | 1 | 5 | 19.98 | 19.78 | 20.06 |
| | | 3 | 0 | 20.21 | 20.02 | 20.16 |
| | | 3 | 2 | 20.25 | 20.07 | 20.23 |
| | | 3 | 3 | 20.23 | 19.90 | 20.09 |
| | | 6 | 0 | 20.23 | 20.06 | 20.21 |
| | 16QAM | 1 | 0 | 20.37 | 20.27 | 20.32 |
| | | 1 | 2 | 20.61 | 20.47 | 20.54 |
| | | 1 | 5 | 20.60 | 20.24 | 20.37 |
| | | 3 | 0 | 20.31 | 20.07 | 20.23 |
| | | 3 | 2 | 20.36 | 20.13 | 20.32 |
| | | 3 | 3 | 20.30 | 20.08 | 20.16 |
| | | 6 | 0 | 20.35 | 20.10 | 20.28 |
| Bandwidth | Modulation | RB size | RB offset | Channel/Frequency (MHz) | | |
| | | | | 18615/1851.5 | 18900/1880 | 19185/1908.5 |
| 3MHz | QPSK | 1 | 0 | 20.08 | 19.96 | 19.95 |
| | | 1 | 7 | 20.40 | 20.15 | 20.30 |
| | | 1 | 14 | 20.01 | 19.83 | 20.10 |
| | | 8 | 0 | 20.29 | 20.12 | 20.27 |
| | | 8 | 4 | 20.35 | 20.15 | 20.33 |
| | | 8 | 7 | 20.31 | 19.99 | 20.17 |
| | | 15 | 0 | 20.26 | 20.10 | 20.24 |
| | 16QAM | 1 | 0 | 20.40 | 20.29 | 20.35 |
| | | 1 | 7 | 20.64 | 20.52 | 20.58 |
| | | 1 | 14 | 20.62 | 20.28 | 20.42 |
| | | 8 | 0 | 20.40 | 20.18 | 20.33 |
| | | 8 | 4 | 20.45 | 20.24 | 20.42 |
| | | 8 | 7 | 20.38 | 20.19 | 20.27 |
| | | 15 | 0 | 20.38 | 20.14 | 20.31 |
| Bandwidth | Modulation | RB size | RB offset | Channel/Frequency (MHz) | | |
| | | | | 18625/1852.5 | 18900/1880 | 19175/1907.5 |
| 5MHz | QPSK | 1 | 0 | 20.05 | 19.94 | 19.91 |
| | | 1 | 13 | 20.38 | 20.11 | 20.27 |
| | | 1 | 24 | 19.98 | 19.78 | 20.06 |
| | | 12 | 0 | 20.26 | 20.07 | 20.23 |



| | 16QAM | 12 | 6 | 20.33 | 20.11 | 20.28 |
|-----------|------------|---------|-----------|-------------------------|------------|--------------|
| | | 12 | 13 | 20.29 | 19.97 | 20.13 |
| | | 25 | 0 | 20.24 | 20.09 | 20.22 |
| | | 1 | 0 | 20.37 | 20.25 | 20.32 |
| | | 1 | 13 | 20.61 | 20.50 | 20.55 |
| | | 1 | 24 | 20.59 | 20.26 | 20.36 |
| | | 12 | 0 | 20.38 | 20.14 | 20.30 |
| | | 12 | 6 | 20.42 | 20.19 | 20.37 |
| | | 12 | 13 | 20.35 | 20.13 | 20.23 |
| | | 25 | 0 | 20.36 | 20.10 | 20.26 |
| Bandwidth | Modulation | RB size | RB offset | Channel/Frequency (MHz) | | |
| | | | | 18650/1855 | 18900/1880 | 19150/1905 |
| 10MHz | QPSK | 1 | 0 | 20.07 | 19.95 | 19.94 |
| | | 1 | 25 | 20.41 | 20.16 | 20.31 |
| | | 1 | 49 | 20.00 | 19.82 | 20.09 |
| | | 25 | 0 | 20.29 | 20.12 | 20.27 |
| | | 25 | 13 | 20.36 | 20.16 | 20.32 |
| | | 25 | 25 | 20.31 | 20.01 | 20.18 |
| | | 50 | 0 | 20.32 | 20.11 | 20.26 |
| | 16QAM | 1 | 0 | 20.39 | 20.28 | 20.34 |
| | | 1 | 25 | 20.64 | 20.54 | 20.58 |
| | | 1 | 49 | 20.62 | 20.28 | 20.39 |
| | | 25 | 0 | 20.41 | 20.19 | 20.34 |
| | | 25 | 13 | 20.44 | 20.23 | 20.42 |
| | | 25 | 25 | 20.38 | 20.18 | 20.27 |
| | | 50 | 0 | 20.39 | 20.15 | 20.30 |
| Bandwidth | Modulation | RB size | RB offset | Channel/Frequency (MHz) | | |
| | | | | 18675/1857.5 | 18900/1880 | 19125/1902.5 |
| 15MHz | QPSK | 1 | 0 | 20.06 | 19.91 | 19.92 |
| | | 1 | 38 | 20.39 | 20.15 | 20.28 |
| | | 1 | 74 | 19.97 | 19.77 | 20.05 |
| | | 36 | 0 | 20.27 | 20.08 | 20.24 |
| | | 36 | 18 | 20.33 | 20.11 | 20.26 |
| | | 36 | 39 | 20.28 | 19.98 | 20.14 |
| | | 75 | 0 | 20.30 | 20.07 | 20.21 |
| | 16QAM | 1 | 0 | 20.34 | 20.26 | 20.32 |
| | | 1 | 38 | 20.62 | 20.51 | 20.56 |
| | | 1 | 74 | 20.59 | 20.24 | 20.36 |
| | | 36 | 0 | 20.38 | 20.17 | 20.31 |
| | | 36 | 18 | 20.41 | 20.18 | 20.37 |



| Bandwidth | Modulation | RB size | RB offset | Channel/Frequency (MHz) | | |
|-----------|------------|---------|-----------|-------------------------|------------|------------|
| | | | | 18700/1860 | 18900/1880 | 19100/1900 |
| 20MHz | | 36 | 39 | 20.36 | 20.14 | 20.24 |
| | | 75 | 0 | 20.36 | 20.10 | 20.26 |
| | QPSK | 1 | 0 | 20.03 | 19.87 | 19.89 |
| | | 1 | 50 | 20.38 | 20.11 | 20.26 |
| | | 1 | 99 | 19.95 | 19.76 | 20.02 |
| | | 50 | 0 | 20.24 | 20.03 | 20.20 |
| | | 50 | 25 | 20.31 | 20.07 | 20.25 |
| | | 50 | 50 | 20.25 | 19.93 | 20.10 |
| | 16QAM | 100 | 0 | 20.27 | 20.02 | 20.17 |
| | | 1 | 0 | 20.32 | 20.22 | 20.27 |
| | | 1 | 50 | 20.58 | 20.49 | 20.52 |
| | | 1 | 99 | 20.57 | 20.21 | 20.34 |
| | | 50 | 0 | 20.35 | 20.13 | 20.28 |
| | | 50 | 25 | 20.38 | 20.16 | 20.34 |
| 50 | | 50 | 20.33 | 20.09 | 20.20 | |
| | 100 | 0 | 20.34 | 20.06 | 20.23 | |

5.2. Effective Isotropic Radiated Power

Ambient condition

| Temperature | Relative humidity | Pressure |
|-------------|-------------------|----------|
| 23°C ~25°C | 45%~50% | 101.5kPa |

Methods of Measurement

The testing follows FCC KDB 971168 v03r01 Section 5.8 and ANSI C63.26 (2015).

- a) Connect the equipment as illustrated. Mount the equipment with the manufacturer specified antenna in a vertical orientation on a manufacturer specified mounting surface located on a non-conducting rotating platform of a RF anechoic chamber (preferred) or a standard radiation site.
- b) Key the transmitter, then rotate the EUT 360° azimuthally and record spectrum analyzer power level (LVL) measurements at angular increments that are sufficiently small to permit resolution of all peaks. If a standard radiation test site is used, raise and lower the test antenna to obtain a maximum reading at each angular increment. (Note: several batteries may be needed to offset the effect of battery voltage droop, which should not exceed 5% of the manufactured specified battery voltage during transmission).
- c) Replace the transmitter under test with a vertically polarized half-wave dipole (or an antenna whose gain is known relative to an ideal half-wave dipole). The center of the antenna should be at the same location as the center of the antenna under test.
- d) Connect the antenna to a signal generator with a known output power and record the path loss (in dB) as LOSS. If a standard radiation test site is used, raise and lower the test antenna to obtain a maximum reading. $LOSS = \text{Generator Output Power (dBm)} - \text{Analyzer reading (dBm)}$
- e) Determine the effective radiated output power at each angular position from the readings in steps b) and d) using the following equation: $ERP \text{ (dBm)} = \text{LVL (dBm)} + \text{LOSS (dB)}$
- f) The maximum ERP is the maximum value determined in the preceding step.
- g) When calculating ERP, in addition to knowing the antenna radiation and matching characteristics, it is necessary to know the loss values of all elements (e.g. transmission line attenuation, mismatches, filters, combiners) interposed between the point where transmitter output power is measured, and the point where power is applied to the antenna. ERP can then be calculated as follows:
 $EIRP \text{ (dBm)} = \text{Output Power (dBm)} - \text{Losses (dB)} + \text{Antenna Gain (dBi)}$
where: dBd refers to gain relative to an ideal dipole.
 $EIRP \text{ (dBm)} = ERP \text{ (dBm)} + 2.15 \text{ (dB.)}$

The RB allocation refers to section 5.1, using the maximum output power configuration.

Test setup

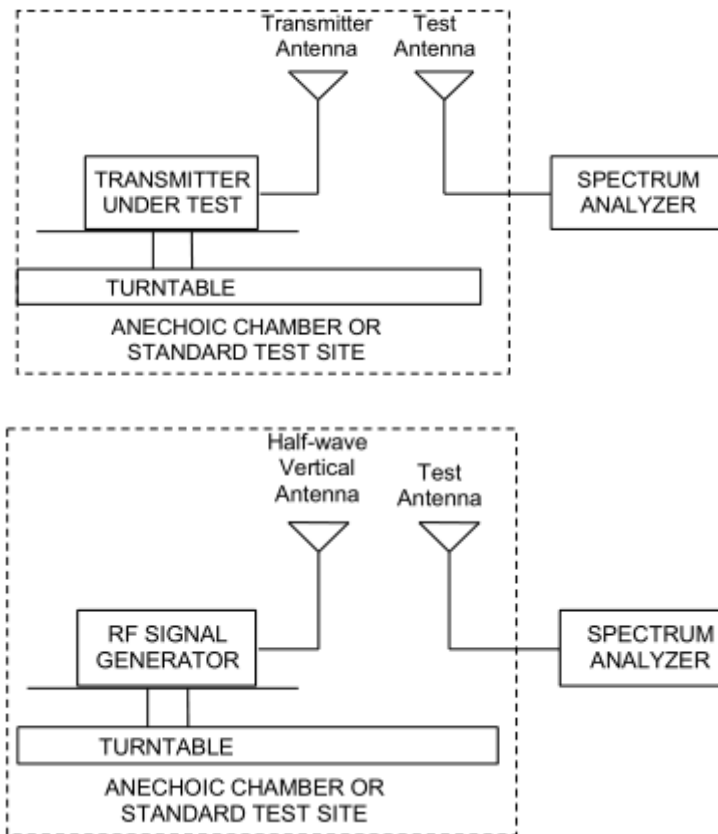

Limits

Rule Part 24.232(c) Mobile and portable stations are limited to 2 watts EIRP.

Rule Part 24.232(e) Peak transmit power must be measured over any interval of continuous transmission using instrumentation calibrated in terms of an rms-equivalent voltage.

| | |
|-------|----------------------------|
| Limit | $\leq 2\text{ W}$ (33 dBm) |
|-------|----------------------------|

Measurement Uncertainty

The assessed measurement uncertainty to ensure 95% confidence level for the normal distribution is with the coverage factor $k = 2$, $U = 1.19\text{ dB}$

Test Results:

The measurement is performed for both of horizontal and vertical antenna Polarization, and only the data of worst mode is recorded in this report.

| Mode | Channel | Frequency (MHz) | Polarization | EIRP (dBm) | Limit (dBm) | Conclusion |
|----------------------|---------|-----------------|--------------|------------|-------------|------------|
| GSM 1900 | Low | 1850.2 | Horizontal | 29.39 | 33 | Pass |
| | Mid | 1880 | Horizontal | 29.39 | 33 | Pass |
| | High | 1909.8 | Horizontal | 28.35 | 33 | Pass |
| GPRS 1900 | Low | 1850.2 | Horizontal | 29.71 | 33 | Pass |
| | Mid | 1880 | Horizontal | 29.72 | 33 | Pass |
| | High | 1909.8 | Horizontal | 28.72 | 33 | Pass |
| EGPRS 1900 | Low | 1850.2 | Horizontal | 28.11 | 33 | Pass |
| | Mid | 1880 | Horizontal | 28.51 | 33 | Pass |
| | High | 1909.8 | Horizontal | 27.59 | 33 | Pass |
| WCDMA Band II | Low | 1852.4 | Horizontal | 22.98 | 33 | Pass |
| | Mid | 1880 | Horizontal | 23.67 | 33 | Pass |
| | High | 1907.6 | Horizontal | 24.16 | 33 | Pass |

| LTE Band 2 | | | | | | |
|-----------------|---------|-----------------|--------------|------------|-------------|------------|
| bandwidth | Channel | Frequency (MHz) | Polarization | EIRP (dBm) | Limit (dBm) | Conclusion |
| 1.4 MHz (QPSK) | Low | 1850.7 | Horizontal | 21.35 | 33 | Pass |
| | Mid | 1880 | Horizontal | 23.52 | 33 | Pass |
| | High | 1909.3 | Horizontal | 24.10 | 33 | Pass |
| 3 MHz (QPSK) | Low | 1851.5 | Horizontal | 22.43 | 33 | Pass |
| | Mid | 1880 | Horizontal | 23.05 | 33 | Pass |
| | High | 1908.5 | Horizontal | 22.41 | 33 | Pass |
| 5 MHz (QPSK) | Low | 1852.5 | Horizontal | 22.38 | 33 | Pass |
| | Mid | 1880 | Horizontal | 23.43 | 33 | Pass |
| | High | 1907.5 | Horizontal | 22.87 | 33 | Pass |
| 10 MHz (QPSK) | Low | 1855 | Horizontal | 23.19 | 33 | Pass |
| | Mid | 1880 | Horizontal | 22.75 | 33 | Pass |
| | High | 1905 | Horizontal | 22.49 | 33 | Pass |
| 15 MHz (QPSK) | Low | 1857.5 | Horizontal | 23.12 | 33 | Pass |
| | Mid | 1880 | Horizontal | 24.05 | 33 | Pass |
| | High | 1902.5 | Horizontal | 23.34 | 33 | Pass |
| 20 MHz (QPSK) | Low | 1860 | Horizontal | 21.97 | 33 | Pass |
| | Mid | 1880 | Horizontal | 22.81 | 33 | Pass |
| | High | 1900 | Horizontal | 22.97 | 33 | Pass |
| 1.4 MHz (16QAM) | Low | 1850.7 | Horizontal | 20.89 | 33 | Pass |
| | Mid | 1880 | Horizontal | 23.03 | 33 | Pass |
| | High | 1909.3 | Horizontal | 23.54 | 33 | Pass |
| 3 MHz (16QAM) | Low | 1851.5 | Horizontal | 21.76 | 33 | Pass |
| | Mid | 1880 | Horizontal | 22.52 | 33 | Pass |
| | High | 1908.5 | Horizontal | 21.75 | 33 | Pass |
| 5 MHz (16QAM) | Low | 1852.5 | Horizontal | 21.88 | 33 | Pass |
| | Mid | 1880 | Horizontal | 22.94 | 33 | Pass |
| | High | 1907.5 | Horizontal | 22.41 | 33 | Pass |
| 10 MHz (16QAM) | Low | 1855 | Horizontal | 22.78 | 33 | Pass |
| | Mid | 1880 | Horizontal | 22.05 | 33 | Pass |
| | High | 1905 | Horizontal | 22.06 | 33 | Pass |
| 15 MHz (16QAM) | Low | 1857.5 | Horizontal | 22.50 | 33 | Pass |
| | Mid | 1880 | Horizontal | 23.57 | 33 | Pass |
| | High | 1902.5 | Horizontal | 22.61 | 33 | Pass |
| 20 MHz (16QAM) | Low | 1860 | Horizontal | 21.48 | 33 | Pass |
| | Mid | 1880 | Horizontal | 22.23 | 33 | Pass |
| | High | 1900 | Horizontal | 22.54 | 33 | Pass |

5.3.Occupied Bandwidth

Ambient condition

| Temperature | Relative humidity | Pressure |
|-------------|-------------------|----------|
| 23°C ~25°C | 45%~50% | 101.5kPa |

Method of Measurement

The EUT was connected to Spectrum Analyzer and Base Station Simulator via power Splitter. The occupied bandwidth is measured using spectrum analyzer.

RBW is set to 3kHz, VBW is set to 10kHz for GSM 1900,

RBW is set to 51kHz, VBW is set to 160kHz for WCDMA Band II,

RBW is set to 51kHz, VBW is set to 160kHz for LTE Band 2 (1.4MHz),

RBW is set to 100kHz,VBW is set to 300kHz for LTE Band 2 (3MHz/5MHz),

RBW is set to 300kHz,VBW is set to 1MHz for LTE Band 2 (10MHz/15MHz/20MHz).

99% power and -26dBc occupied bandwidths are recorded. Spectrum analyzer plots are included on the following pages.

Test Setup

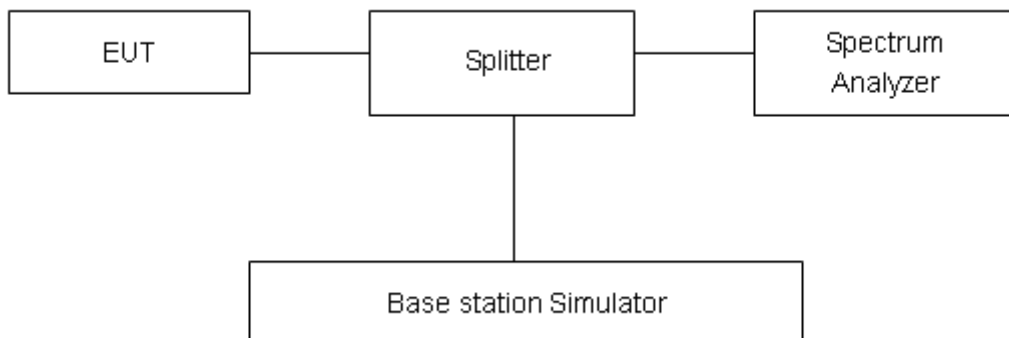

Limits

No specific occupied bandwidth requirements in part 2.1049.

Measurement Uncertainty

The assessed measurement uncertainty to ensure 95% confidence level for the normal distribution is with the coverage factor $k = 2$, $U = 624\text{Hz}$.



Test Result

| Mode | Channel | Frequency (MHz) | 99% Power Bandwidth (MHz) | -26dBc Bandwidth(MHz) |
|---------------------|---------|-----------------|---------------------------|-----------------------|
| GSM 1900 (GSM) | 512 | 1850.2 | 0.24603 | 0.3064 |
| | 661 | 1880.0 | 0.24526 | 0.3072 |
| | 810 | 1909.8 | 0.24685 | 0.3141 |
| GPRS 1900 (GMSK) | 512 | 1850.2 | 0.24439 | 0.3072 |
| | 661 | 1880.0 | 0.24887 | 0.3106 |
| | 810 | 1909.8 | 0.24756 | 0.3099 |
| EGPRS 1900 (8-PSK) | 512 | 1850.2 | 0.25206 | 0.3147 |
| | 661 | 1880.0 | 0.24547 | 0.3107 |
| | 810 | 1909.8 | 0.24635 | 0.3113 |
| WCDMA Band II (RMC) | 9262 | 1852.4 | 4.1659 | 4.693 |
| | 9400 | 1880 | 4.1658 | 4.677 |
| | 9538 | 1907.6 | 4.1539 | 4.669 |

| LTE Band 2 | | | | | |
|------------|-----------------|---------|-----------------|--------------------------|-----------------------|
| Modulation | Bandwidth (MHz) | Channel | Frequency (MHz) | 99% Power Bandwidth(MHz) | -26dBc Bandwidth(MHz) |
| QPSK | 1.4 | 18607 | 1850.7 | 1.1205 | 1.344 |
| | | 18900 | 1880.0 | 1.1296 | 1.350 |
| | | 19193 | 1909.3 | 1.1269 | 1.335 |
| | 3 | 18615 | 1851.5 | 2.7244 | 2.997 |
| | | 18900 | 1880 | 2.7278 | 3.003 |
| | | 19185 | 1908.5 | 2.7302 | 3.002 |
| | 5 | 18625 | 1852.5 | 4.5130 | 4.925 |
| | | 18900 | 1880 | 4.5067 | 4.929 |
| | | 19175 | 1907.5 | 4.5003 | 4.904 |
| | 10 | 18650 | 1855 | 9.0519 | 10.020 |
| | | 18900 | 1880 | 9.0286 | 9.963 |
| | | 19150 | 1905 | 9.0430 | 9.886 |
| | 15 | 18675 | 1857.5 | 13.4890 | 14.630 |



| | | | | | |
|-------|-----|-------|--------|---------|--------|
| | | 18900 | 1880 | 13.4680 | 14.590 |
| | | 19125 | 1902.5 | 13.4770 | 14.540 |
| | 20 | 18700 | 1860 | 17.9090 | 19.040 |
| | 20 | 18900 | 1880 | 17.9260 | 19.220 |
| | 20 | 19100 | 1900 | 17.8880 | 19.140 |
| 16QAM | 1.4 | 18607 | 1850.7 | 1.1195 | 1.331 |
| | | 18900 | 1880.0 | 1.1153 | 1.320 |
| | | 19193 | 1909.3 | 1.1175 | 1.343 |
| | 3 | 18615 | 1851.5 | 2.7196 | 3.022 |
| | | 18900 | 1880 | 2.7258 | 2.984 |
| | | 19185 | 1908.5 | 2.7232 | 2.987 |
| | 5 | 18625 | 1852.5 | 4.4975 | 5.311 |
| | | 18900 | 1880 | 4.5148 | 4.932 |
| | | 19175 | 1907.5 | 4.5265 | 5.677 |
| | 10 | 18650 | 1855 | 9.0436 | 9.893 |
| | | 18900 | 1880 | 9.0456 | 10.710 |
| | | 19150 | 1905 | 9.0563 | 10.920 |
| | 15 | 18675 | 1857.5 | 13.5030 | 14.530 |
| | | 18900 | 1880 | 13.5080 | 14.560 |
| | | 19125 | 1902.5 | 13.4800 | 14.590 |
| | 20 | 18700 | 1860 | 17.9050 | 19.250 |
| | | 18900 | 1880 | 17.9440 | 19.380 |
| | | 19100 | 1900 | 17.9210 | 19.090 |

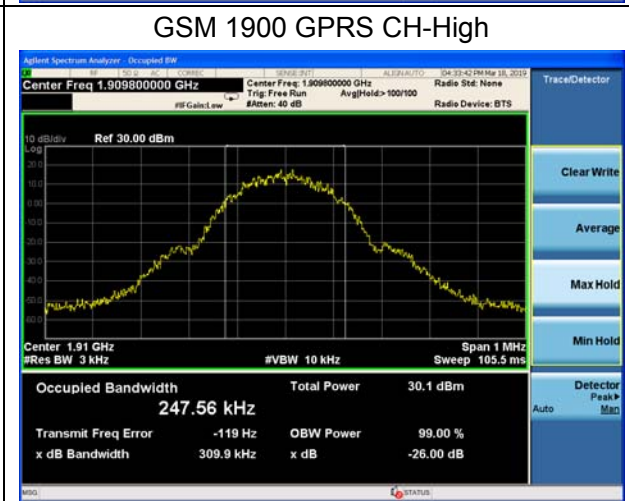
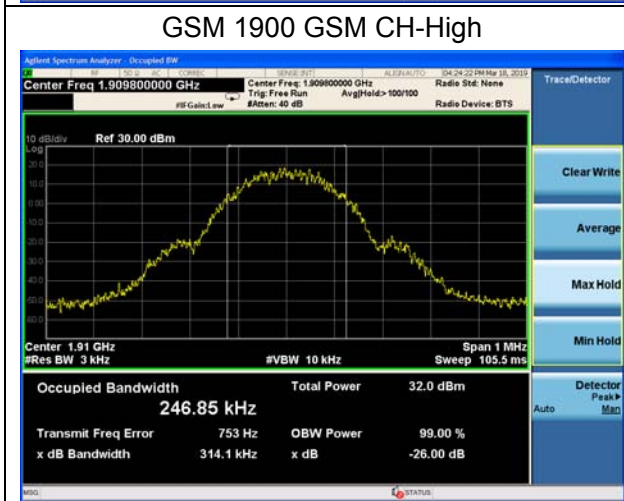
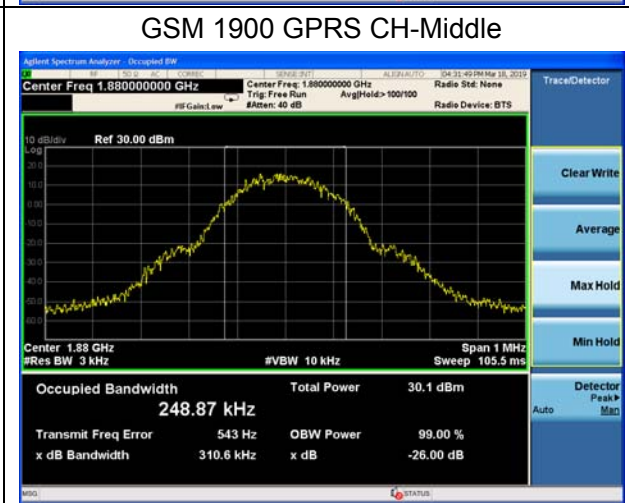
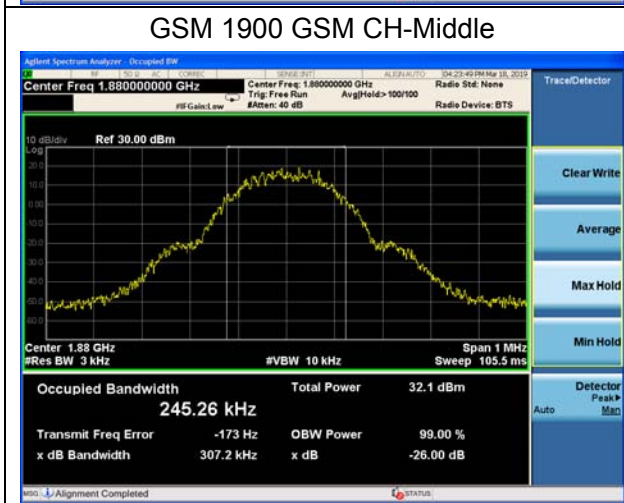
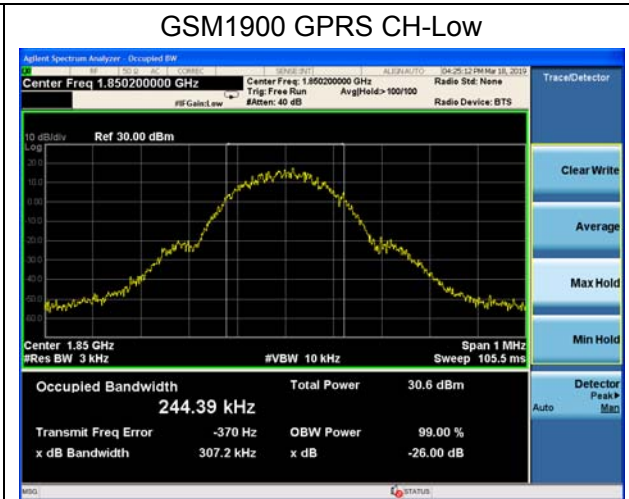

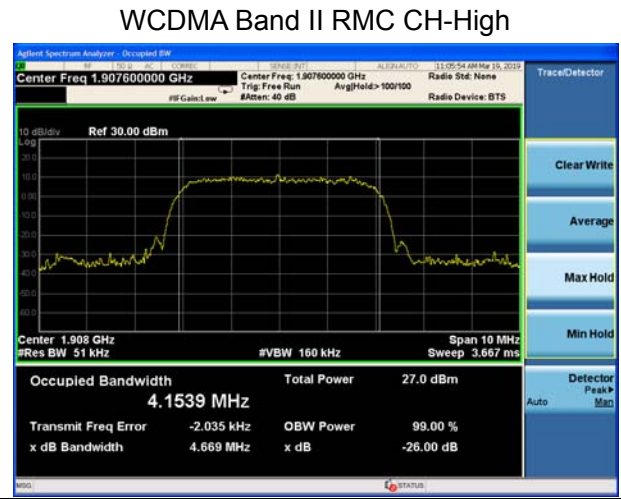
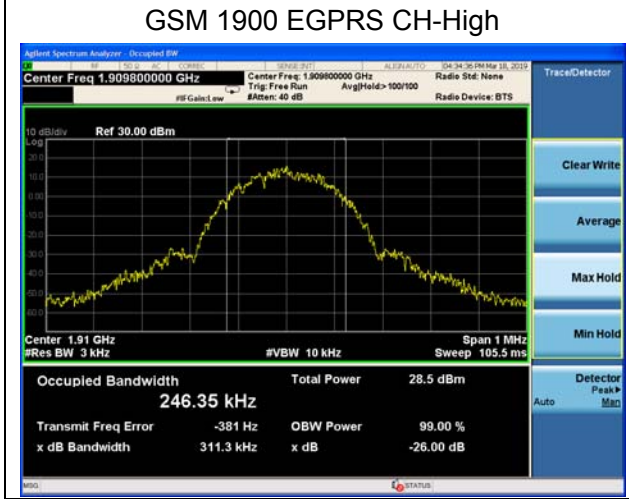
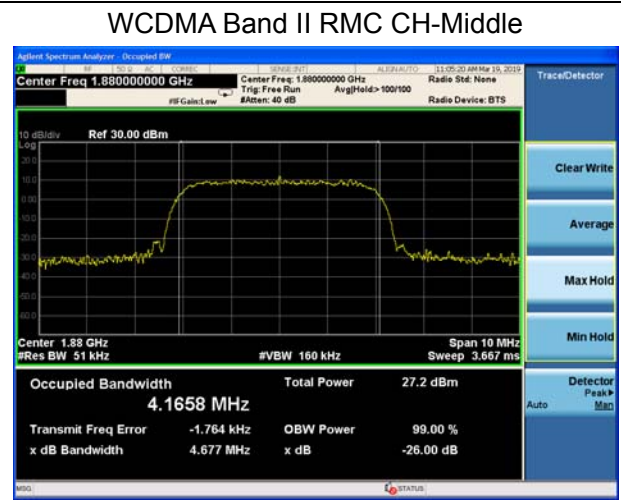
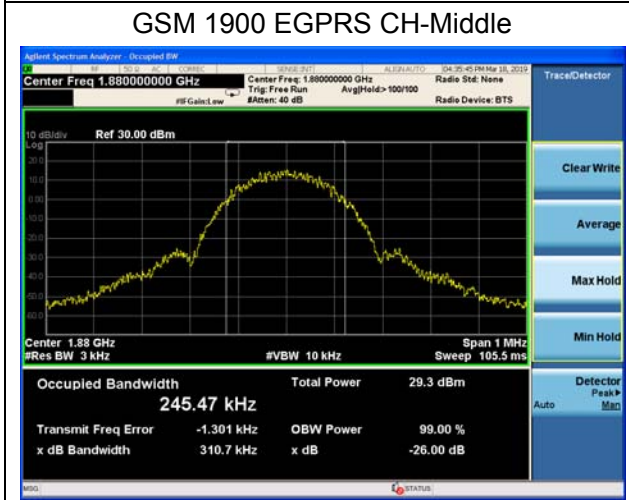
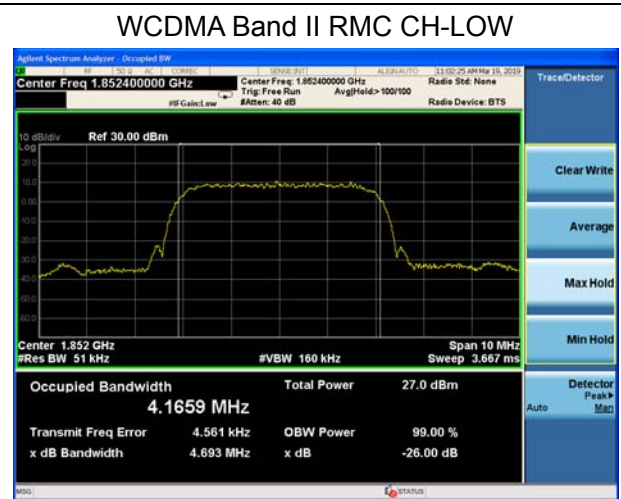
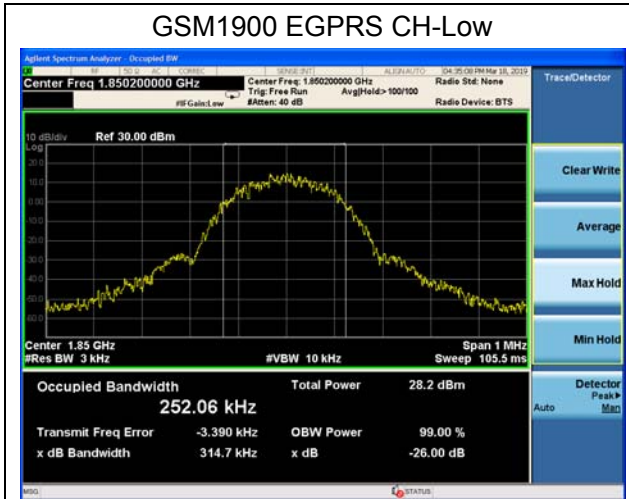

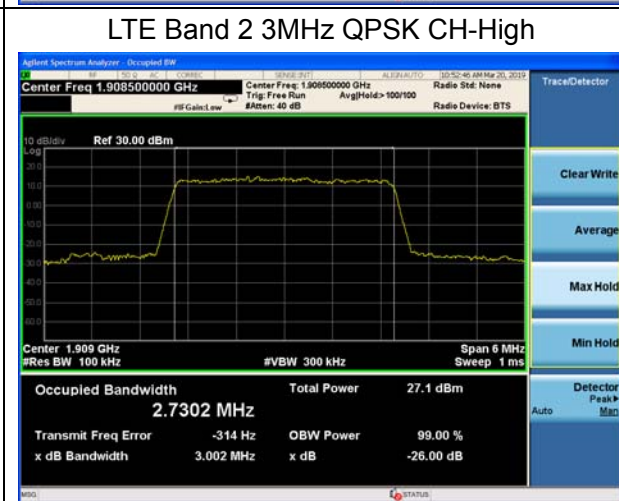
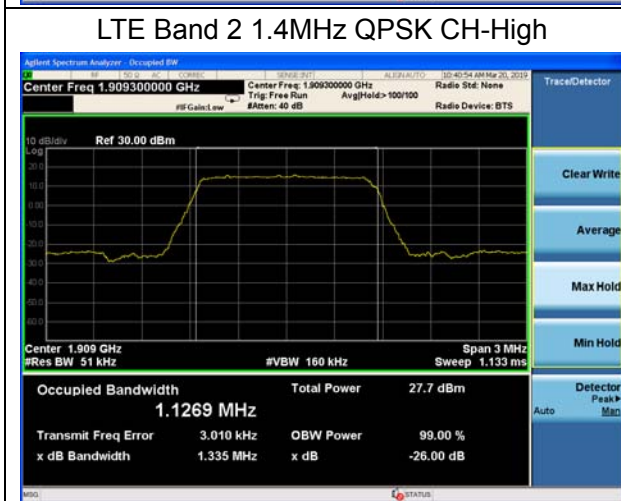
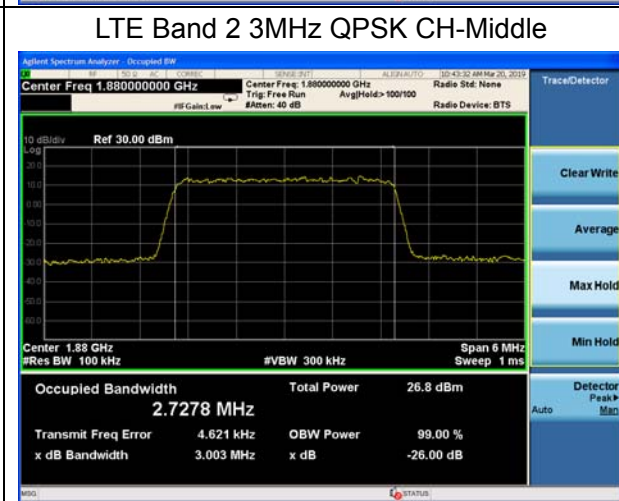
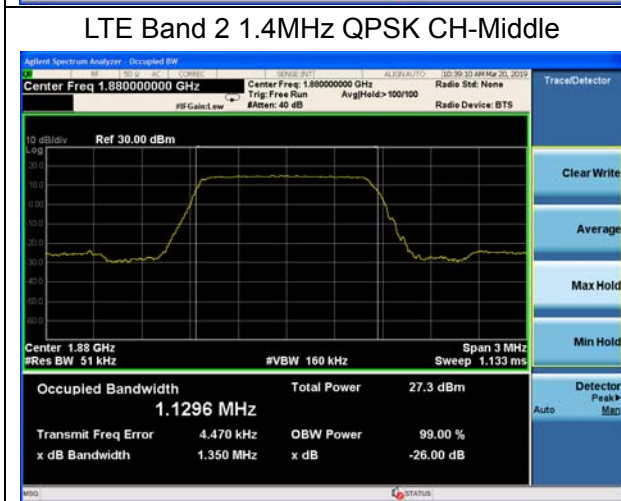
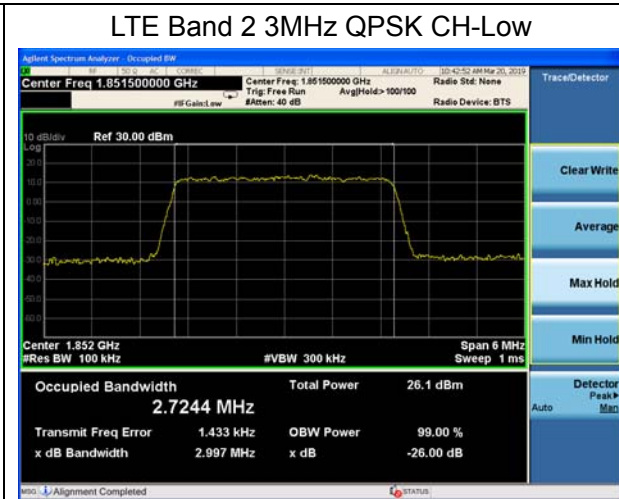
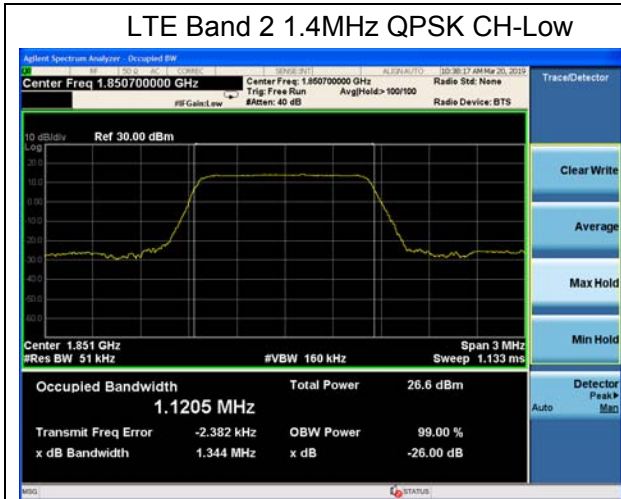

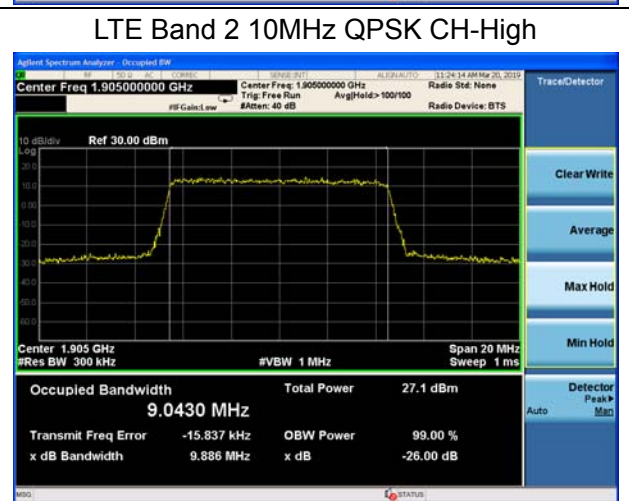
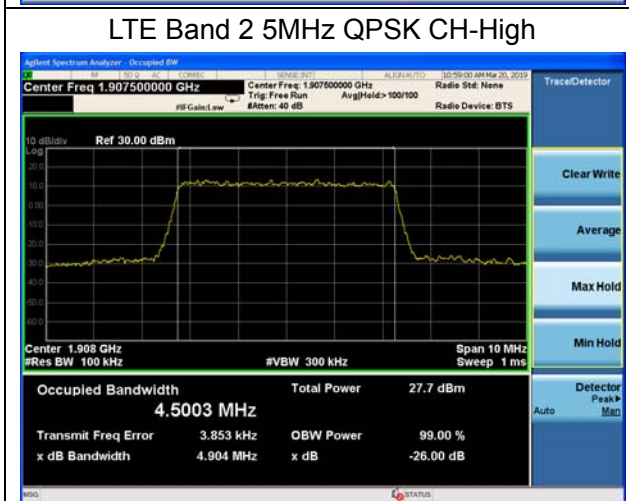
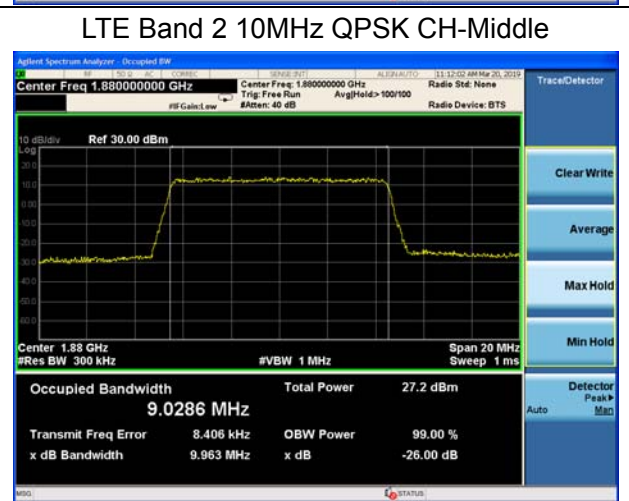
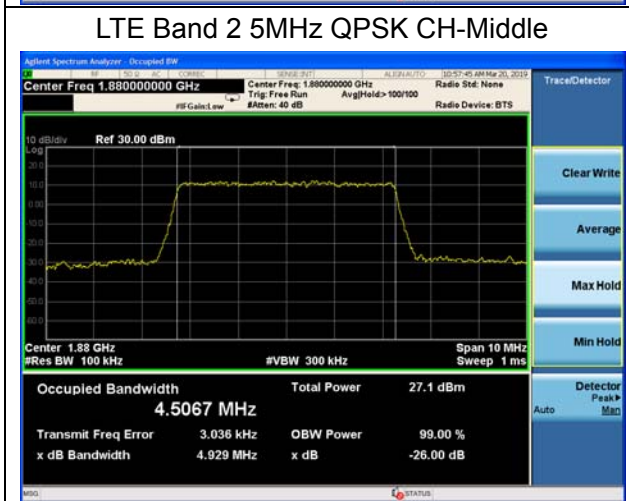
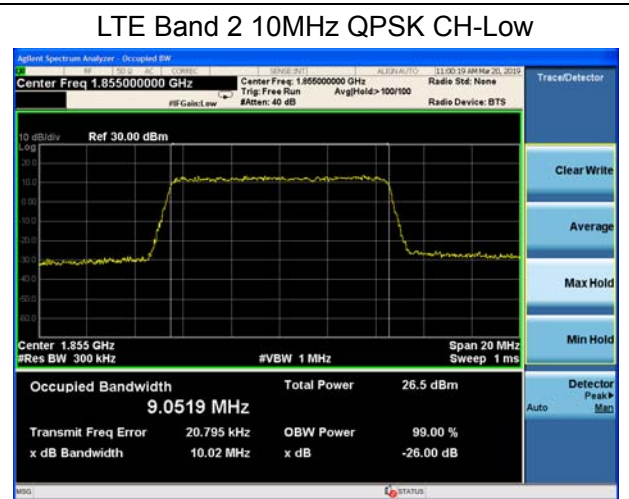
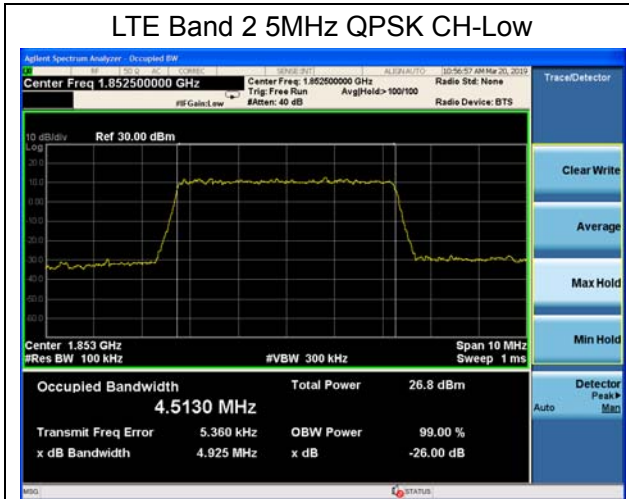

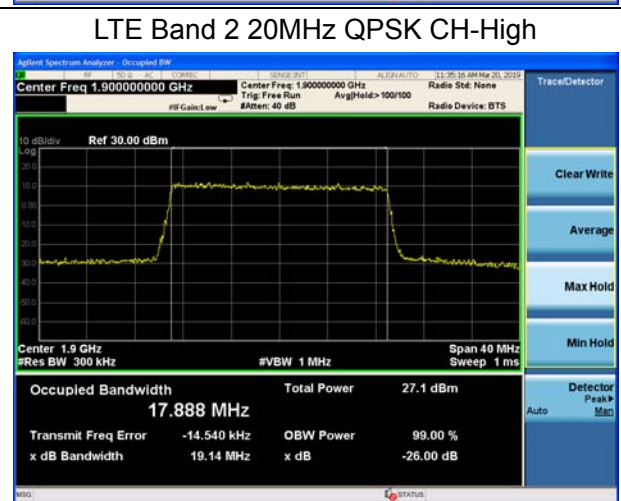
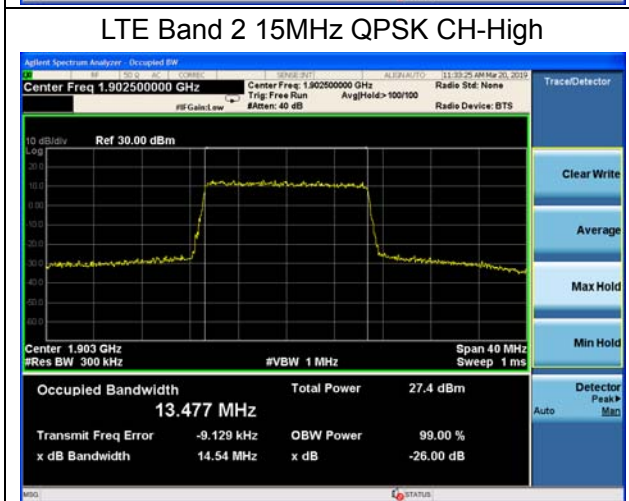
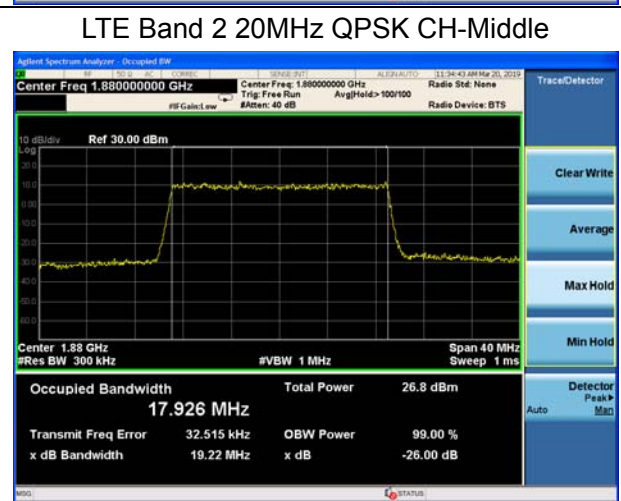
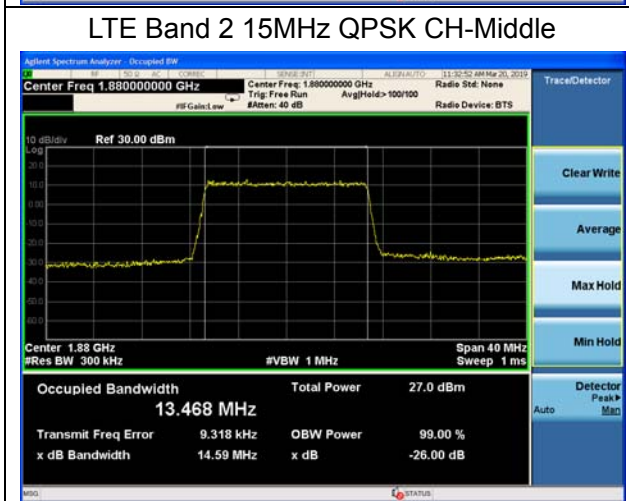
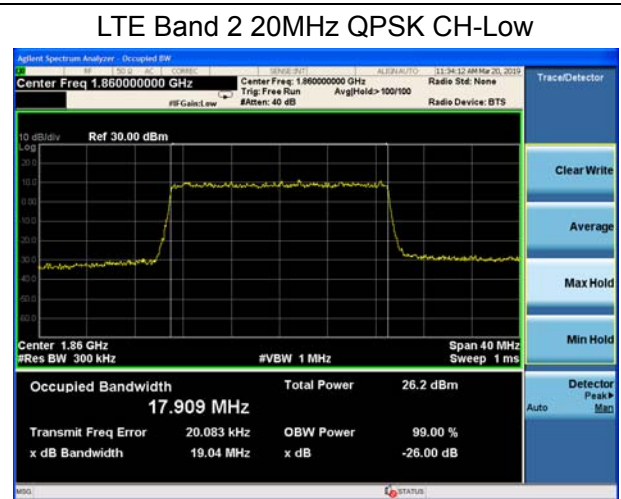
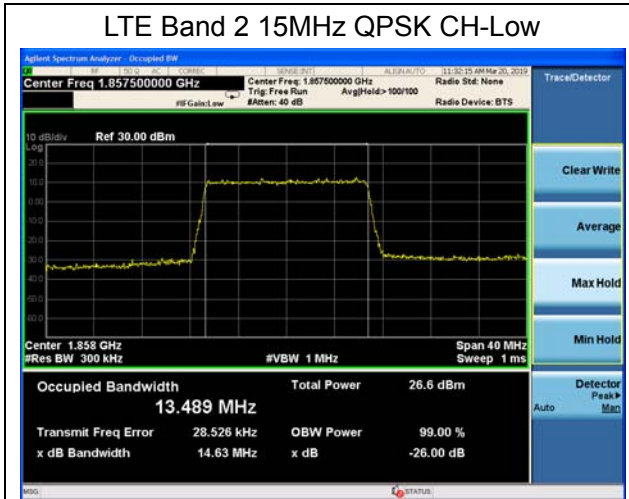

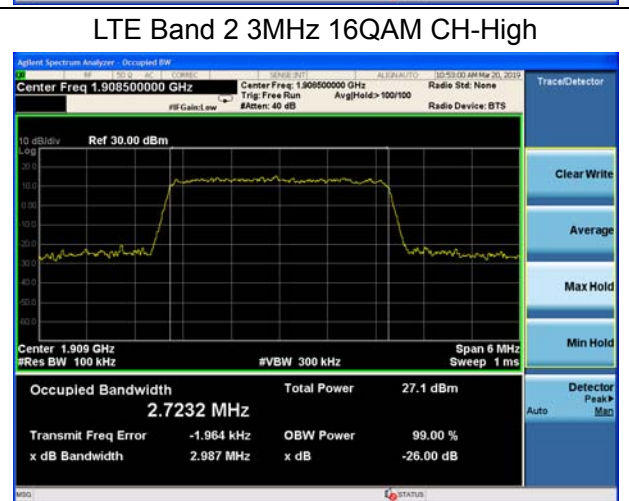
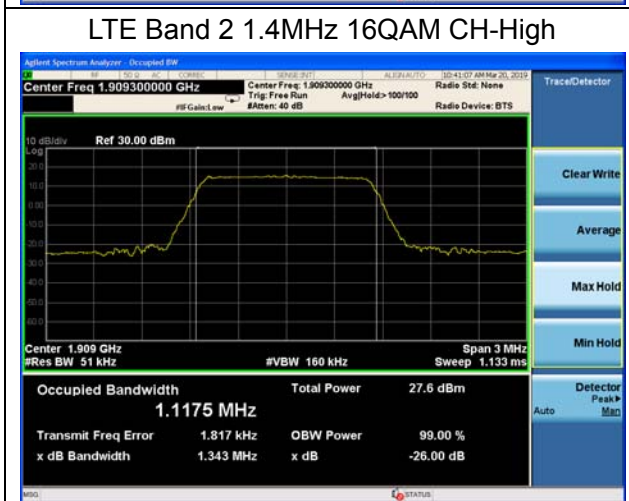
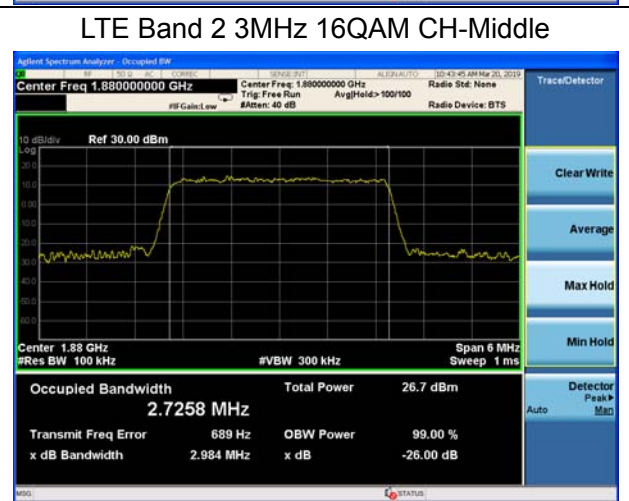
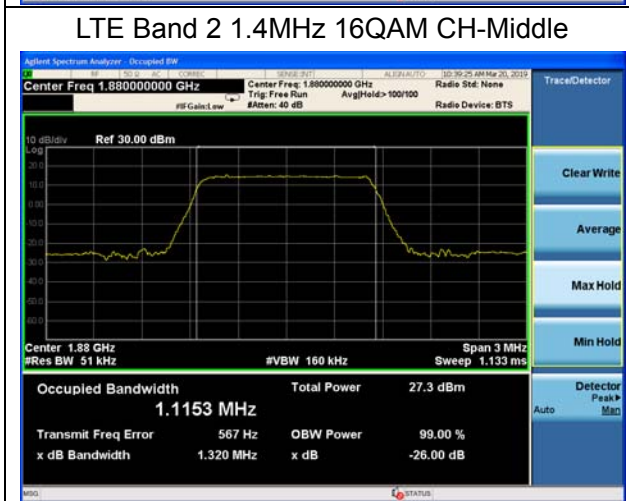
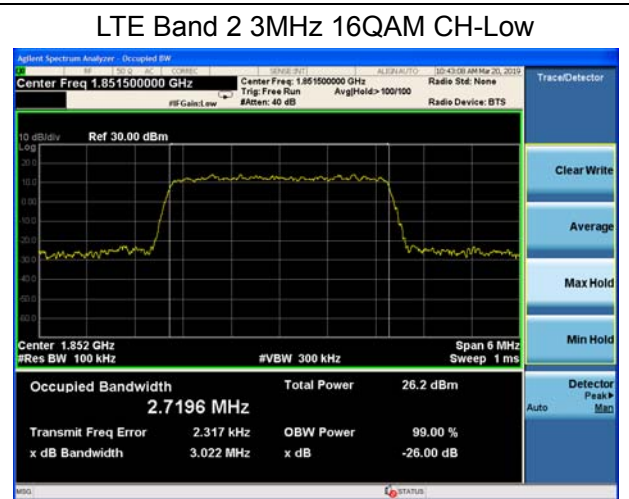
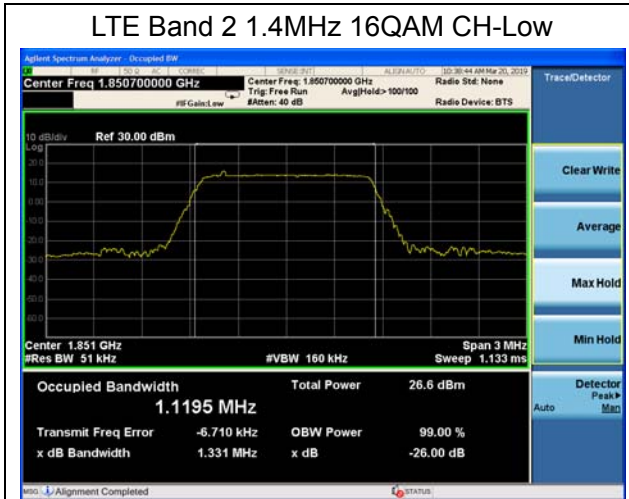

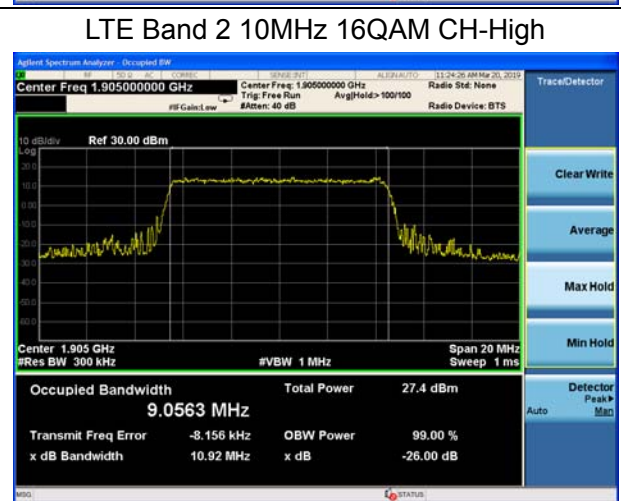
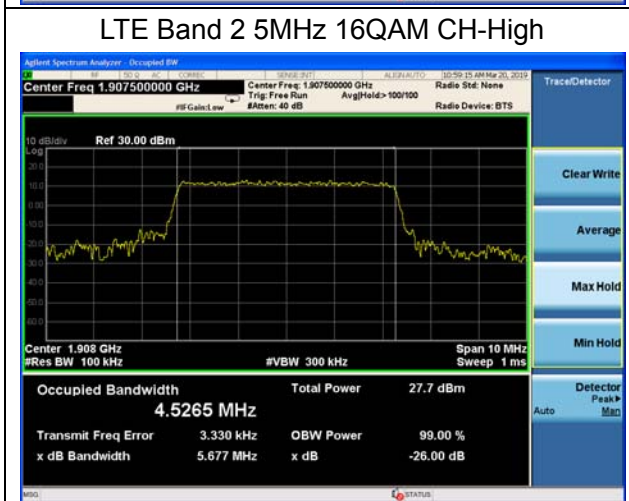
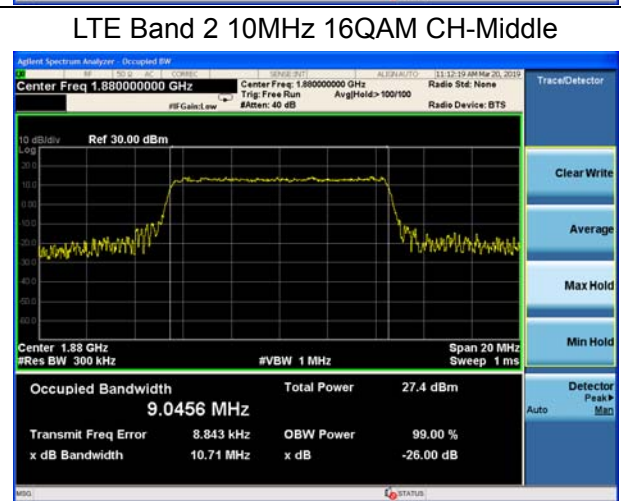
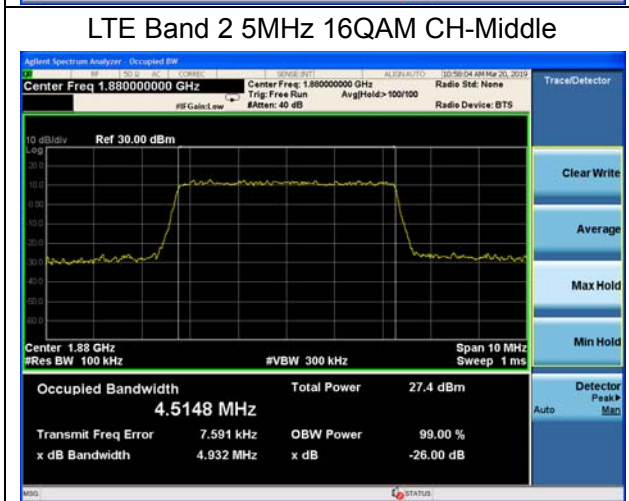
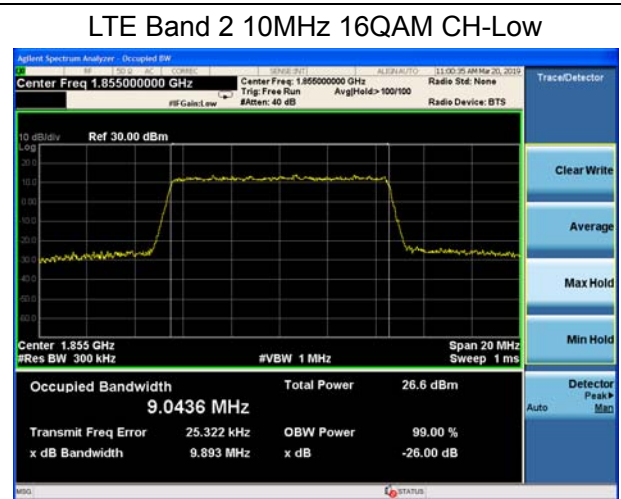
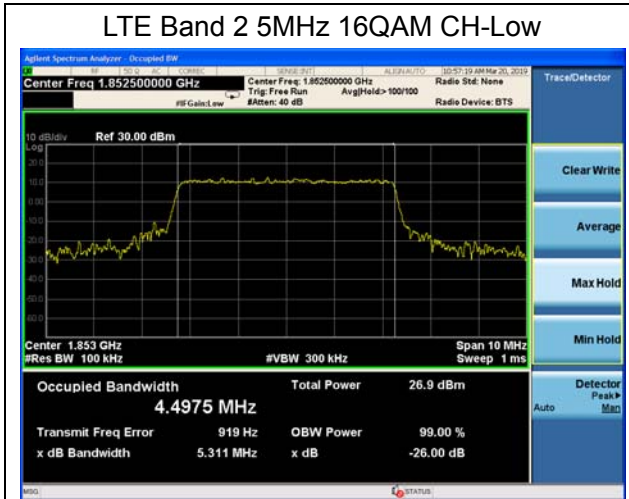

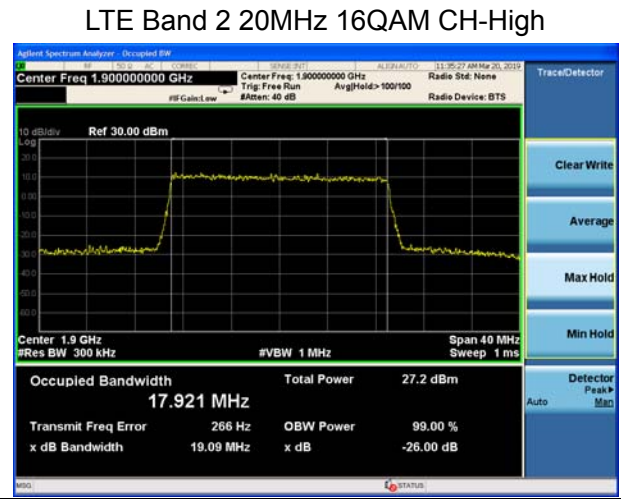
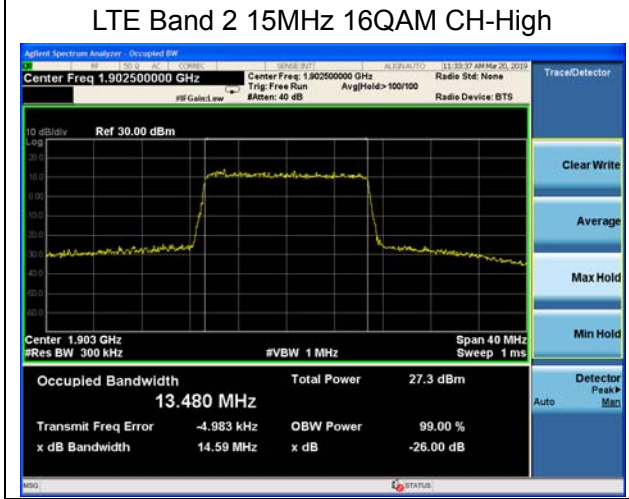
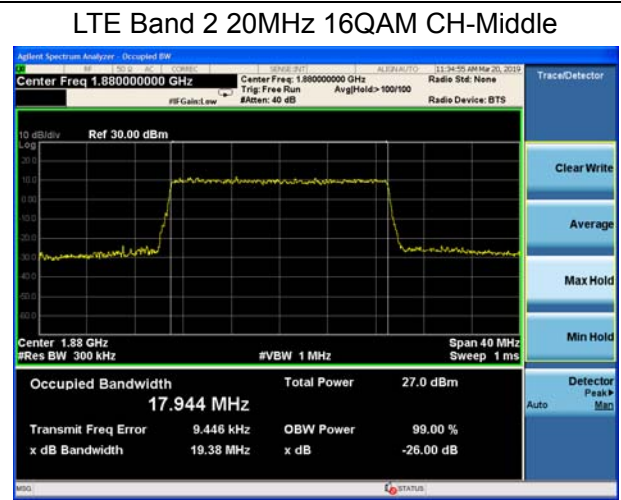
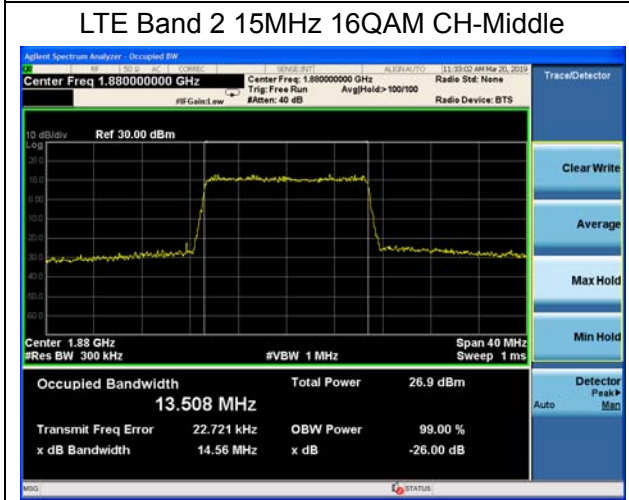
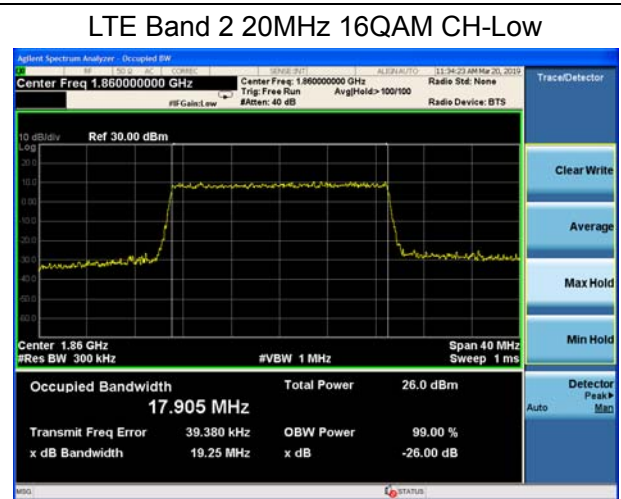
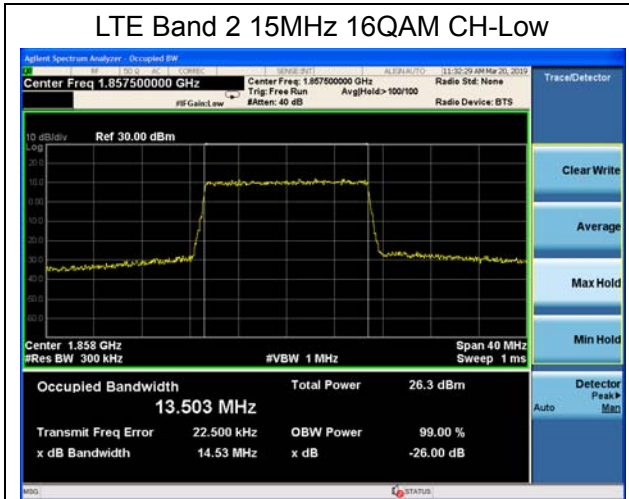

5.4. Band Edge Compliance

Ambient condition

| Temperature | Relative humidity | Pressure |
|-------------|-------------------|----------|
| 23°C ~25°C | 45%~50% | 101.5kPa |

Method of Measurement

The EUT was connected to Spectrum Analyzer and Base Station Simulator via power Splitter. The band edge of the lowest and highest channels were measured. The Average detector is used and RBW is set to 3kHz, VBW is set to 10kHz for GSM 1900, RBW is set to 51kHz, VBW is set to 160kHz for WCDMA Band II, RBW is set to 15kHz, VBW is set to 51kHz for LTE Band 2 (1.4MHz), RBW is set to 30kHz, VBW is set to 100kHz for LTE Band 2 (3MHz), RBW is set to 51kHz, VBW is set to 160kHz for LTE Band 2 (5MHz), RBW is set to 100kHz, VBW is set to 300kHz for LTE Band 2 (10MHz), RBW is set to 150kHz, VBW is set to 510kHz for LTE Band 2 (15MHz), RBW is set to 200kHz, VBW is set to 620kHz for LTE Band 2 (20MHz). Spectrum analyzer plots are included on the following pages.

Test Setup

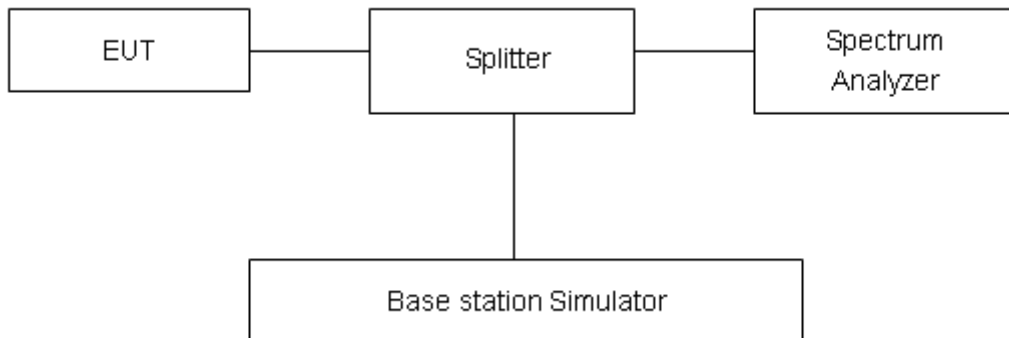

Limits

Rule Part 24.238(a) specifies that “on any frequency outside a licensee’s frequency block, the power of any emission shall be attenuated below the transmitter power (P) by at least 43 + 10 log10 (P) dB.”

| | |
|-------|---------|
| Limit | -13 dBm |
|-------|---------|

Measurement Uncertainty

The assessed measurement uncertainty to ensure 95% confidence level for the normal distribution is with the coverage factor $k = 1.96$, $U=0.684$ dB.



Test Result:

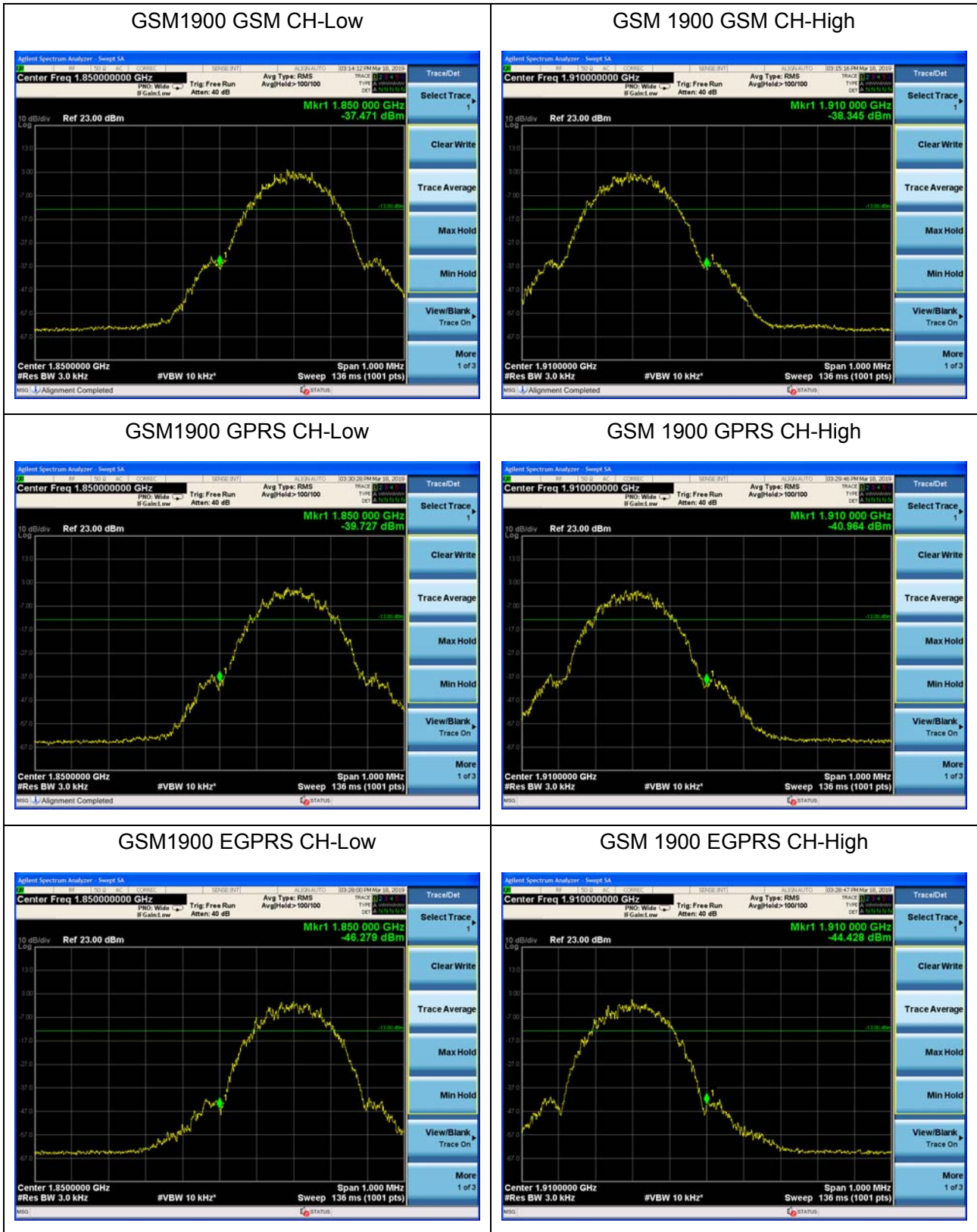



WCDMA Band II RMC CH-Low



WCDMA Band II RMC CH-High



LTE Band 2 1.4MHz QPSK 1RB CH-Low

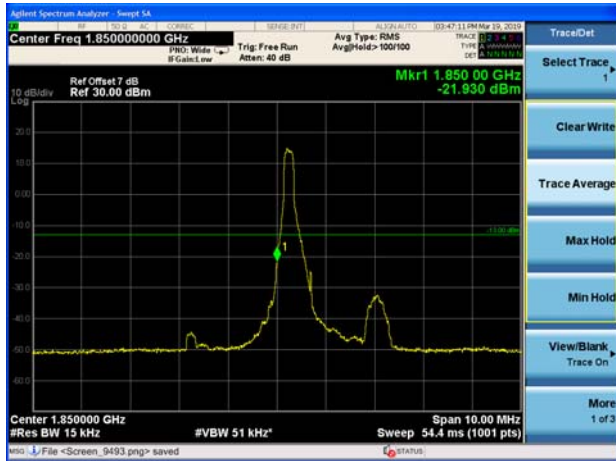

LTE Band 2 1.4MHz QPSK 1RB CH-High

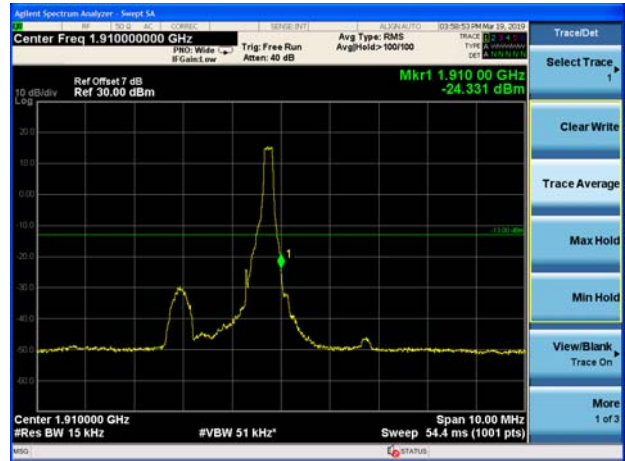

LTE Band 2 1.4MHz QPSK 100%RB CH-Low



LTE Band 2 1.4MHz QPSK 100%RB CH-High

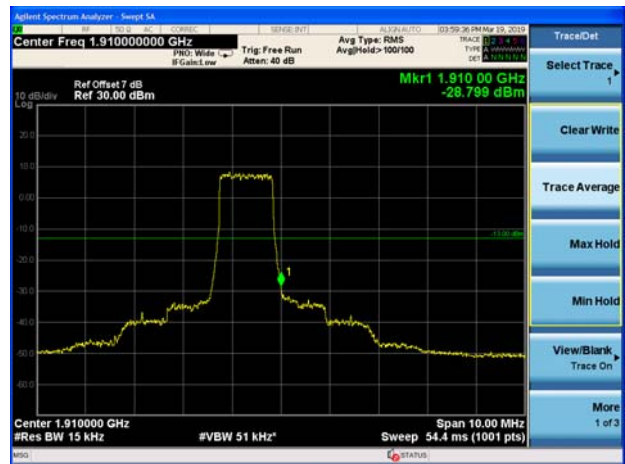

LTE Band 2 3MHz QPSK 1RB CH-Low

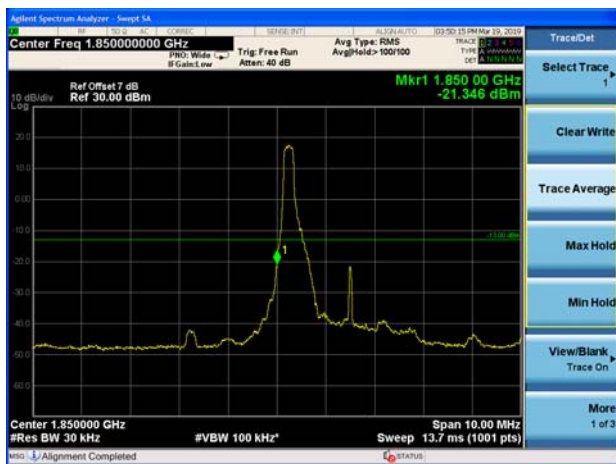

LTE Band 2 3MHz QPSK 1RB CH-High

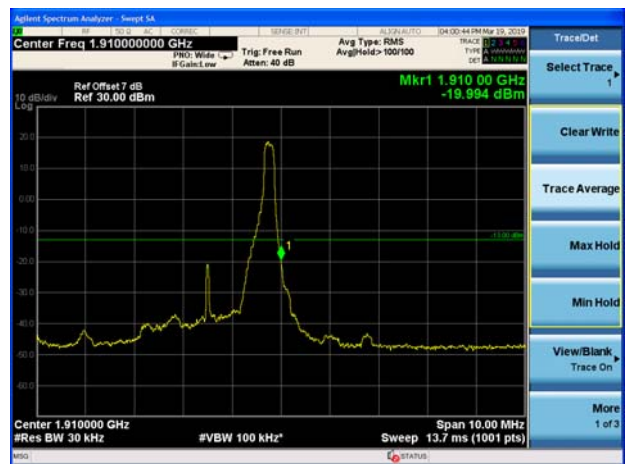



LTE Band 2 3MHz QPSK 100%RB CH-Low

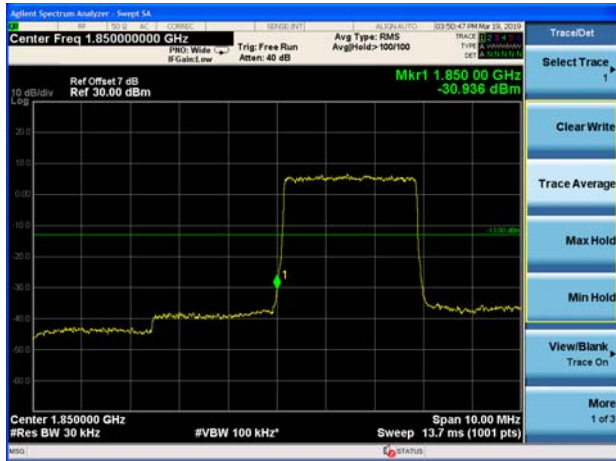

LTE Band 2 3MHz QPSK 100%RB CH-High



LTE Band 2 5MHz QPSK 1RB CH-Low



LTE Band 2 5MHz QPSK 1RB CH-High

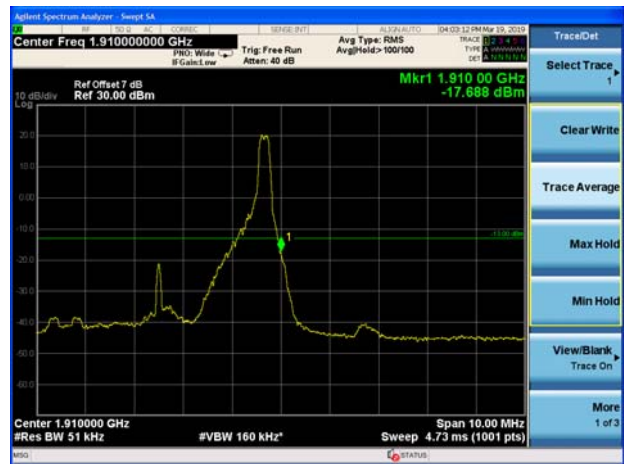

LTE Band 2 5MHz QPSK 100%RB CH-Low

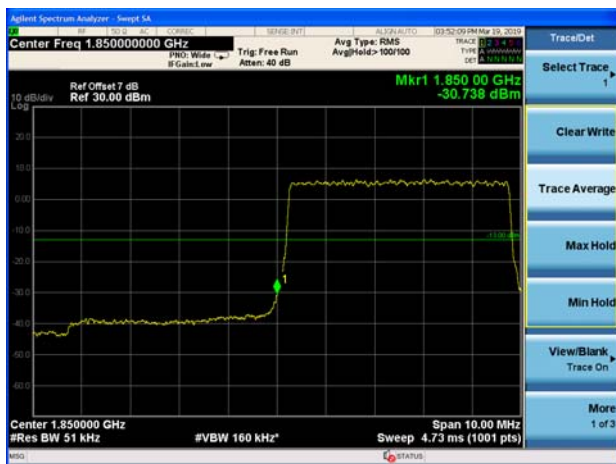

LTE Band 2 5MHz QPSK 100%RB CH-High





LTE Band 2 10MHz QPSK 1RB CH-Low

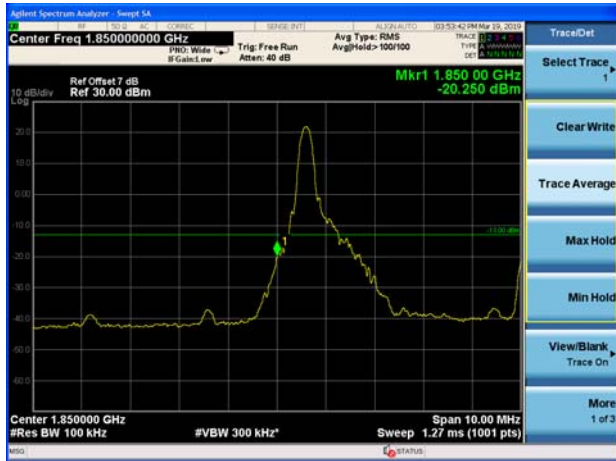

LTE Band 2 10MHz QPSK 1RB CH-High

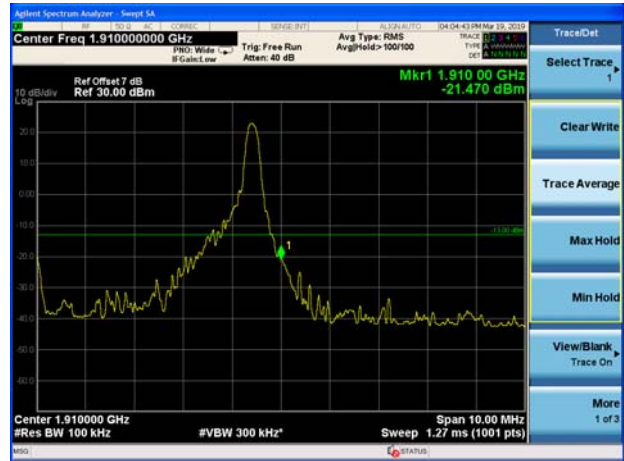

LTE Band 2 10MHz QPSK 100%RB CH-Low

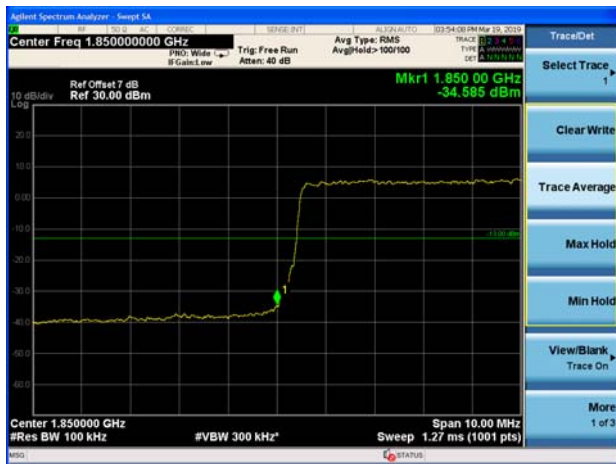

LTE Band 2 10MHz QPSK 100%RB CH-High



LTE Band 2 15MHz QPSK 1RB CH-Low

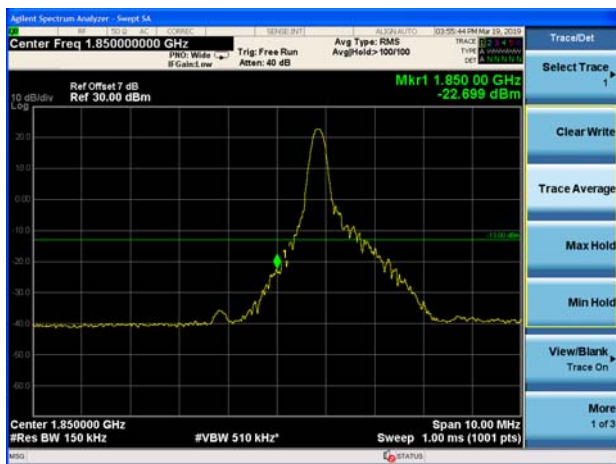

LTE Band 2 15MHz QPSK 1RB CH-High

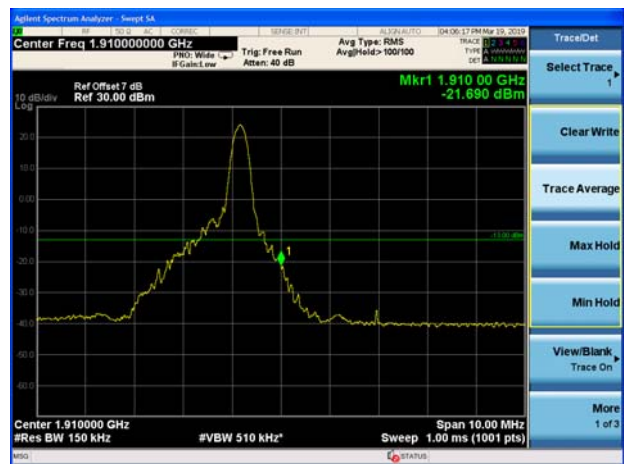



LTE Band 2 15MHz QPSK 100%RB CH-Low



LTE Band 2 15MHz QPSK 100%RB CH-High



LTE Band 2 20MHz QPSK 1RB CH-Low

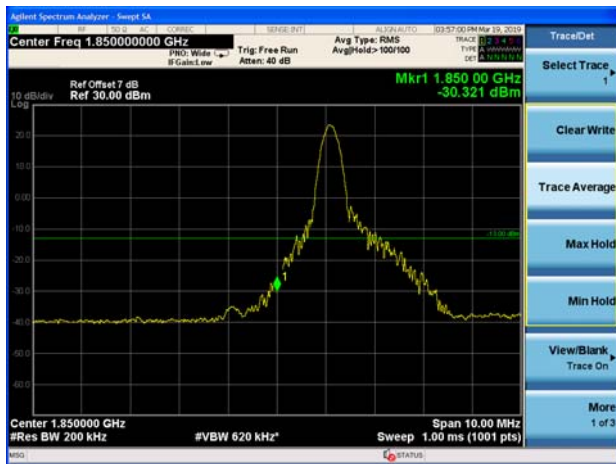

LTE Band 2 20MHz QPSK 1RB CH-High

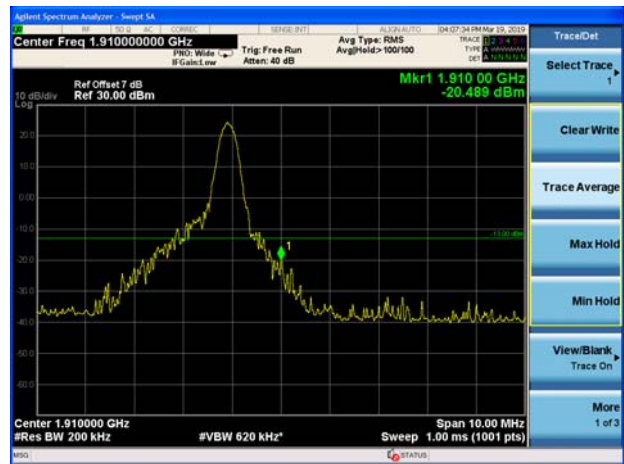

LTE Band 2 20MHz QPSK 100%RB CH-Low



LTE Band 2 20MHz QPSK 100%RB CH-High



LTE Band 2 1.4MHz 16QAM 1RB CH-Low

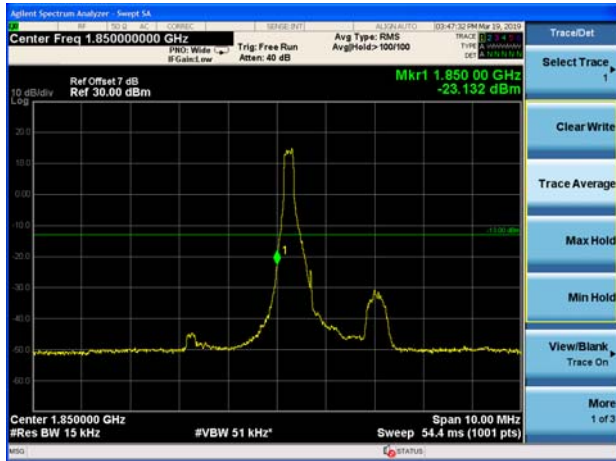

LTE Band 2 1.4MHz 16QAM 1RB CH-High

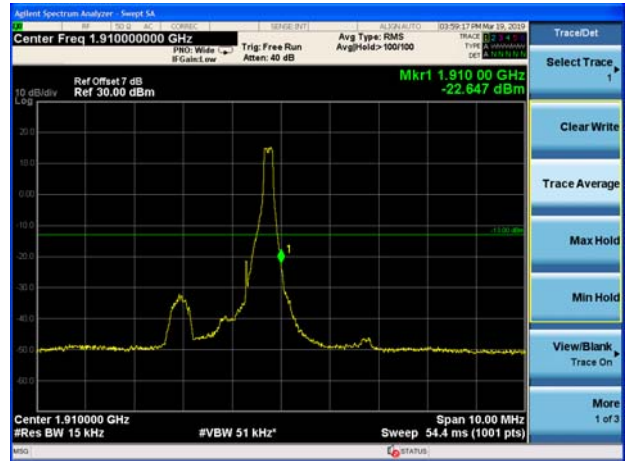

LTE Band 2 1.4MHz 16QAM 100%RB CH-Low

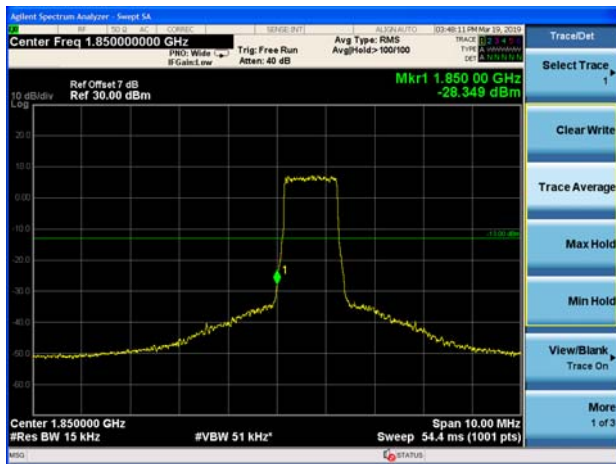

LTE Band 2 1.4MHz 16QAM 100%RB CH-High

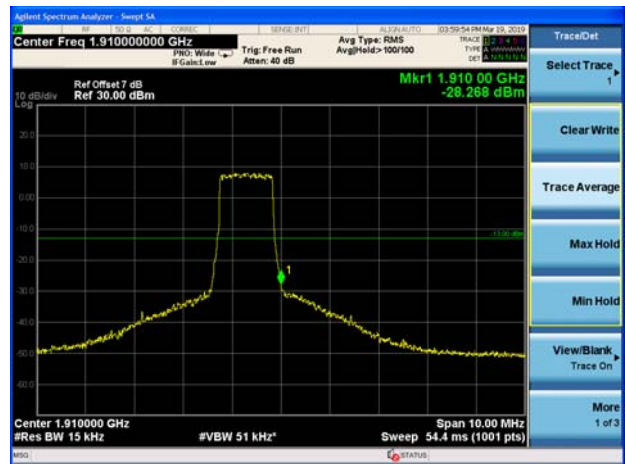

LTE Band 2 3MHz 16QAM 1RB CH-Low

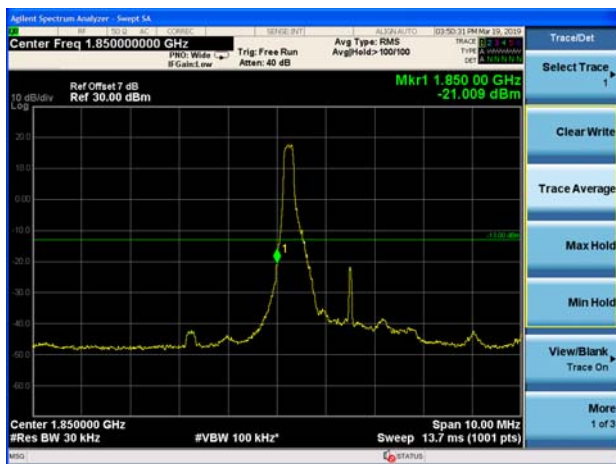

LTE Band 2 3MHz 16QAM 1RB CH-High



LTE Band 2 3MHz 16QAM 100%RB CH-Low



LTE Band 2 3MHz 16QAM 100%RB CH-High

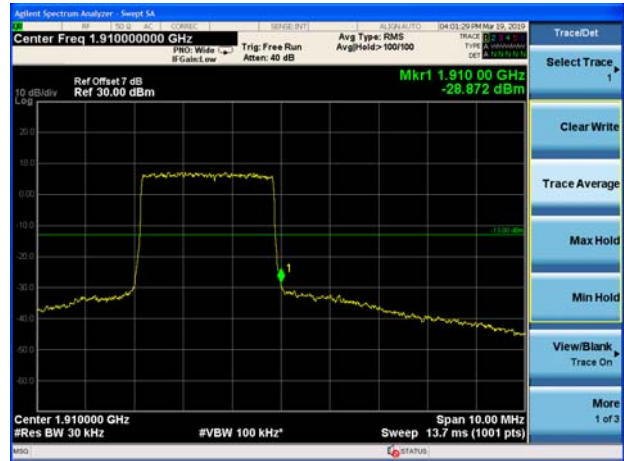

LTE Band 2 5MHz 16QAM 1RB CH-Low

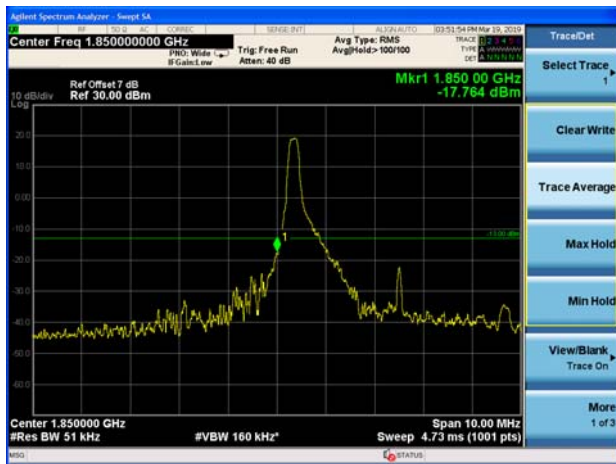

LTE Band 2 5MHz 16QAM 1RB CH-High

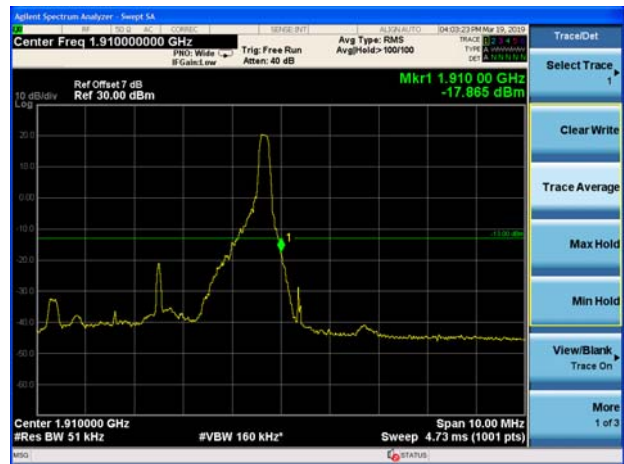

LTE Band 2 5MHz 16QAM 100%RB CH-Low



LTE Band 2 5MHz 16QAM 100%RB CH-High





LTE Band 2 10MHz 16QAM 1RB CH-Low

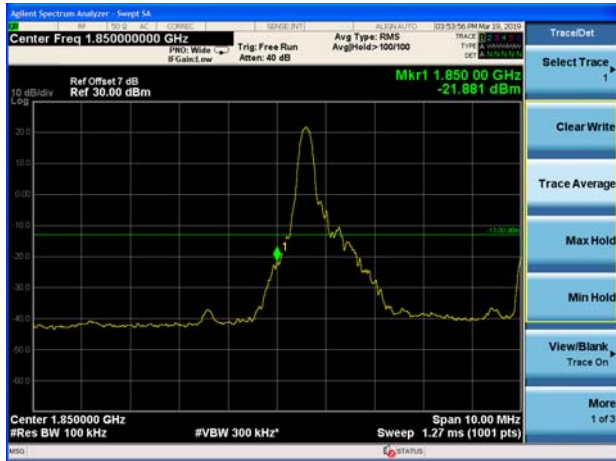

LTE Band 2 10MHz 16QAM 1RB CH-High

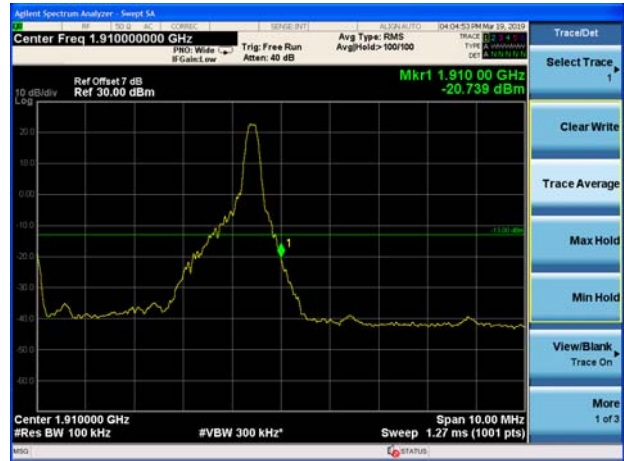

LTE Band 2 10MHz 16QAM 100%RB CH-Low



LTE Band 2 10MHz 16QAM 100%RB CH-High

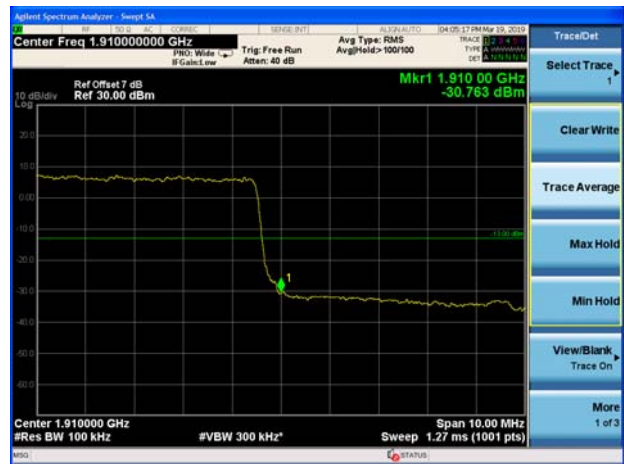

LTE Band 2 15MHz 16QAM 1RB CH-Low

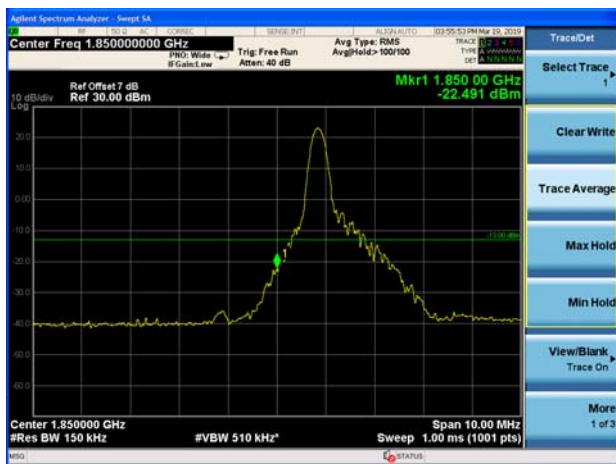

LTE Band 2 15MHz 16QAM 1RB CH-High

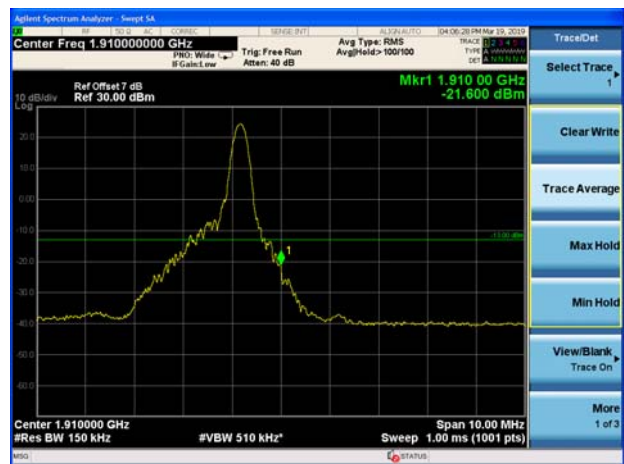



LTE Band 2 15MHz 16QAM 100%RB CH-Low



LTE Band 2 15MHz 16QAM 100%RB CH-High



LTE Band 2 20MHz 16QAM 1RB CH-Low

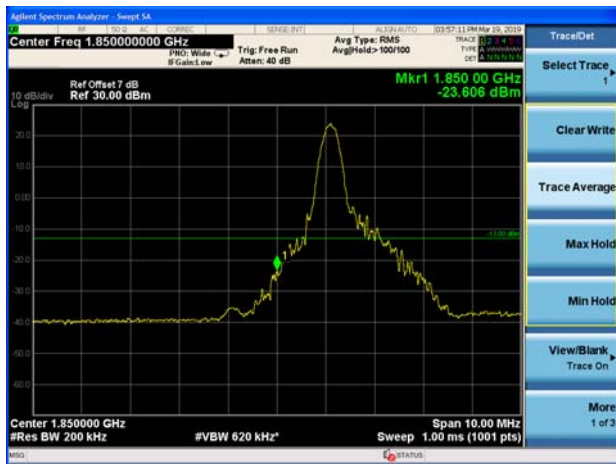

LTE Band 2 20MHz 16QAM 1RB CH-High

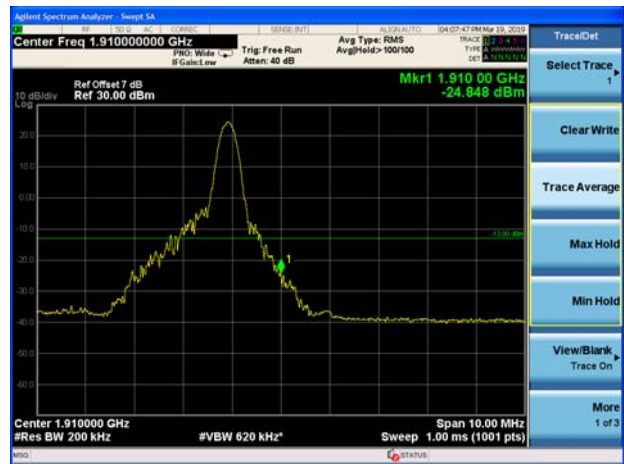

LTE Band 2 20MHz 16QAM 100%RB CH-Low

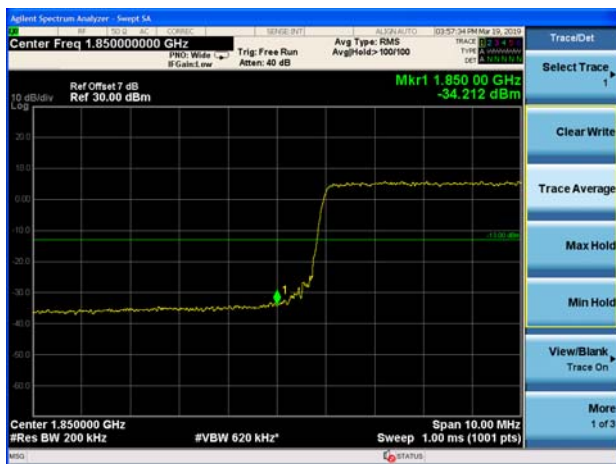

LTE Band 2 20MHz 16QAM 100%RB CH-High

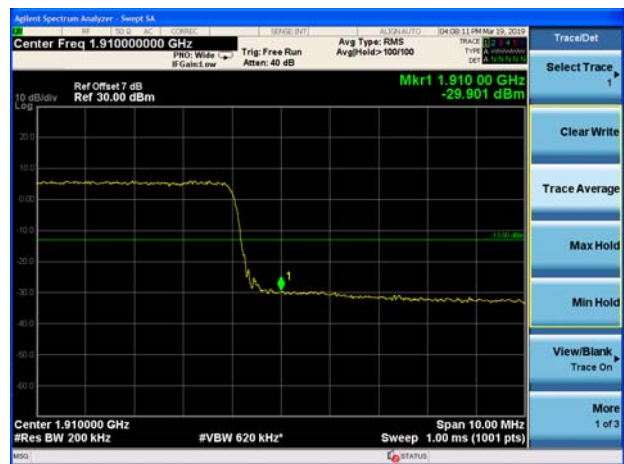

5.5. Peak-to-Average Power Ratio (PAPR)

Ambient condition

| Temperature | Relative humidity | Pressure |
|-------------|-------------------|----------|
| 23°C ~25°C | 45%~50% | 101.5kPa |

Methods of Measurement

Measure the total peak power and record as PPk. And measure the total average power and record as PAvg. Both the peak and average power levels must be expressed in the same logarithmic units (e.g., dBm). Determine the PAPR from:

$$PAPR (dB) = PPk (dBm) - PAvg (dBm).$$

Test Setup

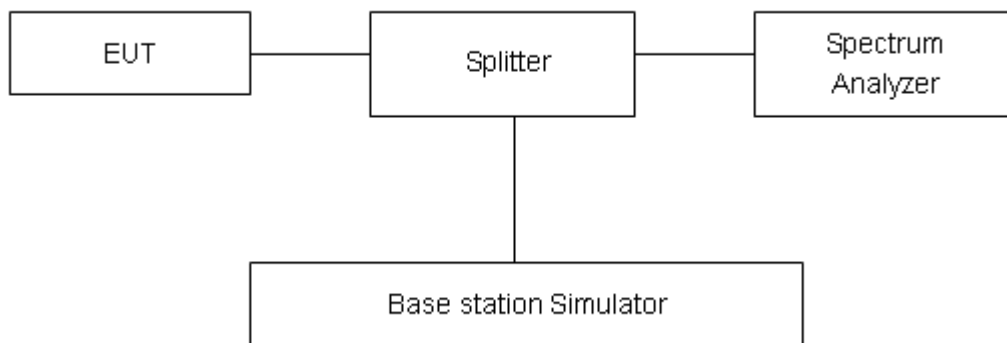

Limits

In measuring transmissions in this band using an average power technique, the peak-to-average ratio (PAR) of the transmission may not exceed 13 dB in 24.232(d).

Measurement Uncertainty

The assessed measurement uncertainty to ensure 95% confidence level for the normal distribution is with the coverage factor $k = 2$, $U = 0.4$ dB.

**Test Results**

| Mode | Channel | Frequency (MHz) | Peak(dBm) | Avg(dBm) | PAPR(dB) | Limit(dB) | Conclusion |
|----------------------------|---------|-----------------|-----------|----------|----------|-----------|------------|
| GSM 1900 (GSM) | 512 | 1850.2 | 30.87 | 29.99 | 0.88 | ≤13 | PASS |
| | 661 | 1880 | 30.75 | 29.79 | 0.96 | ≤13 | PASS |
| | 810 | 1909.8 | 30.58 | 29.68 | 0.90 | ≤13 | PASS |
| GPRS 1900 (GMSK) | 512 | 1850.2 | 27.09 | 26.12 | 0.97 | ≤13 | PASS |
| | 661 | 1880 | 27.02 | 26.01 | 1.01 | ≤13 | PASS |
| | 810 | 1909.8 | 26.91 | 25.97 | 0.94 | ≤13 | PASS |
| EGPRS 1900 (8-PSK) | 512 | 1850.2 | 24.35 | 23.34 | 1.01 | ≤13 | PASS |
| | 661 | 1880 | 24.22 | 23.27 | 0.95 | ≤13 | PASS |
| | 810 | 1909.8 | 24.09 | 23.11 | 0.98 | ≤13 | PASS |
| WCDMA Band II (RMC) | 9262 | 1852.4 | 21.48 | 18.39 | 3.09 | ≤13 | PASS |
| | 9400 | 1880 | 21.73 | 18.50 | 3.23 | ≤13 | PASS |
| | 9538 | 1907.6 | 21.83 | 18.55 | 3.28 | ≤13 | PASS |



| LTE Band 2 | | | | | | | | |
|------------|-----------------|---------|-----------------|------------|-----------|-----------|------------|------------|
| Modulation | Bandwidth (MHz) | Channel | Frequency (MHz) | Peak (dBm) | Avg (dBm) | PAPR (dB) | Limit (dB) | Conclusion |
| QPSK | 1.4 | 18607 | 1850.7 | 24.81 | 19.22 | 5.59 | ≤13 | PASS |
| | | 18900 | 1880.0 | 25.18 | 19.48 | 5.70 | ≤13 | PASS |
| | | 19193 | 1909.3 | 25.17 | 19.39 | 5.78 | ≤13 | PASS |
| | 3 | 18615 | 1851.5 | 24.71 | 19.07 | 5.64 | ≤13 | PASS |
| | | 18900 | 1880 | 25.08 | 19.35 | 5.73 | ≤13 | PASS |
| | | 19185 | 1908.5 | 25.15 | 19.41 | 5.74 | ≤13 | PASS |
| | 5 | 18625 | 1852.5 | 24.74 | 19.06 | 5.68 | ≤13 | PASS |
| | | 18900 | 1880 | 25.09 | 19.23 | 5.86 | ≤13 | PASS |
| | | 19175 | 1907.5 | 25.41 | 19.64 | 5.77 | ≤13 | PASS |
| | 10 | 18650 | 1855 | 25.03 | 19.39 | 5.64 | ≤13 | PASS |
| | | 18900 | 1880 | 25.06 | 19.25 | 5.81 | ≤13 | PASS |
| | | 19150 | 1905 | 25.13 | 19.41 | 5.72 | ≤13 | PASS |
| | 15 | 18675 | 1857.5 | 25.09 | 19.12 | 5.97 | ≤13 | PASS |
| | | 18900 | 1880 | 25.42 | 19.23 | 6.19 | ≤13 | PASS |
| | | 19125 | 1902.5 | 25.60 | 19.50 | 6.10 | ≤13 | PASS |
| | 20 | 18700 | 1860 | 24.90 | 19.21 | 5.69 | ≤13 | PASS |
| | | 18900 | 1880 | 25.19 | 19.32 | 5.87 | ≤13 | PASS |
| | | 19100 | 1900 | 25.29 | 19.46 | 5.83 | ≤13 | PASS |
| 16QAM | 1.4 | 18607 | 1850.7 | 25.33 | 19.27 | 6.06 | ≤13 | PASS |
| | | 18900 | 1880.0 | 26.01 | 19.57 | 6.44 | ≤13 | PASS |
| | | 19193 | 1909.3 | 25.26 | 18.92 | 6.34 | ≤13 | PASS |
| | 3 | 18615 | 1851.5 | 25.14 | 18.92 | 6.22 | ≤13 | PASS |
| | | 18900 | 1880 | 25.62 | 19.18 | 6.44 | ≤13 | PASS |
| | | 19185 | 1908.5 | 25.84 | 19.46 | 6.38 | ≤13 | PASS |
| | 5 | 18625 | 1852.5 | 25.25 | 19.10 | 6.15 | ≤13 | PASS |
| | | 18900 | 1880 | 25.76 | 19.35 | 6.41 | ≤13 | PASS |
| | | 19175 | 1907.5 | 26.14 | 19.78 | 6.36 | ≤13 | PASS |
| | 10 | 18650 | 1855 | 25.32 | 19.13 | 6.19 | ≤13 | PASS |
| | | 18900 | 1880 | 25.69 | 19.26 | 6.43 | ≤13 | PASS |
| | | 19150 | 1905 | 25.75 | 19.46 | 6.29 | ≤13 | PASS |
| | 15 | 18675 | 1857.5 | 25.32 | 19.05 | 6.27 | ≤13 | PASS |
| | | 18900 | 1880 | 25.77 | 19.25 | 6.52 | ≤13 | PASS |
| | | 19125 | 1902.5 | 25.82 | 19.44 | 6.38 | ≤13 | PASS |
| | 20 | 18700 | 1860 | 25.38 | 19.12 | 6.26 | ≤13 | PASS |
| | | 18900 | 1880 | 25.78 | 19.30 | 6.48 | ≤13 | PASS |
| | | 19100 | 1900 | 25.96 | 19.56 | 6.40 | ≤13 | PASS |

5.6. Frequency Stability

Ambient condition

| Temperature | Relative humidity | Pressure |
|-------------|-------------------|----------|
| 23°C ~25°C | 45%~50% | 101.5kPa |

Method of Measurement

Frequency Stability (Temperature Variation)

The temperature inside the climate chamber is varied from -30°C to +55°C in 10°C step size,

(1) With all power removed, the temperature was decreased to 0°C and permitted to stabilize for three hours.

(2) Measure the carrier frequency with the test equipment in a “call mode”. These measurements should be made within 1 minute of powering up the mobile station, to prevent significant self warming.

(3) Repeat the above measurements at 10°C increments from -30°C to +55°C. Allow at least 1.5 hours at each temperature, un-powered, before making measurements.

Frequency Stability (Voltage Variation)

The frequency stability shall be measured with variation of primary supply voltage as follows:

(1) Vary primary supply voltage from 85 to 115 percent of the nominal value for other than hand carried battery equipment.

(2) For hand carried, battery powered equipment, reduce primary supply voltage to the battery-operating end point which shall be specified by the manufacturer.

This transceiver is specified to operate with an input voltage of between 3.6 V and 4.4 V, with a nominal voltage of 3.82V.

Test setup

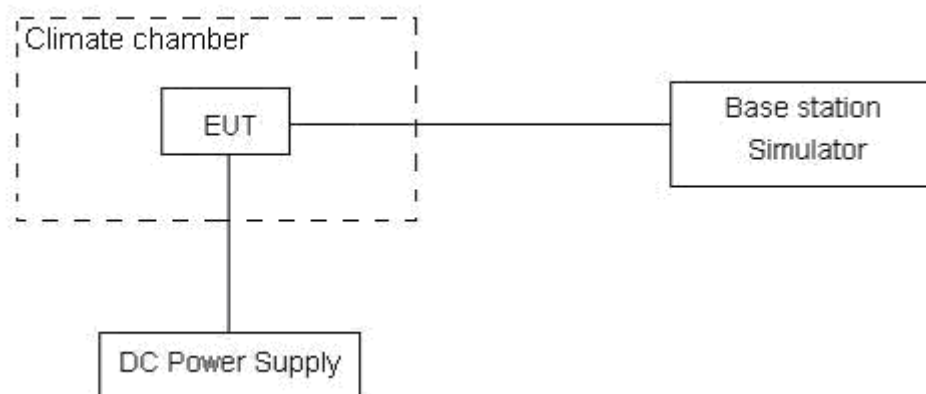

**Limits**

The frequency stability shall be sufficient to ensure that the fundamental emission stays within the authorized frequency block

Measurement Uncertainty

The assessed measurement uncertainty to ensure 99.75% confidence level for the normal distribution is with the coverage factor $k = 3$, $U = 0.01\text{ppm}$.



Test Result

| GSM1900 | | | | | | |
|-----------------|---------|-----------------|-----------------|---------------------------|---------------------------|---------|
| Condition | | Freq.Error (Hz) | Freq.Error (Hz) | Frequency Stability (ppm) | Frequency Stability (ppm) | Verdict |
| Temperature | Voltage | | | | | |
| Normal (25°C) | Normal | 11.79 | 17.18 | 0.00627 | 0.00914 | PASS |
| Extreme (55°C) | | 9.22 | 7.30 | 0.00490 | 0.00389 | PASS |
| Extreme (50°C) | | 2.13 | 9.88 | 0.00113 | 0.00525 | PASS |
| Extreme (40°C) | | 17.24 | 13.47 | 0.00917 | 0.00716 | PASS |
| Extreme (30°C) | | 8.30 | 15.41 | 0.00442 | 0.00820 | PASS |
| Extreme (20°C) | | 3.23 | 9.63 | 0.00172 | 0.00512 | PASS |
| Extreme (10°C) | | 14.91 | 11.20 | 0.00793 | 0.00596 | PASS |
| Extreme (0°C) | | 16.12 | 2.57 | 0.00857 | 0.00137 | PASS |
| Extreme (-10°C) | | 8.14 | 9.84 | 0.00433 | 0.00524 | PASS |
| Extreme (-20°C) | | 5.03 | 13.98 | 0.00268 | 0.00743 | PASS |
| Extreme (-30°C) | | 16.84 | 6.50 | 0.00896 | 0.00345 | PASS |
| 25°C | LV | 15.68 | 14.56 | 0.00834 | 0.00774 | PASS |
| | HV | 14.91 | 2.48 | 0.00793 | 0.00132 | PASS |

| WCDMA Band II | | | | | | |
|-----------------|---------|-----------------|-----------------|---------------------------|---------------------------|---------|
| Condition | | Freq.Error (Hz) | Freq.Error (Hz) | Frequency Stability (ppm) | Frequency Stability (ppm) | Verdict |
| Temperature | Voltage | | | | | |
| Normal (25°C) | Normal | 7.50 | 11.66 | 0.00399 | 0.00620 | PASS |
| Extreme (55°C) | | 3.87 | 4.75 | 0.00206 | 0.00253 | PASS |
| Extreme (50°C) | | 5.81 | 5.93 | 0.00309 | 0.00316 | PASS |
| Extreme (40°C) | | 3.97 | 14.47 | 0.00211 | 0.00769 | PASS |
| Extreme (30°C) | | 15.79 | 3.00 | 0.00840 | 0.00160 | PASS |
| Extreme (20°C) | | 12.28 | 11.92 | 0.00653 | 0.00634 | PASS |
| Extreme (10°C) | | 14.69 | 16.20 | 0.00781 | 0.00862 | PASS |
| Extreme (0°C) | | 7.21 | 11.91 | 0.00383 | 0.00634 | PASS |
| Extreme (-10°C) | | 12.46 | 11.10 | 0.00663 | 0.00590 | PASS |
| Extreme (-20°C) | | 3.25 | 10.17 | 0.00173 | 0.00541 | PASS |
| Extreme (-30°C) | | 6.16 | 9.43 | 0.00328 | 0.00502 | PASS |
| 25°C | LV | 11.14 | 10.04 | 0.00592 | 0.00534 | PASS |
| | HV | 7.24 | 4.92 | 0.00385 | 0.00262 | PASS |

| LTE Band 2, BANDWIDTH 1.4MHz | | | | | | |
|------------------------------|---------|-----------------|-----------------|---------------------------|---------------------------|---------|
| Condition | | Freq.Error (Hz) | Freq.Error (Hz) | Frequency Stability (ppm) | Frequency Stability (ppm) | Verdict |
| BANDWIDTH | 1.4MHz | | | | | |
| Temperature | Voltage | 16QAM | QPSK | 16QAM | QPSK | |
| Normal (25°C) | Normal | 10.64 | 4.53 | 0.00566 | 0.00241 | PASS |
| Extreme (55°C) | | 13.93 | 12.92 | 0.00741 | 0.00687 | PASS |
| Extreme (50°C) | | 9.71 | 14.88 | 0.00516 | 0.00791 | PASS |
| Extreme (40°C) | | 14.78 | 4.50 | 0.00786 | 0.00239 | PASS |
| Extreme (30°C) | | 9.37 | 2.27 | 0.00498 | 0.00121 | PASS |
| Extreme (20°C) | | 17.36 | 3.23 | 0.00923 | 0.00172 | PASS |
| Extreme (10°C) | | 13.51 | 13.53 | 0.00719 | 0.00720 | PASS |
| Extreme (0°C) | | 9.72 | 2.35 | 0.00517 | 0.00125 | PASS |
| Extreme (-10°C) | | 15.09 | 5.17 | 0.00803 | 0.00275 | PASS |
| Extreme (-20°C) | | 1.92 | 11.42 | 0.00102 | 0.00607 | PASS |
| Extreme (-30°C) | | 4.26 | 17.95 | 0.00227 | 0.00955 | PASS |
| 25°C | LV | 8.45 | 6.93 | 0.00449 | 0.00369 | PASS |
| | HV | 10.60 | 9.60 | 0.00564 | 0.00511 | PASS |

| LTE Band 2, BANDWIDTH 3MHz | | | | | | |
|----------------------------|---------|-----------------|-----------------|---------------------------|---------------------------|---------|
| Condition | | Freq.Error (Hz) | Freq.Error (Hz) | Frequency Stability (ppm) | Frequency Stability (ppm) | Verdict |
| BANDWIDTH | 3MHz | | | | | |
| Temperature | Voltage | 16QAM | QPSK | 16QAM | QPSK | |
| Normal (25°C) | Normal | 6.76 | 15.12 | 0.00360 | 0.00804 | PASS |
| Extreme (55°C) | | 14.10 | 9.93 | 0.00750 | 0.00528 | PASS |
| Extreme (50°C) | | 6.62 | 9.47 | 0.00352 | 0.00504 | PASS |
| Extreme (40°C) | | 13.86 | 6.38 | 0.00737 | 0.00339 | PASS |
| Extreme (30°C) | | 14.68 | 2.25 | 0.00781 | 0.00120 | PASS |
| Extreme (20°C) | | 2.28 | 14.63 | 0.00121 | 0.00778 | PASS |
| Extreme (10°C) | | 4.74 | 17.21 | 0.00252 | 0.00916 | PASS |
| Extreme (0°C) | | 5.79 | 4.45 | 0.00308 | 0.00237 | PASS |
| Extreme (-10°C) | | 1.35 | 2.21 | 0.00072 | 0.00118 | PASS |
| Extreme (-20°C) | | 5.40 | 2.72 | 0.00287 | 0.00145 | PASS |
| Extreme (-30°C) | | 2.59 | 10.43 | 0.00138 | 0.00555 | PASS |
| 25°C | LV | 6.09 | 4.11 | 0.00324 | 0.00219 | PASS |
| | HV | 17.18 | 5.81 | 0.00914 | 0.00309 | PASS |

| LTE Band 2, BANDWIDTH 5MHz | | | | | | |
|----------------------------|---------|-----------------|-----------------|---------------------------|---------------------------|---------|
| Condition | | Freq.Error (Hz) | Freq.Error (Hz) | Frequency Stability (ppm) | Frequency Stability (ppm) | Verdict |
| BANDWIDTH | 5MHz | | | | | |
| Temperature | Voltage | 16QAM | QPSK | 16QAM | QPSK | |
| Normal (25°C) | Normal | 10.20 | 3.36 | 0.00543 | 0.00179 | PASS |
| Extreme (55°C) | | 4.10 | 16.93 | 0.00218 | 0.00901 | PASS |
| Extreme (50°C) | | 10.66 | 5.96 | 0.00567 | 0.00317 | PASS |
| Extreme (40°C) | | 8.96 | 13.65 | 0.00477 | 0.00726 | PASS |
| Extreme (30°C) | | 1.30 | 10.75 | 0.00069 | 0.00572 | PASS |
| Extreme (20°C) | | 1.16 | 7.29 | 0.00062 | 0.00388 | PASS |
| Extreme (10°C) | | 6.55 | 10.03 | 0.00348 | 0.00534 | PASS |
| Extreme (0°C) | | 13.10 | 13.37 | 0.00697 | 0.00711 | PASS |
| Extreme (-10°C) | | 15.35 | 4.59 | 0.00816 | 0.00244 | PASS |
| Extreme (-20°C) | | 2.72 | 16.97 | 0.00145 | 0.00903 | PASS |
| Extreme (-30°C) | | 16.66 | 8.24 | 0.00886 | 0.00438 | PASS |
| 25°C | | LV | 3.86 | 5.81 | 0.00205 | 0.00309 |
| | HV | 13.58 | 15.71 | 0.00723 | 0.00835 | PASS |

| LTE Band 2, BANDWIDTH 10MHz | | | | | | |
|-----------------------------|---------|-----------------|-----------------|---------------------------|---------------------------|---------|
| Condition | | Freq.Error (Hz) | Freq.Error (Hz) | Frequency Stability (ppm) | Frequency Stability (ppm) | Verdict |
| BANDWIDTH | 10MHz | | | | | |
| Temperature | Voltage | 16QAM | QPSK | 16QAM | QPSK | |
| Normal (25°C) | Normal | 12.95 | 17.33 | 0.00689 | 0.00922 | PASS |
| Extreme (55°C) | | 6.06 | 7.31 | 0.00322 | 0.00389 | PASS |
| Extreme (50°C) | | 10.71 | 10.33 | 0.00570 | 0.00550 | PASS |
| Extreme (40°C) | | 6.77 | 9.44 | 0.00360 | 0.00502 | PASS |
| Extreme (30°C) | | 15.65 | 15.59 | 0.00833 | 0.00829 | PASS |
| Extreme (20°C) | | 16.75 | 8.18 | 0.00891 | 0.00435 | PASS |
| Extreme (10°C) | | 14.92 | 9.99 | 0.00793 | 0.00532 | PASS |
| Extreme (0°C) | | 4.12 | 2.26 | 0.00219 | 0.00120 | PASS |
| Extreme (-10°C) | | 12.56 | 8.47 | 0.00668 | 0.00450 | PASS |
| Extreme (-20°C) | | 4.98 | 1.03 | 0.00265 | 0.00055 | PASS |
| Extreme (-30°C) | | 1.25 | 3.45 | 0.00067 | 0.00183 | PASS |
| 25°C | | LV | 4.88 | 10.94 | 0.00259 | 0.00582 |
| | HV | 12.30 | 6.61 | 0.00654 | 0.00351 | PASS |

| LTE Band 2, BANDWIDTH 15MHz | | | | | | |
|-----------------------------|---------|-----------------|-----------------|---------------------------|---------------------------|---------|
| Condition | | Freq.Error (Hz) | Freq.Error (Hz) | Frequency Stability (ppm) | Frequency Stability (ppm) | Verdict |
| BANDWIDTH | 15MHz | | | | | |
| Temperature | Voltage | 16QAM | QPSK | 16QAM | QPSK | |
| Normal (25°C) | Normal | 5.72 | 2.71 | 0.00304 | 0.00144 | PASS |
| Extreme (55°C) | | 15.16 | 2.44 | 0.00806 | 0.00130 | PASS |
| Extreme (50°C) | | 11.13 | 6.80 | 0.00592 | 0.00362 | PASS |
| Extreme (40°C) | | 12.26 | 1.37 | 0.00652 | 0.00073 | PASS |
| Extreme (30°C) | | 9.05 | 5.31 | 0.00482 | 0.00282 | PASS |
| Extreme (20°C) | | 12.89 | 2.12 | 0.00686 | 0.00113 | PASS |
| Extreme (10°C) | | 5.37 | 11.84 | 0.00286 | 0.00630 | PASS |
| Extreme (0°C) | | 9.93 | 13.70 | 0.00528 | 0.00729 | PASS |
| Extreme (-10°C) | | 14.94 | 7.47 | 0.00795 | 0.00397 | PASS |
| Extreme (-20°C) | | 12.76 | 1.51 | 0.00679 | 0.00080 | PASS |
| Extreme (-30°C) | | 3.99 | 15.41 | 0.00212 | 0.00820 | PASS |
| 25°C | | LV | 11.78 | 2.96 | 0.00627 | 0.00157 |
| | HV | 3.27 | 13.40 | 0.00174 | 0.00713 | PASS |

| LTE Band 2, BANDWIDTH 20MHz | | | | | | |
|-----------------------------|---------|-----------------|-----------------|---------------------------|---------------------------|---------|
| Condition | | Freq.Error (Hz) | Freq.Error (Hz) | Frequency Stability (ppm) | Frequency Stability (ppm) | Verdict |
| BANDWIDTH | 20MHz | | | | | |
| Temperature | Voltage | 16QAM | QPSK | 16QAM | QPSK | |
| Normal (25°C) | Normal | 14.30 | 1.23 | 0.00761 | 0.00065 | PASS |
| Extreme (55°C) | | 5.36 | 10.85 | 0.00285 | 0.00577 | PASS |
| Extreme (50°C) | | 16.06 | 6.94 | 0.00854 | 0.00369 | PASS |
| Extreme (40°C) | | 11.78 | 3.58 | 0.00627 | 0.00190 | PASS |
| Extreme (30°C) | | 12.80 | 16.53 | 0.00681 | 0.00879 | PASS |
| Extreme (20°C) | | 14.91 | 10.60 | 0.00793 | 0.00564 | PASS |
| Extreme (10°C) | | 4.27 | 7.09 | 0.00227 | 0.00377 | PASS |
| Extreme (0°C) | | 4.51 | 16.01 | 0.00240 | 0.00852 | PASS |
| Extreme (-10°C) | | 5.54 | 11.26 | 0.00294 | 0.00599 | PASS |
| Extreme (-20°C) | | 4.18 | 16.54 | 0.00222 | 0.00880 | PASS |
| Extreme (-30°C) | | 9.41 | 12.22 | 0.00500 | 0.00650 | PASS |
| 25°C | | LV | 3.60 | 17.79 | 0.00191 | 0.00946 |
| | HV | 3.18 | 11.85 | 0.00169 | 0.00630 | PASS |

5.7. Spurious Emissions at Antenna Terminals

Ambient condition

| Temperature | Relative humidity | Pressure |
|-------------|-------------------|----------|
| 23°C ~25°C | 45%~50% | 101.5kPa |

Method of Measurement

The EUT was connected to Spectrum Analyzer and Base Station Simulator via power Splitter. The measurement is carried out using a spectrum analyzer. The spectrum analyzer scans from 9kHz to the 10th harmonic of the carrier. The peak detector is used.

RBW is set to 100kHz, VBW is set to 300kHz for 30MHz~1GHz

RBW is set to 1MHz, VBW is set to 3MHz for above 1GHz, Sweep is set to ATUO.

The modulation mode and RB allocation refer to section 5.1, using the maximum output power configuration.

Test setup

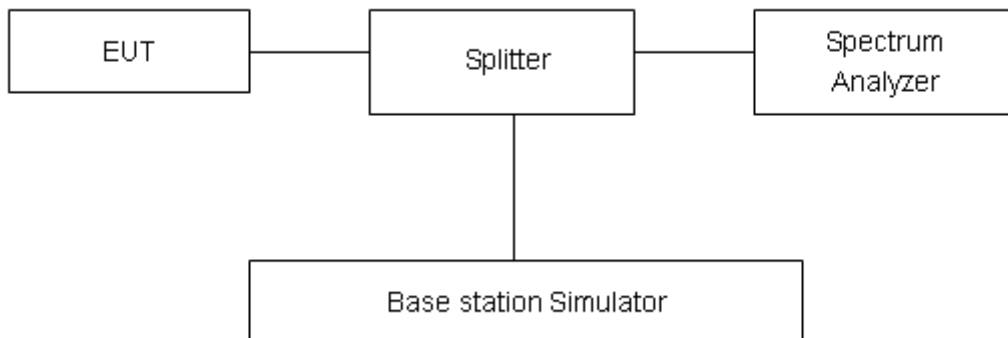

Limits

Rule Part 24.238(a) specifies that “on any frequency outside a licensee's frequency block, the power of any emission shall be attenuated below the transmitter power (P) by at least 43 + 10 log₁₀ (P) dB.”

| | |
|-------|---------|
| Limit | -13 dBm |
|-------|---------|

Measurement Uncertainty

The assessed measurement uncertainty to ensure 99.75% confidence level for the normal distribution is with the coverage factor $k = 1.96$.

| Frequency | Uncertainty |
|------------|-------------|
| 9kHz-1GHz | 0.684 dB |
| 1GHz-20GHz | 1.407 dB |



Test Result

Sweep the whole frequency band through the range from 9kHz to the 10th harmonic of the carrier, the emissions more than 20 dB below the limit are not reported.

The signal beyond the limit is carrier.

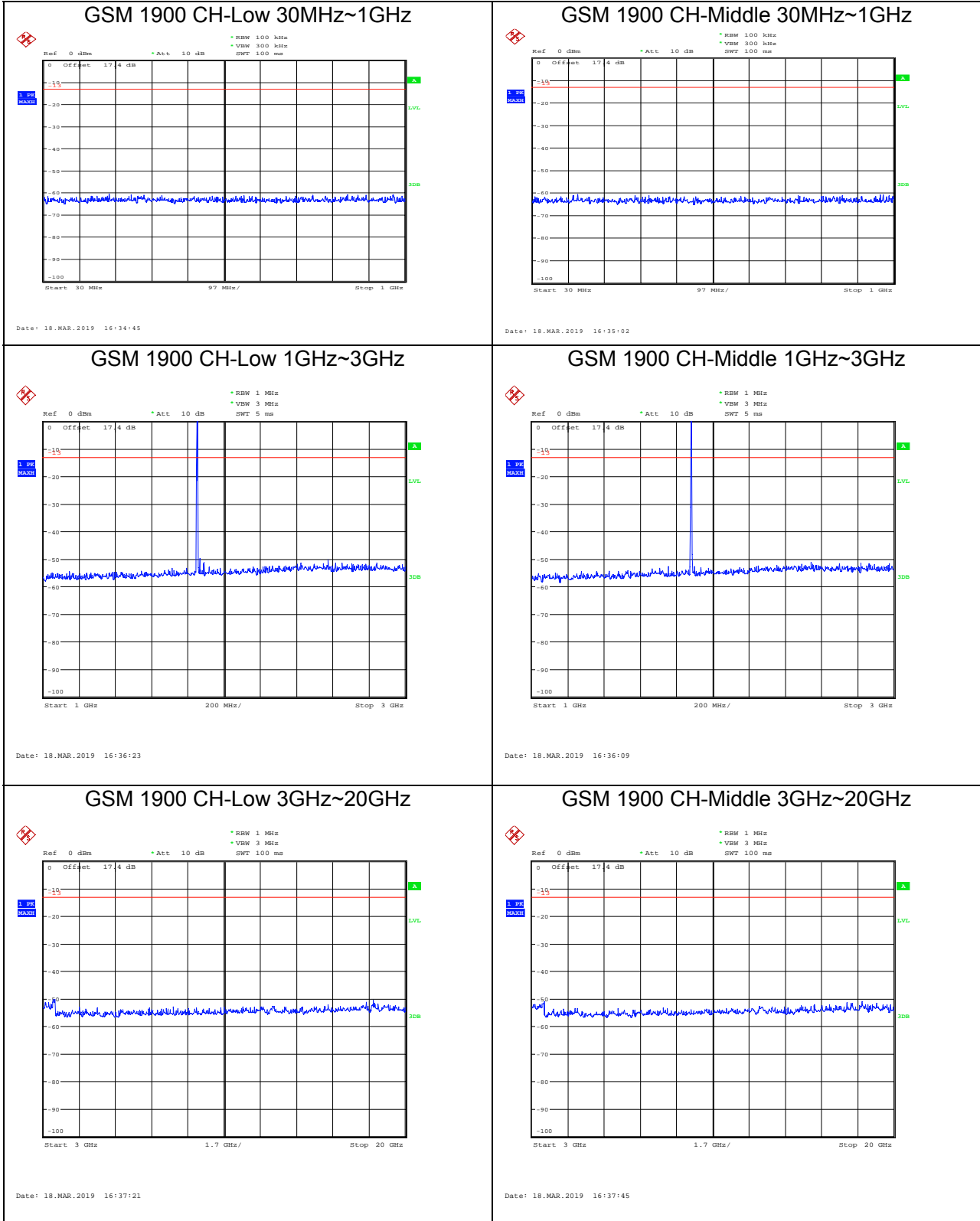



GSM 1900 CH-High 30MHz~1GHz

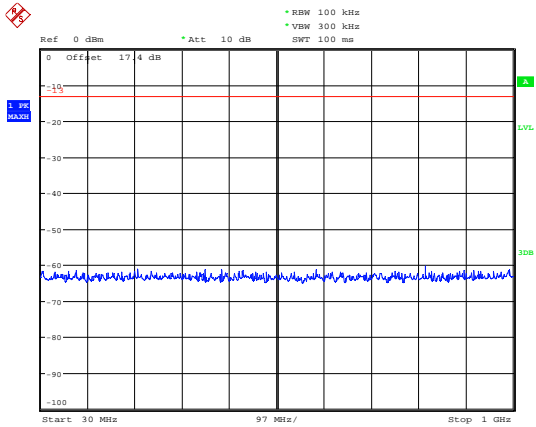

Date: 18.MAR.2019 16:35:16

WCDMA Band II CH-Low 30MHz~1GHz

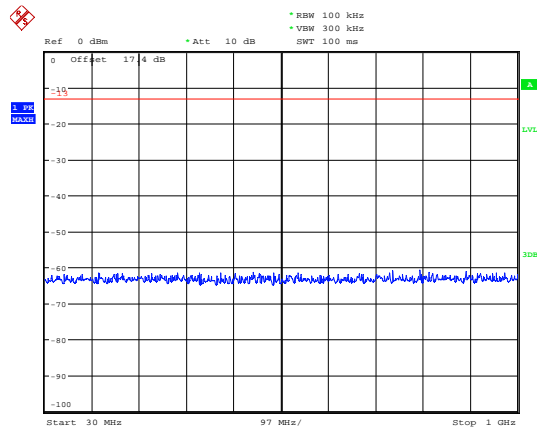

Date: 19.MAR.2019 12:06:24

GSM 1900 CH-High 1GHz~3GHz

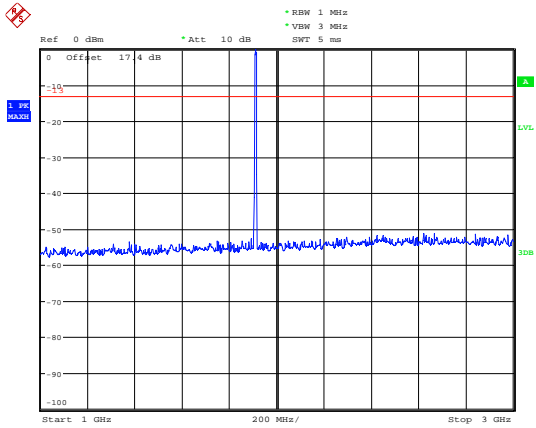

Date: 18.MAR.2019 16:35:42

WCDMA BAND II CH-Low 1GHz~3GHz

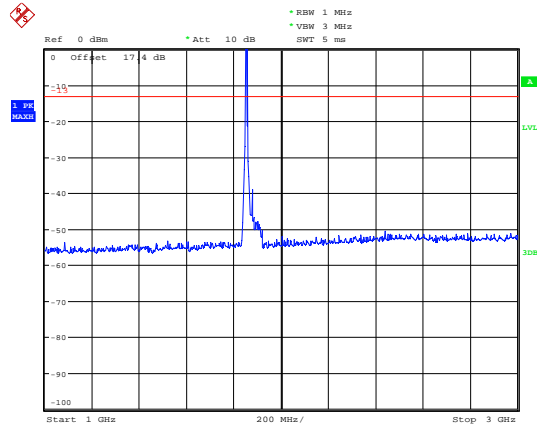

Date: 19.MAR.2019 12:10:36

GSM 1900 CH-High 3GHz~20GHz

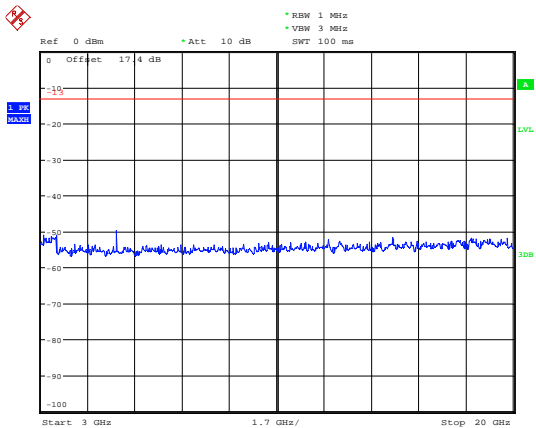

Date: 18.MAR.2019 16:37:57

WCDMA BAND II CH-Low 3GHz~20GHz

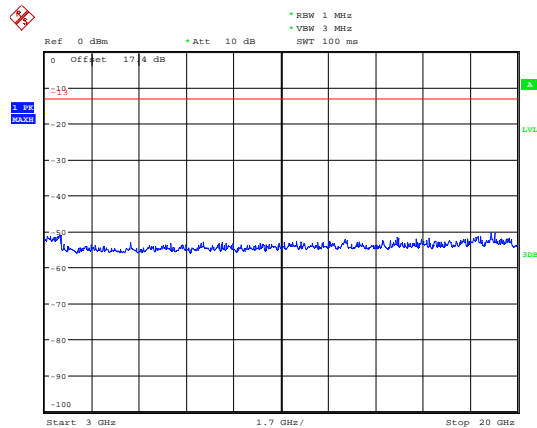

Date: 19.MAR.2019 13:46:26



WCDMA Band II CH- Middle 30MHz~1GHz

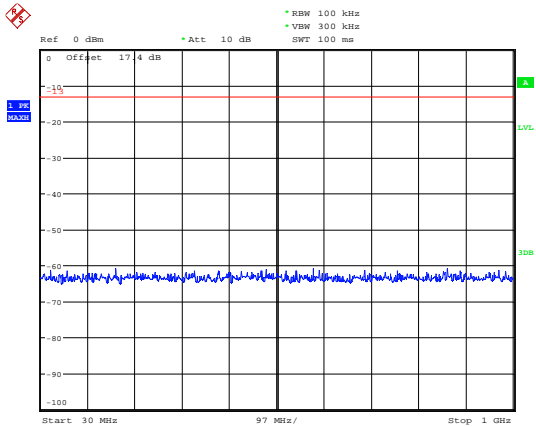

Date: 19.MAR.2019 12:06:42

WCDMA Band II CH- High 30MHz~1GHz

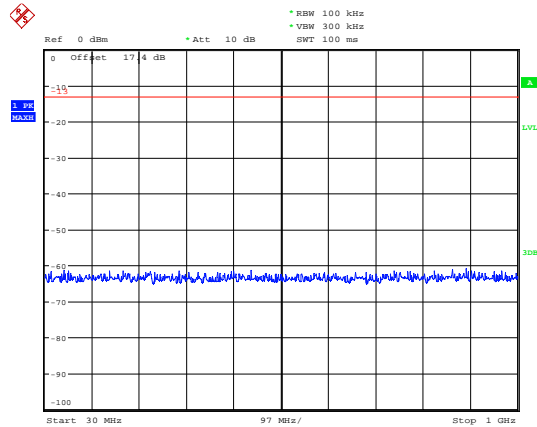

Date: 19.MAR.2019 12:07:16

WCDMA BAND II CH-Middle 1GHz~3GHz

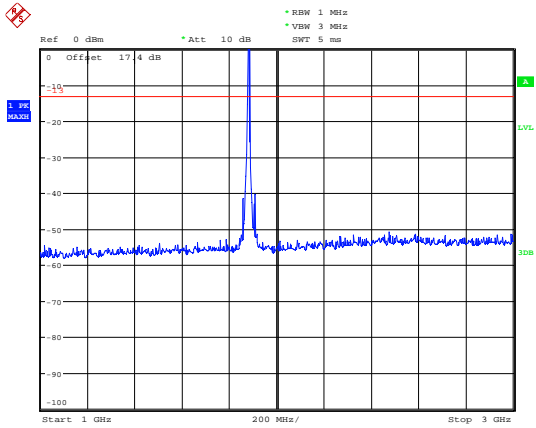

Date: 19.MAR.2019 12:10:55

WCDMA BAND II CH-High 1GHz~3GHz

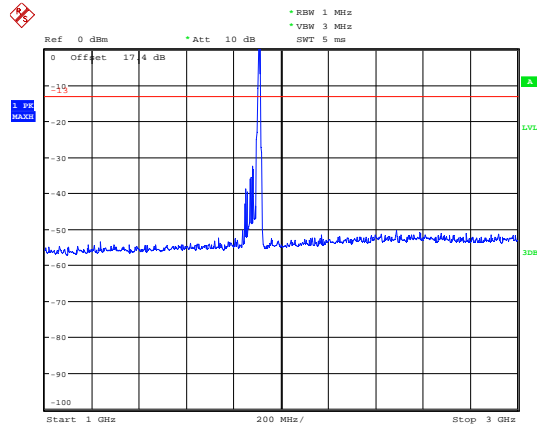

Date: 19.MAR.2019 12:11:20

WCDMA BAND II CH-Middle 3GHz~20GHz

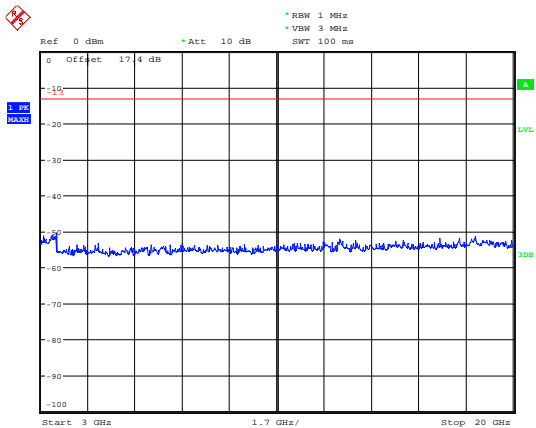

Date: 19.MAR.2019 13:46:53

WCDMA BAND II CH-High 3GHz~20GHz

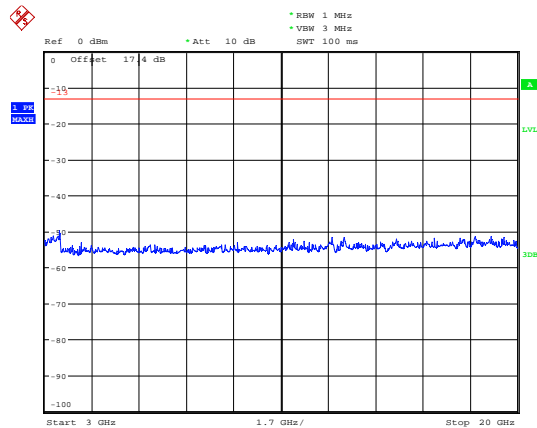

Date: 19.MAR.2019 13:47:11



LTE Band 2 1.4MHz CH-Low 30MHz~1GHz

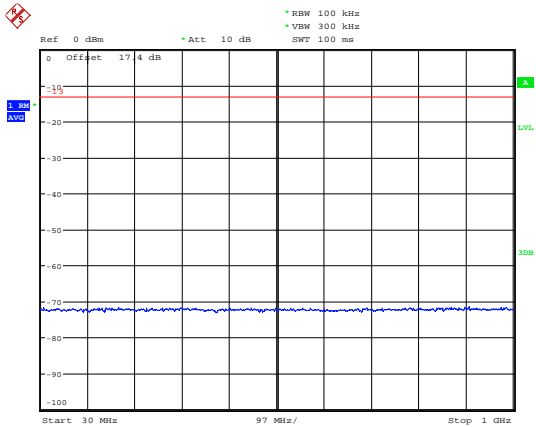

Date: 24.MAR.2019 10:03:16

LTE Band 2 1.4MHz CH-Middle 30MHz~1GHz

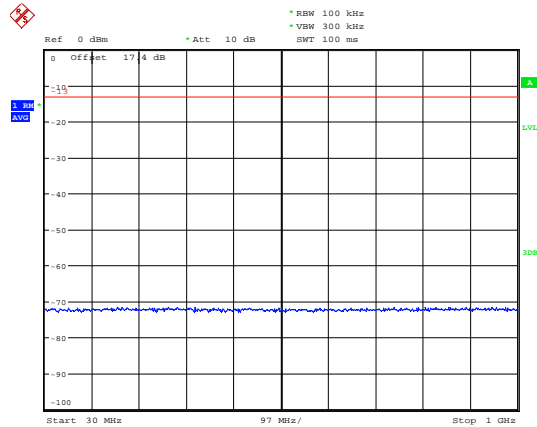

Date: 24.MAR.2019 10:03:41

LTE Band 2 1.4MHz CH-Low 1GHz~3GHz

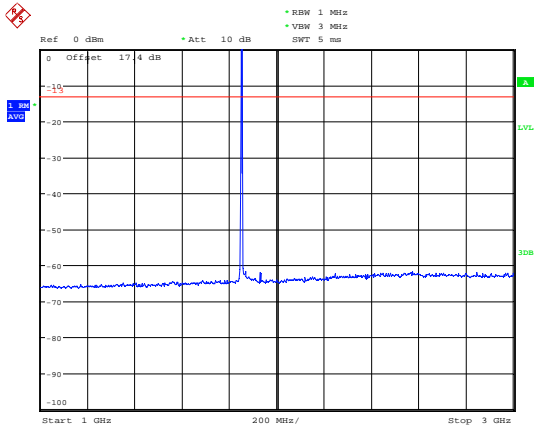

Date: 24.MAR.2019 10:11:20

LTE Band 2 1.4MHz CH-Middle 1GHz~3GHz

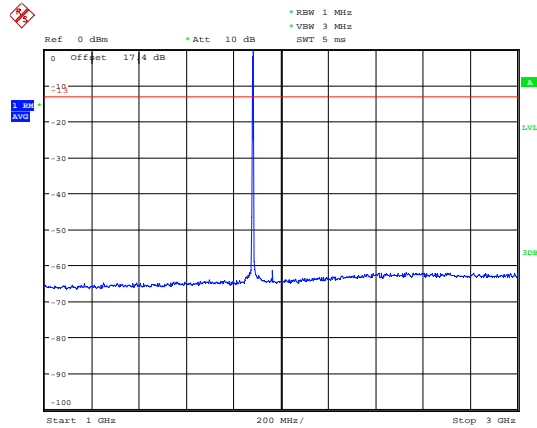

Date: 24.MAR.2019 10:11:33

LTE Band 2 1.4MHz CH-Low 3GHz~20GHz

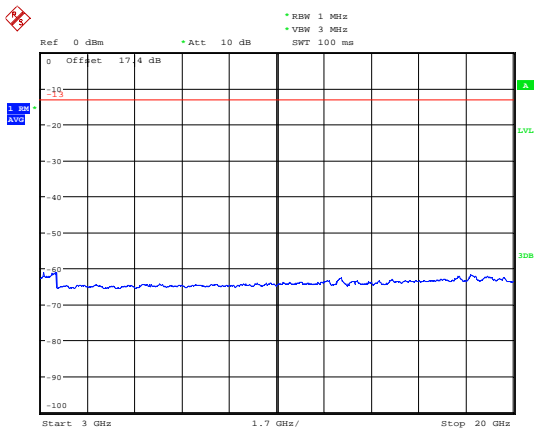

Date: 24.MAR.2019 10:17:28

LTE Band 2 1.4MHz CH-Middle 3GHz~20GHz

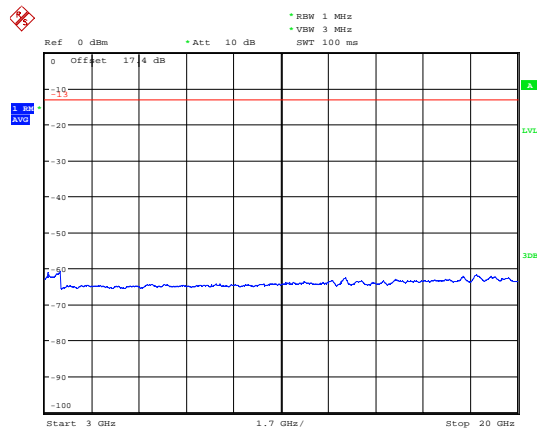

Date: 24.MAR.2019 10:17:42



LTE Band 2 1.4MHz CH-High 30MHz~1GHz

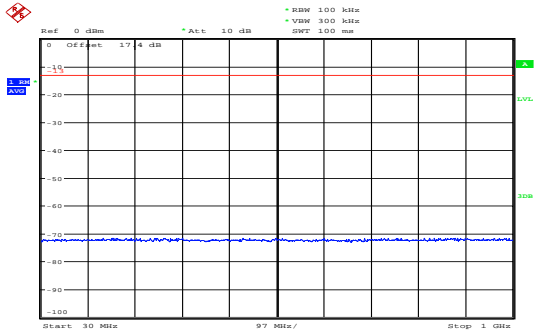

Date: 24.MAR.2019 10:04:07

LTE Band 2 3MHz CH-Low 30MHz~1GHz

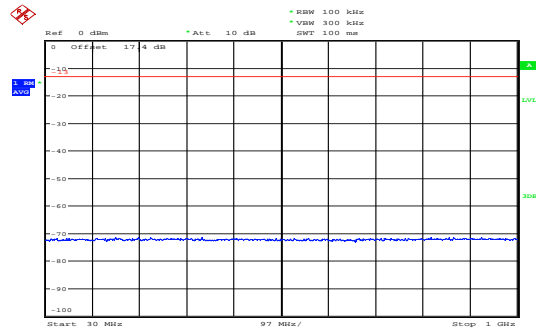

Date: 24.MAR.2019 10:04:39

LTE Band 2 1.4MHz CH-High 1GHz~3GHz

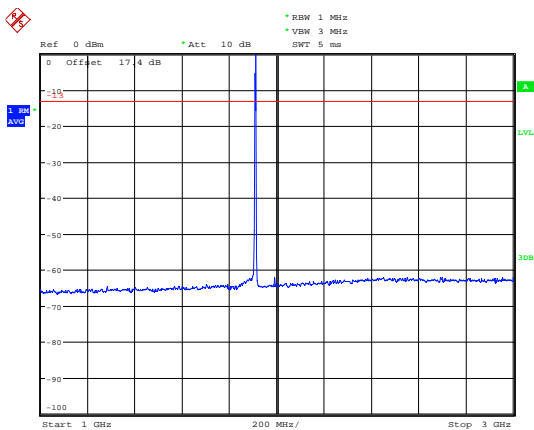

Date: 24.MAR.2019 10:11:46

LTE Band 2 3MHz CH-Low 1GHz~3GHz

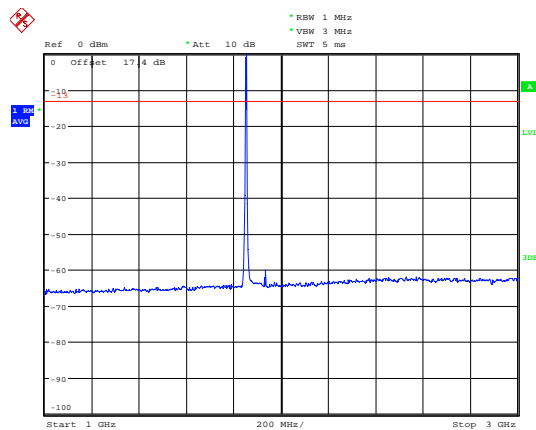

Date: 24.MAR.2019 10:12:12

LTE Band 2 1.4MHz CH-High 3GHz~20GHz

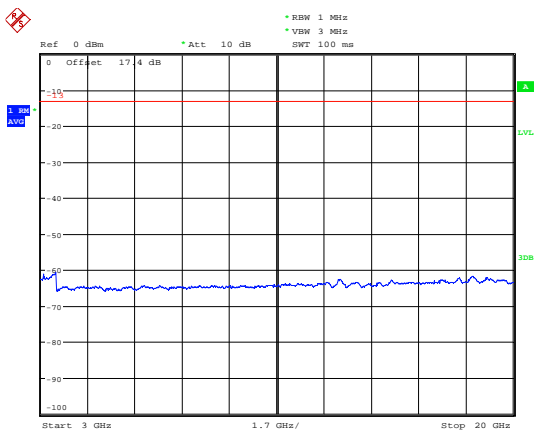

Date: 24.MAR.2019 10:17:56

LTE Band 2 3MHz CH-Low 3GHz~20GHz

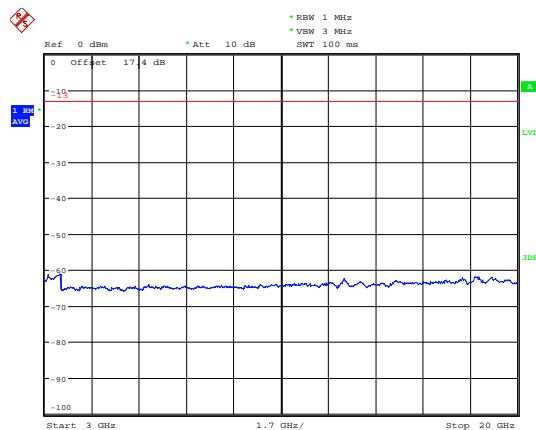

Date: 24.MAR.2019 10:18:21



LTE Band 2 3MHz CH-Middle 30MHz~1GHz

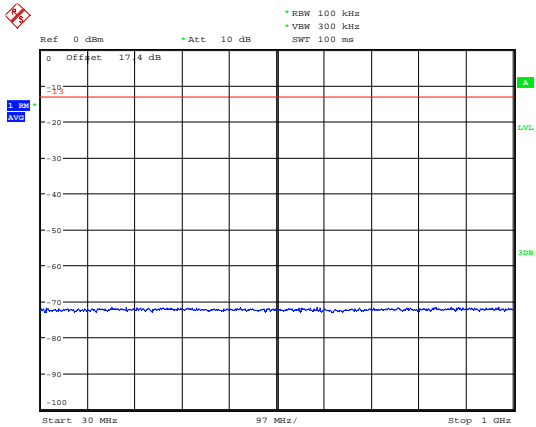

Date: 24.MAR.2019 10:05:18

LTE Band 2 3MHz CH-High 30MHz~1GHz

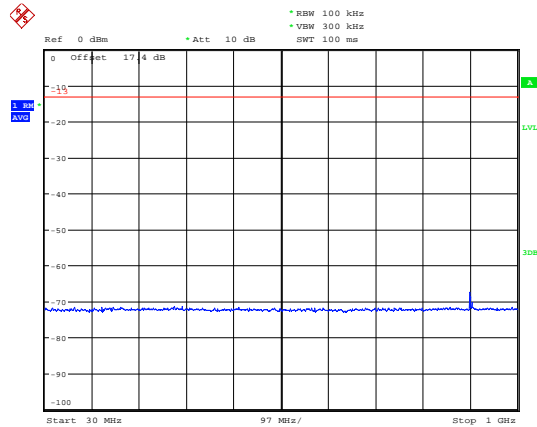

Date: 24.MAR.2019 10:05:38

LTE Band 2 3MHz CH-Middle 1GHz~3GHz

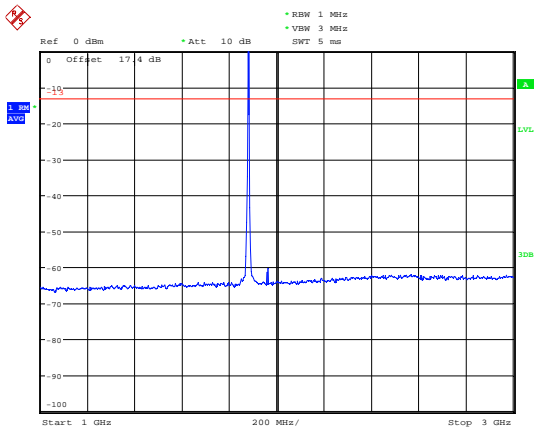

Date: 24.MAR.2019 10:12:27

LTE Band 2 3MHz CH-High 1GHz~3GHz

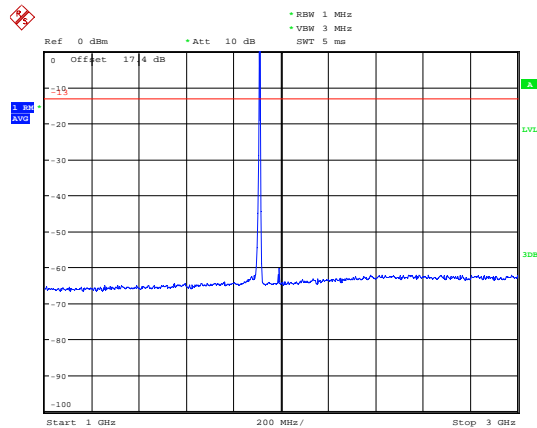

Date: 24.MAR.2019 10:12:41

LTE Band 2 3MHz CH-Middle 3GHz~20GHz

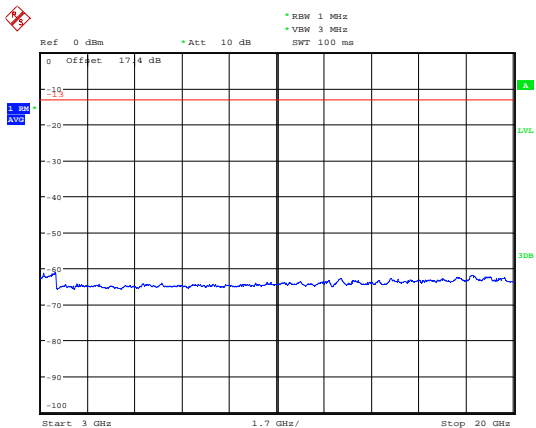

Date: 24.MAR.2019 10:18:31

LTE Band 2 3MHz CH-High 3GHz~20GHz

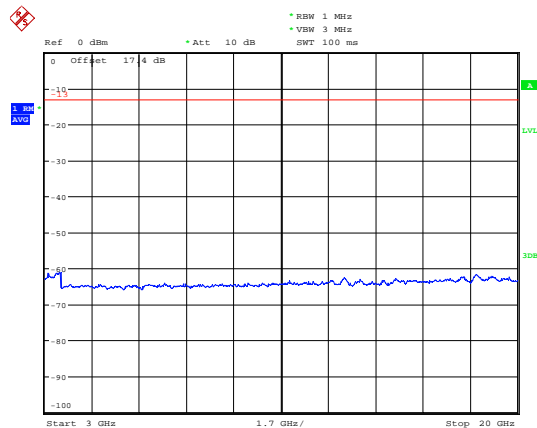

Date: 24.MAR.2019 10:18:45

LTE Band 2 5MHz CH-Low 30MHz~1GHz

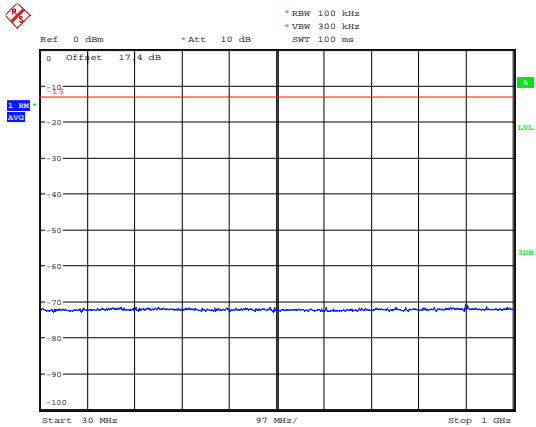

Date: 24.MAR.2019 10:05:56

LTE Band 2 5MHz CH-Middle 30MHz~1GHz

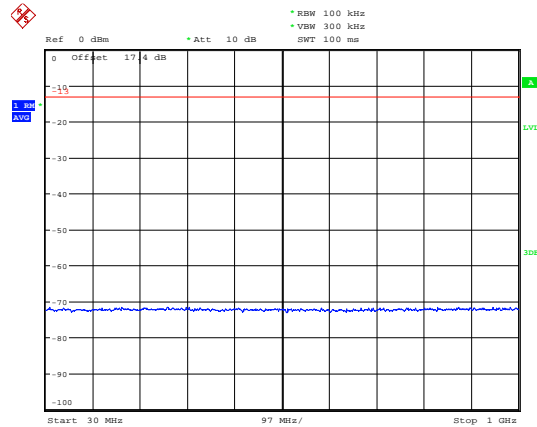

Date: 24.MAR.2019 10:06:59

LTE Band 2 5MHz CH-Low 1GHz~3GHz

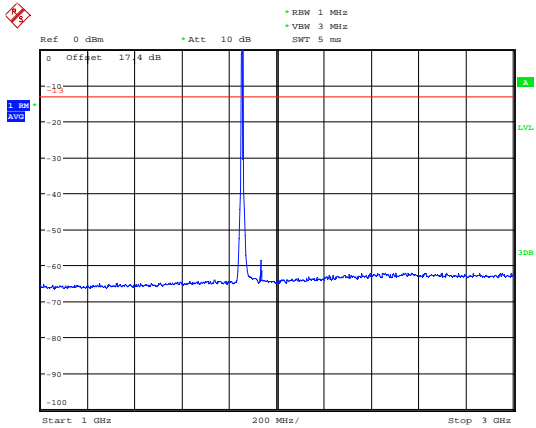

Date: 24.MAR.2019 10:13:09

LTE Band 2 5MHz CH-Middle 1GHz~3GHz

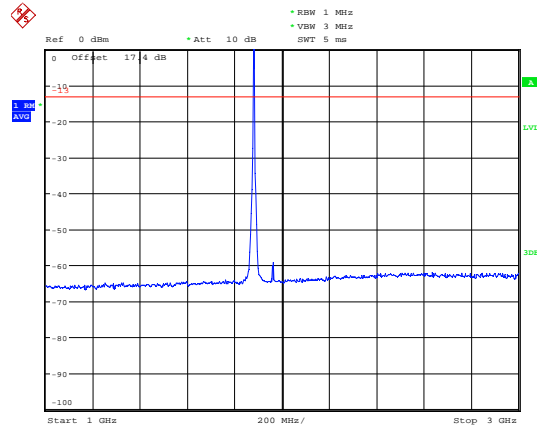

Date: 24.MAR.2019 10:13:22

LTE Band 2 5MHz CH-Low 3GHz~20GHz

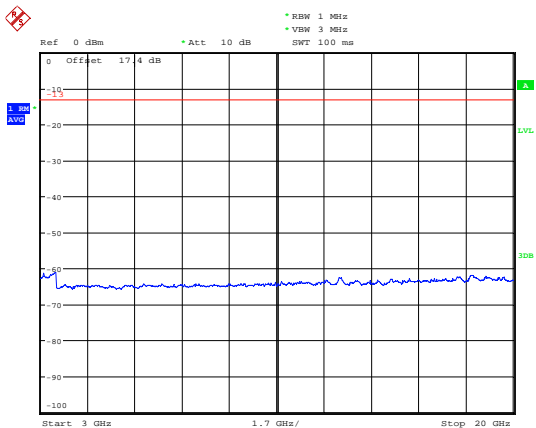

Date: 24.MAR.2019 10:19:03

LTE Band 2 5MHz CH-Middle 3GHz~20GHz

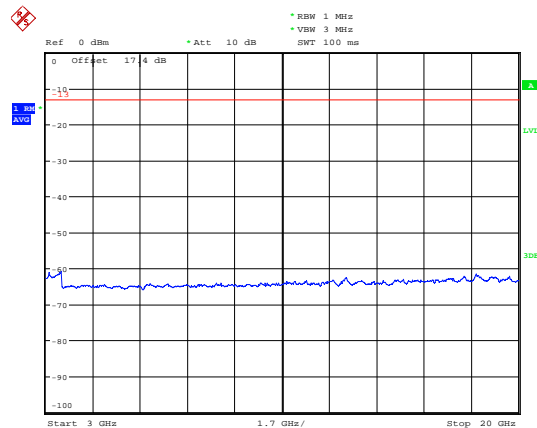

Date: 24.MAR.2019 10:19:24



LTE Band 2 5MHz CH-High 30MHz~1GHz

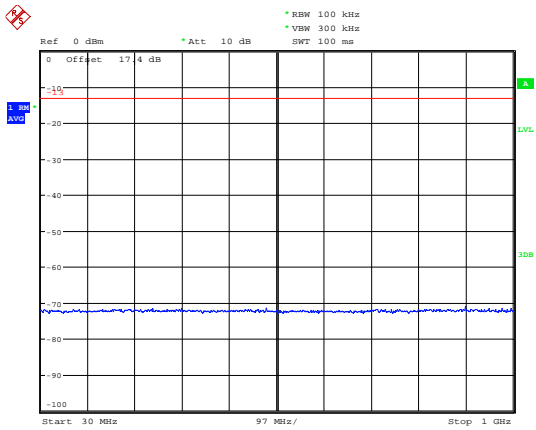

Date: 24.MAR.2019 10:07:21

LTE Band 2 10MHz CH-Low 30MHz~1GHz

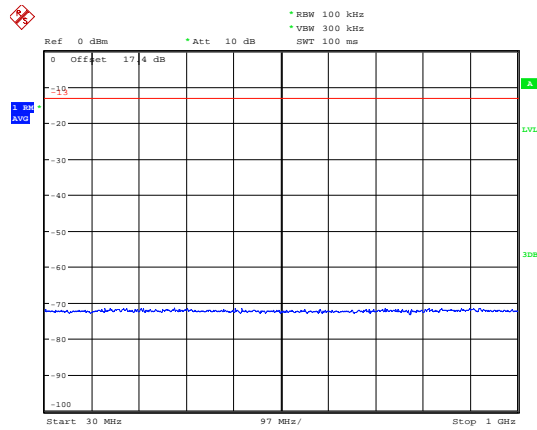

Date: 24.MAR.2019 10:07:40

LTE Band 2 5MHz CH-High 1GHz~3GHz

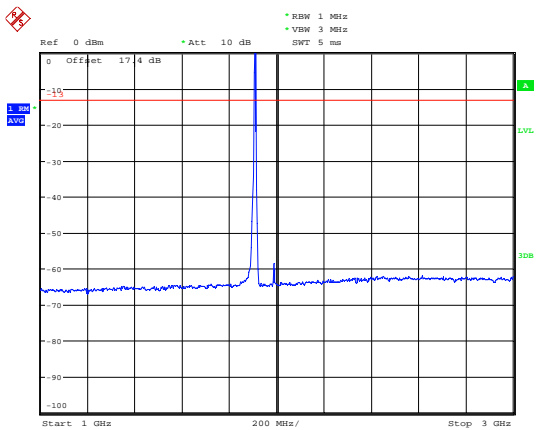

Date: 24.MAR.2019 10:13:34

LTE Band 2 10MHz CH-Low 1GHz~3GHz

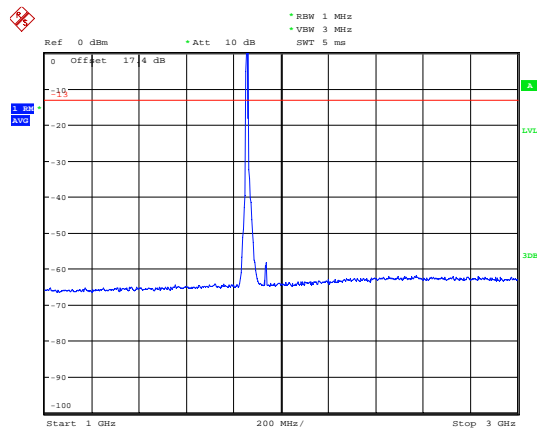

Date: 24.MAR.2019 10:13:59

LTE Band 2 5MHz CH-High 3GHz~20GHz

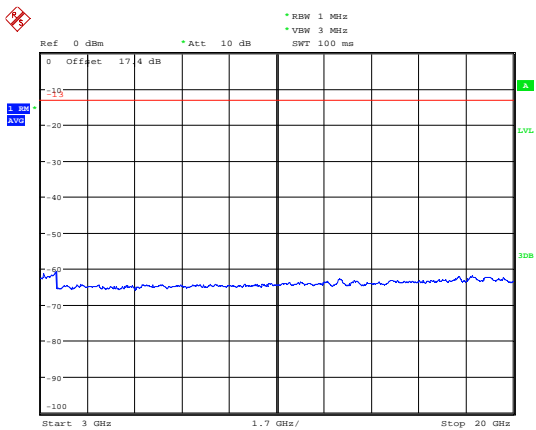

Date: 24.MAR.2019 10:19:39

LTE Band 2 10MHz CH-Low 3GHz~20GHz

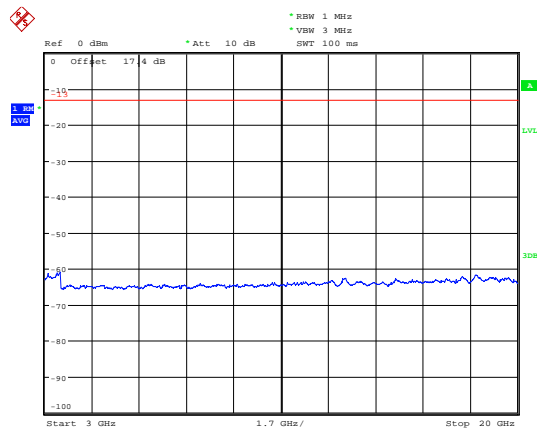

Date: 24.MAR.2019 10:20:11



LTE Band 2 10MHz CH-Middle 30MHz~1GHz

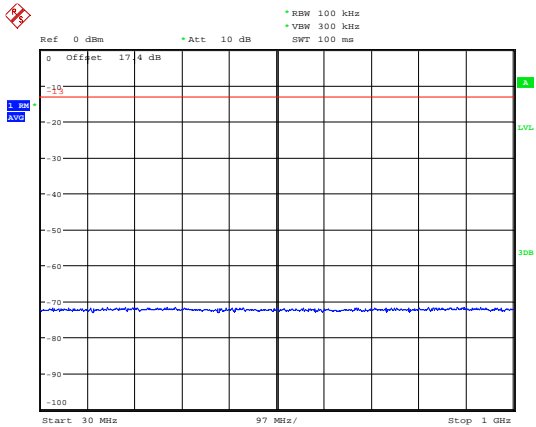

Date: 24.MAR.2019 10:07:57

LTE Band 2 10MHz CH-High 30MHz~1GHz

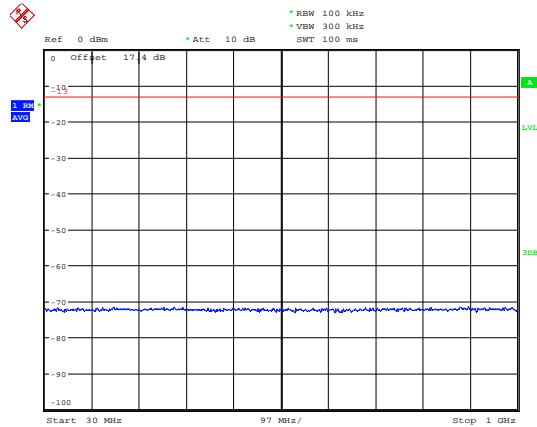

Date: 24.MAR.2019 10:08:27

LTE Band 2 10MHz CH-Middle 1GHz~3GHz

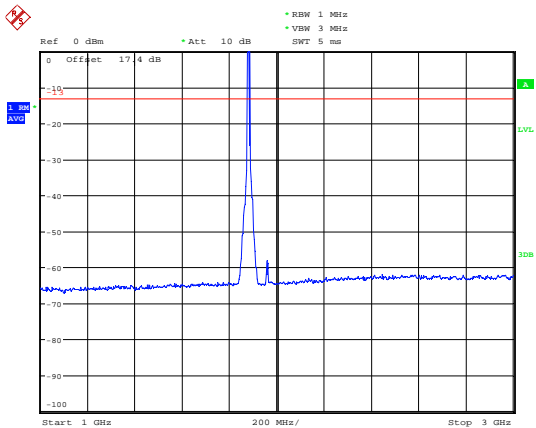

Date: 24.MAR.2019 10:14:09

LTE Band 2 10MHz CH-High 1GHz~3GHz

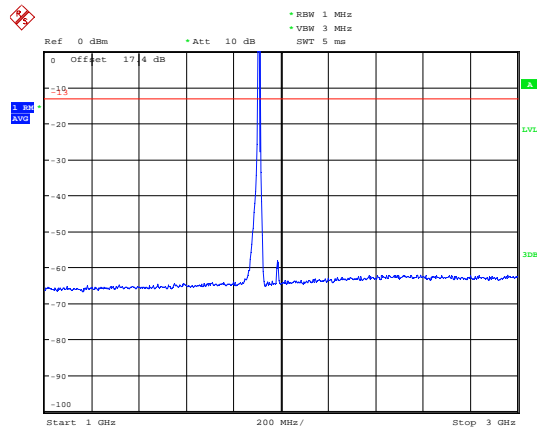

Date: 24.MAR.2019 10:14:35

LTE Band 2 10MHz CH-Middle 3GHz~20GHz

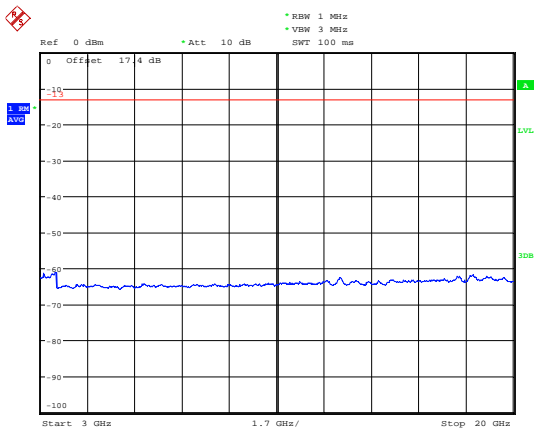

Date: 24.MAR.2019 10:20:24

LTE Band 2 10MHz CH-High 3GHz~20GHz

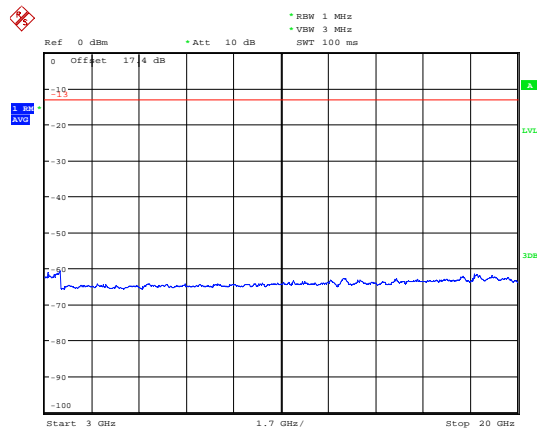

Date: 24.MAR.2019 10:20:46



LTE Band 2 15MHz CH-Low 30MHz~1GHz

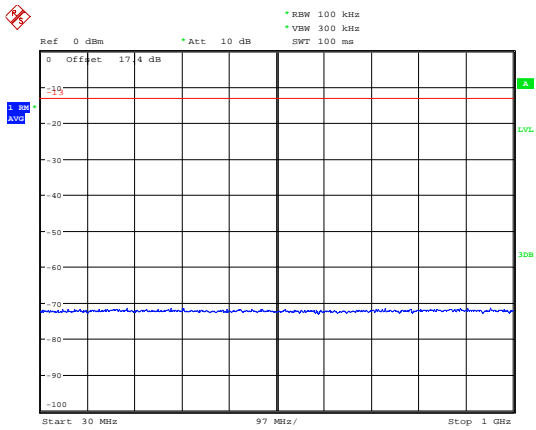

Date: 24.MAR.2019 10:08:51

LTE Band 2 15MHz CH-Middle 30MHz~1GHz

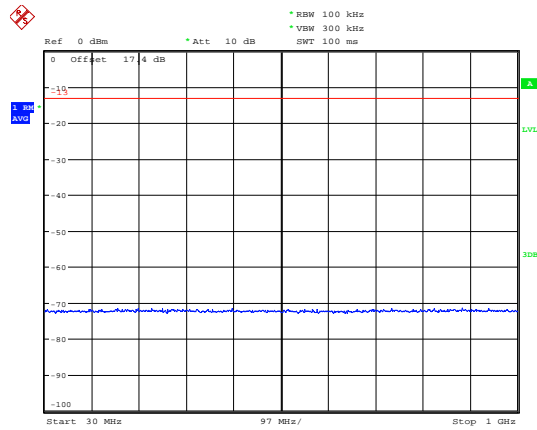

Date: 24.MAR.2019 10:09:08

LTE Band 2 15MHz CH-Low 1GHz~3GHz

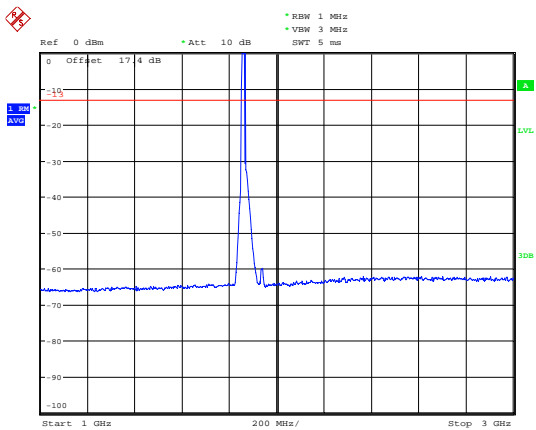

Date: 24.MAR.2019 10:14:57

LTE Band 2 15MHz CH-Middle 1GHz~3GHz

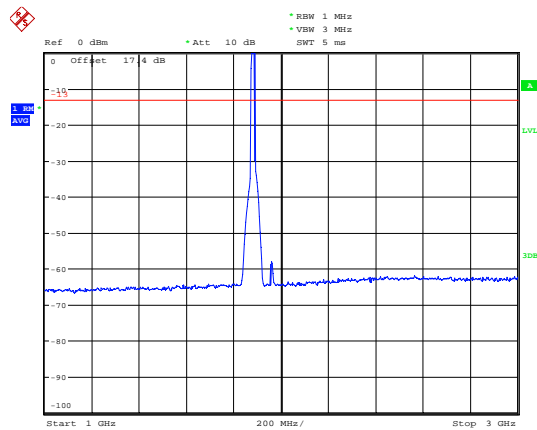

Date: 24.MAR.2019 10:15:08

LTE Band 2 15MHz CH-Low 3GHz~20GHz

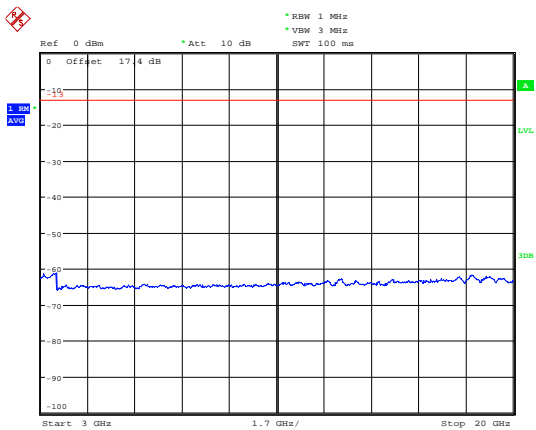

Date: 24.MAR.2019 10:21:06

LTE Band 2 15MHz CH-Middle 3GHz~20GHz

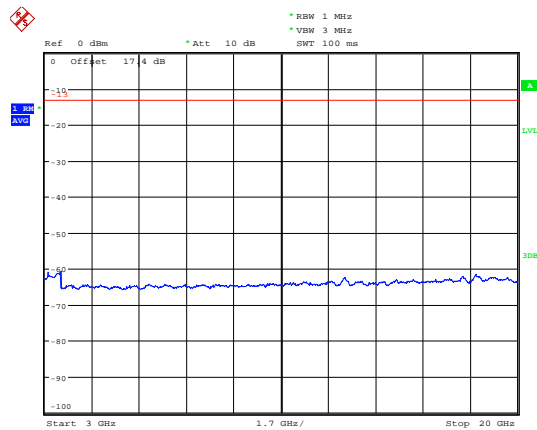

Date: 24.MAR.2019 10:21:19



LTE Band 2 15MHz CH-High 30MHz~1GHz

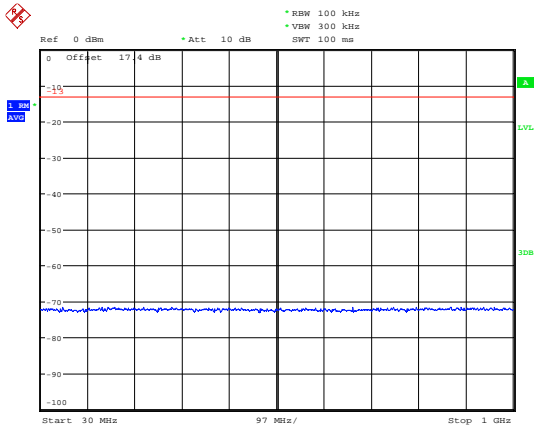

Date: 24.MAR.2019 10:09:17

LTE Band 2 20MHz CH-Low 30MHz~1GHz

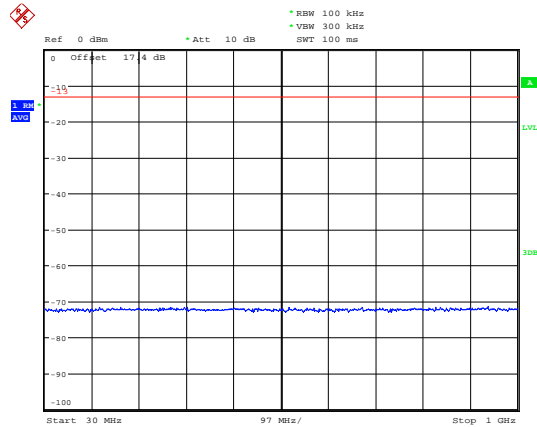

Date: 24.MAR.2019 10:09:40

LTE Band 2 15MHz CH-High 1GHz~3GHz

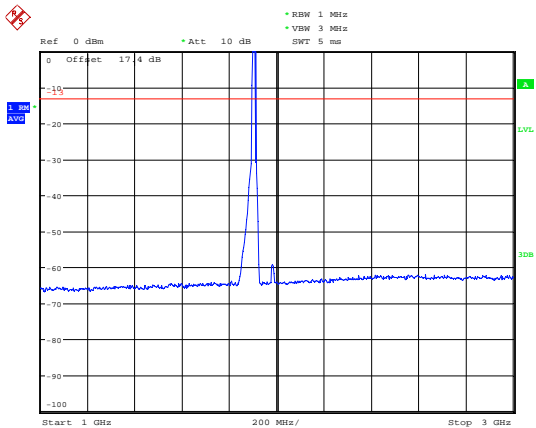

Date: 24.MAR.2019 10:15:22

LTE Band 2 20MHz CH-Low 1GHz~3GHz

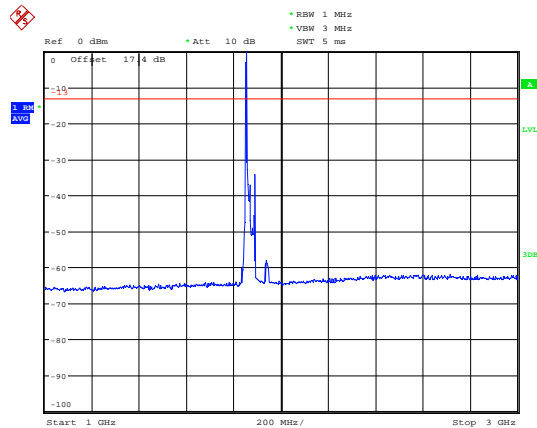

Date: 24.MAR.2019 10:15:45

LTE Band 2 15MHz CH-High 3GHz~20GHz

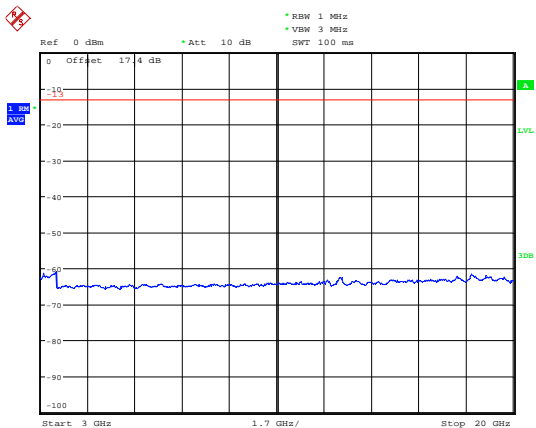

Date: 24.MAR.2019 10:21:33

LTE Band 2 20MHz CH-Low 3GHz~20GHz

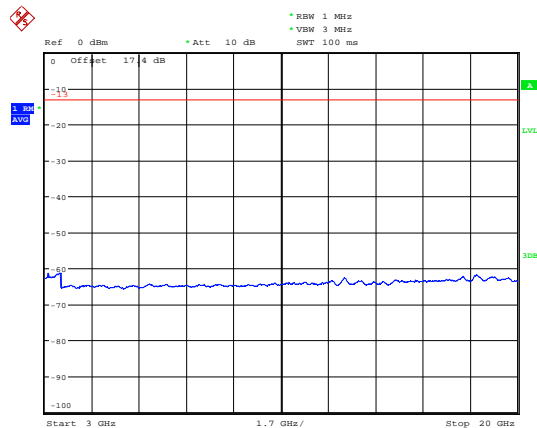

Date: 24.MAR.2019 10:16:54



LTE Band 2 20MHz CH-Middle 30MHz~1GHz

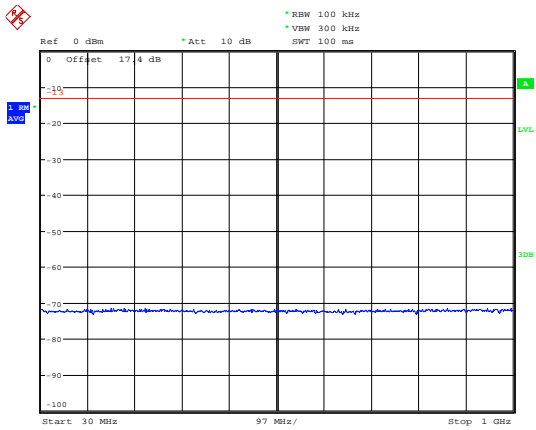

Date: 24.MAR.2019 10:09:52

LTE Band 2 20MHz CH-High 30MHz~1GHz

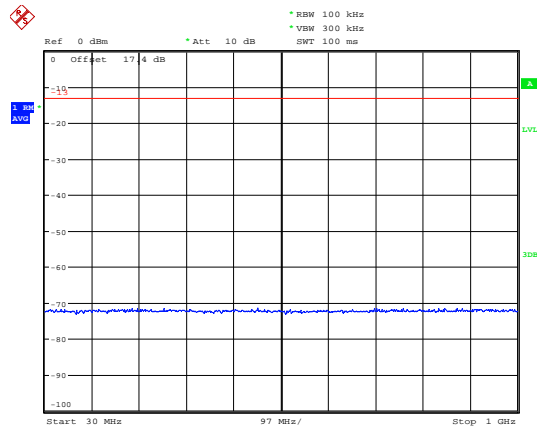

Date: 24.MAR.2019 10:10:01

LTE Band 2 20MHz CH-Middle 1GHz~3GHz

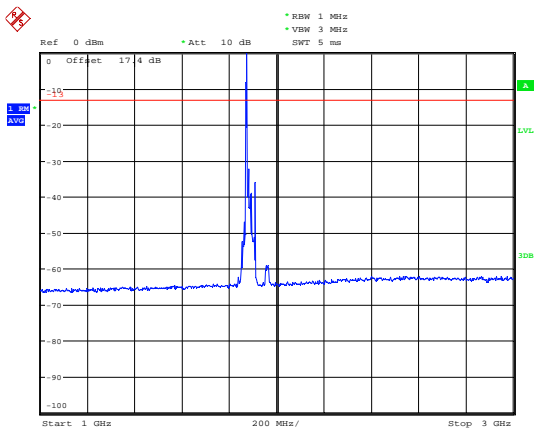

Date: 24.MAR.2019 10:15:56

LTE Band 2 20MHz CH-High 1GHz~3GHz

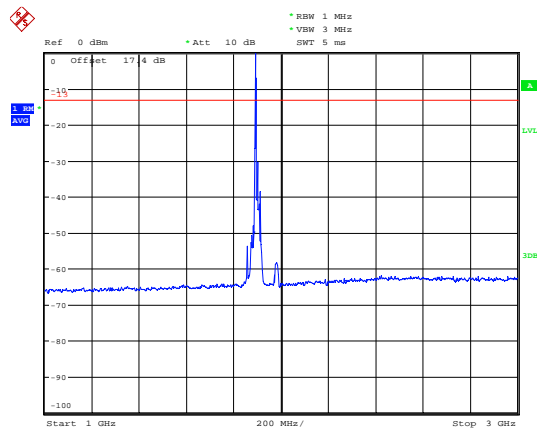

Date: 24.MAR.2019 10:16:08

LTE Band 2 20MHz CH-Middle 3GHz~20GHz

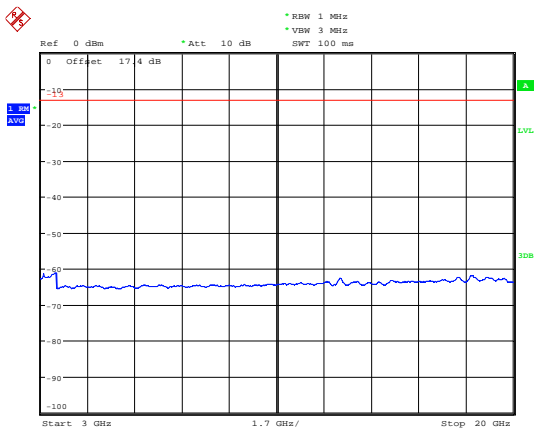

Date: 24.MAR.2019 10:16:37

LTE Band 2 20MHz CH-High 3GHz~20GHz

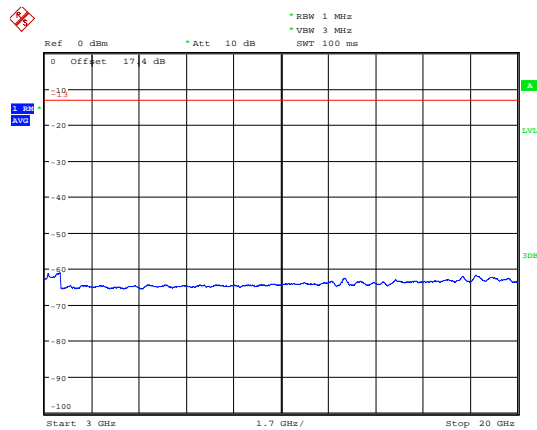

Date: 24.MAR.2019 10:16:25

5.8. Radiates Spurious Emission

Ambient condition

| Temperature | Relative humidity | Pressure |
|-------------|-------------------|----------|
| 23°C ~25°C | 45%~50% | 101.5kPa |

Method of Measurement

- The testing follows FCC KDB 971168 v03r01 Section 5.8 and ANSI C63.26 (2015).
- Below 1GHz: The EUT is placed on a turntable 0.8 meters above the ground in the chamber, 3 meter away from the antenna. The maximal emission value is acquired by adjusting the antenna height, polarisation and turntable azimuth. Normally, the height range of antenna is 1 m to 4 m, the azimuth range of turntable is 0° to 360°, and the receive antenna has two polarizations Vertical (V) and Horizontal (H). Above 1GHz: (Note: the FCC's permission to use 1.5m as an alternative per TCBC Conf call of Dec. 2, 2014.) The EUT is placed on a turntable 1.5 meters above the ground in the chamber, 3 meter away from the antenna. The maximal emission value is acquired by adjusting the antenna height, polarisation and turntable azimuth. Normally, the height range of antenna is 1 m to 4 m, the azimuth range of turntable is 0° to 360°, and the receive antenna has two polarizations Vertical (V) and Horizontal (H).
- A loop antenna, A log-periodic antenna or horn antenna shall be substituted in place of the EUT. The log-periodic antenna will be driven by a signal generator and the level will be adjusted till the same power value on the spectrum analyzer or receiver. The level of the spurious emissions can be calculated through the level of the signal generator, cable loss, the gain of the substitution antenna and the reading of the spectrum analyzer or receiver.
- The EUT is then put into continuously transmitting mode at its maximum power level during the test. Set Test Receiver or Spectrum RBW=200Hz,VBW=600Hz for 9kHz150kHz , RBW=10kHz, VBW=30kHz 150kHz-30MHz , RBW=100kHz,VBW=300kHz for 30MHz to 1GHz and RBW=1MHz, VBW=3MHz for above 1GHz, And the maximum value of the receiver should be recorded as (Pr).
- The EUT shall be replaced by a substitution antenna. In the chamber, an substitution antenna for the frequency band of interest is placed at the reference point of the chamber. An RF Signal source for the frequency band of interest is connected to the substitution antenna with a cable that has been constructed to not interfere with the radiation pattern of the antenna. A power (PMea) is applied to the input of the substitution antenna, and adjust the level of the signal generator output until the value of the receiver reach the previously recorded (Pr). The power of signal source (PMea) is recorded. The test should be performed by rotating the test item and adjusting the receiving antenna polarization.
- A amplifier should be connected to the Signal Source output port. And the cable should be connect between the Amplifier and the Substitution Antenna. The cable loss (Pcl) ,the Substitution Antenna Gain (Ga) and the Amplifier Gain (PAg) should be recorded after test.
- The measurement results are obtained as described below:
 $Power(EIRP)=PMea- PAg - Pcl + Ga$
 The measurement results are amend as described below:
 $Power(EIRP)=PMea- Pcl + Ga$
- This value is EIRP since the measurement is calibrated using an antenna of known gain (2.15 dBi)

and known input power. ERP can be calculated from EIRP by subtracting the gain of the dipole, $ERP = EIRP - 2.15\text{dBi}$.

The modulation mode and RB allocation refer to section 5.1, using the maximum output power configuration.

Test setup

9KHz ~ 30MHz

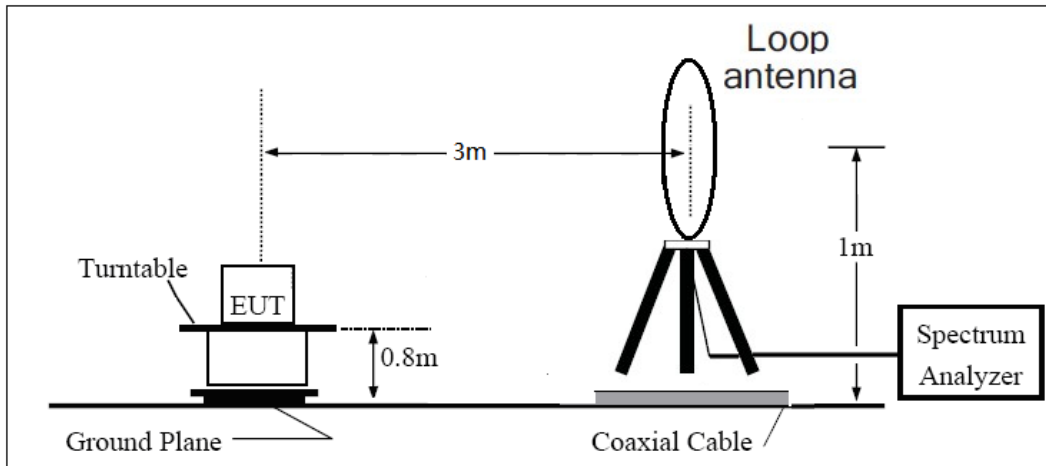

30MHz ~ 1GHz

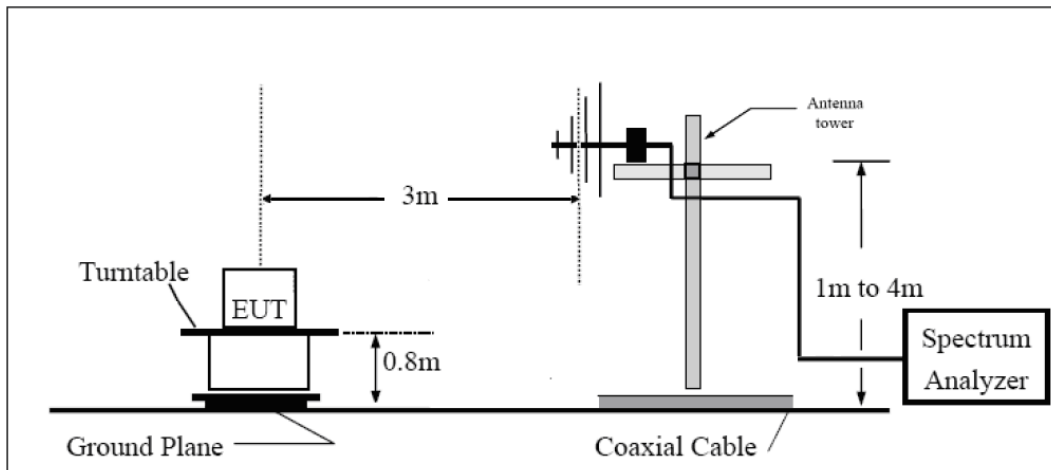

Above 1GHz

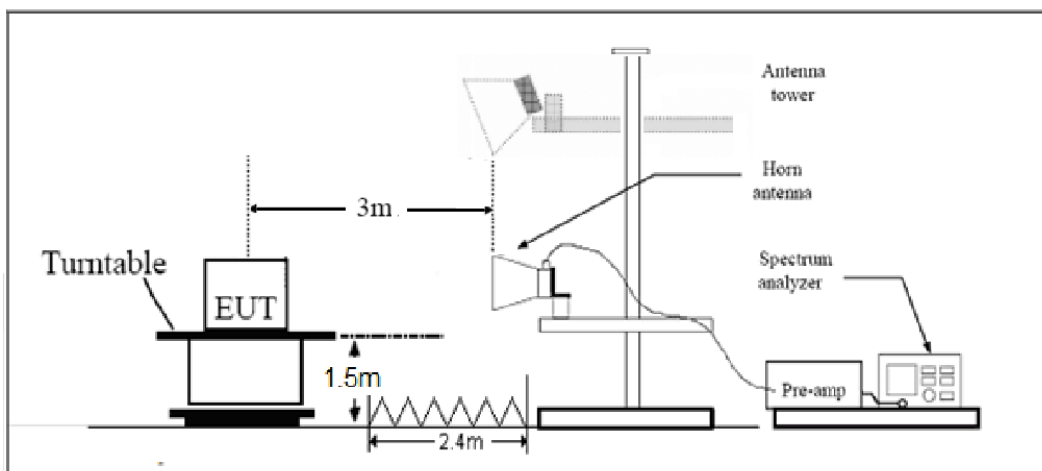



Note: Area side: 2.4mX3.6m

Limits

Rule Part 24.238(a) specifies that “on any frequency outside a licensee's frequency block, the power of any emission shall be attenuated below the transmitter power (P) by at least $43 + 10 \log_{10}(P)$ dB.”

| | |
|-------|---------|
| Limit | -13 dBm |
|-------|---------|

Measurement Uncertainty

The assessed measurement uncertainty to ensure 95% confidence level for the normal distribution is with the coverage factor $k = 1.96$, $U = 3.55$ dB.

Test Result

Sweep the whole frequency band through the range from 9kHz to the 10th harmonic of the carrier, the emissions below the noise floor will not be recorded in the report.

GSM 1900 CH-Middle

| Harmonic | Frequency (MHz) | SG (dBm) | Cable Loss (dB) | Gain (dBi) | Antenna Polarization | EIRP Level (dBm) | Limit (dBm) | Margin (dB) | Azimuth (deg) |
|----------|-----------------|----------|-----------------|------------|----------------------|------------------|-------------|-------------|---------------|
| 2 | 3759.9 | -63.10 | 5.10 | 11.05 | Horizontal | -57.15 | -13.00 | 44.15 | 135 |
| 3 | 5640.2 | -61.11 | 5.42 | 12.65 | Horizontal | -53.88 | -13.00 | 40.88 | 225 |
| 4 | 7519.5 | -55.66 | 6.70 | 13.85 | Horizontal | -48.51 | -13.00 | 35.51 | 90 |
| 5 | 9402.8 | -55.49 | 7.01 | 14.75 | Horizontal | -47.75 | -13.00 | 34.75 | 180 |
| 6 | 11279.3 | -52.47 | 7.48 | 15.95 | Horizontal | -44.00 | -13.00 | 31.00 | 45 |
| 7 | 13159.1 | -53.80 | 7.51 | 16.55 | Horizontal | -44.76 | -13.00 | 31.76 | 0 |
| 8 | 15041.3 | -51.84 | 8.24 | 15.35 | Horizontal | -44.73 | -13.00 | 31.73 | 270 |
| 9 | 16922.3 | -50.49 | 8.41 | 14.95 | Horizontal | -43.95 | -13.00 | 30.95 | 135 |
| 10 | 18800.0 | - | - | - | - | - | - | - | - |

Note: 1.The other Spurious RF Radiated emissions level is no more than noise floor.
 2. The worst emission was found in the antenna is Horizontal position.

WCDMA Band II CH-Middle

| Harmonic | Frequency (MHz) | SG (dBm) | Cable Loss (dB) | Gain (dBi) | Antenna Polarization | EIRP Level (dBm) | Limit (dBm) | Margin (dB) | Azimuth (deg) |
|----------|-----------------|----------|-----------------|------------|----------------------|------------------|-------------|-------------|---------------|
| 2 | 3760.0 | -59.54 | 5.10 | 11.05 | Horizontal | -53.59 | -13.00 | 40.59 | 45 |
| 3 | 5640.0 | -61.78 | 5.42 | 12.65 | Horizontal | -54.55 | -13.00 | 41.55 | 270 |
| 4 | 7520.0 | -56.87 | 6.70 | 13.85 | Horizontal | -49.72 | -13.00 | 36.72 | 90 |
| 5 | 9400.0 | -54.84 | 7.01 | 14.75 | Horizontal | -47.10 | -13.00 | 34.10 | 0 |
| 6 | 11280.0 | -52.57 | 7.48 | 15.95 | Horizontal | -44.10 | -13.00 | 31.10 | 315 |
| 7 | 13160.0 | -54.04 | 7.51 | 16.55 | Horizontal | -45.00 | -13.00 | 32.00 | 225 |
| 8 | 15040.0 | -52.71 | 8.24 | 15.35 | Horizontal | -45.60 | -13.00 | 32.60 | 180 |
| 9 | 16920.0 | -52.33 | 8.41 | 14.95 | Horizontal | -45.79 | -13.00 | 32.79 | 135 |
| 10 | 18800.0 | - | - | - | - | - | - | - | - |

Note: 1.The other Spurious RF Radiated emissions level is no more than noise floor.
 2. The worst emission was found in the antenna is Horizontal position.

LTE Band 2 1.4MHz CH-Middle

| Harmonic | Frequency (MHz) | SG (dBm) | Cable Loss (dB) | Gain (dBi) | Antenna Polarization | EIRP Level (dBm) | Limit (dBm) | Margin (dB) | Azimuth (deg) |
|----------|-----------------|----------|-----------------|------------|----------------------|------------------|-------------|-------------|---------------|
| 2 | 3759.0 | -58.76 | 5.10 | 11.05 | Horizontal | -52.81 | -13.00 | 39.81 | 90 |
| 3 | 5638.9 | -60.92 | 5.42 | 12.65 | Horizontal | -53.69 | -13.00 | 40.69 | 225 |
| 4 | 7520.0 | -54.82 | 6.70 | 13.85 | Horizontal | -47.67 | -13.00 | 34.67 | 135 |
| 5 | 9400.0 | -54.49 | 7.01 | 14.75 | Horizontal | -46.75 | -13.00 | 33.75 | 180 |
| 6 | 11280.0 | -52.17 | 7.48 | 15.95 | Horizontal | -43.70 | -13.00 | 30.70 | 45 |
| 7 | 13160.0 | -51.23 | 7.51 | 16.55 | Horizontal | -42.19 | -13.00 | 29.19 | 225 |
| 8 | 15040.0 | -53.36 | 8.24 | 15.35 | Horizontal | -46.25 | -13.00 | 33.25 | 315 |
| 9 | 16920.0 | -49.44 | 8.41 | 14.95 | Horizontal | -42.90 | -13.00 | 29.90 | 180 |
| 10 | 18800.0 | - | - | - | - | - | - | - | - |

Note: 1.The other Spurious RF Radiated emissions level is no more than noise floor.
 2. The worst emission was found in the antenna is Horizontal position.

LTE Band 2 5MHz CH-Middle

| Harmonic | Frequency (MHz) | SG (dBm) | Cable Loss (dB) | Gain (dBi) | Antenna Polarization | EIRP Level (dBm) | Limit (dBm) | Margin (dB) | Azimuth (deg) |
|----------|-----------------|----------|-----------------|------------|----------------------|------------------|-------------|-------------|---------------|
| 2 | 3760.0 | -61.05 | 5.10 | 11.05 | Horizontal | -55.10 | -13.00 | 42.10 | 90 |
| 3 | 5640.0 | -60.33 | 5.42 | 12.65 | Horizontal | -53.10 | -13.00 | 40.10 | 45 |
| 4 | 7520.0 | -56.46 | 6.70 | 13.85 | Horizontal | -49.31 | -13.00 | 36.31 | 225 |
| 5 | 9400.0 | -53.93 | 7.01 | 14.75 | Horizontal | -46.19 | -13.00 | 33.19 | 135 |
| 6 | 11280.0 | -52.81 | 7.48 | 15.95 | Horizontal | -44.34 | -13.00 | 31.34 | 0 |
| 7 | 13160.0 | -53.84 | 7.51 | 16.55 | Horizontal | -44.80 | -13.00 | 31.80 | 180 |
| 8 | 15040.0 | -52.33 | 8.24 | 15.35 | Horizontal | -45.22 | -13.00 | 32.22 | 270 |
| 9 | 16920.0 | -49.10 | 8.41 | 14.95 | Horizontal | -42.56 | -13.00 | 29.56 | 135 |
| 10 | 18800.0 | - | - | - | - | - | - | - | - |

Note: 1.The other Spurious RF Radiated emissions level is no more than noise floor.
 2. The worst emission was found in the antenna is Horizontal position.



LTE Band 2 20MHz CH-Middle

| Harmonic | Frequency (MHz) | SG (dBm) | Cable Loss (dB) | Gain (dBi) | Antenna Polarization | EIRP Level (dBm) | Limit (dBm) | Margin (dB) | Azimuth (deg) |
|----------|-----------------|----------|-----------------|------------|----------------------|------------------|-------------|-------------|---------------|
| 2 | 3760.0 | -58.50 | 5.10 | 11.05 | Horizontal | -52.55 | -13.00 | 39.55 | 270 |
| 3 | 5640.0 | -60.31 | 5.42 | 12.65 | Horizontal | -53.08 | -13.00 | 40.08 | 135 |
| 4 | 7520.0 | -54.90 | 6.70 | 13.85 | Horizontal | -47.75 | -13.00 | 34.75 | 315 |
| 5 | 9400.0 | -54.51 | 7.01 | 14.75 | Horizontal | -46.77 | -13.00 | 33.77 | 225 |
| 6 | 11280.0 | -52.76 | 7.48 | 15.95 | Horizontal | -44.29 | -13.00 | 31.29 | 90 |
| 7 | 13160.0 | -53.15 | 7.51 | 16.55 | Horizontal | -44.11 | -13.00 | 31.11 | 0 |
| 8 | 15040.0 | -52.99 | 8.24 | 15.35 | Horizontal | -45.88 | -13.00 | 32.88 | 45 |
| 9 | 16920.0 | -49.98 | 8.41 | 14.95 | Horizontal | -43.44 | -13.00 | 30.44 | 90 |
| 10 | 18800.0 | - | - | - | - | - | - | - | - |

Note: 1. The other Spurious RF Radiated emissions level is no more than noise floor.

2. The worst emission was found in the antenna is Horizontal position.

6. Main Test Instruments

| Name | Manufacturer | Type | Serial Number | Calibration Date | Expiration Date |
|--------------------------------------|--------------|--------------|---------------|------------------|-----------------|
| Base Station Simulator | R&S | CMU200 | 118133 | 2018-05-13 | 2019-05-12 |
| Base Station Simulator | R&S | CMW500 | 113824 | 2018-05-20 | 2019-05-19 |
| Power Splitter | Hua Xiang | SHX-GF2-2-13 | 10120101 | / | / |
| Spectrum Analyzer | Key sight | N9010A | MY50210259 | 2018-05-20 | 2019-05-19 |
| Universal Radio Communication Tester | Key sight | E5515C | MY48367192 | 2018-05-20 | 2019-05-19 |
| Signal Analyzer | R&S | FSV30 | 100815 | 2018-12-16 | 2019-12-15 |
| Loop Antenna | SCHWARZBECK | FMZB1519 | 1519-047 | 2017-09-26 | 2019-09-25 |
| Trilog Antenna | SCHWARZBECK | VUBL 9163 | 9163-201 | 2017-11-18 | 2019-11-17 |
| Horn Antenna | R&S | HF907 | 100126 | 2018-07-07 | 2020-07-06 |
| Horn Antenna | ETS-Lindgren | 3160-09 | 00102643 | 2018-06-20 | 2020-06-19 |
| Signal generator | R&S | SMB 100A | 102594 | 2018-05-20 | 2019-05-19 |
| Climatic Chamber | ESPEC | SU-242 | 93000506 | 2017-12-17 | 2020-12-16 |
| Preamplifier | R&S | SCU18 | 102327 | 2018-05-20 | 2019-05-19 |
| MOB COMMS DC SUPPLY | Keysight | 66319D | MY43004105 | 2018-05-07 | 2019-05-06 |
| RF Cable | Agilent | SMA 15cm | 0001 | 2019-03-15 | 2019-06-14 |
| Software | R&S | EMC32 | 9.26.0 | / | / |

*****END OF REPORT *****

ANNEX A: Product Change Description

Huawei Technologies Co., Ltd.

Difference Declaration Letter

Article 1: Difference description:

The difference between model AMN-LX3 and model KSA-LX3 is show in the below table:

| | Model | AMN-LX3 | KSA-LX3 |
|----------------------|--------------------|-------------|--|
| Licensed Frequency | LTE BAND | the same | the same |
| | UMTS BAND | the same | the same |
| | GSM | the same | the same |
| | IC | the same | the same |
| | Antenna | the same | the same |
| | RF conducted power | the same | the same |
| Unlicensed Frequency | Bluetooth | the same | the same |
| | 2.4G Wi-Fi | the same | the same |
| | IC | the same | the same |
| | Antenna | the same | the same |
| Hardware | NFC | Not support | Not support |
| | MIC | the same | the same |
| | Ram / Rom | the same | the same |
| | Camera | the same | the same |
| | PCB | the same | the same |
| | USB Port | the same | the same |
| | SIM | the same | the same |
| RF | RF | the same | the same |
| Appearance | Dimension | the same | Only the rear camera has a different curved appearance |
| | Color | the same | the same |
| Accessory | Battery | the same | the same |
| | Charger | the same | the same |
| | USB label | the same | the same |
| | Earphone | the same | the same |