



# RF TEST REPORT

**Applicant** Huawei Technologies Co., Ltd.  
**FCC ID** QISKSA-LX3  
**Product** Smart Phone  
**Brand** HONOR  
**Model** KSA-LX3  
**Report No.** R1903H0046-R1  
**Issue Date** April 12, 2019

TA Technology (Shanghai) Co., Ltd. tested the above equipment in accordance with the requirements in **FCC CFR47 Part 2 (2019)/ FCC CFR 47 Part 22H (2019)**. The test results show that the equipment tested is capable of demonstrating compliance with the requirements as documented in this report.

Performed by: Peng Tao

Approved by: Kai Xu

---

## TA Technology (Shanghai) Co., Ltd.

No.145, Jintang Rd, Tangzhen Industry Park, Pudong Shanghai, China

TEL: +86-021-50791141/2/3

FAX: +86-021-50791141/2/3-8000



## TABLE OF CONTENT

1. Test Laboratory .....	4
1.1. Notes of the Test Report .....	4
1.2. Test facility .....	4
1.3. Testing Location .....	5
2. General Description of Equipment under Test.....	6
3. Applied Standards .....	8
4. Test Configuration .....	9
5. Test Case Results .....	11
5.1. RF Power Output .....	11
5.2. Effective Radiated Power .....	15
5.3. Occupied Bandwidth .....	19
5.4. Band Edge Compliance .....	28
5.5. Peak-to-Average Power Ratio (PAPR).....	36
5.6. Frequency Stability.....	39
5.7. Spurious Emissions at Antenna Terminals.....	44
5.8. Radiates Spurious Emission .....	51
6. Main Test Instruments.....	57
ANNEX A: Product Change Description .....	58

## Summary of measurement results

No.	Test Type	Clause in FCC rules	Verdict
1	RF power output	2.1046	Refer to the Original
2	Effective Radiated Power	22.913(a)(5)	Refer to the Original
3	Occupied Bandwidth	2.1049	Refer to the Original
4	Band Edge Compliance	2.1051 / 22.917(a)	Refer to the Original
5	Peak-to-Average Power Ratio	22.913(d)/ KDB 971168 D01(5.7)	Refer to the Original
6	Frequency Stability	2.1055 / 22.355	Refer to the Original
7	Spurious Emissions at Antenna Terminals	2.1051 / 22.917(a)	Refer to the Original
8	Radiates Spurious Emission	2.1053 / 22.917 (a)	Only tested the worst Band of Original

Date of Testing: March 17, 2019 ~ March 29, 2019 and March 24, 2019 ~ April 3, 2019

Note: PASS: The EUT complies with the essential requirements in the standard.  
FAIL: The EUT does not comply with the essential requirements in the standard.

**KSA-LX3 (Report No:R1903H0046-R1) is a variant model of AMN-LX3 (Report No: R1903H0043-R1). Test values partial duplicated from Original for variant. There is only tested Radiates Spurious Emission of GSM850 for variant in this report. The detailed product change description please refers to the ANNEX A.**



## 1. Test Laboratory

### 1.1. Notes of the Test Report

This report shall not be reproduced in full or partial, without the written approval of **TA technology (shanghai) co., Ltd.** The results documented in this report apply only to the tested sample, under the conditions and modes of operation as described herein .Measurement Uncertainties were not taken into account and are published for informational purposes only. This report is written to support regulatory compliance of the applicable standards stated above.

### 1.2. Test facility

#### **CNAS (accreditation number: L2264)**

TA Technology (Shanghai) Co., Ltd. has obtained the accreditation of China National Accreditation Service for Conformity Assessment (CNAS).

#### **FCC (Designation number: CN1179, Test Firm Registration Number: 446626)**

TA Technology (Shanghai) Co., Ltd. has been listed on the US Federal Communications Commission list of test facilities recognized to perform electromagnetic emissions measurements.

#### **IC (recognition number is 8510A)**

TA Technology (Shanghai) Co., Ltd. has been listed by industry Canada to perform electromagnetic emission measurement.

#### **VCCI (recognition number is C-4595, T-2154, R-4113, G-10766)**

TA Technology (Shanghai) Co., Ltd. has been listed by industry Japan to perform electromagnetic emission measurement.

#### **A2LA (Certificate Number: 3857.01)**

TA Technology (Shanghai) Co., Ltd. has been listed by American Association for Laboratory Accreditation to perform electromagnetic emission measurement.



### 1.3. Testing Location

Company: TA Technology (Shanghai) Co., Ltd.  
Address: No.145, Jintang Rd, Tangzhen Industry Park, Pudong  
City: Shanghai  
Post code: 201201  
Country: P. R. China  
Contact: Xu Kai  
Telephone: +86-021-50791141/2/3  
Fax: +86-021-50791141/2/3-8000  
Website: <http://www.ta-shanghai.com>  
E-mail: [xukai@ta-shanghai.com](mailto:xukai@ta-shanghai.com)

## 2. General Description of Equipment under Test

### Client Information

Applicant	Huawei Technologies Co., Ltd.
Applicant address	Administration Building, Headquarters of Huawei Technologies Co., Ltd., Bantian, Longgang District Shenzhen 518129 P.R.China
Manufacturer	Huawei Technologies Co., Ltd.
Manufacturer address	Administration Building, Headquarters of Huawei Technologies Co., Ltd., Bantian, Longgang District Shenzhen 518129 P.R.China

### General Information

EUT Description			
Model	KSA-LX3		
IMEI	IMEI 1: 862570040005091 IMEI 2: 862570040008004		
Hardware Version	HL1AMNM		
Software Version	5.0.1.37(C900E20R1P2)		
Power Supply	Battery/AC adapter		
Antenna Type	Internal Antenna		
Antenna Gain	GSM850: 0.24dBi WCDMA Band V: 0.24dBi LTE Band 5: 0.24dBi		
Test Mode(s)	GSM 850; WCDMA Band V; LTE Band 5;		
Test Modulation	(GSM)GMSK,8PSK; (WCDMA)QPSK,16QAM; (LTE)QPSK 16QAM;		
GPRS Multislot Class	12		
EGPRS Multislot Class	12		
HSDPA UE Category	14		
HSUPA UE Category	7		
DC-HSDPA UE Category	24		
HSPA+ UE Category	7		
LTE Category	4		
Maximum E.R.P.	GSM 850:	28.82dBm	
	WCDMA Band V:	19.47dBm	
	LTE Band 5:	19.42dBm	
Rated Power Supply Voltage	3.82V		
Extreme Voltage	Minimum: 3.6V    Maximum: 4.4V		
Extreme Temperature	Lowest: -10°C    Highest: +55°C		
Operating Frequency Range(s)	Band	Tx (MHz)	Rx (MHz)
	GSM850	824 ~ 849	869 ~ 894



	WCDMA Band V	824 ~ 849	869 ~ 894
	LTE Band 5	824 ~ 849	869 ~ 894
<b>EUT Accessory</b>			
Adapter 1	Manufacturer: HuaweiTechnologies Co., Ltd. (SHENZHEN HUNTKEY ELECTRIC CO., LTD.) Model: HW-050100U01		
Adapter 2	Manufacturer: HuaweiTechnologies Co., Ltd. (HUIZHOU BYD ELECTRONIC CO., LTD.) Model: HW-050100U01		
Adapter 3	Manufacturer: HuaweiTechnologies Co., Ltd. (Dongguan Phitek Electronics Co., Ltd.) Model: HW-050100U01		
Battery 1	Manufacturer: HuaweiTechnologies Co., Ltd. (Sunwoda Electronic Co.,LTD ) Model: HB405979ECW		
Battery 2	Manufacturer: HuaweiTechnologies Co., Ltd. (SCUD (Fujian) Electronics Co., LTD.) Model: HB405979ECW		
Battery 3	Manufacturer: HuaweiTechnologies Co., Ltd. (Desay Battery Electronic Co.,LTD ) Model: HB405979ECW		
Earphone 1	Manufacturer: Jiangxi Lianchuang Hongsheng Electronic Co. ,LTD Model: MEND1532B528A02		
Earphone 2	Manufacturer: Boluo County Quancheng Electronic Co.,ltd. Model: 1293-3283-3.5MM-322		
USB Cable 1	Manufacturer: HONGLIN TECHNOLOGY CO.,LTD. Model: 130-26654		
USB Cable 2	Manufacturer: Dongguan Ming Ji Electronics Co.,Ltd. Model: 203-0786-0		
USB Cable 3	Manufacturer: Luxshare Precision industry Co., Ltd. Model: L99U2013-CS-H		
USB Cable 4	Manufacturer: NingBo Broad Telecommunication Co., Ltd. Model: WA0007		
<p>Note: 1.The information of the EUT is declared by the manufacturer.</p> <p>2. There are more than one Adapter, Battery, Earphone and USB Cable, each one should be applied throughout the compliance test respectively, however, only the worst case (Adapter 2, Battery 2 and USB Cable 2) will be recorded in this report.</p>			



### **3. Applied Standards**

According to the specifications of the manufacturer, it must comply with the requirements of the following standards:

**FCC CFR47 Part 2 (2019)**

**FCC CFR 47 Part 22H (2019)**

**ANSI C63.26 (2015)**

**KDB 971168 D01 Power Meas License Digital Systems v03r01**



## 4. Test Configuration

There is more than one SIM card slot, each one should be applied throughout the compliance test respectively, and however, only the worst case (SIM 1) will be recorded in this report

Radiated measurements are performed by rotating the EUT in three different orthogonal test planes. EUT stand-up position (Z axis), lie-down position (X, Y axis). Receiver antenna polarization (horizontal and vertical), the worst emission was found in position (X axis, horizontal polarization) and the worst case was recorded.

All mode and data rates and positions were investigated. Subsequently, only the worst case emissions are reported.

The following testing in GSM/WCDMA/LTE is set based on the maximum RF Output Power.

Test modes are chosen to be reported as the worst case configuration below:

Test items	Modes/Modulation	
	GSM 850	WCDMA Band V
RF power output	GSM GPRS EGPRS	RMC HSDPA/HSUPA DC-HSDPA HSPA+
Effective Radiated Power	GSM GPRS(1Tx slot) EGPRS(1Tx slot)	RMC
Occupied Bandwidth	GSM GPRS(1Tx slot) EGPRS(1Tx slot)	RMC
Band Edge Compliance	GSM GPRS(1Tx slot) EGPRS(1Tx slot)	RMC
Peak-to-Average Power Ratio	GSM GPRS(1Tx slot) EGPRS(1Tx slot)	RMC
Frequency Stability	GSM GPRS(1Tx slot) EGPRS(1Tx slot)	RMC
Spurious Emissions at Antenna Terminals	GSM	RMC
Radiates Spurious Emission	GSM	RMC

Test modes are chosen as the worst case configuration below for LTE Band 5.

Test items	Bandwidth (MHz)				Modulation		RB			Test Channel		
	1.4	3	5	10	QPSK	16QAM	1	50%	100%	L	M	H
RF power output	○	○	○	○	○	○	○	○	○	○	○	○
Effective Isotropic Radiated power	○	○	○	○	○	○	○	○	○	○	○	○
Occupied Bandwidth	○	○	○	○	○	○	-	-	○	○	○	○
Band Edge Compliance	○	○	○	○	○	○	○	-	○	○	-	○
Peak-to-Average Power Ratio	○	○	○	○	○	○	-	-	○	○	○	○
Frequency Stability	○	○	○	○	○	○	○	○	○	○	○	○
Spurious Emissions at Antenna Terminals	○	○	○	○	○	-	-	-	○	○	○	○
Radiates Spurious Emission	○	-	○	○	○	-	○	-	-	-	○	-
Note	1. The mark "○" means that this configuration is chosen for testing. 2. The mark "-" means that this configuration is not testing.											

## 5. Test Case Results

### 5.1. RF Power Output

#### Ambient condition

Temperature	Relative humidity	Pressure
23°C ~25°C	45%~50%	101.5kPa

#### Methods of Measurement

During the process of the testing, The EUT is controlled by the Base Station Simulator to ensure max power transmission and proper modulation.

#### Test Setup

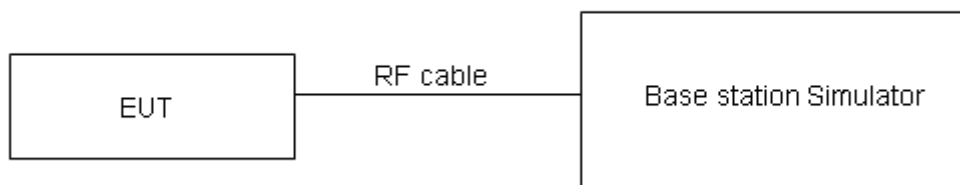

The loss between RF output port of the EUT and the input port of the tester has been taken into consideration.

#### Limits

No specific RF power output requirements in part 2.1046.

#### Measurement Uncertainty

The assessed measurement uncertainty to ensure 95% confidence level for the normal distribution is with the coverage factor  $k = 2$ ,  $U = 0.4$  dB.

**Test Results**

GSM 850		Conducted Power(dBm)		
		Channel 128	Channel 190	Channel 251
		824.2 (MHz)	836.6 (MHz)	848.8 (MHz)
GSM	Results	32.88	32.82	32.81
GPRS/EGPRS (GMSK)	1TXslot	32.65	32.67	32.69
	2TXslots	29.73	29.74	29.77
	3TXslots	27.92	27.94	28.00
	4TXslots	26.55	26.61	26.67
EGPRS (8PSK)	1TXslot	26.90	26.87	26.86
	2TXslots	23.61	23.56	23.47
	3TXslots	21.93	21.89	21.84
	4TXslots	20.74	20.55	20.13

WCDMA Band V		Conducted Power(dBm)		
		Channel 4132	Channel 4183	Channel 4233
		826.4(MHz)	836.6(MHz)	846.6(MHz)
RMC	12.2k	23.97	23.84	23.80
	64k	23.98	23.85	23.77
	144k	23.99	23.83	23.79
	384k	23.95	23.82	23.82
HSDPA	Sub - Test 1	23.43	23.26	23.24
	Sub - Test 2	23.42	23.28	23.21
	Sub - Test 3	22.89	22.78	22.73
	Sub - Test 4	22.90	22.79	22.71
HSUPA	Sub - Test 1	23.39	23.25	23.19
	Sub - Test 2	22.38	22.23	22.18
	Sub - Test 3	22.85	22.71	22.67
	Sub - Test 4	22.31	22.20	22.15
	Sub - Test 5	23.32	23.18	23.13
DC-HSDPA	Sub - Test 1	23.31	23.20	23.14
	Sub - Test 2	23.30	23.19	23.13
	Sub - Test 3	22.88	22.68	22.64
	Sub - Test 4	22.87	22.67	22.63
HSPA+	16QAM	22.86	22.75	22.70

LTE Band 5				Conducted Power(dBm)		
BW	Modulation	RB size	RB offset	Channel/Frequency(MHz)		
				20407/824.7	20525/836.5	20643/848.3
1.4MHz	QPSK	1	0	24.07	24.01	23.98
		1	2	24.22	24.02	23.97
		1	5	23.99	23.91	23.92
		3	0	23.05	22.99	23.07
		3	2	23.10	23.04	23.06
		3	3	23.14	23.00	22.94
		6	0	23.02	23.04	23.03
	16QAM	1	0	23.55	23.16	23.50
		1	2	23.16	23.03	23.35
		1	5	23.22	23.06	23.33
		3	0	22.07	22.09	22.03
		3	2	22.13	22.05	22.10
		3	3	22.09	22.12	22.02
		6	0	22.05	22.05	22.01
BW	Modulation	RB size	RB offset	Channel/Frequency(MHz)		
				20415/825.5	20525/836.5	20635/847.5
3MHz	QPSK	1	0	24.09	24.02	24.01
		1	7	24.25	24.06	24.05
		1	14	24.01	23.95	23.96
		8	0	23.08	23.04	23.11
		8	4	23.13	23.09	23.09
		8	7	23.16	23.04	22.99
		15	0	23.10	23.06	23.07
	16QAM	1	0	23.57	23.19	23.52
		1	7	23.19	23.07	23.38
		1	14	23.25	23.08	23.36
		8	0	22.10	22.14	22.07
		8	4	22.15	22.09	22.13
		8	7	22.12	22.16	22.06
		15	0	22.08	22.10	22.05
BW	Modulation	RB size	RB offset	Channel/Frequency(MHz)		
				20425/826.5	20525/836.5	20625/846.5
5MHz	QPSK	1	0	24.08	23.98	23.99



		1	13	24.23	24.05	24.02	
		1	24	23.97	23.90	23.91	
		12	0	23.06	23.00	23.08	
		12	6	23.10	23.04	23.05	
		12	13	23.13	23.01	22.95	
		25	0	23.08	23.02	23.02	
	16QAM	1	0	23.52	23.17	23.50	
		1	13	23.19	23.04	23.36	
		1	24	23.22	23.04	23.33	
		12	0	22.07	22.12	22.04	
		12	6	22.11	22.04	22.09	
		12	13	22.10	22.08	22.03	
			25	0	22.05	22.05	22.01
	BW	Modulation	RB size	RB offset	Channel/Frequency(MHz)		
20450/829					20525/836.5	20600/844	
10MHz	QPSK	1	0	24.05	23.94	23.96	
		1	25	24.22	24.01	24.00	
		1	49	23.96	23.89	23.88	
		25	0	23.03	22.95	23.04	
		25	13	23.08	23.00	23.02	
		25	25	23.10	22.96	22.91	
	16QAM	50	0	23.05	22.97	22.98	
		1	0	23.50	23.13	23.45	
		1	25	23.13	23.02	23.32	
		1	49	23.20	23.01	23.31	
		25	0	22.04	22.08	22.01	
		25	13	22.09	22.02	22.06	
		25	25	22.07	22.05	21.99	
			50	0	22.03	22.01	21.98

## 5.2. Effective Radiated Power

### Ambient condition

Temperature	Relative humidity	Pressure
23°C ~25°C	45%~50%	101.5kPa

### Methods of Measurement

The testing follows FCC KDB 971168 v03r01 Section 5.8 and ANSI C63.26 (2015).

- a) Connect the equipment as illustrated. Mount the equipment with the manufacturer specified antenna in a vertical orientation on a manufacturer specified mounting surface located on a non-conducting rotating platform of a RF anechoic chamber (preferred) or a standard radiation site.
- b) Key the transmitter, then rotate the EUT 360° azimuthally and record spectrum analyzer power level (LVL) measurements at angular increments that are sufficiently small to permit resolution of all peaks. If a standard radiation test site is used, raise and lower the test antenna to obtain a maximum reading at each angular increment. (Note: several batteries may be needed to offset the effect of battery voltage droop, which should not exceed 5% of the manufactured specified battery voltage during transmission).
- c) Replace the transmitter under test with a vertically polarized half-wave dipole (or an antenna whose gain is known relative to an ideal half-wave dipole). The center of the antenna should be at the same location as the center of the antenna under test.
- d) Connect the antenna to a signal generator with a known output power and record the path loss (in dB) as LOSS. If a standard radiation test site is used, raise and lower the test antenna to obtain a maximum reading.  $LOSS = \text{Generator Output Power (dBm)} - \text{Analyzer reading (dBm)}$
- e) Determine the effective radiated output power at each angular position from the readings in steps b) and d) using the following equation:  $ERP \text{ (dBm)} = LVL \text{ (dBm)} + LOSS \text{ (dB)}$
- f) The maximum ERP is the maximum value determined in the preceding step.
- g) When calculating ERP, in addition to knowing the antenna radiation and matching characteristics, it is necessary to know the loss values of all elements (e.g. transmission line attenuation, mismatches, filters, combiners) interposed between the point where transmitter output power is measured, and the point where power is applied to the antenna. ERP can then be calculated as follows:  
 $EIRP \text{ (dBm)} = \text{Output Power (dBm)} - \text{Losses (dB)} + \text{Antenna Gain (dBi)}$   
where: dBd refers to gain relative to an ideal dipole.  
 $EIRP \text{ (dBm)} = ERP \text{ (dBm)} + 2.15 \text{ (dB.)}$

The RB allocation refers to section 5.1, using the maximum output power configuration.

**Test setup**

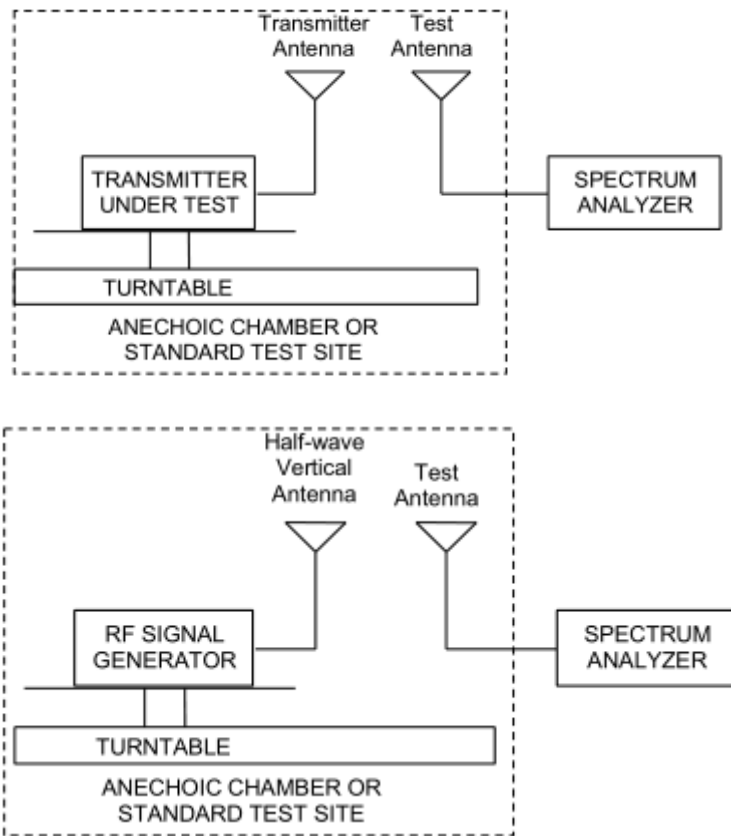

**Limits**

Rule Part 22.913(a)(5) specifies that "Mobile/portable stations are limited to 7 watts ERP".

Limit	$\leq 7 \text{ W}$ (38.45 dBm)
-------	--------------------------------

**Measurement Uncertainty**

The assessed measurement uncertainty to ensure 95% confidence level for the normal distribution is with the coverage factor  $k = 2$ ,  $U = 1.19 \text{ dB}$



**Test Results:**

The measurement is performed for both of horizontal and vertical antenna Polarization, and only the data of worst mode is recorded in this report.

Mode	Channel	Frequency (MHz)	Polarization	ERP (dBm)	Limit (dBm)	Conclusion
GSM 850	Low	824.2	Horizontal	27.65	38.45	Pass
	Mid	836.6	Horizontal	28.42	38.45	Pass
	High	848.8	Horizontal	28.33	38.45	Pass
GPRS 850	Low	824.2	Horizontal	27.97	38.45	Pass
	Mid	836.6	Horizontal	28.72	38.45	Pass
	High	848.8	Horizontal	28.82	38.45	Pass
EGPRS 850	Low	824.2	Horizontal	26.74	38.45	Pass
	Mid	836.6	Horizontal	27.40	38.45	Pass
	High	848.8	Horizontal	27.37	38.45	Pass
WCDMA Band V	Low	826.4	Horizontal	19.10	38.45	Pass
	Mid	836.6	Horizontal	19.44	38.45	Pass
	High	846.6	Horizontal	19.47	38.45	Pass

LTE Band 5						
bandwidth	Channel	Frequency (MHz)	Polarization	ERP (dBm)	Limit (dBm)	Conclusion
<b>1.4 MHz (QPSK)</b>	Low	824.7	Horizontal	18.90	38.45	Pass
	Mid	836.5	Horizontal	19.02	38.45	Pass
	High	848.3	Horizontal	19.28	38.45	Pass
<b>3 MHz (QPSK)</b>	Low	825.5	Horizontal	18.94	38.45	Pass
	Mid	836.5	Horizontal	19.06	38.45	Pass
	High	847.5	Horizontal	19.28	38.45	Pass
<b>5 MHz (QPSK)</b>	Low	826.5	Horizontal	18.93	38.45	Pass
	Mid	836.5	Horizontal	19.08	38.45	Pass
	High	846.5	Horizontal	19.42	38.45	Pass
<b>10 MHz (QPSK)</b>	Low	829	Horizontal	18.93	38.45	Pass
	Mid	836.5	Horizontal	19.18	38.45	Pass
	High	844	Horizontal	19.26	38.45	Pass
<b>1.4 MHz (16QAM)</b>	Low	824.7	Horizontal	18.44	38.45	Pass
	Mid	836.5	Horizontal	18.53	38.45	Pass
	High	848.3	Horizontal	18.72	38.45	Pass
<b>3 MHz (16QAM)</b>	Low	825.5	Horizontal	18.27	38.45	Pass
	Mid	836.5	Horizontal	18.53	38.45	Pass
	High	847.5	Horizontal	18.62	38.45	Pass
<b>5 MHz (16QAM)</b>	Low	826.5	Horizontal	18.43	38.45	Pass
	Mid	836.5	Horizontal	18.59	38.45	Pass
	High	846.5	Horizontal	18.96	38.45	Pass
<b>10 MHz (16QAM)</b>	Low	829	Horizontal	18.52	38.45	Pass
	Mid	836.5	Horizontal	18.48	38.45	Pass
	High	844	Horizontal	18.83	38.45	Pass

### 5.3. Occupied Bandwidth

#### Ambient condition

Temperature	Relative humidity	Pressure
23°C ~25°C	45%~50%	101.5kPa

#### Method of Measurement

The EUT was connected to Spectrum Analyzer and Base Station Simulator via power Splitter. The occupied bandwidth is measured using spectrum analyzer.

RBW is set to 3kHz, VBW is set to 10kHz for GSM 850,

RBW is set to 51kHz, VBW is set to 160kHz for WCDMA Band V,

RBW is set to 51 kHz, VBW is set to 160 kHz for LTE Band 5 (1.4MHz),

RBW is set to 100 kHz, VBW is set to 300 kHz for LTE Band 5 (3MHz/5MHz/10MHz),

99% power and -26dBc occupied bandwidths are recorded. Spectrum analyzer plots are included on the following pages.

#### Test Setup

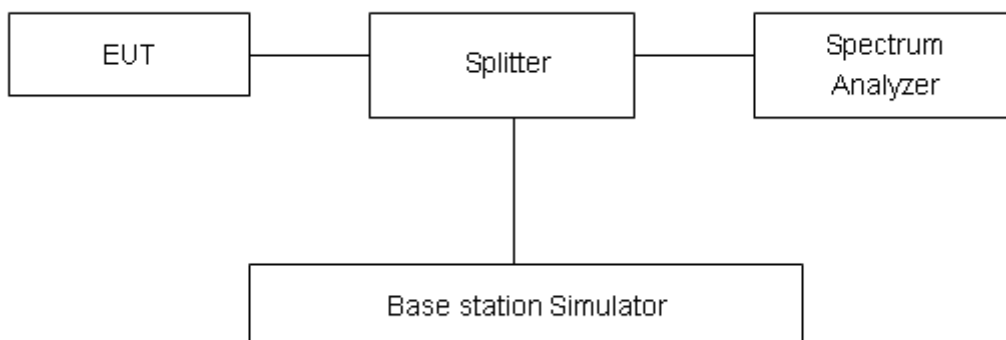

#### Limits

No specific occupied bandwidth requirements in part 2.1049.

#### Measurement Uncertainty

The assessed measurement uncertainty to ensure 95% confidence level for the normal distribution is with the coverage factor  $k = 2$ ,  $U = 624\text{Hz}$ .

**Test Result**

Mode	Channel	Frequency (MHz)	99% Power Bandwidth (MHz)	-26dBc Bandwidth(MHz)
<b>GSM 850 (GSM)</b>	128	824.2	0.24453	0.3092
	190	836.6	0.24462	0.3052
	251	848.8	0.24443	0.3115
<b>GPRS 850 (GMSK)</b>	128	824.2	0.24898	0.3156
	190	836.6	0.25069	0.3100
	251	848.8	0.24800	0.3104
<b>EGPRS 850 (8-PSK)</b>	128	824.2	0.25299	0.3133
	190	836.6	0.25249	0.3128
	251	848.8	0.25228	0.3132
<b>WCDMA Band V (RMC)</b>	4132	826.4	4.1592	4.679
	4183	836.6	4.1562	4.669
	4233	846.6	4.1670	4.683



LTE Band 5						
RB	Modulation	Bandwidth (MHz)	Channel	Frequency (MHz)	99% Power Bandwidth(MHz)	-26dBc Bandwidth(MHz)
100%	QPSK	1.4	20407	824.7	1.1167	1.340
			20525	836.5	1.1222	1.343
			20643	848.3	1.1273	1.326
		3	20415	825.5	2.7231	3.004
			20525	836.5	2.7289	3.000
			20635	847.5	2.7287	2.983
		5	20425	826.5	4.5154	4.968
			20525	836.5	4.5063	4.931
			20625	846.5	4.5054	4.920
		10	20450	829	8.9557	9.652
			20525	836.5	8.9438	9.532
			20600	844	8.9462	9.516
	16QAM	1.4	20407	824.7	1.1240	1.340
			20525	836.5	1.1090	1.326
			20643	848.3	1.1102	1.344
		3	20415	825.5	2.7100	2.969
			20525	836.5	2.7234	2.994
			20635	847.5	2.7159	2.990
		5	20425	826.5	4.4890	4.869
			20525	836.5	4.5269	4.937
			20625	846.5	4.5131	4.961
		10	20450	829	8.9309	9.461
			20525	836.5	8.9486	9.543
			20600	844	8.9431	9.608

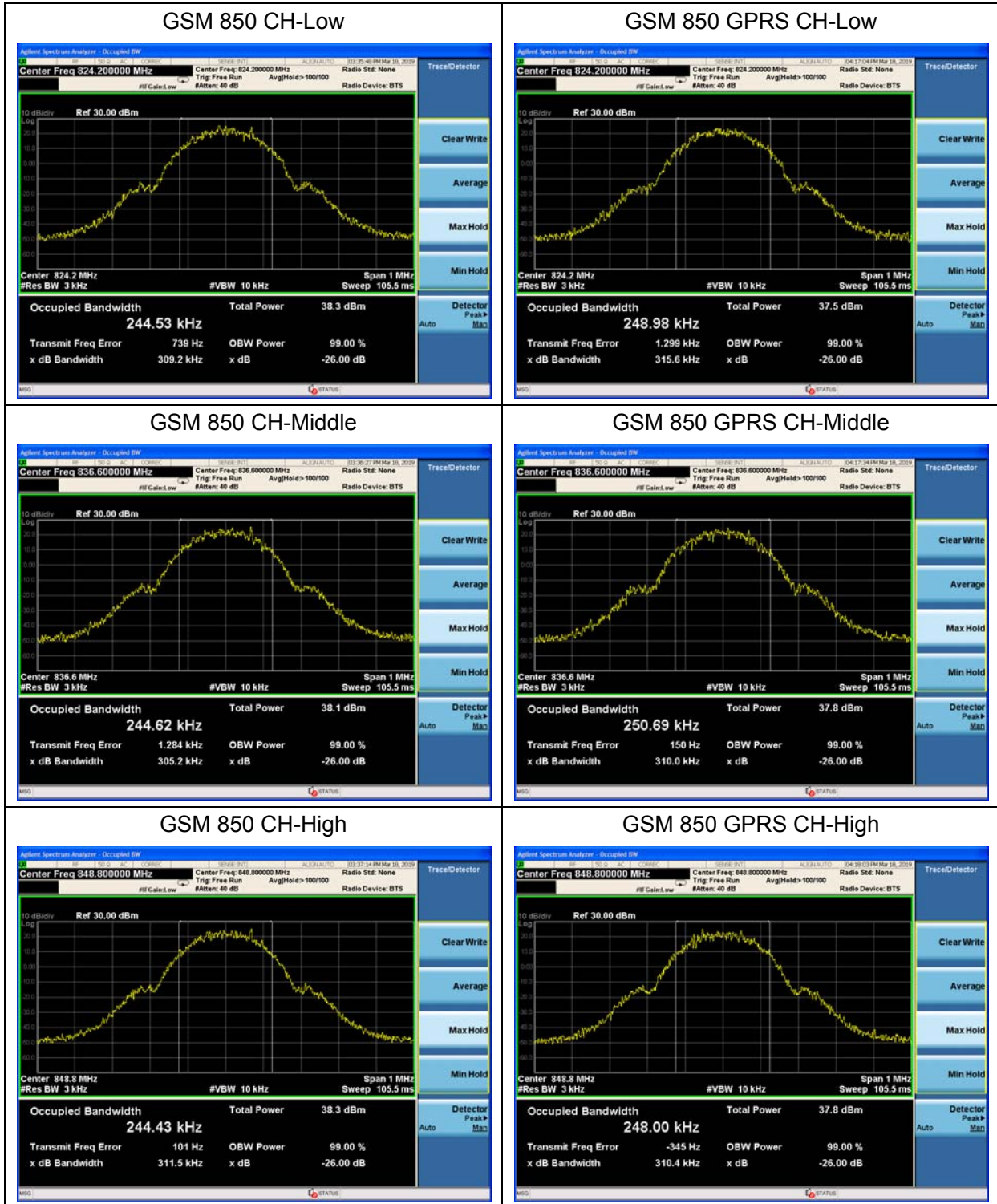

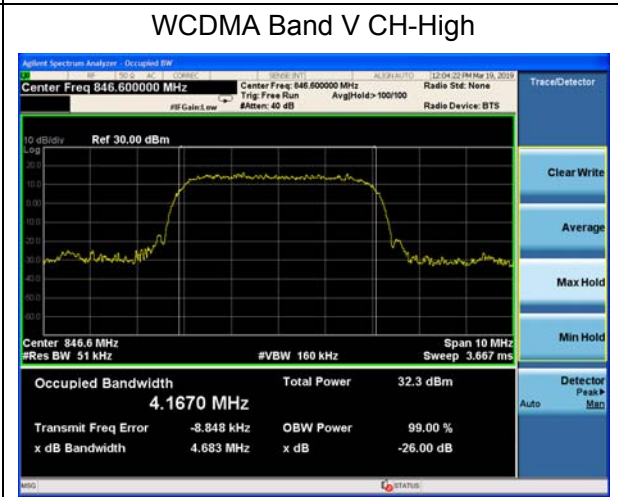
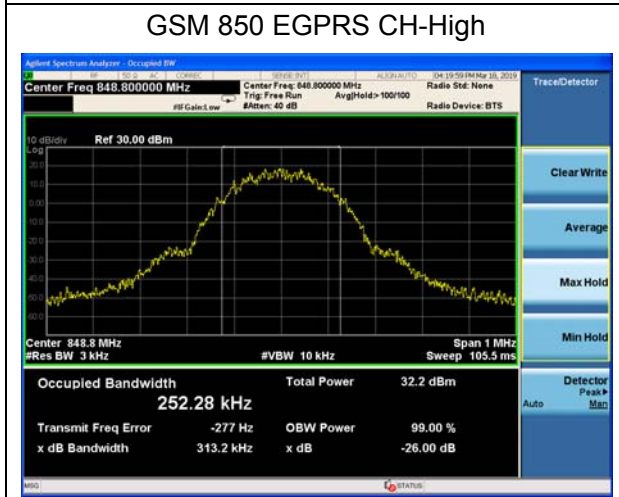
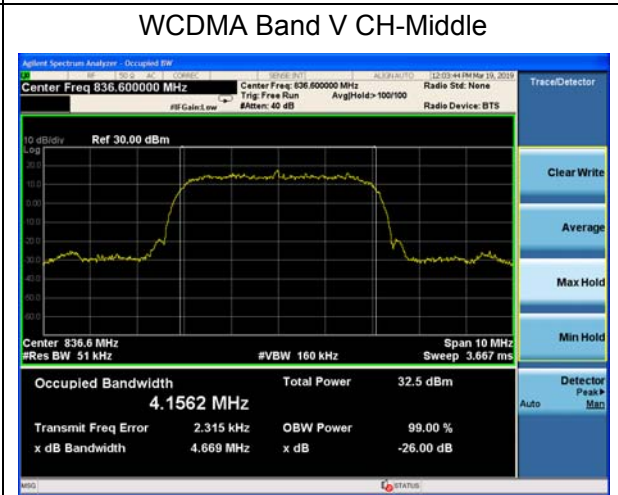
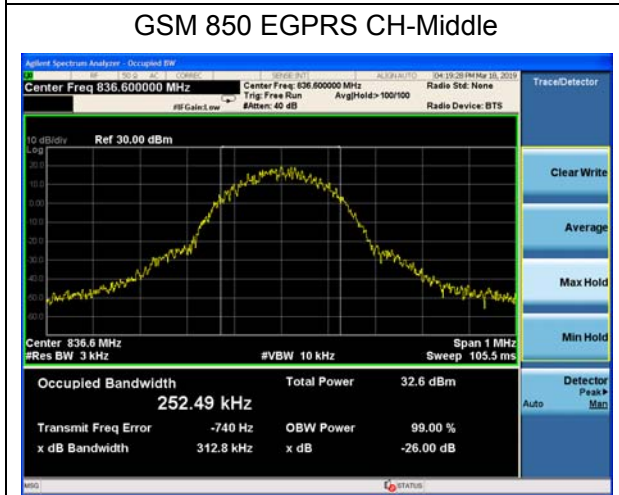
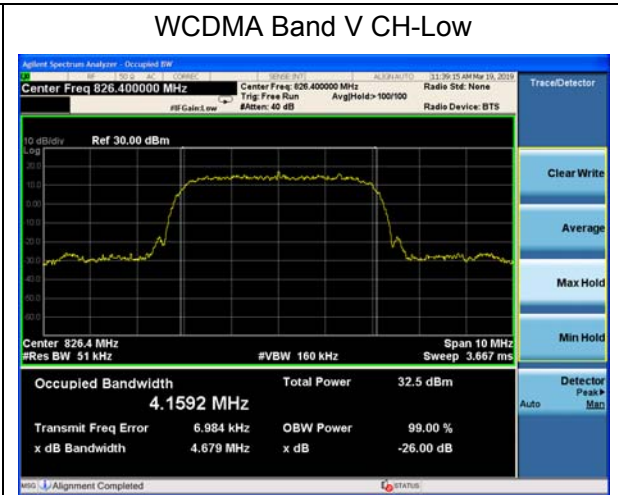
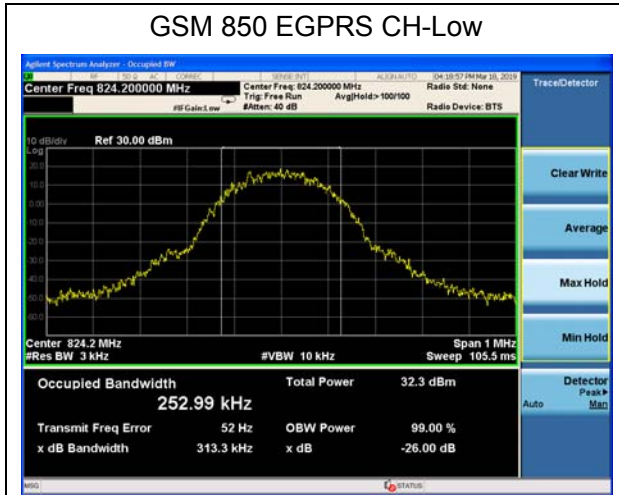

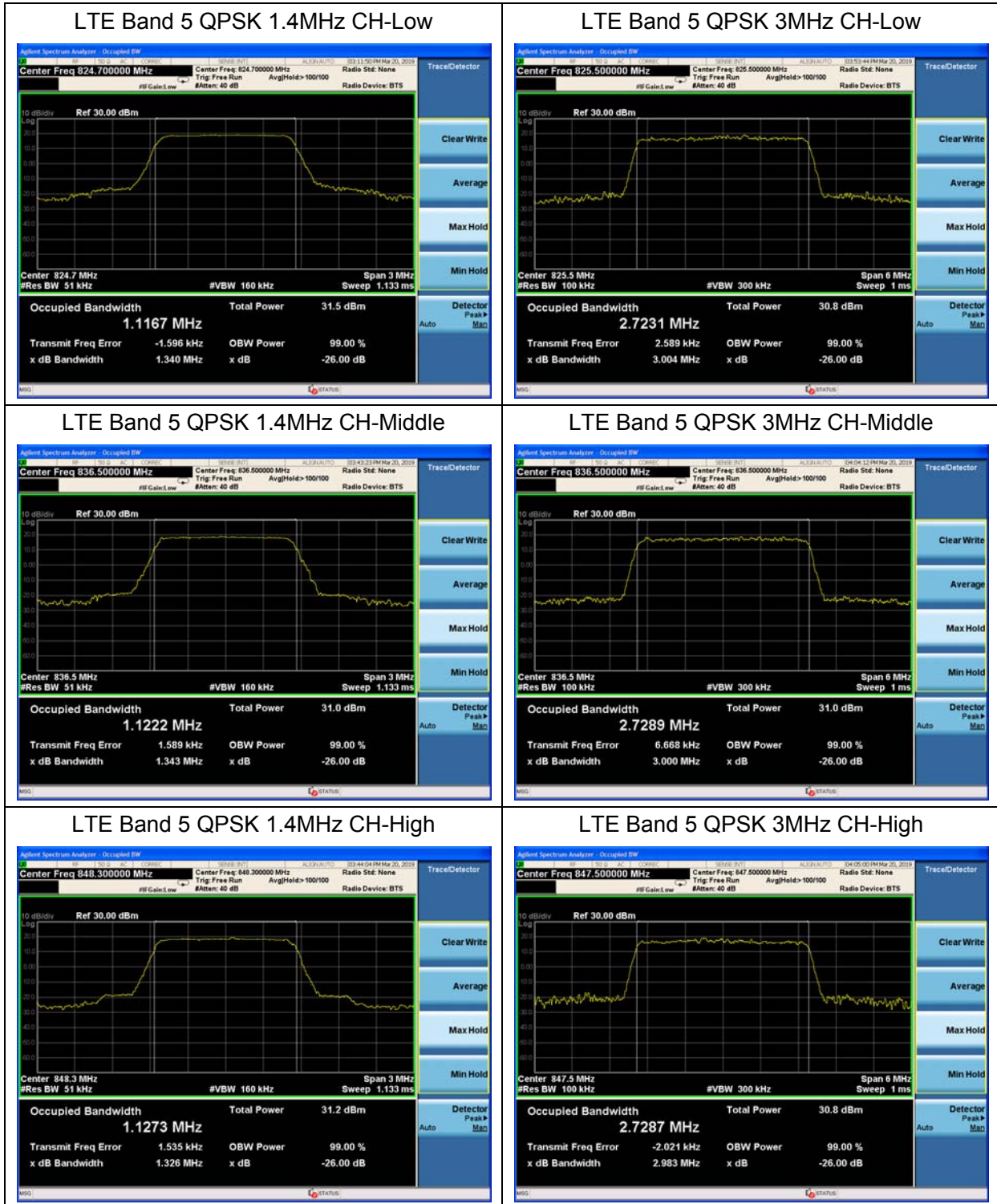



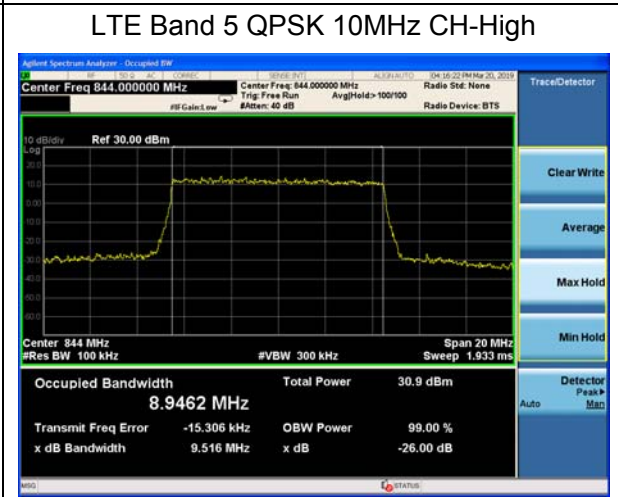
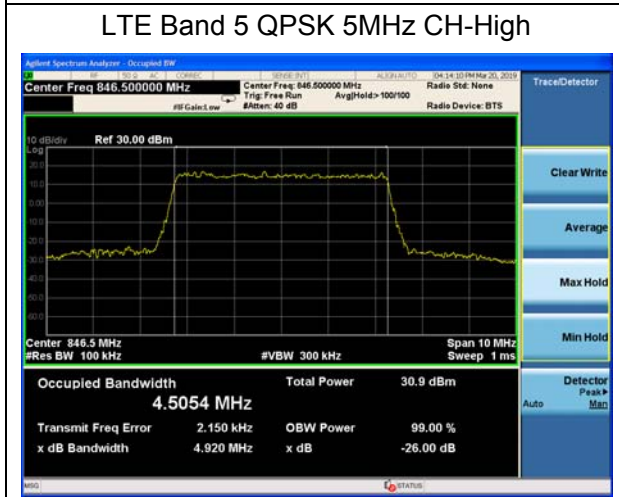
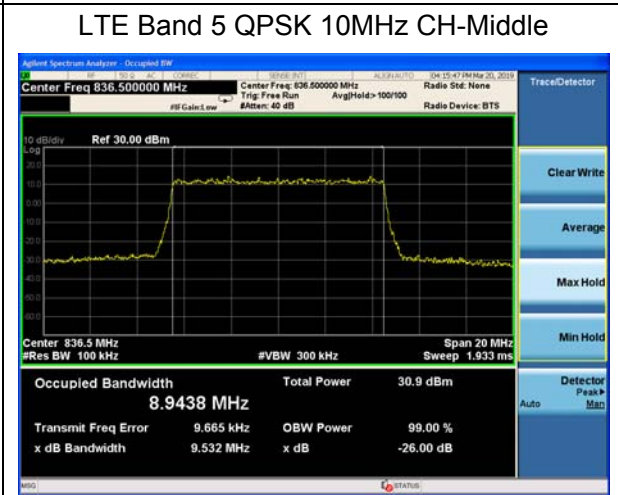
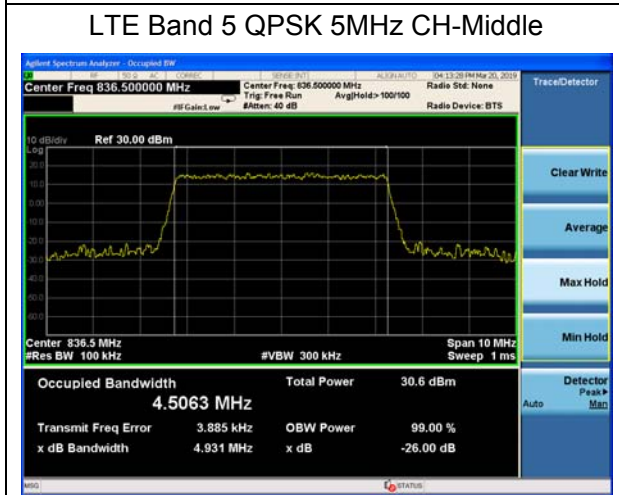
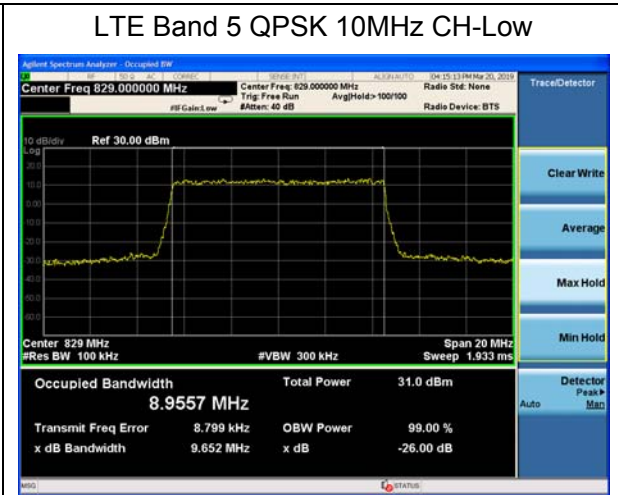
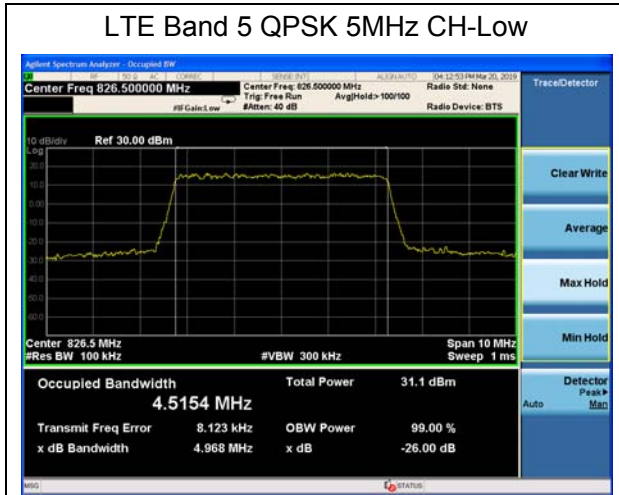

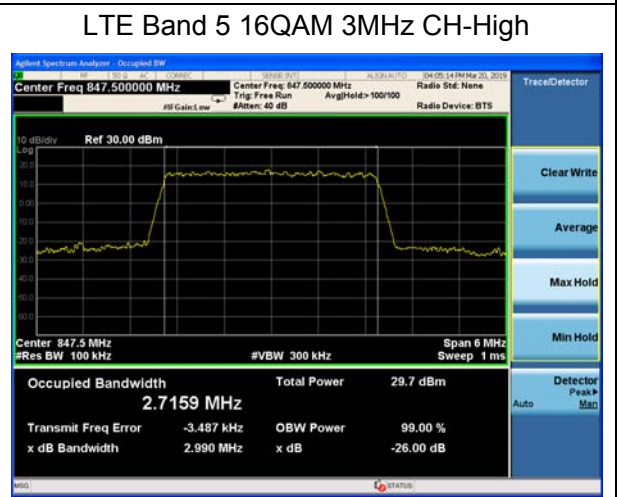
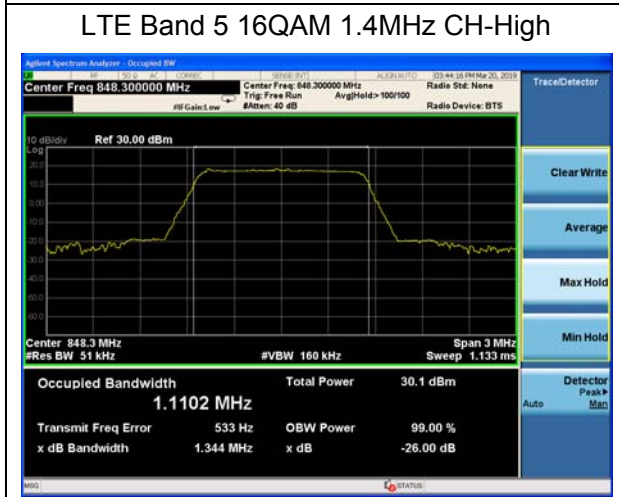
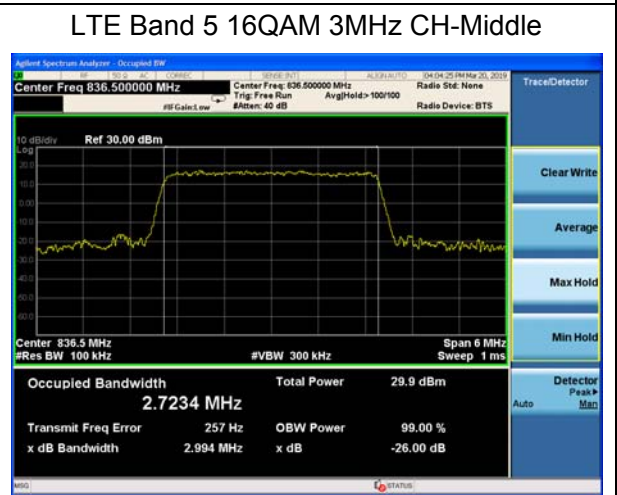
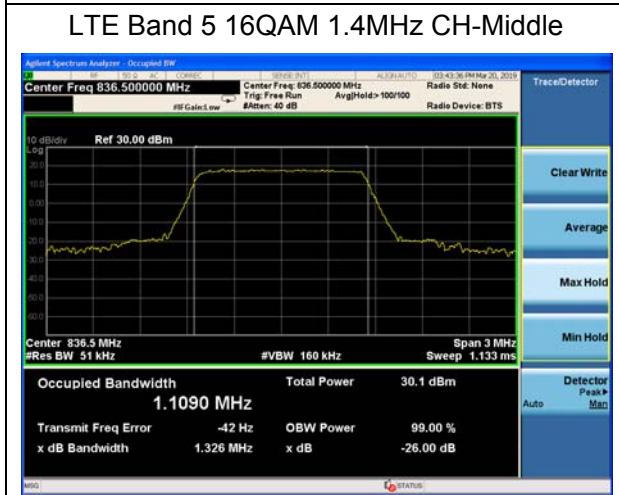
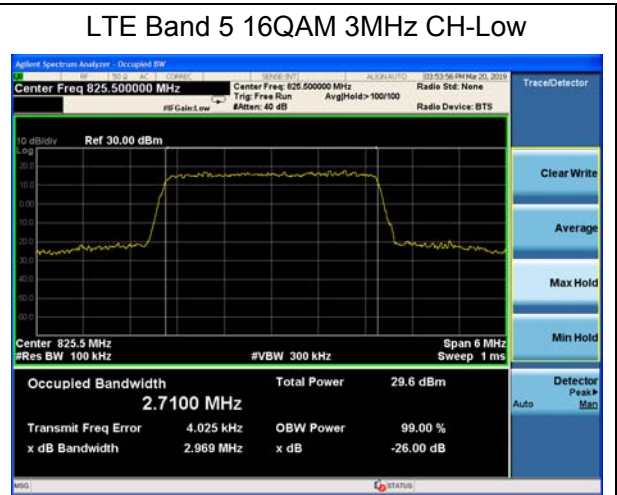
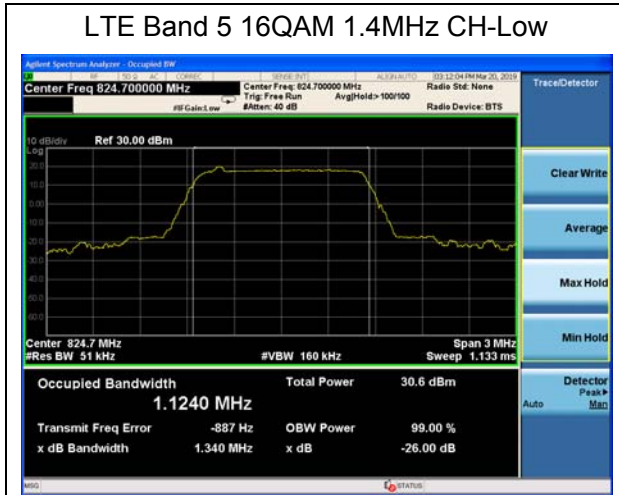

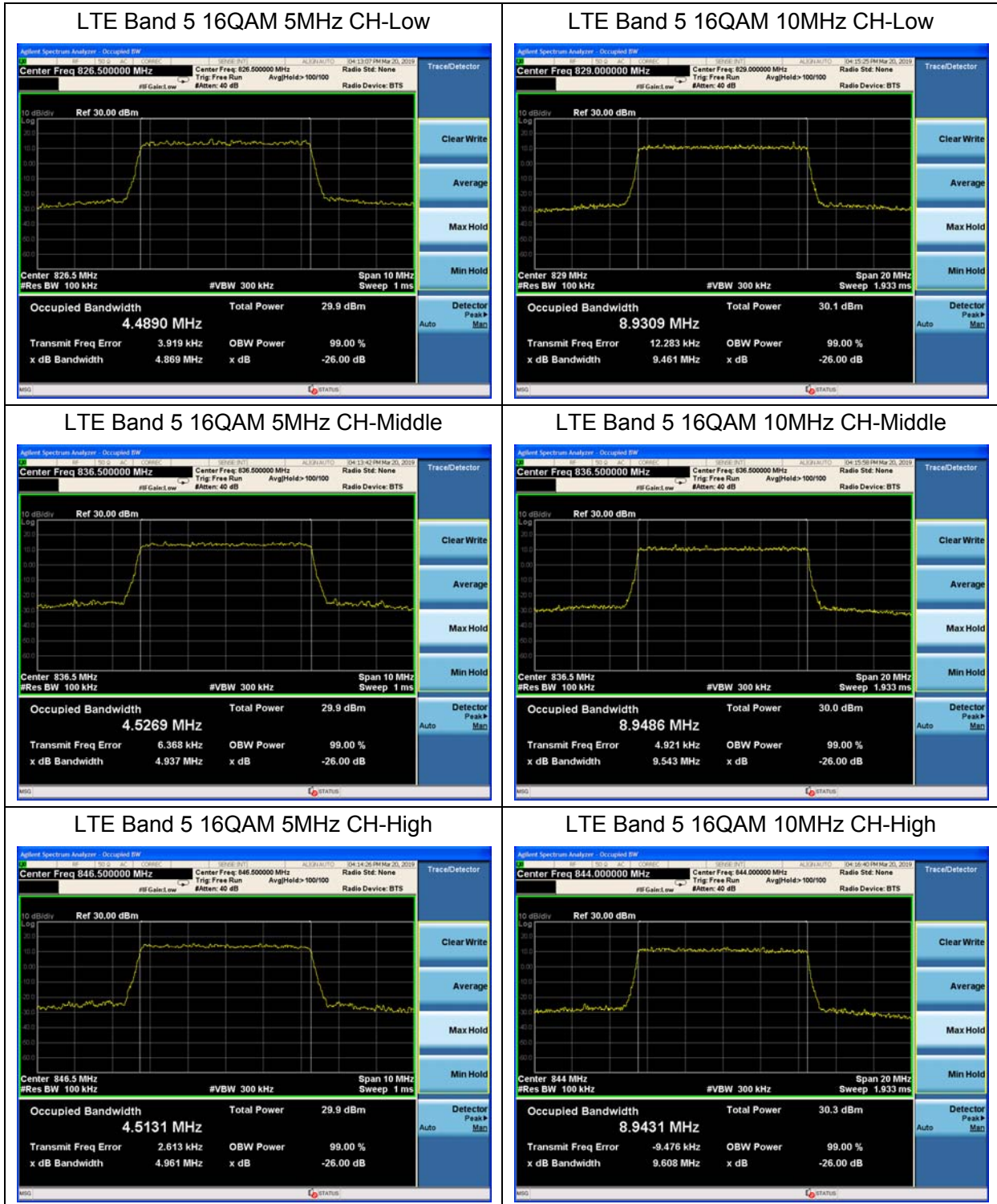

### 5.4. Band Edge Compliance

#### Ambient condition

Temperature	Relative humidity	Pressure
23°C ~25°C	45%~50%	101.5kPa

#### Method of Measurement

The EUT was connected to Spectrum Analyzer and Base Station Simulator via power Splitter. The band edge of the lowest and highest channels were measured. The average detector is used. RBW is set to 3kHz,VBW is set to 10kHz for GSM 850, RBW is set to 51kHz,VBW is set to 160kHz for WCDMA Band V, RBW is set to 15 kHz, VBW is set to 51 kHz for LTE Band 5 (1.4MHz), RBW is set to 30 kHz, VBW is set to 100 kHz for LTE Band 5 (3MHz), RBW is set to 51 kHz, VBW is set to 160 kHz for LTE Band 5 (5MHz), RBW is set to 100 kHz, VBW is set to 300 kHz for LTE Band 5 (10MHz), Spectrum analyzer plots are included on the following pages.

#### Test Setup

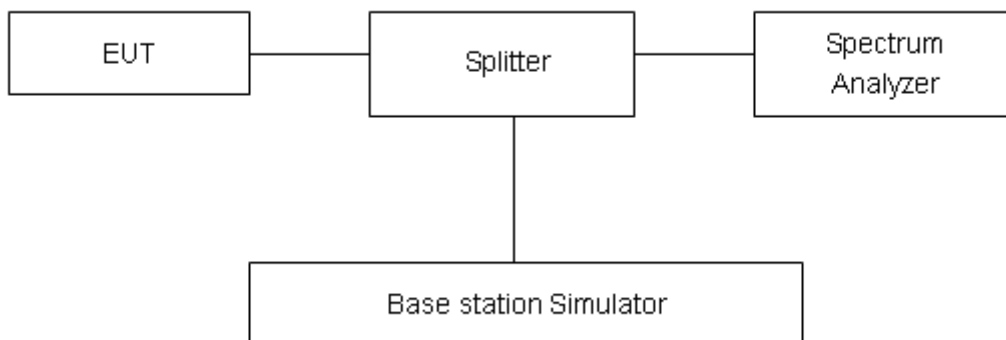

#### Limits

Rule Part 22.917(a) specifies that “The power of any emission outside of the authorized operating frequency ranges must be attenuated below the transmitting power (P) by a factor of at least 43 + 10 log(P) dB.”

Limit	-13 dBm
-------	---------

#### Measurement Uncertainty

The assessed measurement uncertainty to ensure 95% confidence level for the normal distribution is with the coverage factor  $k = 1.96$ ,  $U=0.684$ dB.



Test Result:

GSM 850 CH-Low



GSM 850 CH-High



GSM 850 GPRS CH-Low



GSM 850 GPRS CH-High



GSM 850 EGPRS CH-Low



GSM 850 EGPRS CH-High

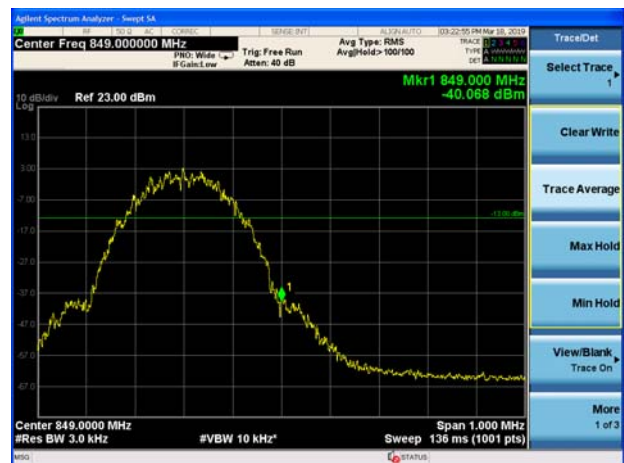



WCDMA Band V CH-Low



WCDMA Band V CH-High



LTE Band 5 QPSK 1.4MHz CH-Low 1RB

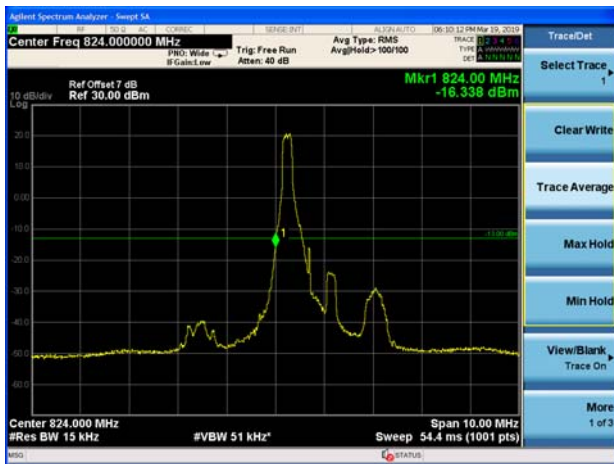

LTE Band 5 QPSK 1.4MHz CH-High 1RB

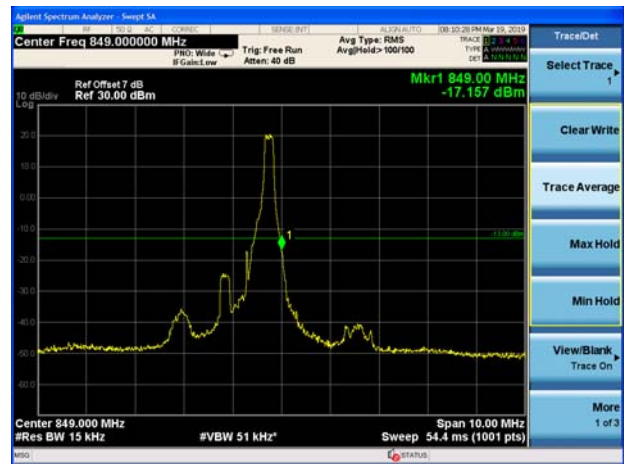

LTE Band 5 QPSK 1.4MHz CH-Low 100%RB

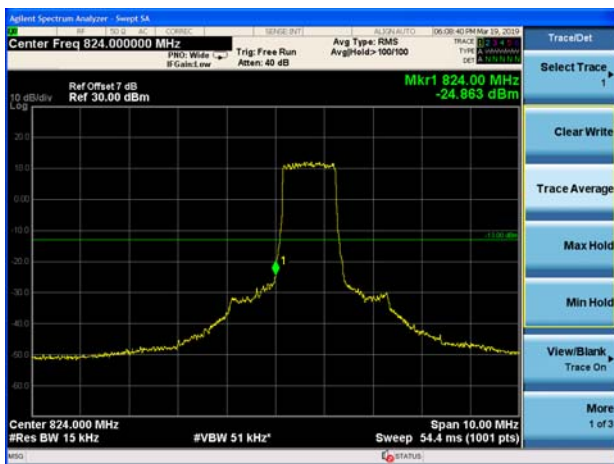

LTE Band 5 QPSK 1.4MHz CH-High 100%RB

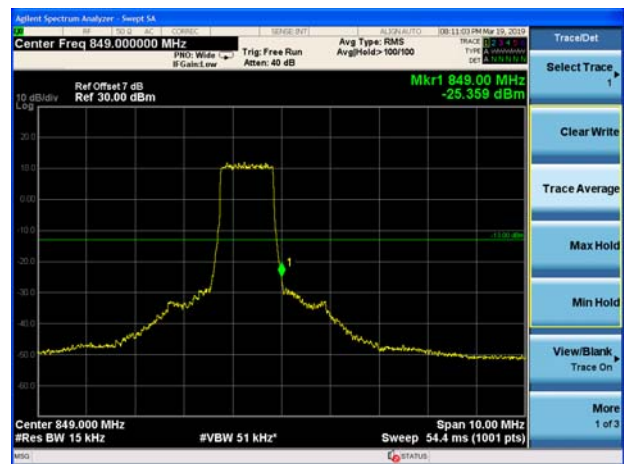

LTE Band 5 QPSK 3MHz CH-Low 1RB



LTE Band 5 QPSK 3MHz CH-High 1RB



LTE Band 5 QPSK 3MHz CH-Low 100%RB



LTE Band 5 QPSK 3MHz CH-High 100%RB

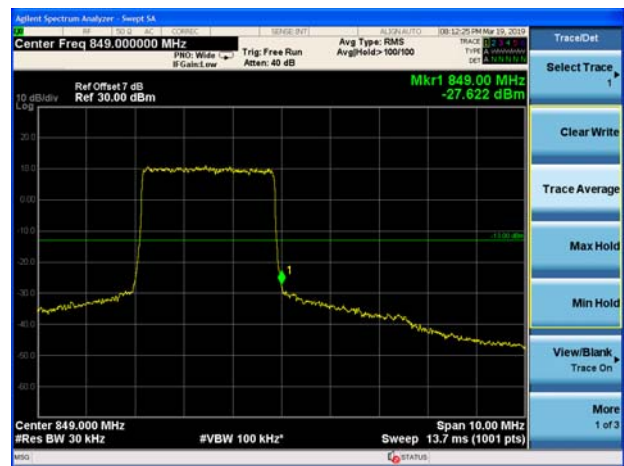

LTE Band 5 QPSK 5MHz CH-Low 1RB

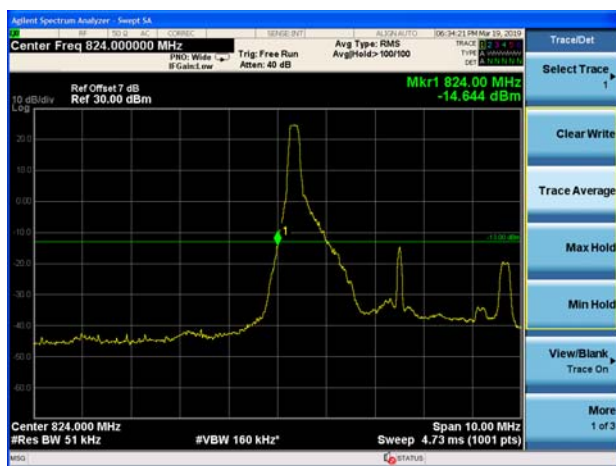

LTE Band 5 QPSK 5MHz CH-High 1RB

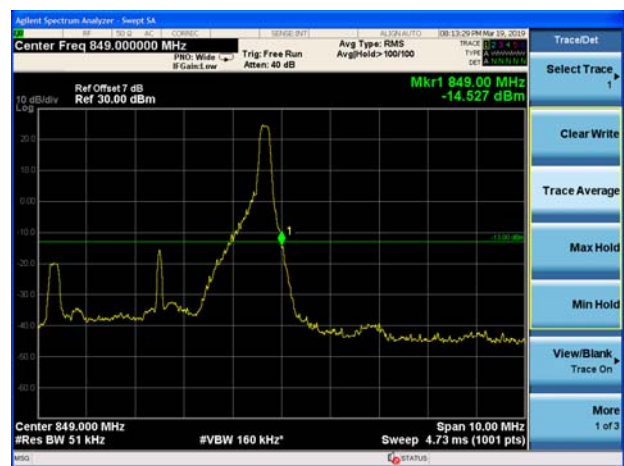

LTE Band 5 QPSK 5MHz CH-Low 100%RB



LTE Band 5 QPSK 5MHz CH-High 100%RB



LTE Band 5 QPSK 10MHz CH-Low 1RB

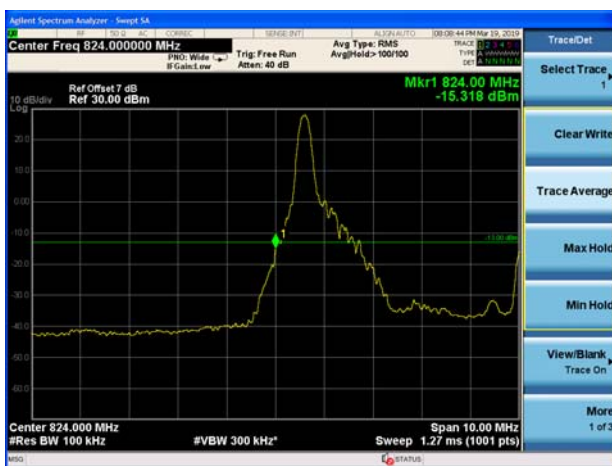

LTE Band 5 QPSK 10MHz CH-High 1RB

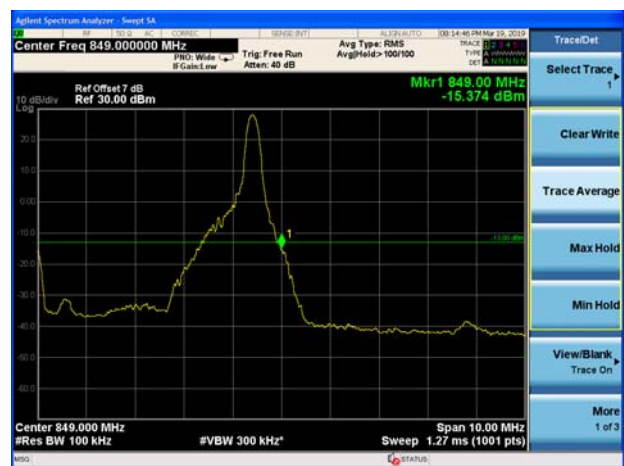

LTE Band 5 QPSK 10MHz CH-Low 100%RB

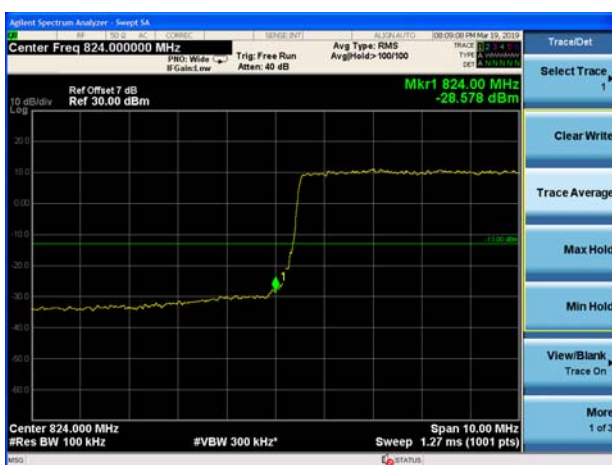

LTE Band 5 QPSK 10MHz CH-High 100%RB

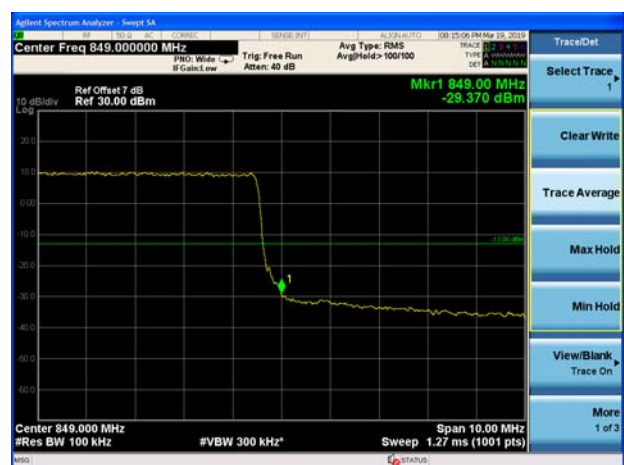





LTE Band 5 16QAM 1.4MHz CH-Low 1RB

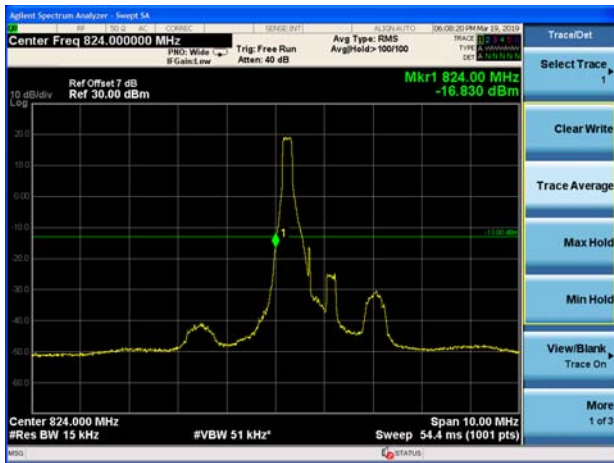

LTE Band 5 16QAM 1.4MHz CH-High 1RB

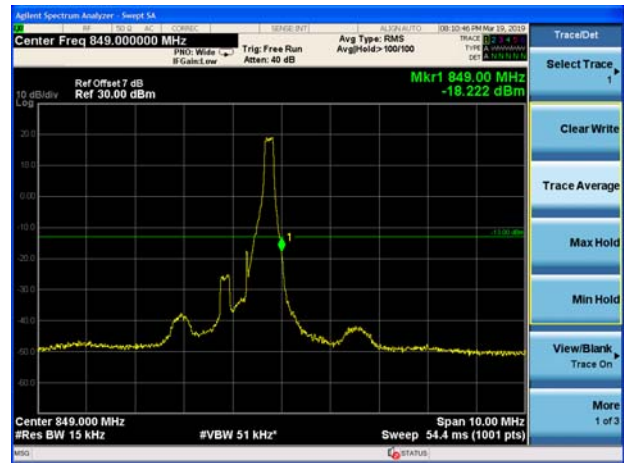

LTE Band 5 16QAM 1.4MHz CH-Low 100%RB

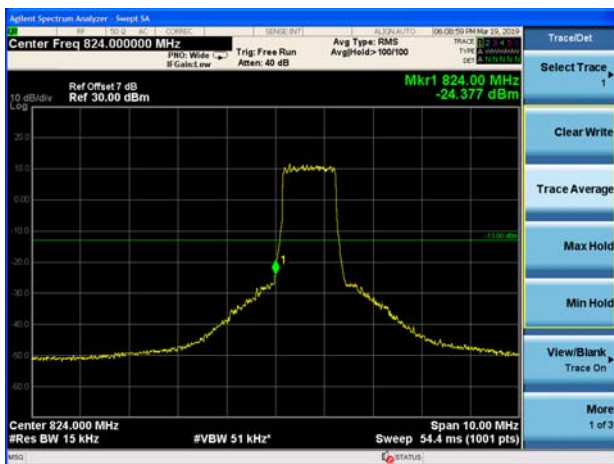

LTE Band 5 16QAM 1.4MHz CH-High 100%RB

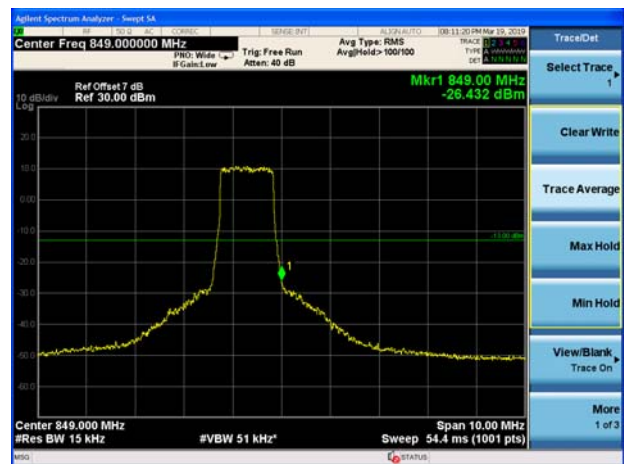

LTE Band 5 16QAM 3MHz CH-Low 1RB

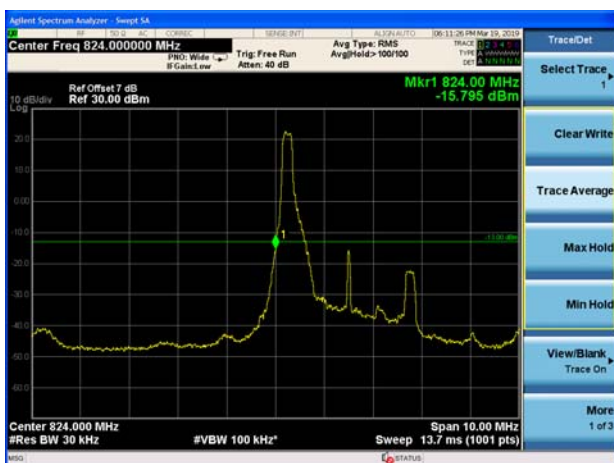

LTE Band 5 16QAM 3MHz CH-High 1RB

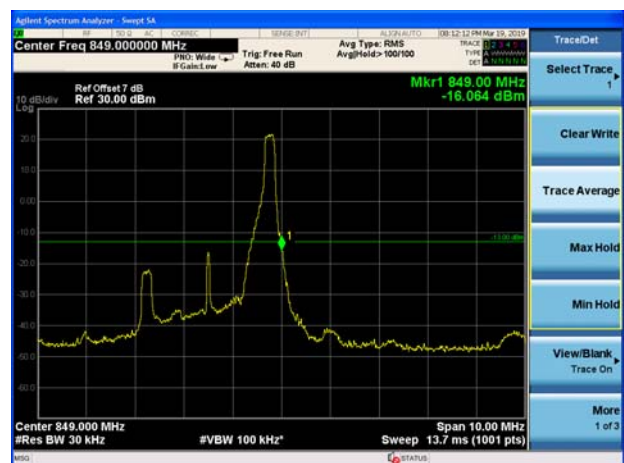

LTE Band 5 16QAM 3MHz CH-Low 100%RB

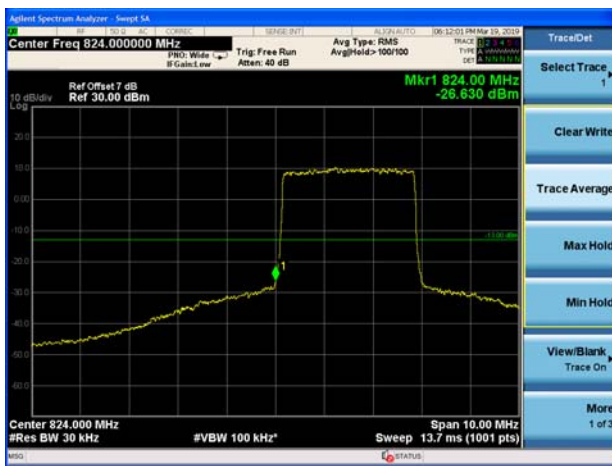

LTE Band 5 16QAM 3MHz CH-High 100%RB



LTE Band 5 16QAM 5MHz CH-Low 1RB

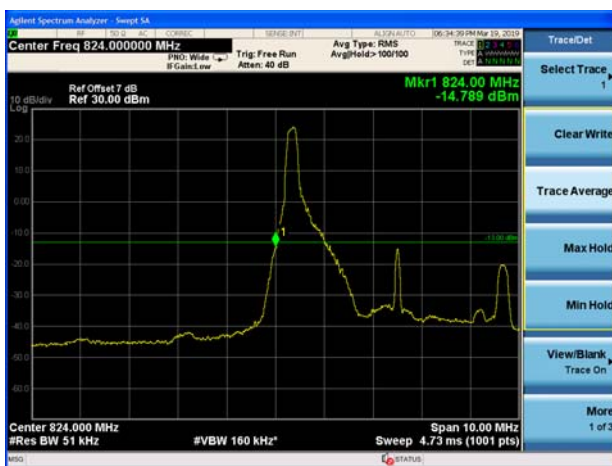

LTE Band 5 16QAM 5MHz CH-High 1RB

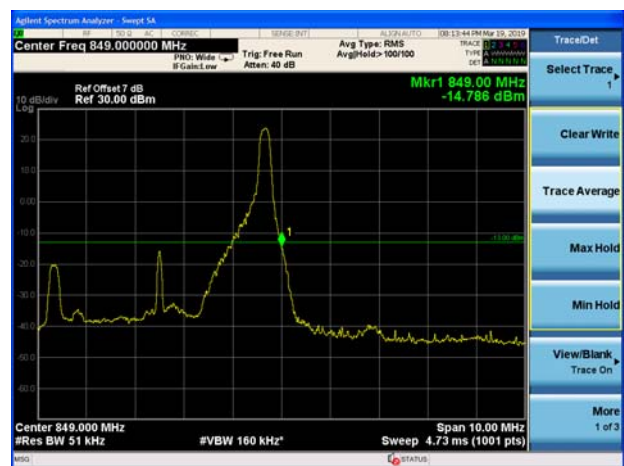

LTE Band 5 16QAM 5MHz CH-Low 100%RB



LTE Band 5 16QAM 5MHz CH-High 100%RB



LTE Band 5 16QAM 10MHz CH-Low 1RB

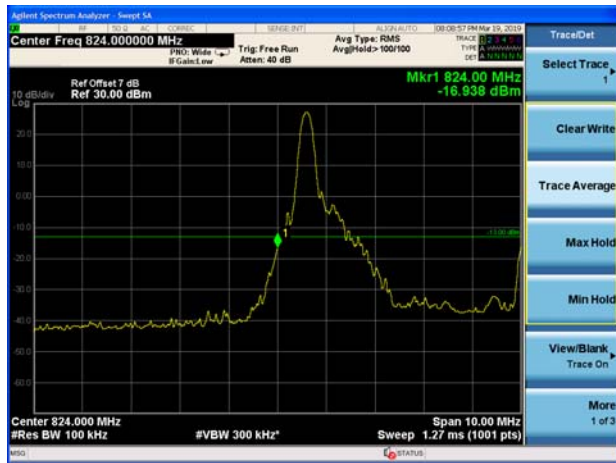

LTE Band 5 16QAM 10MHz CH-High 1RB

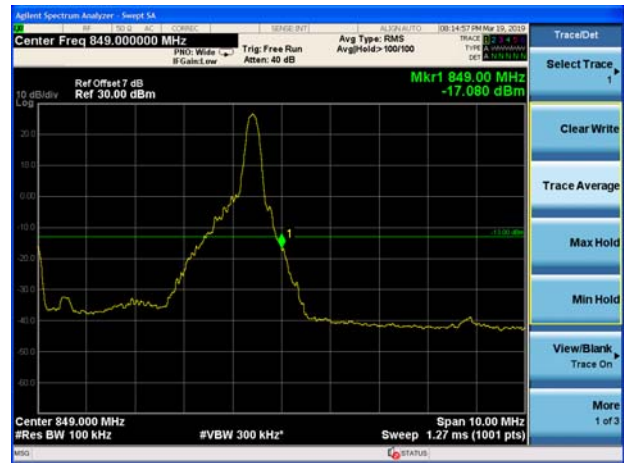

LTE Band 5 16QAM 10MHz CH-Low 100%RB

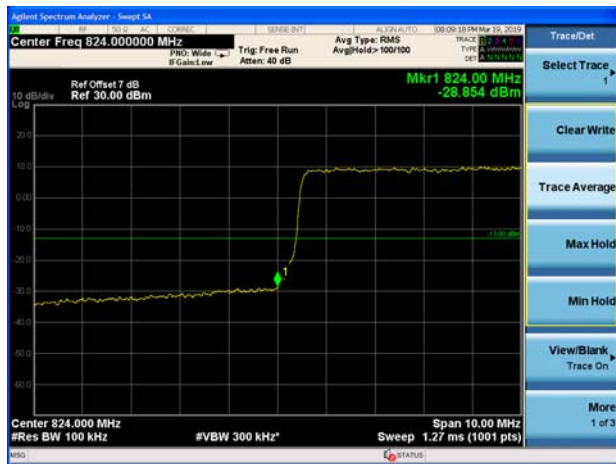

LTE Band 5 16QAM 10MHz CH-High 100%RB



### 5.5. Peak-to-Average Power Ratio (PAPR)

#### Ambient condition

Temperature	Relative humidity	Pressure
23°C ~25°C	45%~50%	101.5kPa

#### Methods of Measurement

Measure the total peak power and record as  $P_{Pk}$ . And measure the total average power and record as  $P_{Avg}$ . Both the peak and average power levels must be expressed in the same logarithmic units (e.g., dBm). Determine the PAPR from:

$$PAPR (dB) = P_{Pk} (dBm) - P_{Avg} (dBm).$$

#### Test Setup

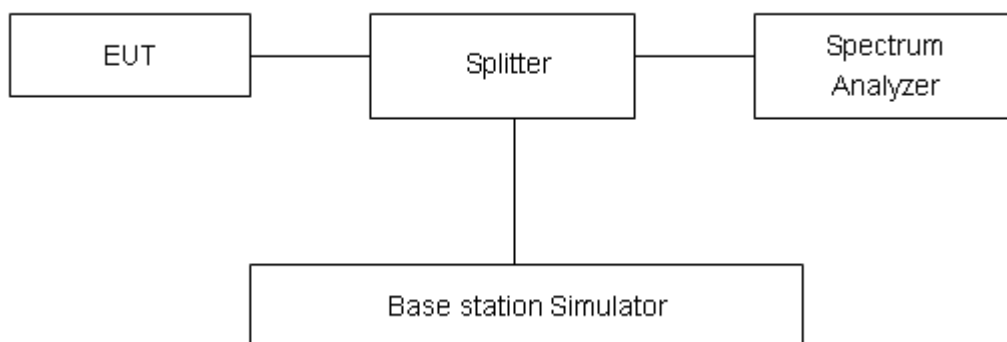

#### Limits

According to the Sec. 22.913(d), The peak-to-average ratio (PAR) of the transmission must not exceed 13 dB.

#### Measurement Uncertainty

The assessed measurement uncertainty to ensure 95% confidence level for the normal distribution is with the coverage factor  $k = 2$ ,  $U = 0.4$  dB.

**Test Results**

Mode	Channel	Frequency (MHz)	Peak (dBm)	Avg (dBm)	PAPR (dB)	Limit (dB)	Conclusion
<b>GSM 850 (GSM)</b>	128	824.2	33.21	32.26	0.95	≤13	PASS
	190	836.6	33.19	32.20	0.99	≤13	PASS
	251	848.8	33.18	32.18	1.00	≤13	PASS
<b>GPRS 850 (GMSK)</b>	128	824.2	29.57	28.59	0.98	≤13	PASS
	190	836.6	29.40	28.39	1.01	≤13	PASS
	251	848.8	30.21	29.24	0.97	≤13	PASS
<b>EGPRS 850 (8-PSK)</b>	128	824.2	24.32	23.34	0.98	≤13	PASS
	190	836.6	24.33	23.39	0.94	≤13	PASS
	251	848.8	24.58	23.53	1.05	≤13	PASS
<b>WCDMA Band V (RMC)</b>	4132	826.4	26.43	23.50	2.93	≤13	PASS
	4183	836.6	26.38	23.47	2.91	≤13	PASS
	4233	846.6	26.37	23.39	2.98	≤13	PASS

LTE Band 5								
Modulation	Bandwidth (MHz)	Channel	Frequency (MHz)	Peak (dBm)	Avg (dBm)	PAPR (dB)	Limit (dB)	Conclusion
QPSK	1.4	20407	824.7	27.77	22.27	5.50	≤13	PASS
		20525	836.5	27.52	22.13	5.39	≤13	PASS
		20643	848.3	27.42	22.01	5.41	≤13	PASS
	3	20415	825.5	27.63	22.06	5.57	≤13	PASS
		20525	836.5	27.44	21.96	5.48	≤13	PASS
		20635	847.5	27.48	21.99	5.49	≤13	PASS
	5	20425	826.5	27.70	22.08	5.62	≤13	PASS
		20525	836.5	27.63	22.04	5.59	≤13	PASS
		20625	846.5	27.61	22.10	5.51	≤13	PASS
	10	20450	829	27.71	22.12	5.59	≤13	PASS
		20525	836.5	27.68	22.15	5.53	≤13	PASS
		20600	844	27.63	22.18	5.45	≤13	PASS
16QAM	1.4	20407	824.7	27.56	21.31	6.25	≤13	PASS
		20525	836.5	27.43	21.20	6.23	≤13	PASS
		20643	848.3	27.21	21.02	6.19	≤13	PASS
	3	20415	825.5	27.48	21.09	6.39	≤13	PASS
		20525	836.5	27.30	20.99	6.31	≤13	PASS
		20635	847.5	27.35	21.04	6.31	≤13	PASS
	5	20425	826.5	27.43	21.12	6.31	≤13	PASS
		20525	836.5	27.41	21.08	6.33	≤13	PASS
		20625	846.5	27.41	21.14	6.27	≤13	PASS
	10	20450	829	27.49	21.15	6.34	≤13	PASS
		20525	836.5	27.53	21.20	6.33	≤13	PASS
		20600	844	27.46	21.21	6.25	≤13	PASS

## 5.6. Frequency Stability

### Ambient condition

Temperature	Relative humidity	Pressure
23°C ~25°C	45%~50%	101.5kPa

### Method of Measurement

#### Frequency Stability (Temperature Variation)

The temperature inside the climate chamber is varied from -30°C to +55°C in 10°C step size,

(1) With all power removed, the temperature was decreased to 0°C and permitted to stabilize for three hours.

(2) Measure the carrier frequency with the test equipment in a “call mode”. These measurements should be made within 1 minute of powering up the mobile station, to prevent significant self warming.

(3) Repeat the above measurements at 10°C increments from -30°C to +55°. Allow at least 1.5 hours at each temperature, un-powered, before making measurements.

#### Frequency Stability (Voltage Variation)

The frequency stability shall be measured with variation of primary supply voltage as follows:

(1) Vary primary supply voltage from 85 to 115 percent of the nominal value for other than hand carried battery equipment.

(2) For hand carried, battery powered equipment, reduce primary supply voltage to the battery-operating end point which shall be specified by the manufacturer.

This transceiver is specified to operate with an input voltage of between 3.6 V and 4.4 V, with a nominal voltage of 3.82V.

### Test setup

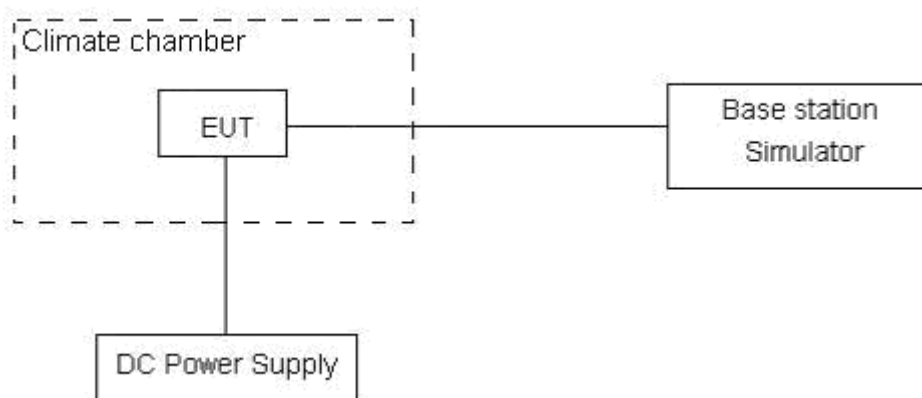

**Limits**

According to the Sec. 22.355, the frequency stability of the carrier shall be accurate to within 2.5 ppm of the received frequency for mobile stations.

Limits	$\leq 2.5$ ppm
--------	----------------

**Measurement Uncertainty**

The assessed measurement uncertainty to ensure 99.75% confidence level for the normal distribution is with the coverage factor  $k = 3$ ,  $U = 0.01$  ppm.





## Test Result

GSM850						
Condition		Freq.Error (Hz)	Freq.Error (Hz)	Frequency Stability (ppm)	Frequency Stability (ppm)	Verdict
Temperature	Voltage					
Normal (25°C)	Normal	2.61	4.79	0.00139	0.00255	PASS
Extreme (55°C)		7.80	13.53	0.00415	0.00720	PASS
Extreme (50°C)		15.27	10.23	0.00812	0.00544	PASS
Extreme (40°C)		10.82	2.81	0.00575	0.00149	PASS
Extreme (30°C)		16.55	16.22	0.00880	0.00863	PASS
Extreme (20°C)		13.67	15.32	0.00727	0.00815	PASS
Extreme (10°C)		11.11	15.47	0.00591	0.00823	PASS
Extreme (0°C)		6.05	7.29	0.00322	0.00388	PASS
Extreme (-10°C)		10.50	2.21	0.00558	0.00117	PASS
Extreme (-20°C)		1.61	6.11	0.00086	0.00325	PASS
Extreme (-30°C)		4.26	15.10	0.00226	0.00803	PASS
25°C		LV	15.63	12.66	0.00832	0.00673
	HV	3.01	13.72	0.00160	0.00730	PASS

WCDMA Band 5						
Condition		Freq.Error (Hz)	Freq.Error (Hz)	Frequency Stability (ppm)	Frequency Stability (ppm)	Verdict
Temperature	Voltage					
Normal (25°C)	Normal	12.00	2.00	0.00638	0.00106	PASS
Extreme (55°C)		7.00	6.00	0.00372	0.00319	PASS
Extreme (50°C)		15.00	2.00	0.00798	0.00106	PASS
Extreme (40°C)		13.00	13.00	0.00691	0.00691	PASS
Extreme (30°C)		5.00	7.00	0.00266	0.00372	PASS
Extreme (20°C)		9.00	16.00	0.00479	0.00851	PASS
Extreme (10°C)		17.00	16.00	0.00904	0.00851	PASS
Extreme (0°C)		7.00	16.00	0.00372	0.00851	PASS
Extreme (-10°C)		1.00	1.00	0.00053	0.00053	PASS
Extreme (-20°C)		7.50	15.61	0.00399	0.00830	PASS
Extreme (-30°C)		6.76	9.99	0.00360	0.00531	PASS
25°C		LV	1.00	8.00	0.00053	0.00426
	HV	10.00	12.00	0.00532	0.00638	PASS

LTE Band 5, BANDWIDTH 1.4MHz						
Condition		Freq.Error (Hz)	Freq.Error (Hz)	Frequency Stability (ppm)	Frequency Stability (ppm)	Verdict
Temperature	Voltage	16QAM	QPSK	16QAM	QPSK	
Normal (25°C)	Normal	10.00	13.33	0.00532	0.00709	PASS
Extreme (55°C)		10.98	2.46	0.00584	0.00131	PASS
Extreme (50°C)		11.50	15.88	0.00612	0.00845	PASS
Extreme (40°C)		10.50	5.07	0.00559	0.00269	PASS
Extreme (30°C)		2.75	7.25	0.00146	0.00386	PASS
Extreme (20°C)		2.39	9.08	0.00127	0.00483	PASS
Extreme (10°C)		3.25	10.38	0.00173	0.00552	PASS
Extreme (0°C)		15.42	2.75	0.00820	0.00146	PASS
Extreme (-10°C)		12.56	11.43	0.00668	0.00608	PASS
Extreme (-20°C)		7.92	7.63	0.00421	0.00406	PASS
Extreme (-30°C)		7.91	3.38	0.00421	0.00180	PASS
25°C	LV	5.26	17.85	0.00280	0.00949	PASS
	HV	7.84	14.28	0.00417	0.00760	PASS

LTE Band 5, BANDWIDTH 3MHz						
Condition		Freq.Error (Hz)	Freq.Error (Hz)	Frequency Stability (ppm)	Frequency Stability (ppm)	Verdict
Temperature	Voltage	16QAM	QPSK	16QAM	QPSK	
Normal (25°C)	Normal	1.31	12.51	0.00070	0.00666	PASS
Extreme (55°C)		14.32	13.78	0.00762	0.00733	PASS
Extreme (50°C)		15.60	1.70	0.00830	0.00090	PASS
Extreme (40°C)		3.78	7.86	0.00201	0.00418	PASS
Extreme (30°C)		11.86	5.15	0.00631	0.00274	PASS
Extreme (20°C)		3.19	14.71	0.00170	0.00782	PASS
Extreme (10°C)		16.52	4.52	0.00879	0.00240	PASS
Extreme (0°C)		8.80	5.78	0.00468	0.00308	PASS
Extreme (-10°C)		9.93	6.87	0.00528	0.00365	PASS
Extreme (-20°C)		1.02	14.75	0.00054	0.00785	PASS
Extreme (-30°C)		16.92	7.71	0.00900	0.00410	PASS
25°C	LV	16.24	12.71	0.00864	0.00676	PASS
	HV	10.93	11.67	0.00581	0.00621	PASS

LTE Band 5, BANDWIDTH 5MHz						
Condition		Freq.Error (Hz)	Freq.Error (Hz)	Frequency Stability (ppm)	Frequency Stability (ppm)	Verdict
Temperature	Voltage	16QAM	QPSK	16QAM	QPSK	
Normal (25°C)	Normal	8.46	14.47	0.00450	0.00770	PASS
Extreme (55°C)		1.10	11.81	0.00059	0.00628	PASS
Extreme (50°C)		6.42	14.24	0.00341	0.00758	PASS
Extreme (40°C)		17.00	12.17	0.00905	0.00647	PASS
Extreme (30°C)		16.60	8.26	0.00883	0.00440	PASS
Extreme (20°C)		13.58	5.94	0.00722	0.00316	PASS
Extreme (10°C)		15.11	5.41	0.00803	0.00288	PASS
Extreme (0°C)		9.51	9.71	0.00506	0.00517	PASS
Extreme (-10°C)		2.09	10.76	0.00111	0.00572	PASS
Extreme (-20°C)		15.52	2.93	0.00826	0.00156	PASS
Extreme (-30°C)		3.12	5.52	0.00166	0.00294	PASS
25°C		LV	16.53	12.20	0.00879	0.00649
	HV	17.75	6.32	0.00944	0.00336	PASS

LTE Band 5, BANDWIDTH 10MHz						
Condition		Freq.Error (Hz)	Freq.Error (Hz)	Frequency Stability (ppm)	Frequency Stability (ppm)	Verdict
Temperature	Voltage	16QAM	QPSK	16QAM	QPSK	
Normal (25°C)	Normal	5.04	8.07	0.00268	0.00429	PASS
Extreme (55°C)		13.69	8.50	0.00728	0.00452	PASS
Extreme (50°C)		4.54	4.63	0.00242	0.00246	PASS
Extreme (40°C)		16.07	9.54	0.00855	0.00508	PASS
Extreme (30°C)		2.66	17.64	0.00141	0.00938	PASS
Extreme (20°C)		3.17	4.31	0.00169	0.00229	PASS
Extreme (10°C)		13.29	5.26	0.00707	0.00280	PASS
Extreme (0°C)		1.49	3.10	0.00079	0.00165	PASS
Extreme (-10°C)		12.74	10.49	0.00678	0.00558	PASS
Extreme (-20°C)		7.28	4.41	0.00387	0.00235	PASS
Extreme (-30°C)		14.13	1.02	0.00752	0.00054	PASS
25°C		LV	17.76	3.56	0.00945	0.00189
	HV	9.60	12.76	0.00511	0.00679	PASS

## 5.7. Spurious Emissions at Antenna Terminals

### Ambient condition

Temperature	Relative humidity	Pressure
23°C ~25°C	45%~50%	101.5kPa

### Method of Measurement

The EUT was connected to Spectrum Analyzer and Base Station Simulator via power Splitter. The measurement is carried out using a spectrum analyzer. The spectrum analyzer scans from 9kHz to the 10th harmonic of the carrier.

The peak detector is used. RBW are set to 100 kHz and VBW are set to 300 kHz for below 1G, RBW are set to 1MHz and VBW are set to 3MHz for above 1G, Sweep is set to ATUO.

The modulation mode and RB allocation refer to section 5.1, using the maximum output power configuration.

### Test setup

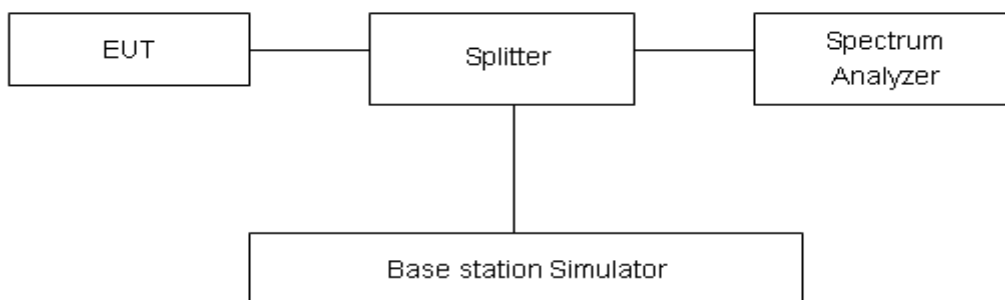

### Limits

Rule Part 22.917(a) specifies that “The power of any emission outside of the authorized operating frequency ranges must be attenuated below the transmitting power (P) by a factor of at least 43 + 10 log (P) dB.”

Limit	-13 dBm
-------	---------

### Measurement Uncertainty

The assessed measurement uncertainty to ensure 99.75% confidence level for the normal distribution is with the coverage factor  $k = 1.96$ .

Frequency	Uncertainty
9kHz-1GHz	0.684 dB
1GHz-18GHz	1.407 dB



### Test Result

Sweep the whole frequency band through the range from 9kHz to the 10th harmonic of the carrier, the emissions more than 20 dB below the limit are not reported.

The signal beyond the limit is carrier.

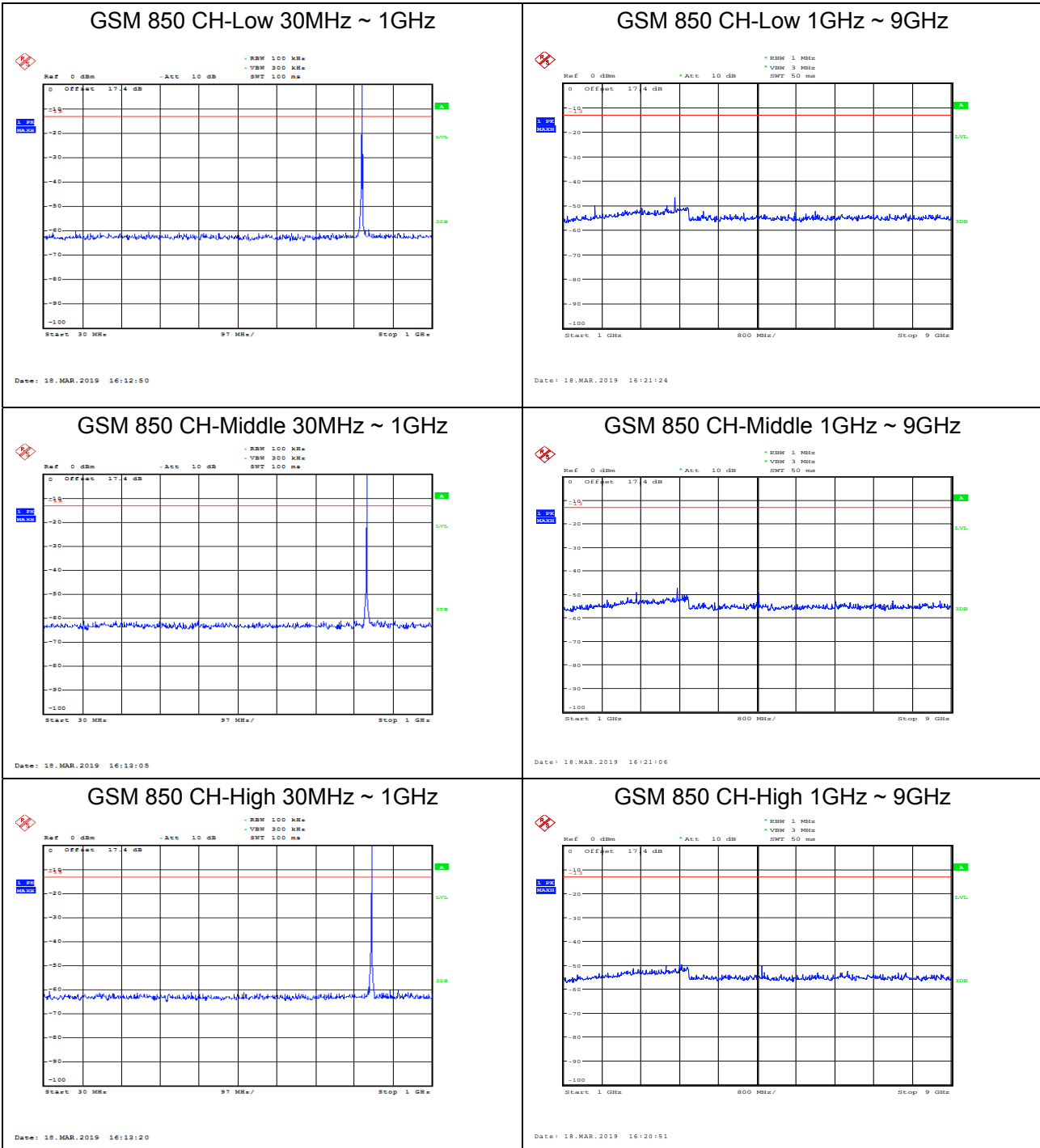



### WCDMA Band V CH-Low 30MHz ~ 1GHz

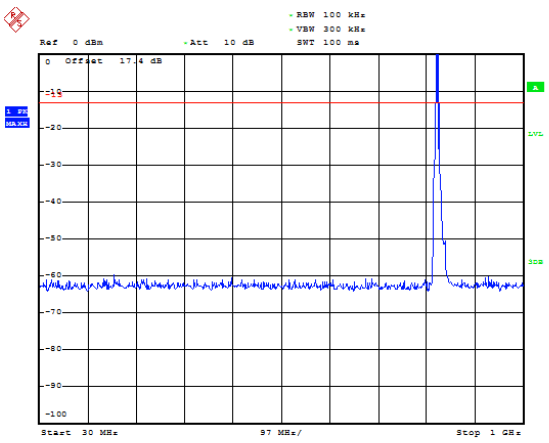

Date: 19\_MAR.2019 12:08:54

### WCDMA Band V CH-Low 1GHz ~ 9GHz

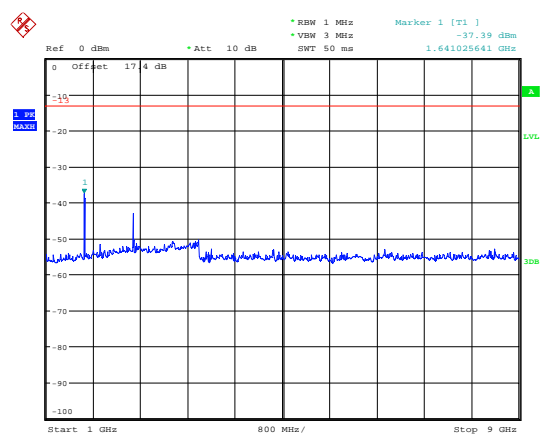

Date: 19\_MAR.2019 13:48:48

### WCDMA Band V CH-Middle 30MHz ~ 1GHz

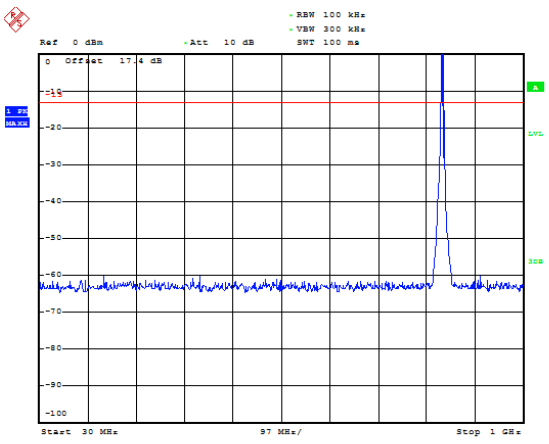

Date: 19\_MAR.2019 12:09:15

### WCDMA Band V CH-Middle 1GHz ~ 9GHz

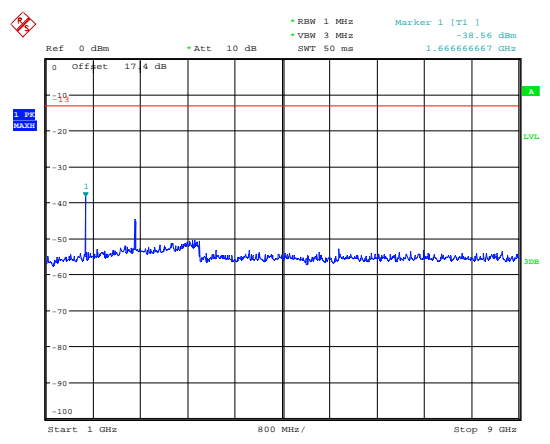

Date: 19\_MAR.2019 13:49:17

### WCDMA Band V CH-High 30MHz ~ 1GHz

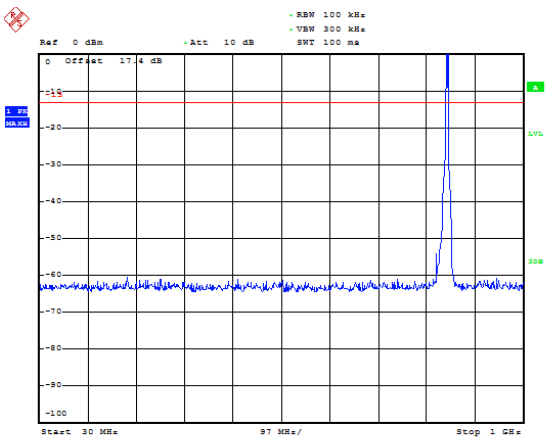

Date: 19\_MAR.2019 12:09:41

### WCDMA Band V CH-High 1GHz ~ 9GHz

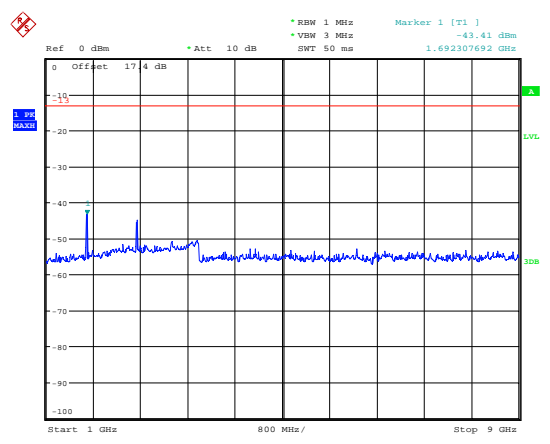

Date: 19\_MAR.2019 13:49:39



### LTE Band 5 1.4MHz CH-Low 30MHz~1GHz

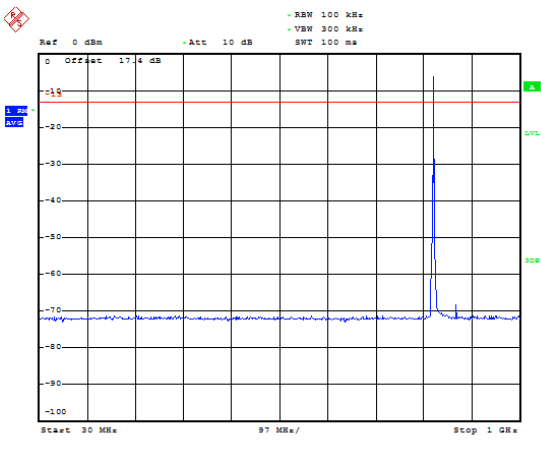

Date: 24.MAR.2019 15:25:31

### LTE Band 5 1.4MHz CH-Low 1GHz~9GHz

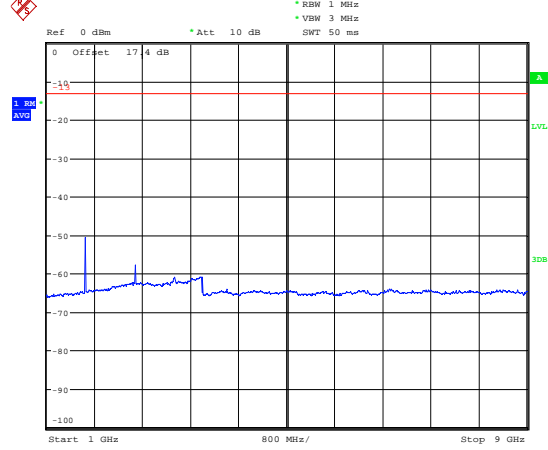

Date: 24.MAR.2019 15:31:49

### LTE Band 5 1.4MHz CH-Middle 30MHz~1GHz

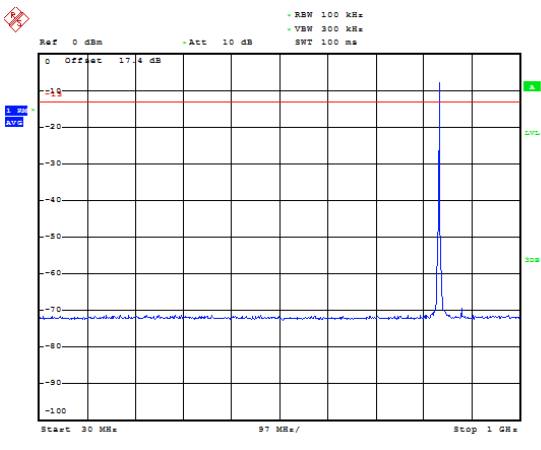

Date: 24.MAR.2019 15:25:54

### LTE Band 5 1.4MHz CH-Middle 1GHz~9GHz

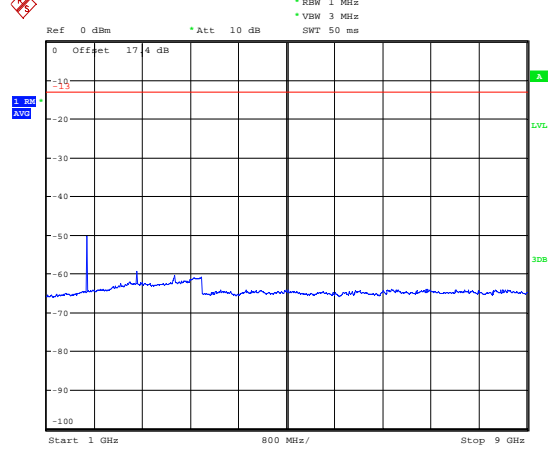

Date: 24.MAR.2019 15:32:01

### LTE Band 5 1.4MHz CH-High 30MHz~1GHz

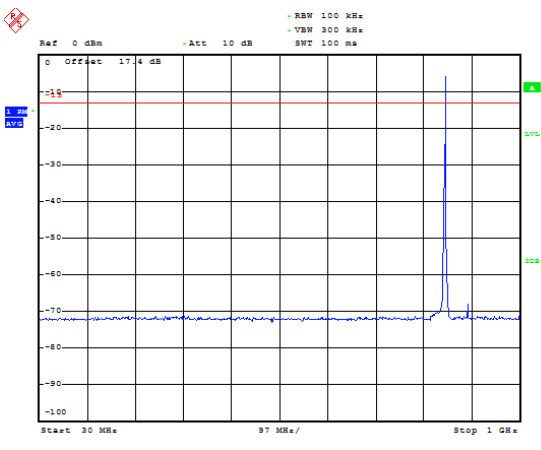

Date: 24.MAR.2019 15:26:14

### LTE Band 5 1.4MHz CH-High 1GHz~9GHz

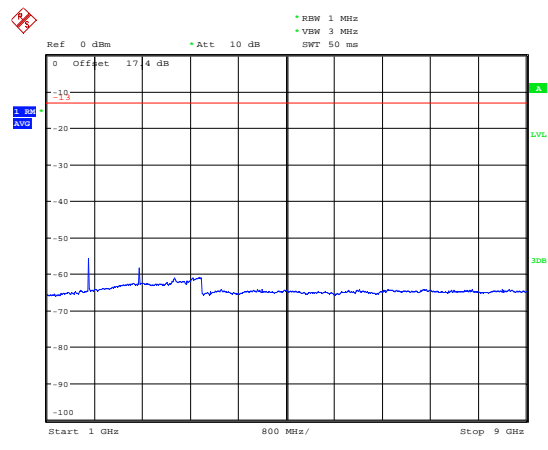

Date: 24.MAR.2019 15:32:15



### LTE Band 5 3MHz CH-Low 30MHz~1GHz

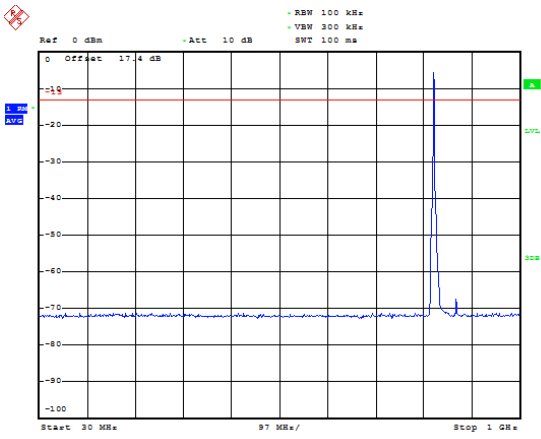

Date: 24.MAR.2019 15:26:45

### LTE Band 5 3MHz CH-Low 1GHz~9GHz

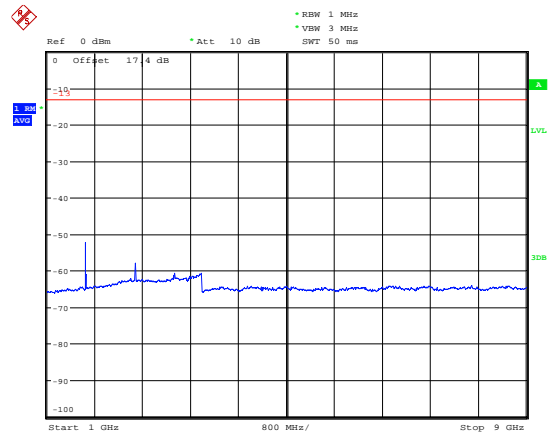

Date: 24.MAR.2019 15:32:45

### LTE Band 5 3MHz CH-Middle 30MHz~1GHz

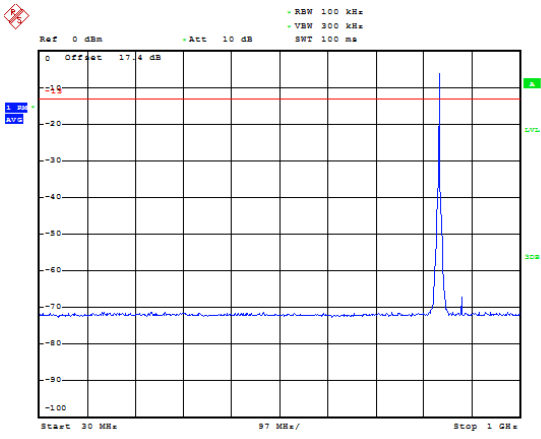

Date: 24.MAR.2019 15:27:07

### LTE Band 5 3MHz CH-Middle 1GHz~9GHz

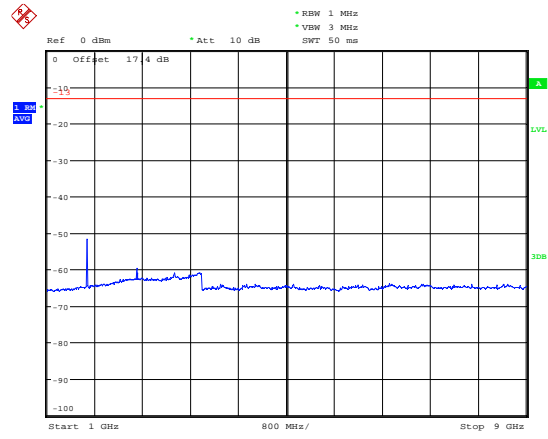

Date: 24.MAR.2019 15:32:58

### LTE Band 5 3MHz CH-High 30MHz~1GHz

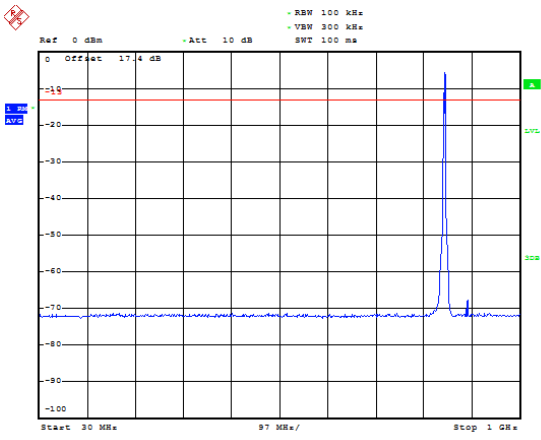

Date: 24.MAR.2019 15:27:26

### LTE Band 5 3MHz CH-High 1GHz~9GHz

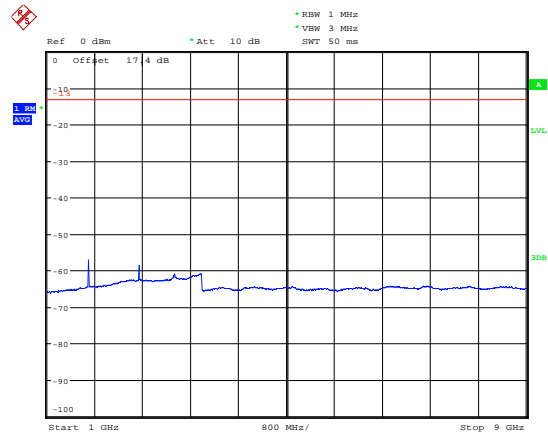

Date: 24.MAR.2019 15:33:16





LTE Band 5 5MHz CH-Low 30MHz~1GHz

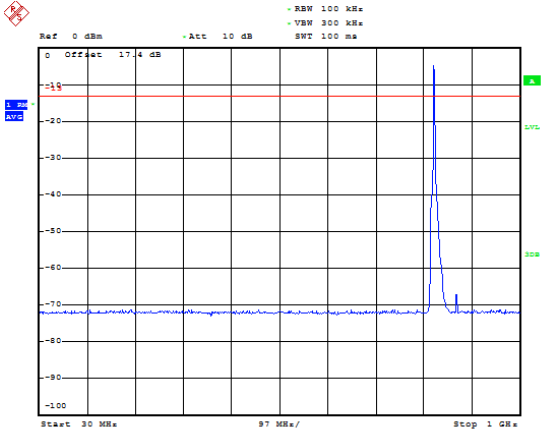

Date: 24.MAR.2019 15:27:59

LTE Band 5 5MHz CH-Low 1GHz~9GHz

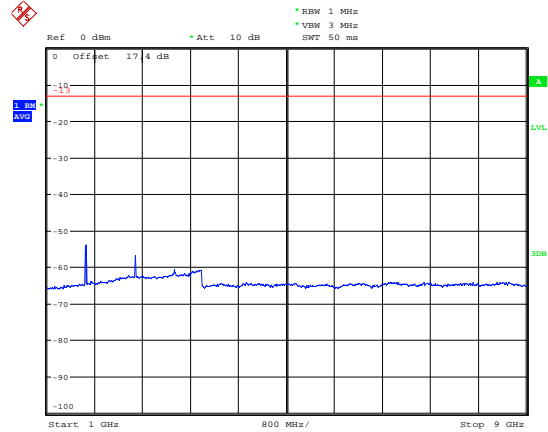

Date: 24.MAR.2019 15:33:42

LTE Band 5 5MHz CH-Middle 30MHz~1GHz

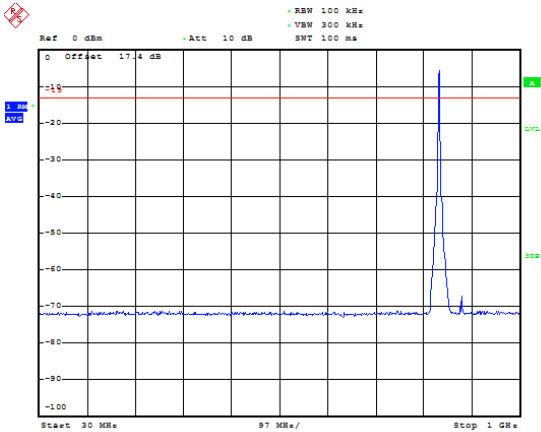

Date: 24.MAR.2019 15:28:05

LTE Band 5 5MHz CH-Middle 1GHz~9GHz

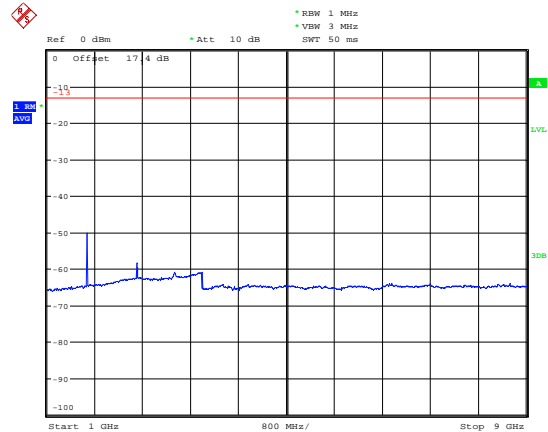

Date: 24.MAR.2019 15:33:54

LTE Band 5 5MHz CH-High 30MHz~1GHz

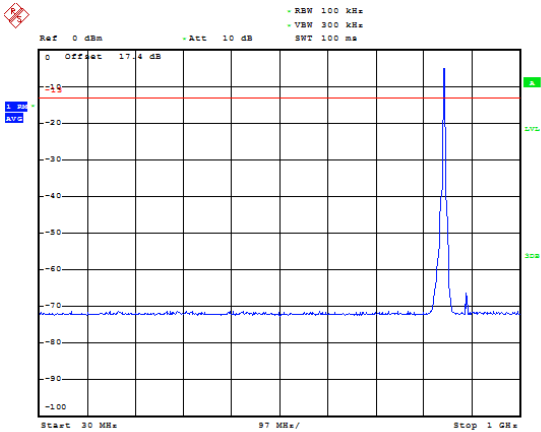

Date: 24.MAR.2019 15:28:20

LTE Band 5 5MHz CH-High 1GHz~9GHz

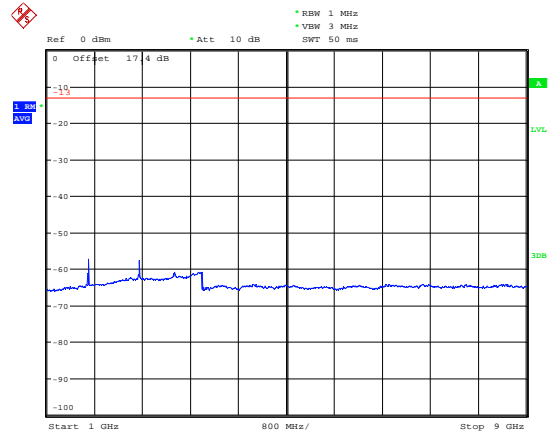

Date: 24.MAR.2019 15:34:09



### LTE Band 5 10MHz CH-Low 30MHz~1GHz

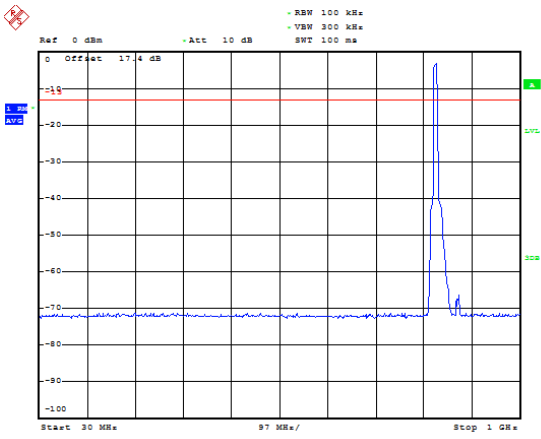

Date: 24.MAR.2019 15:28:44

### LTE Band 5 10MHz CH-Low 1GHz~9GHz

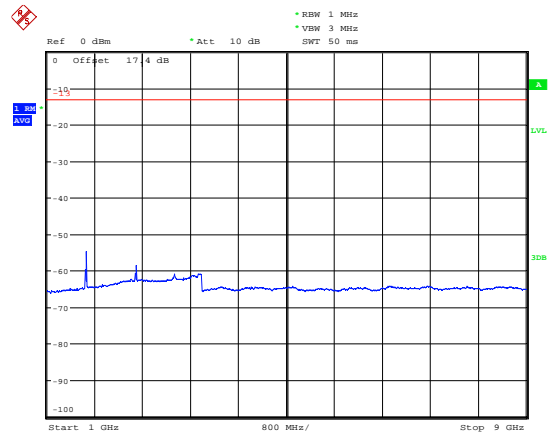

Date: 24.MAR.2019 15:30:10

### LTE Band 5 10MHz CH-Middle 30MHz~1GHz

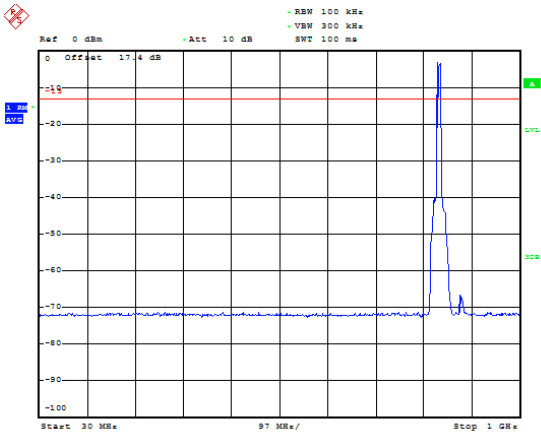

Date: 24.MAR.2019 15:29:01

### LTE Band 5 10MHz CH-Middle 1GHz~9GHz

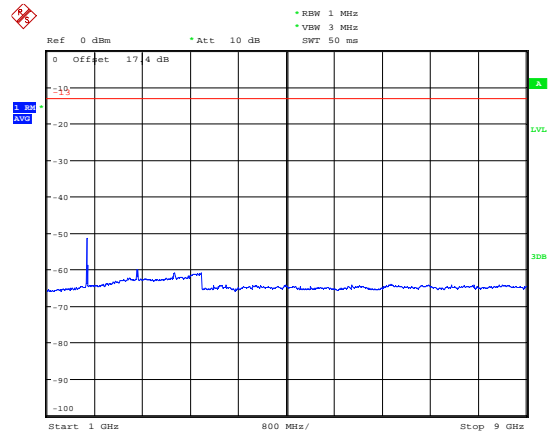

Date: 24.MAR.2019 15:29:55

### LTE Band 5 10MHz CH-High 30MHz~1GHz

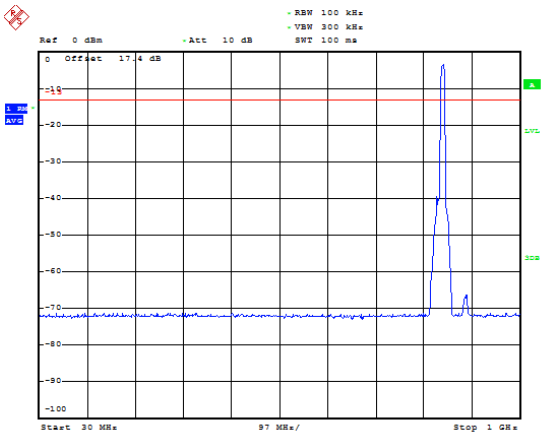

Date: 24.MAR.2019 15:29:15

### LTE Band 5 10MHz CH-High 1GHz~9GHz

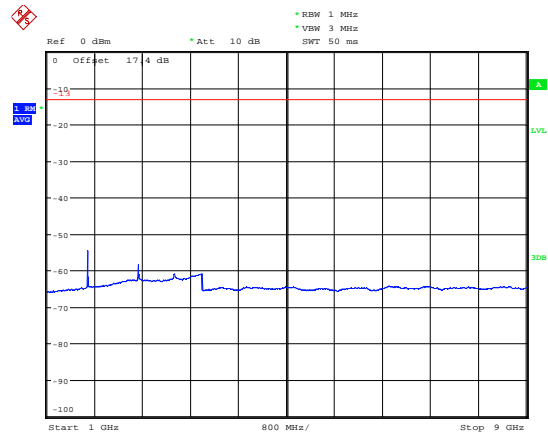

Date: 24.MAR.2019 15:29:40

## 5.8. Radiates Spurious Emission

### Ambient condition

Temperature	Relative humidity	Pressure
23°C ~25°C	45%~50%	101.5kPa

### Method of Measurement

- The testing follows FCC KDB 971168 v03r01 Section 5.8 and ANSI C63.26 (2015).
- Below 1GHz: The EUT is placed on a turntable 0.8 meters above the ground in the chamber, 3 meter away from the antenna. The maximal emission value is acquired by adjusting the antenna height, polarisation and turntable azimuth. Normally, the height range of antenna is 1 m to 4 m, the azimuth range of turntable is 0° to 360°, and the receive antenna has two polarizations Vertical (V) and Horizontal (H). Above 1GHz: (Note: the FCC's permission to use 1.5m as an alternative per TCBC Conf call of Dec. 2, 2014.) The EUT is placed on a turntable 1.5 meters above the ground in the chamber, 3 meter away from the antenna. The maximal emission value is acquired by adjusting the antenna height, polarisation and turntable azimuth. Normally, the height range of antenna is 1 m to 4 m, the azimuth range of turntable is 0° to 360°, and the receive antenna has two polarizations Vertical (V) and Horizontal (H).
- A loop antenna, A log-periodic antenna or horn antenna shall be substituted in place of the EUT. The log-periodic antenna will be driven by a signal generator and the level will be adjusted till the same power value on the spectrum analyzer or receiver. The level of the spurious emissions can be calculated through the level of the signal generator, cable loss, the gain of the substitution antenna and the reading of the spectrum analyzer or receiver.
- The EUT is then put into continuously transmitting mode at its maximum power level during the test. Set Test Receiver or Spectrum RBW=200Hz,VBW=600Hz for 9kHz150kHz , RBW=10kHz, VBW=30kHz 150kHz-30MHz , RBW=100kHz,VBW=300kHz for 30MHz to 1GHz and RBW=1MHz, VBW=3MHz for above 1GHz, And the maximum value of the receiver should be recorded as (Pr).
- The EUT shall be replaced by a substitution antenna. In the chamber, an substitution antenna for the frequency band of interest is placed at the reference point of the chamber. An RF Signal source for the frequency band of interest is connected to the substitution antenna with a cable that has been constructed to not interfere with the radiation pattern of the antenna. A power (PMea) is applied to the input of the substitution antenna, and adjust the level of the signal generator output until the value of the receiver reach the previously recorded (Pr). The power of signal source (PMea) is recorded. The test should be performed by rotating the test item and adjusting the receiving antenna polarization.
- A amplifier should be connected to the Signal Source output port. And the cable should be connect between the Amplifier and the Substitution Antenna. The cable loss (Pcl) ,the Substitution Antenna Gain (Ga) and the Amplifier Gain (PAg) should be recorded after test.
- The measurement results are obtained as described below:  
 $Power(EIRP)=PMea- PAg - Pcl + Ga$   
 The measurement results are amend as described below:  
 $Power(EIRP)=PMea- Pcl + Ga$
- This value is EIRP since the measurement is calibrated using an antenna of known gain (2.15 dBi)

and known input power. ERP can be calculated from EIRP by subtracting the gain of the dipole,  $ERP = EIRP - 2.15\text{dBi}$ .

The modulation mode and RB allocation refer to section 5.1, using the maximum output power configuration.

**Test setup**

**9KHz ~ 30MHz**

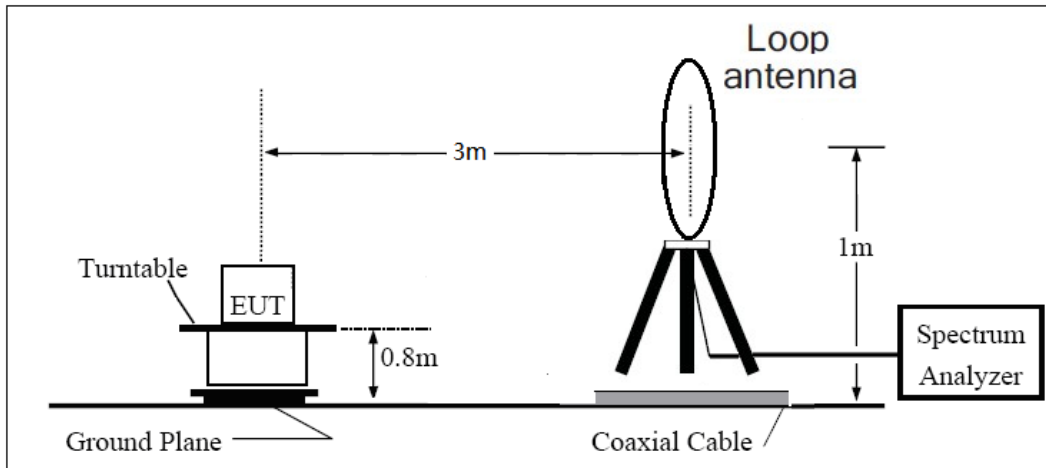

**30MHz ~ 1GHz**

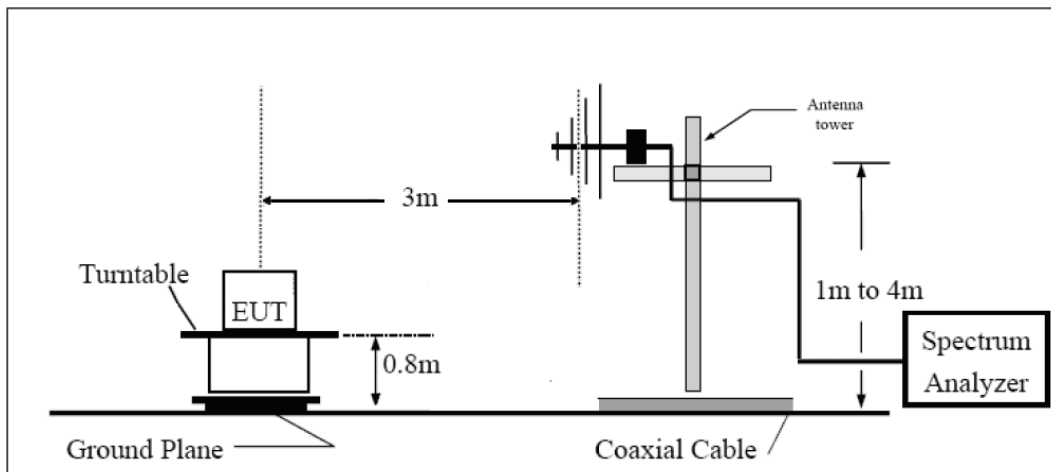

**Above 1GHz**

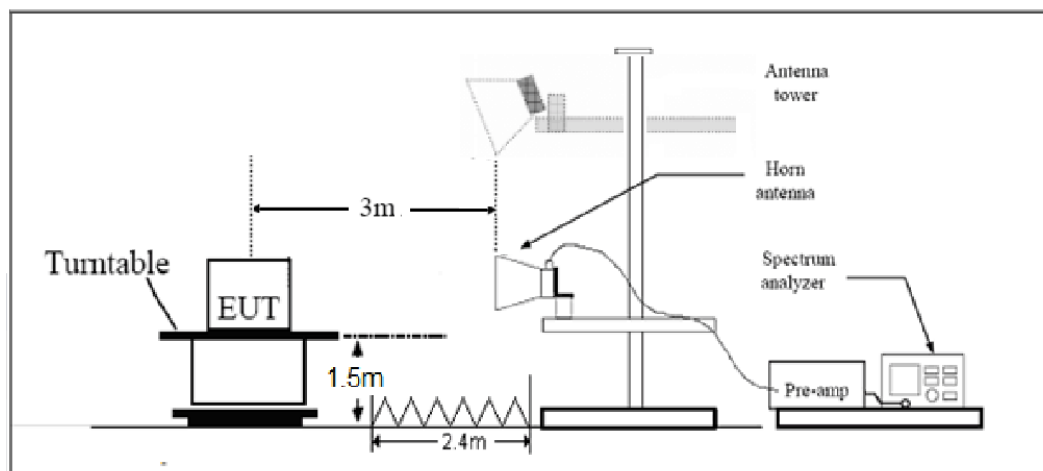



Note: Area side:2.4mX3.6m

**Limits**

Rule Part 22.917(a) specifies that “The power of any emission outside of the authorized operating frequency ranges must be attenuated below the transmitting power (P) by a factor of at least  $43 + 10 \log (P)$  dB.”

Limit	-13 dBm
-------	---------

**Measurement Uncertainty**

The assessed measurement uncertainty to ensure 95% confidence level for the normal distribution is with the coverage factor  $k = 1.96$ ,  $U = 3.55$  dB.

**Test Result**

Sweep the whole frequency band through the range from 9kHz to the 10th harmonic of the carrier, the emissions below the noise floor will not be recorded in the report.

**Variant**

GSM 850 CH-Middle

Harmonic	Frequency (MHz)	SG (dBm)	Cable Loss (dB)	Gain (dBi)	Antenna Polarization	ERP Level (dBm)	Limit (dBm)	Margin (dB)	Azimuth (deg)
2	1673.2	-57.40	2.00	10.75	Horizontal	-50.80	-13.00	37.80	45
3	2509.8	-48.06	2.51	11.05	Horizontal	-41.67	-13.00	28.67	135
4	3346.4	-54.58	4.20	11.15	Horizontal	-49.78	-13.00	36.78	0
5	4183.0	-58.33	5.20	11.15	Horizontal	-54.53	-13.00	41.53	225
6	5019.6	-48.47	5.50	11.95	Horizontal	-44.17	-13.00	31.17	135
7	5856.2	-59.31	5.70	13.55	Horizontal	-53.61	-13.00	40.61	315
8	6692.8	-57.43	6.30	13.75	Horizontal	-52.13	-13.00	39.13	45
9	7529.4	-55.40	6.80	13.85	Horizontal	-50.50	-13.00	37.50	90
10	8366.0	-54.31	6.90	14.25	Horizontal	-49.11	-13.00	36.11	180

Note: 1.The other Spurious RF Radiated emissions level is no more than noise floor.  
2.The worst emission was found in the antenna is Horizontal position.

**Original**

WCDMA Band V CH-Middle

Harmonic	Frequency (MHz)	SG (dBm)	Cable Loss (dB)	Gain (dBi)	Antenna Polarization	ERP Level (dBm)	Limit (dBm)	Margin (dB)	Azimuth (deg)
2	1673	-57.90	2.00	10.75	Horizontal	-51.30	-13.00	38.30	180
3	2510	-62.79	2.51	11.05	Horizontal	-56.40	-13.00	43.40	225
4	3346	-64.20	4.20	11.15	Horizontal	-59.40	-13.00	46.40	90
5	4183	-61.35	5.20	11.15	Horizontal	-57.55	-13.00	44.55	45
6	5020	-58.75	5.50	11.95	Horizontal	-54.45	-13.00	41.45	225
7	5856	-59.60	5.70	13.55	Horizontal	-53.90	-13.00	40.90	135
8	6693	-57.10	6.30	13.75	Horizontal	-51.80	-13.00	38.80	0
9	8366	-54.70	6.80	13.85	Horizontal	-49.80	-13.00	36.80	180
10	3346	-54.36	6.90	14.25	Horizontal	-49.16	-13.00	36.16	270

Note: 1.The other Spurious RF Radiated emissions level is no more than noise floor.  
2.The worst emission was found in the antenna is Horizontal position.

LTE Band 5 1.4MHz CH-Middle

Harmonic	Frequency (MHz)	SG (dBm)	Cable Loss (dB)	Gain (dBi)	Antenna Polarization	ERP Level (dBm)	Limit (dBm)	Margin (dB)	Azimuth (deg)
2	1673.0	-56.59	2.00	10.75	Horizontal	-49.99	-13.00	36.99	225
3	2509.5	-56.17	2.51	11.05	Horizontal	-49.78	-13.00	36.78	90
4	3346.0	-61.75	4.20	11.15	Horizontal	-56.95	-13.00	43.95	225
5	4182.5	-59.36	5.20	11.15	Horizontal	-55.56	-13.00	42.56	90
6	5019.0	-56.45	5.50	11.95	Horizontal	-52.15	-13.00	39.15	180
7	5855.5	-57.86	5.70	13.55	Horizontal	-52.16	-13.00	39.16	45
8	6692.0	-55.78	6.30	13.75	Horizontal	-50.48	-13.00	37.48	0
9	7528.5	-53.82	6.80	13.85	Horizontal	-48.92	-13.00	35.92	270
10	8365.0	-53.26	6.90	14.25	Horizontal	-48.06	-13.00	35.06	135

Note: 1.The other Spurious RF Radiated emissions level is no more than noise floor.  
 2.The worst emission was found in the antenna is Horizontal position.

LTE Band 5 5MHz CH-Middle

Harmonic	Frequency (MHz)	SG (dBm)	Cable Loss (dB)	Gain (dBi)	Antenna Polarization	ERP Level (dBm)	Limit (dBm)	Margin (dB)	Azimuth (deg)
2	1673.0	-57.61	2.00	10.75	Horizontal	-51.01	-13.00	38.01	0
3	2509.5	-55.43	2.51	11.05	Horizontal	-49.04	-13.00	36.04	45
4	3346.0	-61.93	4.20	11.15	Horizontal	-57.13	-13.00	44.13	225
5	4182.5	-59.20	5.20	11.15	Horizontal	-55.40	-13.00	42.40	90
6	5019.0	-57.06	5.50	11.95	Horizontal	-52.76	-13.00	39.76	0
7	5855.5	-58.25	5.70	13.55	Horizontal	-52.55	-13.00	39.55	45
8	6692.0	-55.69	6.30	13.75	Horizontal	-50.39	-13.00	37.39	180
9	7528.5	-53.00	6.80	13.85	Horizontal	-48.10	-13.00	35.10	135
10	8365.0	-54.05	6.90	14.25	Horizontal	-48.85	-13.00	35.85	225

Note: 1.The other Spurious RF Radiated emissions level is no more than noise floor.  
 2.The worst emission was found in the antenna is Horizontal position.



## LTE Band 5 10MHz CH-Middle

Harmonic	Frequency (MHz)	SG (dBm)	Cable Loss (dB)	Gain (dBi)	Antenna Polarization	ERP Level (dBm)	Limit (dBm)	Margin (dB)	Azimuth (deg)
2	1673.0	-53.92	2.00	10.75	Horizontal	-47.32	-13.00	34.32	180
3	2509.5	-52.51	2.51	11.05	Horizontal	-46.12	-13.00	33.12	135
4	3346.0	-62.74	4.20	11.15	Horizontal	-57.94	-13.00	44.94	90
5	4182.5	-59.65	5.20	11.15	Horizontal	-55.85	-13.00	42.85	180
6	5019.0	-57.43	5.50	11.95	Horizontal	-53.13	-13.00	40.13	180
7	5855.5	-58.18	5.70	13.55	Horizontal	-52.48	-13.00	39.48	135
8	6692.0	-55.70	6.30	13.75	Horizontal	-50.40	-13.00	37.40	225
9	7528.5	-51.91	6.80	13.85	Horizontal	-47.01	-13.00	34.01	135
10	8365.0	-52.69	6.90	14.25	Horizontal	-47.49	-13.00	34.49	225

Note: 1.The other Spurious RF Radiated emissions level is no more than noise floor.

2.The worst emission was found in the antenna is Horizontal position.



## 6. Main Test Instruments

Name	Manufacturer	Type	Serial Number	Calibration Date	Expiration Date
Base Station Simulator	R&S	CMW500	113824	2018-05-20	2019-05-19
Power Splitter	Hua Xiang	SHX-GF2-2-13	10120101	/	/
Spectrum Analyzer	Key sight	N9010A	MY50210259	2018-05-20	2019-05-19
Universal Radio Communication Tester	Key sight	E5515C	MY48367192	2018-05-20	2019-05-19
Signal Analyzer	R&S	FSV30	100815	2018-12-16	2019-12-15
Loop Antenna	SCHWARZBECK	FMZB1519	1519-047	2017-09-26	2019-09-25
Trilog Antenna	SCHWARZBECK	VUBL 9163	9163-201	2017-11-18	2019-11-17
Horn Antenna	R&S	HF907	100126	2018-07-07	2020-07-06
Horn Antenna	ETS-Lindgren	3160-09	00102643	2018-06-20	2020-06-19
Signal generator	R&S	SMB 100A	102594	2018-05-20	2019-05-19
Climatic Chamber	ESPEC	SU-242	93000506	2017-12-17	2020-12-16
Preamplifier	R&S	SCU18	102327	2018-05-20	2019-05-19
MOB COMMS DC SUPPLY	Keysight	66319D	MY43004105	2018-05-21	2019-05-20
RF Cable	Agilent	SMA 15cm	0001	2019-03-15	2019-06-14
Software	R&S	EMC32	9.26.0	/	/

\*\*\*\*\*END OF REPORT \*\*\*\*\*

## ANNEX A: Product Change Description

Huawei Technologies Co., Ltd.

### Difference Declaration Letter

Article 1: Difference description:

The difference between model AMN-LX3 and model KSA-LX3 is show in the below table:

	Model	AMN-LX3	KSA-LX3
Licensed Frequency	LTE BAND	the same	the same
	UMTS BAND	the same	the same
	GSM	the same	the same
	IC	the same	the same
	Antenna	the same	the same
	RF conducted power	the same	the same
Unlicensed Frequency	Bluetooth	the same	the same
	2.4G Wi-Fi	the same	the same
	IC	the same	the same
	Antenna	the same	the same
Hardware	NFC	Not support	Not support
	MIC	the same	the same
	Ram / Rom	the same	the same
	Camera	the same	the same
	PCB	the same	the same
	USB Port	the same	the same
	SIM	the same	the same
RF	RF	the same	the same
Appearance	Dimension	the same	Only the rear camera has a different curved appearance
	Color	the same	the same
Accessory	Battery	the same	the same
	Charger	the same	the same
	USB label	the same	the same
	Earphone	the same	the same