



**FCC PART 15C  
TEST REPORT  
No. B17N00263-DFS**

**for**

**Huawei Technologies Co.,Ltd.**

**HUAWEI MediaPad T3**

**Model Name: KOB-W09**

**With**

**Hardware Version: REACHW-V1.0**

**Software Version: KOB-W09C331B002-log**

**FCC ID: QISKOB-W09**

**Issued Date: 2017-06-16**

**Test Laboratory:**

***FCC 2.948 Listed: No.342690***

**Note:** The test results in this test report relate only to the devices specified in this report. This report shall not be reproduced except in full without the written approval of CTTL.

**Test Laboratory:**

CTTL, Telecommunication Technology Labs, Academy of Telecommunication Research, MIIT

No. 52, Huayuan Bei Road, Haidian District, Beijing, P. R. China, 100191

Tel:+86(0)10-62304633-2512, Fax:+86(0)10-62304633-2054

Email: [ctl\\_terminals@catr.cn](mailto:ctl_terminals@catr.cn), website: [www.chinattl.com](http://www.chinattl.com)



## **REPORT HISTORY**

<b>Report Number</b>	<b>Revision</b>	<b>Description</b>	<b>Issue Date</b>
B17N00263-DFS	Rev.0	1st edition	2017-04-10
B17N00263-DFS	Rev.1	2nd edition	2017-06-16



## **CONTENTS**

<b>1.</b>	<b>TEST LATORATORY</b> .....	<b>4</b>
1.1.	TESTING LOCATION .....	4
1.2.	TESTING ENVIRONMENT.....	4
1.3.	PROJECT DATA .....	4
1.4.	SIGNATURE .....	4
<b>2.</b>	<b>CLIENT INFORMATION</b> .....	<b>5</b>
<b>2.1.</b>	<b>APPLICANT INFORMATION</b> .....	<b>5</b>
<b>2.2.</b>	<b>MANUFACTURER INFORMATION</b> .....	<b>5</b>
<b>3.</b>	<b>EQUIPMENT UNDER TEST (EUT) AND ANCILLARY EQUIPMENT(AE)</b> .....	<b>6</b>
3.1.	ABOUT EUT .....	6
3.2.	INTERNAL IDENTIFICATION OF EUT USED DURING THE TEST .....	6
3.3.	INTERNAL IDENTIFICATION OF AE USED DURING THE TEST .....	6
3.4.	GENERAL DESCRIPTION.....	6
<b>4.</b>	<b>REFERENCE DOCUMENTS</b> .....	<b>7</b>
4.1.	DOCUMENTS SUPPLIED BY APPLICANT .....	7
4.2.	REFERENCE DOCUMENTS FOR TESTING .....	7
<b>5.</b>	<b>LABORATORY ENVIRONMENT</b> .....	<b>7</b>
<b>6.</b>	<b>SUMMARY OF TEST RESULTS</b> .....	<b>8</b>
6.1.	SUMMARY OF TEST RESULTS .....	8
6.2.	STATEMENTS.....	8
<b>7.</b>	<b>TEST EQUIPMENTS UTILIZED</b> .....	<b>9</b>
	<b>ANNEX A: MEASUREMENT RESULTS</b> .....	<b>10</b>
A.1.	MEASUREMENT METHOD .....	10
A.2.	CHANNEL MOVE TIME AND CHANNEL CLOSING TRANSMISSION TIME .....	12
A.3.	NON-OCCUPANCY PERIOD .....	15
A3.1	ASSOCIATED TEST .....	15



## **1. TEST LATORATORY**

### **1.1. Testing Location**

Location: CTTL(South Branch)

Address: TCL International E city, No. 1001, Zhongshanyuan Road, Nanshan District, Shenzhen, Guangdong, China 518000

### **1.2. Testing Environment**

Normal Temperature: 15-35°C

Relative Humidity: 20-75%

### **1.3. Project data**

Testing Start Date: 2017-03-14

Testing End Date: 2017-04-07

### **1.4. Signature**

---

Wang Haili  
(Prepared this test report)

---

Tang Weisheng  
(Reviewed this test report)

---

Zhang Bojun  
(Approved this test report)



## **2. CLIENT INFORMATION**

### **2.1. Applicant Information**

Company Name: Huawei Technologies Co.,Ltd.  
Address: Administration Building, Headquarters of Huawei Technologies Co.,Ltd., Bantian, Longgang District Shenzhen China  
City: Shenzhen  
Postal Code: /  
Country: China  
Telephone: /  
Fax: /

### **2.2. Manufacturer Information**

Company Name: Huawei Technologies Co.,Ltd.  
Address: Administration Building, Headquarters of Huawei Technologies Co.,Ltd., Bantian, Longgang District Shenzhen China  
City: Shenzhen  
Postal Code: /  
Country: China  
Telephone: /  
Fax: /



### **3. EQUIPMENT UNDER TEST (EUT) AND ANCILLARY**

#### **EQUIPMENT(AE)**

##### **3.1. About EUT**

Description	HUAWEI MediaPad T3
Model name	KOB-W09
FCC ID	QISKOB-W09
WLAN Frequency Range	ISM Band: - 5250MHz~5350MHz - 5470MHz~5725MHz
Type of modulation	OFDM
Antenna	Integral Antenna
Extreme vol. Limits	3.8V DC by Battery
Device Type (DFS)	Client without radar detection(only support client mode)
TPC mechanism	Not support

##### **3.2. Internal Identification of EUT used during the test**

<b>EUT ID*</b>	<b>IMEI</b>	<b>HW Version</b>	<b>SW Version</b>
EUT1	/	REACHW-V1.0	KOB-W09C331B002-log

\*EUT ID: is used to identify the test sample in the lab internally.

##### **3.3. Internal Identification of AE used during the test**

<b>AE ID*</b>	<b>Description</b>	<b>Type</b>	<b>SN</b>
AE1	Battery	/	/
AE2	Adapter	HW-050100U01	

\*AE ID: is used to identify the test sample in the lab internally.

##### **3.4. General Description**

The Equipment under Test (EUT) is a model of HUAWEI MediaPad T3 with integrated antenna and inbuilt battery.

It consists of normal options: travel charger, USB cable and Phone.

Manual and specifications of the EUT were provided to fulfil the test.



## 4. REFERENCE DOCUMENTS

### 4.1. Documents supplied by applicant

EUT feature information is supplied by the applicant or manufacturer, which is the basis of testing.

### 4.2. Reference Documents for testing

The following documents listed in this section are referred for testing.

Reference	Title	Version
FCC Part15	Title 47 of the Code of Federal Regulations; Chapter I Part 15 - Radio frequency devices Subpart E – UNII Devices	Nov,2015
FCC 06-96	Revision of Parts 2 and 15 of the Commission’s Rules to Permit Unlicensed National Information Infrastructure (U-NII) devices in the 5 GHz band	2006

Note: This report is only for DFS

## 5. Laboratory Environment

**Shielded room** did not exceed following limits along the EMC testing

Temperature	Min. = 15 °C, Max. = 30 °C
Relative humidity	Min. = 35 %, Max. = 60 %
Shielding effectiveness	0.014MHz - 1MHz, >60dB; 1MHz - 1000MHz, >90dB.
Electrical insulation	> 2 MΩ
Ground system resistance	< 4 Ω

## 6. SUMMARY OF TEST RESULTS

### 6.1. Summary of Test Results

No	Test cases	Sub-clause of Part15E	Verdict
1	Channel move time and channel closing transmission time	15.407 (h)(2)(iii)	<b>P</b>
2	Non-Occupancy Period	15.407 (h)(2) (iv)	<b>P</b>

Please refer to **ANNEX A** for detail.

Terms used in Verdict column

P	Pass, The EUT complies with the essential requirements in the standard.
NM	Not measured, The test was not measured by CTTL
NA	Not Applicable, The test was not applicable
F	Fail, The EUT does not comply with the essential requirements in the standard

### 6.2. Statements

CTTL has evaluated the test cases requested by the applicant/manufacturer as listed in section 5.1 of this report, for the EUT specified in section 3, according to the standards or reference documents listed in section 4.2.

This report only deal with the UNII DFS functions among the features described in section 3, and The EUT met all requirements of the reference documents.

The end user is not available to get and modify the parameters of the detected Radar Waveforms in this product.

#### Test Conditions

T nom	Normal Temperature
T min	Low Temperature
T max	High Temperature
V nom	Normal Voltage
V min	Low Voltage
V max	High Voltage
H nom	Norm Humidity
A nom	Norm Air Pressure

For this report, all the test case listed above is tested under Normal Temperature and Normal Voltage, and also under norm humidity, the specific conditions as following:

Temperature	T nom	26°C
Voltage	V nom	3.8V(By battery)
Humidity	H nom	44%
Air Pressure	A nom	1010hPa





## **7. TEST EQUIPMENTS UTILIZED**

### **Conducted test system**

<b>No.</b>	<b>Equipment</b>	<b>Model</b>	<b>Serial Number</b>	<b>Manufacturer</b>	<b>Calibration Date</b>	<b>Calibration Due Date</b>
1	Vector Signal Analyzer	FSV40	100903	Rohde & Schwarz	2018-01-18	1 year
2	Vector Signal General	SMU200A	104096	Rohde & Schwarz	2018-01-05	1 year
3	Master device	BCM94718 NR	1986113	BROADCOM	/	/
4	Shielding Room	S81	/	ETS-Lindgren	2019-11-13	3 years

## ANNEX A: MEASUREMENT RESULTS

### A.1. Measurement Method

#### A.1.1. Conducted Measurements

The below figure shows the DFS setup, where the EUT is a RLAN device operating in slave mode, without Radar Interference Detection function. This setup also contains a device operating in master mode. The radar test signals are injected into the master device. The EUT (slave device) is associated with the master device. WLAN traffic is generated by streaming the mpeg file from the master to the slave in full monitor video mode using the media player.

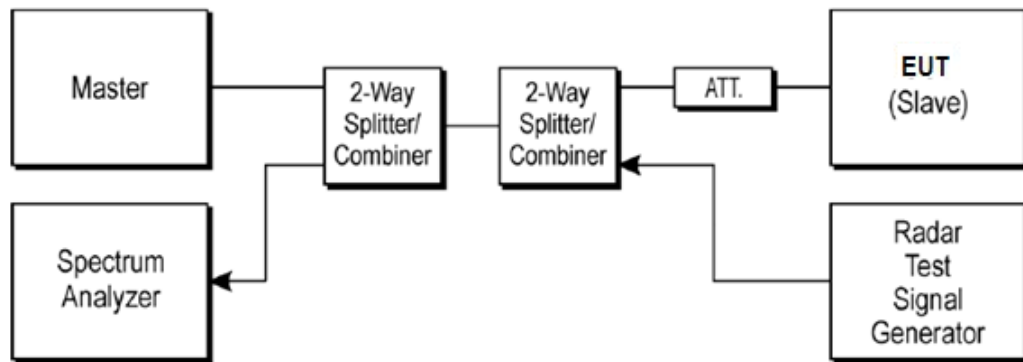

#### A.1.2. Parameters of DFS test signal

1). Interference threshold values, master or client incorporation in service monitoring. For device power less than 23dBm (E.I.R.P.), the threshold level is -62 dBm at the antenna port after correction for antenna gain and procedural adjustments.

Because of conducted measurement performed, the calibration power from radar signal generator to antenna port of DFS test equipment is -62 dBm.

Maximum Transmit Power	Value
> 200 mW	-64 dBm
< 200 mW	-62 dBm

2). DFS requirement values

The required values are as the following table.

Parameter	Value
Non-occupancy	> 1800 s
Channel Availability Check Time	60 s
Channel Move Time	10 s
Channel Closing Transmission Time	200 ms + 60 ms
U-NII Detection Bandwidth	Minimum 80% of the 99% transmission power bandwidth

As the EUT is IP based system, the MPEG video file from NTIA website is used to stream to EUT via the Master device.



**A.1.3. Measurement Uncertainty**

Item	Measurement
Time	0.70 ms
Power	0.75 dBm

## A.2. Channel move time and channel closing transmission time

### Measurement Limit:

Test Items	Limit
channel closing transmission time	< 200 ms + 60 ms
Channel move time	< 10 s

### Measurement Results:

HT20 Frequency Band: 5250MHz ~ 5350MHz

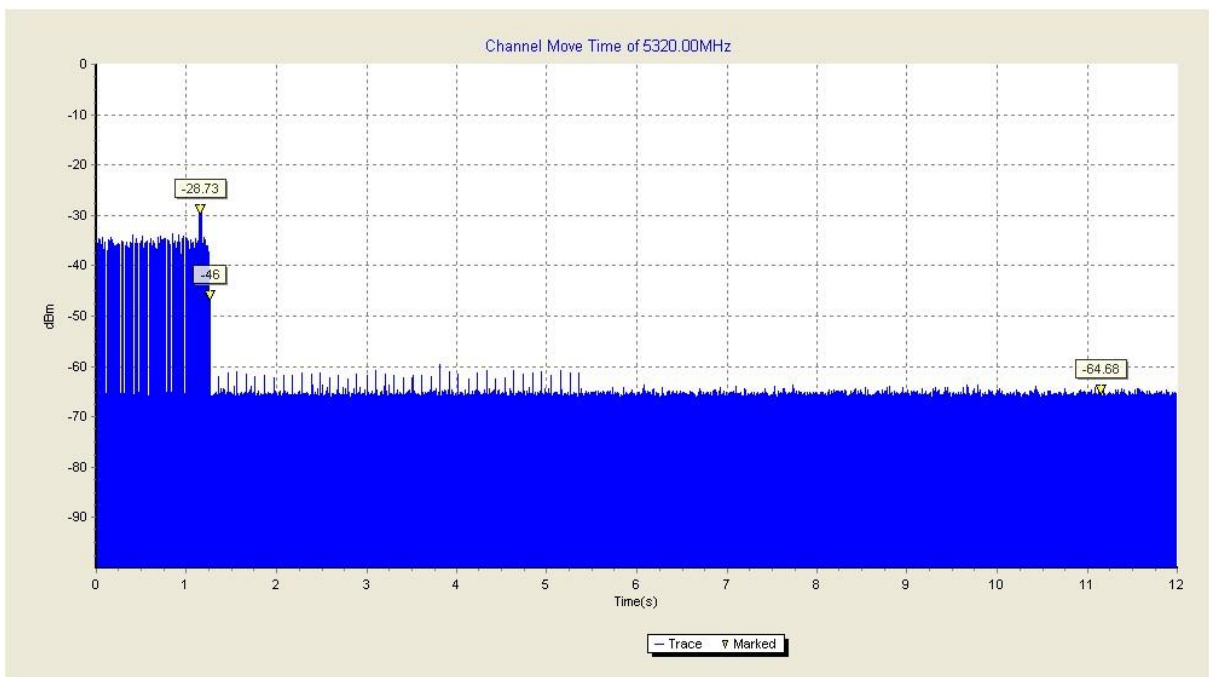

The channel move time is as the figure. It shows the time of the radar and the client pulses. The figure shows that the client stops transmission within 10 seconds, and no transmissions occur after 10 seconds later of the radar burst signal.

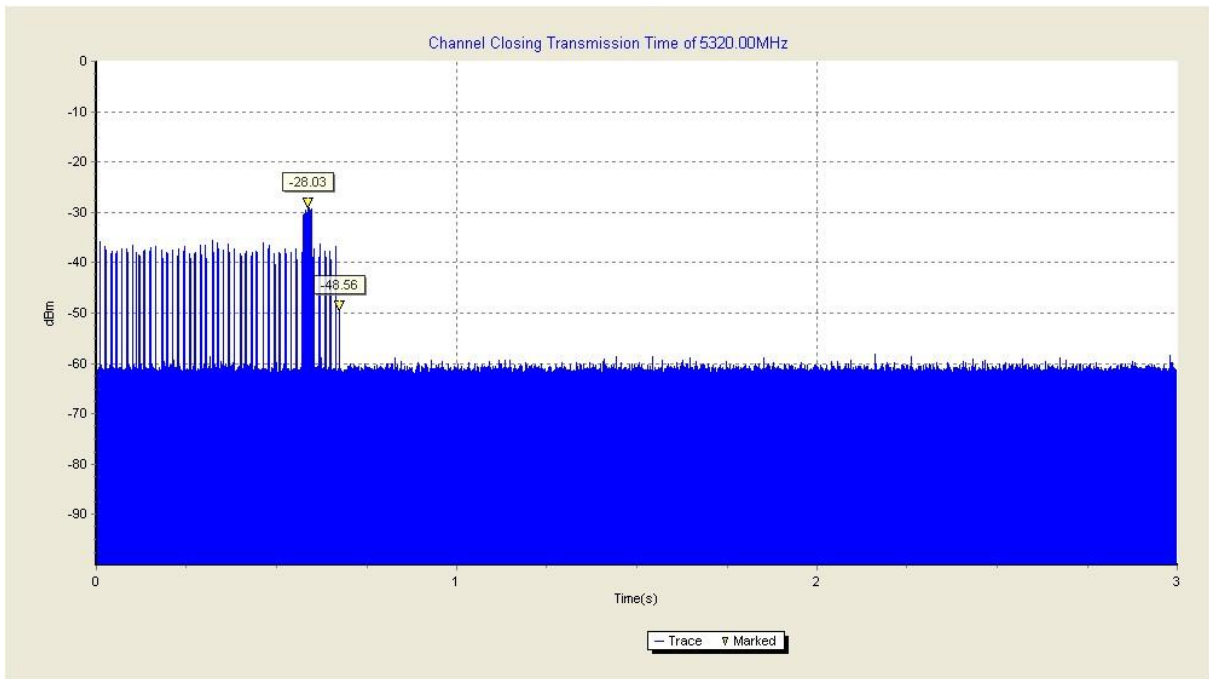

The closing transmission time is as the figure, and the result is 87ms

**Conclusion: PASS**

**HT40 Frequency Band: 5470MHz ~ 5725MHz**

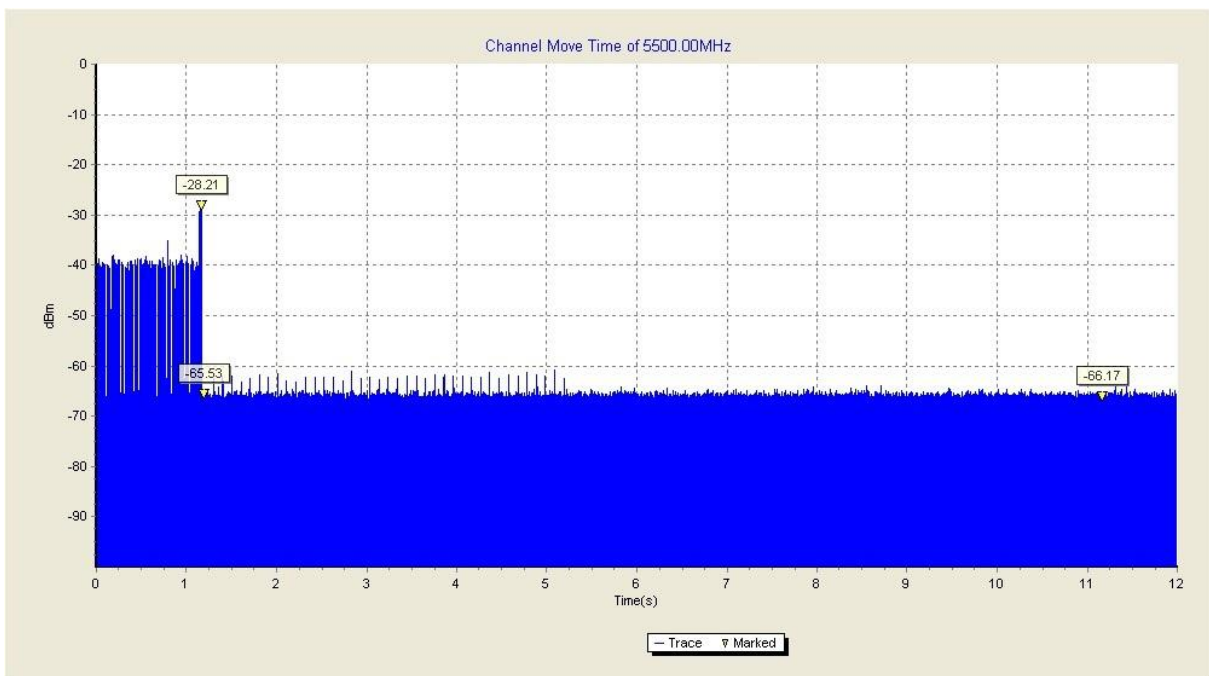

The channel move time is as the figure. It shows the time of the radar and the client pulses. The figure shows that the client stops transmission within 10 seconds, and no transmissions occur after 10 seconds later of the radar burst signal.

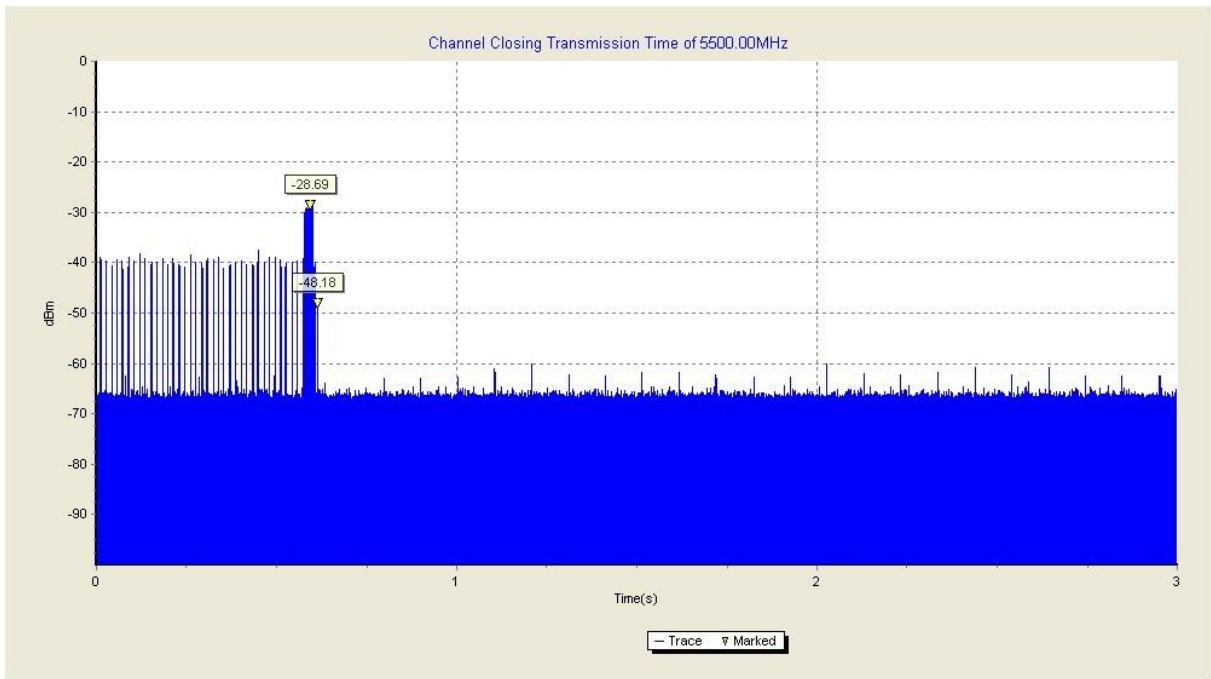

The closing transmission time is as the figure, and the result is 21ms

**Conclusion: PASS**

### A.3. Non-Occupancy Period

#### Measurement Limit:

Test Items	Limit
Non-Occupancy Period	> 1800 s

#### Associated test

Associate the master and client, transmit specified stream between the master and client; monitor the analyzer on the operating frequency to make sure no beacons have been transmitted for 1800 seconds.

#### HT20 Frequency Band: 5250MHz ~ 5350MHz

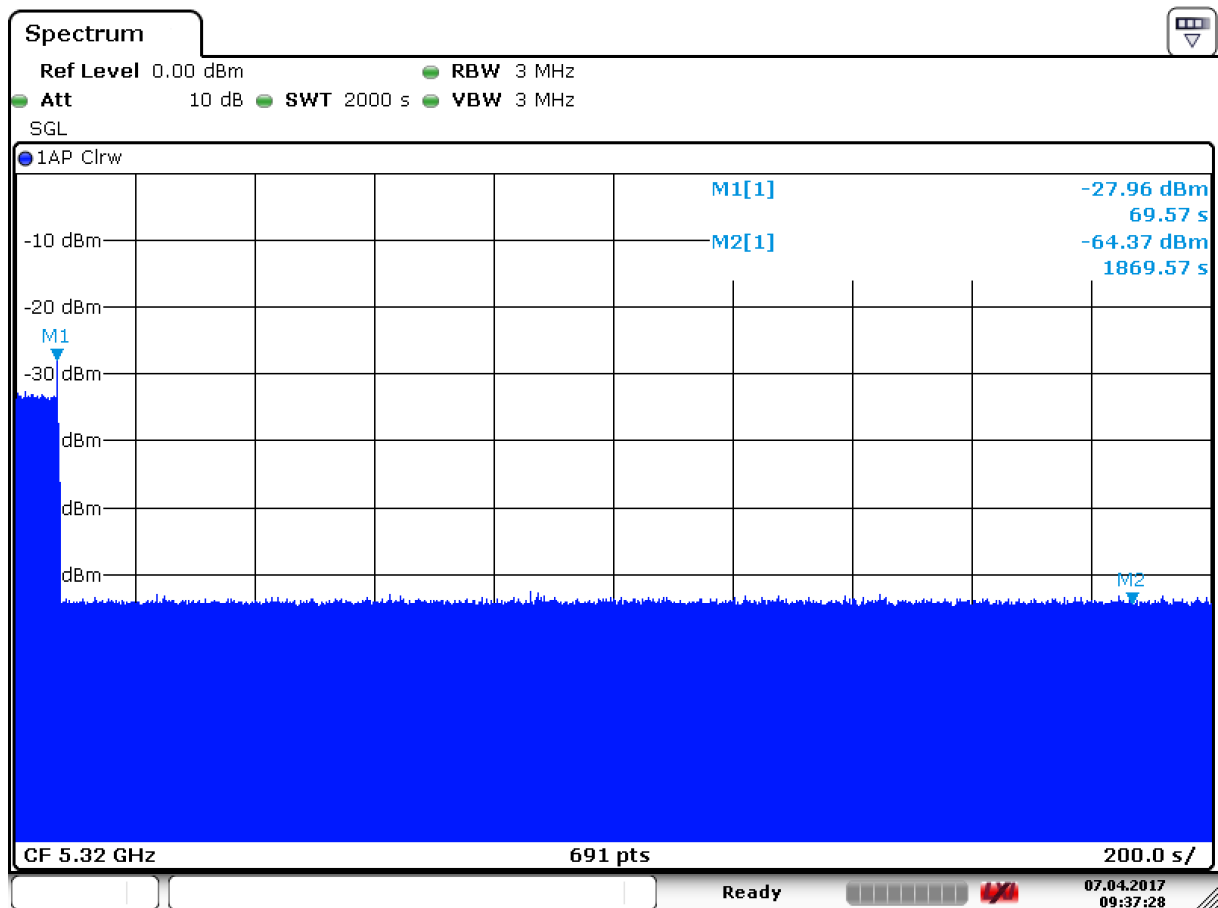

Date: 7.APR.2017 09:37:28

The figure above shows that the client does not transmit any emission within 1800 seconds after getting the order of “stop transmits” from the DFS master (access point).

HT40 Frequency Band: 5470MHz ~ 5725MHz

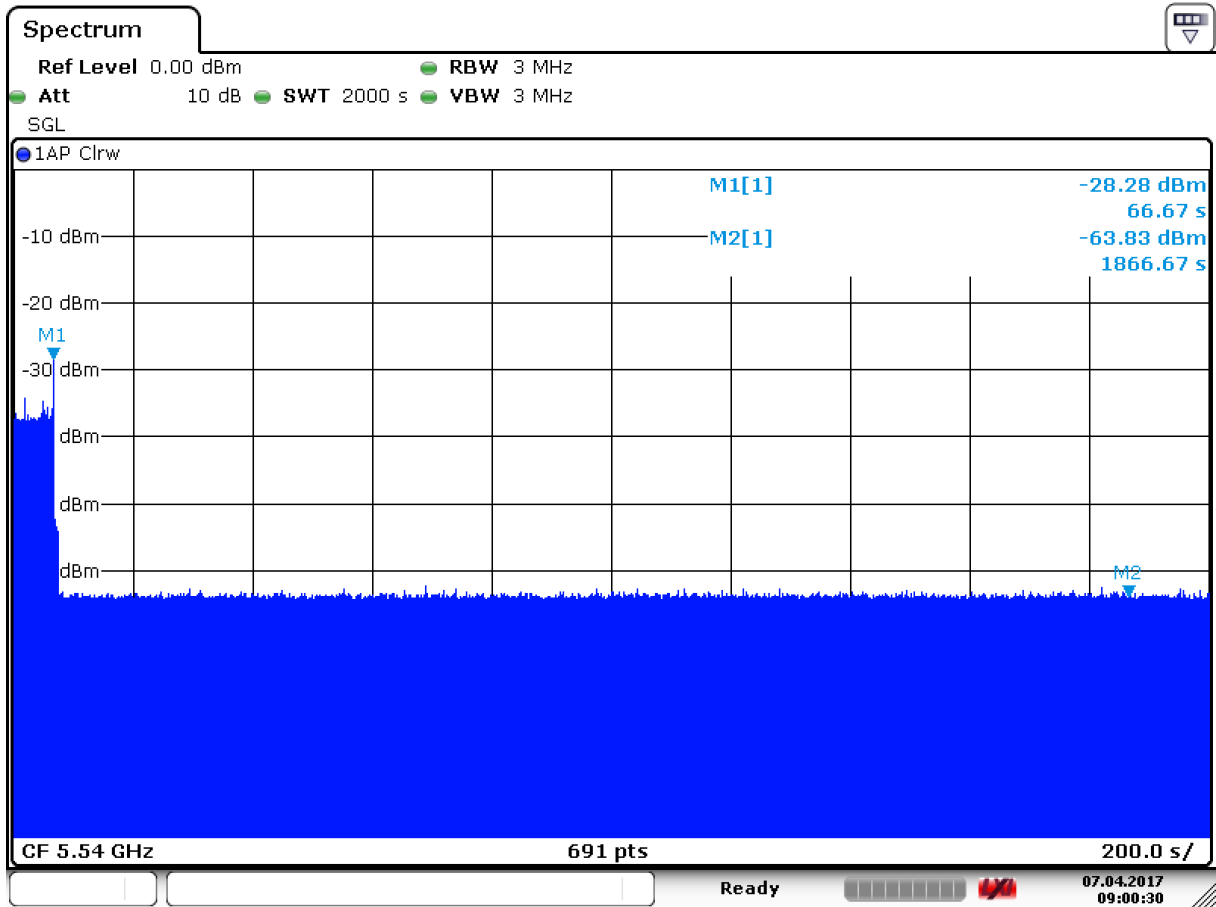

Date: 7.APR.2017 09:00:31

The figure above shows that the client does not transmit any emission within 1800 seconds after getting the order of "stop transmits" from the DFS master (access point).

**Conclusion: PASS**

\*\*\* END OF REPORT BODY \*\*\*