



# RF TEST REPORT

**Applicant** Huawei Technologies Co., Ltd.  
**FCC ID** QISKOB-L09  
**Brand Name** HUAWEI  
**Product** Tablet  
**Model** KOB-L09  
**Report No.** R1804H0051-R5  
**Issue Date** May 15, 2018

TA Technology (Shanghai) Co., Ltd. tested the above equipment in accordance with the requirements in **FCC CFR47 Part 15C (2018)**. The test results show that the equipment tested is capable of demonstrating compliance with the requirements as documented in this report.

*Performed by: Xianqing Li*

*Approved by: Kai Xu*

---

## TA Technology (Shanghai) Co., Ltd.

*No.145, Jintang Rd, Tangzhen Industry Park, Pudong Shanghai, China*

*TEL: +86-021-50791141/2/3*

*FAX: +86-021-50791141/2/3-8000*



## TABLE OF CONTENT

1. Test Laboratory .....	4
1.1. Notes of the test report.....	4
1.2. Test facility .....	4
1.3. Testing Location.....	5
2. General Description of Equipment under Test.....	6
3. Applied Standards .....	8
4. Test Configuration .....	9
5. Test Case Results .....	10
5.1. Maximum conducted output power .....	10
5.2. 6dB Bandwidth .....	12
5.3. Band Edge .....	16
5.4. Power Spectral Density .....	18
5.5. Spurious RF Conducted Emissions.....	22
5.6. Radiated Emissions in the Restricted Band .....	26
5.7. Radiates Emission .....	31
5.8. Conducted Emission .....	59
6. Main Test Instruments.....	61



## Summary of measurement results

Number	Summary of measurements of results	Clause in FCC rules	Verdict
1	Maximum conducted output power	15.247(b)(3)	PASS
2	6 dB bandwidth	15.247(a)(2)	PASS
3	Power spectral density	15.247(e)	PASS
4	Band Edge	15.247(d)	PASS
5	Spurious RF Conducted Emissions	15.247(d)	PASS
6	Radiated Emissions in restricted frequency bands	15.247(d),15.205,15.209	PASS
7	Radiated Emissions	15.247(d),15.205,15.209	PASS
8	Conducted Emissions	15.207	PASS

Date of Testing: April 26, 2018~ May 8, 2018

## 1. Test Laboratory

### 1.1. Notes of the test report

This report shall not be reproduced in full or partial, without the written approval of **TA technology (shanghai) co., Ltd.** The results documented in this report apply only to the tested sample, under the conditions and modes of operation as described herein .Measurement Uncertainties were not taken into account and are published for informational purposes only. This report is written to support regulatory compliance of the applicable standards stated above.

### 1.2. Test facility

#### **CNAS (accreditation number: L2264)**

TA Technology (Shanghai) Co., Ltd. has obtained the accreditation of China National Accreditation Service for Conformity Assessment (CNAS).

#### **FCC (Designation number: CN1179, Test Firm Registration Number: 446626)**

TA Technology (Shanghai) Co., Ltd. has been listed on the US Federal Communications Commission list of test facilities recognized to perform electromagnetic emissions measurements.

#### **IC (recognition number is 8510A)**

TA Technology (Shanghai) Co., Ltd. has been listed by industry Canada to perform electromagnetic emission measurement.

#### **VCCI (recognition number is C-4595, T-2154, R-4113, G-10766)**

TA Technology (Shanghai) Co., Ltd. has been listed by industry Japan to perform electromagnetic emission measurement.

#### **A2LA (Certificate Number: 3857.01)**

TA Technology (Shanghai) Co., Ltd. has been listed by American Association for Laboratory Accreditation to perform electromagnetic emission measurement.



### 1.3. Testing Location

Company: TA Technology (Shanghai) Co., Ltd.  
Address: No.145, Jintang Rd, Tangzhen Industry Park, Pudong  
City: Shanghai  
Post code: 201201  
Country: P. R. China  
Contact: Xu Kai  
Telephone: +86-021-50791141/2/3  
Fax: +86-021-50791141/2/3-8000  
Website: <http://www.ta-shanghai.com>  
E-mail: [xukai@ta-shanghai.com](mailto:xukai@ta-shanghai.com)

## 2. General Description of Equipment under Test

### Client Information

Applicant	Huawei Technologies Co., Ltd.
Applicant address	Administration Building, Headquarters of Huawei Technologies Co., Ltd., Bantian, Longgang District, Shenzhen, 518129, P.R.China.
Manufacturer	Huawei Technologies Co., Ltd.
Manufacturer address	Administration Building, Headquarters of Huawei Technologies Co., Ltd., Bantian, Longgang District, Shenzhen, 518129, P.R.China.

### General information

EUT Description	
Model	KOB-L09
IMEI	864004035495529
Hardware Version	REACH-V2.0
Software Version	KOB-L09C127B252CUSTC127D001
Power Supply	Battery/AC adapter
Antenna Type	Internal Antenna
Antenna Connector	A permanently attached antenna (meet with the standard FCC Part 15.203 requirement)
Antenna Gain	-1.0 dBi
Test Mode	Bluetooth V4.1 LE 802.11b 802.11g, 802.11n(HT20);
Modulation Type	BLE :GFSK 802.11b: DSSS; 802.11g/n(HT20): OFDM
Max. Conducted Power	Wi-Fi 2.4G :10.57dBm BLE : 5.05 dBm
Operating Frequency Range(s)	802.11b/g/n(HT20): 2412 ~ 2462 MHz BLE: 2402 ~2480 MHz
EUT Accessory	
Adapter 1	Manufacturer: SHENZHEN HUNTKEY ELECTRIC CO.,LTD Model: HW-050100B01
Adapter 2	Manufacturer: HUIZHOU BYD ELECTRONIC CO.,LTD Model: HW-050100B01



Adapter 3	Manufacturer: DONGGUAN PHITEK ELECTRONICS CO.,LTD Model: HW-050100B01
Adapter 4	Manufacturer: SHENZHEN HUNTKEY ELECTRIC CO.,LTD Model: HW-050100U01
Adapter 5	Manufacturer: HUIZHOU BYD ELECTRONIC CO.,LTD Model: HW-050100U01
Adapter 6	Manufacturer: DONGGUAN PHITEK ELECTRONICS CO.,LTD Model: HW-050100U01
Battery	Manufacturer: Harbin Coslight Power Co., Ltd. Model: HB3080G1EBC
USB Extend Cable 1	Manufacturer: HONGLIN TECHNOLOGY CO.,LTD Model: 130-26654, Length 1.0m, Shielded
USB Extend Cable 2	Manufacturer: FOXCONN INTERCONNECT TECHNOLOGY LIMITED Model: CUBB01M-HC208-DH, Length 1.0m, Shielded
USB Extend Cable 3	Manufacturer: Luxshare Precision Industry Co., Ltd Model: L99U2013-CS-H, Length 1.0m, Shielded
<p>Note: 1. The information of the EUT is declared by the manufacturer. 2. There is more than one Adapter and USB cable, each one should be applied throughout the compliance test respectively, and however, only the worst case (Adapter 1, USB cable 1) will be recorded in this report.</p>	

### 3. Applied Standards

According to the specifications of the manufacturer, it must comply with the requirements of the following standards:

#### Test standards

- **FCC CFR47 Part 15C (2018) Radio Frequency Devices**
- **ANSI C63.10 (2013)**
- **KDB 558074 D01 DTS Meas Guidance v04**



## 4. Test Configuration

### Test Mode

The EUT has been associated with peripherals and configuration operated in a manner tended to maximize its emission characteristics in a typical application.

The radiated emission was measured in the following position: EUT stand-up position (Z axis), lie-down position (X, Y axis). The worst emission was found in lie-down position (X axis) and the worst case was recorded.

In order to find the worst case condition, Pre-tests are needed at the presence of different data rate. Preliminary tests have been done on all the configuration for confirming worst case. Data rate below means worst-case rate of each test item.

### The test software is used CMD& QRCT

Worst-case data rates are shown as following table.

Band	Data Rate
Bluetooth(Low Energy)	1Mbps
802.11b	1 Mbps
802.11g	6 Mbps
802.11n HT20	MCS0

## 5. Test Case Results

### 5.1. Maximum conducted output power

#### Ambient condition

Temperature	Relative humidity	Pressure
23°C ~25°C	45%~50%	101.5kPa

#### Methods of Measurement

During the process of the testing, The EUT was connected to Average Power meter with a known loss. The EUT is max power transmission with proper modulation. The signal transmission is continuous.

#### Test Setup

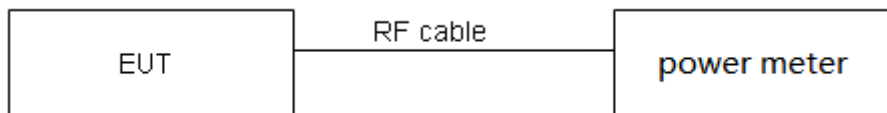

#### Limits

Rule Part 15.247 (b) (3) specifies that " For systems using digital modulation in the 902–928 MHz, 2400–2483.5 MHz: 1 Watt."

Average Output Power	$\leq 1W$ (30dBm)
----------------------	-------------------

#### Measurement Uncertainty

The assessed measurement uncertainty to ensure 95% confidence level for the normal distribution is with the coverage factor  $k = 2$ ,  $U = 0.44$  dB.

**Test Results**

Single Antenna Power Index			
Packet Type	CH1	CH6	CH11
802.11b	11	11	11
802.11g	11	11	11
802.11n HT20	11	11	11

Band	T <sub>on</sub> (ms)	T <sub>(on+off)</sub> (ms)	Duty cycle	Duty cycle correction Factor(dB)
802.11b	8.22	8.42	0.98	0.10
802.11g	1.36	1.56	0.87	0.60
802.11n HT20	1.28	1.48	0.86	0.63
BLE	0.39	0.62	0.622	2.064

Note: when Duty cycle>0.98, Duty cycle correction Factor not required.

Network Standards	Carrier frequency (MHz)	Average Power Measured (dBm)	Average Power with duty factor (dBm)	Limit (dBm)	Conclusion
802.11b	2412	10.45	10.55	30	PASS
	2437	9.55	9.65	30	PASS
	2462	9.11	9.21	30	PASS
802.11g	2412	9.61	10.21	30	PASS
	2437	9.24	9.84	30	PASS
	2462	9.37	9.97	30	PASS
802.11n HT20	2412	9.94	10.57	30	PASS
	2437	9.41	10.04	30	PASS
	2462	9.43	10.06	30	PASS
Bluetooth (Low Energy)	2402	2.81	4.87	30	PASS
	2440	2.99	5.05	30	PASS
	2480	0.24	2.30	30	PASS

Note: Average Power with duty factor = Average Power Measured +Duty cycle correction factor

## 5.2. 6dB Bandwidth

### Ambient condition

Temperature	Relative humidity	Pressure
23°C ~25°C	45%~50%	101.5kPa

### Method of Measurement

The EUT was connected to the spectrum analyzer through an external attenuator (20dB) and a known loss cable. RBW is set to 100 kHz; VBW is set to 300 kHz on spectrum analyzer. Dector=Peak, Trace mode=max hold.

### Test Setup

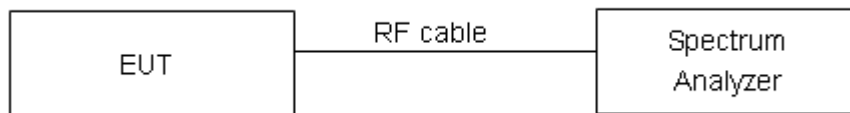

### Limits

Rule Part 15.247 (a) (2) specifies that “Systems using digital modulation techniques may operate in the 902–928 MHz, 2400–2483.5 MHz bands. The minimum 6 dB bandwidth shall be at least 500 kHz.”

minimum 6 dB bandwidth	≥ 500 kHz
------------------------	-----------

### Measurement Uncertainty

The assessed measurement uncertainty to ensure 95% confidence level for the normal distribution is with the coverage factor  $k = 2$ ,  $U = 936$  Hz.

**Test Results:**

Network Standards	Carrier frequency (MHz)	99% bandwidth (MHz)	Minimum 6 dB bandwidth (MHz)	Limit (kHz)	Conclusion
802.11b	2412	12.332	7.549	500	PASS
	2437	12.282	7.582	500	PASS
	2462	12.567	7.607	500	PASS
802.11g	2412	16.480	15.960	500	PASS
	2437	16.612	16.370	500	PASS
	2462	16.800	16.340	500	PASS
802.11n HT20	2412	17.627	17.300	500	PASS
	2437	17.748	17.340	500	PASS
	2462	17.834	17.350	500	PASS
Bluetooth (Low Energy)	2402	1.0863	0.7057	500	PASS
	2440	1.0859	0.7041	500	PASS
	2480	1.0869	0.7078	500	PASS

802.11b, Carrier frequency (MHz): 2412



802.11g, Carrier frequency (MHz): 2412



802.11b, Carrier frequency (MHz): 2437

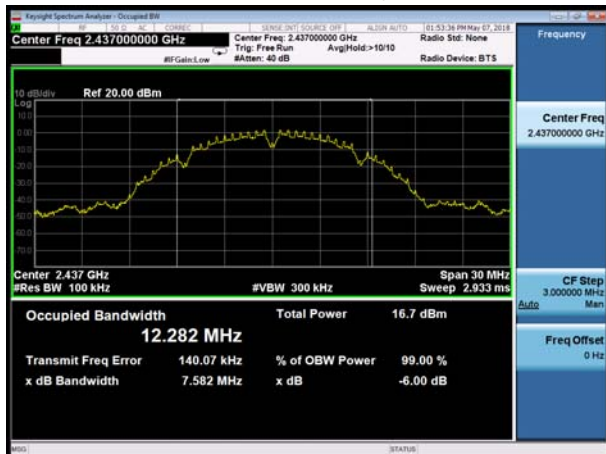

802.11g, Carrier frequency (MHz): 2437



802.11b, Carrier frequency (MHz): 2462



802.11g, Carrier frequency (MHz): 2462



802.11n(HT20), Carrier frequency (MHz): 2412



BLE Carrier frequency (MHz): 2402



802.11n(HT20), Carrier frequency (MHz): 2437

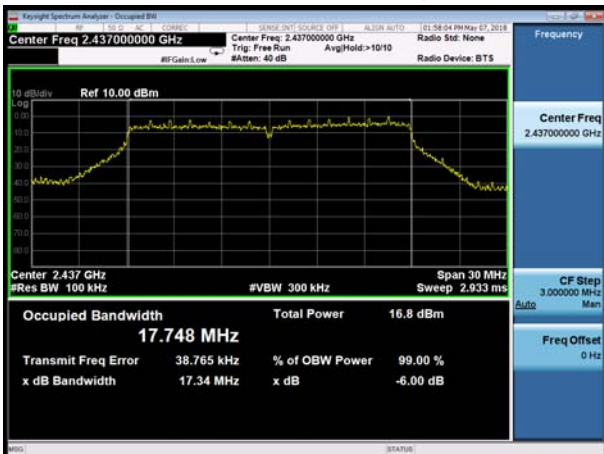

BLE Carrier frequency (MHz): 2440



802.11n(HT20), Carrier frequency (MHz): 2462



BLE Carrier frequency (MHz): 2480



### 5.3. Band Edge

#### Ambient condition

Temperature	Relative humidity	Pressure
23°C ~25°C	45%~50%	101.5kPa

#### Method of Measurement

The EUT was connected to the spectrum analyzer through an external attenuator (20dB) and a known loss cable the band edge of the lowest and highest channels were measured. The peak detector is used and RBW is set to 100 kHz and VBW is set to 300 kHz on spectrum analyzer. Spectrum analyzer plots are included on the following pages.

#### Test Setup

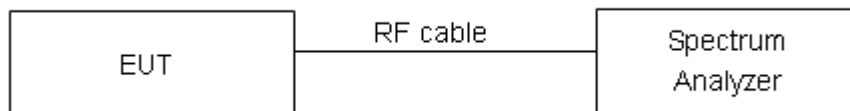

#### Limits

Rule Part 15.247(d) specifies that “In any 100 kHz bandwidth outside the frequency band in which the spread spectrum or digitally modulated intentional radiator is operating, the radio frequency power that is produced by the intentional radiator shall be at least 20 dB below that in the 100 kHz bandwidth within the band that contains the highest level of the desired power, based on either an RF conducted or a radiated measurement, provided the transmitter demonstrates compliance with the peak conducted power limits.” If the transmitter complies with the conducted power limits based on the use of RMS averaging over a time interval, as permitted under paragraph (b)(3) of this section, the attenuation required under this paragraph shall be 30 dB instead of 20 dB.”

#### Measurement Uncertainty

The assessed measurement uncertainty to ensure 95% confidence level for the normal distribution is with the coverage factor  $k = 1.96$ .

Frequency	Uncertainty
2GHz-3GHz	1.407 dB





Test Results: PASS

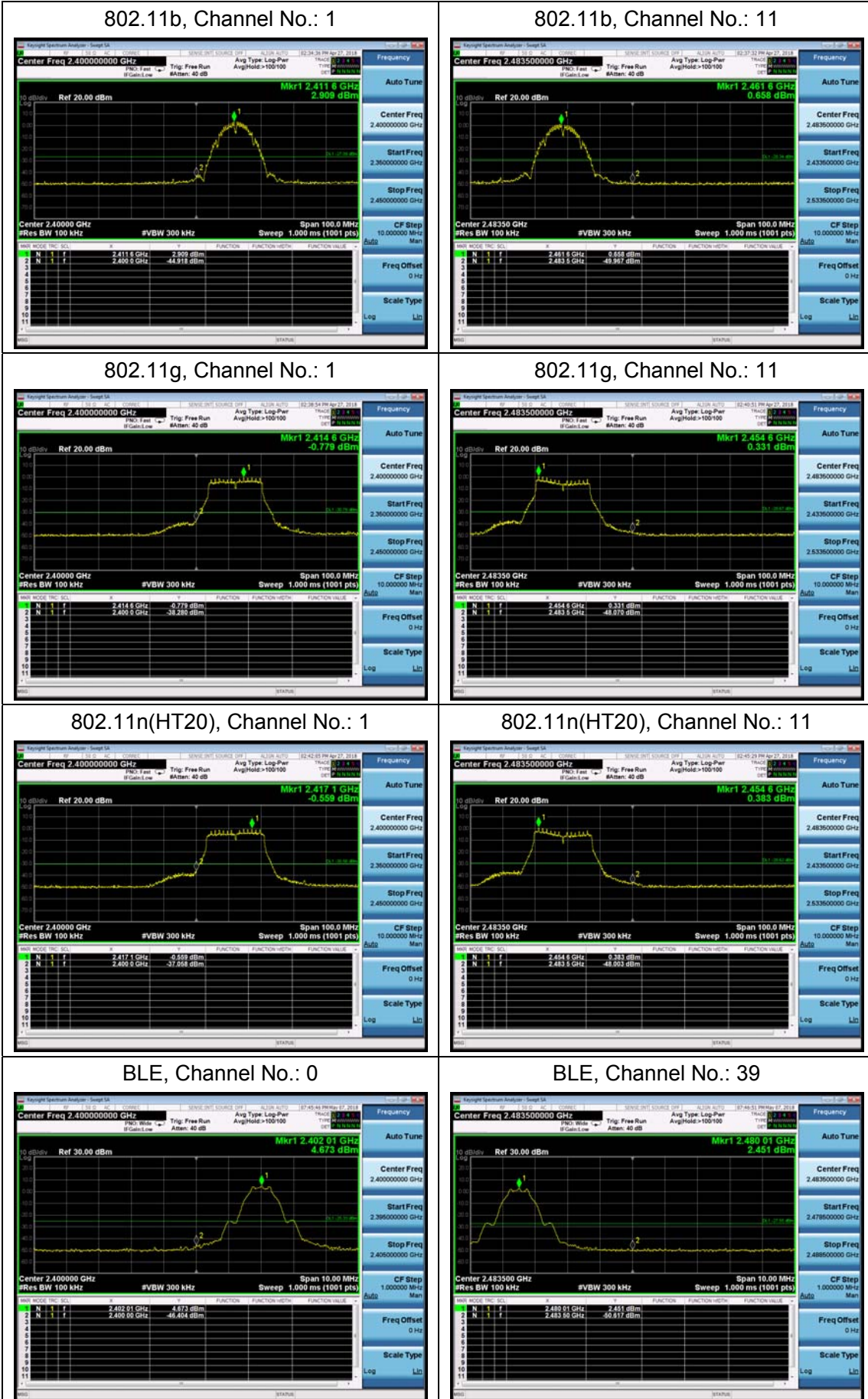

### 5.4. Power Spectral Density

#### Ambient condition

Temperature	Relative humidity	Pressure
23°C ~25°C	45%~50%	101.5kPa

#### Method of Measurement

During the process of the testing, The EUT was connected to Spectrum Analyzer with a known loss. The EUT is max power transmission with proper modulation. Method AVGPSD-2 in KDB558074 D01 was used for this test.

#### Test setup

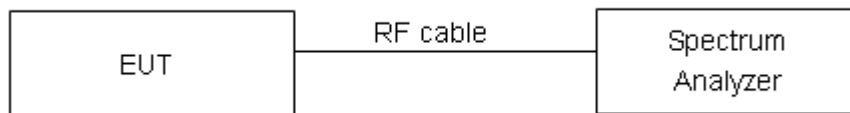

#### Limits

Rule Part 15.247(e) specifies that” For digitally modulated systems, the power spectral density conducted from the intentional radiator to the antenna shall not be greater than 8 dBm in any 3 kHz band during any time interval of continuous transmission. ”

Limits	≤ 8 dBm / 3kHz
--------	----------------

#### Measurement Uncertainty

The assessed measurement uncertainty to ensure 95% confidence level for the normal distribution is with the coverage factor  $k = 2$ ,  $U = 0.75\text{dB}$ .

**Test Results:**

Network Standards	Channel Number	Read Value (dBm / 3kHz)	Power Spectral Density (dBm / 3kHz)	Limit (dBm / 3kHz)	Conclusion
802.11b	1	-21.19	-21.09	8	PASS
	6	-22.21	-22.11	8	PASS
	11	-23.30	-23.19	8	PASS
802.11g	1	-24.52	-23.93	8	PASS
	6	-24.97	-24.37	8	PASS
	11	-24.80	-24.21	8	PASS
802.11n HT20	1	-24.91	-24.28	8	PASS
	6	-25.13	-24.50	8	PASS
	11	-24.96	-24.33	8	PASS
Bluetooth (Low Energy)	0	-13.88	-11.81	8	PASS
	19	-13.40	-11.33	8	PASS
	39	-16.01	-13.94	8	PASS

Note: Power Spectral Density =Read Value+Duty cycle correction factor

802.11b, Channel No.: 1



802.11g, Channel No.: 1



802.11b, Channel No.: 6



802.11g, Channel No.: 6

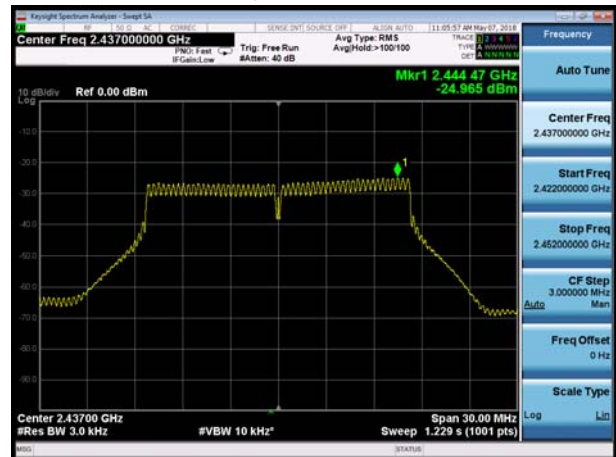

802.11b, Channel No.: 11



802.11g, Channel No.: 11





802.11n(HT20), Channel No. 1

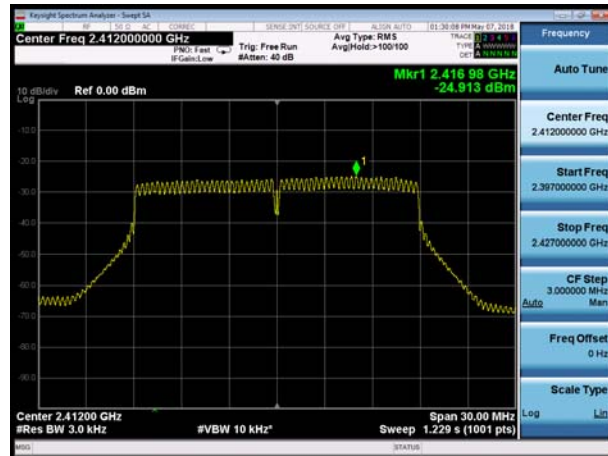

BLE, Channel No.: 0

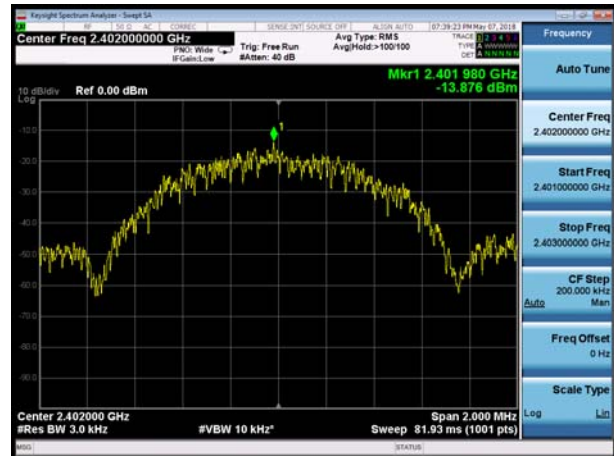

802.11n(HT20), Channel No. 6



BLE, Channel No.: 19

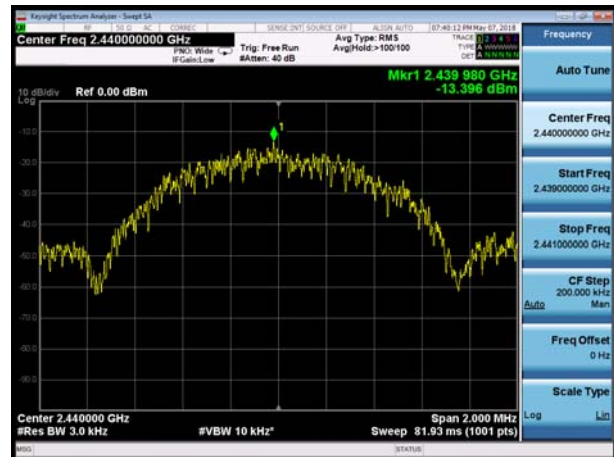

802.11n(HT20), Channel No. 11

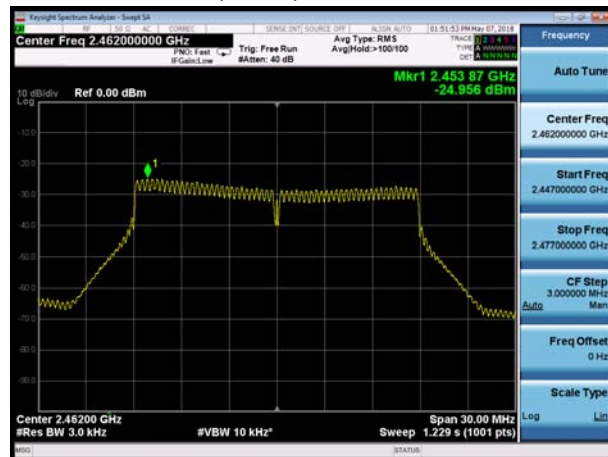

BLE, Channel No.: 39

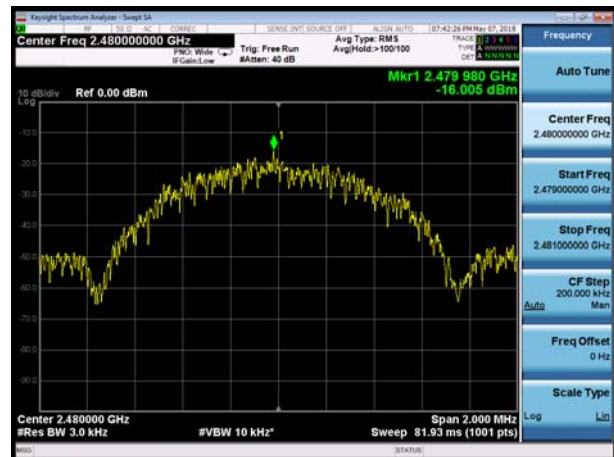

### 5.5. Spurious RF Conducted Emissions

**Ambient condition**

Temperature	Relative humidity	Pressure
23°C ~25°C	45%~50%	101.5kPa

**Method of Measurement**

The EUT was connected to the spectrum analyzer with a known loss. The spectrum analyzer scans from 30MHz to the 10th harmonic of the carrier. The peak detector is used. Set RBW to100kHz and VBW to 300 kHz, Sweep is set to ATUO.

The test is in transmitting mode.

**Test setup**



**Limits**

Rule Part 15.247(d) pacifies that “In any 100 kHz bandwidth outside the frequency band in which the spread spectrum intentional radiator is operating, the radio frequency power that is produced by the intentional radiator shall be at least 30 dB below that in the 100 kHz bandwidth within the band that contains the highest level of the desired power.” If the transmitter complies with the conducted power limits based on the use of RMS averaging over a time interval, as permitted under paragraph (b)(3) of this section, the attenuation required under this paragraph shall be 30 dB instead of 20 dB.”

Network Standards	Carrier frequency (MHz)	Reference value (dBm)	Limit
802.11b	2412	2.30	-27.70
	2437	1.60	-28.40
	2462	0.29	-29.71
802.11g	2412	-1.66	-31.66
	2437	-2.29	-32.29
	2462	-0.19	-30.19
802.11n HT20	2412	-1.85	-31.85
	2437	-1.42	-31.42
	2462	-0.24	-30.24
Bluetooth (Low Energy)	2402	4.02	-25.98
	2440	4.68	-25.32
	2480	1.63	-28.37

**Measurement Uncertainty**

The assessed measurement uncertainty to ensure 95% confidence level for the normal distribution is with the coverage factor  $k = 1.96$ .

Frequency	Uncertainty
100kHz-2GHz	0.684 dB
2GHz-26GHz	1.407 dB



Test Results:

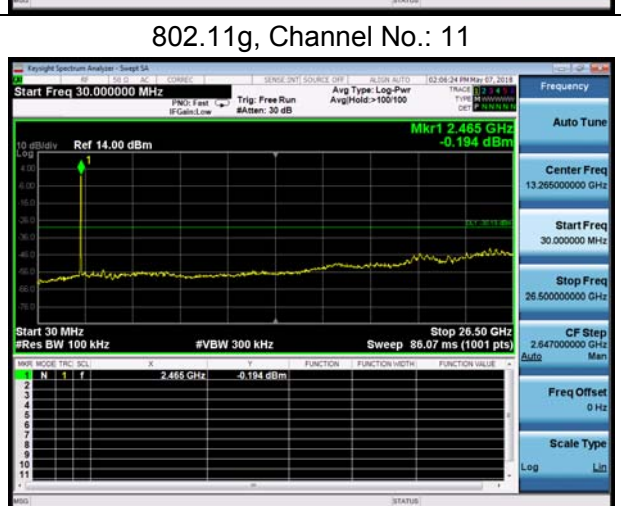
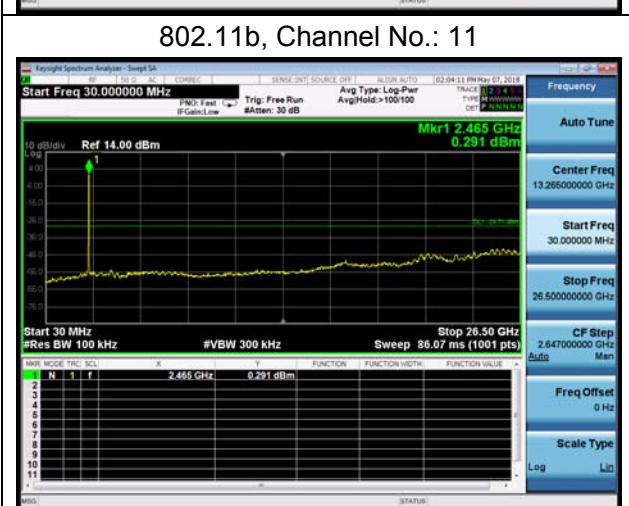
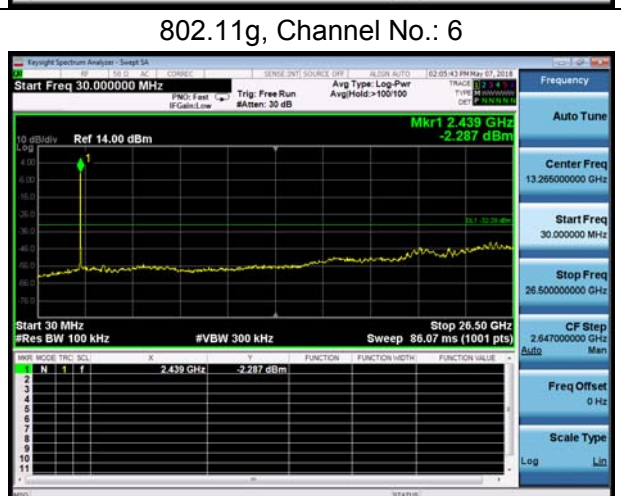
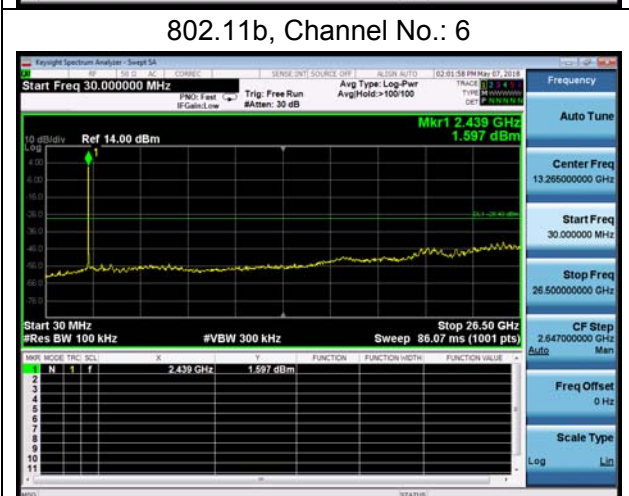
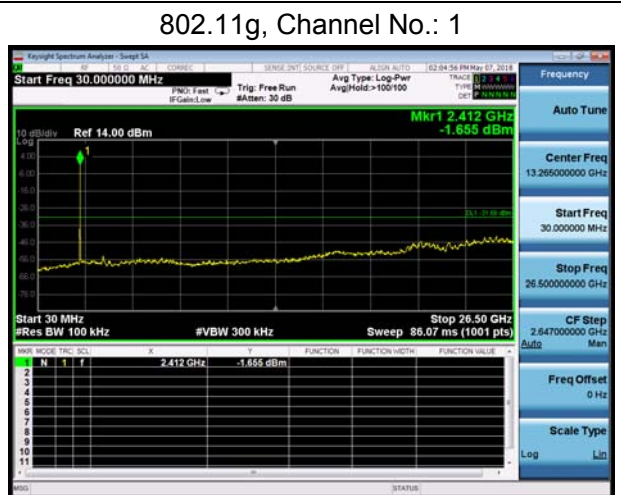
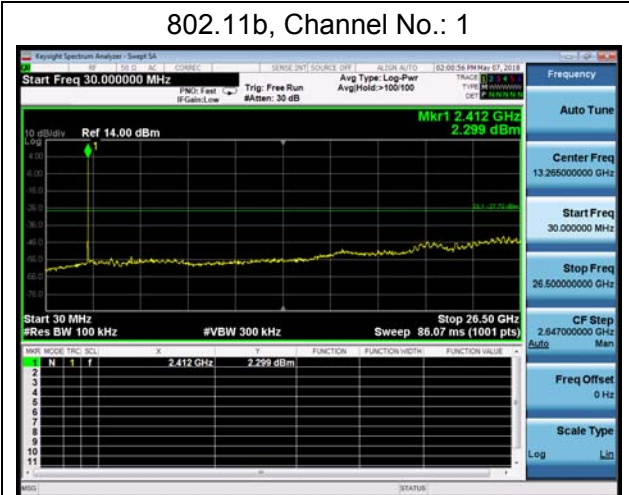



802.11n(HT20), Channel No. 1

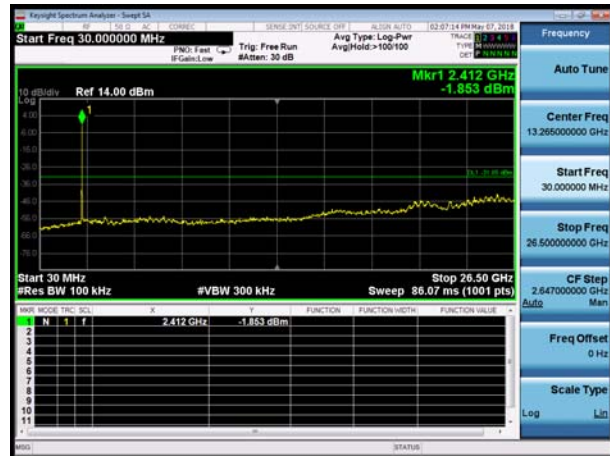

BLE CH 0

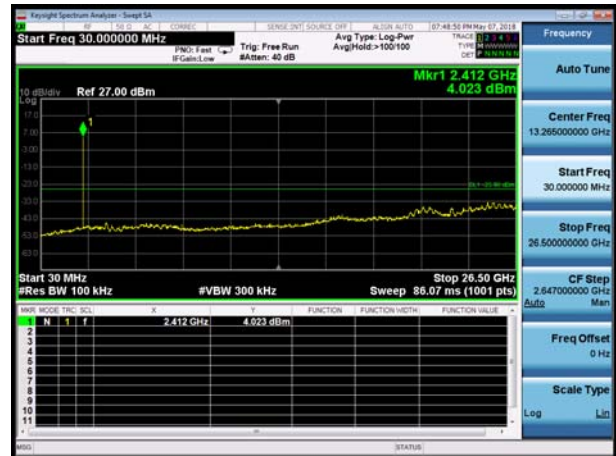

802.11n(HT20), Channel No. 6

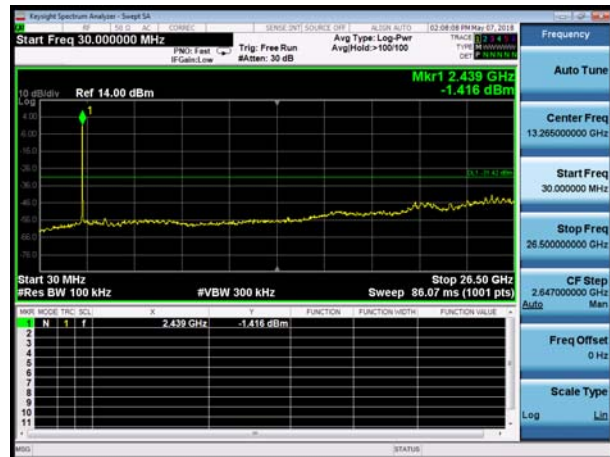

BLE CH 19

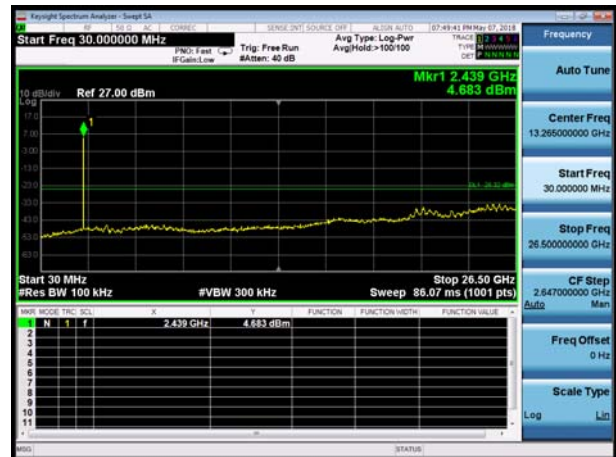

802.11n(HT20), Channel No. 11

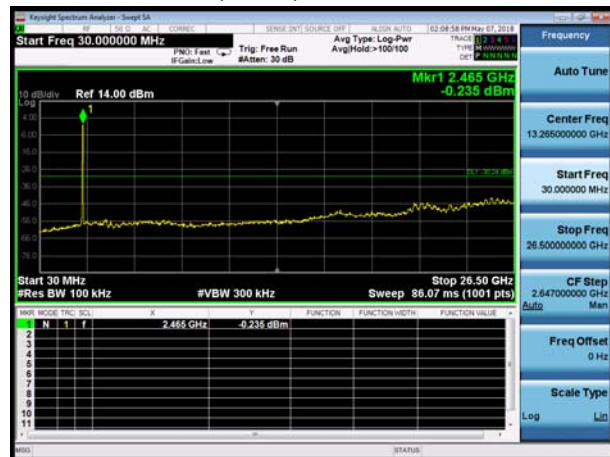

BLE CH 39

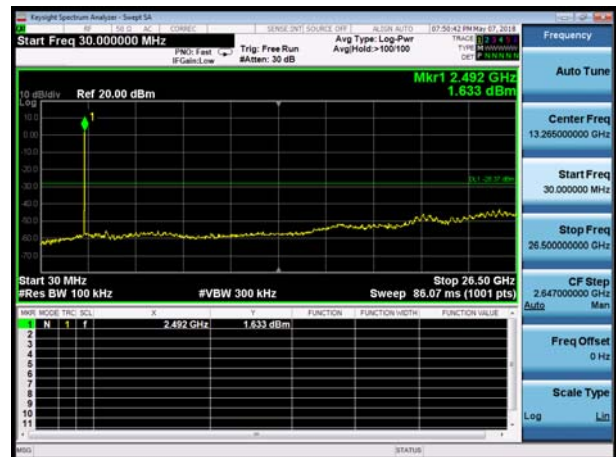

## 5.6. Radiated Emissions in the Restricted Band

### Ambient condition

Temperature	Relative humidity	Pressure
23°C ~25°C	45%~50%	101.5kPa

### Method of Measurement

The Equipment Under Test (EUT) was set up on a non-conductive table in the semi-anechoic chamber. The test was performed at the distance of 3 m between the EUT and the receiving antenna. The turntable shall be rotated from 0 to 360 degrees for detecting the maximum of radiated spurious signal level. The measurements shall be repeated with orthogonal polarization of the test antenna. The data of cable loss and antenna factor has been calibrated in full testing frequency range before the testing. Sweep the Restricted Band and the emissions less than 20 dB below the permissible value are reported.

This method refer to KDB 558074.

The procedure for peak unwanted emissions measurements above 1000 MHz is as follows:

I) Peak emission levels are measured by setting the instrument as follows:

- 1) RBW = 1 MHz.
- 2) VBW  $\geq$  [3  $\times$  RBW]
- 3) Detector = peak.
- 4) Sweep time = auto.
- 5) Trace mode = max hold.
- 6) Allow sweeps to continue until the trace stabilizes. Note that if the transmission is not continuous, then the time required for the trace to stabilize will increase by a factor of approximately 1 / D, where D is the duty cycle.

II) Average emission levels are measured by setting the instrument as follows:

- a) RBW = 1 MHz.
- b) VBW  $\geq$  [3  $\times$  RBW].
- c) Detector = RMS (power averaging), if [span / (# of points in sweep)]  $\leq$  RBW / 2. Satisfying this condition can require increasing the number of points in the sweep or reducing the span. If the condition is not satisfied, then the detector mode shall be set to peak.
- d) Averaging type = power (i.e., rms) (As an alternative, the detector and averaging type may be set for linear voltage averaging. Some instruments require linear display mode to use linear voltage averaging. Log or dB averaging shall not be used.)
- e) Sweep time = auto.
- f) Perform a trace average of at least 100 traces if the transmission is continuous. If the transmission is not continuous, then the number of traces shall be increased by a factor of 1 / D, where D is the duty cycle. For example, with 50% duty cycle, at least 200 traces shall be averaged. (If a specific emission is demonstrated to be continuous—i.e., 100% duty cycle—then rather than turning ON and OFF with the transmit cycle, at least 100 traces shall be averaged.)
- g) If tests are performed with the EUT transmitting at a duty cycle less than 98%, then a correction

factor shall be added to the measurement results prior to comparing with the emission limit, to compute the emission level that would have been measured had the test been performed at 100% duty cycle. The correction factor is computed as follows:

- 1) If power averaging (rms) mode was used in the preceding step e), then the correction factor is  $[10 \log (1 / D)]$ , where D is the duty cycle. For example, if the transmit duty cycle was 50%, then 3 dB shall be added to the measured emission levels.
- 2) If linear voltage averaging mode was used in the preceding step e), then the correction factor is  $[20 \log (1 / D)]$ , where D is the duty cycle. For example, if the transmit duty cycle was 50%, then 6 dB shall be added to the measured emission levels.
- 3) If a specific emission is demonstrated to be continuous (100% duty cycle) rather than turning ON and OFF with the transmit cycle, then no duty cycle correction is required for that emission.

The field strength of spurious emission was measured in the following position: EUT stand-up position (Z axis), lie-down position (X, Y axis). The worst emission was found in lie-down position (X axis) and the antenna is vertical.

The test is in transmitting mode.

**Test setup**

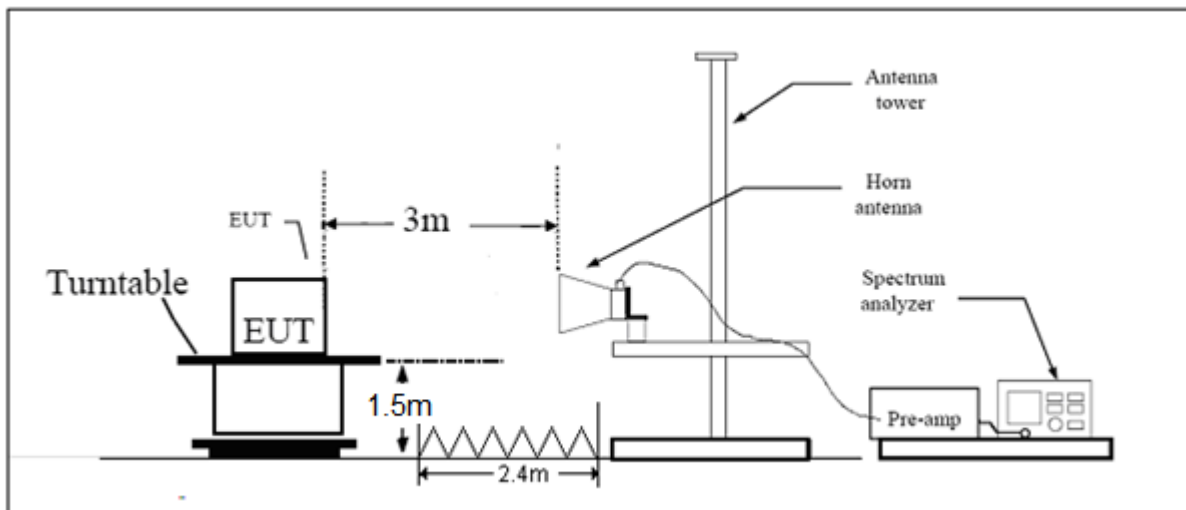

Note: Area side: 2.4mX3.6m

**Limits**

Spurious Radiated Emissions are permitted in any of the frequency bands listed below:



MHz	MHz	MHz	GHz
0.090 - 0.110	16.42 - 16.423	399.9 - 410	4.5 - 5.15
0.495 - 0.505	16.69475 - 16.69525	608 - 614	5.35 - 5.46
2.1735 - 2.1905	16.80425 - 16.80475	960 - 1240	7.25 - 7.75
4.125 - 4.128	25.5 - 25.67	1300 - 1427	8.025 - 8.5
4.17725 - 4.17775	37.5 - 38.25	1435 - 1626.5	9.0 - 9.2
4.20725 - 4.20775	73 - 74.6	1645.5 - 1646.5	9.3 - 9.5
6.215 - 6.218	74.8 - 75.2	1660 - 1710	10.6 - 12.7
6.26775 - 6.26825	108 - 121.94	1718.8 - 1722.2	13.25 - 13.4
6.31175 - 6.31225	123 - 138	2200 - 2300	14.47 - 14.5
8.291 - 8.294	149.9 - 150.05	2310 - 2390	15.35 - 16.2
8.362 - 8.366	156.52475 - 156.52525	2483.5 - 2500	17.7 - 21.4
8.37625 - 8.38675	156.7 - 156.9	2690 - 2900	22.01 - 23.12
8.41425 - 8.41475	162.0125 - 167.17	3260 - 3267	23.6 - 24.0
12.29 - 12.293	167.72 - 173.2	3332 - 3339	31.2 - 31.8
12.51975 - 12.52025	240 - 285	3345.8 - 3358	36.43 - 36.5
12.57675 - 12.57725	322 - 335.4	3600 - 4400	( <sup>2</sup> )
13.36 - 13.41			

Limit in restricted band

Frequency of emission (MHz)	Field strength(uV/m)	Field strength(dBuV/m)
30-88	100	40
88-216	150	43.5
216-960	200	46
Above960	500	54

#### §15.35(b)

There is also a limit on the radio frequency emissions, as measured using instrumentation with a peak detector function, corresponding to 20 dB above the maximum permitted average limit.

Peak Limit=74 dBuV/m

Average Limit=54 dBuV/m

#### Measurement Uncertainty

The assessed measurement uncertainty to ensure 95% confidence level for the normal distribution is with the coverage factor  $k = 1.96$ ,  $U = 3.55$  dB.

**Test Results:**

Band	T <sub>on</sub> (ms)	T <sub>(on+off)</sub> (ms)	Duty cycle	Duty cycle correction Factor(dB)
802.11b	8.22	8.42	0.98	0.10
802.11g	1.36	1.56	0.87	0.60
802.11n HT20	1.28	1.48	0.86	0.63
BLE	0.39	0.62	0.622	2.064

Note: when Duty cycle>0.98, Duty cycle correction Factor not required.

**802.11b-Channel 1**

Frequency (MHz)	Peak (dBuV/m)	Average (dBuV/m)	Height (cm)	Polarization	Azimuth (deg)	Duty cycle correction Factor(dB)	conclusion value (dBuV/m)	Margin (dB)	Limit (dBuV/m)
2390	42.749	--	200.0	V	135	0.10	42.849	31.151	74
2390	--	32.303	200.0	V	135	0.10	32.403	21.597	54

**802.11b-Channel 11**

Frequency (MHz)	Peak (dBuV/m)	Average (dBuV/m)	Height (cm)	Polarization	Azimuth (deg)	Duty cycle correction Factor(dB)	conclusion value (dBuV/m)	Margin (dB)	Limit (dBuV/m)
2483.5	42.517	--	200.0	V	135	0.10	42.617	31.383	74
2483.5	--	30.695	200.0	V	135	0.10	30.795	23.205	54

**802.11g-Channel 1**

Frequency (MHz)	Peak (dBuV/m)	Average (dBuV/m)	Height (cm)	Polarization	Azimuth (deg)	Duty cycle correction Factor(dB)	conclusion value (dBuV/m)	Margin (dB)	Limit (dBuV/m)
2390	46.194	--	150	V	65	0.60	46.794	27.206	74
2390	--	40.150	150	V	65	0.60	40.750	13.250	54

**802.11g-Channel 11**

Frequency (MHz)	Peak (dBuV/m)	Average (dBuV/m)	Height (cm)	Polarization	Azimuth (deg)	Duty cycle correction Factor(dB)	conclusion value (dBuV/m)	Margin (dB)	Limit (dBuV/m)
2483.5	55.104	--	150	V	78	0.60	55.704	18.296	74
2483.5	--	37.268	150	V	78	0.60	37.868	16.132	54

**802.11n HT20 -Channel 1**

Frequency (MHz)	Peak (dBuV/m)	Average (dBuV/m)	Height (cm)	Polarization	Azimuth (deg)	Duty cycle correction Factor(dB)	conclusion value (dBuV/m)	Margin (dB)	Limit (dBuV/m)
2390	61.306	--	200	V	90	0.63	61.936	12.064	74
2390	--	39.776	200	V	90	0.63	40.406	13.594	54

**802.11n HT20-Channel 11**

Frequency (MHz)	Peak (dBuV/m)	Average (dBuV/m)	Height (cm)	Polarization	Azimuth (deg)	Duty cycle correction Factor(dB)	conclusion value (dBuV/m)	Margin (dB)	Limit (dBuV/m)
2483.5	50.877	--	200	V	90	0.63	51.507	22.493	74
2483.5	--	34.396	200	V	90	0.63	35.026	18.974	54

**BLE Channel 0**

Frequency (MHz)	Peak (dBuV/m)	Average (dBuV/m)	Height (cm)	Polarization	Azimuth (deg)	Duty cycle correction Factor(dB)	conclusion value (dBuV/m)	Margin (dB)	Limit (dBuV/m)
2390	39.174	--	200.0	V	135	2.064	41.238	32.762	74
2390	--	29.876	200.0	V	135	2.064	31.940	22.060	54

**BLE Channel 39**

Frequency (MHz)	Peak (dBuV/m)	Average (dBuV/m)	Height (cm)	Polarization	Azimuth (deg)	Duty cycle correction Factor(dB)	conclusion value (dBuV/m)	Margin (dB)	Limit (dBuV/m)
2483.5	45.418	--	200.0	V	135	2.064	47.482	26.518	74
2483.5	--	41.425	200.0	V	135	2.064	43.489	10.511	54

## 5.7. Radiates Emission

### Ambient condition

Temperature	Relative humidity	Pressure
23°C ~25°C	45%~50%	102.5kPa

### Method of Measurement

The test set-up was made in accordance to the general provisions of ANSI C63.10-2013. The Equipment Under Test (EUT) was set up on a non-conductive table in the semi-anechoic chamber. The test was performed at the distance of 3 m between the EUT and the receiving antenna. The radiated emissions measurements were made in a typical installation configuration.

Sweep the whole frequency band through the range from 9 kHz to the 10th harmonic of the carrier, and the emissions less than 20 dB below the permissible value are reported.

During the test, below 30MHz, the center of the loop shall be 1 meters; above 30MHz, the height of receive antenna shall be moved from 1 to 4 meters, and the antenna shall be performed under horizontal and vertical polarization. The turntable shall be rotated from 0 to 360 degrees for detecting the maximum of radiated spurious signal level. The measurements shall be repeated with orthogonal polarization of the test antenna. The data of cable loss and antenna factor has been calibrated in full testing frequency range before the testing.

Set the spectrum analyzer in the following:

Below 1GHz (detector: Peak and Quasi-Peak)

RBW=100 kHz / VBW=300 kHz / Sweep=AUTO

Above 1GHz (detector: Peak):

(a) PEAK: RBW=1MHz / VBW=3MHz/ Sweep=AUTO

(b) AVERAGE: RBW=1MHz / VBW=10Hz, when duty cycle is not less than 98%

VBW $\geq$ 1/T when duty cycle is less than 98%, where T is transmit on time

Sweep=AUTO

The radiated emission was measured in the following position: EUT stand-up position (Z axis), lie-down position (X, Y axis). The worst emission was found in lie-down position (X axis) and the worst case was recorded.

The test is in transmitting mode.

**Test setup**

**9KHz ~ 30MHz**

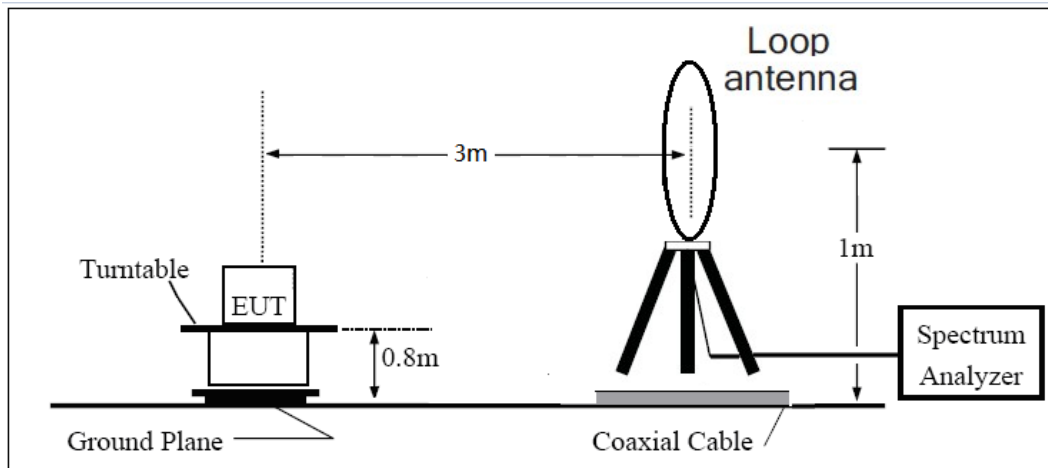

**30MHz ~ 1GHz**

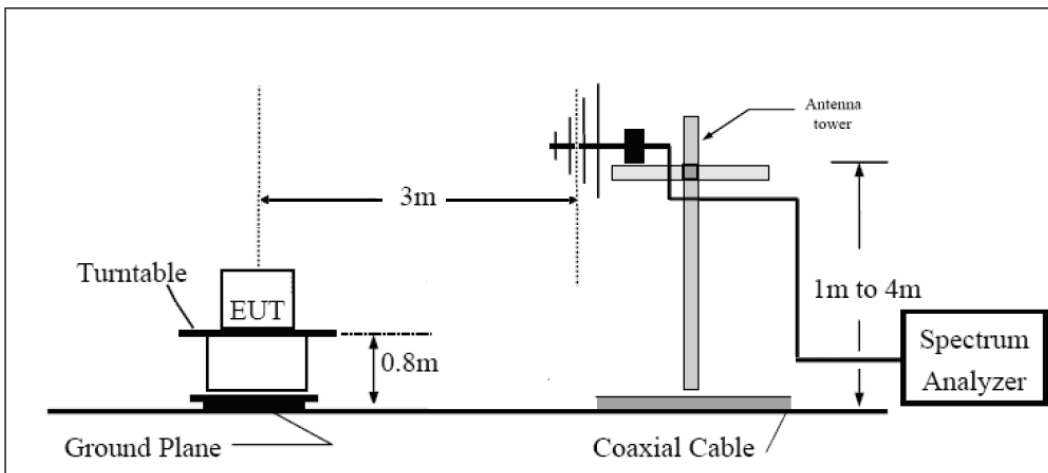

**Above 1GHz**

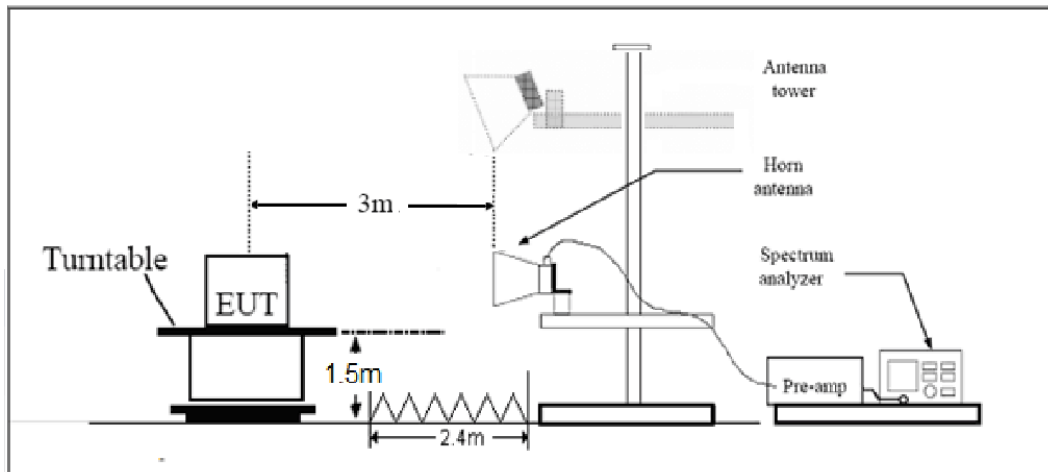

Note: Area side:2.4mX3.6m



**Limits**

Rule Part 15.247(d) specifies that “In addition, radiated emissions which fall in the restricted bands, as defined in § 15.205(a), must also comply with the radiated emission limits specified in § 15.209(a) (see § 15.205(c)).”

Limit in restricted band

Frequency of emission (MHz)	Field strength(uV/m)	Field strength(dBuV/m)
0.009–0.490	2400/F(kHz)	/
0.490–1.705	24000/F(kHz)	/
1.705–30.0	30	/
30-88	100	40
88-216	150	43.5
216-960	200	46
Above960	500	54

§15.35(b)

There is also a limit on the radio frequency emissions, as measured using instrumentation with a peak detector function, corresponding to 20 dB above the maximum permitted average limit.

**Measurement Uncertainty**

The assessed measurement uncertainty to ensure 95% confidence level for the normal distribution is with the coverage factor  $k = 1.96$ .

Frequency	Uncertainty
9KHz-30MHz	3.55 dB
30MHz-200MHz	4.19 dB
200MHz-1GHz	3.63 dB
Above 1GHz	3.68 dB

**Test result**

Sweep from 9 kHz to 30MHz, 18GHz to 26.5GHz and the emissions more than 20 dB below the permissible value are not reported.

The following graphs display the maximum values of horizontal and vertical by software.

For above 1GHz, Blue trace uses the peak detection, Green trace uses the average detection.

During the test, the Radiates Emission from 30MHz to 1GHz was performed in all modes with all channels, 802.11b, Channel 11 are selected as the worst condition. The test data of the worst-case condition was recorded in this report.

**Continuous TX mode:**

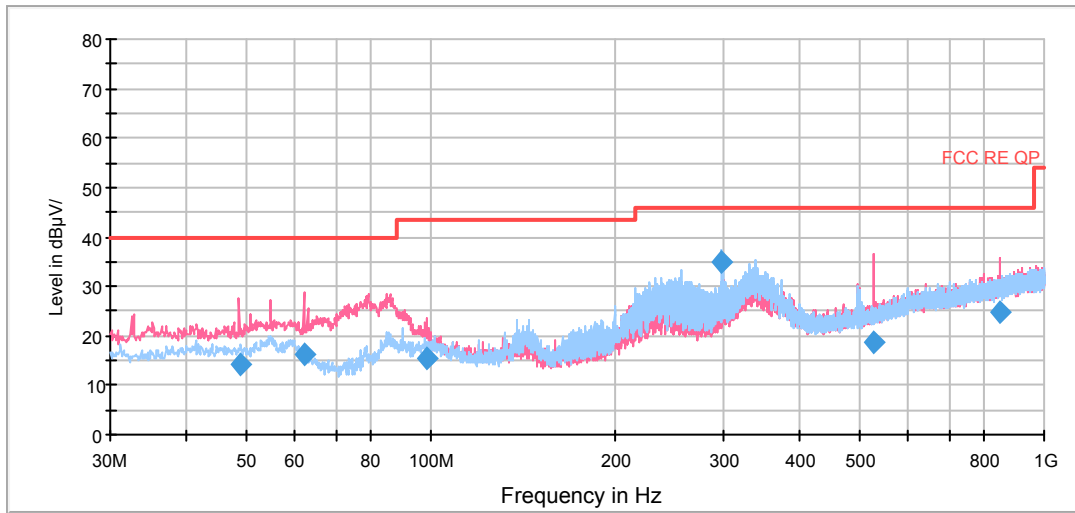

Radiates Emission from 30MHz to 1GHz

Frequency (MHz)	Quasi-Peak (dBuV/m)	Reading value (dBuV/m)	Height (cm)	Polarization	Azimuth (deg)	Correct Factor (dB)	Margin (dB)	Limit (dBuV/m)
48.792500	14.0	0.9	175.0	V	294.0	13.1	26.0	40.0
62.371250	16.3	4.7	175.0	V	322.0	11.6	23.7	40.0
98.143750	15.2	2.1	100.0	V	25.0	13.1	28.3	43.5
298.770000	34.9	19.5	100.0	H	351.0	15.4	11.1	46.0
527.977500	18.7	-2.5	188.0	V	338.0	21.2	27.3	46.0
845.735000	25.0	-1.0	217.0	V	319.0	26.0	21.0	46.0

- Remark:**
1. Quasi-Peak = Reading value + Correction factor
  2. Correction Factor = Antenna factor+ Insertion loss(cable loss+amplifier gain)
  3. Margin = Limit – Quasi-Peak

802.11b CH1

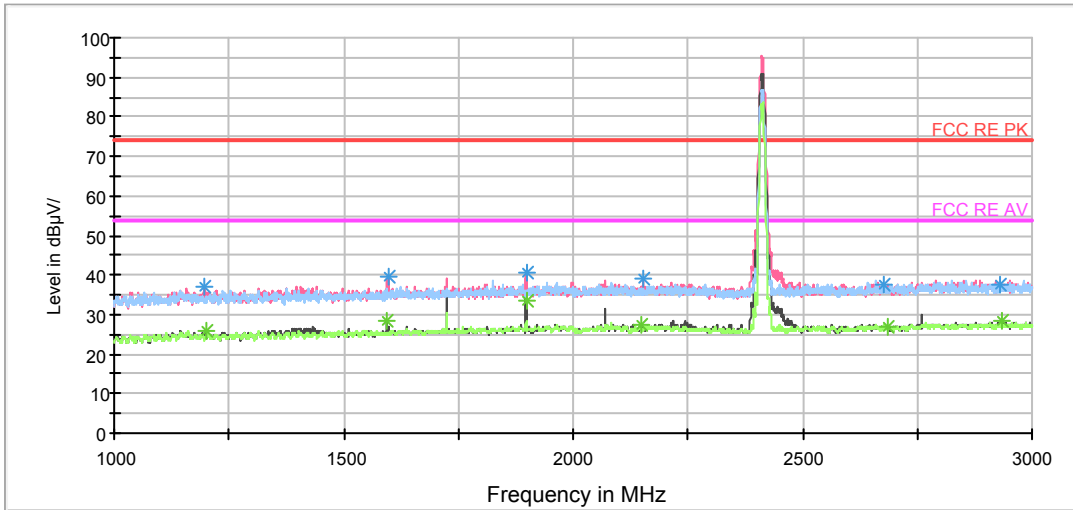

Note: The signal beyond the limit is carrier.  
Radiates Emission from 1GHz to 3GHz

FCC RE 1G-18GHz PK+AV Class B

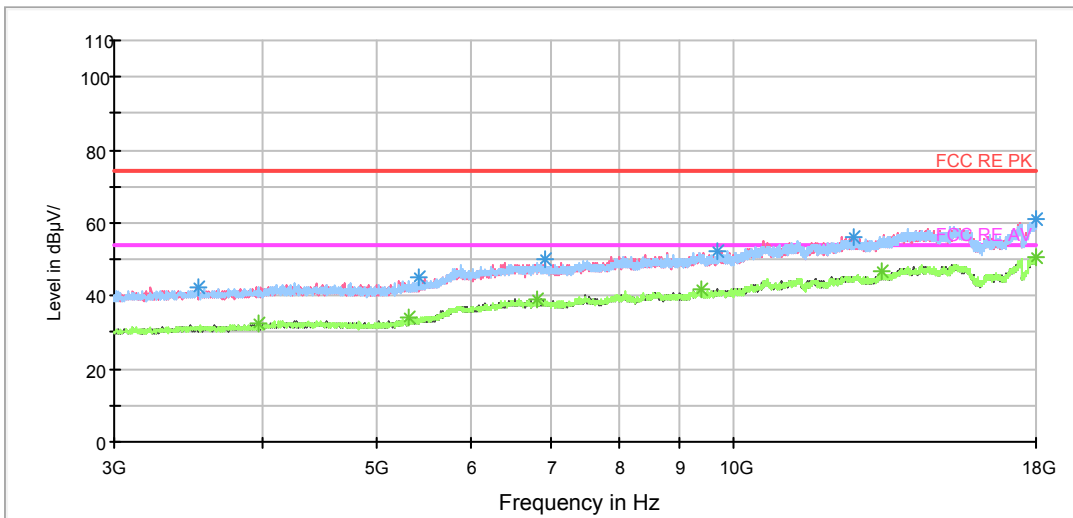

Radiates Emission from 3GHz to 18GHz



Frequency (MHz)	Peak (dBuV/m)	Height (cm)	Polarization	Azimuth (deg)	Reading value (dBuV/m)	Correct Factor (dB)	Margin (dB)	Limit (dBuV/m)
1196.500000	37.2	100.0	V	149.0	44.8	-7.6	36.8	74
1598.000000	39.6	100.0	V	273.0	45.9	-6.3	34.4	74
1897.500000	40.7	100.0	V	306.0	45.9	-5.2	33.3	74
2152.500000	38.9	100.0	V	356.0	43.1	-4.2	35.1	74
2676.000000	37.6	100.0	H	15.0	40.3	-2.7	36.4	74
2929.000000	37.8	100.0	V	345.0	40.3	-2.5	36.2	74

Remark: 1. Correction Factor = Antenna factor+ Insertion loss (cable loss + amplifier gain)

Frequency (MHz)	Average (dBuV/m)	Height (cm)	Polarization	Azimuth (deg)	Reading value (dBuV/m)	Correct Factor (dB)	Margin (dB)	Limit (dBuV/m)
1199.000000	26.1	100.0	V	357.0	33.7	-7.6	27.9	54
1593.500000	28.5	100.0	V	194.0	34.8	-6.3	25.5	54
1898.000000	33.7	100.0	V	306.0	38.9	-5.2	20.3	54
2148.000000	27.2	100.0	V	357.0	31.4	-4.2	26.8	54
2686.500000	27.0	100.0	V	137.0	29.7	-2.7	27.0	54
2933.500000	28.2	100.0	V	359.0	30.7	-2.5	25.8	54

Remark: 1. Correction Factor = Antenna factor+ Insertion loss (cable loss + amplifier gain)

802.11b CH6

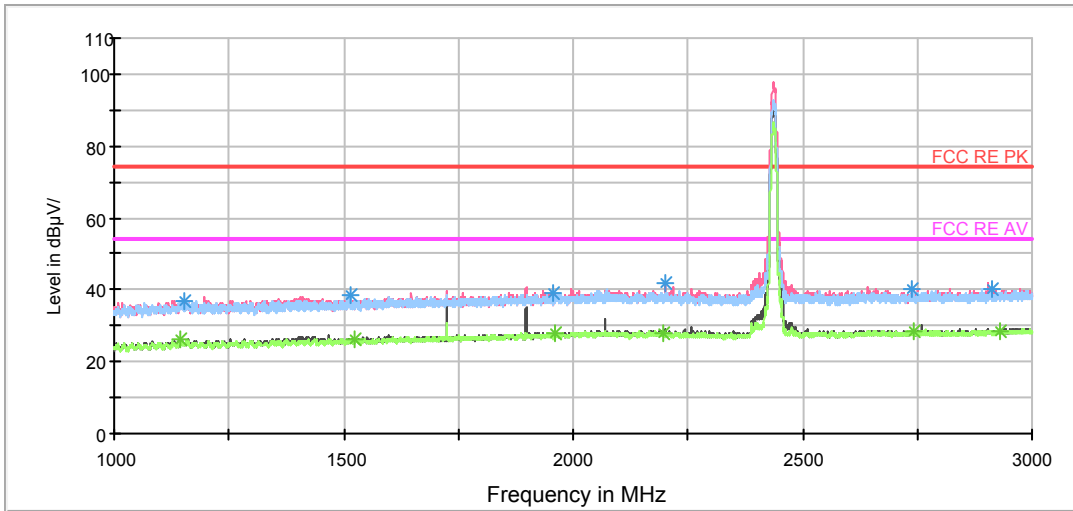

Note: The signal beyond the limit is carrier.

Radiates Emission from 1GHz to 3GHz

FCC RE 1G-18GHz PK+AV Class B

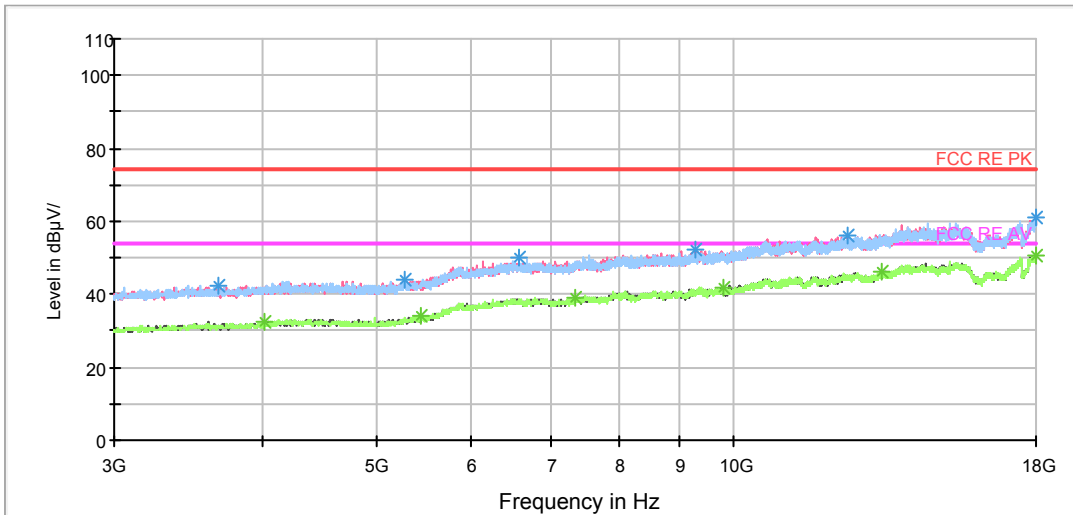

Radiates Emission from 3GHz to 18GHz



Frequency (MHz)	Peak (dBuV/m)	Height (cm)	Polarization	Azimuth (deg)	Reading value (dBuV/m)	Correct Factor (dB)	Margin (dB)	Limit (dBuV/m)
1150.750000	36.6	200.0	V	27.0	44.3	-7.7	37.4	74
1514.500000	38.5	200.0	H	262.0	45.1	-6.6	35.5	74
1958.250000	39.3	200.0	H	115.0	44.3	-5.0	34.7	74
2199.000000	41.6	200.0	V	65.0	45.6	-4.0	32.4	74
2736.500000	40.4	200.0	H	236.0	43.0	-2.6	33.6	74
2914.750000	40.3	100.0	V	0.0	42.8	-2.5	33.7	74

Remark: 1. Correction Factor = Antenna factor+ Insertion loss (cable loss + amplifier gain)

Frequency (MHz)	Average (dBuV/m)	Height (cm)	Polarization	Azimuth (deg)	Reading value (dBuV/m)	Correct Factor (dB)	Margin (dB)	Limit (dBuV/m)
1145.750000	26.3	200.0	V	119.0	34.0	-7.7	27.7	54
1525.500000	26.4	100.0	V	175.0	32.9	-6.5	27.6	54
1962.250000	28.0	200.0	V	161.0	32.9	-4.9	26.0	54
2195.750000	28.0	200.0	V	0.0	32.0	-4.0	26.0	54
2741.250000	28.5	200.0	V	218.0	31.1	-2.6	25.5	54
2928.250000	28.7	100.0	V	310.0	31.2	-2.5	25.3	54

Remark: 1. Correction Factor = Antenna factor+ Insertion loss (cable loss + amplifier gain)

802.11b CH11

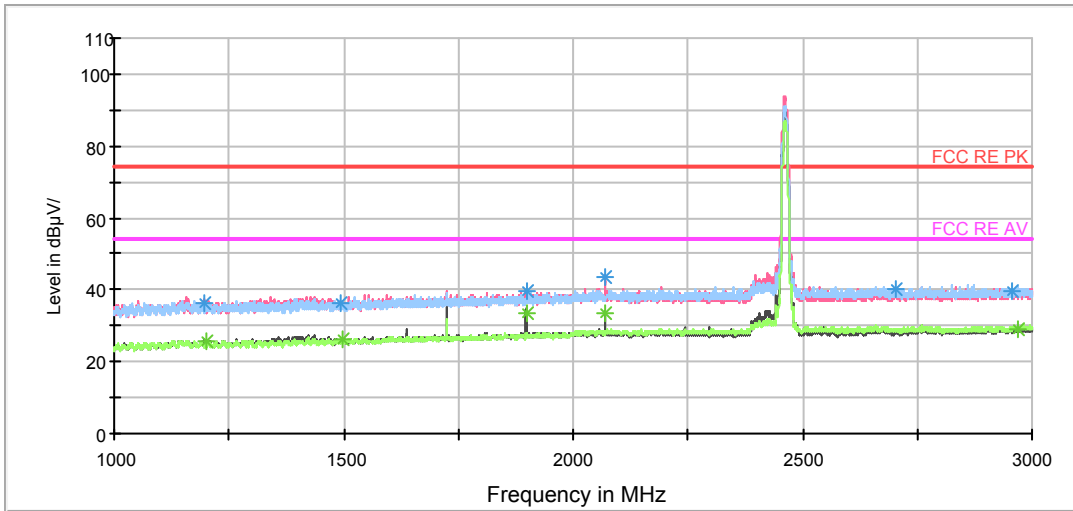

Note: The signal beyond the limit is carrier.

Radiates Emission from 1GHz to 3GHz

FCC RE 1G-18GHz PK+AV Class B

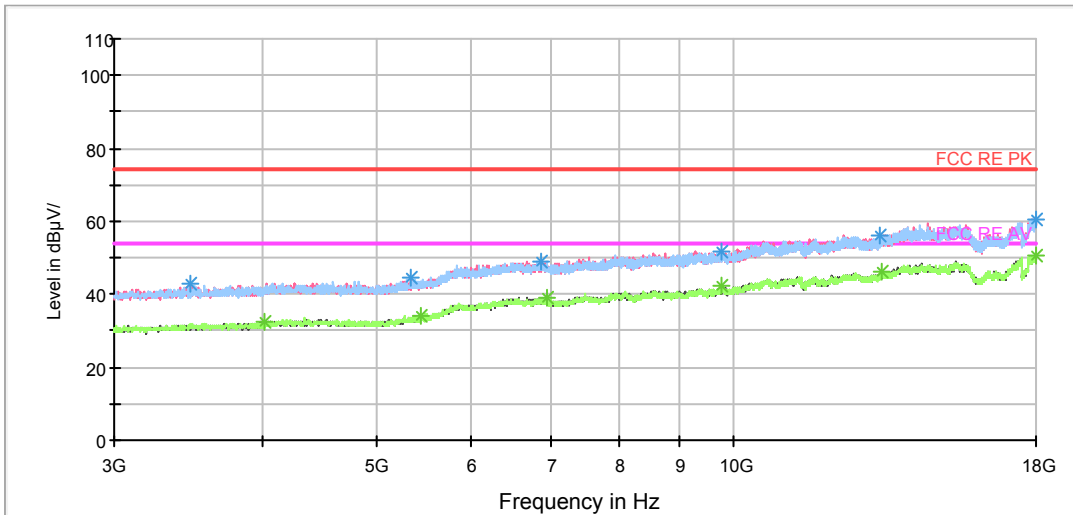

Radiates Emission from 3GHz to 18GHz



Frequency (MHz)	Peak (dBuV/m)	Height (cm)	Polarization	Azimuth (deg)	Reading value (dBuV/m)	Correct Factor (dB)	Margin (dB)	Limit (dBuV/m)
1196.250000	36.4	200.0	V	54.0	44.0	-7.6	37.6	74
1494.500000	36.3	100.0	V	85.0	43.0	-6.7	37.7	74
1897.750000	39.8	200.0	V	42.0	45.0	-5.2	34.2	74
2069.250000	43.3	100.0	V	70.0	47.8	-4.5	30.7	74
2701.250000	40.2	200.0	V	2.0	42.9	-2.7	33.8	74
2954.500000	39.8	200.0	H	293.0	42.3	-2.5	34.2	74

Remark: 1. Correction Factor = Antenna factor+ Insertion loss (cable loss + amplifier gain)

Frequency (MHz)	Average (dBuV/m)	Height (cm)	Polarization	Azimuth (deg)	Reading value (dBuV/m)	Correct Factor (dB)	Margin (dB)	Limit (dBuV/m)
1199.750000	25.9	100.0	V	351.0	33.5	-7.6	28.1	54
1496.500000	26.4	200.0	H	0.0	33.1	-6.7	27.6	54
1897.750000	33.4	100.0	V	255.0	38.6	-5.2	20.6	54
2069.750000	33.3	100.0	V	268.0	37.8	-4.5	20.7	54
2969.000000	29.1	100.0	V	0.0	31.6	-2.5	24.9	54

Remark: 1. Correction Factor = Antenna factor+ Insertion loss (cable loss + amplifier gain)



802.11g CH1

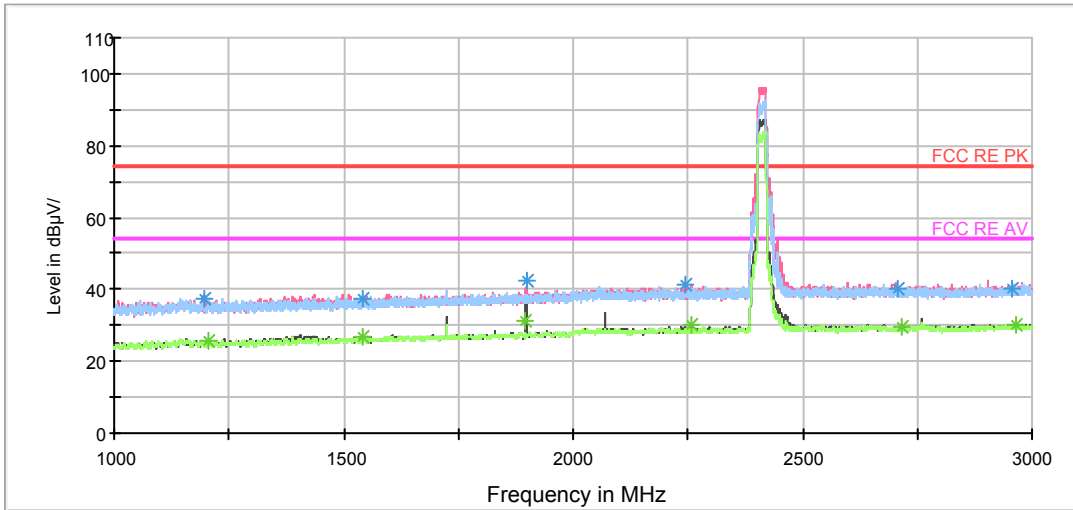

Note: The signal beyond the limit is carrier.  
Radiates Emission from 1GHz to 3GHz

FCC RE 1G-18GHz PK+AV Class B

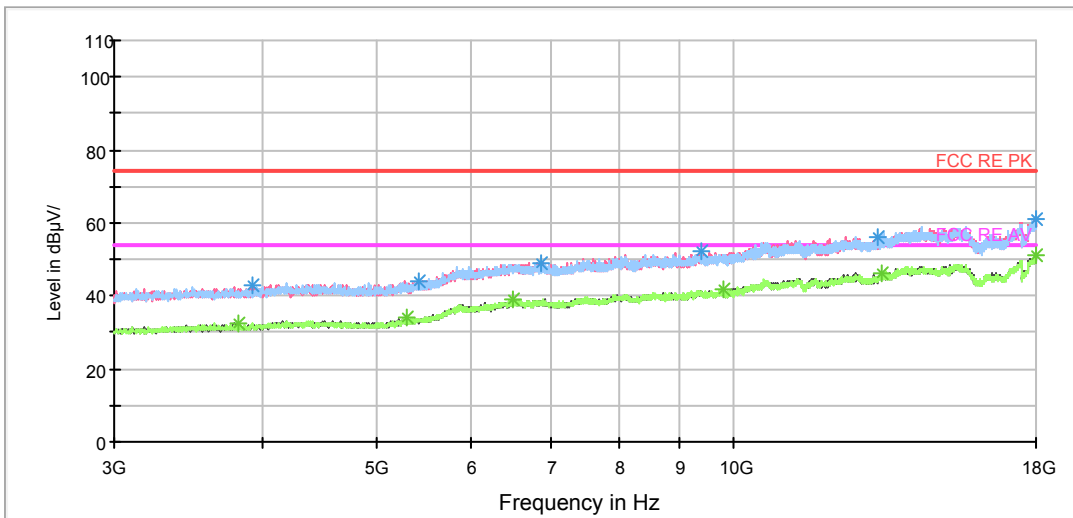

Radiates Emission from 3GHz to 18GHz



Frequency (MHz)	Peak (dBuV/m)	Height (cm)	Polarization	Azimuth (deg)	Reading value (dBuV/m)	Correct Factor (dB)	Margin (dB)	Limit (dBuV/m)
1196.500000	37.4	100.0	V	0.0	45.0	-7.6	36.6	74
1540.500000	37.7	200.0	V	99.0	44.2	-6.5	36.3	74
1897.750000	42.3	200.0	V	29.0	47.5	-5.2	31.7	74
2243.000000	41.5	100.0	V	341.0	45.3	-3.8	32.5	74
2707.250000	40.0	200.0	V	8.0	42.7	-2.7	34.0	74
2956.500000	40.1	100.0	V	198.0	42.6	-2.5	33.9	74

Remark: 1. Correction Factor = Antenna factor+ Insertion loss (cable loss + amplifier gain)

Frequency (MHz)	Average (dBuV/m)	Height (cm)	Polarization	Azimuth (deg)	Reading value (dBuV/m)	Correct Factor (dB)	Margin (dB)	Limit (dBuV/m)
1206.000000	25.6	200.0	V	2.0	33.1	-7.5	28.4	54
1543.000000	26.6	100.0	H	1.0	33.1	-6.5	27.4	54
1896.750000	31.3	200.0	V	29.0	36.5	-5.2	22.7	54
2256.250000	30.3	200.0	V	72.0	34.1	-3.8	23.7	54
2717.500000	29.4	200.0	V	11.0	32.1	-2.7	24.6	54
2964.250000	30.1	100.0	H	8.0	32.6	-2.5	23.9	54

Remark: 1. Correction Factor = Antenna factor+ Insertion loss (cable loss + amplifier gain)

802.11g CH6

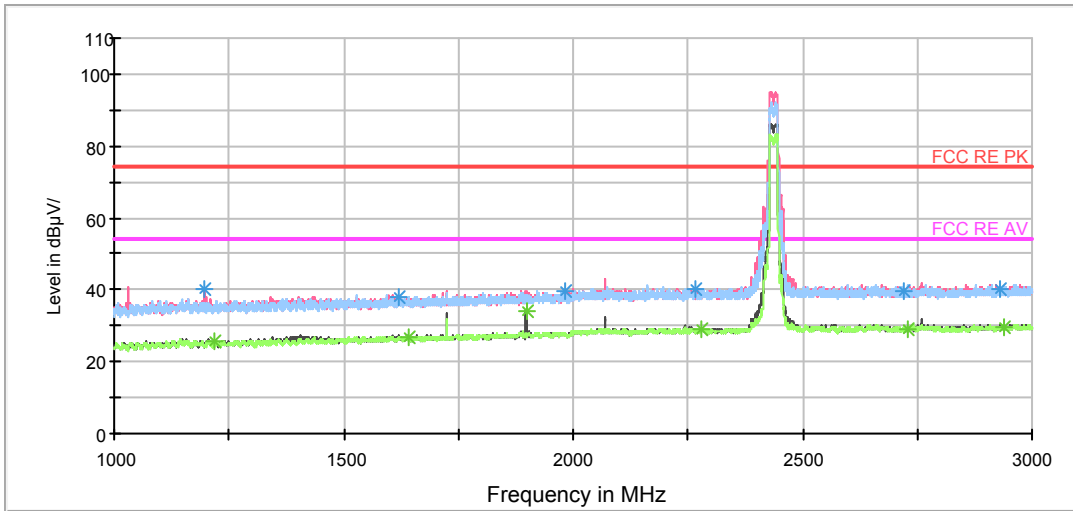

Note: The signal beyond the limit is carrier.

Radiates Emission from 1GHz to 3GHz

FCC RE 1G-18GHz PK+AV Class B

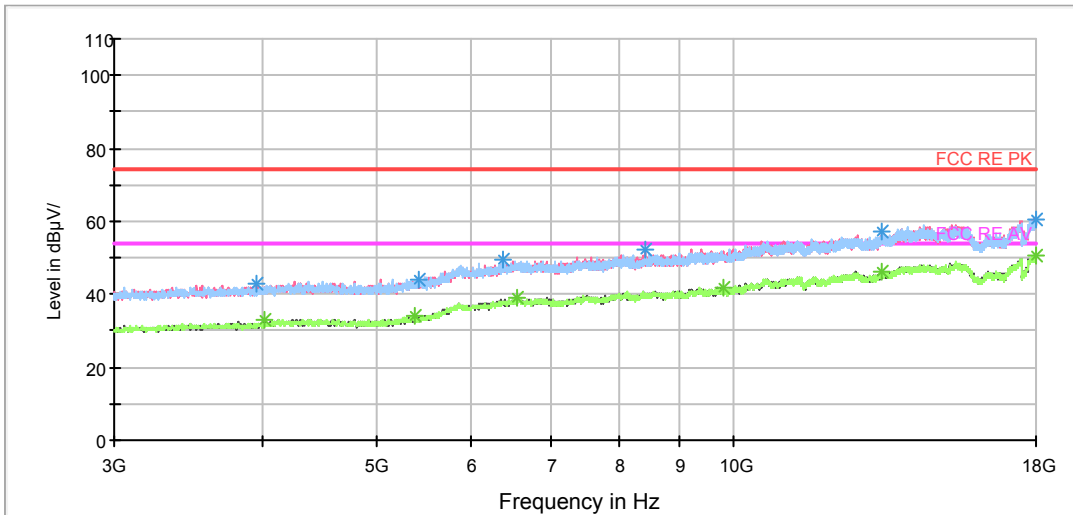

Radiates Emission from 3GHz to 18GHz



Frequency (MHz)	Peak (dBuV/m)	Height (cm)	Polarization	Azimuth (deg)	Reading value (dBuV/m)	Correct Factor (dB)	Margin (dB)	Limit (dBuV/m)
1198.500000	40.3	100.0	V	0.0	47.9	-7.6	33.7	74
1622.250000	38.2	100.0	V	354.0	44.4	-6.2	35.8	74
1981.750000	39.5	200.0	H	272.0	44.4	-4.9	34.5	74
2265.750000	40.4	200.0	V	161.0	44.1	-3.7	33.6	74
2722.250000	39.7	200.0	V	0.0	42.4	-2.7	34.3	74
2932.000000	40.4	200.0	V	218.0	42.9	-2.5	33.6	74

Remark: 1. Correction Factor = Antenna factor+ Insertion loss (cable loss + amplifier gain)

Frequency (MHz)	Average (dBuV/m)	Height (cm)	Polarization	Azimuth (deg)	Reading value (dBuV/m)	Correct Factor (dB)	Margin (dB)	Limit (dBuV/m)
1220.000000	25.7	100.0	V	356.0	33.2	-7.5	28.3	54
1643.250000	26.8	200.0	V	4.0	32.9	-6.1	27.2	54
1897.750000	34.3	200.0	V	35.0	39.5	-5.2	19.7	54
2280.750000	29.2	200.0	H	231.0	32.9	-3.7	24.8	54
2730.500000	29.2	100.0	V	113.0	31.8	-2.6	24.8	54
2938.250000	29.4	200.0	V	0.0	31.9	-2.5	24.6	54

Remark: 1. Correction Factor = Antenna factor+ Insertion loss (cable loss + amplifier gain)

802.11g CH11

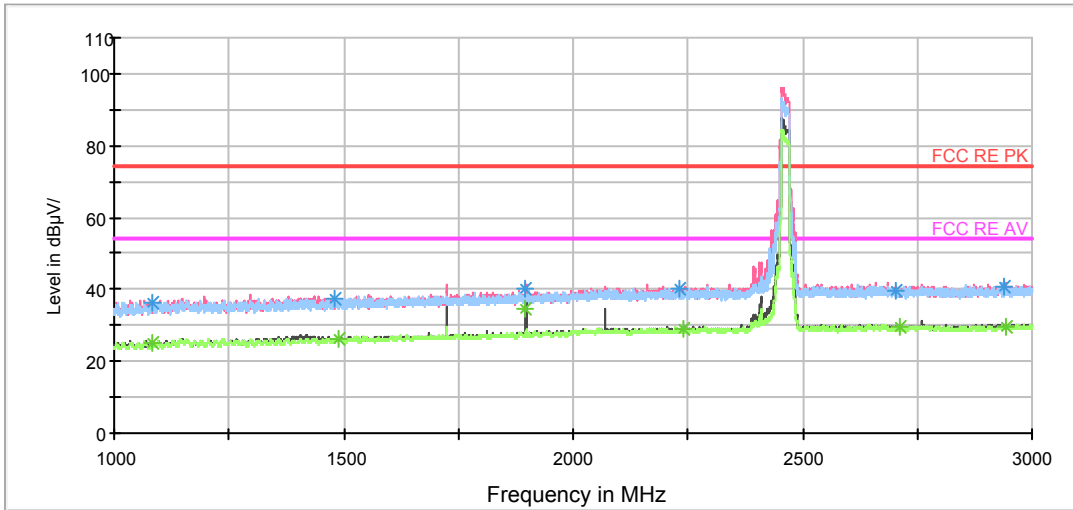

Note: The signal beyond the limit is carrier.  
Radiates Emission from 1GHz to 3GHz

FCC RE 1G-18GHz PK+AV Class B

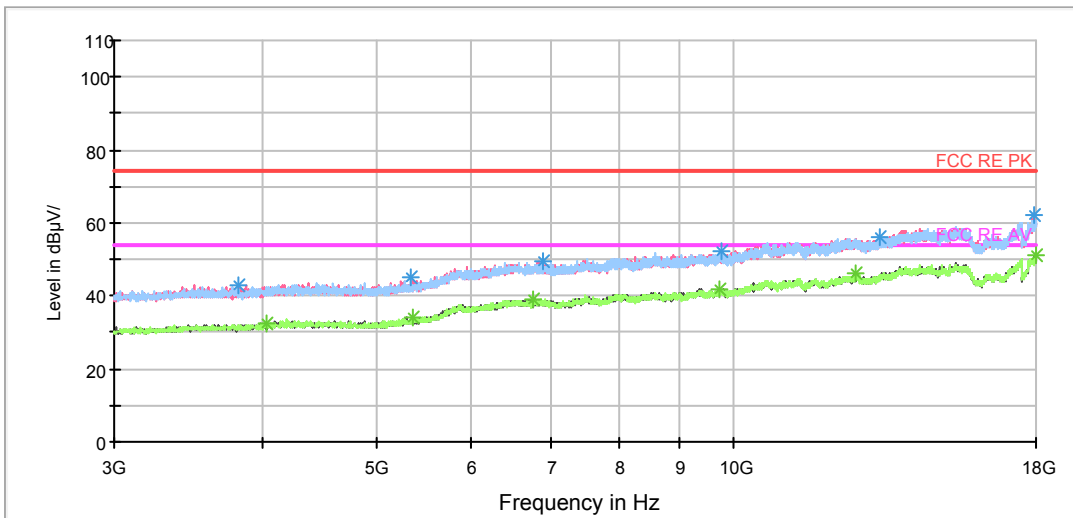

Radiates Emission from 3GHz to 18GHz



Frequency (MHz)	Peak (dBuV/m)	Height (cm)	Polarization	Azimuth (deg)	Reading value (dBuV/m)	Correct Factor (dB)	Margin (dB)	Limit (dBuV/m)
1082.250000	36.2	200.0	V	242.0	44.1	-7.9	37.8	74
1479.000000	37.2	100.0	H	1.0	43.9	-6.7	36.8	74
1897.000000	40.3	200.0	V	30.0	45.5	-5.2	33.7	74
2231.000000	40.0	100.0	V	305.0	43.9	-3.9	34.0	74
2701.000000	39.9	200.0	V	61.0	42.6	-2.7	34.1	74
2940.000000	40.6	100.0	V	0.0	43.1	-2.5	33.4	74

Remark: 1. Correction Factor = Antenna factor+ Insertion loss (cable loss + amplifier gain)

Frequency (MHz)	Average (dBuV/m)	Height (cm)	Polarization	Azimuth (deg)	Reading value (dBuV/m)	Correct Factor (dB)	Margin (dB)	Limit (dBuV/m)
1084.750000	25.1	200.0	V	0.0	33.0	-7.9	28.9	54
1488.250000	26.3	100.0	V	0.0	33.0	-6.7	27.7	54
1897.000000	34.7	200.0	V	30.0	39.9	-5.2	19.3	54
2239.750000	28.9	200.0	V	0.0	32.7	-3.8	25.1	54
2712.500000	29.4	100.0	V	350.0	32.1	-2.7	24.6	54
2944.750000	29.8	200.0	V	129.0	32.3	-2.5	24.2	54

Remark: 1. Correction Factor = Antenna factor+ Insertion loss (cable loss + amplifier gain)

802.11n (HT20) CH1

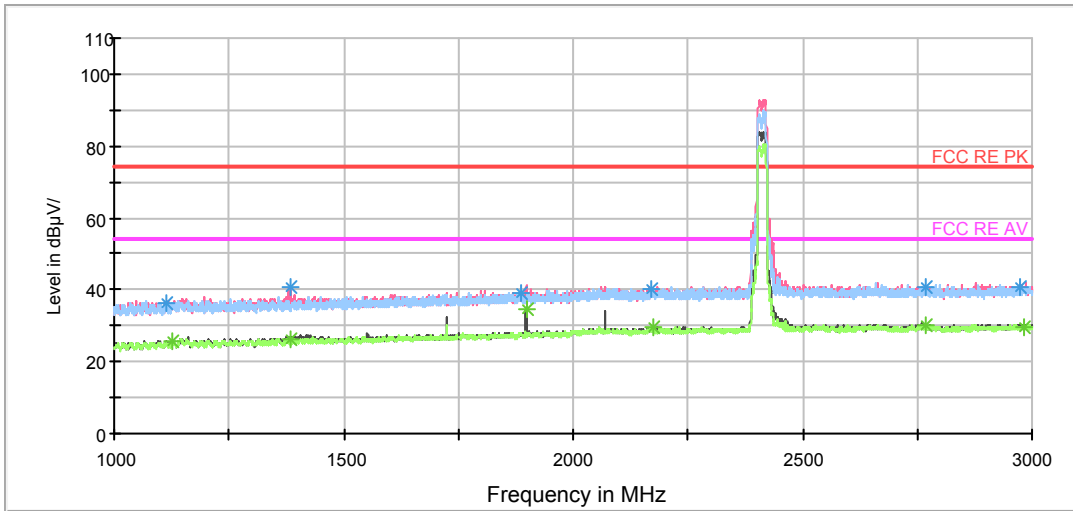

Note: The signal beyond the limit is carrier.

Radiates Emission from 1GHz to 3GHz

FCC RE 1G-18GHz PK+AV Class B

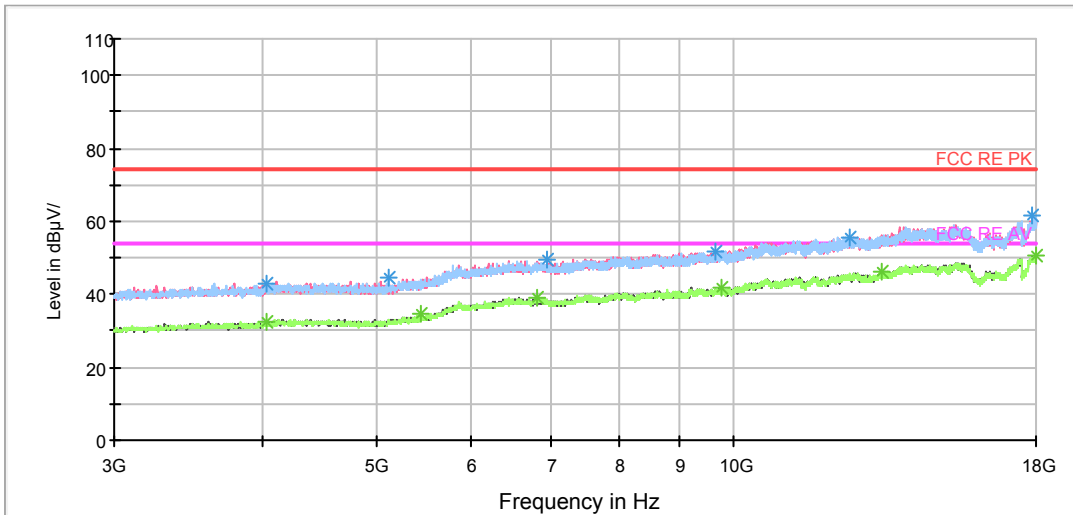

Radiates Emission from 3GHz to 18GHz



Frequency (MHz)	Peak (dBuV/m)	Height (cm)	Polarization	Azimuth (deg)	Reading value (dBuV/m)	Correct Factor (dB)	Margin (dB)	Limit (dBuV/m)
1114.000000	36.4	200.0	V	5.0	44.2	-7.8	37.6	74
1386.000000	40.5	100.0	V	0.0	47.5	-7.0	33.5	74
1885.250000	39.3	200.0	V	101.0	44.5	-5.2	34.7	74
2171.750000	39.9	200.0	V	0.0	44.0	-4.1	34.1	74
2767.500000	40.6	200.0	H	0.0	43.2	-2.6	33.4	74
2973.000000	40.7	100.0	V	0.0	43.2	-2.5	33.3	74

Remark: 1. Correction Factor = Antenna factor+ Insertion loss (cable loss + amplifier gain)

Frequency (MHz)	Average (dBuV/m)	Height (cm)	Polarization	Azimuth (deg)	Reading value (dBuV/m)	Correct Factor (dB)	Margin (dB)	Limit (dBuV/m)
1126.250000	25.8	200.0	H	329.0	33.6	-7.8	28.2	54
1385.000000	26.2	100.0	V	359.0	33.2	-7.0	27.8	54
1897.500000	34.5	200.0	V	30.0	39.7	-5.2	19.5	54
2173.000000	29.4	100.0	V	358.0	33.5	-4.1	24.6	54
2767.250000	30.3	100.0	V	0.0	32.9	-2.6	23.7	54
2983.750000	29.7	200.0	V	8.0	32.2	-2.5	24.3	54

Remark: 1. Correction Factor = Antenna factor+ Insertion loss (cable loss + amplifier gain)



802.11n (HT20) CH6

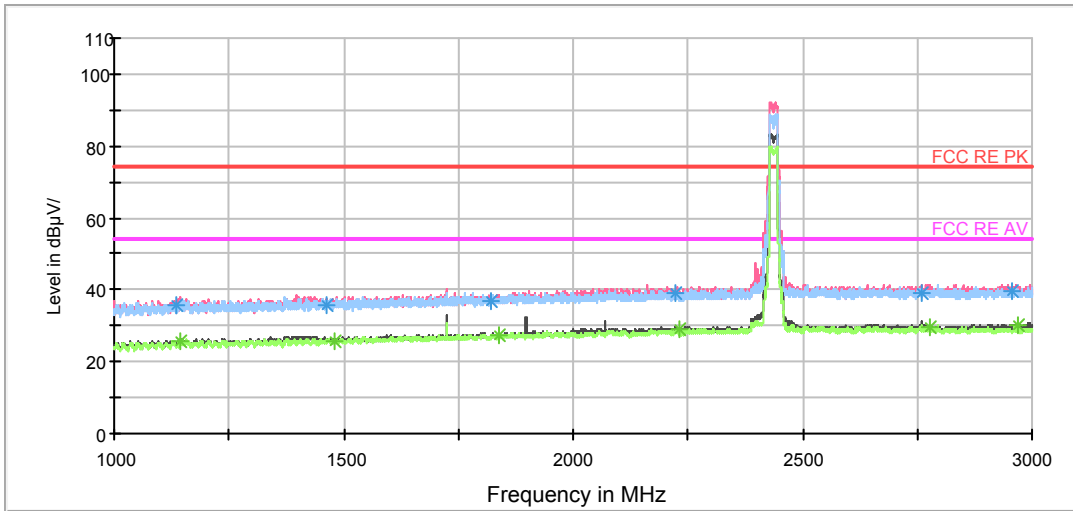

Note: The signal beyond the limit is carrier.

Radiates Emission from 1GHz to 3GHz

FCC RE 1G-18GHz PK+AV Class B

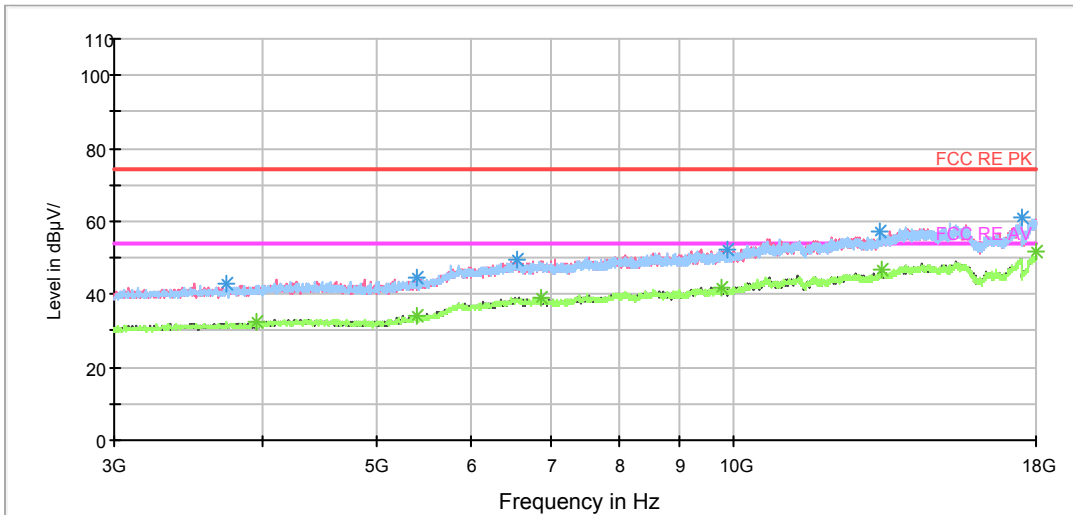

Radiates Emission from 3GHz to 18GHz



Frequency (MHz)	Peak (dBuV/m)	Height (cm)	Polarization	Azimuth (deg)	Reading value (dBuV/m)	Correct Factor (dB)	Margin (dB)	Limit (dBuV/m)
1135.000000	35.9	100.0	H	4.0	43.7	-7.8	38.1	74
1461.000000	35.7	100.0	V	214.0	42.5	-6.8	38.3	74
1821.750000	36.7	100.0	V	186.0	42.1	-5.4	37.3	74
2221.000000	39.0	200.0	V	12.0	42.9	-3.9	35.0	74
2759.500000	39.1	200.0	H	0.0	41.7	-2.6	34.9	74
2956.750000	39.6	100.0	V	0.0	42.1	-2.5	34.4	74

Remark: 1. Correction Factor = Antenna factor+ Insertion loss (cable loss + amplifier gain)

Frequency (MHz)	Average (dBuV/m)	Height (cm)	Polarization	Azimuth (deg)	Reading value (dBuV/m)	Correct Factor (dB)	Margin (dB)	Limit (dBuV/m)
1145.250000	25.8	200.0	V	6.0	33.5	-7.7	28.2	54
1481.250000	25.8	200.0	V	12.0	32.5	-6.7	28.2	54
1837.500000	27.4	100.0	V	319.0	32.8	-5.4	26.6	54
2231.750000	28.9	100.0	V	0.0	32.7	-3.8	25.1	54
2775.250000	29.7	200.0	V	42.0	32.3	-2.6	24.3	54
2968.500000	30.0	200.0	V	12.0	32.5	-2.5	24.0	54

Remark: 1. Correction Factor = Antenna factor+ Insertion loss (cable loss + amplifier gain)

802.11n (HT20) CH11

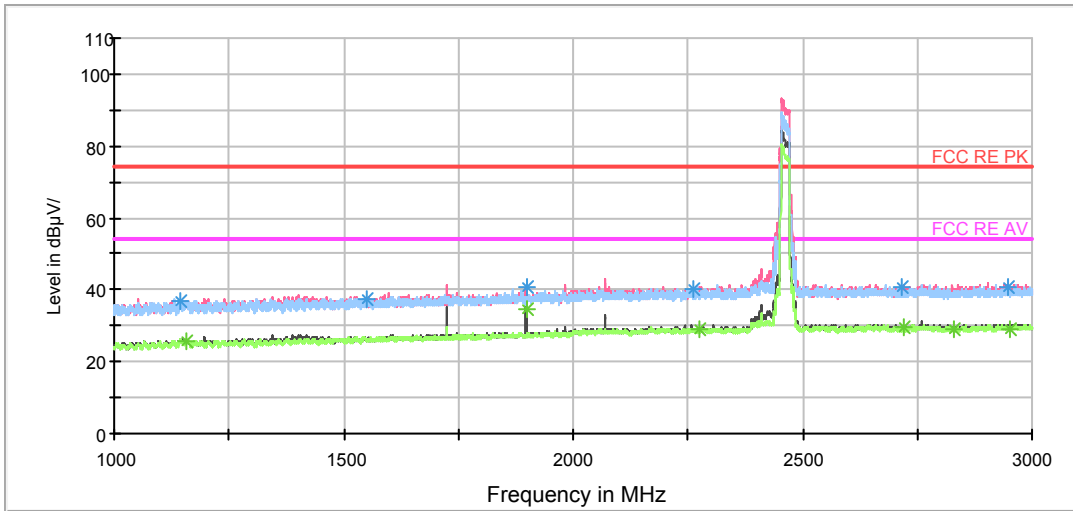

Note: The signal beyond the limit is carrier.

Radiates Emission from 1GHz to 3GHz

FCC RE 1G-18GHz PK+AV Class B

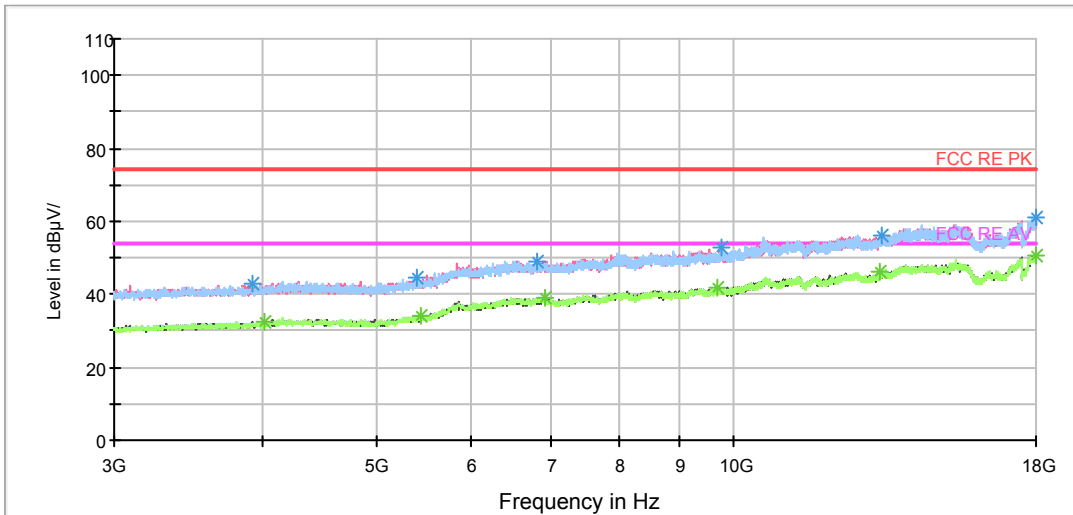

Radiates Emission from 3GHz to 18GHz



Frequency (MHz)	Peak (dBuV/m)	Height (cm)	Polarization	Azimuth (deg)	Reading value (dBuV/m)	Correct Factor (dB)	Margin (dB)	Limit (dBuV/m)
1144.000000	36.7	100.0	V	346.0	44.4	-7.7	37.3	74
1551.750000	37.2	200.0	V	4.0	43.6	-6.4	36.8	74
1897.750000	40.7	200.0	V	32.0	45.9	-5.2	33.3	74
2261.750000	40.0	200.0	H	357.0	43.7	-3.7	34.0	74
2718.250000	40.7	200.0	V	2.0	43.4	-2.7	33.3	74
2948.750000	40.6	100.0	V	316.0	43.1	-2.5	33.4	74

Remark: 1. Correction Factor = Antenna factor+ Insertion loss (cable loss + amplifier gain)

Frequency (MHz)	Average (dBuV/m)	Height (cm)	Polarization	Azimuth (deg)	Reading value (dBuV/m)	Correct Factor (dB)	Margin (dB)	Limit (dBuV/m)
1156.500000	25.8	100.0	V	350.0	33.5	-7.7	28.2	54
1897.750000	34.6	200.0	V	32.0	39.8	-5.2	19.4	54
2277.000000	29.1	100.0	V	184.0	32.8	-3.7	24.9	54
2718.500000	29.8	100.0	V	0.0	32.5	-2.7	24.2	54
2830.250000	29.2	100.0	V	0.0	31.8	-2.6	24.8	54
2953.500000	29.1	200.0	H	0.0	31.6	-2.5	24.9	54

Remark: 1. Correction Factor = Antenna factor+ Insertion loss (cable loss + amplifier gain)

**BLE-Channel 0**

FCC RE 1G-3GHz PK+AV Class B

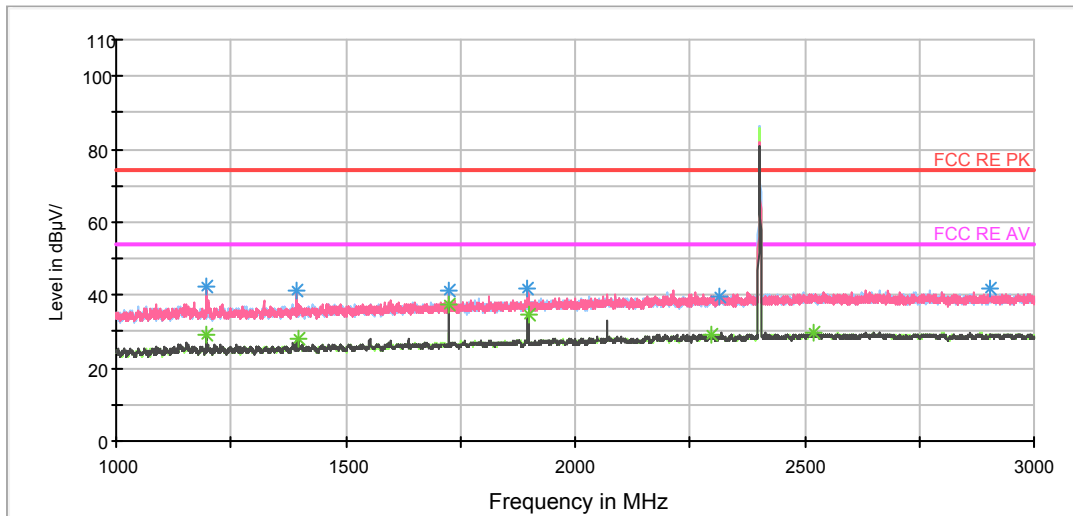

Note: The signal beyond the limit is carrier.  
Radiates Emission from 1GHz to 3GHz

FCC RE 1G-18GHz PK+AV Class B

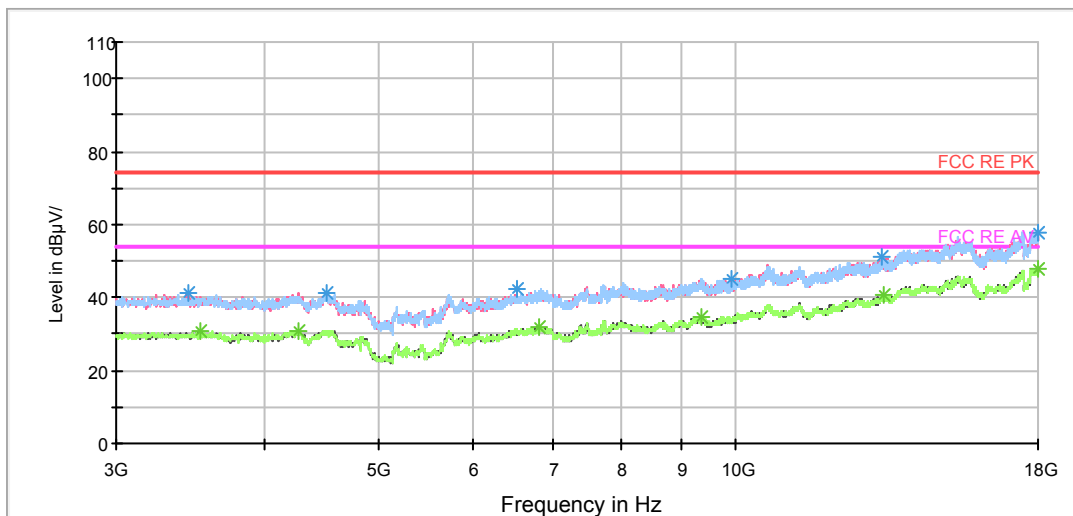

Radiates Emission from 3GHz to 18GHz



Frequency (MHz)	Peak (dBuV/m)	Height (cm)	Polarization	Azimuth (deg)	Reading value (dBuV/m)	Correct Factor (dB)	Margin (dB)	Limit (dBuV/m)
1198.000000	42.3	100.0	V	172.0	49.9	-7.6	31.7	74
1393.500000	41.3	100.0	V	18.0	48.3	-7.0	32.7	74
1725.000000	41.5	100.0	V	90.0	47.3	-5.8	32.5	74
1897.250000	41.9	100.0	V	90.0	47.1	-5.2	32.1	74
2905.000000	41.7	200.0	V	147.0	44.2	-2.5	32.3	74
2314.250000	39.6	100.0	V	0.0	43.1	-3.5	34.4	74

Remark: 1. Correction Factor = Antenna factor+ Insertion loss (cable loss + amplifier gain)

Frequency (MHz)	Average (dBuV/m)	Height (cm)	Polarization	Azimuth (deg)	Reading value (dBuV/m)	Correct Factor (dB)	Margin (dB)	Limit (dBuV/m)
1196.250000	29.0	100.0	V	2.0	36.6	-7.6	25.0	54
1395.750000	28.2	100.0	V	0.0	35.2	-7.0	25.8	54
1725.000000	37.5	100.0	V	90.0	43.3	-5.8	16.5	54
1897.500000	34.9	100.0	V	90.0	40.1	-5.2	19.1	54
2520.750000	29.6	200.0	V	229.0	32.4	-2.8	24.4	54
2295.750000	29.2	100.0	V	32.0	32.8	-3.6	24.8	54

Remark: 1. Correction Factor = Antenna factor+ Insertion loss (cable loss + amplifier gain)

**BLE-Channel 19**

FCC RE 1G-3GHz PK+AV Class B

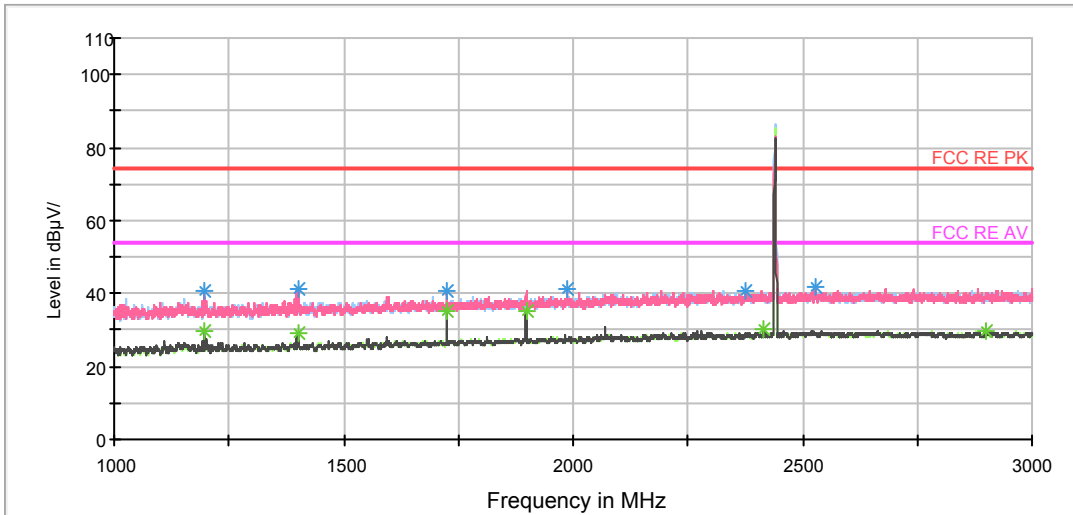

Note: The signal beyond the limit is carrier.  
Radiates Emission from 1GHz to 3GHz

FCC RE 1G-18GHz PK+AV Class B

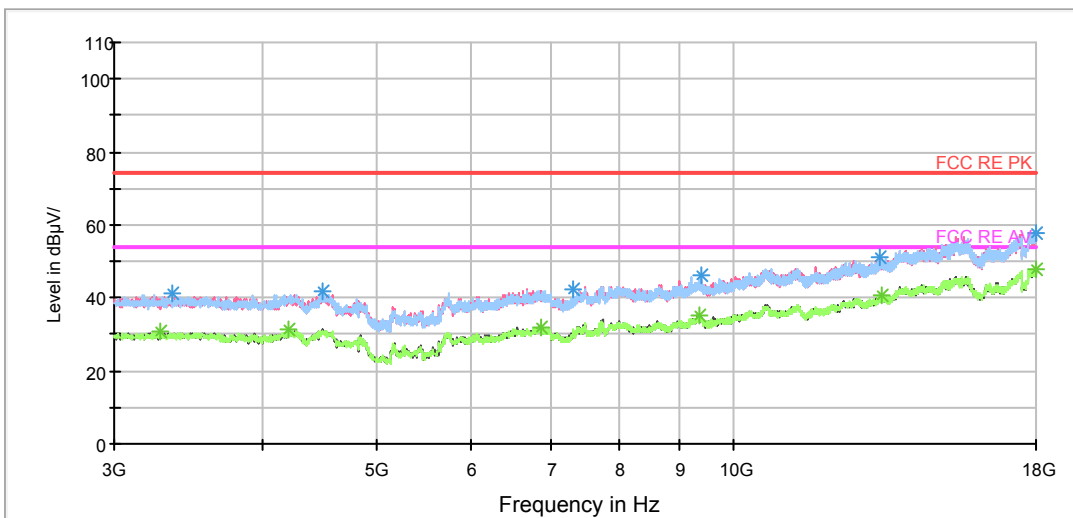

Radiates Emission from 3GHz to 18GHz



Frequency (MHz)	Peak (dBuV/m)	Height (cm)	Polarization	Azimuth (deg)	Reading value (dBuV/m)	Correct Factor (dB)	Margin (dB)	Limit (dBuV/m)
1197.000000	40.5	100.0	V	157.0	48.1	-7.6	33.5	74
1400.500000	41.5	100.0	V	12.0	48.4	-6.9	32.5	74
1724.250000	40.9	200.0	V	106.0	46.7	-5.8	33.1	74
1986.250000	41.4	200.0	V	343.0	46.3	-4.9	32.6	74
2529.500000	41.8	100.0	V	143.0	44.6	-2.8	32.2	74
2377.000000	40.8	100.0	V	4.0	44.1	-3.3	33.2	74

Remark: 1. Correction Factor = Antenna factor+ Insertion loss (cable loss + amplifier gain)

Frequency (MHz)	Average (dBuV/m)	Height (cm)	Polarization	Azimuth (deg)	Reading value (dBuV/m)	Correct Factor (dB)	Margin (dB)	Limit (dBuV/m)
1197.000000	29.6	100.0	V	157.0	37.2	-7.6	24.4	54
1399.750000	29.1	100.0	V	12.0	36.0	-6.9	24.9	54
1724.750000	35.4	200.0	V	106.0	41.2	-5.8	18.6	54
1897.500000	35.0	100.0	V	75.0	40.2	-5.2	19.0	54
2900.000000	29.7	100.0	V	0.0	32.2	-2.5	24.3	54
2414.750000	30.2	200.0	V	106.0	33.4	-3.2	23.8	54

Remark: 1. Correction Factor = Antenna factor+ Insertion loss (cable loss + amplifier gain)



**BLE-Channel 39**

FCC RE 1G-3GHz PK+AV Class B

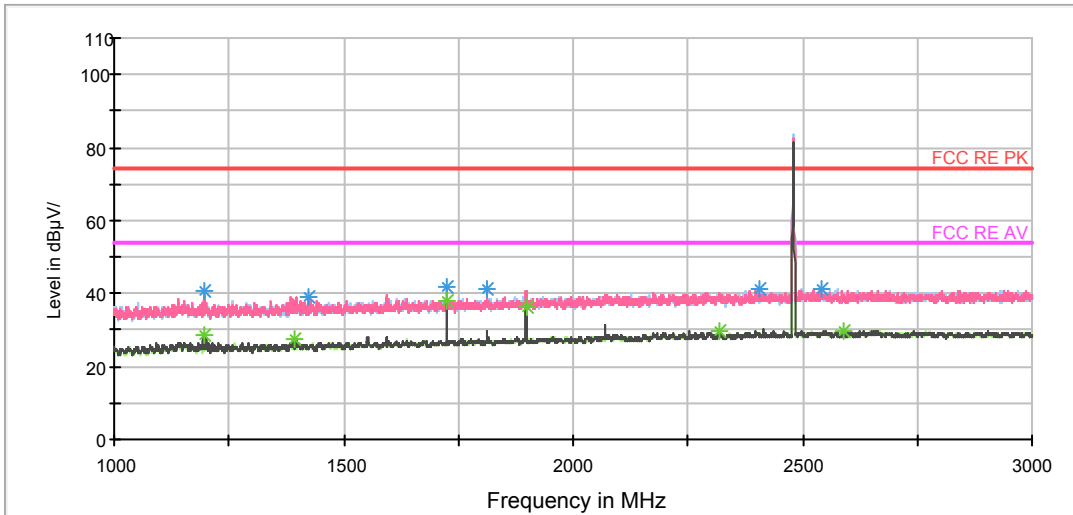

Note: The signal beyond the limit is carrier.  
Radiates Emission from 1GHz to 3GHz

FCC RE 1G-18GHz PK+AV Class B

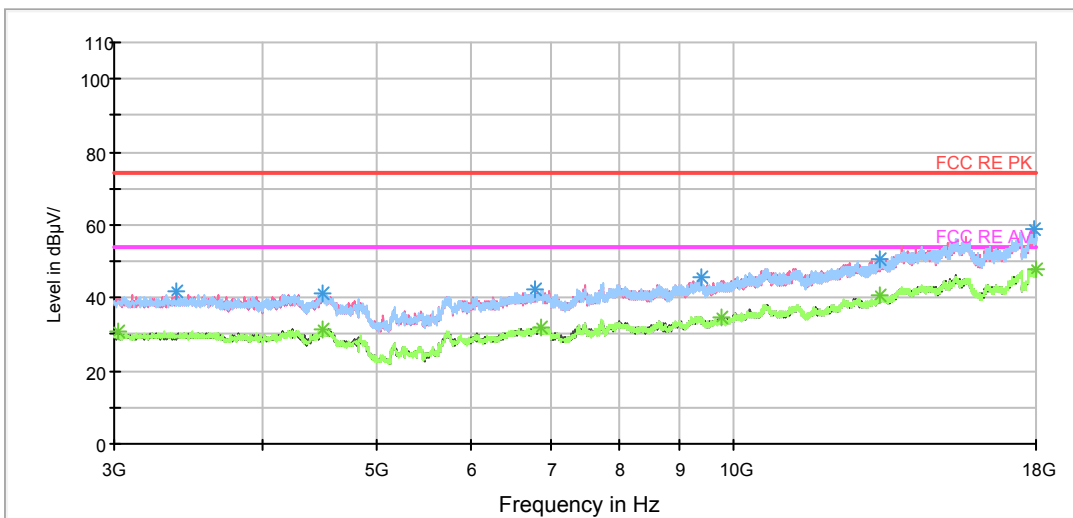

Radiates Emission from 3GHz to 18GHz



Frequency (MHz)	Peak (dBuV/m)	Height (cm)	Polarization	Azimuth (deg)	Reading value (dBuV/m)	Correct Factor (dB)	Margin (dB)	Limit (dBuV/m)
1195.500000	40.6	200.0	V	188.0	48.2	-7.6	33.4	74
1423.000000	39.2	100.0	V	26.0	46.1	-6.9	34.8	74
1724.750000	41.7	100.0	V	79.0	47.5	-5.8	32.3	74
1811.250000	41.4	100.0	V	79.0	46.9	-5.5	32.6	74
2541.250000	41.1	100.0	H	258.0	43.9	-2.8	32.9	74
2406.500000	41.2	200.0	H	9.0	44.4	-3.2	32.8	74

Remark: 1. Correction Factor = Antenna factor+ Insertion loss (cable loss + amplifier gain)

Frequency (MHz)	Average (dBuV/m)	Height (cm)	Polarization	Azimuth (deg)	Reading value (dBuV/m)	Correct Factor (dB)	Margin (dB)	Limit (dBuV/m)
1194.500000	28.7	100.0	V	6.0	36.3	-7.6	25.3	54
1395.000000	27.5	100.0	V	14.0	34.5	-7.0	26.5	54
1725.000000	38.0	100.0	V	79.0	43.8	-5.8	16.0	54
1897.500000	36.5	100.0	V	79.0	41.7	-5.2	17.5	54
2590.500000	29.8	200.0	V	203.0	32.6	-2.8	24.2	54
2318.750000	29.9	100.0	V	4.0	33.4	-3.5	24.1	54

Remark: 1. Correction Factor = Antenna factor+ Insertion loss (cable loss + amplifier gain)

### 5.8. Conducted Emission

#### Ambient condition

Temperature	Relative humidity	Pressure
23°C ~25°C	45%~50%	101.5kPa

#### Methods of Measurement

The EUT is placed on a non-metallic table of 80cm height above the horizontal metal reference ground plane. During the test, the EUT was operating in its typical mode. The test method is according to ANSI C63.10-2013. Connect the AC power line of the EUT to the L.I.S.N. Use EMI receiver to detect the average and Quasi-peak value. RBW is set to 9 kHz, VBW is set to 30kHz. The measurement result should include both L line and N line.

The test is in transmitting mode.

#### Test Setup

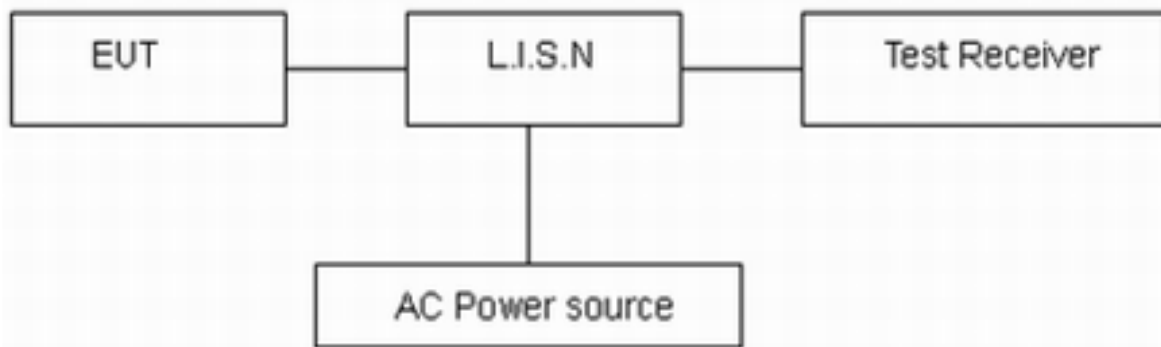

Note: AC Power source is used to change the voltage 110V/60Hz.

#### Limits

Frequency (MHz)	Conducted Limits(dBμV)	
	Quasi-peak	Average
0.15 - 0.5	66 to 56 *	56 to 46*
0.5 - 5	56	46
5 - 30	60	50

\*: Decreases with the logarithm of the frequency.

#### Measurement Uncertainty

The assessed measurement uncertainty to ensure 95% confidence level for the normal distribution is with the coverage factor  $k = 1.96$ ,  $U = 2.69$  dB.



**Test Results:**

Following plots, Blue trace uses the peak detection and Green trace uses the average detection. During the test, the Conducted Emission was performed in all modes (WIFI 2.4G /BLE) with all channels, 802.11b, Channel 11 are selected as the worst condition. The test data of the worst-case condition was recorded in this report.

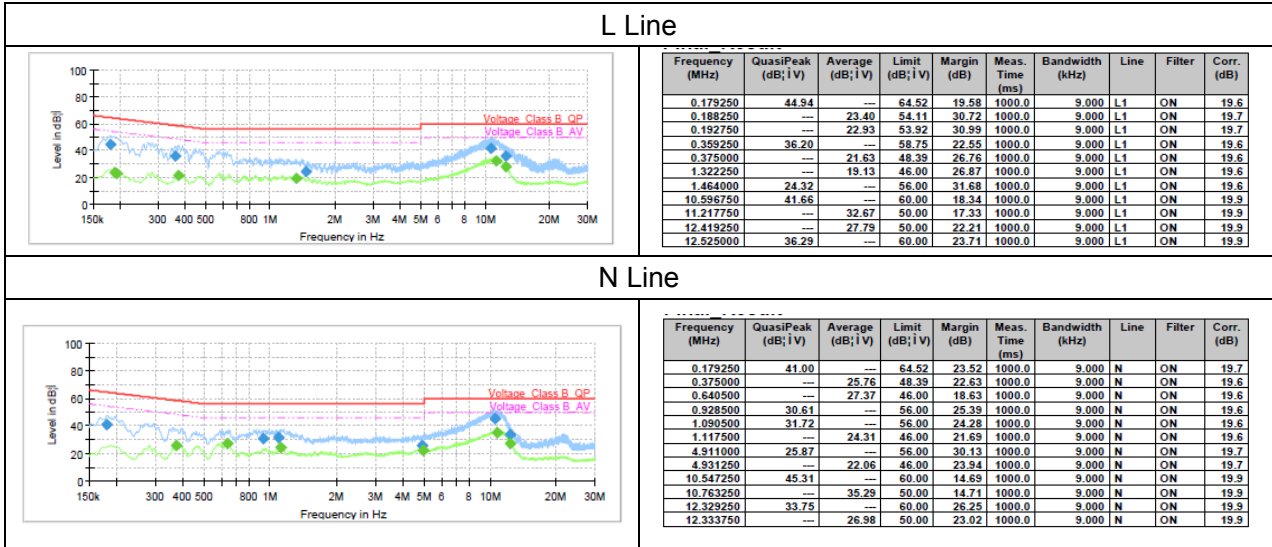



## 6. Main Test Instruments

Name	Manufacturer	Type	Serial Number	Calibration Date	Expiration Date
Spectrum Analyzer	R&S	FSV30	100815	2017-12-17	2018-12-16
EMI Test Receiver	R&S	ESCI	100948	2017-05-20	2018-05-19
TRILOG Broadband Antenna	Schwarzbeck	VULB 9163	9163-201	2017-11-18	2020-11-17
Double Ridged Waveguide Horn Antenna	R&S	HF907	100126	2014-12-06	2019-12-05
Loop Antenna	SCHWARZBECK	FMZB1519	1519-047	2017-11-18	2020-11-17
Standard Gain Horn	ETS-Lindgren	3160-09	00102644	2015-01-30	2020-01-29
EMI Test Receiver	R&S	ESR	101667	2017-09-06	2018-09-05
LISN	R&S	ENV216	101171	2016-12-16	2019-12-15
Spectrum Analyzer	Agilent	N9010A	MY47191109	2017-05-20	2018-05-19
Power Meter	R&S	NRP2	1144.1374K02 -104306-EX	2017-05-24	2018-05-23
Power Sensor	R&S	NRP-Z21	104799	2017-05-24	2018-05-23
RF Cable	Agilent	SMA 15cm	0001	/	/
Software (CE)	ROHDE&SCHW ARZ	EMC32	9.26.0	/	/
Software (RE/RSE)	ROHDE&SCHW ARZ	EMC32	8.52.0	/	/

\*\*\*\*\*END OF REPORT \*\*\*\*\*