



# RF TEST REPORT

**Applicant** Huawei Technologies Co., Ltd.  
**FCC ID** QISJKM-LX3  
**Product** Smart Phone  
**Model** JKM-LX3  
**Report No.** R1807H0096-R5  
**Issue Date** August 26, 2018

TA Technology (Shanghai) Co., Ltd. tested the above equipment in accordance with the requirements in **FCC CFR47 Part 15C (2018)**. The test results show that the equipment tested is capable of demonstrating compliance with the requirements as documented in this report.

*Performed by: Peng Tao*

*Approved by: Kai Xu*

---

**TA Technology (Shanghai) Co., Ltd.**

*No.145, Jintang Rd, Tangzhen Industry Park, Pudong Shanghai, China*

*TEL: +86-021-50791141/2/3*

*FAX: +86-021-50791141/2/3-8000*

## Table of Contents

1	Test Laboratory.....	4
1.1	Notes of the Test Report.....	4
1.2	Test facility.....	4
1.3	Testing Location.....	5
2	General Description of Equipment under Test.....	6
3	Applied Standards.....	9
4	Test Case Results.....	10
4.1	Unwanted Emission.....	10
4.2	Conducted Emission.....	28
5	Main Test Instruments.....	30



## Summary of Measurement Results

Number	Summary of measurements of results	Clause in FCC rules	Verdict
1	Unwanted Emissions	15.247(d),15.205,15.209	PASS
2	AC Power Line Conducted Emission	15.207	PASS
Date of Testing: August 2, 2018 ~ August 12, 2018			

# 1 Test Laboratory

## 1.1 Notes of the Test Report

This report shall not be reproduced in full or partial, without the written approval of **TA technology (shanghai) co., Ltd.** The results documented in this report apply only to the tested sample, under the conditions and modes of operation as described herein .Measurement Uncertainties were not taken into account and are published for informational purposes only. This report is written to support regulatory compliance of the applicable standards stated above.

## 1.2 Test facility

### **CNAS (accreditation number: L2264)**

TA Technology (Shanghai) Co., Ltd. has obtained the accreditation of China National Accreditation Service for Conformity Assessment (CNAS).

### **FCC (Designation number: CN1179, Test Firm Registration Number: 446626)**

TA Technology (Shanghai) Co., Ltd. has been listed on the US Federal Communications Commission list of test facilities recognized to perform electromagnetic emissions measurements.

### **IC (recognition number is 8510A)**

TA Technology (Shanghai) Co., Ltd. has been listed by industry Canada to perform electromagnetic emission measurement.

### **VCCI (recognition number is C-4595, T-2154, R-4113, G-10766)**

TA Technology (Shanghai) Co., Ltd. has been listed by industry Japan to perform electromagnetic emission measurement.

### **A2LA (Certificate Number: 3857.01)**

TA Technology (Shanghai) Co., Ltd. has been listed by American Association for Laboratory Accreditation to perform electromagnetic emission measurement.

### 1.3 Testing Location

Company: TA Technology (Shanghai) Co., Ltd.  
Address: No.145, Jintang Rd, Tangzhen Industry Park, Pudong Shanghai, China  
City: Shanghai  
Post code: 201201  
Country: P. R. China  
Contact: Xu Kai  
Telephone: +86-021-50791141/2/3  
Fax: +86-021-50791141/2/3-8000  
Website: <http://www.ta-shanghai.com>  
E-mail: [xukai@ta-shanghai.com](mailto:xukai@ta-shanghai.com)

## 2 General Description of Equipment under Test

### Client Information



<b>Applicant</b>	Huawei Technologies Co., Ltd.
<b>Applicant address</b>	Administration Building, Headquarters of Huawei Technologies Co., Ltd., Bantian, Longgang District, Shenzhen, 518129, P.R.China.
<b>Manufacturer</b>	Huawei Technologies Co., Ltd.
<b>Manufacturer address</b>	Administration Building, Headquarters of Huawei Technologies Co., Ltd., Bantian, Longgang District, Shenzhen, 518129, P.R.China.

### General information

EUT Description			
Model	JKM-LX3		
IMEI	SIM 1:866861040004689 SIM 2:866861040004960		
Hardware Version	HL3JKMM		
Software Version	JKM-LX3 5.0.1.33(C900)		
Power Supply	Battery/AC adapter		
Antenna Type	Internal Antenna		
Antenna Connector	A permanently attached antenna (meet with the standard FCC Part 15.203 requirement)		
Test Mode(s)	Basic Rate	Enhanced Data Rate(EDR)	
Modulation Type	Frequency Hopping Spread Spectrum (FHSS)		
	GFSK	$\pi/4$ DQPSK	8DPSK
Packet Type (Maximum Payload)	DH5	2DH5	3DH5
Operating Frequency Range(s)	2402-2480 MHz		
EUT Accessory			
Adapter 1	Manufacturer: SALCOMP(GUIGANG)CO.,LTD Model: HW-050200U02 SN: K95501J3N00047		
Adapter 2	Manufacturer: HUIZHOU BYD ELECTRONIC CO., LTD. Model: HW-050200U02 SN: B95532J5T00027		
Adapter 3	Manufacturer: SHENZHEN HUNTKEY ELECTRIC CO., LTD. Model: HW-050200U02 SN: H955KAJ4M00140		
Adapter 4	Manufacturer: Dongguan Phitek Electronics Co., Ltd. Model: HW-050200U02 SN: P95521J6200050		

Adapter 5	Manufacturer: HUIZHOU BYD ELECTRONIC CO., LTD. Model: HW-050200U01 SN: 878697J4J02221
Adapter 6	Manufacturer: SHENZHEN HUNTKEY ELECTRIC CO., LTD. Model: HW-050200U01 SN: H786K9J4V01335
Adapter 7	Manufacturer: Dongguan Phitek Electronics Co., Ltd. Model: HW-050200U01 SN: P78621J4278849
Battery 1	Manufacturer: HuaweiTechnologies Co., Ltd. (Manufacturer: SCUD) Model: HB406689ECW SN: 2791ACI708900020
Battery 2	Manufacturer: HuaweiTechnologies Co., Ltd. (Manufacturer: Desay) Model: HB406689ECW SN: 2791AYI717X00018
Earphone 1	Manufacturer: GoerTek Inc Model: HA1-3W
Earphone 2	Manufacturer: Jiangxi Lianchuang Hongsheng Electronic Co.,LTD Model: MEMD1532B528A00
Earphone 3	Manufacturer: BOLUO COUNTY QUANCHENG ELECTRONIC CO.,LTD Model: 1293-3283-3.5mm-300
Earphone 4	Manufacturer: FOXCONN INTERCONNECT TECHNOLOGY LIMITED Model: EPAB542-2WH03-DH
Earphone 5	Manufacturer: Jiangxi Lianchuang Hongsheng Electronic Co. ,LTD Model: MEND1532B528A02
Earphone 6	Manufacturer: Boluo County Quancheng Electronic Co.,ltd Model: 11293-3283-3.5mm-322
USB Cable 1	Manufacturer: NingBo Broad Telecommunication Co., Ltd. Model: WA0001
USB Cable 2	Manufacturer: HONGLIN TECHNOLOGY CO., LTD. Model: 130-26669
USB Cable 3	Manufacturer: FOXCONN INTERCONNECT TECHNOLOGY LIMITED Model: CUBB01M-HC304-DH
USB Cable 4	Manufacturer: LuXshare Model: L99U2017-CS-H
<p>Note: 1. The information of the EUT is declared by the manufacturer.</p> <p>2. There is more than one Adapter/ SIM /USB cable/ Battery/Earphone, each one should be applied throughout the compliance test respectively, and however, only the worst case (Adapter 1/SIM 1/USB cable 4/ Battery 2/Earphone 2) will be recorded in this report.</p>	

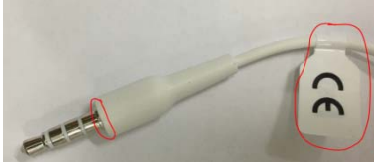
More details information with earphone

HUAWEI code	22040300	22040322
Manufactory	1.Lianchuang 2.QUANCHENG 3.FOXCONN 4.GoerTek	1.Lianchuang 2.QUANCHENG
model	1. MEMD1532B528A00 2. 1293-3283-3.5mm-300 3.EPAB542-2WH03-DH 4. HA1-3W	1. MEND1532B528A02 2. 1293-3283-3.5mm-322
PCB	The PCB of the same Manufactory is the same	The PCB of the same Manufactory is the same
Appearance		 1.change the plastic of earphone head 2.remove the CE label



### 3 Applied Standards

According to the specifications of the manufacturer, it must comply with the requirements of the following standards:

#### Test standards

- **FCC CFR47 Part 15C (2018) Radio Frequency Devices**
- **ANSI C63.10 (2013)**
- **DA00-705 Filing and Frequency Measurement Guidelines For Frequency Hopping Spread Spectrum System (2000).**

## 4 Test Case Results

### 4.1 Unwanted Emission

#### Ambient condition

Temperature	Relative humidity	Pressure
23°C ~25°C	45%~50%	101.5kPa

#### Method of Measurement

The test set-up was made in accordance to the general provisions of ANSI C63.10-2013. The Equipment Under Test (EUT) was set up on a non-conductive table in the semi-anechoic chamber. The test was performed at the distance of 3 m between the EUT and the receiving antenna. The radiated emissions measurements were made in a typical installation configuration.

Sweep the whole frequency band through the range from 9 kHz to the 10th harmonic of the carrier, and the emissions less than 20 dB below the permissible value are reported.

During the test, below 30MHz, the center of the loop shall be 1 meters; above 30MHz, the height of receive antenna shall be moved from 1 to 4 meters, and the antenna shall be performed under horizontal and vertical polarization. The turntable shall be rotated from 0 to 360 degrees for detecting the maximum of radiated spurious signal level. The measurements shall be repeated with orthogonal polarization of the test antenna. The data of cable loss and antenna factor has been calibrated in full testing frequency range before the testing.

Set the spectrum analyzer in the following:

Below 1GHz (detector: Peak and Quasi-Peak)

RBW=100kHz / VBW=300kHz / Sweep=AUTO

Above 1GHz(detector: Peak):

(a) PEAK: RBW=1MHz VBW=3MHz/ Sweep=AUTO

(b) AVERAGE: RBW=1MHz / VBW=10Hz / Sweep=AUTO

The dwell time per channel of the hopping signal is less than 100 ms, then the reading obtained with the 10 Hz VBW may be further adjusted by a “duty cycle correction factor”, derived from  $20\log(\text{dwell time}/100 \text{ ms})$ , in an effort to demonstrate compliance with the 15.209 limit.

If the emission is pulsed, modify the unit for continuous operation; use the settings shown above, then correct the reading by subtracting the peak- average correction factor, derived form the appropriate duty cycle calculation.

This setting method can refer to **DA00-705**.

The radiated emission was measured in the following position: EUT stand-up position (Z axis), lie-down position (X, Y axis). The worst emission was found in lie-down position (X axis) and the worst case was recorded. Then this mode was measured in the following mode: EUT with cradle and EUT without cradle. The worst emission was found in EUT with cradle mode and the worst case was recorded.

The test is in transmitting mode.

**Test setup**  
**9KHz ~ 30MHz**

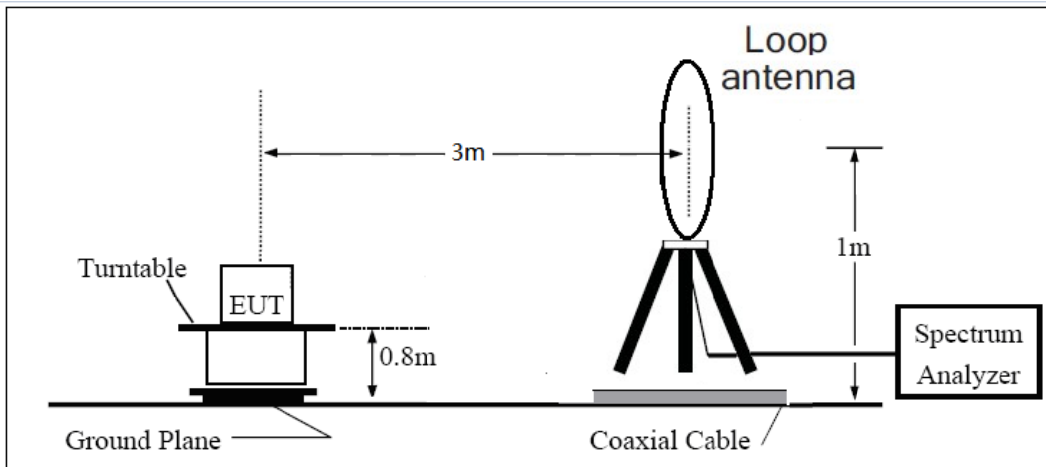

**30MHz ~ 1GHz**

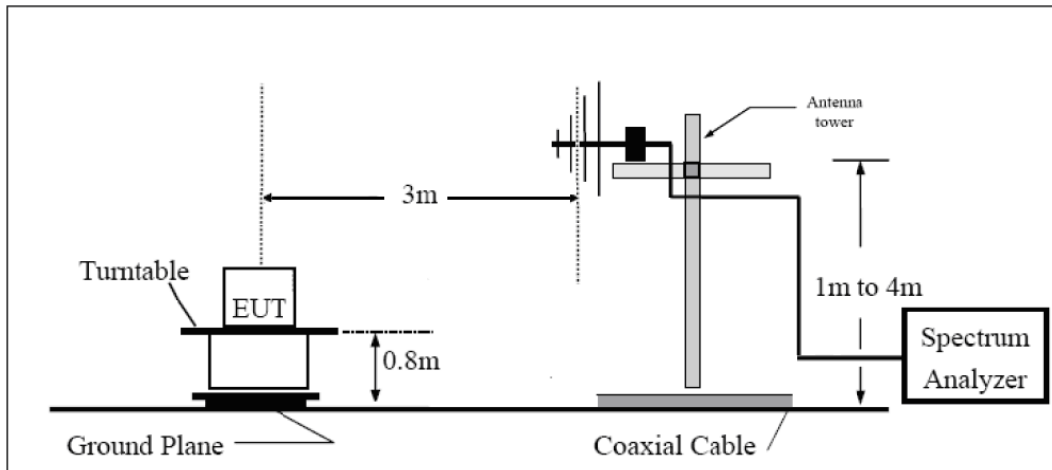

**Above 1GHz**

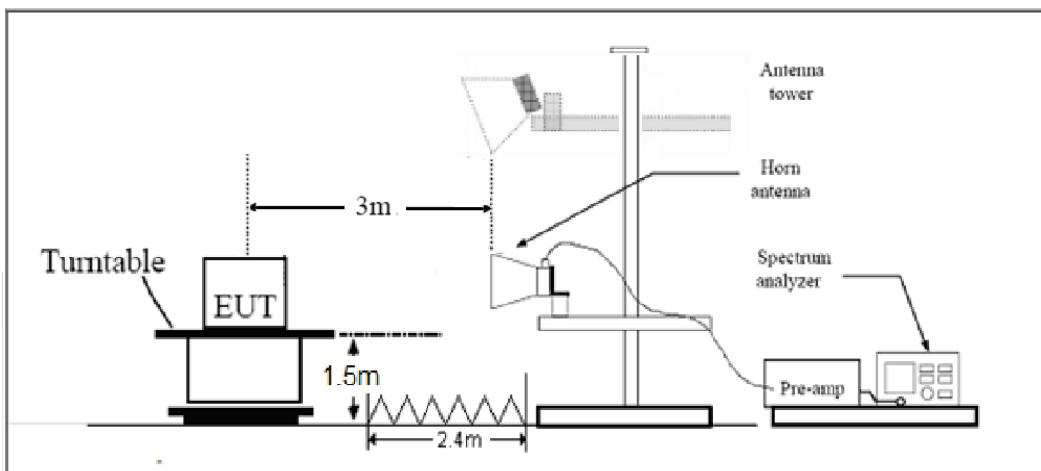

**Limits**

Rule Part 15.247(d) specifies that “In addition, radiated emissions which fall in the restricted bands, as defined in § 15.205(a), must also comply with the radiated emission limits specified in § 15.209(a) (see § 15.205(c)).”

Limit in restricted band

Frequency of emission (MHz)	Field strength(uV/m)	Field strength(dBuV/m)
0.009–0.490	2400/F(kHz)	/
0.490–1.705	24000/F(kHz)	/
1.705–30.0	30	/
30-88	100	40
88-216	150	43.5
216-960	200	46
Above960	500	54

**§15.35(b)**

There is also a limit on the radio frequency emissions, as measured using instrumentation with a peak detector function, corresponding to 20 dB above the maximum permitted average limit.

Peak Limit=74dBuV/m

Average Limit=54dBuV/m

Spurious Radiated Emissions are permitted in any of the frequency bands listed below:

MHz	MHz	MHz	GHz
0.090 - 0.110	16.42 - 16.423	399.9 - 410	4.5 - 5.15
<sup>1</sup> 0.495 - 0.505	16.69475 - 16.69525	608 - 614	5.35 - 5.46
2.1735 - 2.1905	16.80425 - 16.80475	960 - 1240	7.25 - 7.75
4.125 - 4.128	25.5 - 25.67	1300 - 1427	8.025 - 8.5
4.17725 - 4.17775	37.5 - 38.25	1435 - 1626.5	9.0 - 9.2
4.20725 - 4.20775	73 - 74.6	1645.5 - 1646.5	9.3 - 9.5
6.215 - 6.218	74.8 - 75.2	1660 - 1710	10.6 - 12.7
6.26775 - 6.26825	108 - 121.94	1718.8 - 1722.2	13.25 - 13.4
6.31175 - 6.31225	123 - 138	2200 - 2300	14.47 - 14.5
8.291 - 8.294	149.9 - 150.05	2310 - 2390	15.35 - 16.2
8.362 - 8.366	156.52475 - 156.52525	2483.5 - 2500	17.7 - 21.4
8.37625 - 8.38675	156.7 - 156.9	2690 - 2900	22.01 - 23.12
8.41425 - 8.41475	162.0125 - 167.17	3260 - 3267	23.6 - 24.0
12.29 - 12.293	167.72 - 173.2	3332 - 3339	31.2 - 31.8
12.51975 - 12.52025	240 - 285	3345.8 - 3358	36.43 - 36.5
12.57675 - 12.57725	322 - 335.4	3600 - 4400	( <sup>2</sup> )
13.36 - 13.41			

**Measurement Uncertainty**

The assessed measurement uncertainty to ensure 95% confidence level for the normal distribution is with the coverage factor  $k = 1.96$ .

Frequency	Uncertainty
9KHz-30MHz	3.55 dB
30MHz-200MHz	4.19 dB
200MHz-1GHz	3.63 dB
Above 1GHz	3.68 dB



Test Results:

The signal beyond the limit is carrier.

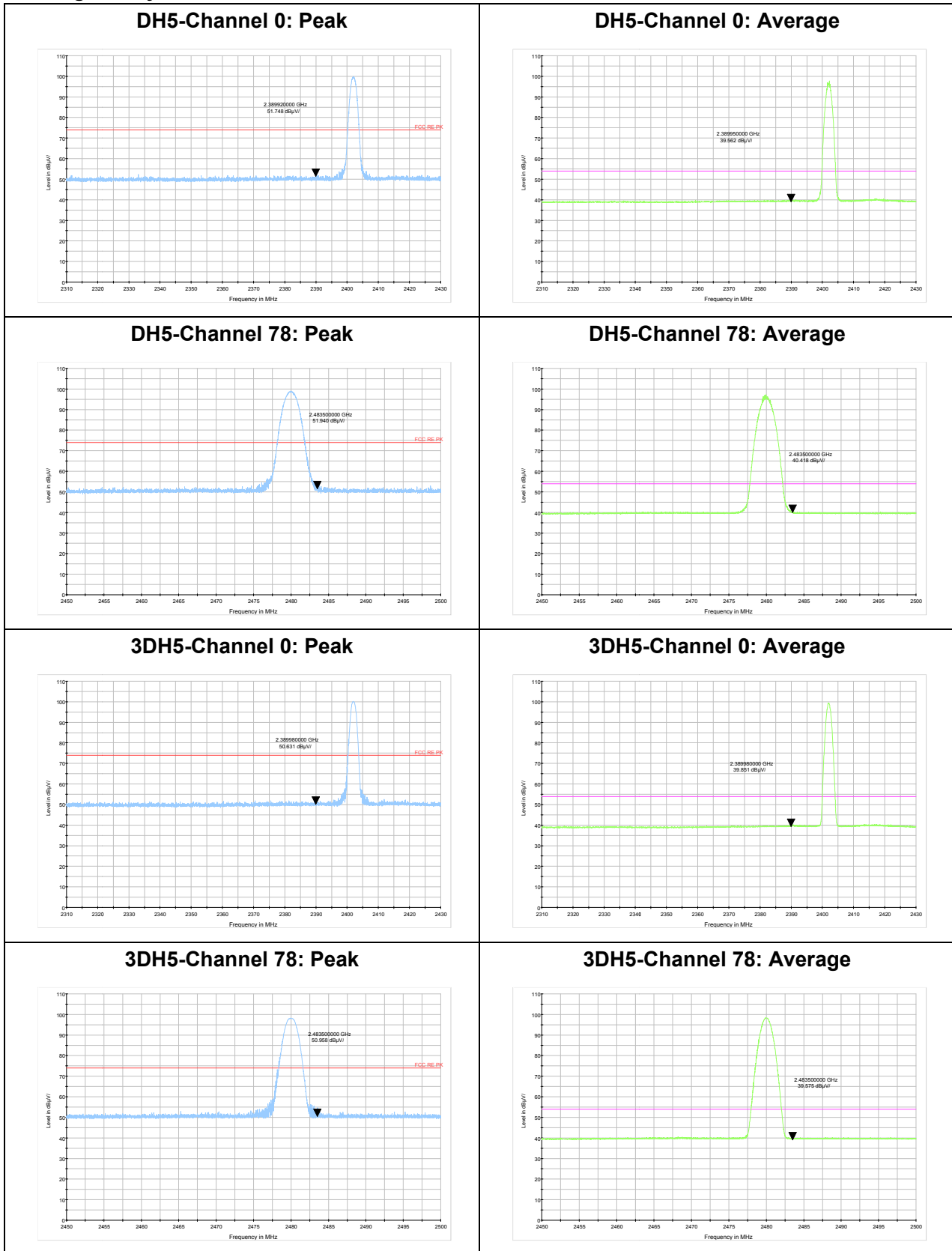

**Result of RE**

**Test result**

Sweep the whole frequency band through the range from 9kHz to the 10th harmonic of the carrier, the Emissions in the frequency band 9kHz-30MHz and 18GHz -26.5GHz are more than 20dB below the limit are not reported.

The following graphs display the maximum values of horizontal and vertical by software. For above 1GHz, Blue trace uses the peak detection, Green trace uses the average detection.

During the test, the Radiates Emission from 30MHz to 1GHz was performed in all modes with all channels, BT **GFSK Channel 0** are selected as the worst condition. The test data of the worst-case condition was recorded in this report.

**Continuous TX mode:**

RE 0.03-1GHz QP Class B

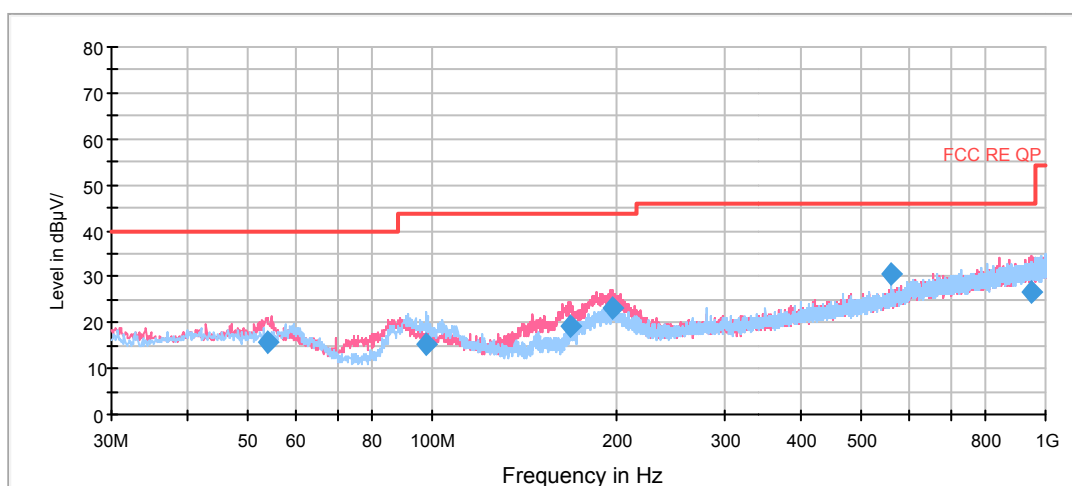

Radiates Emission from 30MHz to 1GHz

Frequency (MHz)	Quasi-Peak (dBuV/m)	Reading value (dBuV/m)	Height (cm)	Polarization	Azimuth (deg)	Correct Factor (dB)	Margin (dB)	Limit (dBuV/m)
54.053750	15.6	2.8	100.0	V	313.0	12.8	24.4	40.0
97.697500	15.3	2.3	200.0	H	8.0	13.0	28.2	43.5
168.260000	19.3	8.9	100.0	V	267.0	10.4	24.2	43.5
197.083750	23.1	11.1	100.0	V	20.0	12.0	20.4	43.5
561.601250	30.6	9.4	100.0	V	359.0	21.2	15.4	46.0
950.853750	26.6	-0.6	200.0	V	4.0	27.2	19.4	46.0

- Remark: 1. Quasi-Peak = Reading value + Correction factor
- 2. Correction Factor = Antenna factor+ Insertion loss(cable loss+amplifier gain)
- 3. Margin = Limit – Quasi-Peak



Copy of FCC RE 1G-18GHz PK+AV Class B

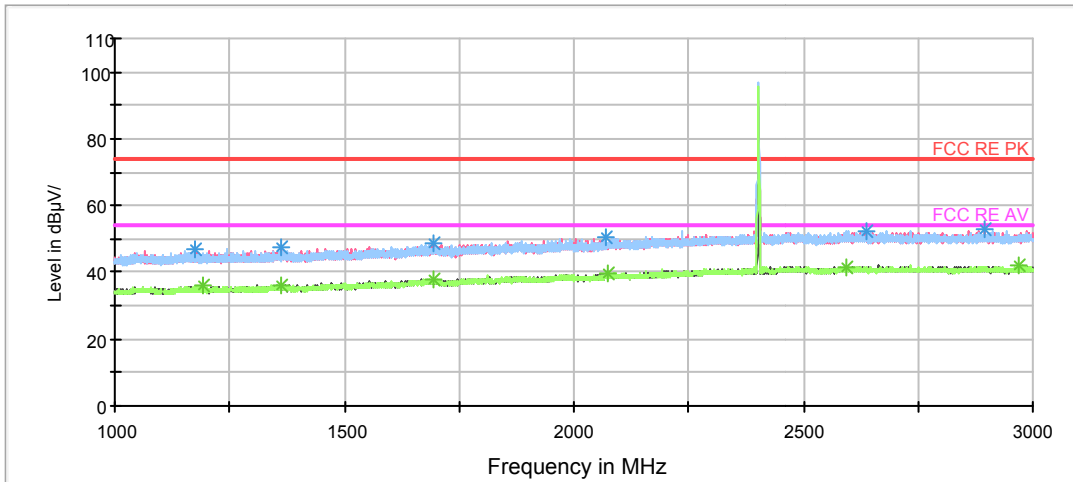

Note: The signal beyond the limit is carrier.

Radiates Emission from 1GHz to 3GHz

Copy of FCC RE 1G-18GHz PK+AV Class B

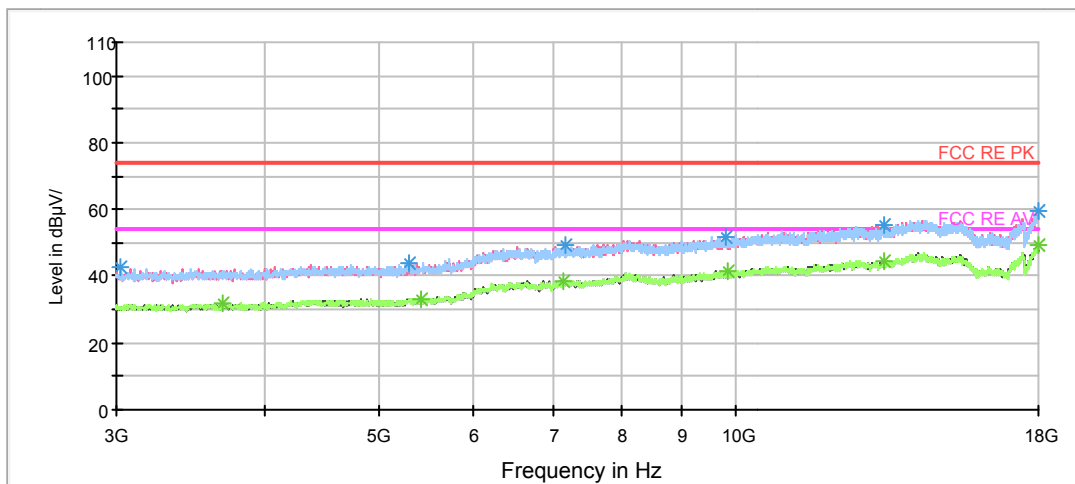

Radiates Emission from 3GHz to 18GHz



Frequency (MHz)	Peak (dBuV/m)	Height (cm)	Polarization	Azimuth (deg)	Reading value (dBuV/m)	Correct Factor (dB)	Margin (dB)	Limit (dBuV/m)
1173.000000	46.6	100.0	H	5.0	47.9	-1.3	27.4	74
1362.500000	47.4	100.0	V	358.0	47.7	-0.3	26.6	74
1693.500000	48.5	200.0	V	0.0	47.3	1.2	25.5	74
2071.000000	50.7	100.0	H	125.0	47.4	3.3	23.3	74
2637.500000	52.1	100.0	V	353.0	46.7	5.4	21.9	74
2894.000000	52.9	200.0	V	0.0	47.1	5.8	21.1	74

**Remark: 1. Correction Factor = Antenna factor+ Insertion loss (cable loss + amplifier gain)**

Frequency (MHz)	Average (dBuV/m)	Height (cm)	Polarization	Azimuth (deg)	Reading value (dBuV/m)	Correct Factor (dB)	Margin (dB)	Limit (dBuV/m)
1190.500000	36.0	200.0	H	0.0	37.4	-1.4	18.0	54
1362.500000	36.3	200.0	H	347.0	36.6	-0.3	17.7	54
1696.500000	37.9	200.0	H	174.0	36.6	1.3	16.1	54
2072.250000	39.5	200.0	V	147.0	36.2	3.3	14.5	54
2595.250000	41.5	100.0	H	55.0	36.0	5.5	12.5	54
2971.000000	41.9	100.0	V	88.0	36.1	5.8	12.1	54

**Remark: 1. Correction Factor = Antenna factor+ Insertion loss (cable loss + amplifier gain)**

EDR -Channel 39

Copy of FCC RE 1G-18GHz PK+AV Class B

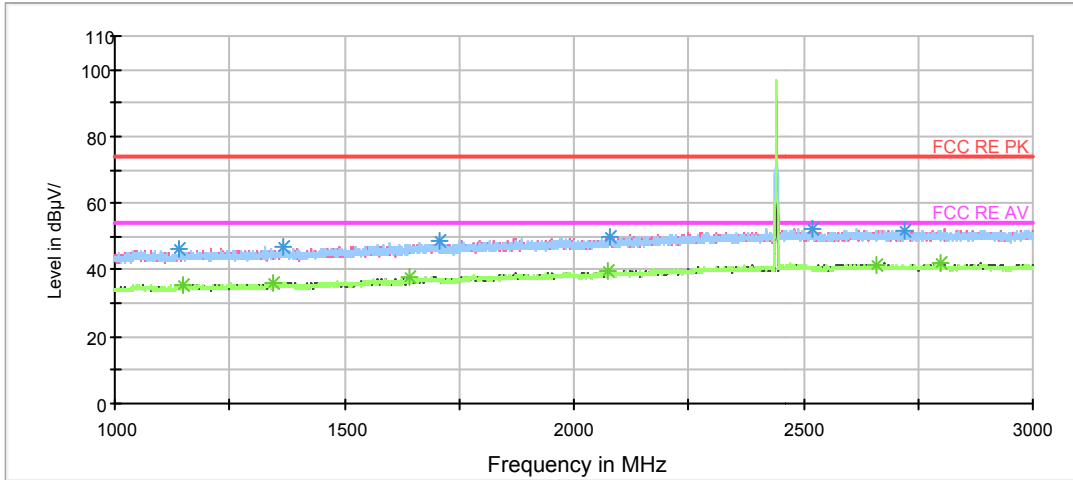

Note: The signal beyond the limit is carrier.  
Radiates Emission from 1GHz to 3GHz

Copy of FCC RE 1G-18GHz PK+AV Class B

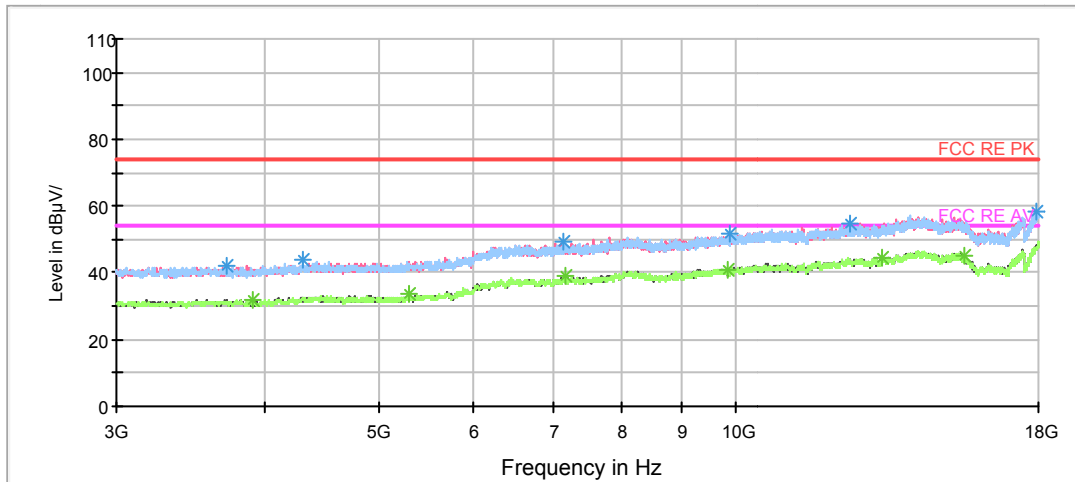

Radiates Emission from 3GHz to 18GHz

Frequency (MHz)	Peak (dBuV/m)	Height (cm)	Polarization	Azimuth (deg)	Reading value (dBuV/m)	Correct Factor (dB)	Margin (dB)	Limit (dBuV/m)
1140.000000	46.3	100.0	H	7.0	47.7	-1.4	27.7	74
1365.000000	46.8	100.0	V	316.0	47.1	-0.3	27.2	74
1707.750000	48.7	200.0	H	134.0	47.6	1.1	25.3	74
2080.000000	50.0	200.0	H	221.0	46.5	3.5	24.0	74
2521.250000	52.3	200.0	H	0.0	47.0	5.3	21.7	74
2720.500000	51.5	200.0	V	18.0	46.0	5.5	22.5	74

**Remark: 1. Correction Factor = Antenna factor+ Insertion loss (cable loss + amplifier gain)**

Frequency (MHz)	Average (dBuV/m)	Height (cm)	Polarization	Azimuth (deg)	Reading value (dBuV/m)	Correct Factor (dB)	Margin (dB)	Limit (dBuV/m)
1149.000000	35.7	200.0	H	356.0	37.1	-1.4	18.3	54
1346.750000	36.2	200.0	V	168.0	36.8	-0.6	17.8	54
1644.000000	37.9	100.0	V	72.0	37.0	0.9	16.1	54
2076.000000	39.9	100.0	V	358.0	36.5	3.4	14.1	54
2660.750000	41.7	100.0	V	304.0	36.2	5.5	12.3	54
2798.750000	41.9	200.0	V	82.0	36.1	5.8	12.1	54

**Remark: 1. Correction Factor = Antenna factor+ Insertion loss (cable loss + amplifier gain)**

EDR -Channel 78

Copy of FCC RE 1G-18GHz PK+AV Class B

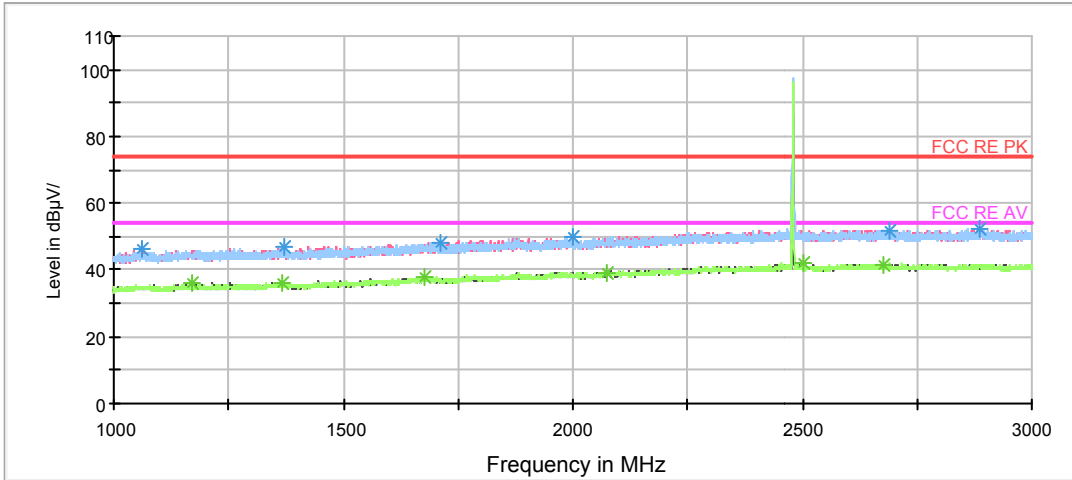

Note: The signal beyond the limit is carrier.  
Radiates Emission from 1GHz to 3GHz

Copy of FCC RE 1G-18GHz PK+AV Class B

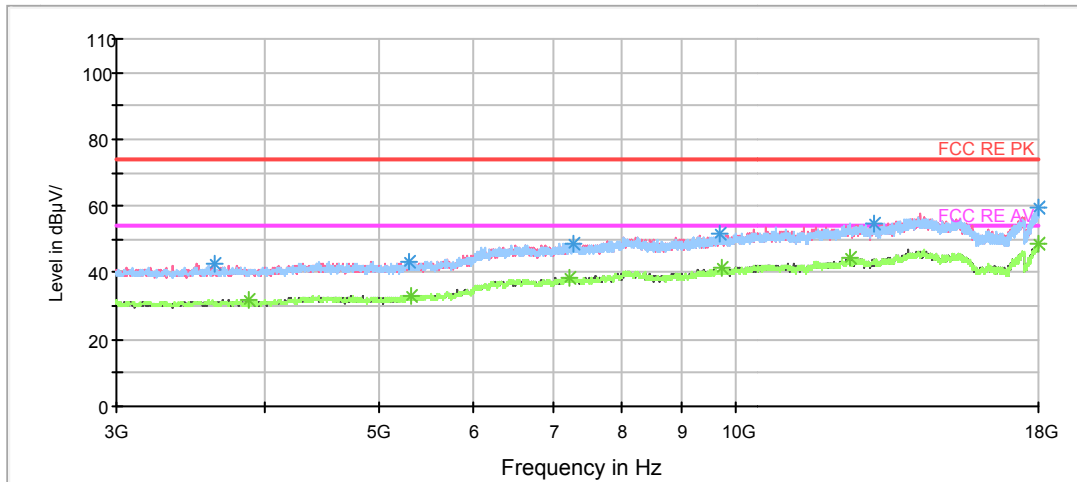

Radiates Emission from 3GHz to 18GHz

Frequency (MHz)	Peak (dBuV/m)	Height (cm)	Polarization	Azimuth (deg)	Reading value (dBuV/m)	Correct Factor (dB)	Margin (dB)	Limit (dBuV/m)
1060.250000	46.0	100.0	H	4.0	47.6	-1.6	28.0	74
1370.500000	47.1	200.0	H	290.0	47.4	-0.3	26.9	74
1710.250000	48.3	200.0	V	50.0	47.3	1.0	25.7	74
1999.750000	49.6	200.0	V	305.0	47.0	2.6	24.4	74
2691.750000	51.8	100.0	H	125.0	46.2	5.6	22.2	74
2888.500000	52.1	200.0	V	50.0	46.3	5.8	21.9	74

**Remark: 1. Correction Factor = Antenna factor+ Insertion loss (cable loss + amplifier gain)**

Frequency (MHz)	Average (dBuV/m)	Height (cm)	Polarization	Azimuth (deg)	Reading value (dBuV/m)	Correct Factor (dB)	Margin (dB)	Limit (dBuV/m)
1169.500000	35.8	100.0	V	234.0	37.1	-1.3	18.2	54
1368.500000	36.1	200.0	H	191.0	36.4	-0.3	17.9	54
1677.500000	38.1	200.0	V	168.0	37.0	1.1	15.9	54
2073.000000	39.3	200.0	H	219.0	36.0	3.3	14.7	54
2501.750000	41.8	200.0	V	5.0	36.5	5.3	12.2	54
2676.250000	41.6	200.0	H	0.0	36.0	5.6	12.4	54

**Remark: 1. Correction Factor = Antenna factor+ Insertion loss (cable loss + amplifier gain)**



Copy of FCC RE 1G-18GHz PK+AV Class B

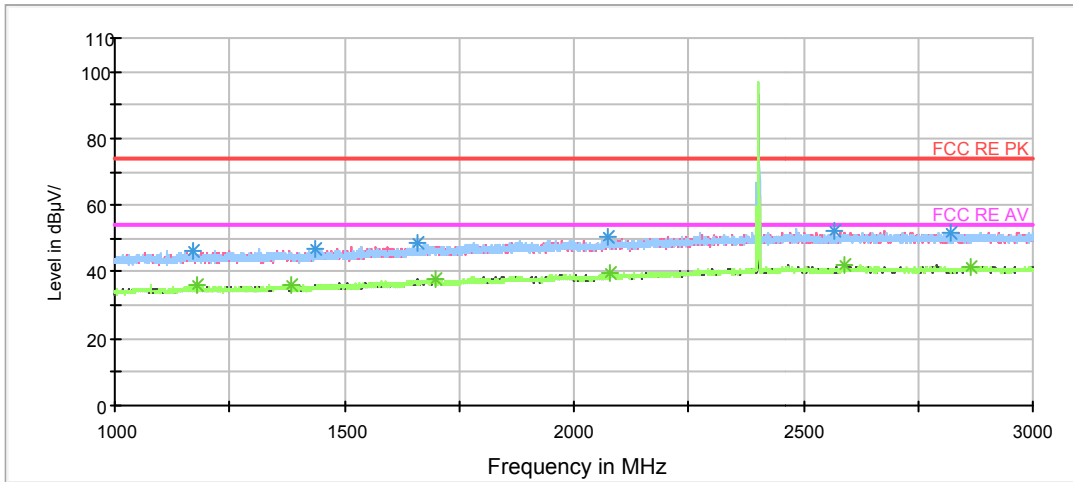

Note: The signal beyond the limit is carrier.  
Radiates Emission from 1GHz to 3GHz

Copy of FCC RE 1G-18GHz PK+AV Class B

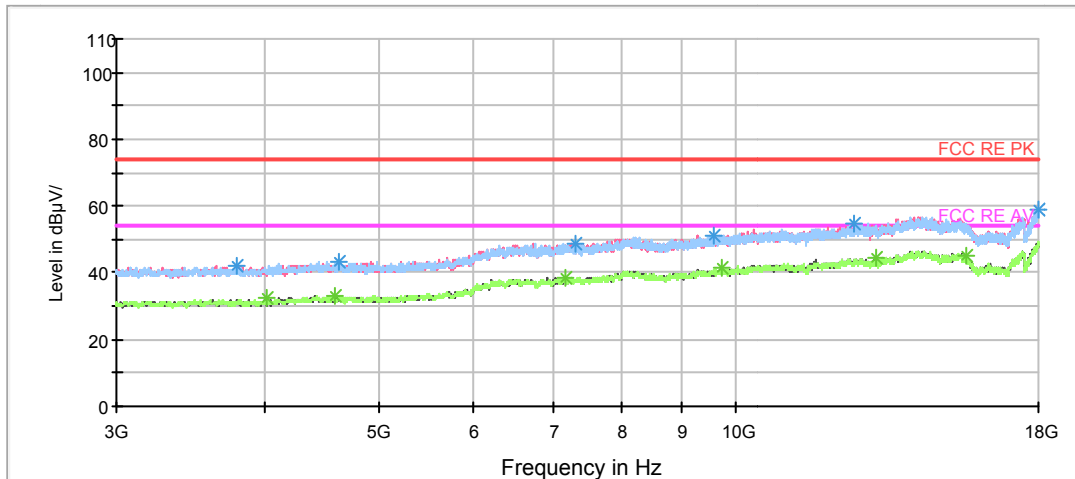

Radiates Emission from 3GHz to 18GHz

Frequency (MHz)	Peak (dBuV/m)	Height (cm)	Polarization	Azimuth (deg)	Reading value (dBuV/m)	Correct Factor (dB)	Margin (dB)	Limit (dBuV/m)
1168.750000	46.3	100.0	H	197.0	47.6	-1.3	27.7	74
1437.750000	47.2	100.0	H	5.0	47.5	-0.3	26.8	74
1660.250000	48.6	200.0	H	0.0	47.7	0.9	25.4	74
2072.250000	50.7	200.0	V	352.0	47.4	3.3	23.3	74
2565.750000	52.4	100.0	V	91.0	47.0	5.4	21.6	74
2822.500000	51.4	100.0	V	337.0	45.9	5.5	22.6	74

**Remark: 1. Correction Factor = Antenna factor+ Insertion loss (cable loss + amplifier gain)**

Frequency (MHz)	Average (dBuV/m)	Height (cm)	Polarization	Azimuth (deg)	Reading value (dBuV/m)	Correct Factor (dB)	Margin (dB)	Limit (dBuV/m)
1180.750000	35.8	200.0	V	285.0	37.1	-1.3	18.2	54
1384.000000	36.3	100.0	H	65.0	36.8	-0.5	17.7	54
1697.500000	37.9	200.0	H	124.0	36.6	1.3	16.1	54
2079.500000	39.5	200.0	V	252.0	36.1	3.4	14.5	54
2591.500000	42.0	100.0	V	124.0	36.4	5.6	12.0	54
2864.500000	41.2	200.0	V	71.0	35.5	5.7	12.8	54

**Remark: 1. Correction Factor = Antenna factor+ Insertion loss (cable loss + amplifier gain)**

Copy of FCC RE 1G-18GHz PK+AV Class B

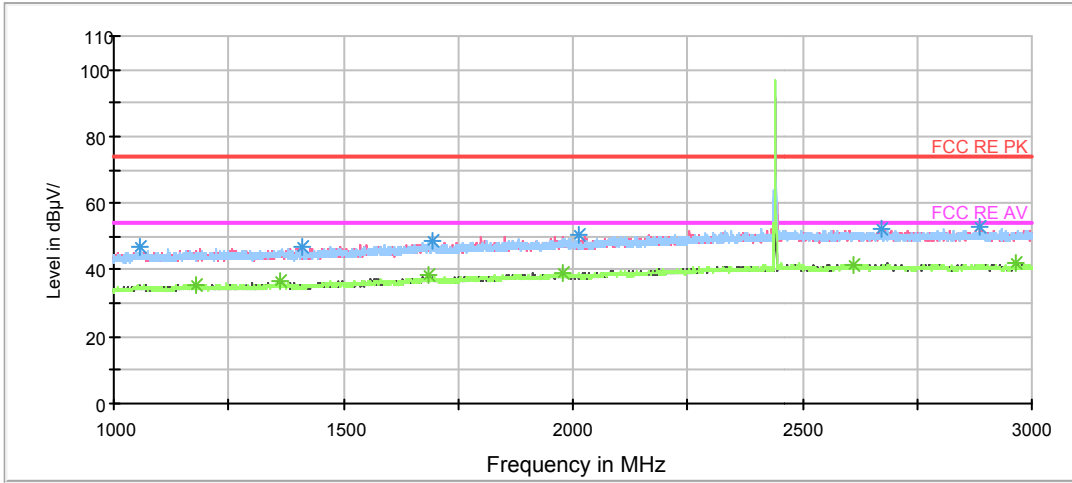

Note: The signal beyond the limit is carrier.  
Radiates Emission from 1GHz to 3GHz

Copy of FCC RE 1G-18GHz PK+AV Class B

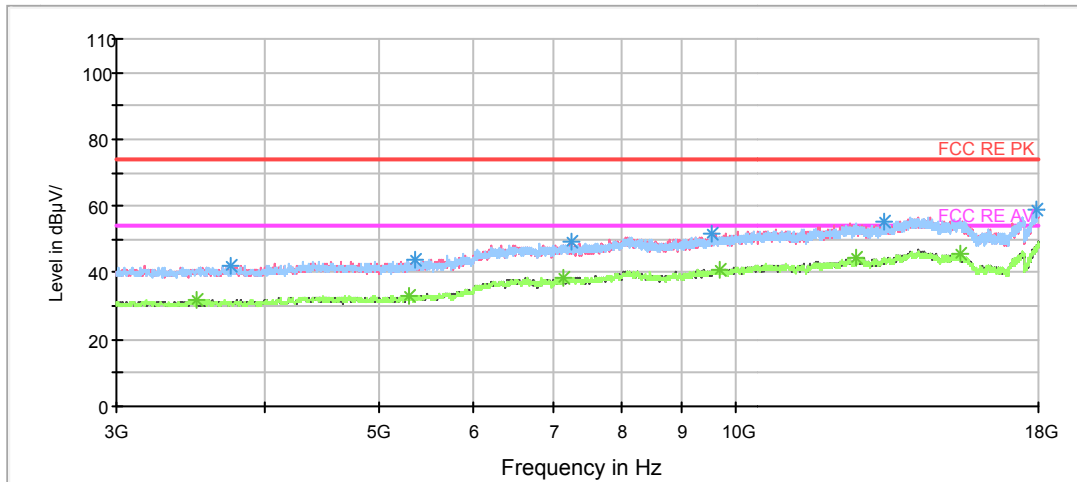

Radiates Emission from 3GHz to 18GHz



Frequency (MHz)	Peak (dBuV/m)	Height (cm)	Polarization	Azimuth (deg)	Reading value (dBuV/m)	Correct Factor (dB)	Margin (dB)	Limit (dBuV/m)
1058.750000	46.6	100.0	H	7.0	48.3	-1.7	27.4	74
1411.500000	46.7	100.0	V	0.0	47.2	-0.5	27.3	74
1693.250000	48.8	100.0	V	337.0	47.6	1.2	25.2	74
2013.000000	50.2	100.0	H	136.0	47.6	2.6	23.8	74
2674.500000	52.2	200.0	V	0.0	46.6	5.6	21.8	74
2887.000000	52.6	100.0	V	308.0	46.8	5.8	21.4	74

**Remark: 1. Correction Factor = Antenna factor+ Insertion loss (cable loss + amplifier gain)**

Frequency (MHz)	Average (dBuV/m)	Height (cm)	Polarization	Azimuth (deg)	Reading value (dBuV/m)	Correct Factor (dB)	Margin (dB)	Limit (dBuV/m)
1178.000000	35.6	100.0	H	0.0	36.9	-1.3	18.4	54
1361.500000	36.5	200.0	H	139.0	36.9	-0.4	17.5	54
1685.500000	38.2	200.0	V	13.0	37.1	1.1	15.8	54
1976.750000	39.3	100.0	H	165.0	36.6	2.7	14.7	54
2609.250000	41.4	200.0	V	19.0	36.0	5.4	12.6	54
2965.500000	41.9	200.0	V	188.0	36.2	5.7	12.1	54

**Remark: 1. Correction Factor = Antenna factor+ Insertion loss (cable loss + amplifier gain)**

Copy of FCC RE 1G-18GHz PK+AV Class B

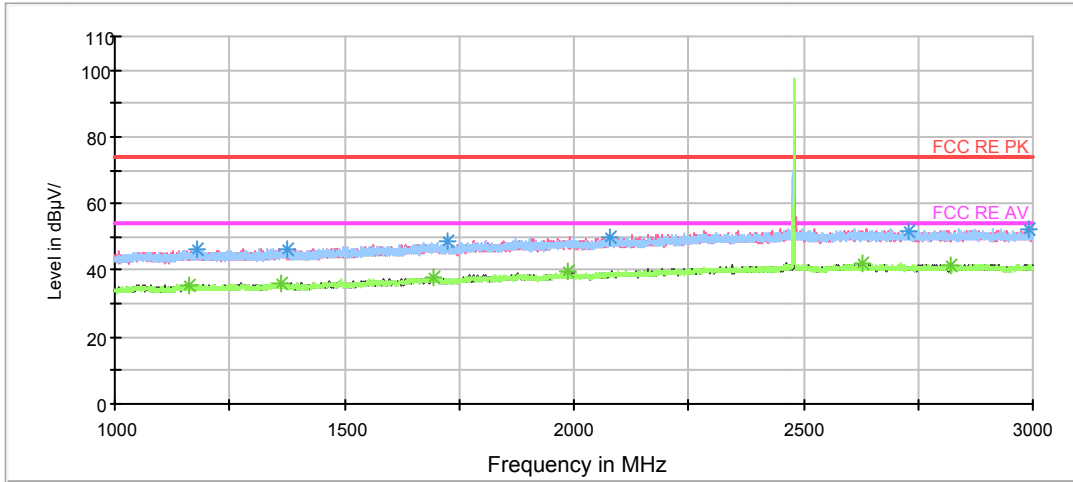

Note: The signal beyond the limit is carrier.  
Radiates Emission from 1GHz to 3GHz

Copy of FCC RE 1G-18GHz PK+AV Class B

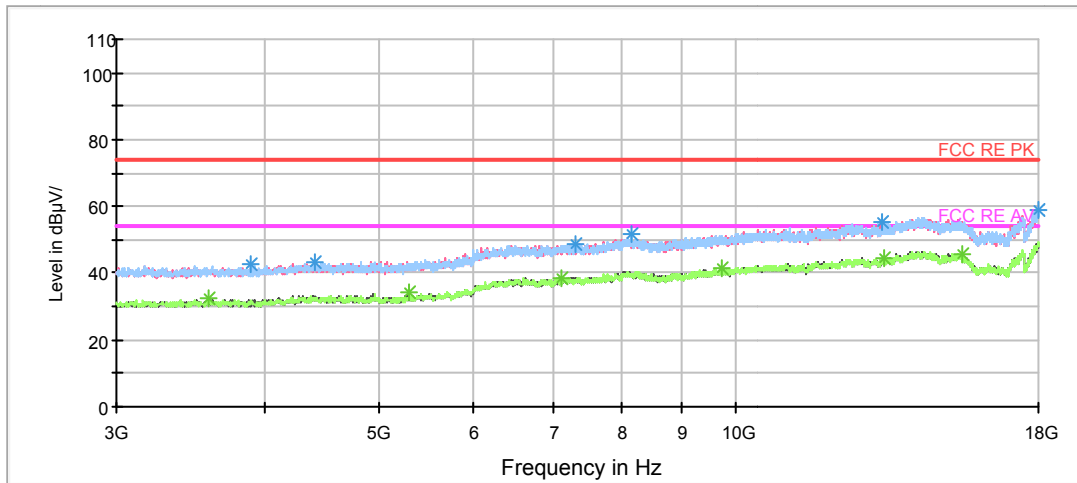

Radiates Emission from 3GHz to 18GHz

Frequency (MHz)	Peak (dBuV/m)	Height (cm)	Polarization	Azimuth (deg)	Reading value (dBuV/m)	Correct Factor (dB)	Margin (dB)	Limit (dBuV/m)
1179.750000	46.1	100.0	V	348.0	47.4	-1.3	27.9	74
1374.750000	46.6	100.0	H	112.0	47.0	-0.4	27.4	74
1722.750000	48.5	200.0	V	199.0	47.5	1.0	25.5	74
2079.750000	50.1	200.0	V	10.0	46.7	3.4	23.9	74
2730.250000	51.9	200.0	H	353.0	46.5	5.4	22.1	74
2991.250000	52.5	100.0	V	267.0	46.7	5.8	21.5	74

**Remark: 1. Correction Factor = Antenna factor+ Insertion loss (cable loss + amplifier gain)**

Frequency (MHz)	Average (dBuV/m)	Height (cm)	Polarization	Azimuth (deg)	Reading value (dBuV/m)	Correct Factor (dB)	Margin (dB)	Limit (dBuV/m)
1159.750000	35.7	100.0	V	71.0	37.0	-1.3	18.3	54
1362.750000	36.2	100.0	H	70.0	36.5	-0.3	17.8	54
1695.250000	37.7	100.0	H	98.0	36.5	1.2	16.3	54
1987.750000	39.4	100.0	V	352.0	36.7	2.7	14.6	54
2628.500000	41.8	200.0	V	6.0	36.4	5.4	12.2	54
2820.250000	41.3	100.0	H	2.0	35.8	5.5	12.7	54

**Remark: 1. Correction Factor = Antenna factor+ Insertion loss (cable loss + amplifier gain)**

## 4.2 Conducted Emission

### Ambient condition

Temperature	Relative humidity	Pressure
23°C ~25°C	45%~50%	101.5kPa

### Methods of Measurement

The EUT is placed on a non-metallic table of 80cm height above the horizontal metal reference ground plane. During the test, the EUT was operating in its typical mode. The test method is according to ANSI C63.10-2013. Connect the AC power line of the EUT to the L.I.S.N. Use EMI receiver to detect the average and Quasi-peak value. RBW is set to 9 kHz, VBW is set to 30kHz. The measurement result should include both L line and N line.

The test is in transmitting mode.

### Test Setup

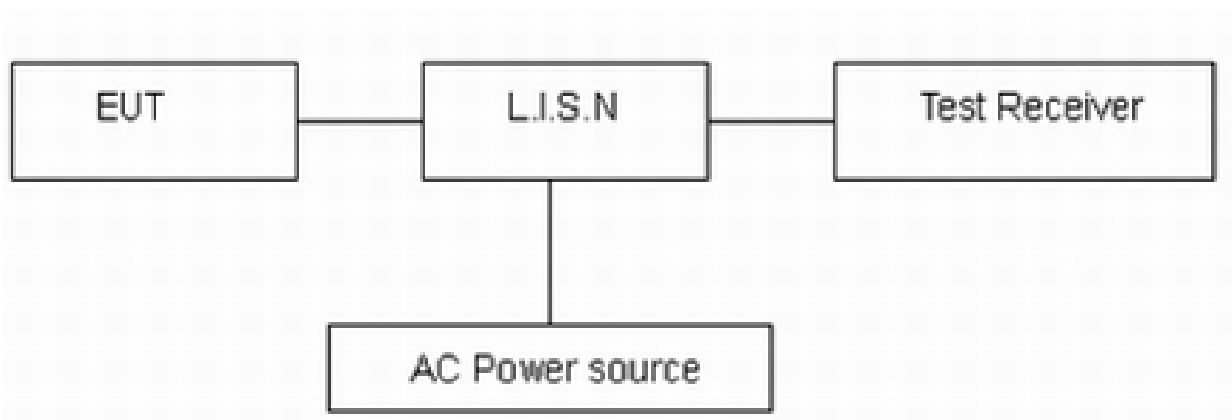

Note: AC Power source is used to 120V/60Hz.

### Limits

Frequency (MHz)	Conducted Limits(dBμV)	
	Quasi-peak	Average
0.15 - 0.5	66 to 56 *	56 to 46 *
0.5 - 5	56	46
5 - 30	60	50

\*: Decreases with the logarithm of the frequency.

### Measurement Uncertainty

The assessed measurement uncertainty to ensure 95% confidence level for the normal distribution is with the coverage factor  $k = 1.96$ ,  $U=2.69$  dB.

**Test Results:**

Following plots, Blue trace uses the peak detection, Green trace uses the average detection. During the test, the Conducted Emission was performed in all modes with all channels, BT **GFSK channel0**, are selected as the worst condition. The test data of the worst-case condition was recorded in this report.

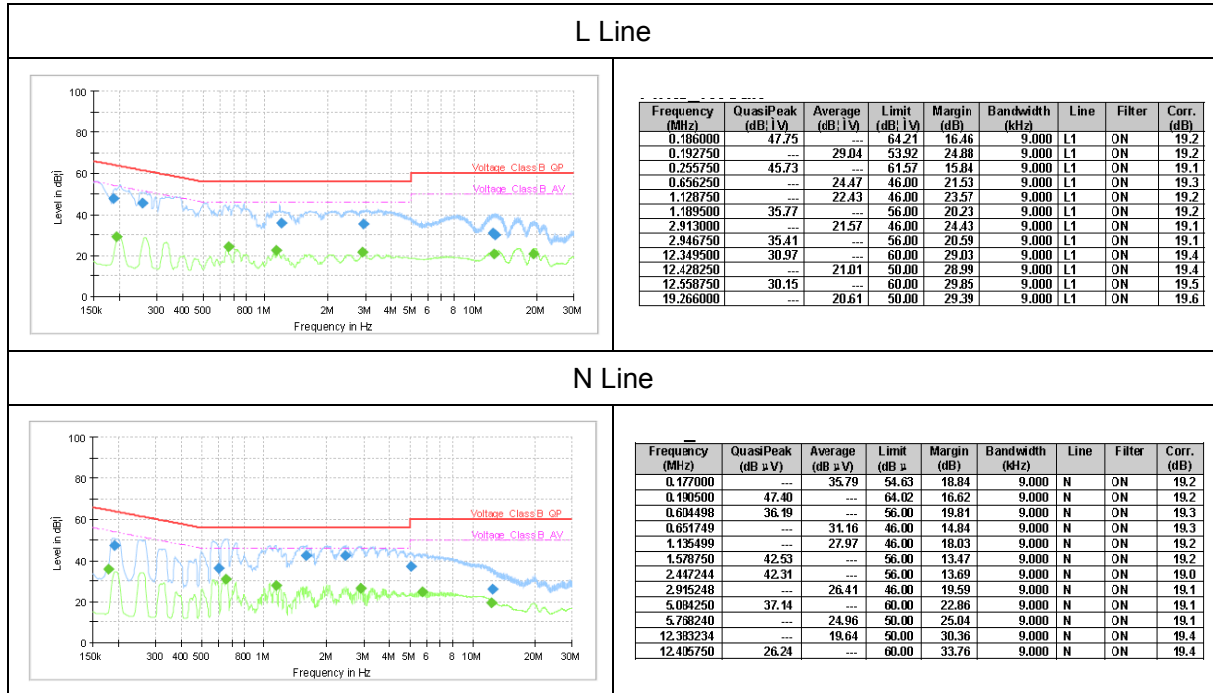

## 5 Main Test Instruments

Name	Manufacturer	Type	Serial Number	Calibration Date	Expiration Date
BT Base Station Simulator	R&S	CBT	100271	2018-05-20	2019-05-19
Loop Antenna	Schwarzbeck	FMZB1519	1519-047	2017-02-18	2020-02-17
EMI Test Receiver	R&S	ESR	101667	2017-09-06	2018-09-05
LISN	R&S	ENV216	101171	2016-12-16	2019-12-15
Signal Analyzer	R&S	FSV30	100815	2017-12-17	2018-12-16
EMI Test Receiver	R&S	ESCI	100948	2018-05-20	2019-05-19
TRILOG Broadband Antenna	Schwarzbeck	VULB 9163	9163-201	2017-11-18	2020-11-17
Double Ridged Waveguide Horn Antenna	R&S	HF907	100126	2014-12-06	2019-12-05
Spectrum Analyzer	Agilent	N9010A	MY47191109	2018-05-20	2019-05-19
Standard Gain Horn	ETS-Lindgren	3160-09	00102644	2015-01-30	2020-01-29
Software	R&S	EMC32	9.26.0	/	/

\*\*\*\*\*END OF REPORT \*\*\*\*\*