



RF TEST REPORT

Applicant Huawei Technologies Co., Ltd.
FCC ID QISJAT-LX3
Product Smart Phone
Model JAT-LX3
Report No. R1811H0154-R1V1
Issue Date December 18, 2018

TA Technology (Shanghai) Co., Ltd. tested the above equipment in accordance with the requirements in **FCC CFR47 Part 2 (2018)/ FCC CFR 47 Part 22H (2018)**. The test results show that the equipment tested is capable of demonstrating compliance with the requirements as documented in this report.

Performed by: Jiangpeng Lan

Approved by: Kai Xu

TA Technology (Shanghai) Co., Ltd.

No.145, Jintang Rd, Tangzhen Industry Park, Pudong Shanghai, China

TEL: +86-021-50791141/2/3

FAX: +86-021-50791141/2/3-8000



TABLE OF CONTENT

- 1. Test Laboratory4
 - 1.1. Notes of the Test Report 4
 - 1.2. Test facility.....4
 - 1.3. Testing Location 5
- 2. General Description of Equipment under Test.....6
- 3. Applied Standards.....8
- 4. Test Configuration.....9
- 5. Test Case Results11
 - 5.1. RF Power Output..... 11
 - 5.2. Effective Radiated Power 15
 - 5.3. Occupied Bandwidth 19
 - 5.4. Band Edge Compliance.....26
 - 5.5. Peak-to-Average Power Ratio (PAPR) 34
 - 5.6. Frequency Stability 37
 - 5.7. Spurious Emissions at Antenna Terminals42
 - 5.8. Radiates Spurious Emission 49
- 6. Main Test Instruments 54

Summary of measurement results

| No. | Test Type | Clause in FCC rules | Verdict |
|---|---|-----------------------------------|---------|
| 1 | RF power output | 2.1046 | PASS |
| 2 | Effective Radiated Power | 22.913(a)(5) | PASS |
| 3 | Occupied Bandwidth | 2.1049 | PASS |
| 4 | Band Edge Compliance | 2.1051 / 22.917(a) | PASS |
| 5 | Peak-to-Average Power Ratio | 22.913(d)/ KDB 971168 D01(5.7) | PASS |
| 6 | Frequency Stability | 2.1055 / 22.355 | PASS |
| 7 | Spurious Emissions at Antenna Terminals | 2.1051 / 22.917(a) | PASS |
| 8 | Radiates Spurious Emission | 2.1053 / 22.917 (a) | PASS |
| Date of Testing: November 11, 2018 ~ December 10, 2018 | | | |
| Note: PASS: The EUT complies with the essential requirements in the standard. FAIL: The EUT does not comply with the essential requirements in the standard. | | | |



1. Test Laboratory

1.1. Notes of the Test Report

This report shall not be reproduced in full or partial, without the written approval of **TA technology (shanghai) co., Ltd.** The results documented in this report apply only to the tested sample, under the conditions and modes of operation as described herein .Measurement Uncertainties were not taken into account and are published for informational purposes only. This report is written to support regulatory compliance of the applicable standards stated above.

1.2. Test facility

CNAS (accreditation number: L2264)

TA Technology (Shanghai) Co., Ltd. has obtained the accreditation of China National Accreditation Service for Conformity Assessment (CNAS).

FCC (Designation number: CN1179, Test Firm Registration Number: 446626)

TA Technology (Shanghai) Co., Ltd. has been listed on the US Federal Communications Commission list of test facilities recognized to perform electromagnetic emissions measurements.

IC (recognition number is 8510A)

TA Technology (Shanghai) Co., Ltd. has been listed by industry Canada to perform electromagnetic emission measurement.

VCCI (recognition number is C-4595, T-2154, R-4113, G-10766)

TA Technology (Shanghai) Co., Ltd. has been listed by industry Japan to perform electromagnetic emission measurement.

A2LA (Certificate Number: 3857.01)

TA Technology (Shanghai) Co., Ltd. has been listed by American Association for Laboratory Accreditation to perform electromagnetic emission measurement.



1.3. Testing Location

Company: TA Technology (Shanghai) Co., Ltd.
Address: No.145, Jintang Rd, Tangzhen Industry Park, Pudong
City: Shanghai
Post code: 201201
Country: P. R. China
Contact: Xu Kai
Telephone: +86-021-50791141/2/3
Fax: +86-021-50791141/2/3-8000
Website: <http://www.ta-shanghai.com>
E-mail: xukai@ta-shanghai.com

2. General Description of Equipment under Test

Client Information

| | |
|----------------------|--|
| Applicant | Huawei Technologies Co., Ltd. |
| Applicant address | Administration Building, Headquarters of Huawei Technologies Co., Ltd., Bantian, Longgang District Shenzhen 518129 P.R.China |
| Manufacturer | Huawei Technologies Co., Ltd. |
| Manufacturer address | Administration Building, Headquarters of Huawei Technologies Co., Ltd., Bantian, Longgang District Shenzhen 518129 P.R.China |

General Information

| EUT Description | | | |
|------------------------------|--|-----------|-----------|
| Model | JAT-LX3 | | |
| IMEI | IMEI 1:861844040014648 IMEI 2:861844040015942 | | |
| Hardware Version | HL1JATM | | |
| Software Version | 9.0.1.55(C900E61R1P4log) | | |
| Power Supply | Battery/AC adapter | | |
| Antenna Type | Internal Antenna | | |
| Antenna Gain | GSM 850: -2.1dBi WCDMA Band V: -2.1dBi LTE Band 5: -2.1dBi | | |
| Test Mode(s) | GSM 850; WCDMA Band V; LTE Band 5; | | |
| Test Modulation | (GSM)GMSK,8PSK; (WCDMA)QPSK; (LTE)QPSK 16QAM; | | |
| GPRS Multislot Class | 12 | | |
| EGPRS Multislot Class | 12 | | |
| HSDPA UE Category | 24 | | |
| HSUPA UE Category | 6 | | |
| DC-HSDPA UE Category | 24 | | |
| HSPA+ UE Category | 7 | | |
| LTE Category | 4 | | |
| Maximum E.R.P. | GSM 850: | 28.69dBm | |
| | WCDMA Band V: | 19.90dBm | |
| | LTE Band 5: | 18.94dBm | |
| Rated Power Supply Voltage | 3.82V | | |
| Extreme Voltage | Minimum: 3.6V Maximum: 4.4V | | |
| Extreme Temperature | Lowest: 0°C Highest: +35°C | | |
| Operating Frequency Range(s) | Band | Tx (MHz) | Rx (MHz) |
| | GSM850 | 824 ~ 849 | 869 ~ 894 |
| | WCDMA Band V | 824 ~ 849 | 869 ~ 894 |



| | LTE Band 5 | 824 ~ 849 | 869 ~ 894 |
|---|---|-----------|-----------|
| EUT Accessory | | | |
| Adapter 1 | Manufacturer: Huawei Technologies Co., Ltd. (SHENZHEN HUNTKEY ELECTRIC CO., LTD.) Model: HW-050100U01 | | |
| Adapter 2 | Manufacturer: Huawei Technologies Co., Ltd. (HUIZHOU BYD ELECTRONIC CO., LTD.) Model: HW-050100U01 | | |
| Adapter 3 | Manufacturer: Huawei Technologies Co., Ltd. (Dongguan Phitek Electronics Co., Ltd.) Model: HW-050100U01 | | |
| Battery 1 | Manufacturer: Huawei Technologies Co., Ltd. (Sunwoda Electronic Co.,LTD) Model: HB405979ECW | | |
| Battery 2 | Manufacturer: Huawei Technologies Co., Ltd. (SCUD (Fujian) Electronics Co., LTD.) Model: HB405979ECW | | |
| Battery 3 | Manufacturer: Huawei Technologies Co., Ltd. (Desay Battery Electronic Co.,LTD) Model: HB405979ECW | | |
| Earphone 1 | Manufacturer: Jiangxi Lianchuang Hongsheng Electronic Co. ,LTD. Model: MEND1532B528A02 | | |
| Earphone 2 | Manufacturer: Boluo County Quancheng Electronic Co.,Ltd. Model: 1293-3283-3.5MM-322 | | |
| USB Cable 1 | Manufacturer: HONGLIN TECHNOLOGY CO.,LTD. Model: 130-26654 | | |
| USB Cable 2 | Manufacturer: Dongguan Ming Ji Electronics Co.,Ltd. Model: 203-0786-0 | | |
| USB Cable 3 | Manufacturer: Luxshare Precision industry Co., Ltd. Model: L99U2013-CS-H | | |
| USB Cable 4 | Manufacturer: NingBo Broad Telecommunication Co., Ltd. Model: WA0007 | | |
| Note: 1. The information of the EUT is declared by the manufacturer. 2. There are more than one Adapter, Battery, Earphone and USB Cable, each one should be applied throughout the compliance test respectively, however, only the worst case (Adapter 1, Battery 1, Earphone 2 and USB Cable 4) will be recorded in this report. | | | |



3. Applied Standards

According to the specifications of the manufacturer, it must comply with the requirements of the following standards:

FCC CFR47 Part 2 (2018)

FCC CFR 47 Part 22H (2018)

ANSI C63.26 (2015)

KDB 971168 D01 Power Meas License Digital Systems v03r01

4. Test Configuration

There is more than one SIM card slot, each one should be applied throughout the compliance test respectively, and however, only the worst case (SIM 1) will be recorded in this report

Radiated measurements are performed by rotating the EUT in three different orthogonal test planes. EUT stand-up position (Z axis), lie-down position (X, Y axis). Receiver antenna polarization (horizontal and vertical), the worst emission was found in position (X axis, horizontal polarization) and the worst case was recorded.

All mode and data rates and positions were investigated. Subsequently, only the worst case emissions are reported.

The following testing in GSM/WCDMA/LTE is set based on the maximum RF Output Power.

Test modes are chosen to be reported as the worst case configuration below:

| Test items | Modes/Modulation | |
|---|--|--------------------------------------|
| | GSM 850 | WCDMA Band V |
| RF power output | GSM GPRS EGPRS | RMC HSDPA/HSUPA DC-HSDPA/HSPA+ |
| Effective Radiated Power | GSM GPRS(1Tx slot) EGPRS(1Tx slot) | RMC |
| Occupied Bandwidth | GSM GPRS(1Tx slot) EGPRS(1Tx slot) | RMC |
| Band Edge Compliance | GSM GPRS(1Tx slot) EGPRS(1Tx slot) | RMC |
| Peak-to-Average Power Ratio | GSM GPRS(1Tx slot) EGPRS(1Tx slot) | RMC |
| Frequency Stability | GSM GPRS(1Tx slot) EGPRS(1Tx slot) | RMC |
| Spurious Emissions at Antenna Terminals | GSM | RMC |
| Radiates Spurious Emission | GSM | RMC |



Test modes are chosen as the worst case configuration below for LTE Band 5.

| Test items | Bandwidth (MHz) | | | | Modulation | | RB | | | Test Channel | | |
|---|---|---|---|----|------------|-------|----|-----|------|--------------|---|---|
| | 1.4 | 3 | 5 | 10 | QPSK | 16QAM | 1 | 50% | 100% | L | M | H |
| RF power output | ○ | ○ | ○ | ○ | ○ | ○ | ○ | ○ | ○ | ○ | ○ | ○ |
| Effective Isotropic Radiated power | ○ | ○ | ○ | ○ | ○ | ○ | ○ | ○ | ○ | ○ | ○ | ○ |
| Occupied Bandwidth | ○ | ○ | ○ | ○ | ○ | ○ | - | - | ○ | - | ○ | - |
| Band Edge Compliance | ○ | ○ | ○ | ○ | ○ | ○ | ○ | - | ○ | ○ | - | ○ |
| Peak-to-Average Power Ratio | ○ | ○ | ○ | ○ | ○ | ○ | - | - | ○ | ○ | ○ | ○ |
| Frequency Stability | ○ | ○ | ○ | ○ | ○ | ○ | ○ | ○ | ○ | ○ | ○ | ○ |
| Spurious Emissions at Antenna Terminals | ○ | ○ | ○ | ○ | ○ | - | ○ | - | - | ○ | ○ | ○ |
| Radiates Spurious Emission | ○ | - | ○ | ○ | ○ | - | ○ | - | - | - | ○ | - |
| Note | 1. The mark "○" means that this configuration is chosen for testing. 2. The mark "-" means that this configuration is not testing. | | | | | | | | | | | |

5. Test Case Results

5.1. RF Power Output

Ambient condition

| Temperature | Relative humidity | Pressure |
|-------------|-------------------|----------|
| 23°C ~25°C | 45%~50% | 101.5kPa |

Methods of Measurement

During the process of the testing, The EUT is controlled by the Base Station Simulator to ensure max power transmission and proper modulation.

Test Setup

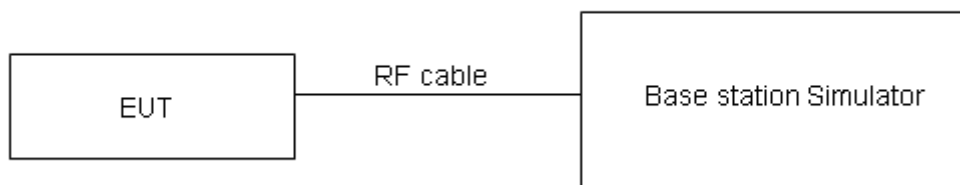

The loss between RF output port of the EUT and the input port of the tester has been taken into consideration.

Limits

No specific RF power output requirements in part 2.1046.

Measurement Uncertainty

The assessed measurement uncertainty to ensure 95% confidence level for the normal distribution is with the coverage factor $k = 2$, $U = 0.4$ dB.

Test Results

| GSM 850 | | Conducted Power(dBm) | | |
|----------------------|----------|----------------------|-------------|-------------|
| | | Channel 128 | Channel 190 | Channel 251 |
| | | 824.2 (MHz) | 836.6 (MHz) | 848.8 (MHz) |
| GSM | Results | 32.84 | 32.88 | 32.80 |
| GPRS/EGPRS (GMSK) | 1TXslot | 32.85 | 32.89 | 32.79 |
| | 2TXslots | 29.85 | 29.86 | 29.75 |
| | 3TXslots | 28.12 | 28.15 | 28.03 |
| | 4TXslots | 26.74 | 26.77 | 26.64 |
| EGPRS (8PSK) | 1TXslot | 27.25 | 27.58 | 27.02 |
| | 2TXslots | 24.13 | 24.05 | 24.23 |
| | 3TXslots | 22.41 | 22.47 | 22.45 |
| | 4TXslots | 21.14 | 21.18 | 21.09 |

| WCDMA Band V | | Conducted Power(dBm) | | |
|--------------|--------------|----------------------|--------------|--------------|
| | | Channel 4132 | Channel 4183 | Channel 4233 |
| | | 826.4(MHz) | 836.6(MHz) | 846.6(MHz) |
| RMC | 12.2k | 23.34 | 23.33 | 23.36 |
| AMR | 12.2k | 23.20 | 23.45 | 23.24 |
| HSDPA | Sub - Test 1 | 22.76 | 22.67 | 23.02 |
| | Sub - Test 2 | 22.74 | 22.91 | 23.02 |
| | Sub - Test 3 | 22.26 | 22.23 | 22.38 |
| | Sub - Test 4 | 22.48 | 22.33 | 22.26 |
| HSUPA | Sub - Test 1 | 21.30 | 21.17 | 21.34 |
| | Sub - Test 2 | 21.38 | 21.21 | 21.50 |
| | Sub - Test 3 | 22.38 | 22.17 | 22.34 |
| | Sub - Test 4 | 20.86 | 20.87 | 20.80 |
| | Sub - Test 5 | 22.34 | 22.45 | 22.34 |
| DC-HSDPA | Sub - Test 1 | 23.00 | 22.75 | 22.90 |
| | Sub - Test 2 | 22.76 | 22.69 | 23.00 |
| | Sub - Test 3 | 22.46 | 22.49 | 22.20 |
| | Sub - Test 4 | 22.30 | 22.37 | 22.50 |
| HSPA+ | 16QAM | 21.88 | 21.93 | 21.98 |

| LTE Band 5 | | | | Conducted Power(dBm) | | |
|------------|------------|---------|-----------|-------------------------|-------------|-------------|
| Bandwidth | Modulation | RB size | RB offset | Channel/Frequency (MHz) | | |
| | | | | 20407/824.7 | 20525/836.5 | 20643/848.3 |
| 1.4MHz | QPSK | 1 | 0 | 23.17 | 23.18 | 23.16 |
| | | 1 | 2 | 23.23 | 23.20 | 23.28 |
| | | 1 | 5 | 22.97 | 23.00 | 23.13 |
| | | 3 | 0 | 23.28 | 23.68 | 23.27 |
| | | 3 | 2 | 23.41 | 23.48 | 23.24 |
| | | 3 | 3 | 23.27 | 22.93 | 23.64 |
| | | 6 | 0 | 22.37 | 22.19 | 22.43 |
| | 16QAM | 1 | 0 | 22.62 | 22.81 | 22.86 |
| | | 1 | 2 | 22.82 | 22.67 | 23.13 |
| | | 1 | 5 | 22.02 | 22.41 | 22.77 |
| | | 3 | 0 | 22.25 | 22.04 | 22.43 |
| | | 3 | 2 | 22.51 | 22.29 | 21.88 |
| | | 3 | 3 | 22.12 | 21.91 | 21.93 |
| | | 6 | 0 | 21.27 | 21.30 | 21.05 |
| Bandwidth | Modulation | RB size | RB offset | Channel/Frequency (MHz) | | |
| | | | | 20415/825.5 | 20525/836.5 | 20635/847.5 |
| 3MHz | QPSK | 1 | 0 | 23.09 | 23.12 | 23.22 |
| | | 1 | 7 | 23.37 | 23.14 | 23.36 |
| | | 1 | 14 | 23.15 | 22.90 | 23.05 |
| | | 8 | 0 | 22.44 | 22.10 | 22.23 |
| | | 8 | 4 | 22.37 | 22.20 | 22.16 |
| | | 8 | 7 | 22.01 | 22.13 | 22.16 |
| | | 15 | 0 | 22.31 | 22.19 | 22.45 |
| | 16QAM | 1 | 0 | 22.66 | 22.71 | 22.82 |
| | | 1 | 7 | 22.88 | 22.83 | 23.01 |
| | | 1 | 14 | 22.32 | 22.43 | 22.75 |
| | | 8 | 0 | 21.65 | 21.44 | 21.49 |
| | | 8 | 4 | 21.13 | 21.51 | 21.28 |
| | | 8 | 7 | 21.20 | 21.25 | 21.31 |
| | | 15 | 0 | 21.51 | 21.46 | 21.05 |
| Bandwidth | Modulation | RB size | RB offset | Channel/Frequency (MHz) | | |
| | | | | 20425/826.5 | 20525/836.5 | 20625/846.5 |
| 5MHz | QPSK | 1 | 0 | 23.25 | 23.28 | 22.94 |
| | | 1 | 13 | 23.31 | 23.22 | 23.32 |
| | | 1 | 24 | 23.11 | 23.22 | 23.17 |
| | | 12 | 0 | 22.38 | 22.28 | 22.39 |
| | | 12 | 6 | 22.31 | 22.34 | 22.36 |
| | | 12 | 13 | 22.39 | 22.13 | 22.32 |
| | | 25 | 0 | 22.39 | 22.19 | 22.37 |



| | 16QAM | 1 | 0 | 22.72 | 22.67 | 22.74 |
|-----------|------------|---------|-----------|-------------------------|-------------|-----------|
| | | 1 | 13 | 22.82 | 22.93 | 22.87 |
| | | 1 | 24 | 22.58 | 22.57 | 22.63 |
| | | 12 | 0 | 21.41 | 21.36 | 21.21 |
| | | 12 | 6 | 21.41 | 21.41 | 21.16 |
| | | 12 | 13 | 21.32 | 21.35 | 21.37 |
| | | 25 | 0 | 21.37 | 21.22 | 21.41 |
| Bandwidth | Modulation | RB size | RB offset | Channel/Frequency (MHz) | | |
| | | | | 20450/829 | 20525/836.5 | 20600/844 |
| 10MHz | QPSK | 1 | 0 | 23.17 | 23.16 | 23.06 |
| | | 1 | 25 | 23.35 | 23.26 | 23.34 |
| | | 1 | 49 | 23.11 | 23.10 | 23.21 |
| | | 25 | 0 | 22.32 | 22.18 | 22.31 |
| | | 25 | 13 | 22.31 | 22.28 | 22.26 |
| | | 25 | 25 | 22.29 | 22.19 | 22.22 |
| | | 50 | 0 | 22.31 | 22.21 | 22.27 |
| | 16QAM | 1 | 0 | 22.68 | 22.67 | 22.62 |
| | | 1 | 25 | 22.84 | 22.79 | 22.83 |
| | | 1 | 49 | 22.54 | 22.53 | 22.59 |
| | | 25 | 0 | 21.35 | 21.28 | 21.35 |
| | | 25 | 13 | 21.27 | 21.25 | 21.24 |
| | | 25 | 25 | 21.28 | 21.23 | 21.25 |
| | | 50 | 0 | 21.31 | 21.26 | 21.29 |

5.2. Effective Radiated Power

Ambient condition

| Temperature | Relative humidity | Pressure |
|-------------|-------------------|----------|
| 23°C ~25°C | 45%~50% | 101.5kPa |

Methods of Measurement

The testing follows FCC KDB 971168 v03r01 Section 5.8 and ANSI C63.26 (2015).

- a) Connect the equipment as illustrated. Mount the equipment with the manufacturer specified antenna in a vertical orientation on a manufacturer specified mounting surface located on a non-conducting rotating platform of a RF anechoic chamber (preferred) or a standard radiation site.
- b) Key the transmitter, then rotate the EUT 360° azimuthally and record spectrum analyzer power level (LVL) measurements at angular increments that are sufficiently small to permit resolution of all peaks. If a standard radiation test site is used, raise and lower the test antenna to obtain a maximum reading at each angular increment. (Note: several batteries may be needed to offset the effect of battery voltage droop, which should not exceed 5% of the manufactured specified battery voltage during transmission).
- c) Replace the transmitter under test with a vertically polarized half-wave dipole (or an antenna whose gain is known relative to an ideal half-wave dipole). The center of the antenna should be at the same location as the center of the antenna under test.
- d) Connect the antenna to a signal generator with a known output power and record the path loss (in dB) as LOSS. If a standard radiation test site is used, raise and lower the test antenna to obtain a maximum reading. $LOSS = \text{Generator Output Power (dBm)} - \text{Analyzer reading (dBm)}$
- e) Determine the effective radiated output power at each angular position from the readings in steps b) and d) using the following equation: $ERP \text{ (dBm)} = LVL \text{ (dBm)} + LOSS \text{ (dB)}$
- f) The maximum ERP is the maximum value determined in the preceding step.
- g) When calculating ERP, in addition to knowing the antenna radiation and matching characteristics, it is necessary to know the loss values of all elements (e.g. transmission line attenuation, mismatches, filters, combiners) interposed between the point where transmitter output power is measured, and the point where power is applied to the antenna. ERP can then be calculated as follows:
 $EIRP \text{ (dBm)} = \text{Output Power (dBm)} - \text{Losses (dB)} + \text{Antenna Gain (dBi)}$
 where: dBd refers to gain relative to an ideal dipole.
 $EIRP \text{ (dBm)} = ERP \text{ (dBm)} + 2.15 \text{ (dB.)}$

The RB allocation refers to section 5.1, using the maximum output power configuration.

Test setup

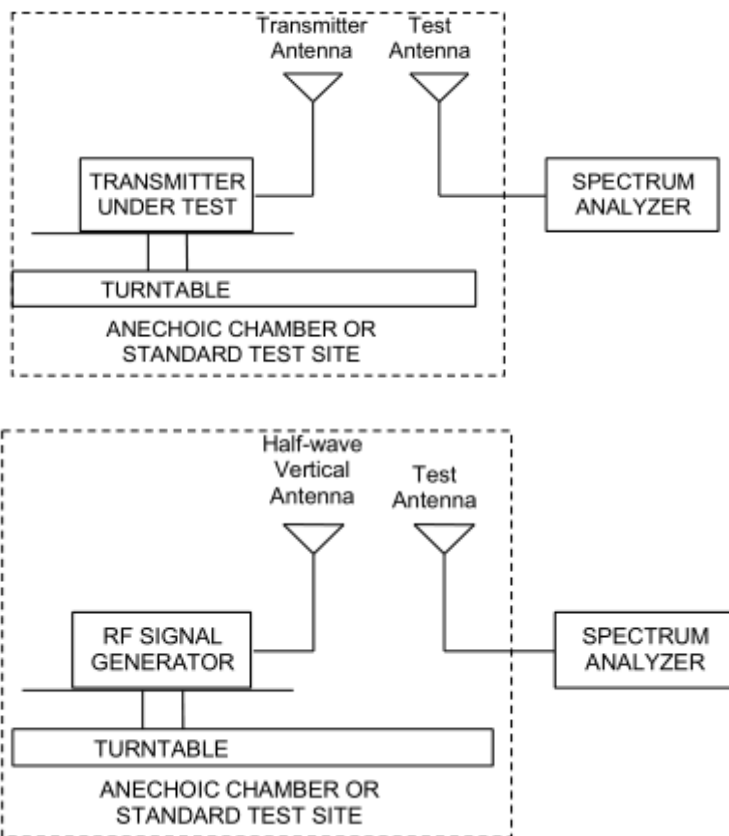

Limits

Rule Part 22.913(a)(5) specifies that "Mobile/portable stations are limited to 7 watts ERP".

| | |
|-------|--------------------------------|
| Limit | $\leq 7 \text{ W}$ (38.45 dBm) |
|-------|--------------------------------|

Measurement Uncertainty

The assessed measurement uncertainty to ensure 95% confidence level for the normal distribution is with the coverage factor $k = 2$, $U = 1.19 \text{ dB}$

**Test Results:**

The measurement is performed for both of horizontal and vertical antenna Polarization, and only the data of worst mode is recorded in this report.

| Mode | Channel | Frequency (MHz) | Polarization | ERP (dBm) | Limit (dBm) | Conclusion |
|--------------|---------|-----------------|--------------|-----------|-------------|------------|
| GSM 850 | Low | 824.2 | Horizontal | 28.34 | 38.45 | Pass |
| | Mid | 836.6 | Horizontal | 28.43 | 38.45 | Pass |
| | High | 848.8 | Horizontal | 28.69 | 38.45 | Pass |
| GPRS 850 | Low | 824.2 | Horizontal | 27.90 | 38.45 | Pass |
| | Mid | 836.6 | Horizontal | 27.95 | 38.45 | Pass |
| | High | 848.8 | Horizontal | 28.14 | 38.45 | Pass |
| EGPRS 850 | Low | 824.2 | Horizontal | 24.05 | 38.45 | Pass |
| | Mid | 836.6 | Horizontal | 25.38 | 38.45 | Pass |
| | High | 848.8 | Horizontal | 26.42 | 38.45 | Pass |
| WCDMA Band V | Low | 826.4 | Horizontal | 19.02 | 38.45 | Pass |
| | Mid | 836.6 | Horizontal | 19.63 | 38.45 | Pass |
| | High | 846.6 | Horizontal | 19.90 | 38.45 | Pass |

| LTE Band 5 | | | | | | |
|------------------------|---------|-----------------|--------------|-----------|-------------|------------|
| bandwidth | Channel | Frequency (MHz) | Polarization | ERP (dBm) | Limit (dBm) | Conclusion |
| 1.4 MHz (QPSK) | Low | 824.7 | Horizontal | 18.34 | 38.45 | Pass |
| | Mid | 836.5 | Horizontal | 18.75 | 38.45 | Pass |
| | High | 848.3 | Horizontal | 18.94 | 38.45 | Pass |
| 3 MHz (QPSK) | Low | 825.5 | Horizontal | 18.16 | 38.45 | Pass |
| | Mid | 836.5 | Horizontal | 18.78 | 38.45 | Pass |
| | High | 847.5 | Horizontal | 18.91 | 38.45 | Pass |
| 5 MHz (QPSK) | Low | 826.5 | Horizontal | 18.28 | 38.45 | Pass |
| | Mid | 836.5 | Horizontal | 18.69 | 38.45 | Pass |
| | High | 846.5 | Horizontal | 18.86 | 38.45 | Pass |
| 10 MHz (QPSK) | Low | 829 | Horizontal | 18.06 | 38.45 | Pass |
| | Mid | 836.5 | Horizontal | 18.44 | 38.45 | Pass |
| | High | 844 | Horizontal | 18.80 | 38.45 | Pass |
| 1.4 MHz (16QAM) | Low | 824.7 | Horizontal | 17.86 | 38.45 | Pass |
| | Mid | 836.5 | Horizontal | 18.33 | 38.45 | Pass |
| | High | 848.3 | Horizontal | 18.52 | 38.45 | Pass |
| 3 MHz (16QAM) | Low | 825.5 | Horizontal | 17.74 | 38.45 | Pass |
| | Mid | 836.5 | Horizontal | 18.22 | 38.45 | Pass |
| | High | 847.5 | Horizontal | 18.39 | 38.45 | Pass |
| 5 MHz (16QAM) | Low | 826.5 | Horizontal | 17.83 | 38.45 | Pass |
| | Mid | 836.5 | Horizontal | 18.14 | 38.45 | Pass |
| | High | 846.5 | Horizontal | 18.52 | 38.45 | Pass |
| 10 MHz (16QAM) | Low | 829 | Horizontal | 17.60 | 38.45 | Pass |
| | Mid | 836.5 | Horizontal | 17.88 | 38.45 | Pass |
| | High | 844 | Horizontal | 18.34 | 38.45 | Pass |

5.3. Occupied Bandwidth

Ambient condition

| Temperature | Relative humidity | Pressure |
|-------------|-------------------|----------|
| 23°C ~25°C | 45%~50% | 101.5kPa |

Method of Measurement

The EUT was connected to Spectrum Analyzer and Base Station Simulator via power Splitter. The occupied bandwidth is measured using spectrum analyzer.

RBW is set to 3kHz, VBW is set to 10kHz for GSM 850,

RBW is set to 51kHz, VBW is set to 160kHz for WCDMA Band V,

RBW is set to 51 kHz, VBW is set to 160 kHz for LTE Band 5 (1.4MHz),

RBW is set to 100 kHz, VBW is set to 300 kHz for LTE Band 5 (3MHz/5MHz),

RBW is set to 300 kHz, VBW is set to 1 MHz for LTE Band 5 (10MHz),

99% power and -26dBc occupied bandwidths are recorded. Spectrum analyzer plots are included on the following pages.

Test Setup

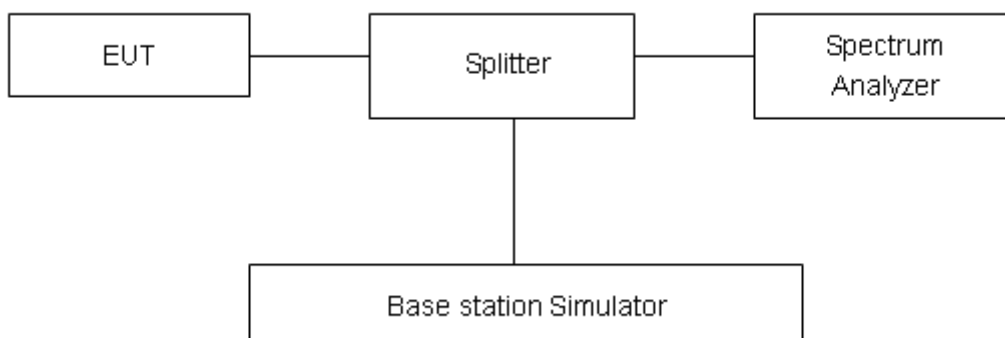

Limits

No specific occupied bandwidth requirements in part 2.1049.

Measurement Uncertainty

The assessed measurement uncertainty to ensure 95% confidence level for the normal distribution is with the coverage factor $k = 2$, $U = 624\text{Hz}$.



Test Result

| Mode | Channel | Frequency (MHz) | 99% Power Bandwidth (MHz) | -26dBc Bandwidth(MHz) |
|--------------------------|---------|-----------------|---------------------------|-----------------------|
| GSM 850 (GSM) | 128 | 824.2 | 0.249 | 0.309 |
| | 190 | 836.6 | 0.245 | 0.308 |
| | 251 | 848.8 | 0.246 | 0.311 |
| GPRS 850 (GMSK) | 128 | 824.2 | 0.246 | 0.314 |
| | 190 | 836.6 | 0.247 | 0.318 |
| | 251 | 848.8 | 0.246 | 0.313 |
| EGPRS 850 (8-PSK) | 128 | 824.2 | 0.246 | 0.310 |
| | 190 | 836.6 | 0.246 | 0.313 |
| | 251 | 848.8 | 0.246 | 0.311 |
| WCDMA Band V (RMC) | 4132 | 826.4 | 4.171 | 4.693 |
| | 4183 | 836.6 | 4.175 | 4.673 |
| | 4233 | 846.6 | 4.157 | 4.657 |



| LTE Band 5 | | | | | | |
|------------|------------|-----------------|---------|-----------------|--------------------------|-----------------------|
| RB | Modulation | Bandwidth (MHz) | Channel | Frequency (MHz) | 99% Power Bandwidth(MHz) | -26dBc Bandwidth(MHz) |
| 100% | QPSK | 1.4 | 20525 | 836.5 | 1.110 | 1.295 |
| | | 3 | 20525 | 836.5 | 2.722 | 2.942 |
| | | 5 | 20525 | 836.5 | 4.496 | 4.805 |
| | | 10 | 20525 | 836.5 | 9.049 | 9.735 |
| | 16QAM | 1.4 | 20525 | 836.5 | 1.110 | 0.267 |
| | | 3 | 20525 | 836.5 | 2.725 | 2.950 |
| | | 5 | 20525 | 836.5 | 4.496 | 4.795 |
| | | 10 | 20525 | 836.5 | 9.062 | 9.726 |

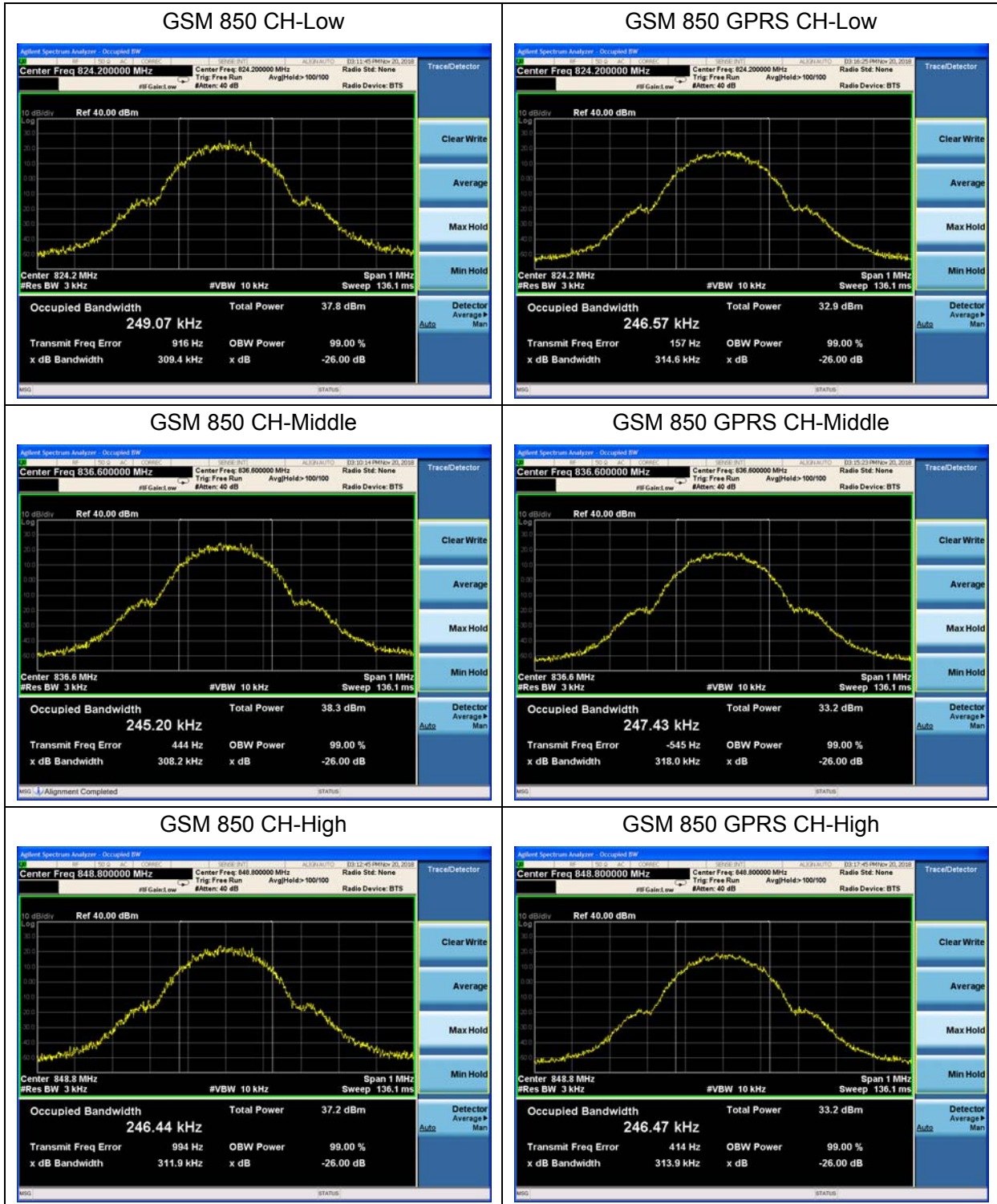

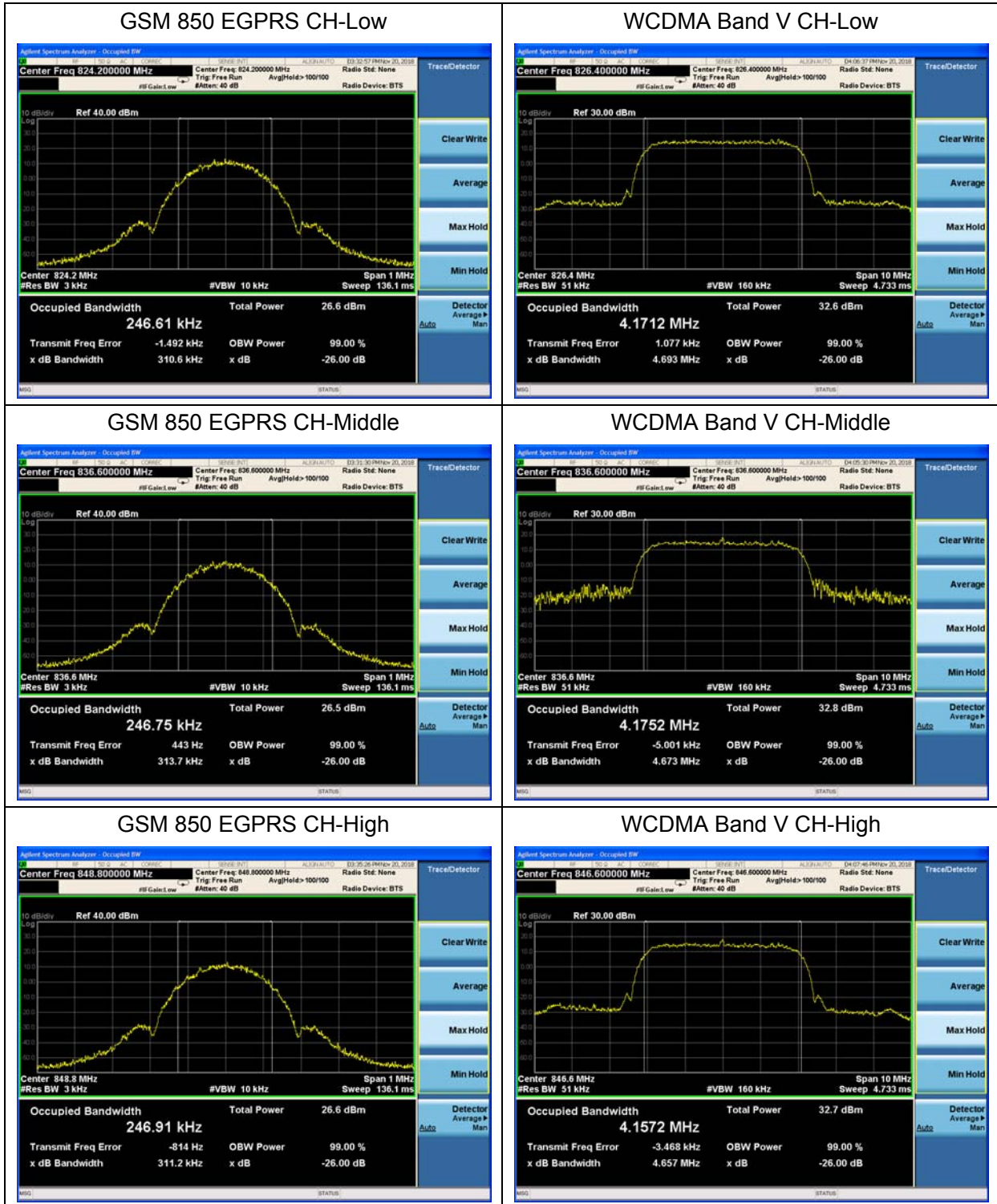

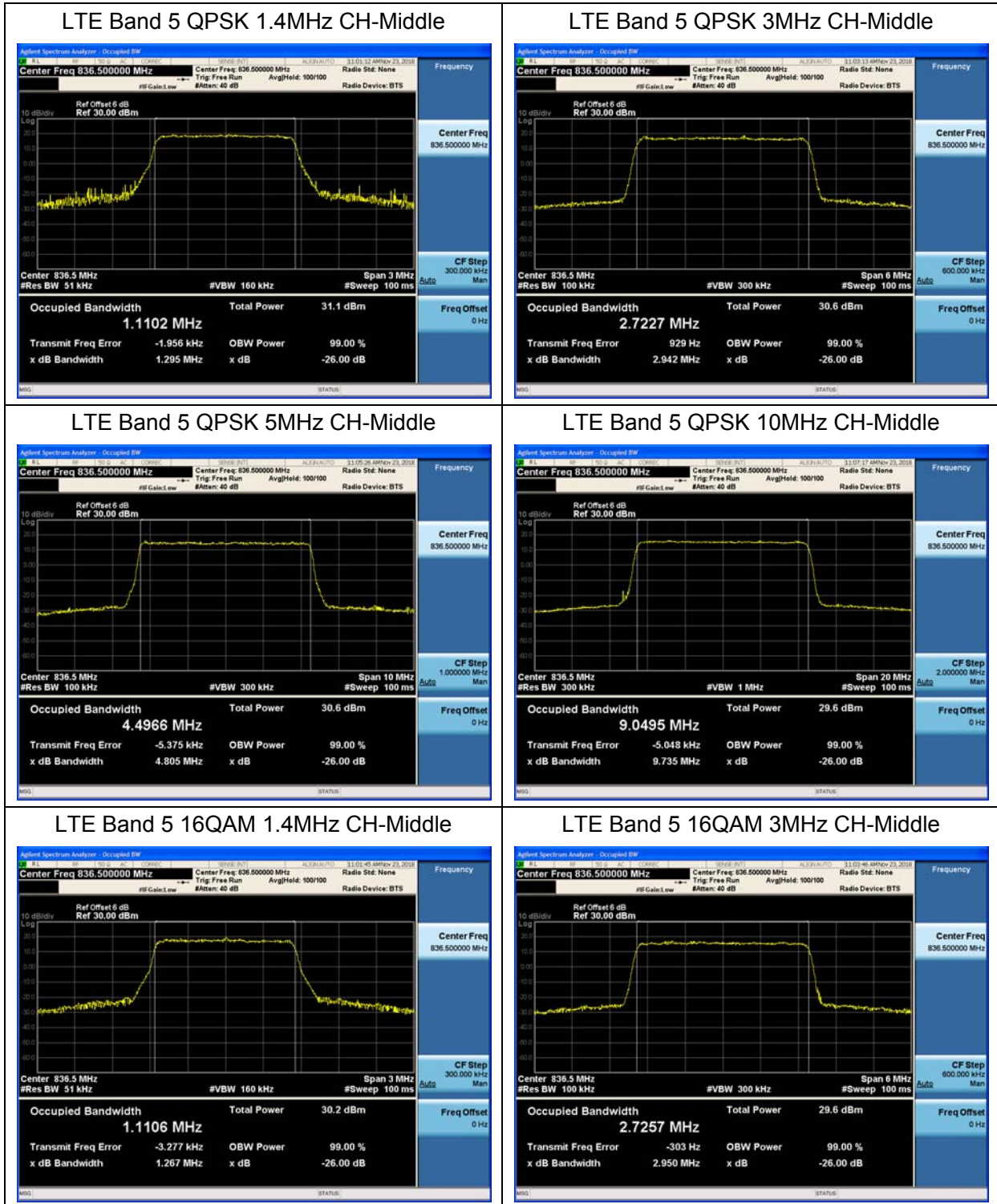

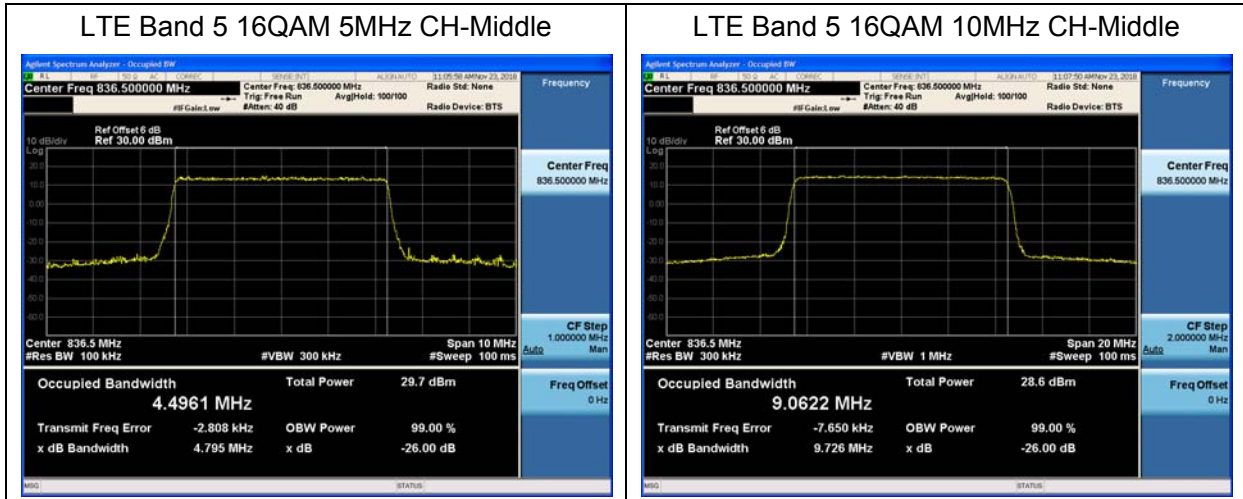

5.4. Band Edge Compliance

Ambient condition

| Temperature | Relative humidity | Pressure |
|-------------|-------------------|----------|
| 23°C ~25°C | 45%~50% | 101.5kPa |

Method of Measurement

The EUT was connected to Spectrum Analyzer and Base Station Simulator via power Splitter. The band edge of the lowest and highest channels were measured. The average detector is used. RBW is set to 3kHz,VBW is set to 10kHz for GSM 850, RBW is set to 51kHz,VBW is set to 160kHz for WCDMA Band V, RBW is set to 15 kHz, VBW is set to 51 kHz for LTE Band 5 (1.4MHz), RBW is set to 30 kHz, VBW is set to 100 kHz for LTE Band 5 (3MHz), RBW is set to 51 kHz, VBW is set to 160 kHz for LTE Band 5 (5MHz), RBW is set to 100 kHz, VBW is set to 300 kHz for LTE Band 5 (10MHz), Spectrum analyzer plots are included on the following pages.

Test Setup

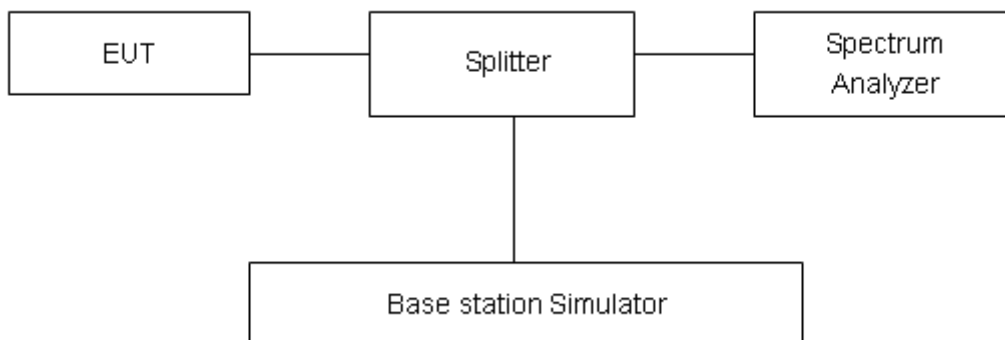

Limits

Rule Part 22.917(a) specifies that “The power of any emission outside of the authorized operating frequency ranges must be attenuated below the transmitting power (P) by a factor of at least 43 + 10 log(P) dB.”

| | |
|-------|---------|
| Limit | -13 dBm |
|-------|---------|

Measurement Uncertainty

The assessed measurement uncertainty to ensure 95% confidence level for the normal distribution is with the coverage factor $k = 1.96$, $U=0.684$ dB.



Test Result:

GSM 850 CH-Low

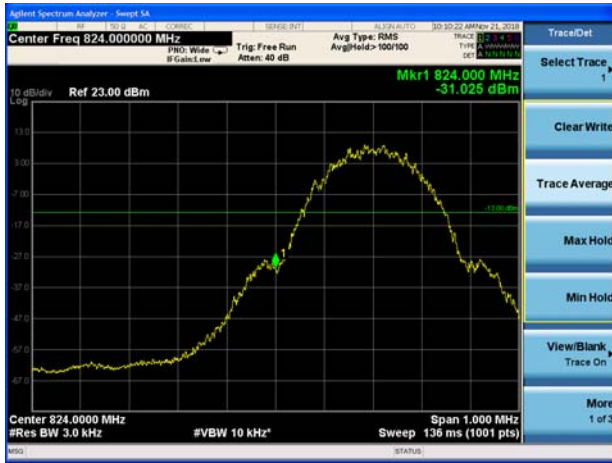

GSM 850 CH-High



GSM 850 GPRS CH-Low

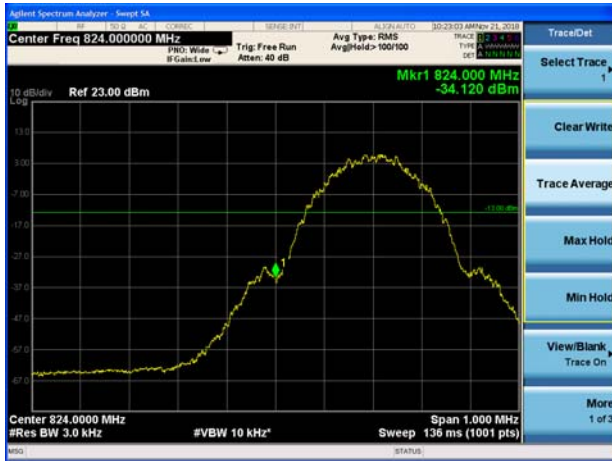

GSM 850 GPRS CH-High



GSM 850 EGPRS CH-Low

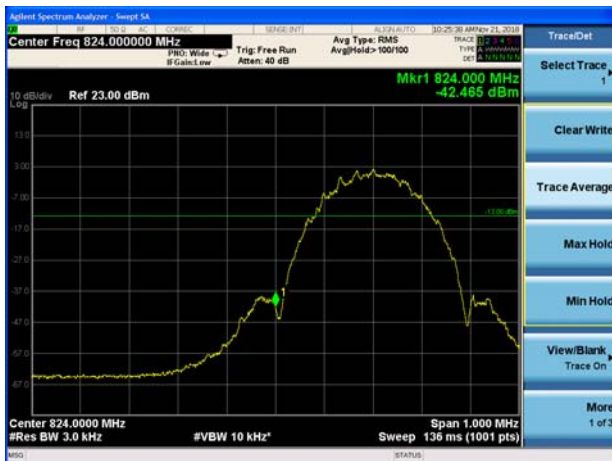

GSM 850 EGPRS CH-High





WCDMA Band V CH-Low



WCDMA Band V CH-High



LTE Band 5 QPSK 1.4MHz CH-Low 1RB

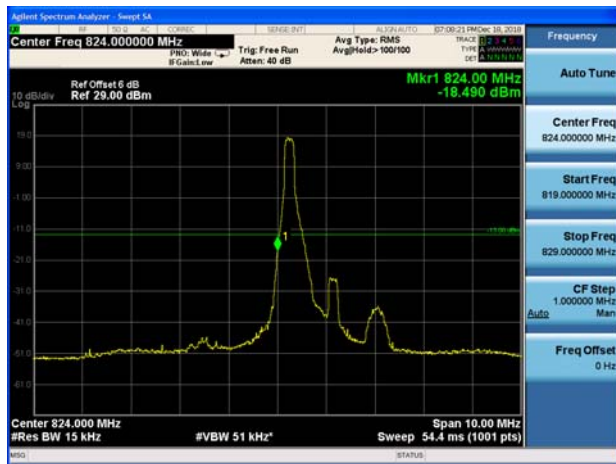

LTE Band 5 QPSK 1.4MHz CH-High 1RB

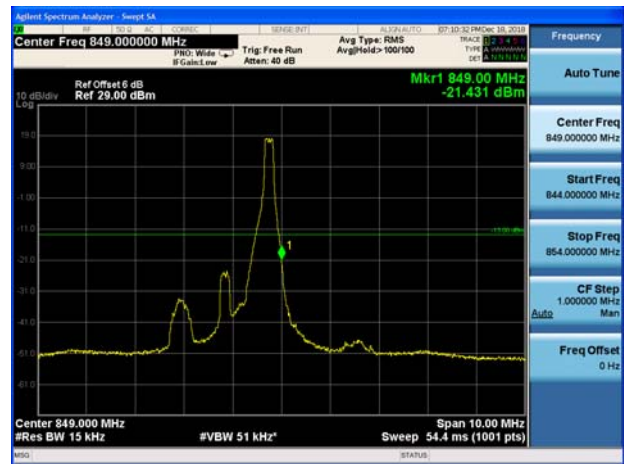

LTE Band 5 QPSK 1.4MHz CH-Low 100%RB

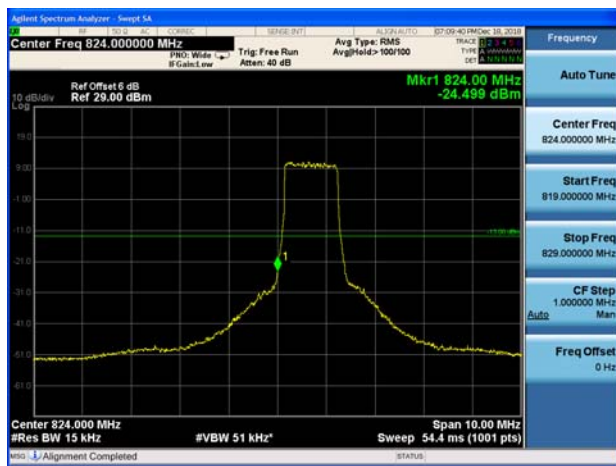

LTE Band 5 QPSK 1.4MHz CH-High 100%RB

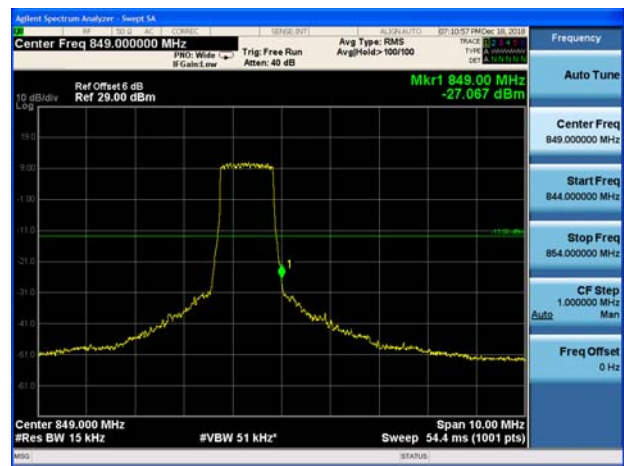



LTE Band 5 QPSK 3MHz CH-Low 1RB

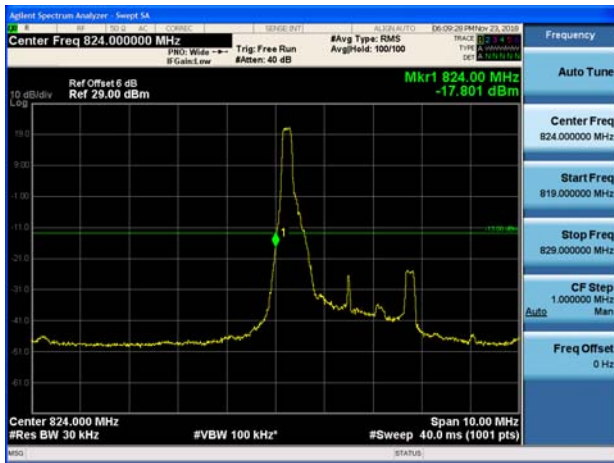

LTE Band 5 QPSK 3MHz CH-High 1RB

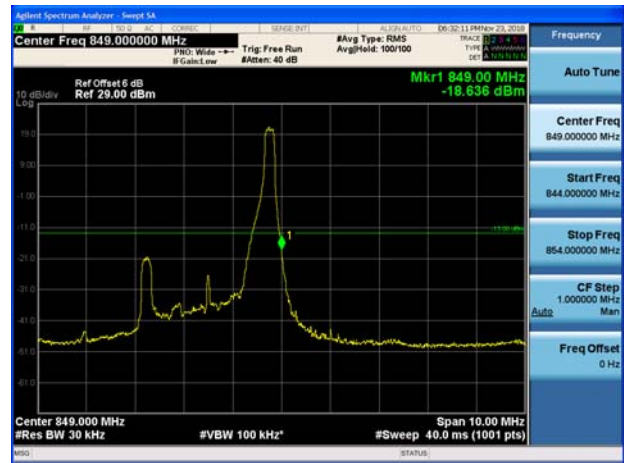

LTE Band 5 QPSK 3MHz CH-Low 100%RB

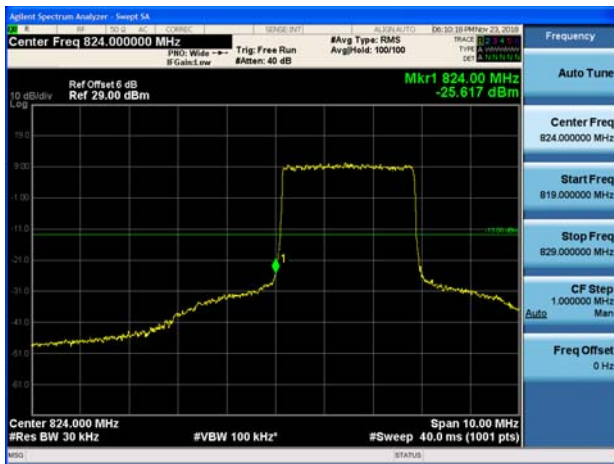

LTE Band 5 QPSK 3MHz CH-High 100%RB

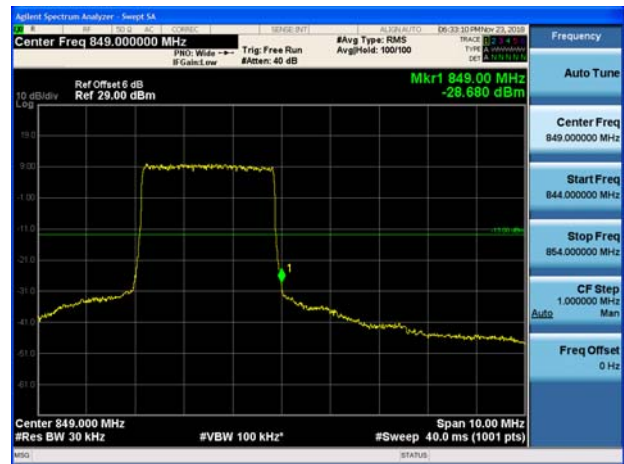

LTE Band 5 QPSK 5MHz CH-Low 1RB

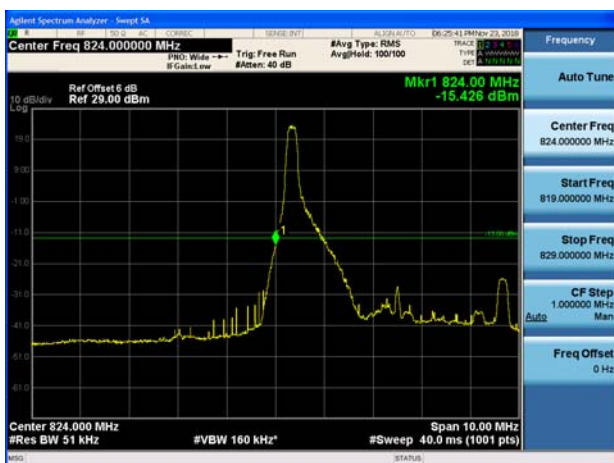

LTE Band 5 QPSK 5MHz CH-High 1RB

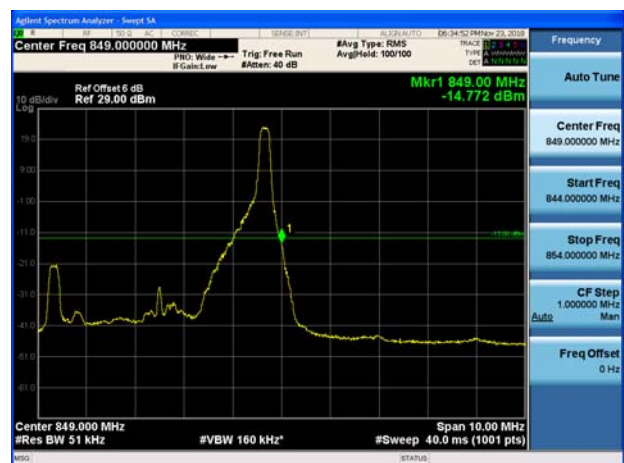



LTE Band 5 QPSK 5MHz CH-Low 100%RB



LTE Band 5 QPSK 5MHz CH-High 100%RB



LTE Band 5 QPSK 10MHz CH-Low 1RB

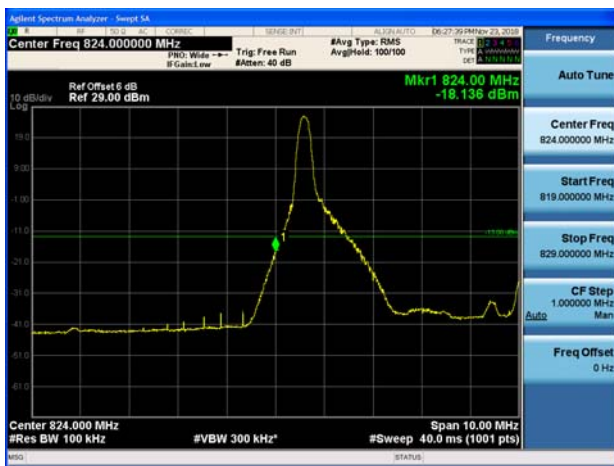

LTE Band 5 QPSK 10MHz CH-High 1RB

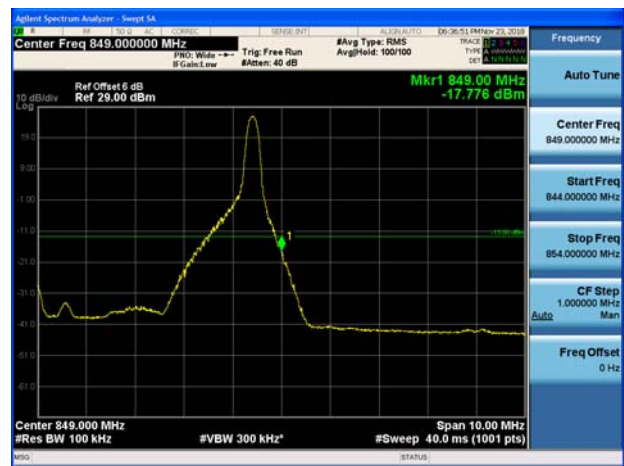

LTE Band 5 QPSK 10MHz CH-Low 100%RB

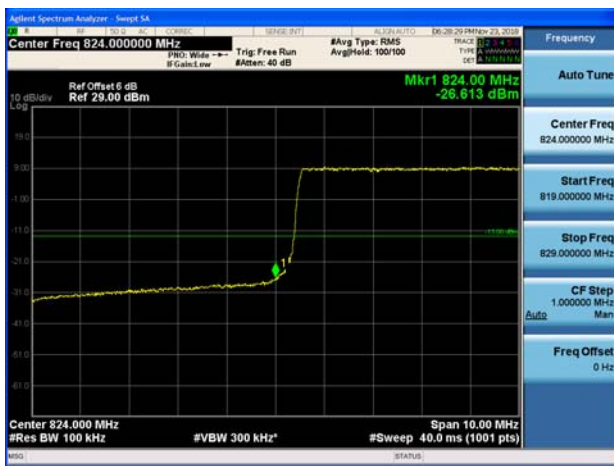

LTE Band 5 QPSK 10MHz CH-High 100%RB





LTE Band 5 16QAM 1.4MHz CH-Low 1RB

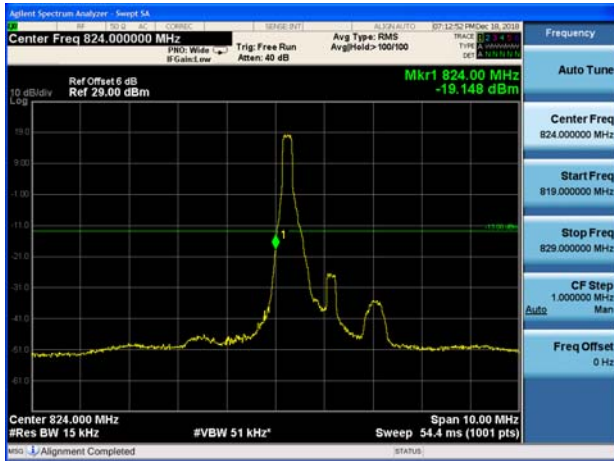

LTE Band 5 16QAM 1.4MHz CH-High 1RB

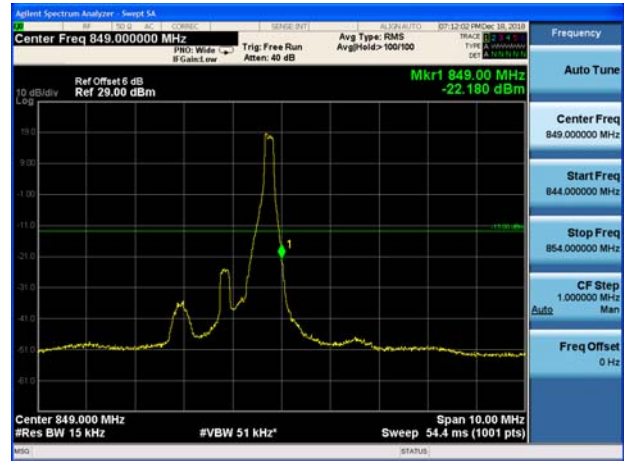

LTE Band 5 16QAM 1.4MHz CH-Low 100%RB

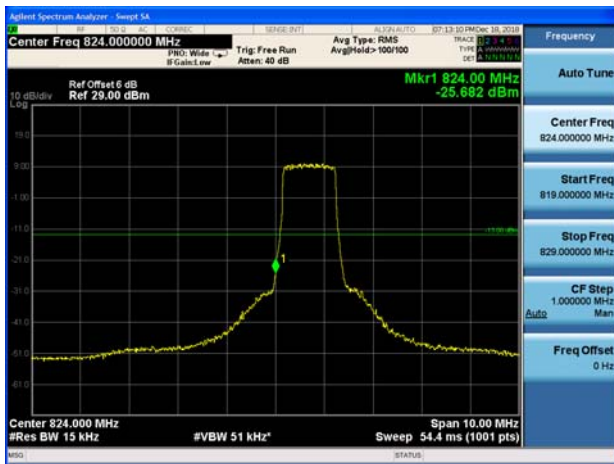

LTE Band 5 16QAM 1.4MHz CH-High 100%RB

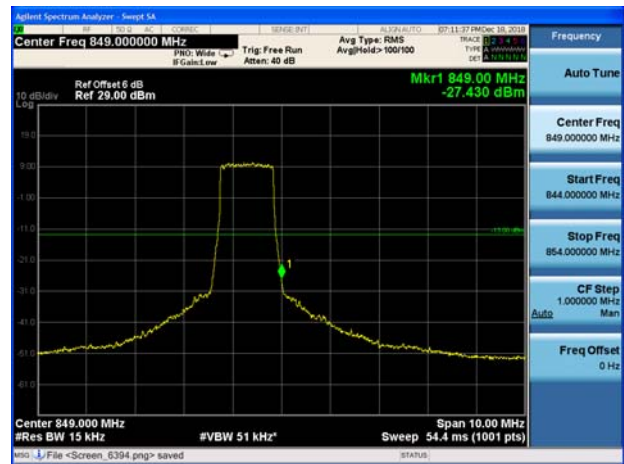

LTE Band 5 16QAM 3MHz CH-Low 1RB

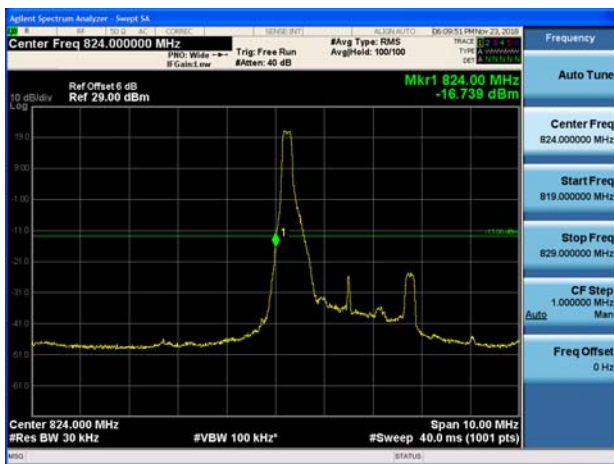

LTE Band 5 16QAM 3MHz CH-High 1RB

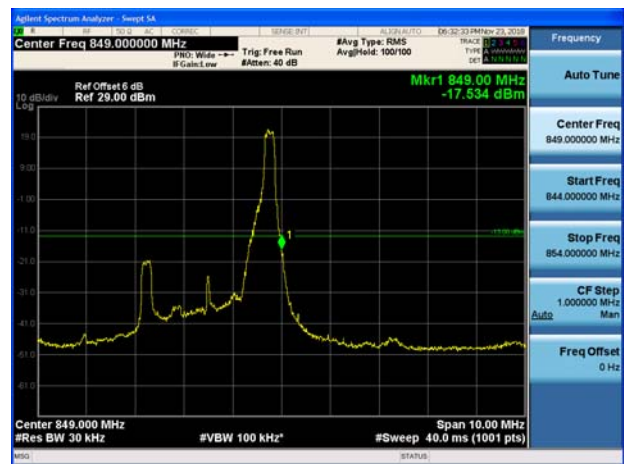



LTE Band 5 16QAM 3MHz CH-Low 100%RB

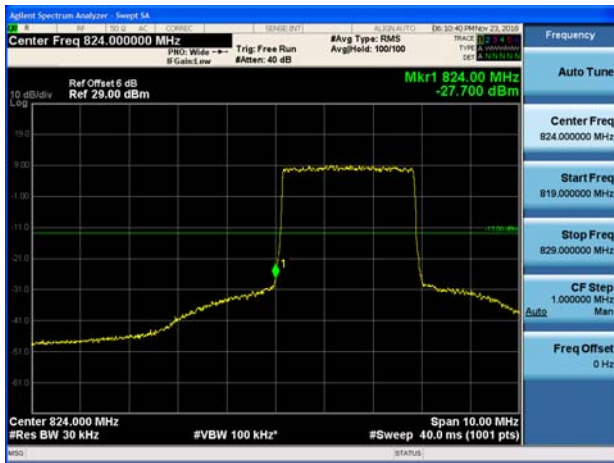

LTE Band 5 16QAM 3MHz CH-High 100%RB



LTE Band 5 16QAM 5MHz CH-Low 1RB

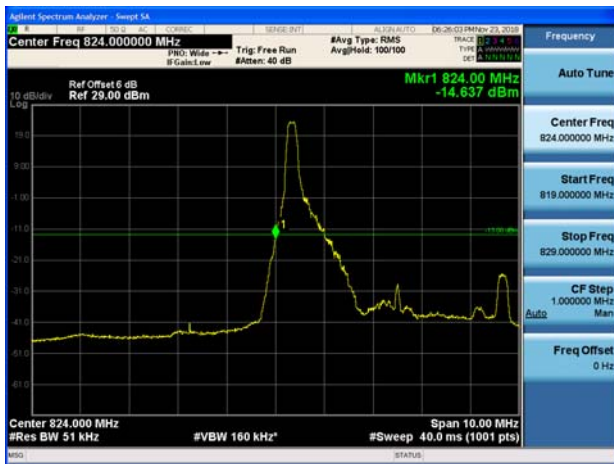

LTE Band 5 16QAM 5MHz CH-High 1RB

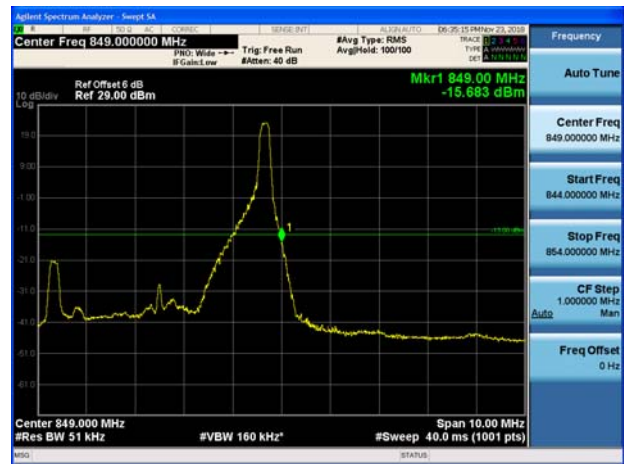

LTE Band 5 16QAM 5MHz CH-Low 100%RB

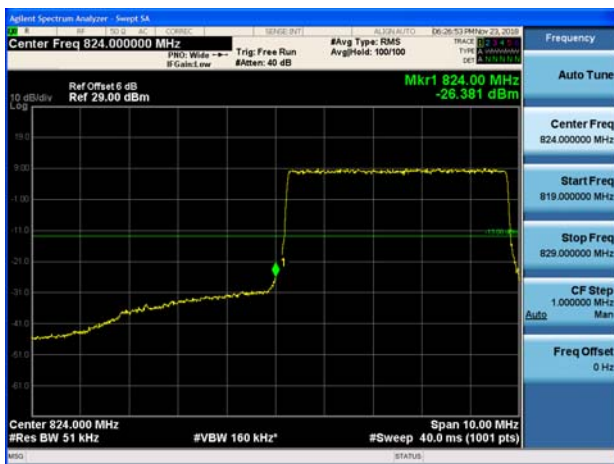

LTE Band 5 16QAM 5MHz CH-High 100%RB





LTE Band 5 16QAM 10MHz CH-Low 1RB

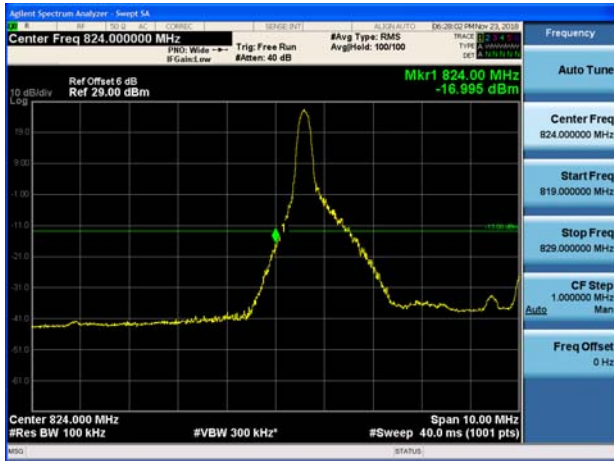

LTE Band 5 16QAM 10MHz CH-High 1RB

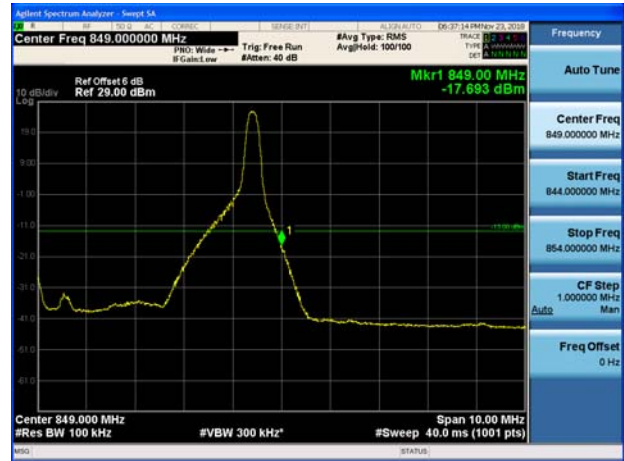

LTE Band 5 16QAM 10MHz CH-Low 100%RB

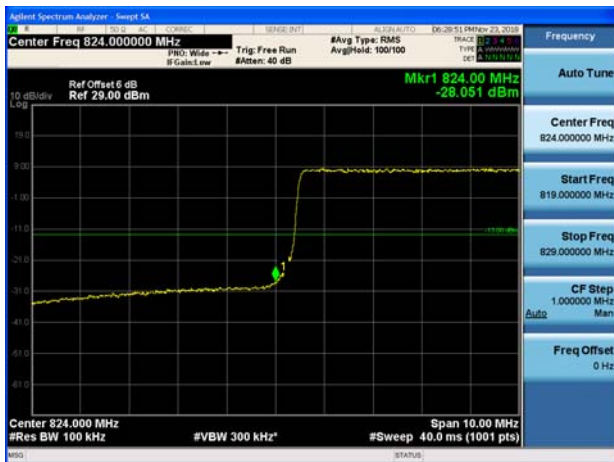

LTE Band 5 16QAM 10MHz CH-High 100%RB

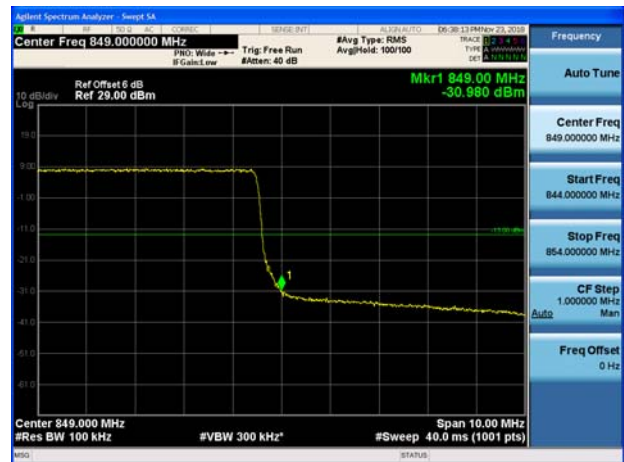

5.5. Peak-to-Average Power Ratio (PAPR)

Ambient condition

| Temperature | Relative humidity | Pressure |
|-------------|-------------------|----------|
| 23°C ~25°C | 45%~50% | 101.5kPa |

Methods of Measurement

Measure the total peak power and record as P_{Pk} . And measure the total average power and record as P_{Avg} . Both the peak and average power levels must be expressed in the same logarithmic units (e.g., dBm). Determine the PAPR from:

$$PAPR (dB) = P_{Pk} (dBm) - P_{Avg} (dBm).$$

Test Setup

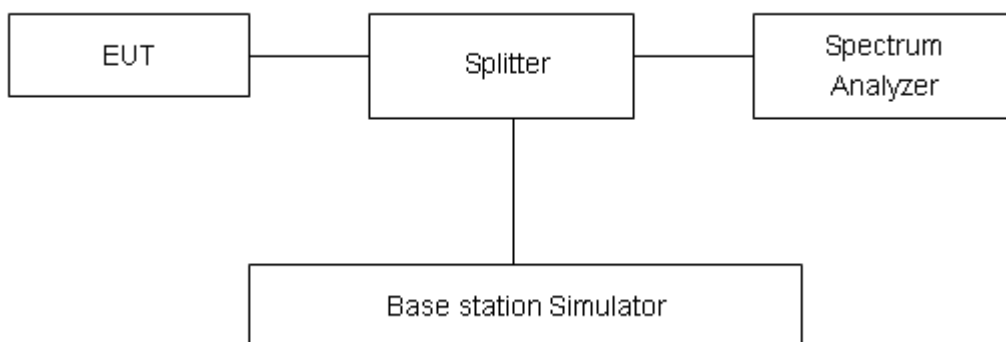

Limits

According to the Sec. 22.913(d), The peak-to-average ratio (PAR) of the transmission must not exceed 13 dB.

Measurement Uncertainty

The assessed measurement uncertainty to ensure 95% confidence level for the normal distribution is with the coverage factor $k = 2$, $U = 0.4$ dB.



Test Results

| Mode | Channel | Frequency (MHz) | Peak (dBm) | Avg (dBm) | PAPR (dB) | Limit (dB) | Conclusion |
|--------------------|---------|-----------------|------------|-----------|-----------|------------|------------|
| GSM 850 (GSM) | 128 | 824.2 | 22.05 | 26.46 | 1.05 | ≤13 | PASS |
| | 190 | 836.6 | 21.76 | 25.56 | 1.08 | ≤13 | PASS |
| | 251 | 848.8 | 22.31 | 25.93 | 1.01 | ≤13 | PASS |
| EGPRS 850 (8-PSK) | 128 | 824.2 | 22.05 | 20.96 | 1.09 | ≤13 | PASS |
| | 190 | 836.6 | 21.76 | 20.65 | 1.11 | ≤13 | PASS |
| | 251 | 848.8 | 22.31 | 21.16 | 1.15 | ≤13 | PASS |
| WCDMA Band V (RMC) | 4132 | 826.4 | 26.28 | 23.25 | 3.03 | ≤13 | PASS |
| | 4183 | 836.6 | 26.24 | 23.31 | 2.93 | ≤13 | PASS |
| | 4233 | 846.6 | 26.41 | 23.35 | 3.06 | ≤13 | PASS |

| LTE Band 5 | | | | | | | | |
|------------|-----------------|---------|-----------------|------------|-----------|-----------|------------|------------|
| Modulation | Bandwidth (MHz) | Channel | Frequency (MHz) | Peak (dBm) | Avg (dBm) | PAPR (dB) | Limit (dB) | Conclusion |
| QPSK | 1.4 | 20407 | 824.7 | 21.35 | 16.23 | 5.12 | ≤13 | PASS |
| | | 20525 | 836.5 | 22.85 | 17.80 | 5.05 | ≤13 | PASS |
| | | 20643 | 848.3 | 24.52 | 18.97 | 5.55 | ≤13 | PASS |
| | 3 | 20415 | 825.5 | 21.71 | 16.29 | 5.42 | ≤13 | PASS |
| | | 20525 | 836.5 | 23.04 | 17.76 | 5.28 | ≤13 | PASS |
| | | 20635 | 847.5 | 24.59 | 18.86 | 5.73 | ≤13 | PASS |
| | 5 | 20425 | 826.5 | 22.18 | 16.49 | 5.69 | ≤13 | PASS |
| | | 20525 | 836.5 | 23.16 | 17.79 | 5.37 | ≤13 | PASS |
| | | 20625 | 846.5 | 24.69 | 18.81 | 5.88 | ≤13 | PASS |
| | 10 | 20450 | 829 | 22.64 | 16.90 | 5.74 | ≤13 | PASS |
| | | 20525 | 836.5 | 23.30 | 17.78 | 5.52 | ≤13 | PASS |
| | | 20600 | 844 | 24.36 | 18.69 | 5.67 | ≤13 | PASS |
| 16QAM | 1.4 | 20407 | 824.7 | 21.07 | 15.24 | 5.83 | ≤13 | PASS |
| | | 20525 | 836.5 | 22.73 | 16.84 | 5.89 | ≤13 | PASS |
| | | 20643 | 848.3 | 24.26 | 17.96 | 6.30 | ≤13 | PASS |
| | 3 | 20415 | 825.5 | 21.46 | 15.28 | 6.18 | ≤13 | PASS |
| | | 20525 | 836.5 | 22.83 | 16.76 | 6.07 | ≤13 | PASS |
| | | 20635 | 847.5 | 24.41 | 17.88 | 6.53 | ≤13 | PASS |
| | 5 | 20425 | 826.5 | 21.82 | 15.50 | 6.32 | ≤13 | PASS |
| | | 20525 | 836.5 | 22.82 | 16.78 | 6.04 | ≤13 | PASS |
| | | 20625 | 846.5 | 24.37 | 17.83 | 6.54 | ≤13 | PASS |
| | 10 | 20450 | 829 | 22.44 | 15.89 | 6.55 | ≤13 | PASS |
| | | 20525 | 836.5 | 22.96 | 16.75 | 6.21 | ≤13 | PASS |
| | | 20600 | 844 | 24.15 | 17.69 | 6.46 | ≤13 | PASS |

5.6. Frequency Stability

Ambient condition

| Temperature | Relative humidity | Pressure |
|-------------|-------------------|----------|
| 23°C ~25°C | 45%~50% | 101.5kPa |

Method of Measurement

Frequency Stability (Temperature Variation)

The temperature inside the climate chamber is varied from -30°C to +55°C in 10°C step size,

(1) With all power removed, the temperature was decreased to 0°C and permitted to stabilize for three hours.

(2) Measure the carrier frequency with the test equipment in a “call mode”. These measurements should be made within 1 minute of powering up the mobile station, to prevent significant self warming.

(3) Repeat the above measurements at 10°C increments from -30°C to +55°C. Allow at least 1.5 hours at each temperature, un-powered, before making measurements.

Frequency Stability (Voltage Variation)

The frequency stability shall be measured with variation of primary supply voltage as follows:

(1) Vary primary supply voltage from 85 to 115 percent of the nominal value for other than hand carried battery equipment.

(2) For hand carried, battery powered equipment, reduce primary supply voltage to the battery-operating end point which shall be specified by the manufacturer.

This transceiver is specified to operate with an input voltage of between 3.6 V and 4.4V, with a nominal voltage of 3.82V.

Test setup

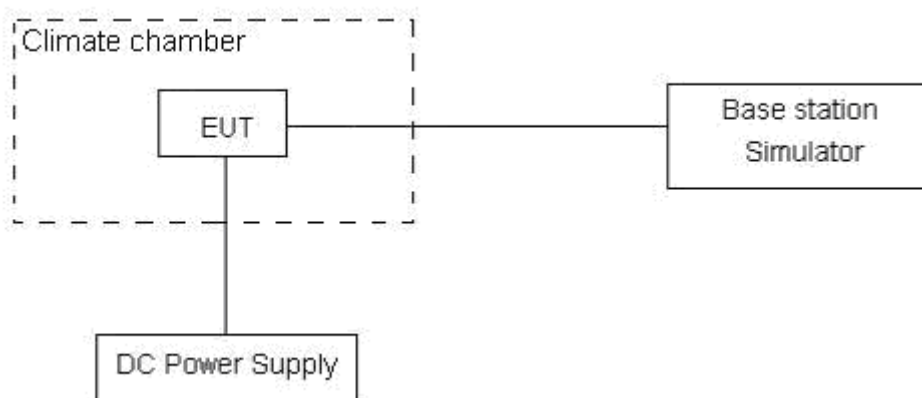

**Limits**

According to the Sec. 22.355, the frequency stability of the carrier shall be accurate to within 2.5 ppm of the received frequency for mobile stations.

| | |
|--------|----------------|
| Limits | ≤ 2.5 ppm |
|--------|----------------|

Measurement Uncertainty

The assessed measurement uncertainty to ensure 99.75% confidence level for the normal distribution is with the coverage factor $k = 3$, $U = 0.01$ ppm.



Test Result

| GSM 850 | | | | | |
|-----------------|---------|-------------------|--------------------|------------|---------------------------|
| Condition | | 824 | 849 | Delta (Hz) | Frequency Stability (ppm) |
| Temperature | Voltage | F low@-13dBm(MHz) | F high@-13dBm(MHz) | | |
| Normal (25°C) | Normal | 824.0689 | 848.9736 | 3.76 | 0.00449 |
| Extreme (55°C) | | 824.0677 | 848.9724 | 0.74 | 0.00088 |
| Extreme (50°C) | | 824.0676 | 848.9723 | 5.55 | 0.00663 |
| Extreme (40°C) | | 824.0686 | 848.9733 | 1.69 | 0.00202 |
| Extreme (30°C) | | 824.0677 | 848.9724 | 2.19 | 0.00262 |
| Extreme (20°C) | | 824.0685 | 848.9732 | 2.00 | 0.00239 |
| Extreme (10C) | | 824.0678 | 848.9725 | -3.96 | -0.00473 |
| Extreme (0°C) | | 824.0684 | 848.9731 | 4.72 | 0.00564 |
| Extreme (-10°C) | | 824.0679 | 848.9726 | -1.26 | -0.00151 |
| Extreme (-20°C) | | 824.0683 | 848.9730 | 2.53 | 0.00302 |
| Extreme (-30°C) | | 824.0680 | 848.9727 | 4.57 | 0.00546 |
| 25C | | LV | 824.0681 | 848.9728 | 1.67 |
| | HV | 824.0690 | 848.9737 | 3.12 | 0.00373 |
| GPRS 850 | | | | | |
| Condition | | 824 | 849 | Delta (Hz) | Frequency Stability (ppm) |
| Temperature | Voltage | F low@-13dBm(MHz) | F high@-13dBm(MHz) | | |
| Normal (25°C) | Normal | 824.0654 | 848.9658 | 3.36 | 0.00402 |
| Extreme (55°C) | | 824.0642 | 848.9646 | 1.32 | 0.00158 |
| Extreme (50°C) | | 824.0641 | 848.9645 | -0.97 | -0.00116 |
| Extreme (40°C) | | 824.0651 | 848.9655 | -0.44 | -0.00053 |
| Extreme (30°C) | | 824.0642 | 848.9646 | 0.64 | 0.00077 |
| Extreme (20°C) | | 824.0650 | 848.9654 | 3.30 | 0.00394 |
| Extreme (10C) | | 824.0643 | 848.9647 | 6.79 | 0.00812 |
| Extreme (0°C) | | 824.0649 | 848.9653 | 1.85 | 0.00221 |
| Extreme (-10°C) | | 824.0644 | 848.9648 | -1.92 | -0.00230 |
| Extreme (-20°C) | | 824.0648 | 848.9652 | -0.54 | -0.00065 |
| Extreme (-30°C) | | 824.0645 | 848.9649 | 2.45 | 0.00293 |
| 25C | | LV | 824.0646 | 848.9650 | 2.31 |
| | HV | 824.0655 | 848.9659 | 0.58 | 0.00069 |
| EGPRS 850 | | | | | |
| Condition | | 824 | 849 | Delta (Hz) | Frequency Stability (ppm) |
| Temperature | Voltage | F low@-13dBm(MHz) | F high@-13dBm(MHz) | | |
| Normal (25°C) | Normal | 824.0782 | 848.9396 | 1.19 | 0.00142 |



| | | | | | |
|-----------------|----|----------|----------|-------|----------|
| Extreme (55°C) | | 824.0770 | 848.9384 | 3.05 | 0.00365 |
| Extreme (50°C) | | 824.0769 | 848.9383 | -1.96 | -0.00234 |
| Extreme (40°C) | | 824.0779 | 848.9393 | 7.60 | 0.00908 |
| Extreme (30°C) | | 824.0770 | 848.9384 | 2.70 | 0.00323 |
| Extreme (20°C) | | 824.0778 | 848.9392 | 2.42 | 0.00289 |
| Extreme (10C) | | 824.0771 | 848.9385 | 1.17 | 0.00140 |
| Extreme (0°C) | | 824.0777 | 848.9391 | 0.29 | 0.00035 |
| Extreme (-10°C) | | 824.0772 | 848.9386 | 6.57 | 0.00785 |
| Extreme (-20°C) | | 824.0776 | 848.9390 | 6.42 | 0.00767 |
| Extreme (-30°C) | | 824.0773 | 848.9387 | 2.39 | 0.00286 |
| 25C | LV | 824.0774 | 848.9388 | 1.27 | 0.00152 |
| | HV | 824.0783 | 848.9397 | 3.15 | 0.00377 |

| WCDMA Band 5 | | | | | |
|-----------------|---------|-------------------|--------------------|------------|---------------------------|
| Condition | | 824 | 849 | Delta (Hz) | Frequency Stability (ppm) |
| Temperature | Voltage | F low@-13dBm(MHz) | F high@-13dBm(MHz) | | |
| Normal (25°C) | Normal | 824.0321 | 848.9679 | 2.80 | 0.00335 |
| Extreme (55°C) | | 824.0323 | 848.9656 | -1.20 | -0.00143 |
| Extreme (50°C) | | 824.0317 | 848.9662 | -0.20 | -0.00024 |
| Extreme (40°C) | | 824.0304 | 848.9675 | 2.66 | 0.00318 |
| Extreme (30°C) | | 824.0297 | 848.9682 | -0.04 | -0.00005 |
| Extreme (20°C) | | 824.0318 | 848.9661 | -0.72 | -0.00086 |
| Extreme (10C) | | 824.0306 | 848.9673 | 1.73 | 0.00207 |
| Extreme (0°C) | | 824.0319 | 848.9662 | 0.53 | 0.00063 |
| Extreme (-10°C) | | 824.0324 | 848.9655 | 0.46 | 0.00055 |
| Extreme (-20°C) | | 824.0313 | 848.9666 | -0.59 | -0.00071 |
| Extreme (-30°C) | | 824.0283 | 848.9699 | 2.13 | 0.00255 |
| 25C | | LV | 824.0316 | 848.9663 | 3.58 |
| | HV | 824.0313 | 848.9669 | 2.94 | 0.00351 |



| LTE Band 5 | | | | | |
|--------------------------|---------|-------------------|--------------------|---------------|-----------------------------|
| (QPSK, 10MHz BANDWIDTH) | | | | | |
| Condition | | 824 | 849 | Delta (Hz) | Frequency Stability(ppm) |
| Temperature | Voltage | F low@-13dBm(MHz) | F high@-13dBm(MHz) | | |
| Normal (25°C) | Normal | 824.2278 | 848.7882 | 5.31 | 0.00635 |
| Extreme (55°C) | | 824.2301 | 848.7903 | 1.09 | 0.00130 |
| Extreme (50°C) | | 824.2295 | 848.7897 | 3.15 | 0.00377 |
| Extreme (40°C) | | 824.2282 | 848.7884 | -1.02 | -0.00122 |
| Extreme (30°C) | | 824.2275 | 848.7877 | -2.02 | -0.00241 |
| Extreme (20°C) | | 824.2296 | 848.7898 | 3.51 | 0.00420 |
| Extreme (10C) | | 824.2284 | 848.7886 | -1.81 | -0.00216 |
| Extreme (0°C) | | 824.2297 | 848.7899 | -0.14 | -0.00017 |
| Extreme (-10°C) | | 824.2302 | 848.7904 | -4.01 | -0.00479 |
| Extreme (-20°C) | | 824.2291 | 848.7893 | -0.74 | -0.00088 |
| Extreme (-30°C) | | 824.2258 | 848.7863 | 5.40 | 0.00646 |
| 25°C | | LV | 824.2294 | 848.7896 | 2.67 |
| | HV | 824.2288 | 848.7896 | 4.13 | 0.00494 |
| (16QAM, 10MHz BANDWIDTH) | | | | | |
| Condition | | 824 | 849 | Delta (Hz) | Frequency Stability(ppm) |
| Temperature | Voltage | F low@-13dBm(MHz) | F high@-13dBm(MHz) | | |
| Normal (25°C) | Normal | 824.3662 | 848.7284 | 4.12 | 0.00493 |
| Extreme (55°C) | | 824.3639 | 848.7261 | -6.84 | -0.00818 |
| Extreme (50°C) | | 824.3645 | 848.7267 | 1.74 | 0.00208 |
| Extreme (40°C) | | 824.3658 | 848.7283 | -1.14 | -0.00136 |
| Extreme (30°C) | | 824.3665 | 848.7287 | -4.22 | -0.00504 |
| Extreme (20°C) | | 824.3644 | 848.7266 | -0.70 | -0.00084 |
| Extreme (10C) | | 824.3656 | 848.7278 | -4.43 | -0.00530 |
| Extreme (0°C) | | 824.3643 | 848.7265 | 3.14 | 0.00375 |
| Extreme (-10°C) | | 824.3638 | 848.7262 | 1.44 | 0.00172 |
| Extreme (-20°C) | | 824.3649 | 848.7271 | 2.04 | 0.00244 |
| Extreme (-30°C) | | 824.3682 | 848.7304 | 5.81 | 0.00695 |
| 25°C | | LV | 824.3646 | 848.7268 | 2.67 |
| | HV | 824.3652 | 848.7274 | 3.02 | 0.00361 |

5.7. Spurious Emissions at Antenna Terminals

Ambient condition

| Temperature | Relative humidity | Pressure |
|-------------|-------------------|----------|
| 23°C ~25°C | 45%~50% | 101.5kPa |

Method of Measurement

The EUT was connected to Spectrum Analyzer and Base Station Simulator via power Splitter. The measurement is carried out using a spectrum analyzer. The spectrum analyzer scans from 9kHz to the 10th harmonic of the carrier.

The peak detector is used. RBW are set to 100 kHz and VBW are set to 300 kHz for below 1G, RBW are set to 1MHz and VBW are set to 3MHz for above 1G, Sweep is set to ATUO.

The modulation mode and RB allocation refer to section 5.1, using the maximum output power configuration.

Test setup

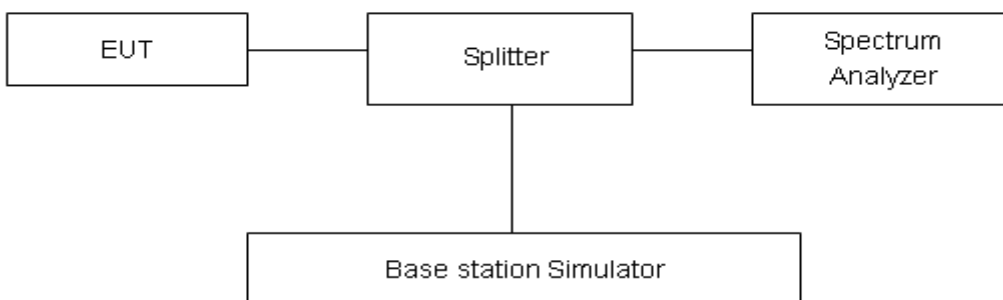

Limits

Rule Part 22.917(a) specifies that “The power of any emission outside of the authorized operating frequency ranges must be attenuated below the transmitting power (P) by a factor of at least 43 + 10 log (P) dB.”

| | |
|-------|---------|
| Limit | -13 dBm |
|-------|---------|

Measurement Uncertainty

The assessed measurement uncertainty to ensure 99.75% confidence level for the normal distribution is with the coverage factor $k = 1.96$.

| Frequency | Uncertainty |
|------------|-------------|
| 9kHz-1GHz | 0.684 dB |
| 1GHz-18GHz | 1.407 dB |



Test Result

Sweep the whole frequency band through the range from 9kHz to the 10th harmonic of the carrier, the emissions more than 20 dB below the limit are not reported.

The signal beyond the limit is carrier.

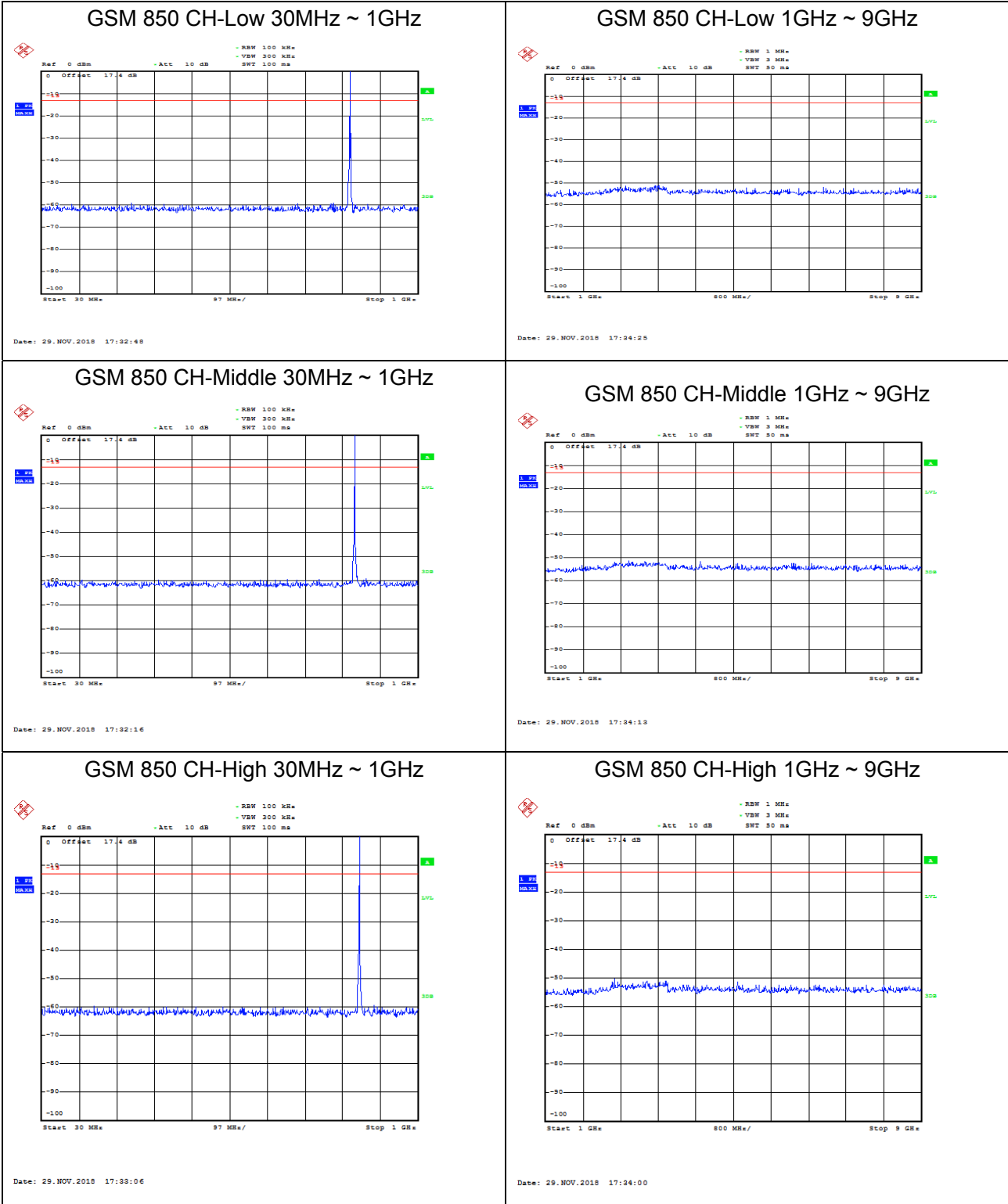



WCDMA Band V CH-Low 30MHz ~ 1GHz

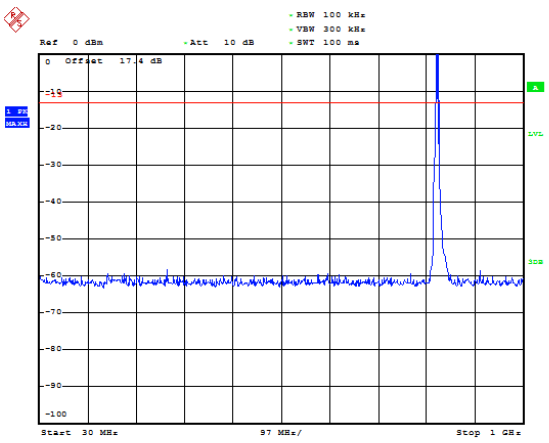

Date: 21.NOV.2018 15:19:20

WCDMA Band V CH-Low 1GHz ~ 9GHz

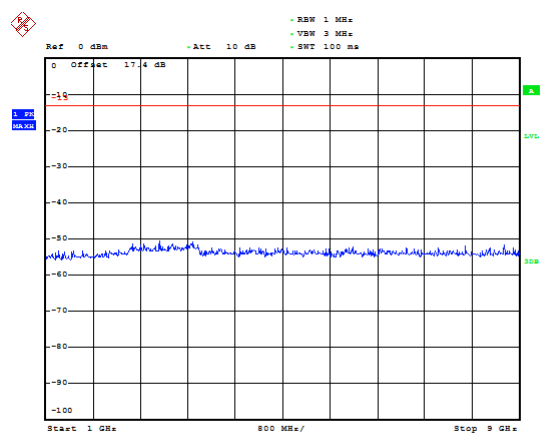

Date: 21.NOV.2018 15:16:37

WCDMA Band V CH-Middle 30MHz ~ 1GHz

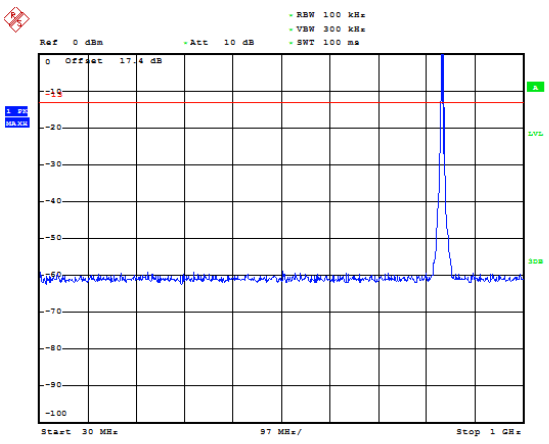

Date: 21.NOV.2018 15:15:08

WCDMA Band V CH-Middle 1GHz ~ 9GHz

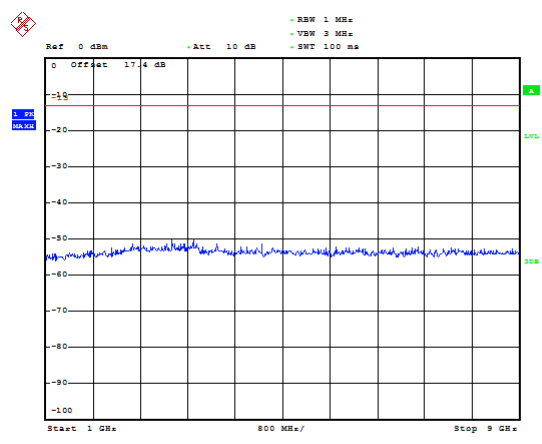

Date: 21.NOV.2018 15:16:13

WCDMA Band V CH-High 30MHz ~ 1GHz

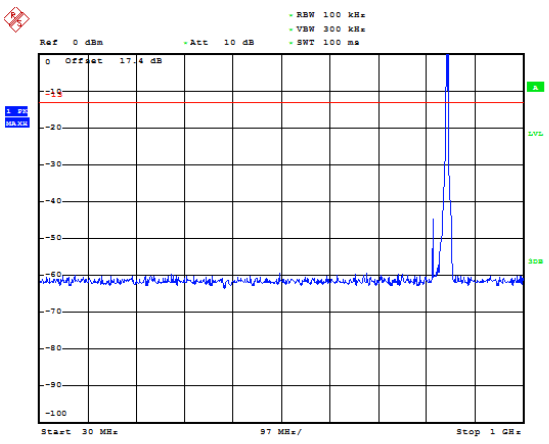

Date: 21.NOV.2018 15:18:50

WCDMA Band V CH-High 1GHz ~ 9GHz

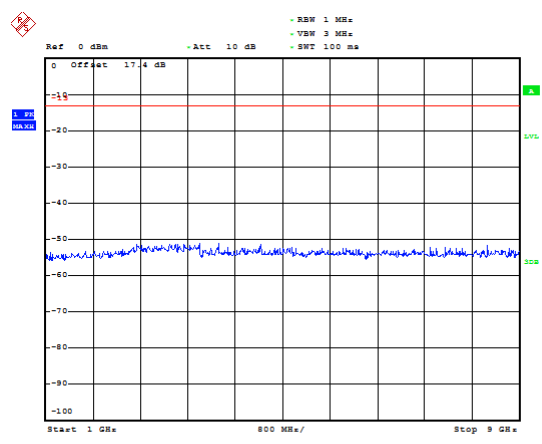

Date: 21.NOV.2018 15:17:10



LTE Band 5 1.4MHz CH-Low 30MHz~1GHz

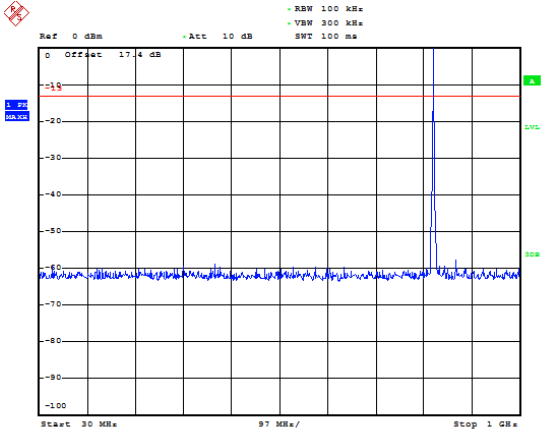

Date: 26.NOV.2018 15:19:46

LTE Band 5 1.4MHz CH-Low 1GHz~9GHz

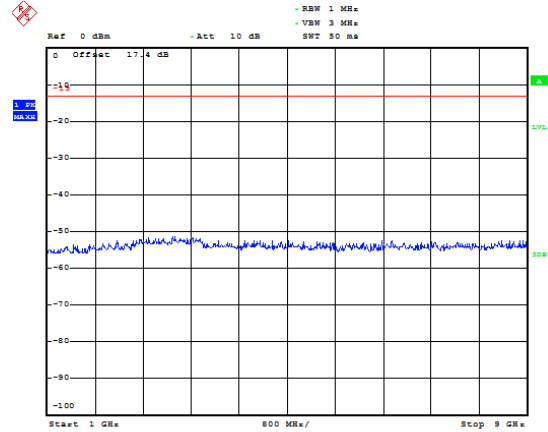

Date: 26.NOV.2018 15:20:38

LTE Band 5 1.4MHz CH-Middle 30MHz~1GHz

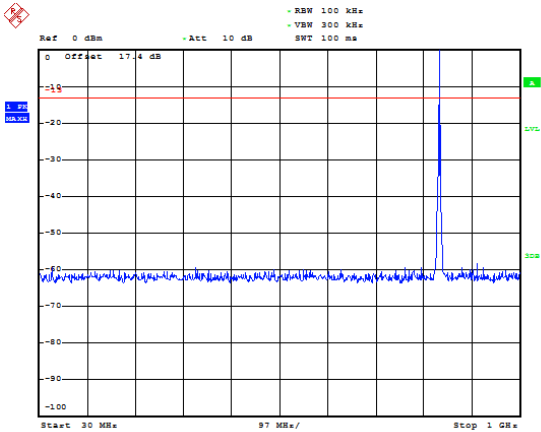

Date: 26.NOV.2018 15:41:21

LTE Band 5 1.4MHz CH-Middle 1GHz~9GHz

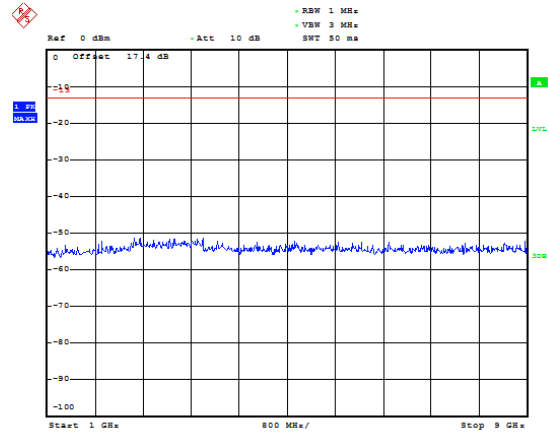

Date: 26.NOV.2018 15:40:37

LTE Band 5 1.4MHz CH-High 30MHz~1GHz

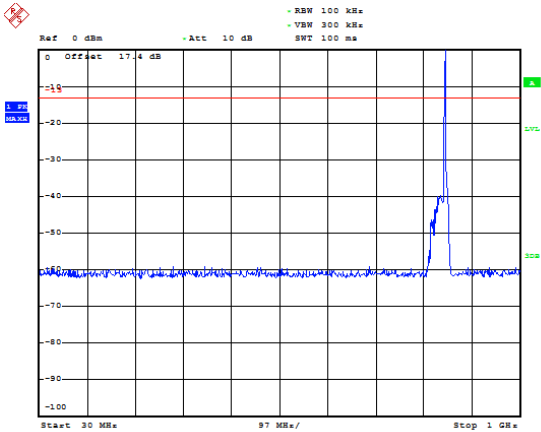

Date: 26.NOV.2018 15:41:58

LTE Band 5 1.4MHz CH-High 1GHz~9GHz

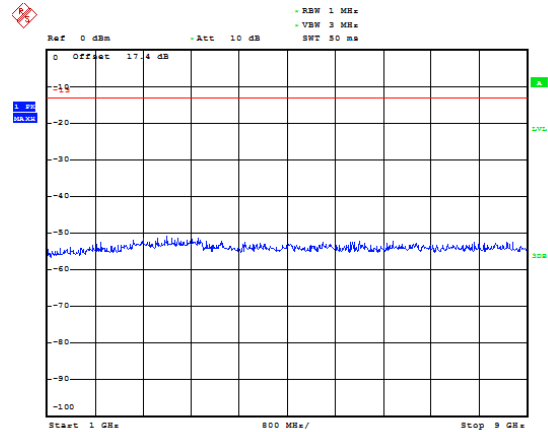

Date: 26.NOV.2018 15:42:48



LTE Band 5 3MHz CH-Low 30MHz~1GHz

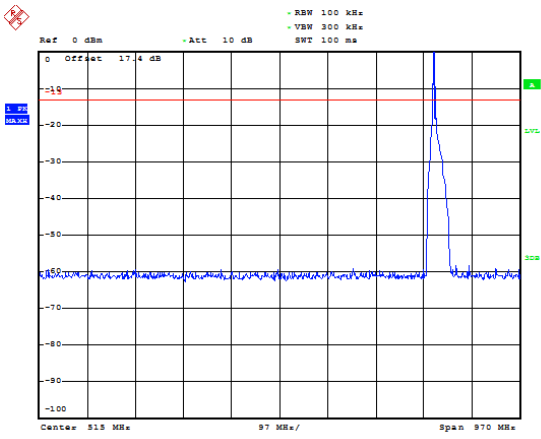

Date: 27_NOV.2018 09:57:51

LTE Band 5 3MHz CH-Low 1GHz~9GHz

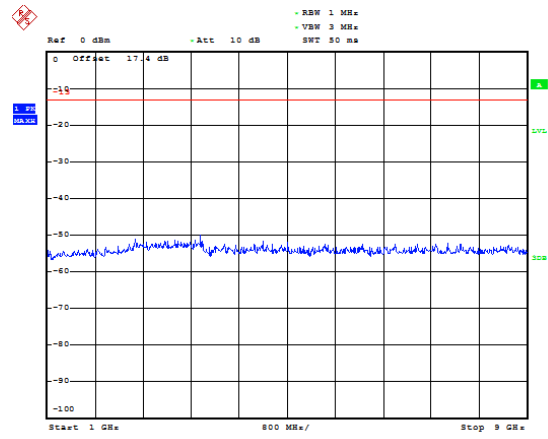

Date: 27_NOV.2018 09:58:50

LTE Band 5 3MHz CH-Middle 30MHz~1GHz

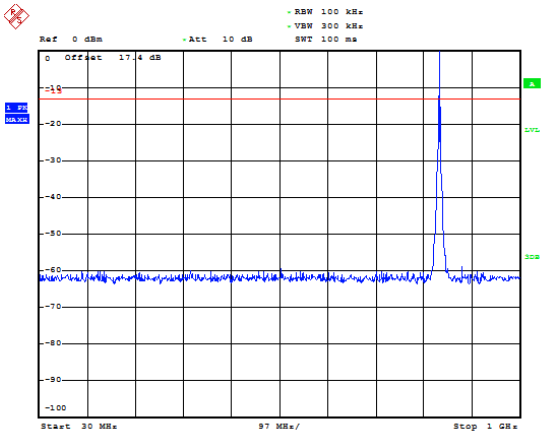

Date: 27_NOV.2018 10:00:38

LTE Band 5 3MHz CH-Middle 1GHz~9GHz

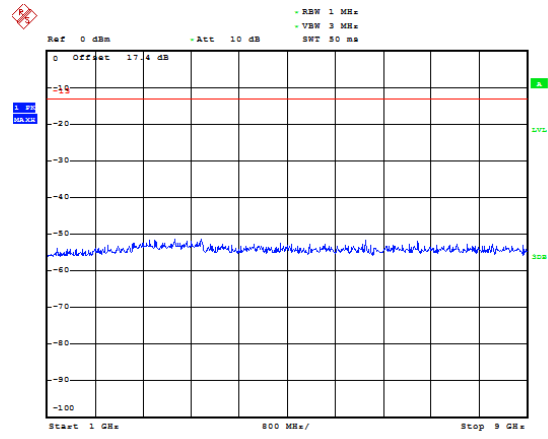

Date: 27_NOV.2018 09:59:22

LTE Band 5 3MHz CH-High 30MHz~1GHz

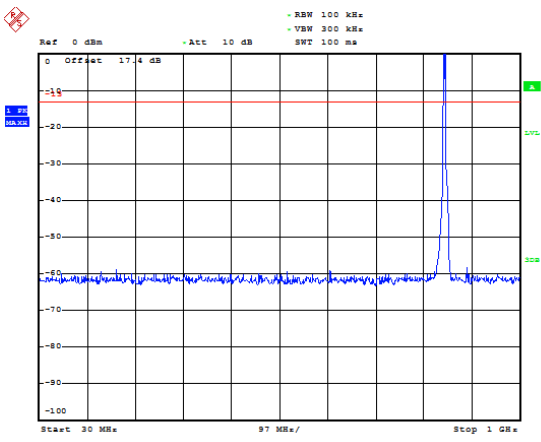

Date: 27_NOV.2018 10:01:20

LTE Band 5 3MHz CH-High 1GHz~9GHz

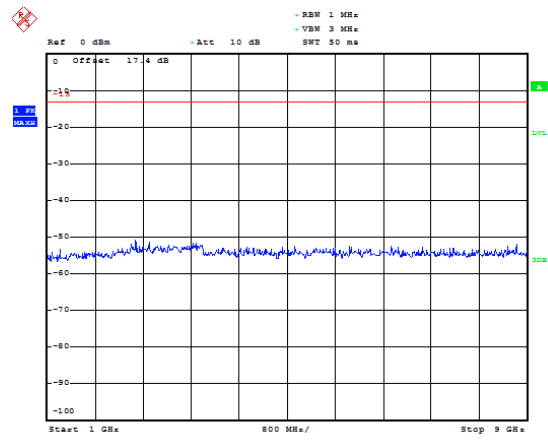

Date: 27_NOV.2018 10:02:10



LTE Band 5 5MHz CH-Low 30MHz~1GHz

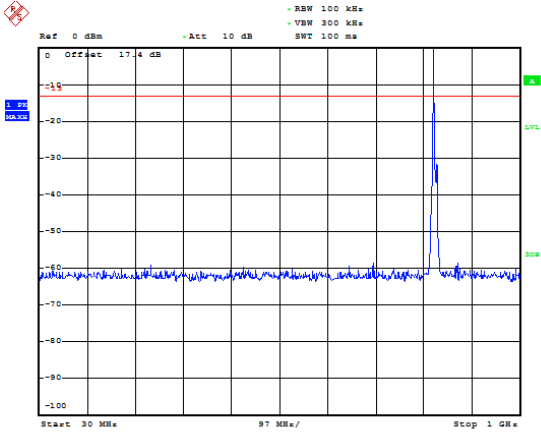

Date: 27.NOV.2018 10:04:54

LTE Band 5 5MHz CH-Low 1GHz~9GHz

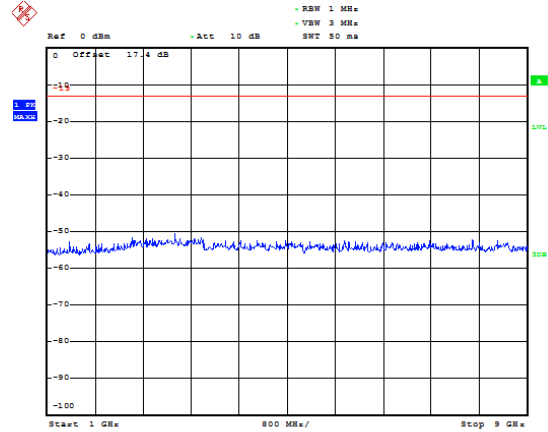

Date: 27.NOV.2018 10:02:36

LTE Band 5 5MHz CH-Middle 30MHz~1GHz

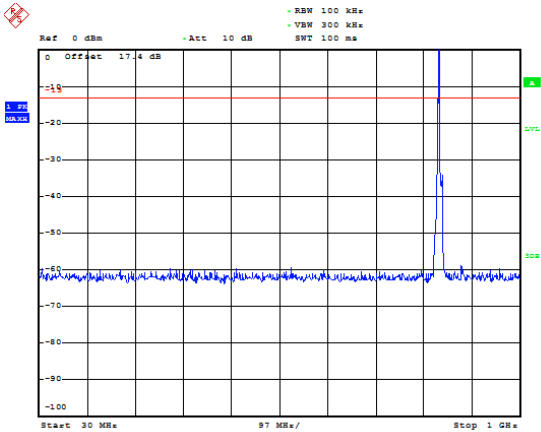

Date: 27.NOV.2018 10:04:25

LTE Band 5 5MHz CH-Middle 1GHz~9GHz

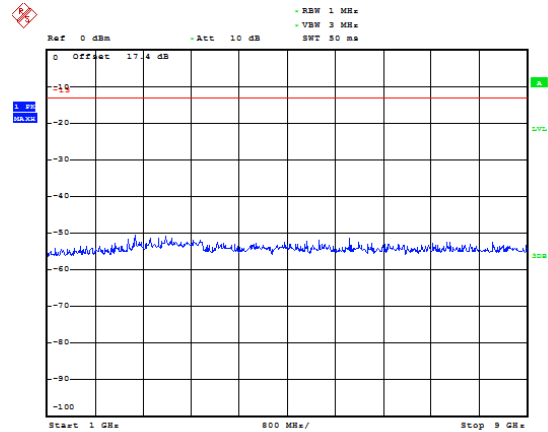

Date: 27.NOV.2018 10:03:02

LTE Band 5 5MHz CH-High 30MHz~1GHz

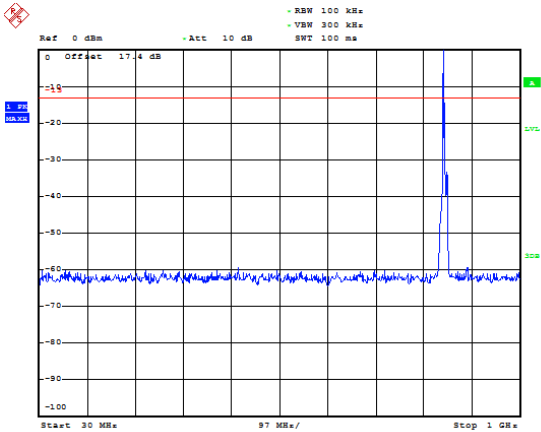

Date: 27.NOV.2018 10:04:06

LTE Band 5 5MHz CH-High 1GHz~9GHz

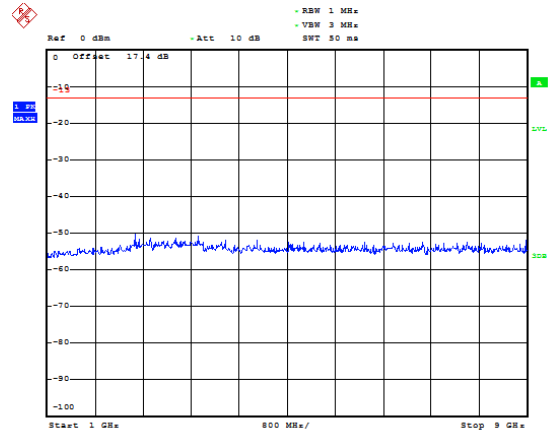

Date: 27.NOV.2018 10:03:24



LTE Band 5 10MHz CH-Low 30MHz~1GHz

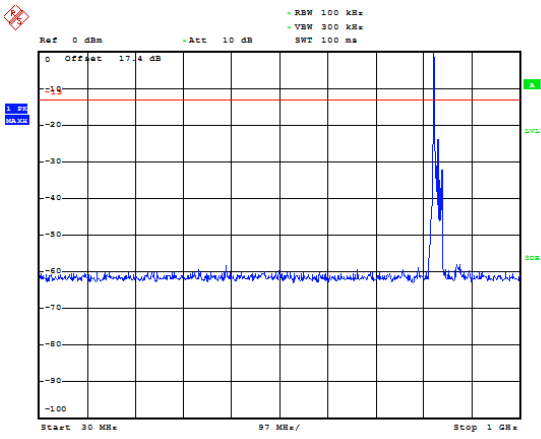

Date: 27_NOV.2018 10:05:43

LTE Band 5 10MHz CH-Low 1GHz~9GHz

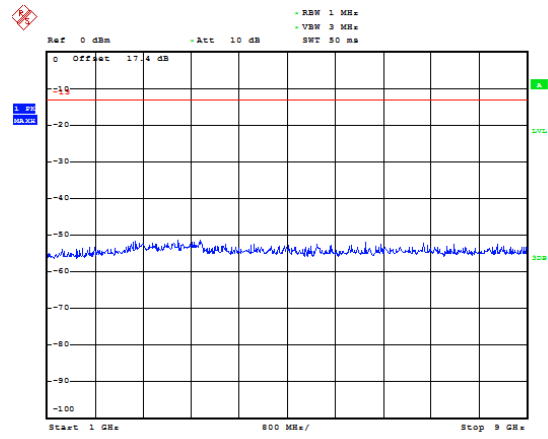

Date: 27_NOV.2018 10:07:44

LTE Band 5 10MHz CH-Middle 30MHz~1GHz

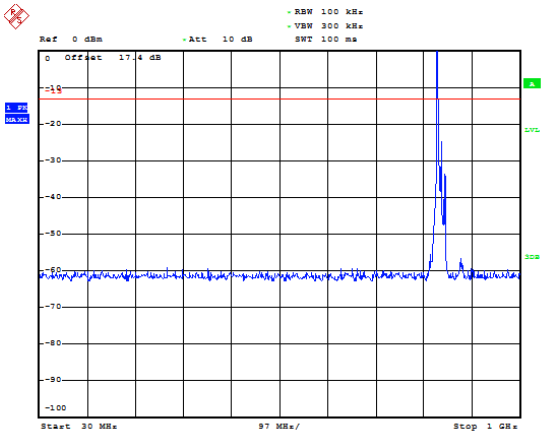

Date: 27_NOV.2018 10:06:04

LTE Band 5 10MHz CH-Middle 1GHz~9GHz

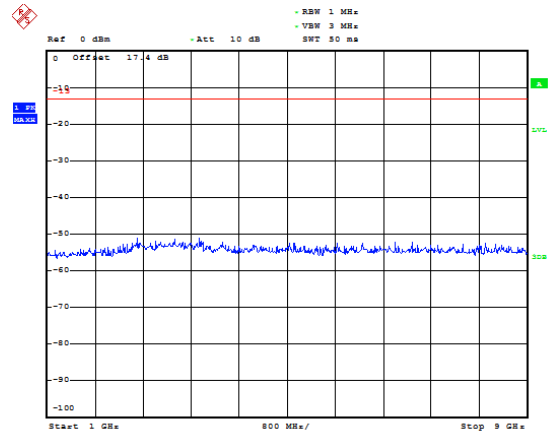

Date: 27_NOV.2018 10:07:27

LTE Band 5 10MHz CH-High 30MHz~1GHz

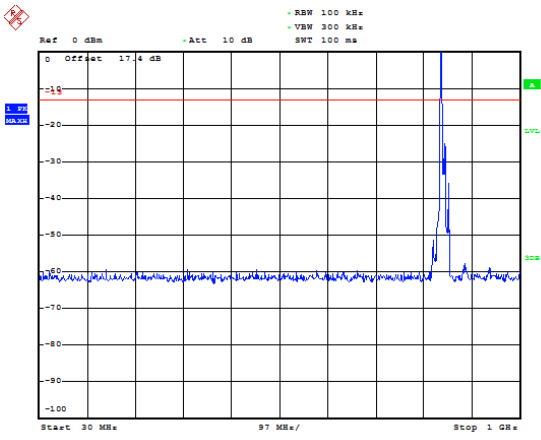

Date: 27_NOV.2018 10:06:24

LTE Band 5 10MHz CH-High 1GHz~9GHz

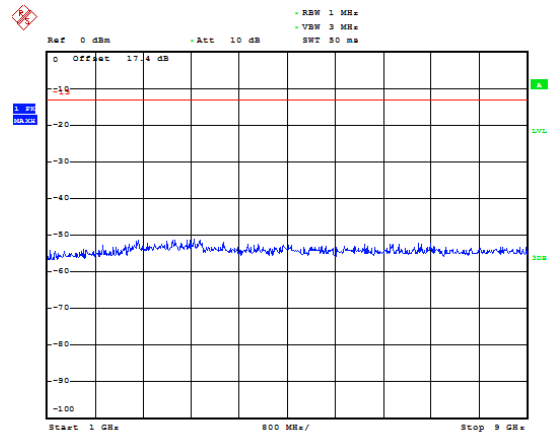

Date: 27_NOV.2018 10:07:12

5.8. Radiates Spurious Emission

Ambient condition

| Temperature | Relative humidity | Pressure |
|-------------|-------------------|----------|
| 23°C ~25°C | 45%~50% | 101.5kPa |

Method of Measurement

1. The testing follows FCC KDB 971168 v03r01 Section 5.8 and ANSI C63.26 (2015).
2. Above 30MHz: The EUT is placed on a turntable 0.8 meters above the ground in the chamber, 3 meter away from the antenna. The maximal emission value is acquired by adjusting the antenna height, polarisation and turntable azimuth. Normally, the height range of antenna is 1 m to 4 m, the azimuth range of turntable is 0° to 360°, and the receive antenna has two polarizations Vertical (V) and Horizontal (H). Above 1GHz: (Note: the FCC's permission to use 1.5m as an alternative per TCBC Conf call of Dec. 2, 2014.) The EUT is placed on a turntable 1.5 meters above the ground in the chamber, 3 meter away from the antenna. The maximal emission value is acquired by adjusting the antenna height, polarisation and turntable azimuth. Normally, the height range of antenna is 1 m to 4 m, the azimuth range of turntable is 0° to 360°, and the receive antenna has two polarizations Vertical (V) and Horizontal (H).
3. A log-periodic antenna or horn antenna shall be substituted in place of the EUT. The log-periodic antenna will be driven by a signal generator and the level will be adjusted till the same power value on the spectrum analyzer or receiver. The level of the spurious emissions can be calculated through the level of the signal generator, cable loss, the gain of the substitution antenna and the reading of the spectrum analyzer or receiver.
4. The EUT is then put into continuously transmitting mode at its maximum power level during the test. Set Test Receiver or Spectrum RBW=1MHz, VBW=3MHz for above 1GHz and RBW=100kHz, VBW=300kHz for 30MHz to 1GHz, And the maximum value of the receiver should be recorded as (Pr).
5. The EUT shall be replaced by a substitution antenna. In the chamber, an substitution antenna for the frequency band of interest is placed at the reference point of the chamber. An RF Signal source for the frequency band of interest is connected to the substitution antenna with a cable that has been constructed to not interfere with the radiation pattern of the antenna. A power (PMea) is applied to the input of the substitution antenna, and adjust the level of the signal generator output until the value of the receiver reach the previously recorded (Pr). The power of signal source (PMea) is recorded. The test should be performed by rotating the test item and adjusting the receiving antenna polarization.
6. A amplifier should be connected to the Signal Source output port. And the cable should be connect between the Amplifier and the Substitution Antenna. The cable loss (Pcl), the Substitution Antenna Gain (Ga) and the Amplifier Gain (PAg) should be recorded after test.
7. The measurement results are obtained as described below:
Power(EIRP)=PMea- PAg - Pcl + Ga
The measurement results are amend as described below:
Power(EIRP)=PMea- Pcl + Ga
8. This value is EIRP since the measurement is calibrated using an antenna of known gain (2.15 dBi)

and known input power. ERP can be calculated from EIRP by subtracting the gain of the dipole, $ERP = EIRP - 2.15\text{dBi}$.

The modulation mode and RB allocation refer to section 5.1, using the maximum output power configuration.

Test setup

30MHz~~~ 1GHz

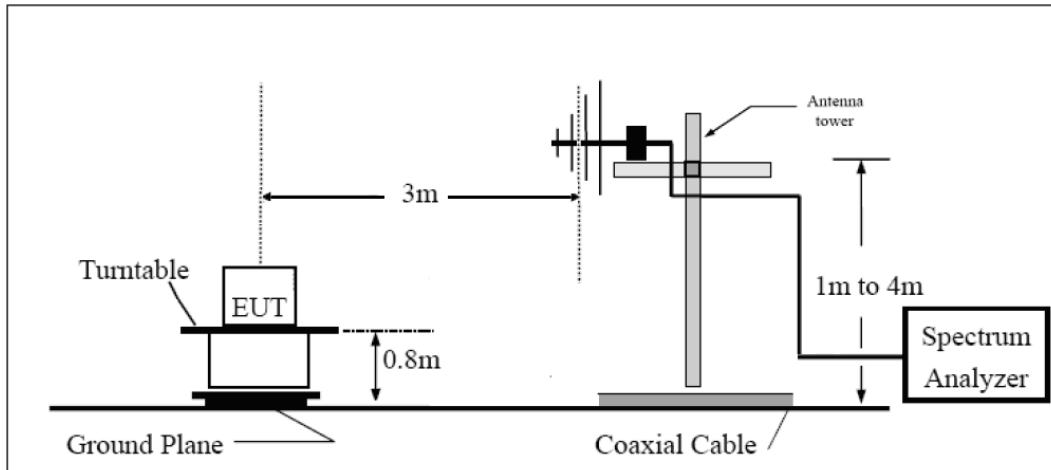

Above 1GHz

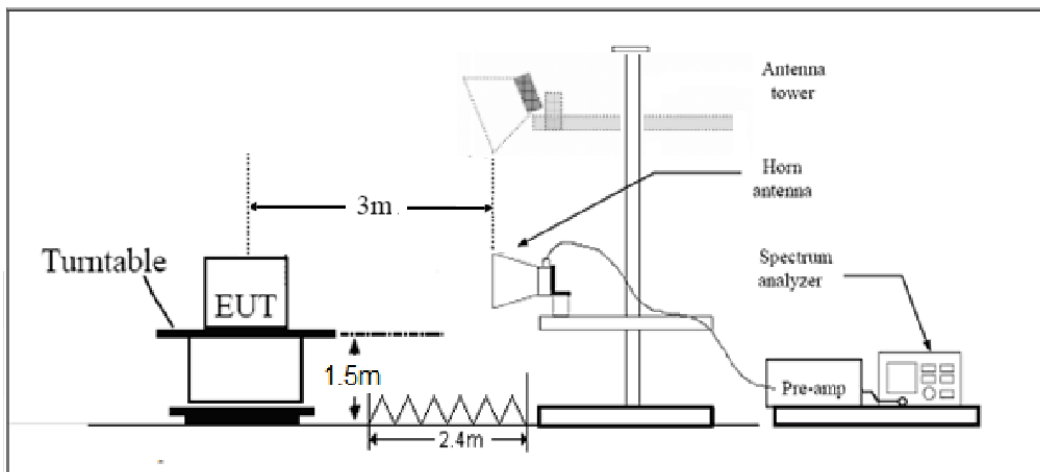

Note: Area side: 2.4mX3.6m

Limits

Rule Part 22.917(a) specifies that “The power of any emission outside of the authorized operating frequency ranges must be attenuated below the transmitting power (P) by a factor of at least $43 + 10 \log (P)$ dB.”

| | |
|-------|---------|
| Limit | -13 dBm |
|-------|---------|

Measurement Uncertainty

The assessed measurement uncertainty to ensure 95% confidence level for the normal distribution is with the coverage factor $k = 1.96$, $U = 3.55$ dB.

**Test Result**

Sweep the whole frequency band through the range from 9kHz to the 10th harmonic of the carrier, the emissions below the noise floor will not be recorded in the report.

GSM 850 CH-Middle

| Harmonic | Frequency (MHz) | SG (dBm) | Cable Loss (dB) | Gain (dBi) | Antenna Polarization | ERP Level (dBm) | Limit (dBm) | Margin (dB) | Azimuth (deg) |
|----------|-----------------|----------|-----------------|------------|----------------------|-----------------|-------------|-------------|---------------|
| 2 | 1673 | -46.19 | 2.00 | 10.75 | Horizontal | -39.59 | -13.00 | 26.59 | 45 |
| 3 | 2498 | -49.70 | 2.51 | 11.05 | Horizontal | -43.31 | -13.00 | 30.31 | 225 |
| 4 | 3346 | -63.55 | 4.20 | 11.15 | Horizontal | -58.75 | -13.00 | 45.75 | 45 |
| 5 | 4183 | -59.96 | 5.20 | 11.15 | Horizontal | -56.16 | -13.00 | 43.16 | 0 |
| 6 | 5020 | -58.01 | 5.50 | 11.95 | Horizontal | -53.71 | -13.00 | 40.71 | 315 |
| 7 | 5856 | -59.55 | 5.70 | 13.55 | Horizontal | -53.85 | -13.00 | 40.85 | 45 |
| 8 | 6693 | -57.26 | 6.30 | 13.75 | Horizontal | -51.96 | -13.00 | 38.96 | 135 |
| 9 | 7529 | -54.12 | 6.80 | 13.85 | Horizontal | -49.22 | -13.00 | 36.22 | 225 |
| 10 | 8366 | -55.38 | 6.90 | 14.25 | Horizontal | -50.18 | -13.00 | 37.18 | 180 |

Note: 1.The other Spurious RF Radiated emissions level is no more than noise floor.

2.The worst emission was found in the antenna is Horizontal position.

WCDMA Band V CH-Middle

| Harmonic | Frequency (MHz) | SG (dBm) | Cable Loss (dB) | Gain (dBi) | Antenna Polarization | ERP Level (dBm) | Limit (dBm) | Margin (dB) | Azimuth (deg) |
|----------|-----------------|----------|-----------------|------------|----------------------|-----------------|-------------|-------------|---------------|
| 2 | 1673 | -64.63 | 2.00 | 10.75 | Horizontal | -58.03 | -13.00 | 45.03 | 0 |
| 3 | 2510 | -62.57 | 2.51 | 11.05 | Horizontal | -56.18 | -13.00 | 43.18 | 135 |
| 4 | 3346 | -63.56 | 4.20 | 11.15 | Horizontal | -58.76 | -13.00 | 45.76 | 225 |
| 5 | 4183 | -60.30 | 5.20 | 11.15 | Horizontal | -56.50 | -13.00 | 43.50 | 315 |
| 6 | 5020 | -58.35 | 5.50 | 11.95 | Horizontal | -54.05 | -13.00 | 41.05 | 190 |
| 7 | 5856 | -59.26 | 5.70 | 13.55 | Horizontal | -53.56 | -13.00 | 40.56 | 90 |
| 8 | 6693 | -57.56 | 6.30 | 13.75 | Horizontal | -52.26 | -13.00 | 39.26 | 225 |
| 9 | 8366 | -54.93 | 6.80 | 13.85 | Horizontal | -50.03 | -13.00 | 37.03 | 45 |
| 10 | 3346 | -54.64 | 6.90 | 14.25 | Horizontal | -49.44 | -13.00 | 36.44 | 0 |

Note: 1.The other Spurious RF Radiated emissions level is no more than noise floor.

2.The worst emission was found in the antenna is Horizontal position.

LTE Band 5 1.4MHz CH-Middle

| Harmonic | Frequency (MHz) | SG (dBm) | Cable Loss (dB) | Gain (dBi) | Antenna Polarization | ERP Level (dBm) | Limit (dBm) | Margin (dB) | Azimuth (deg) |
|----------|-----------------|----------|-----------------|------------|----------------------|-----------------|-------------|-------------|---------------|
| 2 | 1673.0 | -66.26 | 2.00 | 10.75 | Horizontal | -59.66 | -13.00 | 46.66 | 45 |
| 3 | 2509.5 | -59.63 | 2.51 | 11.05 | Horizontal | -53.24 | -13.00 | 40.24 | 135 |
| 4 | 3346.0 | -63.48 | 4.20 | 11.15 | Horizontal | -58.68 | -13.00 | 45.68 | 0 |
| 5 | 4182.5 | -59.42 | 5.20 | 11.15 | Horizontal | -55.62 | -13.00 | 42.62 | 27 |
| 6 | 5019.0 | -56.77 | 5.50 | 11.95 | Horizontal | -52.47 | -13.00 | 39.47 | 135 |
| 7 | 5855.5 | -59.04 | 5.70 | 13.55 | Horizontal | -53.34 | -13.00 | 40.34 | 0 |
| 8 | 6692.0 | -56.63 | 6.30 | 13.75 | Horizontal | -51.33 | -13.00 | 38.33 | 315 |
| 9 | 7528.5 | -55.93 | 6.80 | 13.85 | Horizontal | -51.03 | -13.00 | 38.03 | 0 |
| 10 | 8365.0 | -53.79 | 6.90 | 14.25 | Horizontal | -48.59 | -13.00 | 35.59 | 135 |

Note: 1.The other Spurious RF Radiated emissions level is no more than noise floor.
 2.The worst emission was found in the antenna is Horizontal position.

LTE Band 5 5MHz CH-Middle

| Harmonic | Frequency (MHz) | SG (dBm) | Cable Loss (dB) | Gain (dBi) | Antenna Polarization | ERP Level (dBm) | Limit (dBm) | Margin (dB) | Azimuth (deg) |
|----------|-----------------|----------|-----------------|------------|----------------------|-----------------|-------------|-------------|---------------|
| 2 | 1673.0 | -66.44 | 2.00 | 10.75 | Horizontal | -59.84 | -13.00 | 46.84 | 0 |
| 3 | 2509.5 | -59.56 | 2.51 | 11.05 | Horizontal | -53.17 | -13.00 | 40.17 | 180 |
| 4 | 3346.0 | -63.08 | 4.20 | 11.15 | Horizontal | -58.28 | -13.00 | 45.28 | 270 |
| 5 | 4182.5 | -59.44 | 5.20 | 11.15 | Horizontal | -55.64 | -13.00 | 42.64 | 225 |
| 6 | 5019.0 | -58.28 | 5.50 | 11.95 | Horizontal | -53.98 | -13.00 | 40.98 | 270 |
| 7 | 5855.5 | -59.25 | 5.70 | 13.55 | Horizontal | -53.55 | -13.00 | 40.55 | 135 |
| 8 | 6692.0 | -56.10 | 6.30 | 13.75 | Horizontal | -50.80 | -13.00 | 37.80 | 0 |
| 9 | 7528.5 | -55.14 | 6.80 | 13.85 | Horizontal | -50.24 | -13.00 | 37.24 | 315 |
| 10 | 8365.0 | -55.03 | 6.90 | 14.25 | Horizontal | -49.83 | -13.00 | 36.83 | 90 |

Note: 1.The other Spurious RF Radiated emissions level is no more than noise floor.
 2.The worst emission was found in the antenna is Horizontal position.



LTE Band 5 10MHz CH-Middle

| Harmonic | Frequency (MHz) | SG (dBm) | Cable Loss (dB) | Gain (dBi) | Antenna Polarization | ERP Level (dBm) | Limit (dBm) | Margin (dB) | Azimuth (deg) |
|----------|-----------------|----------|-----------------|------------|----------------------|-----------------|-------------|-------------|---------------|
| 2 | 1673.0 | -66.47 | 2.00 | 10.75 | Horizontal | -59.87 | -13.00 | 46.87 | 90 |
| 3 | 2509.5 | -60.53 | 2.51 | 11.05 | Horizontal | -54.14 | -13.00 | 41.14 | 135 |
| 4 | 3346.0 | -63.89 | 4.20 | 11.15 | Horizontal | -59.09 | -13.00 | 46.09 | 135 |
| 5 | 4182.5 | -60.42 | 5.20 | 11.15 | Horizontal | -56.62 | -13.00 | 43.62 | 0 |
| 6 | 5019.0 | -57.25 | 5.50 | 11.95 | Horizontal | -52.95 | -13.00 | 39.95 | 45 |
| 7 | 5855.5 | -58.49 | 5.70 | 13.55 | Horizontal | -52.79 | -13.00 | 39.79 | 135 |
| 8 | 6692.0 | -55.97 | 6.30 | 13.75 | Horizontal | -50.67 | -13.00 | 37.67 | 0 |
| 9 | 7528.5 | -55.11 | 6.80 | 13.85 | Horizontal | -50.21 | -13.00 | 37.21 | 270 |
| 10 | 8365.0 | -54.02 | 6.90 | 14.25 | Horizontal | -48.82 | -13.00 | 35.82 | 135 |

Note: 1.The other Spurious RF Radiated emissions level is no more than noise floor.

2.The worst emission was found in the antenna is Horizontal position.



6. Main Test Instruments

| Name | Manufacturer | Type | Serial Number | Calibration Date | Expiration Date |
|--------------------------------------|--------------|--------------|---------------|------------------|-----------------|
| Base Station Simulator | R&S | CMW500 | 113824 | 2018-05-20 | 2019-05-19 |
| Power Splitter | Hua Xiang | SHX-GF2-2-13 | 10120101 | / | / |
| Spectrum Analyzer | Key sight | N9010A | MY50210259 | 2018-05-20 | 2019-05-19 |
| Universal Radio Communication Tester | Key sight | E5515C | MY48367192 | 2018-05-20 | 2019-05-19 |
| Signal Analyzer | R&S | FSV30 | 100815 | 2017-12-17 | 2018-12-16 |
| EMI Test Receiver | R&S | ESCI | 100948 | 2018-05-20 | 2019-05-19 |
| Loop Antenna | SCHWARZBECK | FMZB1519 | 1519-047 | 2017-09-26 | 2019-09-25 |
| Trilog Antenna | SCHWARZBECK | VUBL 9163 | 9163-201 | 2017-11-18 | 2019-11-17 |
| Horn Antenna | R&S | HF907 | 100126 | 2018-07-07 | 2020-07-06 |
| Horn Antenna | ETS-Lindgren | 3160-09 | 00102643 | 2018-06-20 | 2020-06-19 |
| Signal generator | R&S | SMB 100A | 102594 | 2018-05-20 | 2019-05-19 |
| Climatic Chamber | ESPEC | SU-242 | 93000506 | 2017-12-17 | 2020-12-16 |
| Preamplifier | R&S | SCU18 | 102327 | 2018-05-20 | 2019-05-19 |
| MOB COMMS DC SUPPLY | Keysight | 66319D | MY43004105 | 2018-05-21 | 2019-05-20 |
| RF Cable | Agilent | SMA 15cm | 0001 | / | / |
| Software | R&S | EMC32 | 9.26.0 | / | / |

*****END OF REPORT *****