



# RF TEST REPORT

**Applicant** Huawei Technologies Co., Ltd.  
**FCC ID** QISJAT-LX3  
**Product** Smart Phone  
**Model** JAT-LX3  
**Report No.** R1811H0154-R4V1  
**Issue Date** December 18, 2018

TA Technology (Shanghai) Co., Ltd. tested the above equipment in accordance with the requirements in **FCC CFR47 Part 15C (2018)**. The test results show that the equipment tested is capable of demonstrating compliance with the requirements as documented in this report.

Performed by: Peng Tao

Approved by: Kai Xu

---

## TA Technology (Shanghai) Co., Ltd.

No.145, Jintang Rd, Tangzhen Industry Park, Pudong Shanghai, China

TEL: +86-021-50791141/2/3

FAX: +86-021-50791141/2/3-8000



# TABLE OF CONTENT

- 1. Test Laboratory ..... 4
  - 1.1. Notes of the test report..... 4
  - 1.2. Test facility ..... 4
  - 1.3. Testing Location..... 5
- 2. General Description of Equipment under Test..... 6
- 3. Applied Standards ..... 8
- 4. Test Configuration ..... 9
- 5. Test Case Results ..... 10
  - 5.1. Maximum output power ..... 10
  - 5.2. 6dB Bandwidth ..... 13
  - 5.3. Band Edge ..... 18
  - 5.4. Power Spectral Density ..... 21
  - 5.5. Spurious RF Conducted Emissions..... 26
  - 5.6. Unwanted Emission ..... 31
  - 5.7. Conducted Emission ..... 75
- 6. Main Test Instruments ..... 77



## Summary of measurement results

Number	Summary of measurements of results	Clause in FCC rules	Verdict
1	Maximum conducted output power	15.247(b)(3)	PASS
2	6 dB bandwidth	15.247(a)(2)	PASS
3	Power spectral density	15.247(e)	PASS
4	Band Edge	15.247(d)	PASS
5	Spurious RF Conducted Emissions	15.247(d)	PASS
6	Unwanted Emissions	15.247(d),15.205,15.209	PASS
7	Conducted Emissions	15.207	PASS

Date of Testing: November 11, 2018 ~ December 10, 2018



## 1. Test Laboratory

### 1.1. Notes of the test report

This report shall not be reproduced in full or partial, without the written approval of **TA technology (shanghai) co., Ltd.** The results documented in this report apply only to the tested sample, under the conditions and modes of operation as described herein .Measurement Uncertainties were not taken into account and are published for informational purposes only. This report is written to support regulatory compliance of the applicable standards stated above.

### 1.2. Test facility

#### **CNAS (accreditation number: L2264)**

TA Technology (Shanghai) Co., Ltd. has obtained the accreditation of China National Accreditation Service for Conformity Assessment (CNAS).

#### **FCC (Designation number: CN1179, Test Firm Registration Number: 446626)**

TA Technology (Shanghai) Co., Ltd. has been listed on the US Federal Communications Commission list of test facilities recognized to perform electromagnetic emissions measurements.

#### **IC (recognition number is 8510A)**

TA Technology (Shanghai) Co., Ltd. has been listed by industry Canada to perform electromagnetic emission measurement.

#### **VCCI (recognition number is C-4595, T-2154, R-4113, G-10766)**

TA Technology (Shanghai) Co., Ltd. has been listed by industry Japan to perform electromagnetic emission measurement.

#### **A2LA (Certificate Number: 3857.01)**

TA Technology (Shanghai) Co., Ltd. has been listed by American Association for Laboratory Accreditation to perform electromagnetic emission measurement.



### 1.3. Testing Location

Company: TA Technology (Shanghai) Co., Ltd.  
Address: No.145, Jintang Rd, Tangzhen Industry Park, Pudong  
City: Shanghai  
Post code: 201201  
Country: P. R. China  
Contact: Xu Kai  
Telephone: +86-021-50791141/2/3  
Fax: +86-021-50791141/2/3-8000  
Website: <http://www.ta-shanghai.com>  
E-mail: [xukai@ta-shanghai.com](mailto:xukai@ta-shanghai.com)

## 2. General Description of Equipment under Test

### Client Information

Applicant	Huawei Technologies Co., Ltd.
Applicant address	Administration Building, Headquarters of Huawei Technologies Co., Ltd., Bantian, Longgang District Shenzhen 518129 P.R.China
Manufacturer	Huawei Technologies Co., Ltd.
Manufacturer address	Administration Building, Headquarters of Huawei Technologies Co., Ltd., Bantian, Longgang District Shenzhen 518129 P.R.China

### General information

EUT Description	
Model	JAT-LX3
IMEI	IMEI 1:861844040014721 IMEI 2:861844040016023
Hardware Version	HL1JATM
Software Version	9.0.1.55(C900E61R1P4log)
Power Supply	Battery/AC adapter
Antenna Type	Internal Antenna
Antenna Connector	A permanently attached antenna (meet with the standard FCC Part 15.203 requirement)
Antenna Gain	-1.00 dBi
additional beamforming gain	NA
Test Mode	Bluetooth V4.2 LE 802.11b 802.11g, 802.11n(HT20/HT40);
Modulation Type	BLE :GFSK 802.11b: DSSS; 802.11g/n(HT20/HT40): OFDM
Max. Conducted Power	Wi-Fi 2.4G :17.82dBm BLE : -1.92dBm
Operating Frequency Range(s)	802.11b/g/n(HT20): 2412 ~ 2462 MHz 802.11n(HT40): 2422 ~ 2452 MHz BLE: 2402 ~2480 MHz
EUT Accessory	
Adapter 1	Manufacturer: Huawei Technologies Co., Ltd. (SHENZHEN HUNTKEY ELECTRIC CO., LTD.) Model: HW-050100U01



Adapter 2	Manufacturer: Huawei Technologies Co., Ltd. (HUIZHOU BYD ELECTRONIC CO., LTD.) Model: HW-050100U01
Adapter 3	Manufacturer: Huawei Technologies Co., Ltd. (Dongguan Phitek Electronics Co., Ltd.) Model: HW-050100U01
Battery 1	Manufacturer: Huawei Technologies Co., Ltd. (Sunwoda Electronic Co.,LTD ) Model: HB405979ECW
Battery 2	Manufacturer: Huawei Technologies Co., Ltd. (SCUD (Fujian) Electronics Co., LTD.) Model: HB405979ECW
Battery 3	Manufacturer: Huawei Technologies Co., Ltd. (Desay Battery Electronic Co.,LTD) Model: HB405979ECW
Earphone 1	Manufacturer: Jiangxi Lianchuang Hongsheng Electronic Co. ,LTD. Model: MEND1532B528A02
Earphone 2	Manufacturer: Boluo County Quancheng Electronic Co.,Ltd. Model: 1293-3283-3.5MM-322
USB Cable 1	Manufacturer: HONGLIN TECHNOLOGY CO.,LTD. Model: 130-26654
USB Cable 2	Manufacturer: Dongguan Ming Ji Electronics Co.,Ltd. Model: 203-0786-0
USB Cable 3	Manufacturer: Luxshare Precision industry Co., Ltd. Model: L99U2013-CS-H
USB Cable 4	Manufacturer: NingBo Broad Telecommunication Co., Ltd. Model: WA0007
<p>Note: The information of the EUT is declared by the manufacturer.</p> <p>2. There are more than one Adapter, Battery, Earphone and USB Cable, each one should be applied throughout the compliance test respectively, however, only the worst case (Adapter 1, Battery 1, Earphone 2 and USB Cable 4) will be recorded in this report.</p>	

### 3. Applied Standards

According to the specifications of the manufacturer, it must comply with the requirements of the following standards:

#### Test standards

- **FCC CFR47 Part 15C (2018) Radio Frequency Devices**
- **ANSI C63.10 (2013)**
- **KDB 558074 D01 15.247 Meas Guidance v05**



## 4. Test Configuration

### Test Mode

The EUT has been associated with peripherals and configuration operated in a manner tended to maximize its emission characteristics in a typical application.

The radiated emission was measured in the following position: EUT stand-up position (Z axis), lie-down position (X, Y axis). The worst emission was found in lie-down position (X axis) and the worst case was recorded.

In order to find the worst case condition, Pre-tests are needed at the presence of different data rate. Preliminary tests have been done on all the configuration for confirming worst case. Data rate below means worst-case rate of each test item.

Worst-case data rates are shown as following table.

Band	Data Rate
Bluetooth(Low Energy)	1Mbps
802.11b	1Mbps
802.11g	6Mbps
802.11n HT20	MCS0
802.11n HT40	MCS0

## 5. Test Case Results

### 5.1. Maximum output power

#### Ambient condition

Temperature	Relative humidity	Pressure
23°C ~25°C	45%~50%	101.5kPa

#### Methods of Measurement

During the process of the testing, The EUT was connected to Average Power meter with a known loss. The EUT is max power transmission with proper modulation. The signal transmission is continuous.

During the process of the testing, The EUT was connected to Average Power meter with a known loss. The EUT is max power transmission with proper modulation. The signal transmission is continuous.

#### Test Setup

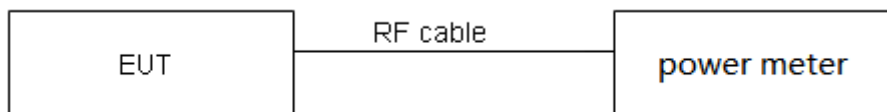

#### Limits

Rule Part 15.247 (b) (3) specifies that " For systems using digital modulation in the 902–928 MHz, 2400–2483.5 MHz: 1 Watt."

Average Output Power	$\leq 1W$ (30dBm)
----------------------	-------------------

#### Measurement Uncertainty

The assessed measurement uncertainty to ensure 95% confidence level for the normal distribution is with the coverage factor  $k = 2$ ,  $U = 0.44$  dB.

**Test Results**

Single Antenna Power Index					
Packet Type	CH1	CH2	CH6	CH10	CH11
802.11b	18.5	/	18.5	/	18.5
802.11g	13.5	17.5	17.5	17.5	13.5
802.11n HT20	13.5	17	17	17	13.5
Packet Type	CH3	CH4	CH6	CH8	CH9
802.11n HT40	13.5	16	16	16	13.5

Band	T <sub>on</sub> (ms)	T <sub>(on+off)</sub> (ms)	Duty cycle	Duty cycle correction Factor(dB)
802.11b	8.37	8.42	0.99	NA
802.11g	1.40	1.44	0.97	0.12
802.11n HT20	1.30	1.34	0.97	0.14
802.11n HT40	1.25	1.30	0.97	0.15
BLE	0.38	0.62	0.612	2.131

Note: when Duty cycle>0.98, Duty cycle correction Factor not required.

Network Standards	Carrier frequency (MHz)	Average Power Measured (dBm)	Average Power with duty factor (dBm)	Limit (dBm)	Conclusion
802.11b	2412	17.34	17.34	30	PASS
	2437	17.53	17.53	30	PASS
	2462	17.82	17.82	30	PASS
802.11g	2412	12.15	12.27	30	PASS
	2417	16.18	16.30	30	PASS
	2437	16.39	16.51	30	PASS
	2457	16.21	16.33	30	PASS
	2462	12.77	12.89	30	PASS
802.11n HT20	2412	12.16	12.30	30	PASS
	2417	15.62	15.76	30	PASS
	2437	15.86	16.00	30	PASS
	2457	15.71	15.85	30	PASS
	2462	12.68	12.82	30	PASS
802.11n HT40	2422	12.30	12.45	30	PASS
	2427	14.62	14.77	30	PASS
	2437	14.66	14.81	30	PASS
	2447	14.43	14.58	30	PASS
	2452	12.12	12.27	30	PASS
Bluetooth (Low Energy)	2402	-4.62	-2.49	30	PASS
	2440	-4.05	-1.92	30	PASS
	2480	-4.48	-2.35	30	PASS

Note: Average Power with duty factor = Average Power Measured +Duty cycle correction factor

## 5.2. 6dB Bandwidth

### Ambient condition

Temperature	Relative humidity	Pressure
23°C ~25°C	45%~50%	101.5kPa

### Method of Measurement

The EUT was connected to the spectrum analyzer through an external attenuator (20dB) and a known loss cable. RBW is set to 100 kHz; VBW is set to 300 kHz on spectrum analyzer. Dector=Peak, Trace mode=max hold.

### Test Setup

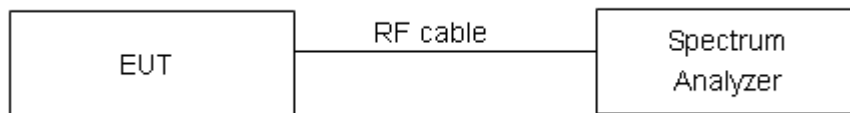

### Limits

Rule Part 15.247 (a) (2) specifies that “Systems using digital modulation techniques may operate in the 902–928 MHz, 2400–2483.5 MHz bands. The minimum 6 dB bandwidth shall be at least 500 kHz.”

minimum 6 dB bandwidth	≥ 500 kHz
------------------------	-----------

### Measurement Uncertainty

The assessed measurement uncertainty to ensure 95% confidence level for the normal distribution is with the coverage factor  $k = 2$ ,  $U = 936$  Hz.

**Test Results:**

Network Standards	Carrier frequency (MHz)	99% bandwidth (MHz)	Minimum 6 dB bandwidth (MHz)	Limit (kHz)	Conclusion
802.11b	2412	12.629	8.080	500	PASS
	2437	12.864	8.068	500	PASS
	2462	12.663	8.058	500	PASS
802.11g	2412	16.425	15.74	500	PASS
	2437	16.506	16.36	500	PASS
	2462	16.440	16.08	500	PASS
802.11n HT20	2412	17.620	16.37	500	PASS
	2437	17.700	17.60	500	PASS
	2462	17.603	17.30	500	PASS
802.11n HT40	2422	35.898	35.48	500	PASS
	2437	36.224	36.38	500	PASS
	2452	36.140	35.78	500	PASS
Bluetooth (Low Energy)	2402	1.0575	0.7123	500	PASS
	2440	1.0579	0.7116	500	PASS
	2480	1.0555	0.7115	500	PASS

802.11b, Carrier frequency (MHz): 2412



802.11g, Carrier frequency (MHz): 2412



802.11b, Carrier frequency (MHz): 2437



802.11g, Carrier frequency (MHz): 2437

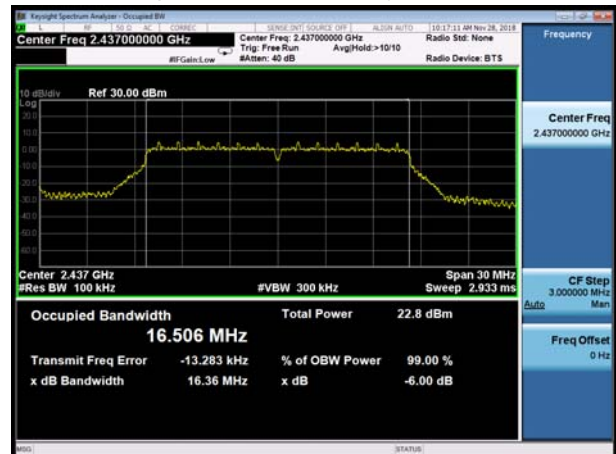

802.11b, Carrier frequency (MHz): 2462



802.11g, Carrier frequency (MHz): 2462

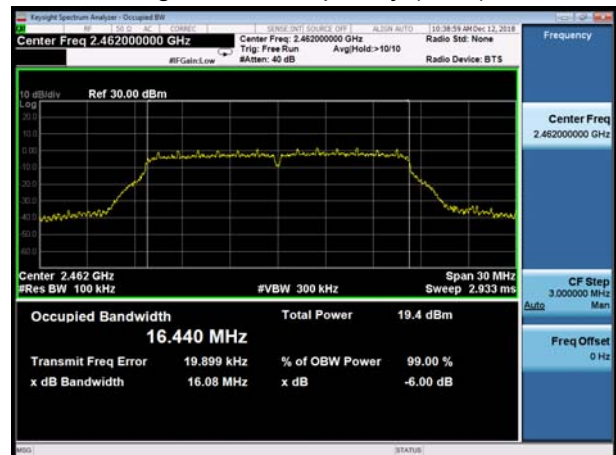



802.11n(HT20), Carrier frequency (MHz): 2412



802.11n(HT40), Carrier frequency (MHz): 2422



802.11n(HT20), Carrier frequency (MHz): 2437



802.11n(HT40), Carrier frequency (MHz): 2437



802.11n(HT20), Carrier frequency (MHz):2462

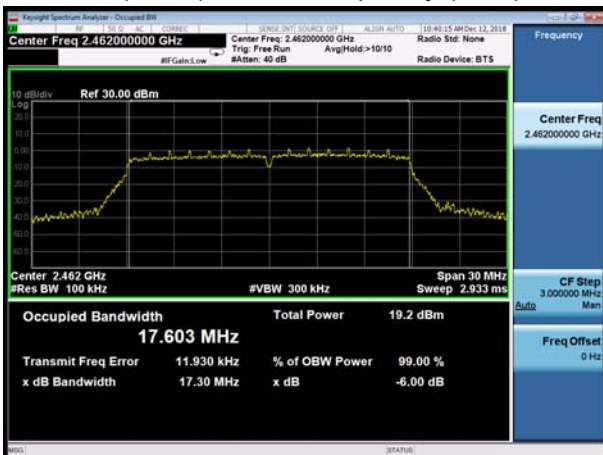

802.11n(HT40), Carrier frequency (MHz):2452

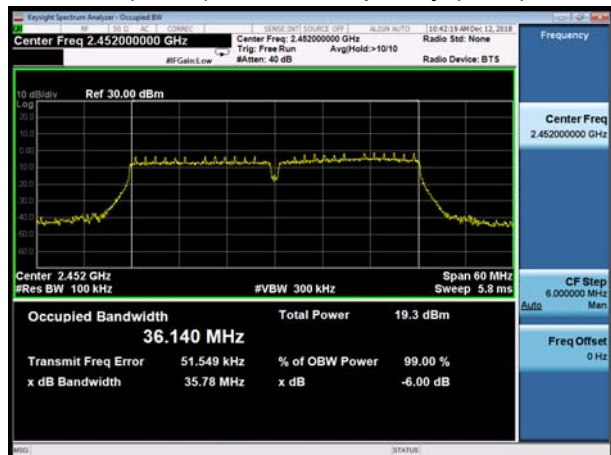





BLE Carrier frequency (MHz): 2402

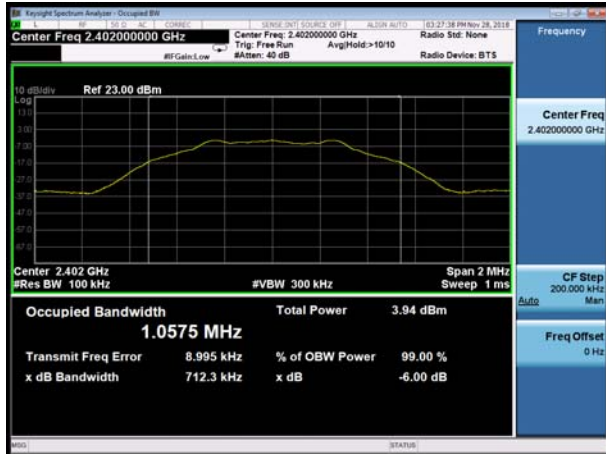

BLE Carrier frequency (MHz): 2440



BLE Carrier frequency (MHz): 2480



### 5.3. Band Edge

#### Ambient condition

Temperature	Relative humidity	Pressure
23°C ~25°C	45%~50%	101.5kPa

#### Method of Measurement

The EUT was connected to the spectrum analyzer through an external attenuator (20dB) and a known loss cable the band edge of the lowest and highest channels were measured. The peak detector is used and RBW is set to 100 kHz and VBW is set to 300 kHz on spectrum analyzer. Spectrum analyzer plots are included on the following pages.

#### Test Setup

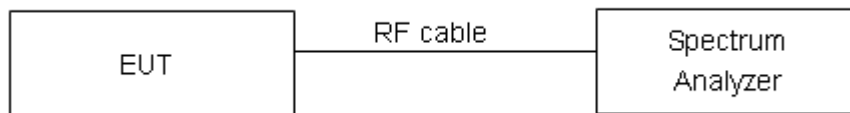

#### Limits

Rule Part 15.247(d) specifies that “In any 100 kHz bandwidth outside the frequency band in which the spread spectrum or digitally modulated intentional radiator is operating, the radio frequency power that is produced by the intentional radiator shall be at least 20 dB below that in the 100 kHz bandwidth within the band that contains the highest level of the desired power, based on either an RF conducted or a radiated measurement, provided the transmitter demonstrates compliance with the peak conducted power limits.” If the transmitter complies with the conducted power limits based on the use of RMS averaging over a time interval, as permitted under paragraph (b)(3) of this section, the attenuation required under this paragraph shall be 30 dB instead of 20 dB.”

#### Measurement Uncertainty

The assessed measurement uncertainty to ensure 95% confidence level for the normal distribution is with the coverage factor  $k = 1.96$ .

Frequency	Uncertainty
2GHz-3GHz	1.407 dB



Test Results: PASS

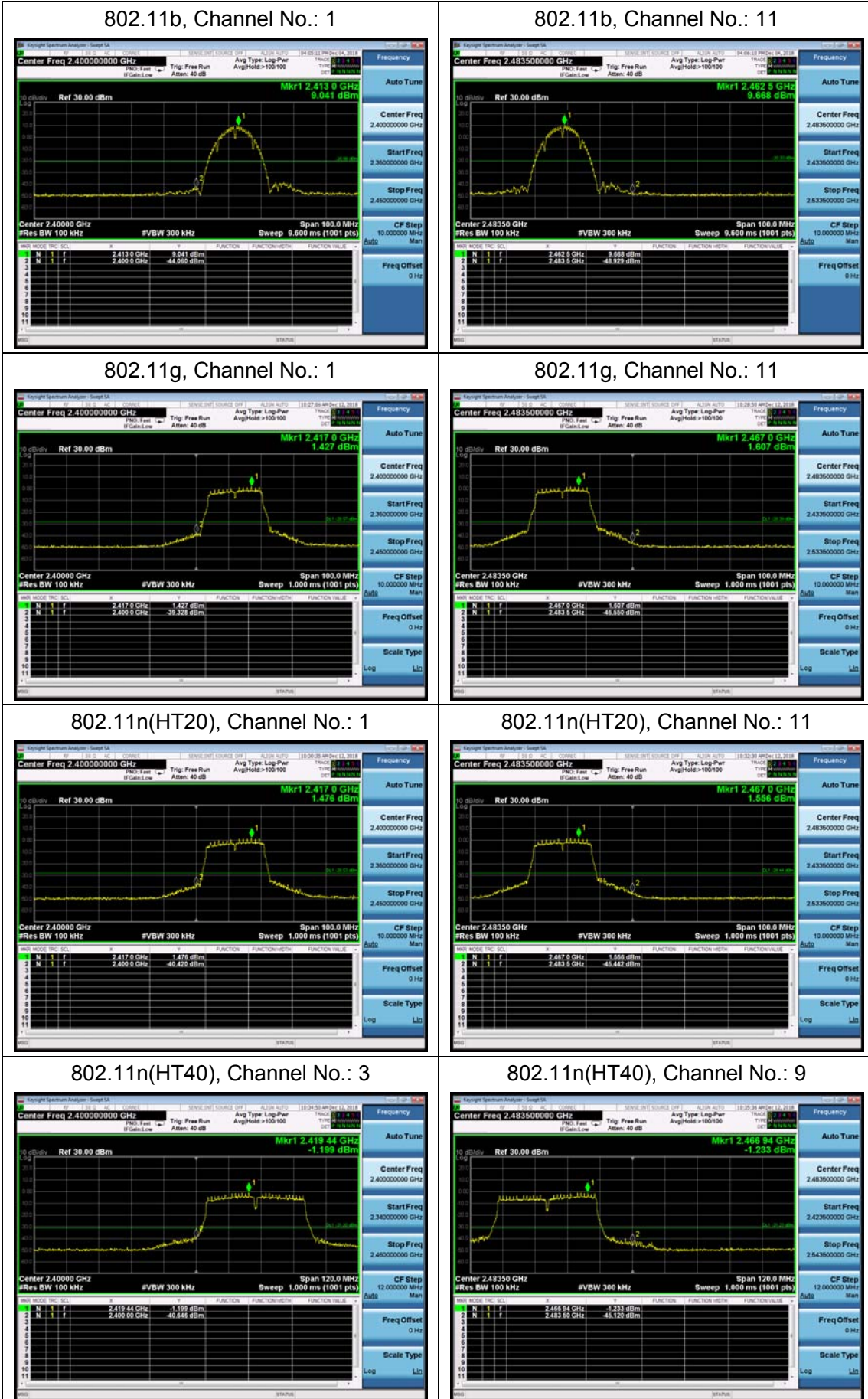

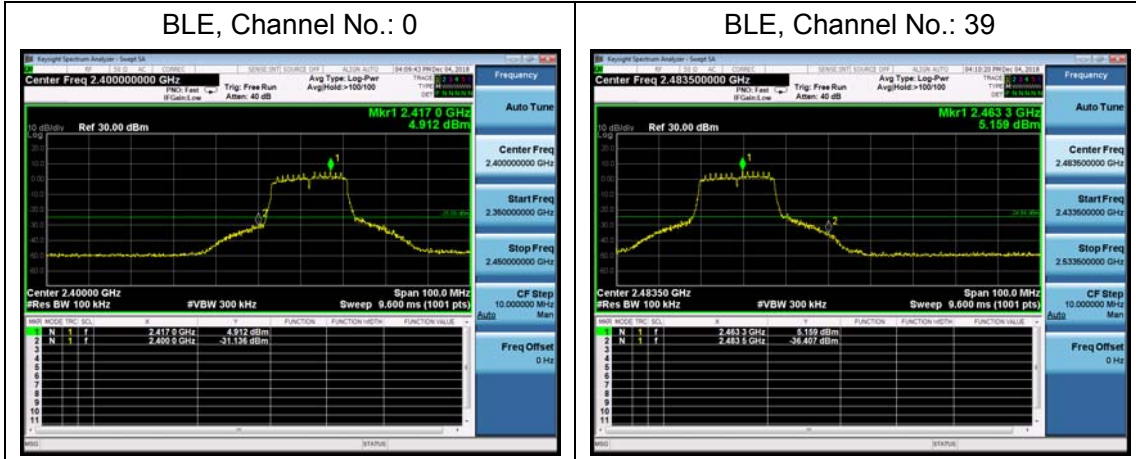

### 5.4. Power Spectral Density

#### Ambient condition

Temperature	Relative humidity	Pressure
23°C ~25°C	45%~50%	101.5kPa

#### Method of Measurement

During the process of the testing, The EUT was connected to Spectrum Analyzer with a known loss. The EUT is max power transmission with proper modulation. Method AVGPSD-2 in KDB558074 D01 was used for this test.

#### Test setup

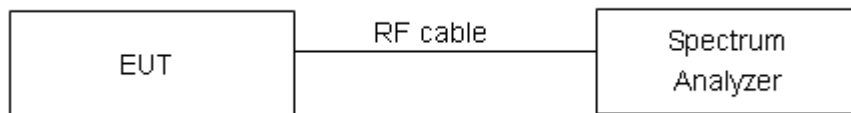

#### Limits

Rule Part 15.247(e) specifies that” For digitally modulated systems, the power spectral density conducted from the intentional radiator to the antenna shall not be greater than 8 dBm in any 3 kHz band during any time interval of continuous transmission. ”

Limits	≤ 8 dBm / 3kHz
--------	----------------

#### Measurement Uncertainty

The assessed measurement uncertainty to ensure 95% confidence level for the normal distribution is with the coverage factor  $k = 2$ ,  $U = 0.75\text{dB}$ .

**Test Results:**

Network Standards	Channel Number	Read Value (dBm / 3kHz)	Power Spectral Density (dBm / 3kHz)	Limit (dBm / 3kHz)	Conclusion
802.11b	1	-15.00	-15.00	8	PASS
	6	-14.79	-14.79	8	PASS
	11	-14.65	-14.65	8	PASS
802.11g	1	-22.95	-22.83	8	PASS
	6	-19.08	-18.95	8	PASS
	11	-22.35	-22.22	8	PASS
802.11n HT20	1	-22.77	-22.63	8	PASS
	6	-19.99	-19.84	8	PASS
	11	-22.93	-22.79	8	PASS
802.11n HT40	3	-26.29	-26.14	8	PASS
	6	-23.85	-23.70	8	PASS
	9	-26.05	-25.90	8	PASS
Bluetooth (Low Energy)	0	-21.95	-19.82	8	PASS
	19	-21.02	-18.89	8	PASS
	39	-21.50	-19.37	8	PASS

Note: Power Spectral Density =Read Value+Duty cycle correction factor

802.11b, Channel No.: 1



802.11g, Channel No.: 1



802.11b, Channel No.: 6



802.11g, Channel No.: 6



802.11b, Channel No.: 11



802.11g, Channel No.: 11







802.11n(HT20), Channel No. 1



802.11n(HT40), Channel No. 3



802.11n(HT20), Channel No. 6

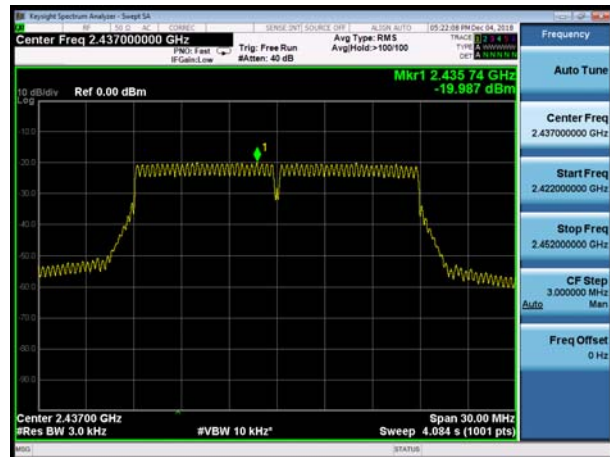

802.11n(HT40), Channel No. 6

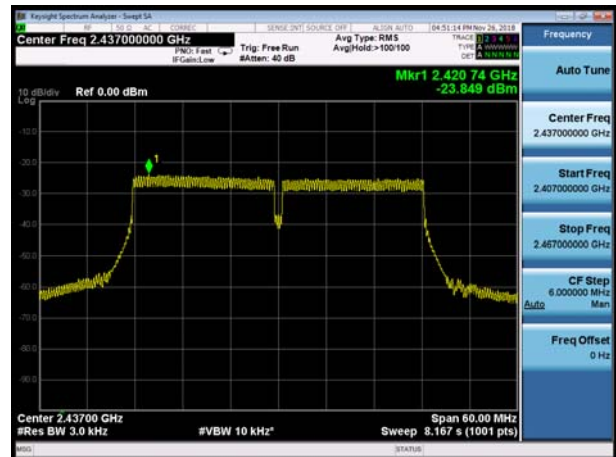

802.11n(HT20), Channel No. 11



802.11n(HT40), Channel No. 9







BLE, Channel No.: 0

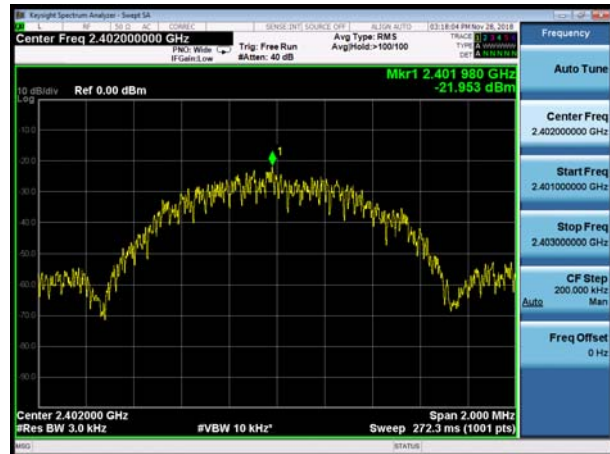

BLE, Channel No.: 19



BLE, Channel No.: 39



### 5.5. Spurious RF Conducted Emissions

**Ambient condition**

Temperature	Relative humidity	Pressure
23°C ~25°C	45%~50%	101.5kPa

**Method of Measurement**

The EUT was connected to the spectrum analyzer with a known loss. The spectrum analyzer scans from 30MHz to the 10th harmonic of the carrier. The peak detector is used. Set RBW to 100 kHz and VBW to 300 kHz, Sweep is set to ATUO.

The test is in transmitting mode.

**Test setup**



**Limits**

Rule Part 15.247(d) pacifies that “In any 100 kHz bandwidth outside the frequency band in which the spread spectrum or digitally modulated intentional radiator is operating, the radio frequency power that is produced by the intentional radiator shall be at least 20 dB below that in the 100 kHz bandwidth within the band that contains the highest level of the desired power, based on either an RF conducted or a radiated measurement, provided the transmitter demonstrates compliance with the peak conducted power limits. If the transmitter complies with the conducted power limits based on the use of RMS averaging over a time interval, as permitted under paragraph (b)(3) of this section, the attenuation required under this paragraph shall be 30 dB instead of 20 dB. ”

Network Standards	Carrier frequency (MHz)	Reference value (dBm)	Limit
802.11b	2412	8.30	-21.70
	2437	7.84	-22.16
	2462	8.95	-21.05
802.11g	2412	1.29	-28.71
	2437	4.77	-25.23
	2462	1.68	-28.33
802.11n HT20	2412	1.64	-28.36
	2437	4.22	-25.78
	2462	1.03	-28.97
802.11n HT40	2422	-1.56	-31.56
	2437	1.27	-28.73



	2452	-0.89	-30.89
Bluetooth (Low Energy)	2402	-3.07	-33.07
	2440	-2.23	-32.23
	2480	-2.75	-32.75

### Measurement Uncertainty

The assessed measurement uncertainty to ensure 95% confidence level for the normal distribution is with the coverage factor  $k = 1.96$ .

Frequency	Uncertainty
100kHz-2GHz	0.684 dB
2GHz-26GHz	1.407 dB



Test Results:

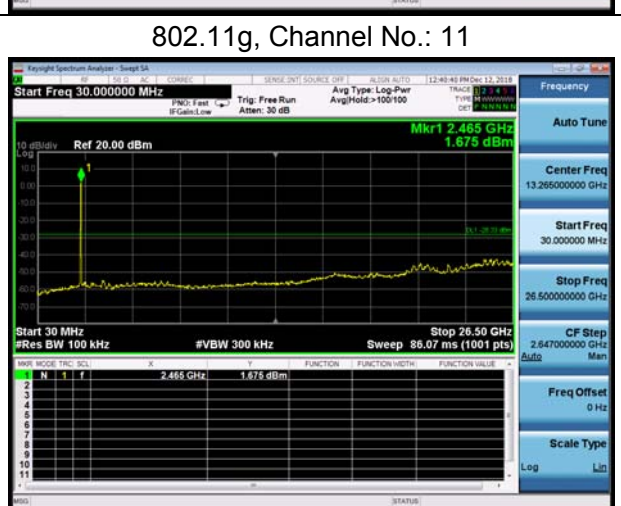
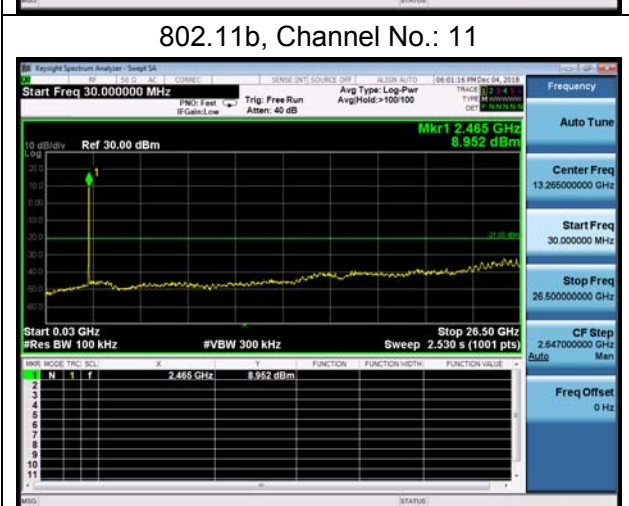
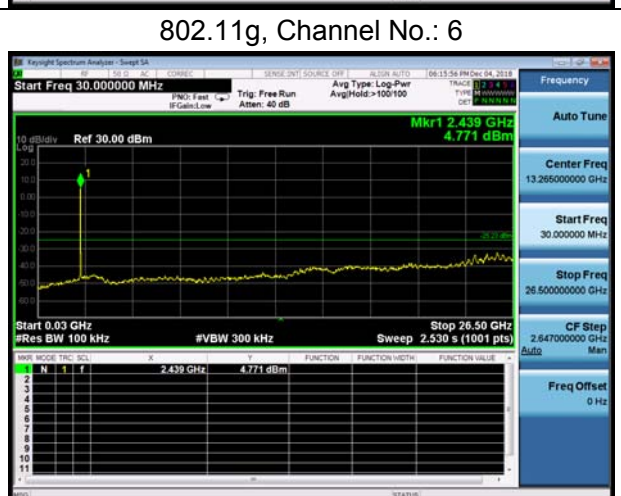
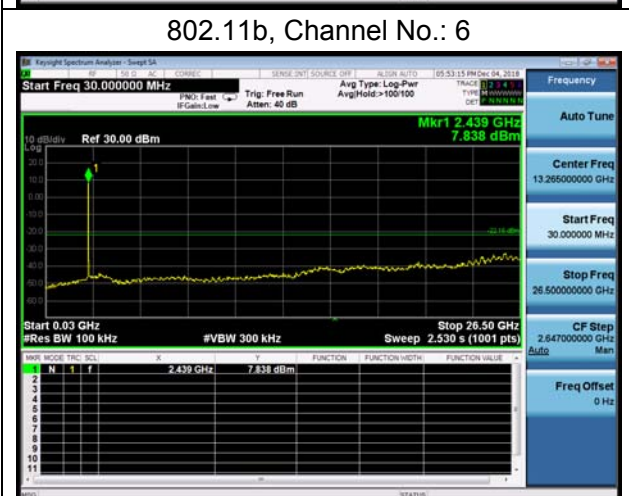
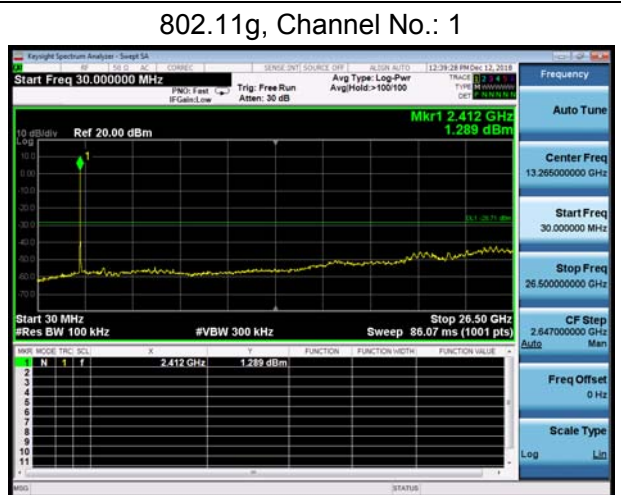
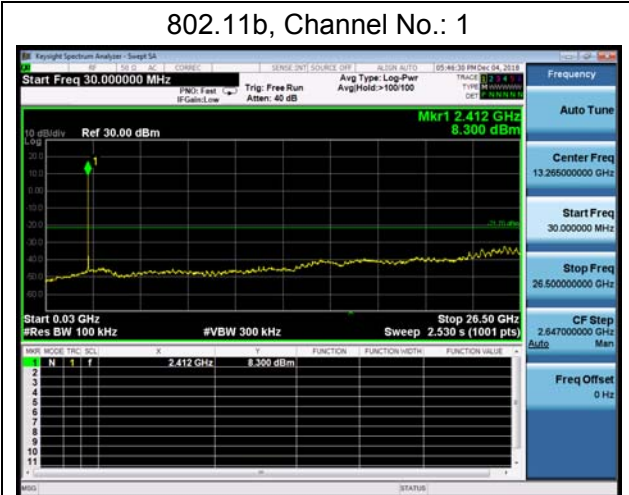



802.11n(HT20), Channel No. 1

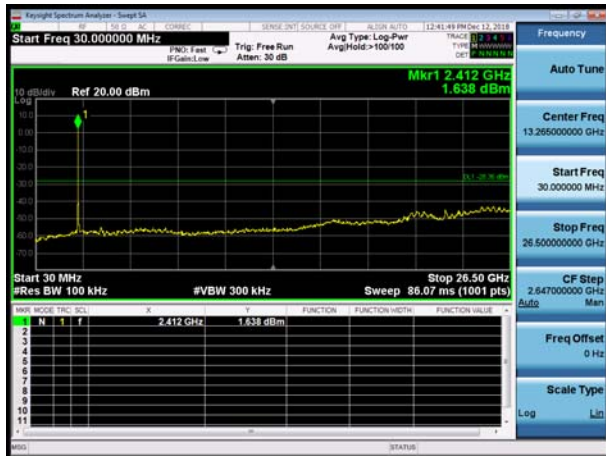

802.11n(HT40), Channel No. 3

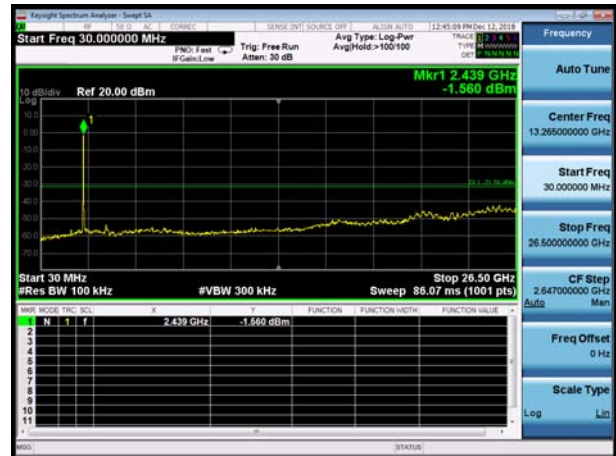

802.11n(HT20), Channel No. 6

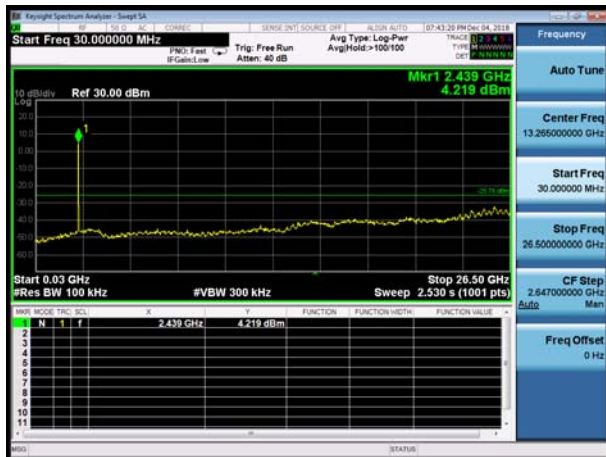

802.11n(HT40), Channel No. 6

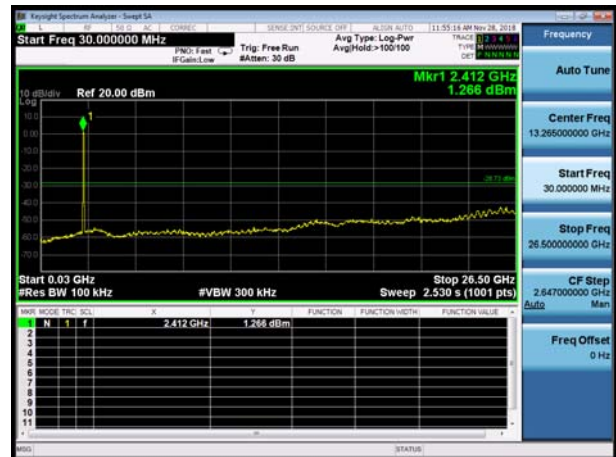

802.11n(HT20), Channel No. 11

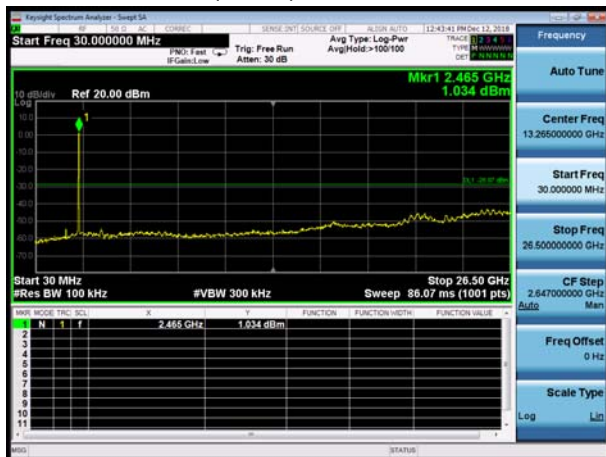

802.11n(HT40), Channel No. 9

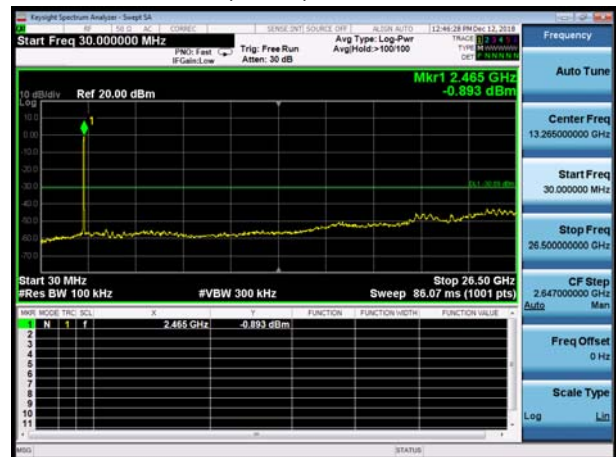





BLE, Channel No.: 0

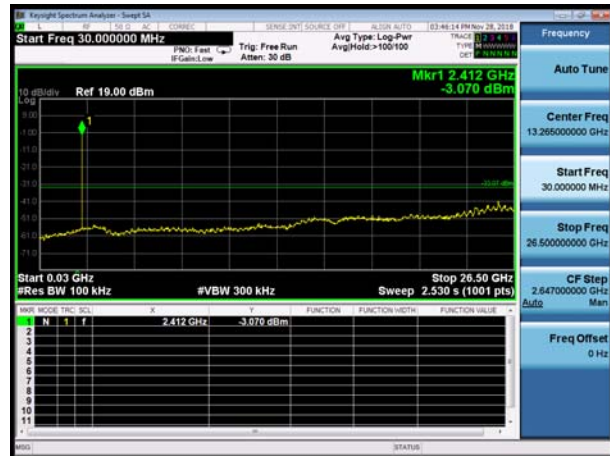

BLE, Channel No.: 19

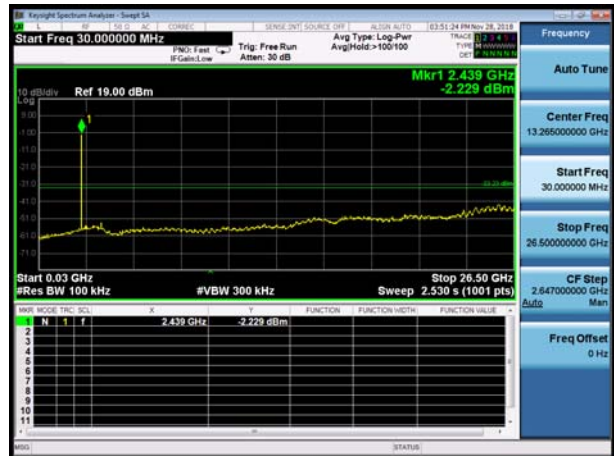

BLE, Channel No.: 39

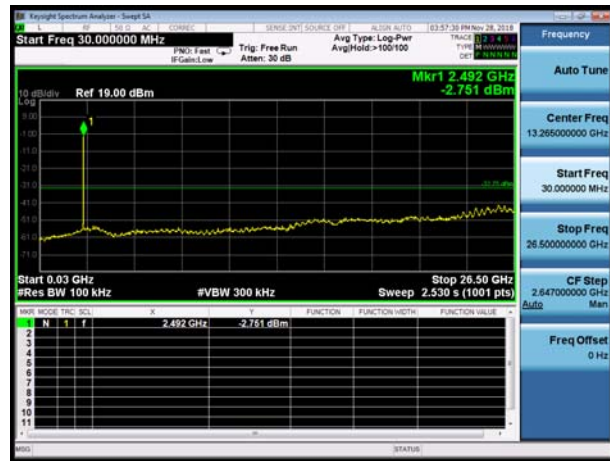

## 5.6. Unwanted Emission

### Ambient condition

Temperature	Relative humidity	Pressure
23°C ~25°C	45%~50%	102.5kPa

### Method of Measurement

The test set-up was made in accordance to the general provisions of ANSI C63.10-2013.

The Equipment Under Test (EUT) was set up on a non-conductive table in the semi-anechoic chamber. The test was performed at the distance of 3 m between the EUT and the receiving antenna.

The turntable shall be rotated from 0 to 360 degrees for detecting the maximum of radiated spurious signal level. The measurements shall be repeated with orthogonal polarization of the test antenna. The data of cable loss and antenna factor has been calibrated in full testing frequency range before the testing. Sweep the Restricted Band and the emissions less than 20 dB below the permissible value are reported.

The radiated emissions measurements were made in a typical installation configuration.

Sweep the whole frequency band through the range from 9 kHz to the 10th harmonic of the carrier, and the emissions less than 20 dB below the permissible value are reported.

This method refer to ANSI C63.10-2013.

The procedure for peak unwanted emissions measurements above 1000 MHz is as follows:

I) Peak emission levels are measured by setting the instrument as follows:

- 1) RBW = 1 MHz.
- 2) VBW  $\geq$  [3  $\times$  RBW]
- 3) Detector = peak.
- 4) Sweep time = auto.
- 5) Trace mode = max hold.
- 6) Allow sweeps to continue until the trace stabilizes. Note that if the transmission is not continuous, then the time required for the trace to stabilize will increase by a factor of approximately 1 / D, where D is the duty cycle.

II) Average emission levels are measured by setting the instrument as follows:

- a) RBW = 1 MHz.
- b) VBW  $\geq$  [3  $\times$  RBW].
- c) Detector = RMS (power averaging), if [span / (# of points in sweep)]  $\leq$  RBW / 2. Satisfying this condition can require increasing the number of points in the sweep or reducing the span. If the condition is not satisfied, then the detector mode shall be set to peak.
- d) Averaging type = power (i.e., rms) (As an alternative, the detector and averaging type may be set for linear voltage averaging. Some instruments require linear display mode to use linear voltage



averaging. Log or dB averaging shall not be used.)

e) Sweep time = auto.

f) Perform a trace average of at least 100 traces if the transmission is continuous. If the transmission is not continuous, then the number of traces shall be increased by a factor of  $1 / D$ , where  $D$  is the duty cycle. For example, with 50% duty cycle, at least 200 traces shall be averaged. (If a specific emission is demonstrated to be continuous—i.e., 100% duty cycle—then rather than turning ON and OFF with the transmit cycle, at least 100 traces shall be averaged.)

g) If tests are performed with the EUT transmitting at a duty cycle less than 98%, then a correction factor shall be added to the measurement results prior to comparing with the emission limit, to compute the emission level that would have been measured had the test been performed at 100% duty cycle. The correction factor is computed as follows:

1) If power averaging (rms) mode was used in the preceding step e), then the correction factor is  $[10 \log (1 / D)]$ , where  $D$  is the duty cycle. For example, if the transmit duty cycle was 50%, then 3 dB shall be added to the measured emission levels.

2) If linear voltage averaging mode was used in the preceding step e), then the correction factor is  $[20 \log (1 / D)]$ , where  $D$  is the duty cycle. For example, if the transmit duty cycle was 50%, then 6 dB shall be added to the measured emission levels.

3) If a specific emission is demonstrated to be continuous (100% duty cycle) rather than turning ON and OFF with the transmit cycle, then no duty cycle correction is required for that emission.

The field strength of spurious emission was measured in the following position: EUT stand-up position (Z axis), lie-down position (X, Y axis). The worst emission was found in lie-down position (X axis) and the loop antenna is vertical, the others are vertical and horizontal.

The test is in transmitting mode.



**Test setup**

**9KHz ~ 30MHz**

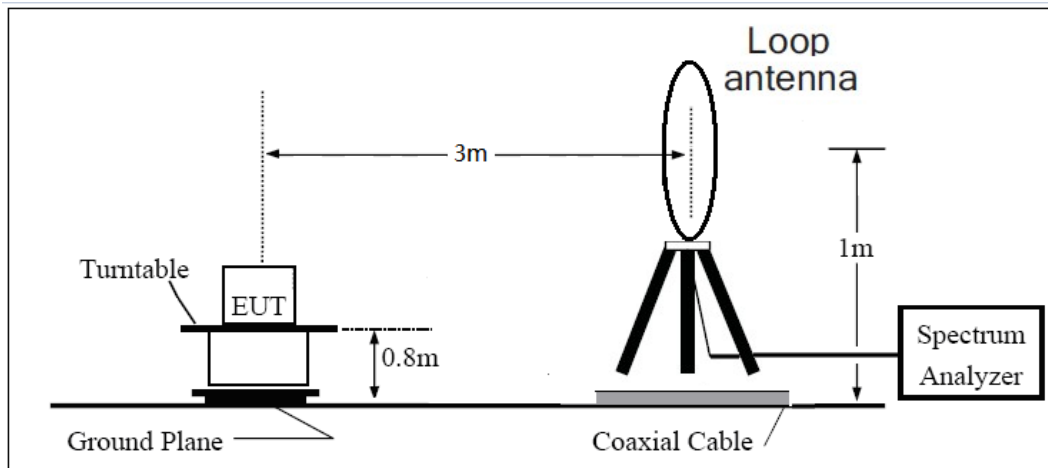

**30MHz ~ 1GHz**

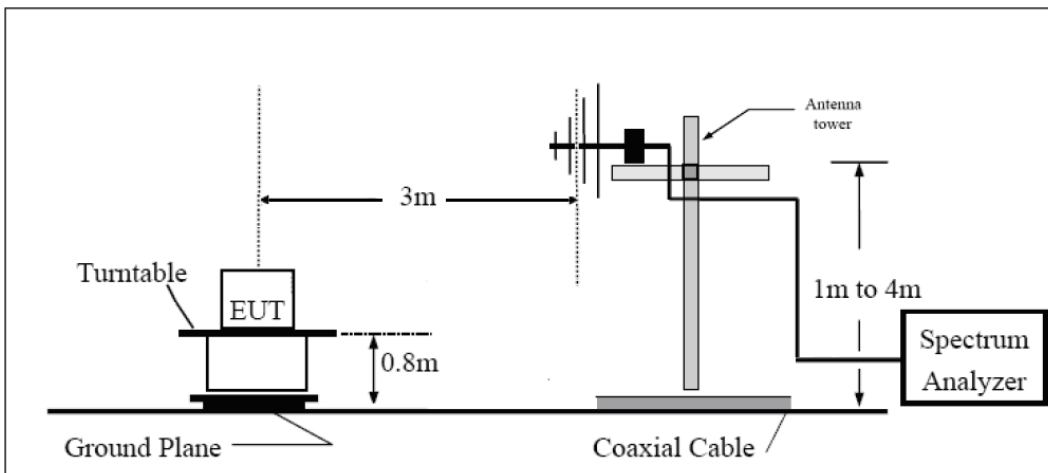

**Above 1GHz**

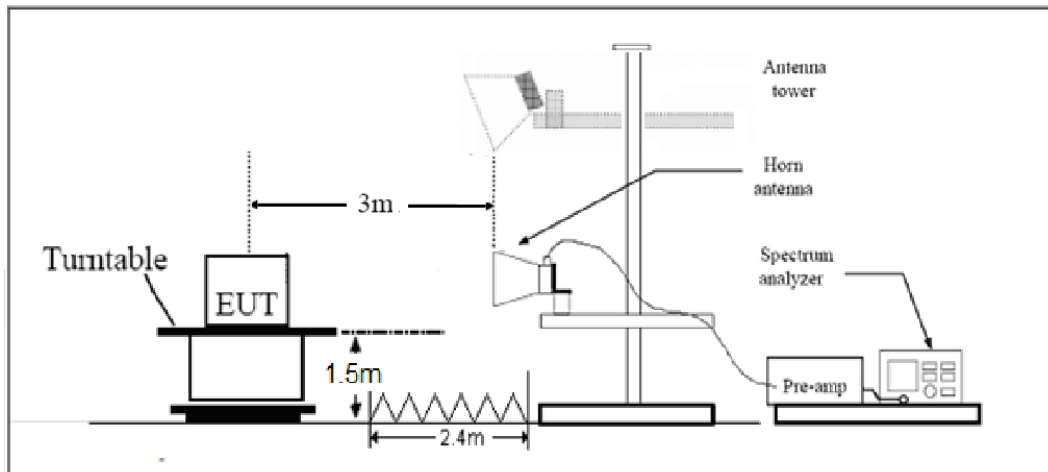

Note: Area side:2.4mX3.6m

**Limits**

Rule Part 15.247(d) specifies that “In addition, radiated emissions which fall in the restricted bands, as defined in § 15.205(a), must also comply with the radiated emission limits specified in § 15.209(a) (see § 15.205(c)).”

Limit in restricted band

Frequency of emission (MHz)	Field strength(uV/m)	Field strength(dBuV/m)
0.009–0.490	2400/F(kHz)	/
0.490–1.705	24000/F(kHz)	/
1.705–30.0	30	/
30-88	100	40
88-216	150	43.5
216-960	200	46
Above960	500	54

§15.35(b)

There is also a limit on the radio frequency emissions, as measured using instrumentation with a peak detector function, corresponding to 20 dB above the maximum permitted average limit.

Peak Limit=74 dBuV/m

Average Limit=54 dBuV/m

Spurious Radiated Emissions are permitted in any of the frequency bands listed below:

MHz	MHz	MHz	GHz
0.090 - 0.110	16.42 - 16.423	399.9 - 410	4.5 - 5.15
<sup>1</sup> 0.495 - 0.505	16.69475 - 16.69525	608 - 614	5.35 - 5.46
2.1735 - 2.1905	16.80425 - 16.80475	960 - 1240	7.25 - 7.75
4.125 - 4.128	25.5 - 25.67	1300 - 1427	8.025 - 8.5
4.17725 - 4.17775	37.5 - 38.25	1435 - 1626.5	9.0 - 9.2
4.20725 - 4.20775	73 - 74.6	1645.5 - 1646.5	9.3 - 9.5
6.215 - 6.218	74.8 - 75.2	1660 - 1710	10.6 - 12.7
6.26775 - 6.26825	108 - 121.94	1718.8 - 1722.2	13.25 - 13.4
6.31175 - 6.31225	123 - 138	2200 - 2300	14.47 - 14.5
8.291 - 8.294	149.9 - 150.05	2310 - 2390	15.35 - 16.2
8.362 - 8.366	156.52475 - 156.52525	2483.5 - 2500	17.7 - 21.4
8.37625 - 8.38675	156.7 - 156.9	2690 - 2900	22.01 - 23.12
8.41425 - 8.41475	162.0125 - 167.17	3260 - 3267	23.6 - 24.0
12.29 - 12.293	167.72 - 173.2	3332 - 3339	31.2 - 31.8
12.51975 - 12.52025	240 - 285	3345.8 - 3358	36.43 - 36.5
12.57675 - 12.57725	322 - 335.4	3600 - 4400	( <sup>2</sup> )
13.36 - 13.41			

**Measurement Uncertainty**

The assessed measurement uncertainty to ensure 95% confidence level for the normal distribution is with the coverage factor  $k = 1.96$ .

Frequency	Uncertainty
9KHz-30MHz	3.55 dB
30MHz-200MHz	4.02 dB
200MHz-1GHz	3.28 dB
1-18GHz	3.70 dB
18-26.5GHz	5.78 dB

**Test Results:**

**SISO Antenna 2**

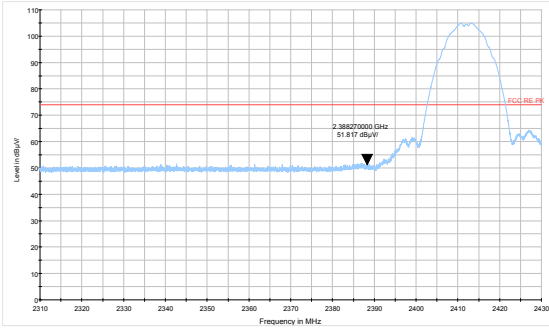

802.11b-Channel 1 Peak

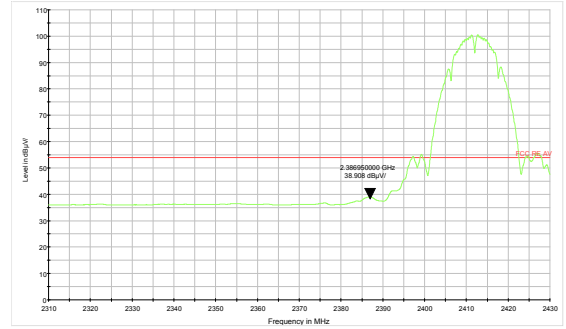

802.11b-Channel 1 Average

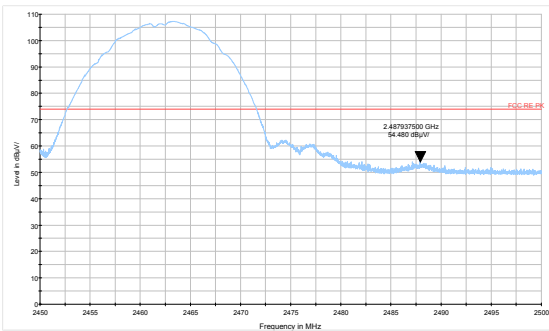

802.11b-Channel 11 Peak

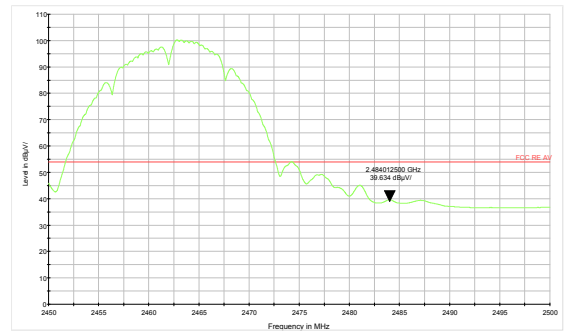

802.11b-Channel 11 Average

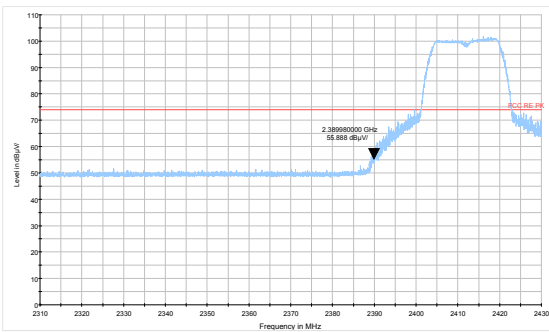

802.11g-Channel 1 Peak

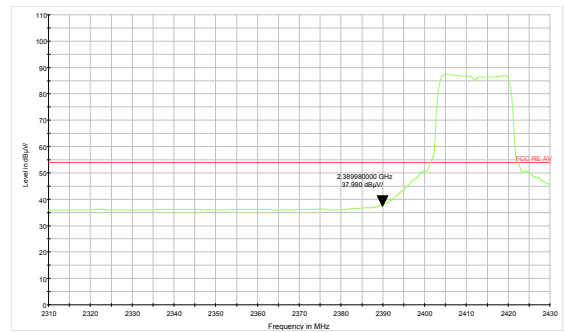

802.11g-Channel 1 Average

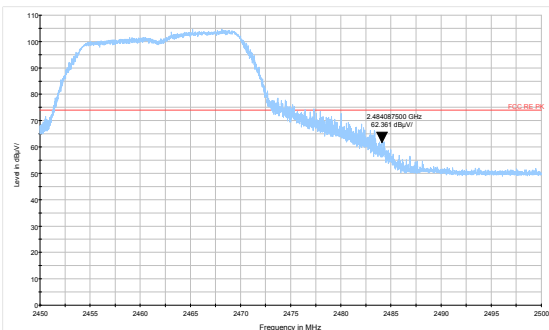

802.11g-Channel 11 Peak

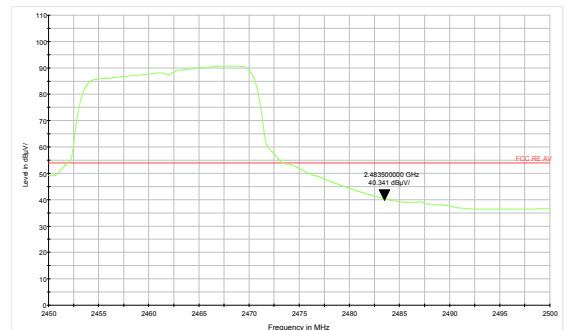

802.11g-Channel 11 Average

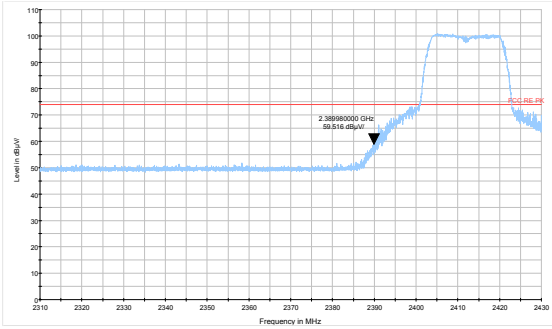

802.11n HT20 -Channel 1 Peak

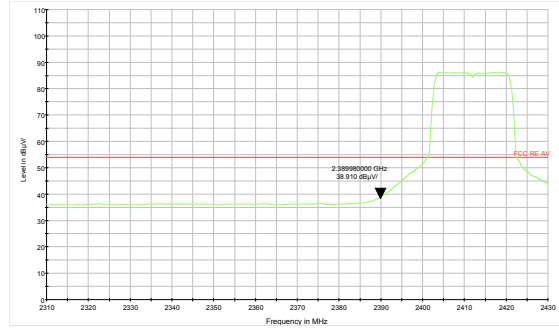

802.11n HT20 -Channel 1 Average

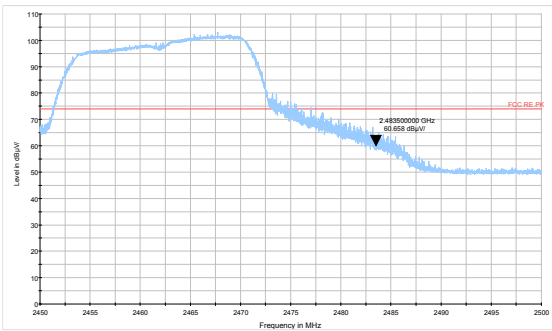

802.11n HT20 -Channel 11 Peak

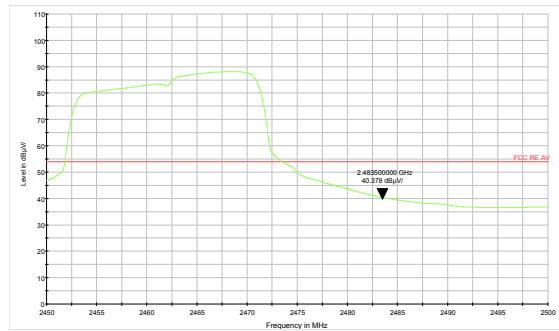

802.11n HT20 -Channel 11 Average

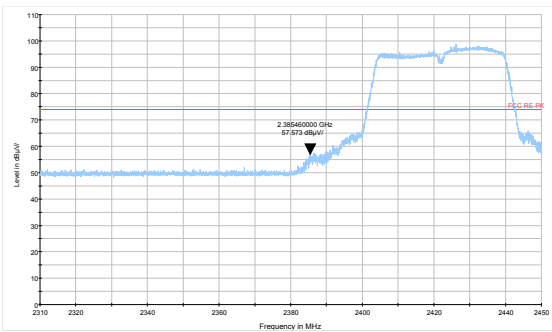

802.11n HT40 -Channel 3 Peak

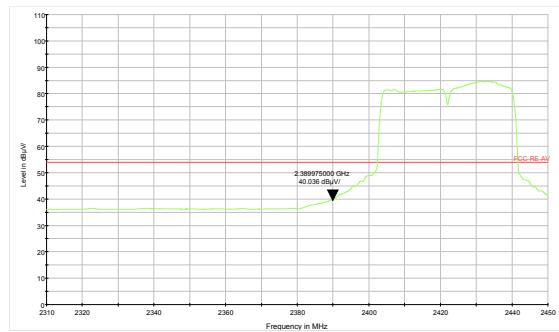

802.11n HT40 -Channel 3 Average

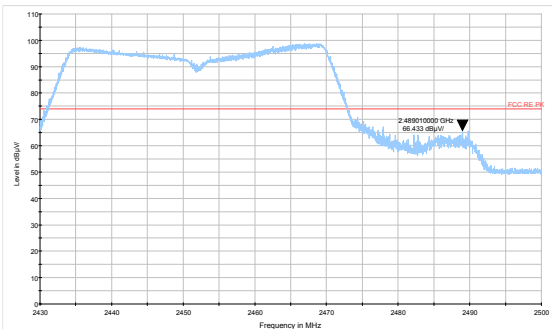

802.11n HT40 -Channel 9 Peak

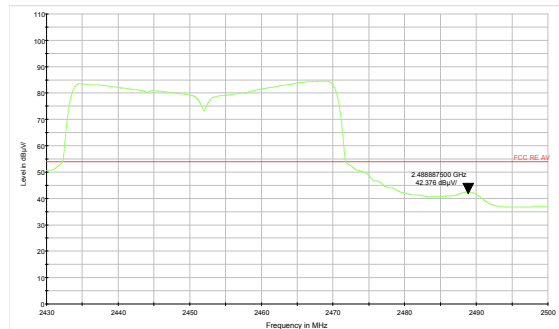

802.11n HT40 -Channel 9 Average

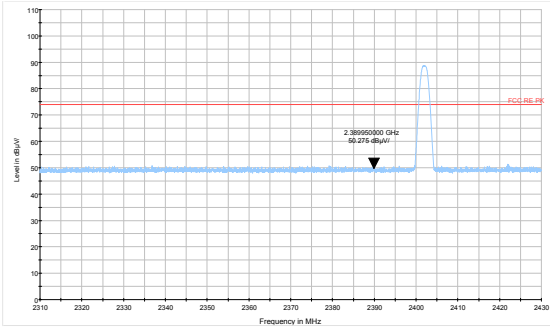

BLE Channel 0 Peak

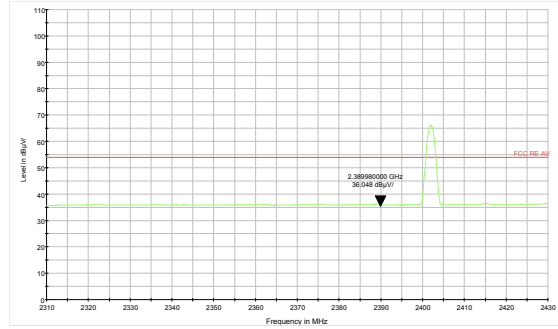

BLE Channel 0 Average

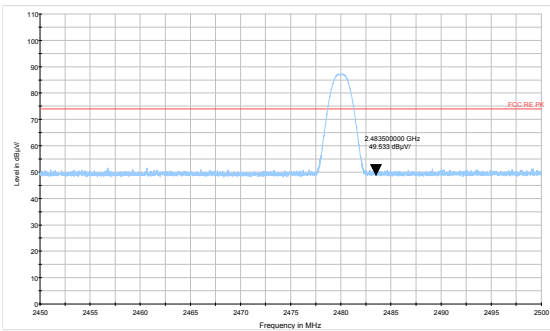

BLE Channel 39 Peak

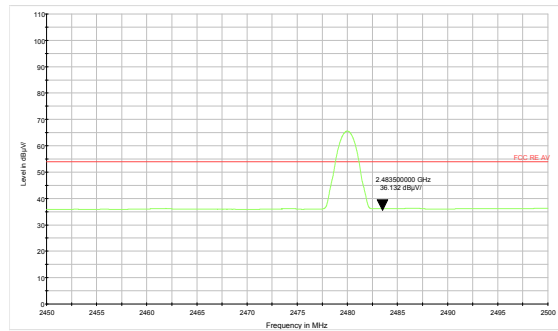

BLE Channel 39 Average

Band	T <sub>on</sub> (ms)	T <sub>(on+off)</sub> (ms)	Duty cycle	Duty cycle correction Factor(dB)
802.11b	8.37	8.42	0.99	0.00
802.11g	1.40	1.44	0.97	0.12
802.11n HT20	1.30	1.34	0.97	0.14
802.11n HT40	1.25	1.30	0.97	0.15
BLE	0.38	0.62	0.612	2.131

Note: when Duty cycle>0.98, Duty cycle correction Factor not required.

**802.11b-Channel 1**

Frequency (MHz)	Peak (dBuV/m)	Average (dBuV/m)	Height (cm)	Polarization	Azimuth (deg)	Duty cycle correction Factor(dB)	conclusion value (dBuV/m)	Margin (dB)	Limit (dBuV/m)
2390	51.817	--	200.0	V	135	0.00	51.817	22.183	74
2390	--	38.908	200.0	V	135	0.00	38.908	15.092	54

**802.11b-Channel 11**

Frequency (MHz)	Peak (dBuV/m)	Average (dBuV/m)	Height (cm)	Polarization	Azimuth (deg)	Duty cycle correction Factor(dB)	conclusion value (dBuV/m)	Margin (dB)	Limit (dBuV/m)
2483.5	54.480	--	200.0	V	135	0.00	54.480	19.520	74
2483.5	--	39.634	200.0	V	135	0.00	39.634	14.366	54

**802.11g-Channel 1**

Frequency (MHz)	Peak (dBuV/m)	Average (dBuV/m)	Height (cm)	Polarization	Azimuth (deg)	Duty cycle correction Factor(dB)	conclusion value (dBuV/m)	Margin (dB)	Limit (dBuV/m)
2390	55.888	--	150	V	65	0.12	56.008	17.992	74
2390	--	37.990	150	V	65	0.12	38.110	15.890	54

**802.11g-Channel 11**

Frequency (MHz)	Peak (dBuV/m)	Average (dBuV/m)	Height (cm)	Polarization	Azimuth (deg)	Duty cycle correction Factor(dB)	conclusion value (dBuV/m)	Margin (dB)	Limit (dBuV/m)
2483.5	62.361	--	150	V	78	0.12	62.481	11.519	74
2483.5	--	40.341	150	V	78	0.12	40.461	13.539	54

**802.11n HT20 -Channel 1**

Frequency (MHz)	Peak (dBuV/m)	Average (dBuV/m)	Height (cm)	Polarization	Azimuth (deg)	Duty cycle correction Factor(dB)	conclusion value (dBuV/m)	Margin (dB)	Limit (dBuV/m)
2390	59.516	--	200	V	90	0.14	59.656	14.344	74
2390	--	38.910	200	V	90	0.14	39.050	14.950	54

**802.11n HT20-Channel 11**

Frequency (MHz)	Peak (dBuV/m)	Average (dBuV/m)	Height (cm)	Polarization	Azimuth (deg)	Duty cycle correction Factor(dB)	conclusion value (dBuV/m)	Margin (dB)	Limit (dBuV/m)
2483.5	60.658	--	200	V	90	0.14	60.798	13.202	74
2483.5	--	40.378	200	V	90	0.14	40.518	13.482	54

**802.11n HT40 -Channel 3**

Frequency (MHz)	Peak (dBuV/m)	Average (dBuV/m)	Height (cm)	Polarization	Azimuth (deg)	Duty cycle correction Factor(dB)	conclusion value (dBuV/m)	Margin (dB)	Limit (dBuV/m)
2390	57.573	--	150	V	46	0.15	57.723	16.277	74
2390	--	40.036	150	V	46	0.15	40.186	13.814	54

**802.11n HT40-Channel 9**

Frequency (MHz)	Peak (dBuV/m)	Average (dBuV/m)	Height (cm)	Polarization	Azimuth (deg)	Duty cycle correction Factor(dB)	conclusion value (dBuV/m)	Margin (dB)	Limit (dBuV/m)
2483.5	66.433	--	150	V	46	0.15	66.583	7.417	74
2483.5	--	42.376	150	V	46	0.15	42.526	11.474	54

**BLE Channel 0**

Frequency (MHz)	Peak (dBuV/m)	Average (dBuV/m)	Height (cm)	Polarization	Azimuth (deg)	Duty cycle correction Factor(dB)	conclusion value (dBuV/m)	Margin (dB)	Limit (dBuV/m)
2390	50.275	--	200.0	V	135	2.131	52.406	21.594	74
2390	--	36.048	200.0	V	135	2.131	38.179	15.821	54

**BLE Channel 39**

Frequency (MHz)	Peak (dBuV/m)	Average (dBuV/m)	Height (cm)	Polarization	Azimuth (deg)	Duty cycle correction Factor(dB)	conclusion value (dBuV/m)	Margin (dB)	Limit (dBuV/m)
2483.5	49.533	--	200.0	V	135	2.131	51.664	22.336	74
2483.5	--	36.132	200.0	V	135	2.131	38.263	15.737	54



## Result of RE

### Test result

Sweep the whole frequency band through the range from 9kHz to the 10th harmonic of the carrier, the Emissions in the frequency band 9kHz-30MHz and 18GHz-26.5GHz are more than 20dB below the limit are not reported.

The following graphs display the maximum values of horizontal and vertical by software. For above 1GHz, Blue trace uses the peak detection, Green trace uses the average detection.

During the test, the Radiates Emission from 9kHz to 1GHz was performed in all modes with all channels, BLE-Channel 39 are selected as the worst condition. The test data of the worst-case condition was recorded in this report.

### Continuous TX mode:

FCC RE 9K-90KHz AV

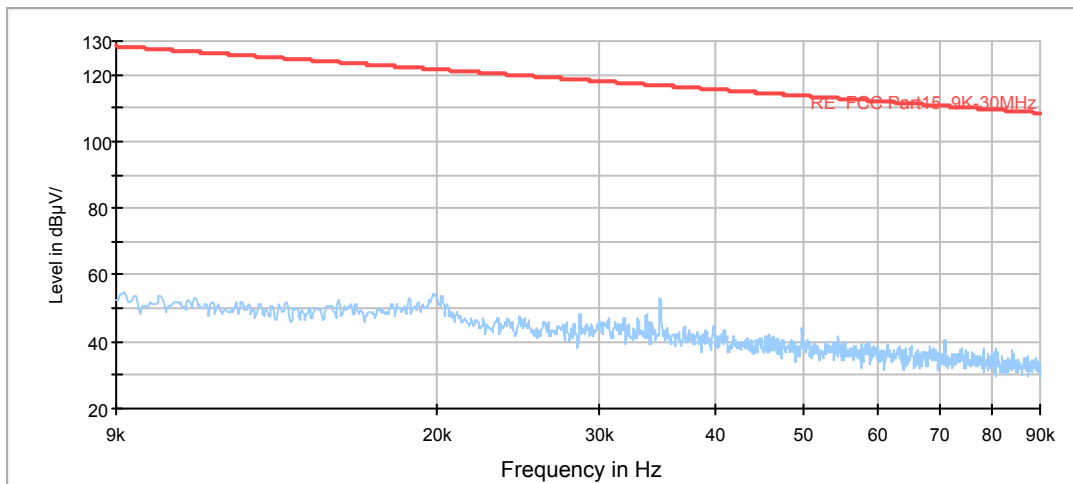

Radiates Emission from 9KHz to 90KHz

FCC RE 90K-110KHz QP

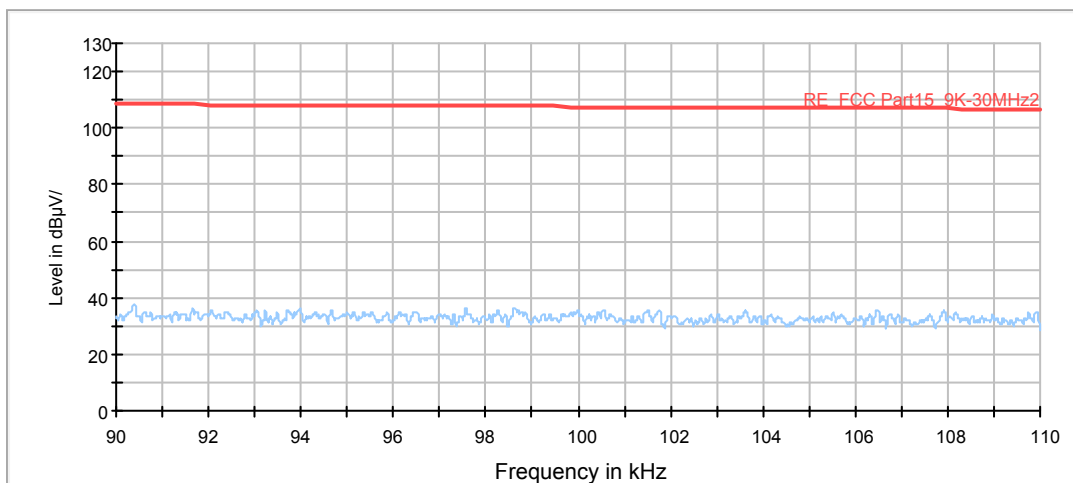

Radiates Emission from 90KHz to 110KHz

FCC RE 110K-490KHz AV

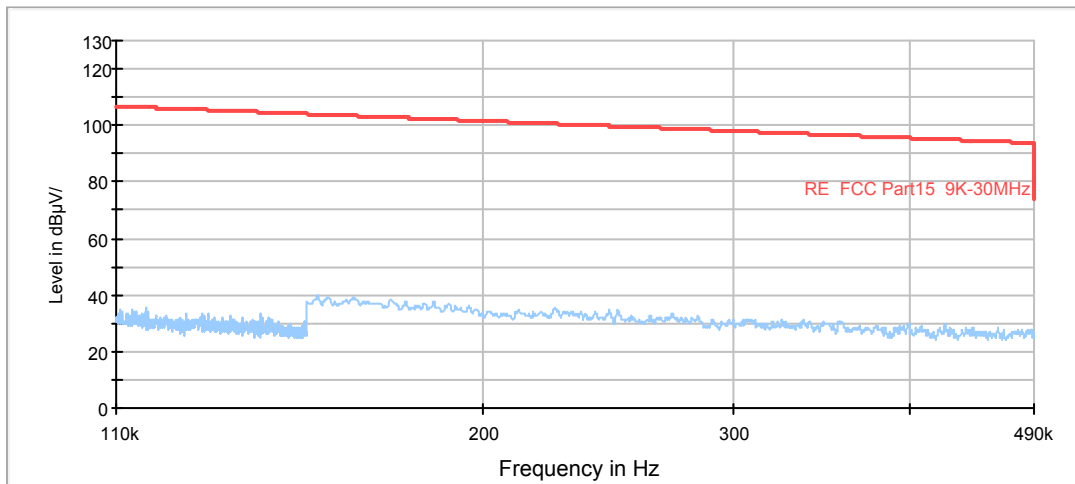

Radiates Emission from 110KHz to 490KHz

FCC RE 490K-30MHz QP

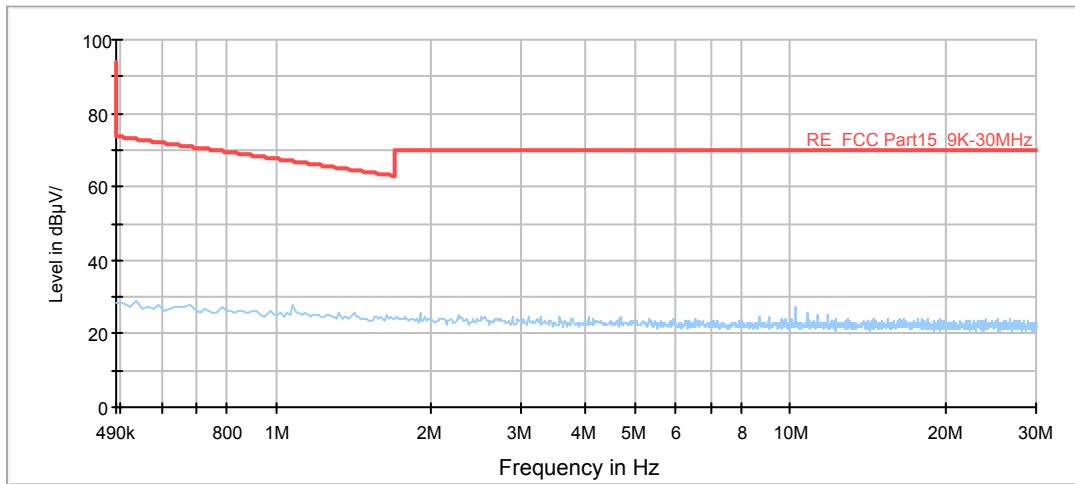

Radiates Emission from 490KHz to 30MHz

RE 0.03-1GHz QP Class B

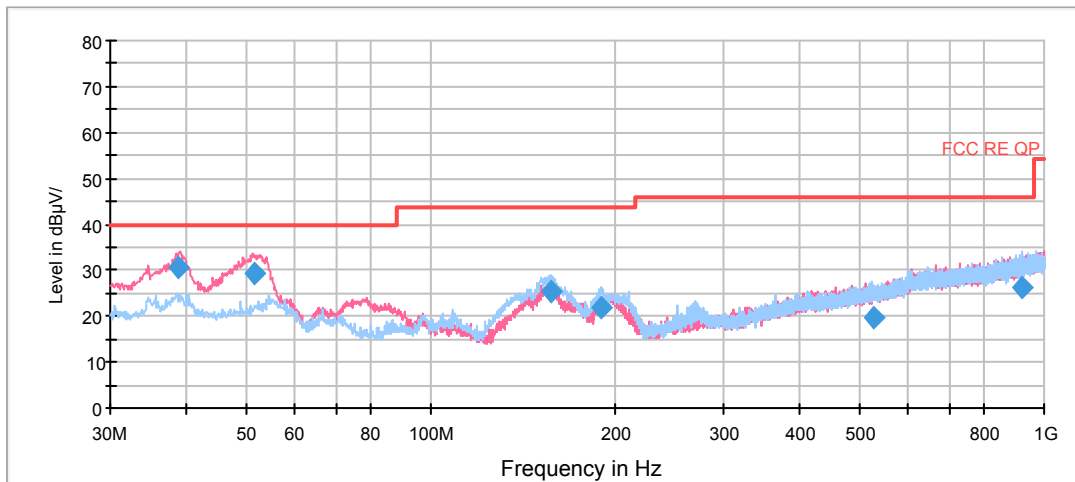

Radiates Emission from 30MHz to 1GHz

Frequency (MHz)	Quasi-Peak (dBuV/m)	Reading value (dBuV/m)	Height (cm)	Polarization	Azimuth (deg)	Correct Factor (dB)	Margin (dB)	Limit (dBuV/m)
38.892500	30.8	13.8	100.0	V	316.0	17.0	9.2	40.0
51.420000	29.3	15.5	100.0	V	83.0	13.8	10.7	40.0
157.063750	25.4	15.4	200.0	H	60.0	10.0	18.1	43.5
189.450000	21.9	10.6	100.0	H	301.0	11.3	21.6	43.5
525.787500	19.6	-2.0	200.0	H	34.0	21.6	26.4	46.0
923.976250	26.3	-0.4	100.0	H	78.0	26.7	19.7	46.0

Remark: 1. Quasi-Peak = Reading value + Correction factor

2. Correction Factor = Antenna Factor + Insertion loss(Cable loss-Amplifier gain)

3. Margin = Limit – Quasi-Peak

802.11b CH1

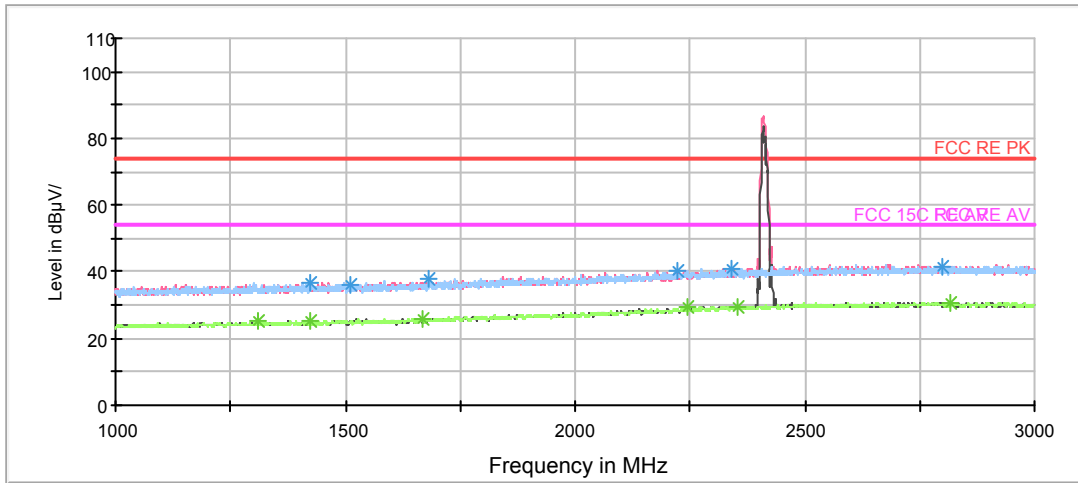

Note: The signal beyond the limit is carrier.  
Radiates Emission from 1GHz to 3GHz

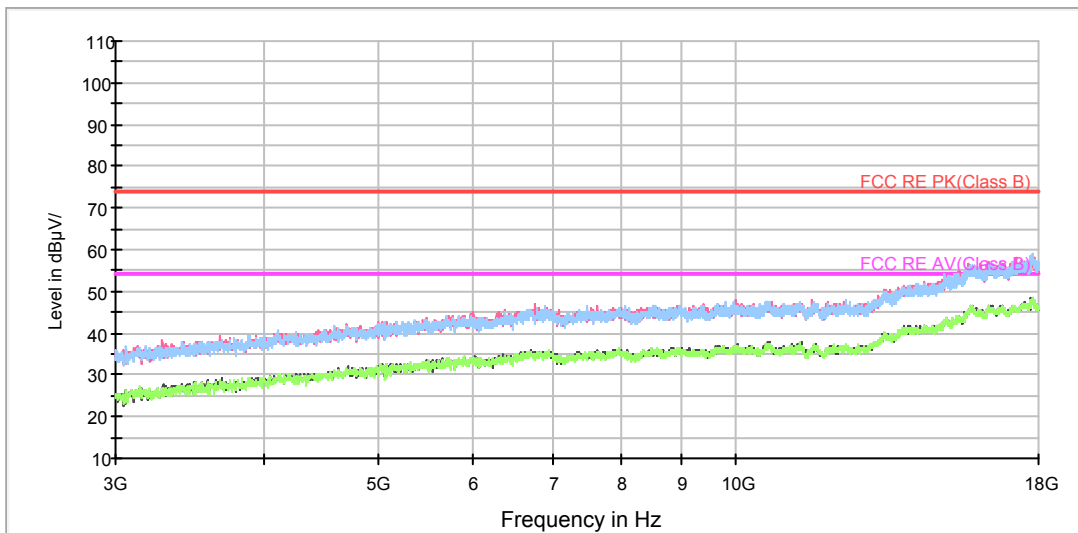

Radiates Emission from 3GHz to 18GHz



Frequency (MHz)	Peak (dBuV/m)	Height (cm)	Polarization	Azimuth (deg)	Reading value (dBuV/m)	Correct Factor (dB)	Margin (dB)	Limit (dBuV/m)
1422.000000	36.8	100.0	H	68.0	46.7	-9.9	37.2	74
1511.000000	36.3	200.0	H	356.0	45.8	-9.5	37.7	74
1681.000000	37.6	200.0	H	161.0	46.0	-8.4	36.4	74
2222.000000	40.1	200.0	V	0.0	45.6	-5.5	33.9	74
2340.000000	40.8	200.0	V	168.0	45.6	-4.8	33.2	74
2798.000000	41.3	100.0	H	0.0	45.1	-3.8	32.7	74

Remark: 1. Correction Factor = Antenna factor+ Insertion loss (cable loss - amplifier gain)

Frequency (MHz)	Average (dBuV/m)	Height (cm)	Polarization	Azimuth (deg)	Reading value (dBuV/m)	Correct Factor (dB)	Margin (dB)	Limit (dBuV/m)
1308.500000	25.2	100.0	V	212.0	35.7	-10.5	28.8	54
1425.500000	25.1	100.0	H	198.0	35.0	-9.9	28.9	54
1666.000000	25.9	200.0	V	135.0	34.4	-8.5	28.1	54
2245.000000	29.4	100.0	V	249.0	34.8	-5.4	24.6	54
2354.000000	29.7	100.0	V	238.0	34.5	-4.8	24.3	54
2816.000000	30.9	100.0	H	18.0	34.6	-3.7	23.1	54

Remark: 1. Correction Factor = Antenna factor+ Insertion loss (cable loss - amplifier gain)

802.11b CH6

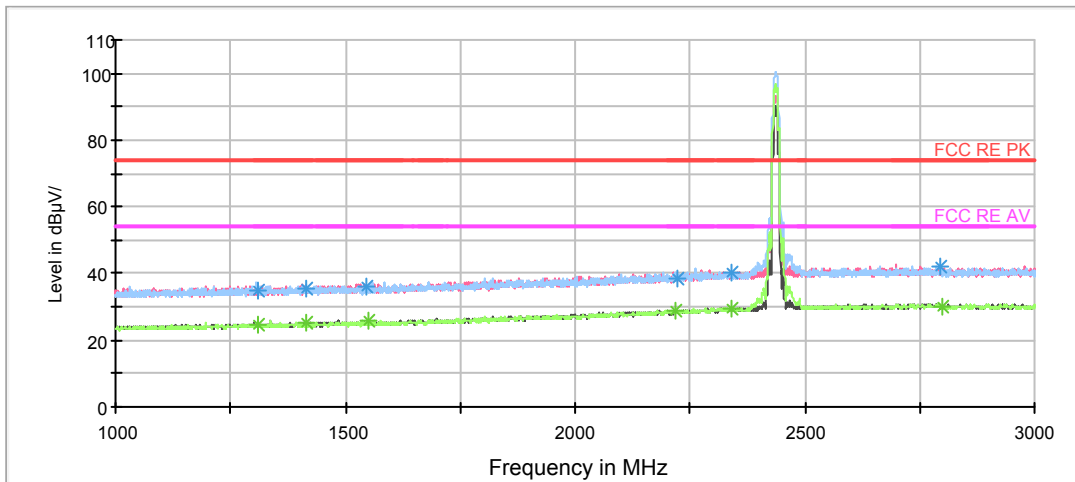

Note: The signal beyond the limit is carrier.  
Radiates Emission from 1GHz to 3GHz

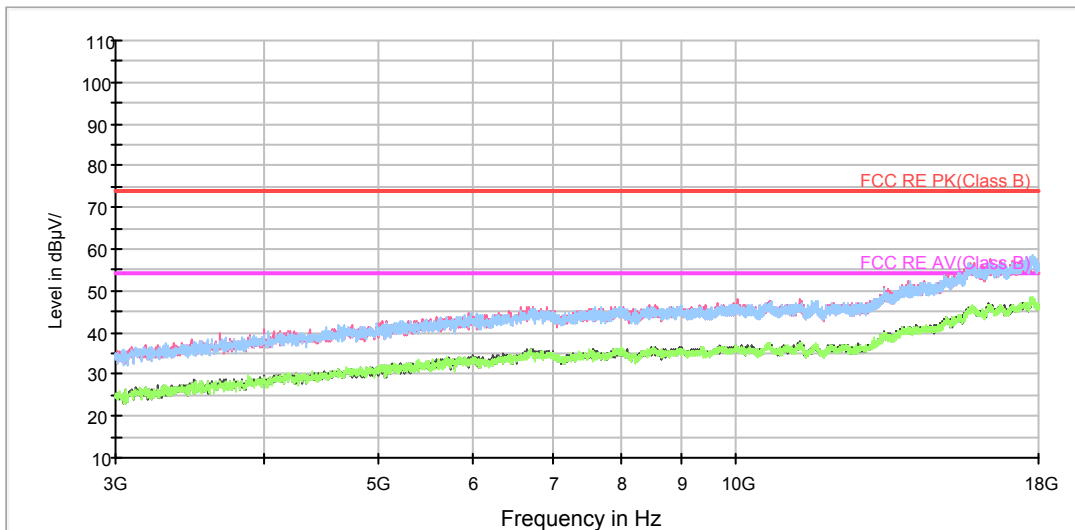

Radiates Emission from 3GHz to 18GHz



Frequency (MHz)	Peak (dBuV/m)	Height (cm)	Polarization	Azimuth (deg)	Reading value (dBuV/m)	Correct Factor (dB)	Margin (dB)	Limit (dBuV/m)
1309.000000	35.1	100.0	H	13.0	45.6	-10.5	38.9	74
1413.000000	35.6	100.0	V	315.0	45.6	-10.0	38.4	74
1546.000000	35.8	100.0	H	5.0	45.0	-9.2	38.2	74
2221.500000	38.7	200.0	V	60.0	44.2	-5.5	35.3	74
2341.000000	40.2	100.0	V	358.0	45.0	-4.8	33.8	74
2794.000000	42.4	200.0	H	187.0	46.2	-3.8	31.6	74

Remark: 1. Correction Factor = Antenna factor+ Insertion loss (cable loss - amplifier gain)

Frequency (MHz)	Average (dBuV/m)	Height (cm)	Polarization	Azimuth (deg)	Reading value (dBuV/m)	Correct Factor (dB)	Margin (dB)	Limit (dBuV/m)
1309.500000	24.7	200.0	H	286.0	35.2	-10.5	29.3	54
1413.500000	25.1	100.0	H	4.0	35.1	-10.0	28.9	54
1550.000000	25.6	100.0	H	79.0	34.8	-9.2	28.4	54
2220.500000	28.9	200.0	V	160.0	34.4	-5.5	25.1	54
2342.000000	29.7	100.0	V	174.0	34.5	-4.8	24.3	54
2800.500000	30.2	200.0	V	2.0	34.0	-3.8	23.8	54

Remark: 1. Correction Factor = Antenna factor+ Insertion loss (cable loss - amplifier gain)

802.11b CH11

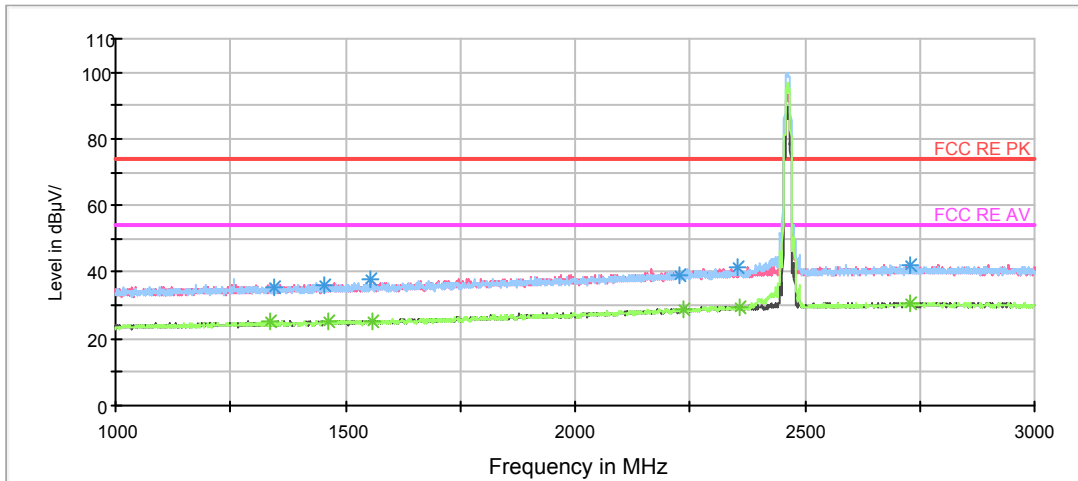

Note: The signal beyond the limit is carrier.  
Radiates Emission from 1GHz to 3GHz

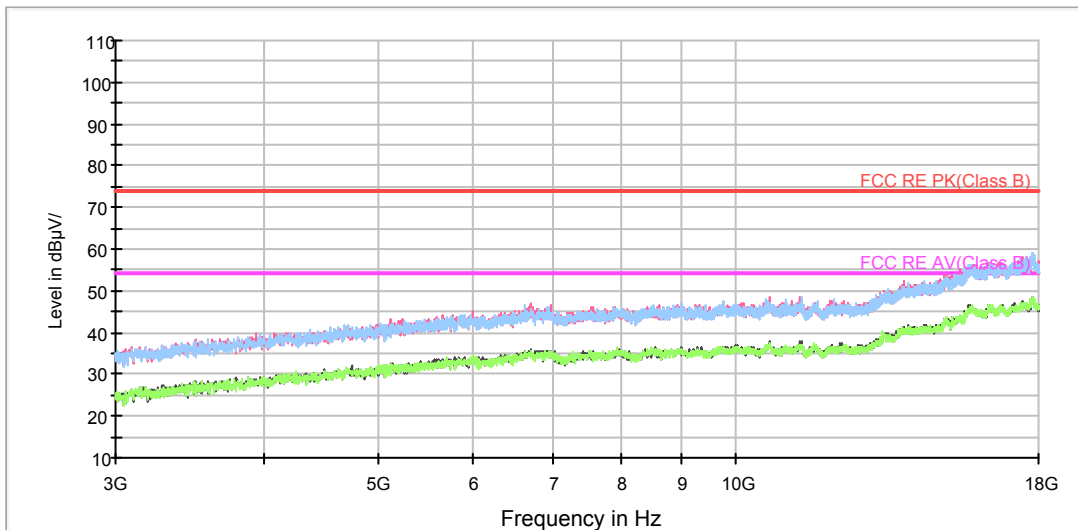

Radiates Emission from 3GHz to 18GHz





Frequency (MHz)	Peak (dBuV/m)	Height (cm)	Polarization	Azimuth (deg)	Reading value (dBuV/m)	Correct Factor (dB)	Margin (dB)	Limit (dBuV/m)
1345.500000	35.4	200.0	V	4.0	45.7	-10.3	38.6	74
1455.500000	36.2	200.0	H	321.0	45.9	-9.7	37.8	74
1556.500000	38.0	200.0	V	0.0	47.2	-9.2	36.0	74
2229.000000	39.1	200.0	V	87.0	44.5	-5.4	34.9	74
2355.000000	41.5	100.0	V	255.0	46.3	-4.8	32.5	74
2728.500000	42.4	200.0	V	281.0	46.3	-3.9	31.6	74

Remark: 1. Correction Factor = Antenna factor+ Insertion loss (cable loss - amplifier gain)

Frequency (MHz)	Average (dBuV/m)	Height (cm)	Polarization	Azimuth (deg)	Reading value (dBuV/m)	Correct Factor (dB)	Margin (dB)	Limit (dBuV/m)
1338.000000	25.4	100.0	H	267.0	35.7	-10.3	28.6	54
1461.000000	25.0	200.0	V	192.0	34.7	-9.7	29.0	54
1557.500000	25.4	100.0	V	0.0	34.6	-9.2	28.6	54
2236.500000	29.0	100.0	H	3.0	34.4	-5.4	25.0	54
2357.000000	29.7	200.0	V	1.0	34.5	-4.8	24.3	54
2730.500000	30.5	100.0	V	206.0	34.4	-3.9	23.5	54

Remark: 1. Correction Factor = Antenna factor+ Insertion loss (cable loss - amplifier gain)

802.11g CH1

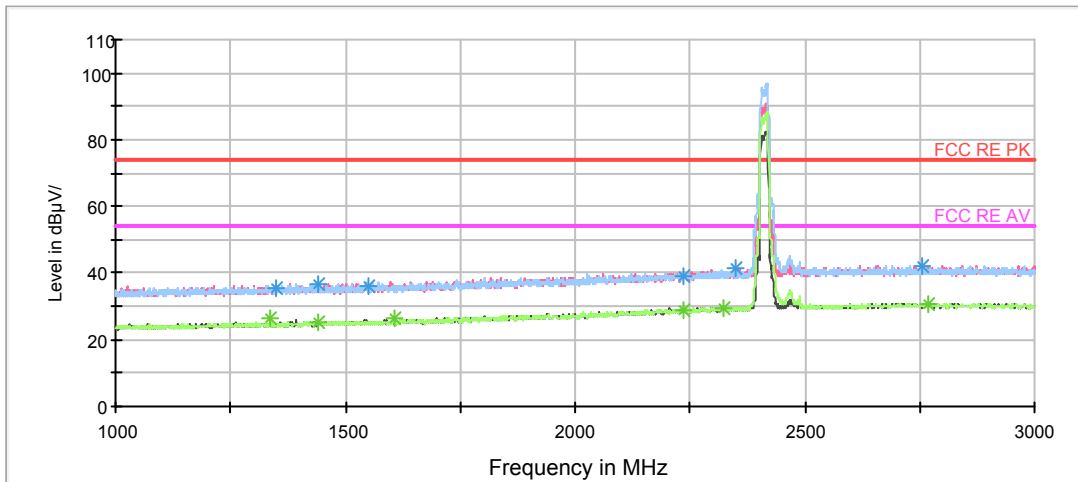

Note: The signal beyond the limit is carrier.  
Radiates Emission from 1GHz to 3GHz

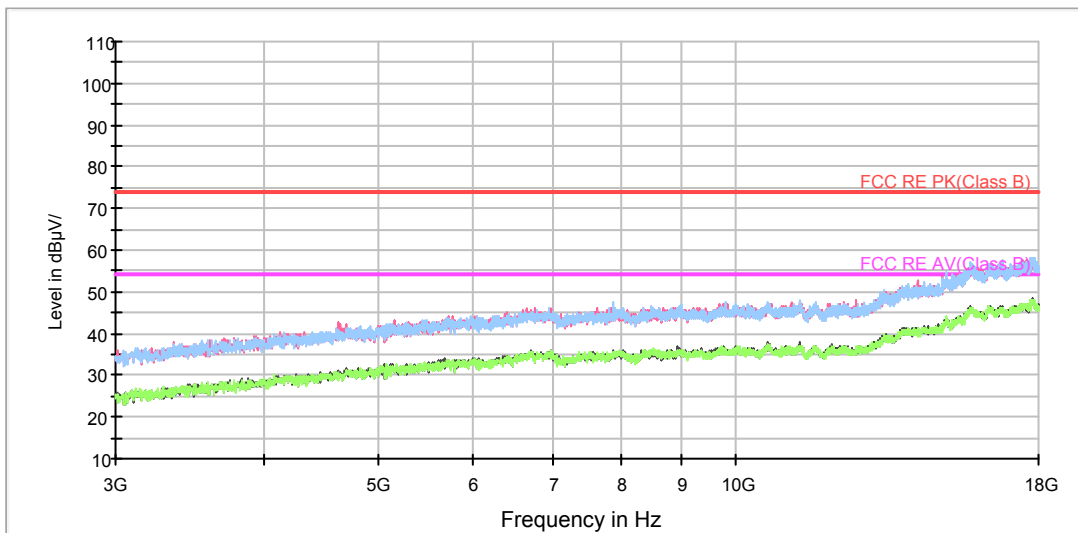

Radiates Emission from 3GHz to 18GHz



Frequency (MHz)	Peak (dBuV/m)	Height (cm)	Polarization	Azimuth (deg)	Reading value (dBuV/m)	Correct Factor (dB)	Margin (dB)	Limit (dBuV/m)
1350.000000	35.5	100.0	V	128.0	45.8	-10.3	38.5	74
1441.500000	36.6	200.0	H	288.0	46.4	-9.8	37.4	74
1549.500000	35.8	200.0	V	0.0	45.0	-9.2	38.2	74
2234.000000	39.1	100.0	V	357.0	44.5	-5.4	34.9	74
2350.500000	41.3	200.0	H	356.0	46.1	-4.8	32.7	74
2754.000000	42.3	100.0	H	168.0	46.1	-3.8	31.7	74

Remark: 1. Correction Factor = Antenna factor+ Insertion loss (cable loss - amplifier gain)

Frequency (MHz)	Average (dBuV/m)	Height (cm)	Polarization	Azimuth (deg)	Reading value (dBuV/m)	Correct Factor (dB)	Margin (dB)	Limit (dBuV/m)
1338.000000	26.7	200.0	H	359.0	37.0	-10.3	27.3	54
1442.000000	25.0	200.0	V	70.0	34.8	-9.8	29.0	54
1605.000000	26.4	100.0	V	171.0	35.3	-8.9	27.6	54
2235.000000	28.9	200.0	H	0.0	34.3	-5.4	25.1	54
2325.000000	29.3	200.0	H	251.0	34.2	-4.9	24.7	54
2770.000000	30.5	200.0	V	58.0	34.3	-3.8	23.5	54

Remark: 1. Correction Factor = Antenna factor+ Insertion loss (cable loss - amplifier gain)

802.11g CH6

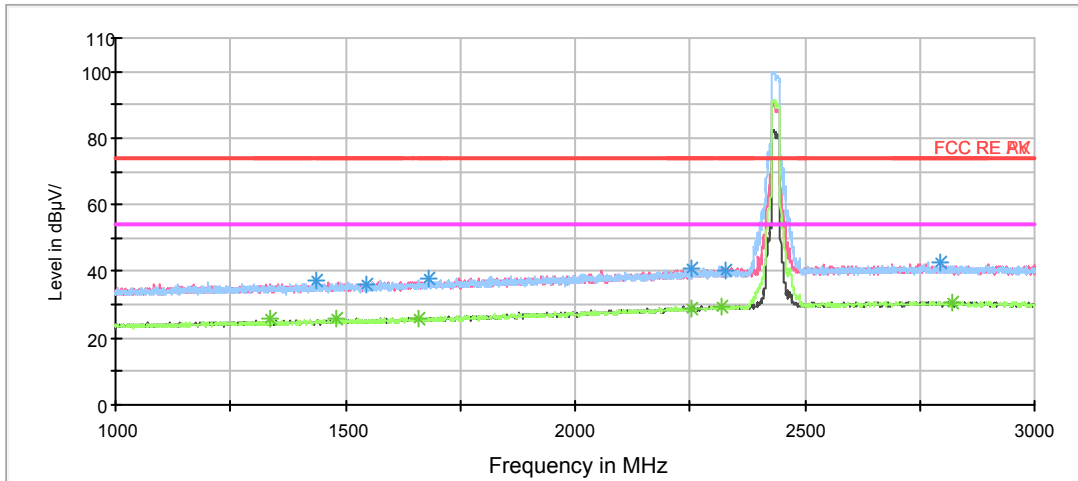

Note: The signal beyond the limit is carrier.  
Radiates Emission from 1GHz to 3GHz

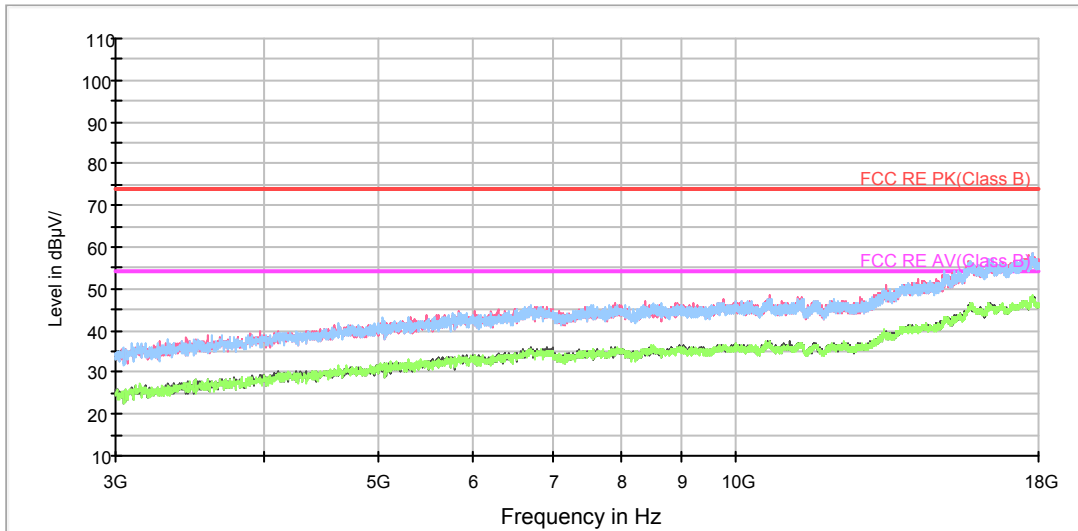

Radiates Emission from 3GHz to 18GHz



Frequency (MHz)	Peak (dBuV/m)	Height (cm)	Polarization	Azimuth (deg)	Reading value (dBuV/m)	Correct Factor (dB)	Margin (dB)	Limit (dBuV/m)
1438.500000	37.1	200.0	V	275.0	46.9	-9.8	36.9	74
1547.000000	36.0	200.0	H	357.0	45.2	-9.2	38.0	74
1681.000000	37.9	100.0	H	216.0	46.3	-8.4	36.1	74
2255.000000	40.8	100.0	H	128.0	46.1	-5.3	33.2	74
2325.500000	40.4	200.0	H	347.0	45.3	-4.9	33.6	74
2795.000000	42.8	100.0	H	242.0	46.6	-3.8	31.2	74

Remark: 1. Correction Factor = Antenna factor+ Insertion loss (cable loss - amplifier gain)

Frequency (MHz)	Average (dBuV/m)	Height (cm)	Polarization	Azimuth (deg)	Reading value (dBuV/m)	Correct Factor (dB)	Margin (dB)	Limit (dBuV/m)
1338.000000	25.8	100.0	H	216.0	36.1	-10.3	28.2	54
1482.500000	25.7	200.0	V	262.0	35.3	-9.6	28.3	54
1659.500000	25.7	100.0	V	0.0	34.3	-8.6	28.3	54
2254.500000	29.1	100.0	H	80.0	34.4	-5.3	24.9	54
2317.500000	29.4	200.0	V	8.0	34.4	-5.0	24.6	54
2822.500000	30.9	200.0	V	20.0	34.6	-3.7	23.1	54

Remark: 1. Correction Factor = Antenna factor+ Insertion loss (cable loss - amplifier gain)



802.11g CH11

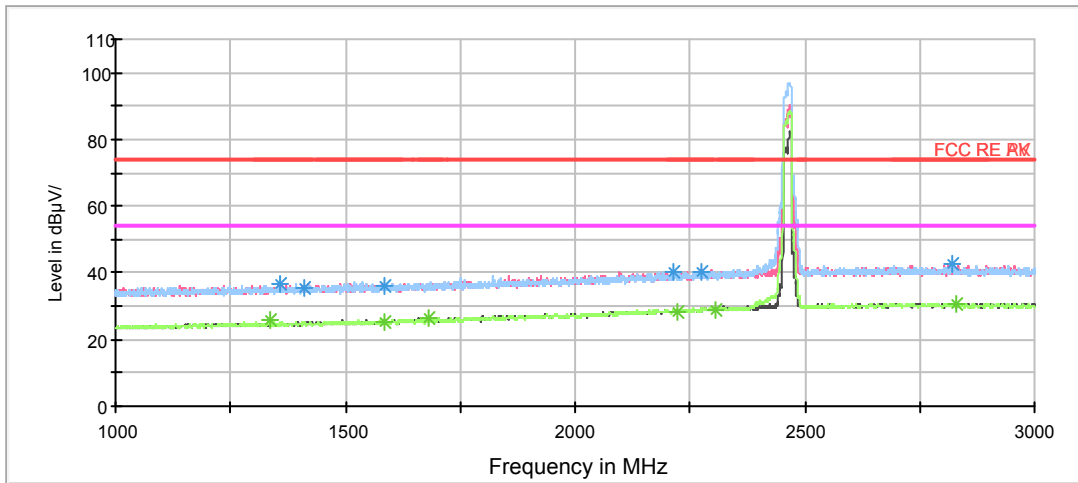

Note: The signal beyond the limit is carrier.  
Radiates Emission from 1GHz to 3GHz

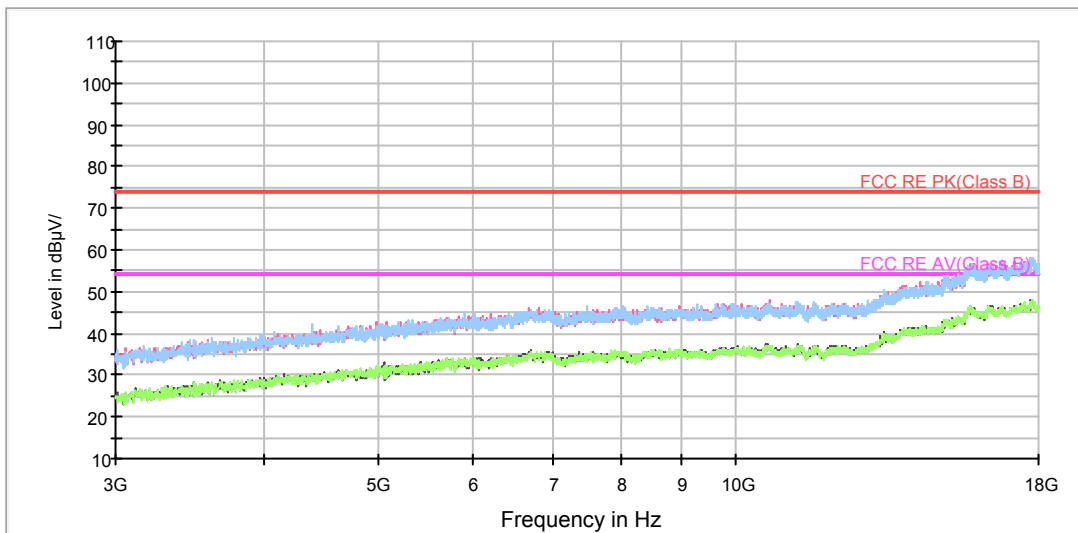

Radiates Emission from 3GHz to 18GHz



Frequency (MHz)	Peak (dBuV/m)	Height (cm)	Polarization	Azimuth (deg)	Reading value (dBuV/m)	Correct Factor (dB)	Margin (dB)	Limit (dBuV/m)
1358.000000	37.0	200.0	V	110.0	47.3	-10.3	37.0	74
1409.500000	35.5	100.0	V	292.0	45.5	-10.0	38.5	74
1585.000000	36.2	100.0	V	347.0	45.2	-9.0	37.8	74
2213.500000	40.1	100.0	H	1.0	45.6	-5.5	33.9	74
2276.000000	40.4	200.0	H	0.0	45.5	-5.1	33.6	74
2823.000000	42.5	200.0	H	223.0	46.2	-3.7	31.5	74

Remark: 1. Correction Factor = Antenna factor+ Insertion loss (cable loss - amplifier gain)

Frequency (MHz)	Average (dBuV/m)	Height (cm)	Polarization	Azimuth (deg)	Reading value (dBuV/m)	Correct Factor (dB)	Margin (dB)	Limit (dBuV/m)
1338.000000	25.9	100.0	H	263.0	36.2	-10.3	28.1	54
1585.500000	25.0	100.0	V	357.0	34.0	-9.0	29.0	54
1680.500000	26.4	100.0	V	318.0	34.8	-8.4	27.6	54
2223.500000	28.5	100.0	H	13.0	34.0	-5.5	25.5	54
2303.500000	28.8	100.0	V	152.0	33.8	-5.0	25.2	54
2829.000000	30.8	200.0	V	2.0	34.5	-3.7	23.2	54

Remark: 1. Correction Factor = Antenna factor+ Insertion loss (cable loss - amplifier gain)

802.11n (HT20) CH1

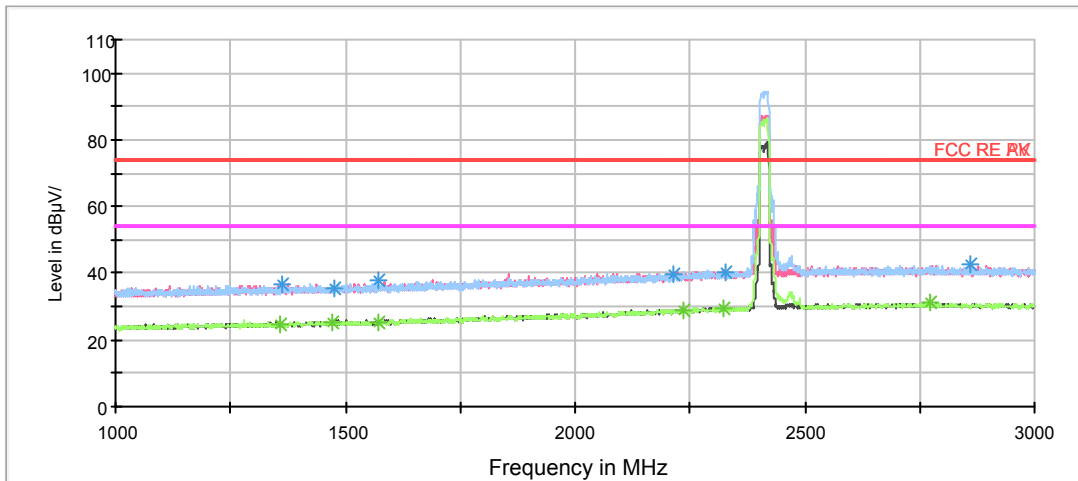

Note: The signal beyond the limit is carrier.  
Radiates Emission from 1GHz to 3GHz

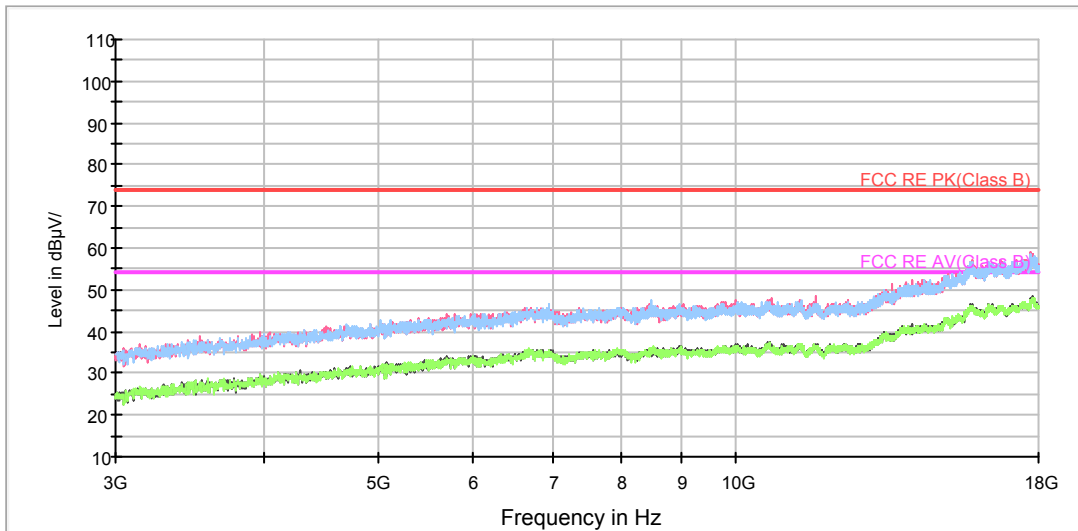

Radiates Emission from 3GHz to 18GHz





Frequency (MHz)	Peak (dBuV/m)	Height (cm)	Polarization	Azimuth (deg)	Reading value (dBuV/m)	Correct Factor (dB)	Margin (dB)	Limit (dBuV/m)
1364.500000	36.8	100.0	V	301.0	47.0	-10.2	37.2	74
1477.500000	35.6	100.0	V	35.0	45.2	-9.6	38.4	74
1571.500000	37.7	200.0	H	36.0	46.8	-9.1	36.3	74
2216.000000	39.9	100.0	V	354.0	45.4	-5.5	34.1	74
2329.500000	40.4	200.0	V	72.0	45.3	-4.9	33.6	74
2861.000000	42.4	100.0	V	325.0	46.1	-3.7	31.6	74

Remark: 1. Correction Factor = Antenna factor+ Insertion loss (cable loss - amplifier gain)

Frequency (MHz)	Average (dBuV/m)	Height (cm)	Polarization	Azimuth (deg)	Reading value (dBuV/m)	Correct Factor (dB)	Margin (dB)	Limit (dBuV/m)
1356.000000	24.5	200.0	V	109.0	34.8	-10.3	29.5	54
1470.000000	25.3	200.0	V	60.0	35.0	-9.7	28.7	54
1572.000000	25.4	200.0	V	17.0	34.5	-9.1	28.6	54
2234.000000	29.1	200.0	V	38.0	34.5	-5.4	24.9	54
2325.000000	29.6	100.0	V	238.0	34.5	-4.9	24.4	54
2774.500000	31.0	200.0	V	7.0	34.8	-3.8	23.0	54

Remark: 1. Correction Factor = Antenna factor+ Insertion loss (cable loss - amplifier gain)



802.11n (HT20) CH6

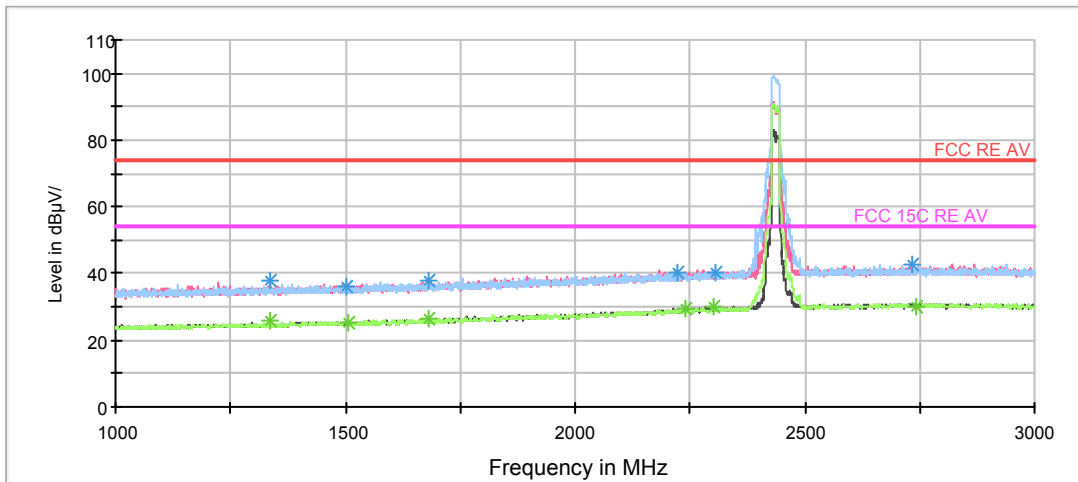

Note: The signal beyond the limit is carrier.  
Radiates Emission from 1GHz to 3GHz

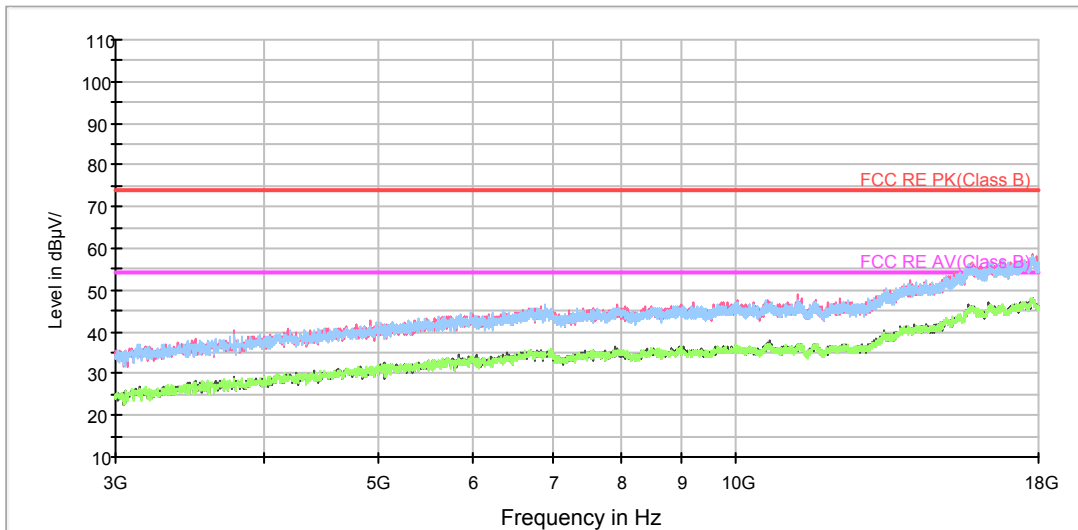

Radiates Emission from 3GHz to 18GHz



Frequency (MHz)	Peak (dBuV/m)	Height (cm)	Polarization	Azimuth (deg)	Reading value (dBuV/m)	Correct Factor (dB)	Margin (dB)	Limit (dBuV/m)
1337.500000	37.8	200.0	V	197.0	48.1	-10.3	36.2	74
1502.500000	36.3	200.0	H	26.0	45.8	-9.5	37.7	74
1680.500000	37.9	100.0	H	357.0	46.3	-8.4	36.1	74
2222.000000	40.4	100.0	V	354.0	45.9	-5.5	33.6	74
2304.000000	40.3	100.0	H	162.0	45.3	-5.0	33.7	74
2732.000000	42.7	200.0	H	169.0	46.6	-3.9	31.3	74

Remark: 1. Correction Factor = Antenna factor+ Insertion loss (cable loss - amplifier gain)

Frequency (MHz)	Average (dBuV/m)	Height (cm)	Polarization	Azimuth (deg)	Reading value (dBuV/m)	Correct Factor (dB)	Margin (dB)	Limit (dBuV/m)
1337.500000	25.6	100.0	H	263.0	35.9	-10.3	28.4	54
1505.000000	25.4	100.0	V	0.0	34.9	-9.5	28.6	54
1680.000000	26.3	100.0	H	8.0	34.7	-8.4	27.7	54
2238.000000	29.2	100.0	V	0.0	34.6	-5.4	24.8	54
2301.000000	29.9	200.0	V	197.0	34.9	-5.0	24.1	54
2743.000000	30.3	200.0	V	10.0	34.2	-3.9	23.7	54

Remark: 1. Correction Factor = Antenna factor+ Insertion loss (cable loss - amplifier gain)

802.11n (HT20) CH11

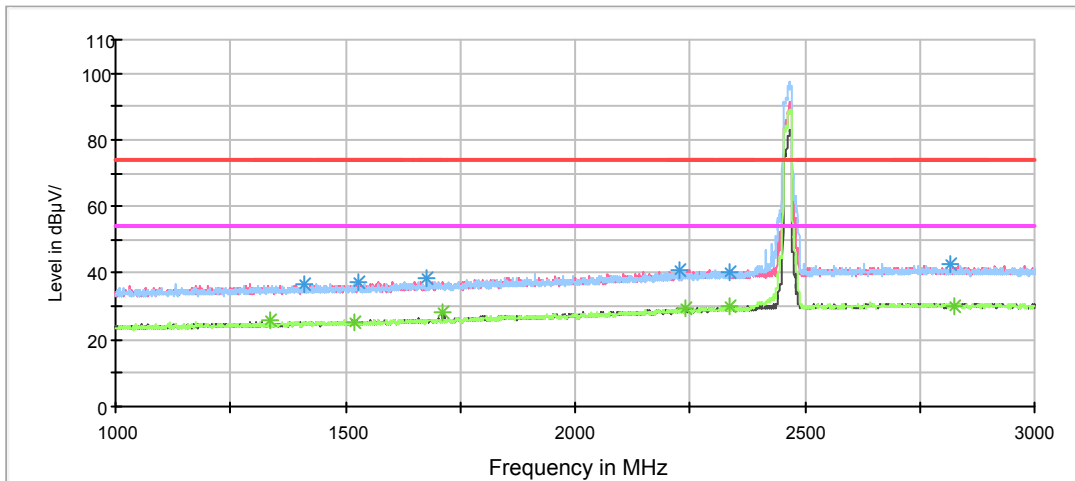

Note: The signal beyond the limit is carrier.  
Radiates Emission from 1GHz to 3GHz

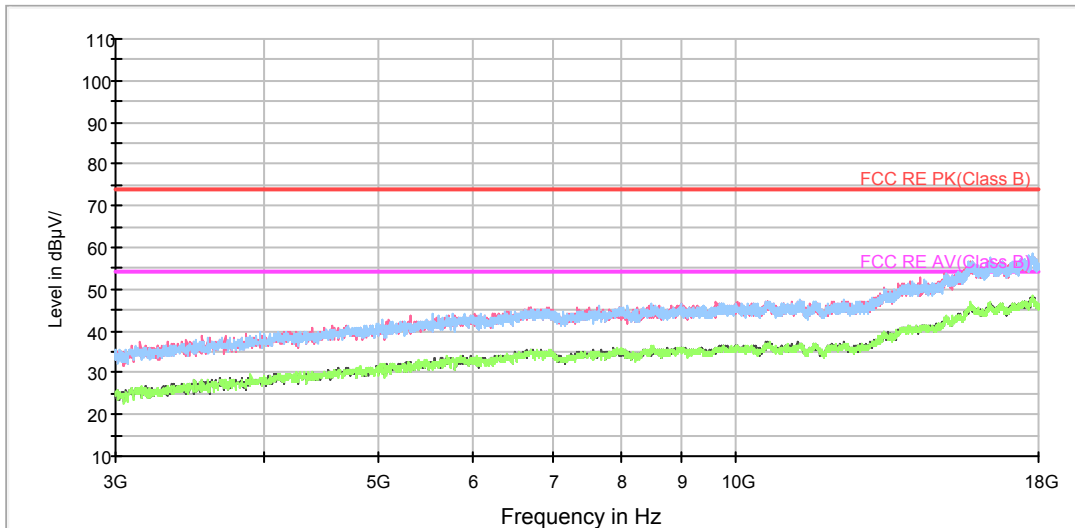

Radiates Emission from 3GHz to 18GHz



Frequency (MHz)	Peak (dBuV/m)	Height (cm)	Polarization	Azimuth (deg)	Reading value (dBuV/m)	Correct Factor (dB)	Margin (dB)	Limit (dBuV/m)
1412.000000	36.7	100.0	H	288.0	46.7	-10.0	37.3	74
1529.000000	37.5	200.0	H	309.0	46.8	-9.3	36.5	74
1678.500000	38.3	100.0	H	0.0	46.7	-8.4	35.7	74
2229.000000	41.1	100.0	V	293.0	46.5	-5.4	32.9	74
2337.000000	40.3	200.0	V	41.0	45.1	-4.8	33.7	74
2815.000000	42.6	200.0	H	322.0	46.3	-3.7	31.4	74

Remark: 1. Correction Factor = Antenna factor+ Insertion loss (cable loss - amplifier gain)

Frequency (MHz)	Average (dBuV/m)	Height (cm)	Polarization	Azimuth (deg)	Reading value (dBuV/m)	Correct Factor (dB)	Margin (dB)	Limit (dBuV/m)
1338.000000	25.6	100.0	V	257.0	35.9	-10.3	28.4	54
1520.500000	25.2	200.0	V	91.0	34.6	-9.4	28.8	54
1712.500000	28.2	100.0	V	220.0	36.5	-8.3	25.8	54
2240.000000	29.2	100.0	H	235.0	34.6	-5.4	24.8	54
2337.500000	29.8	200.0	H	356.0	34.6	-4.8	24.2	54
2823.500000	30.2	100.0	V	359.0	33.9	-3.7	23.8	54

Remark: 1. Correction Factor = Antenna factor+ Insertion loss (cable loss - amplifier gain)

802.11n (HT40) CH3

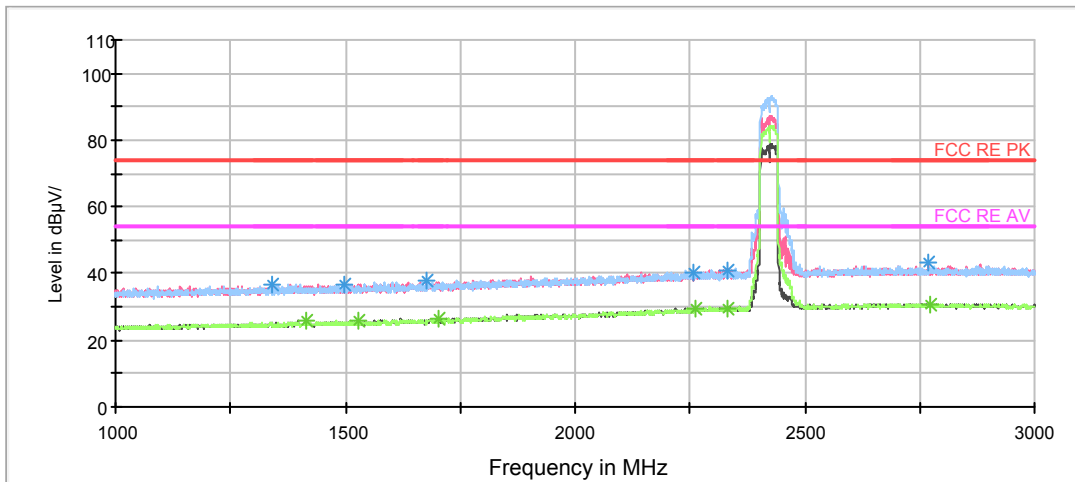

Note: The signal beyond the limit is carrier.  
Radiates Emission from 1GHz to 3GHz

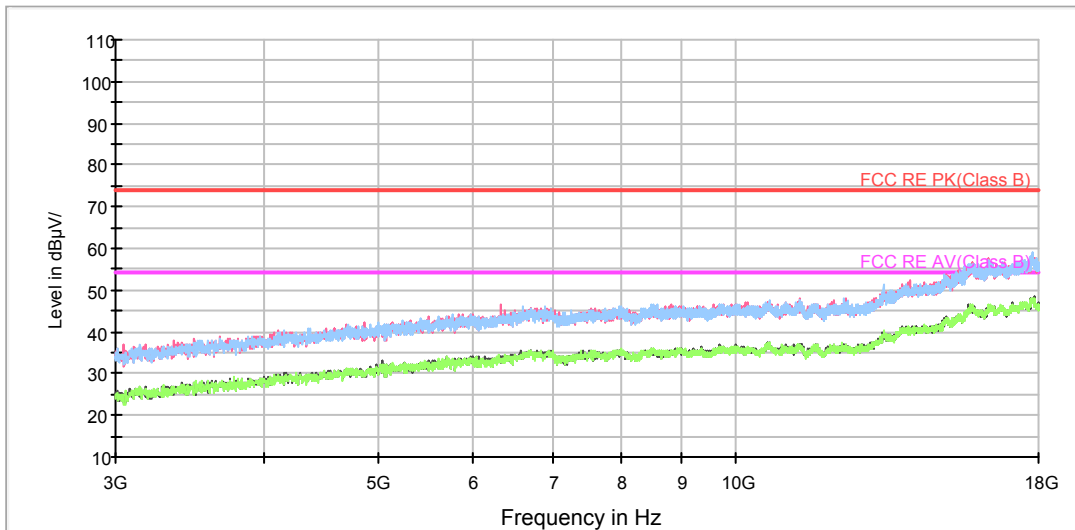

Radiates Emission from 3GHz to 18GHz



Frequency (MHz)	Peak (dBuV/m)	Height (cm)	Polarization	Azimuth (deg)	Reading value (dBuV/m)	Correct Factor (dB)	Margin (dB)	Limit (dBuV/m)
1338.500000	36.9	100.0	V	299.0	47.2	-10.3	37.1	74
1498.500000	36.6	100.0	H	188.0	46.1	-9.5	37.4	74
1679.000000	37.6	200.0	H	346.0	46.0	-8.4	36.4	74
2257.000000	40.4	200.0	H	181.0	45.7	-5.3	33.6	74
2330.000000	41.0	200.0	V	28.0	45.9	-4.9	33.0	74
2768.000000	43.4	200.0	V	266.0	47.2	-3.8	30.6	74

Remark: 1. Correction Factor = Antenna factor+ Insertion loss (cable loss - amplifier gain)

Frequency (MHz)	Average (dBuV/m)	Height (cm)	Polarization	Azimuth (deg)	Reading value (dBuV/m)	Correct Factor (dB)	Margin (dB)	Limit (dBuV/m)
1414.500000	25.8	200.0	H	0.0	35.7	-9.9	28.2	54
1527.000000	25.9	100.0	V	335.0	35.3	-9.4	28.1	54
1703.500000	26.5	100.0	H	62.0	34.8	-8.3	27.5	54
2262.000000	29.3	100.0	H	13.0	34.6	-5.3	24.7	54
2331.000000	29.5	200.0	V	2.0	34.4	-4.9	24.5	54
2774.500000	30.4	100.0	V	335.0	34.2	-3.8	23.6	54

Remark: 1. Correction Factor = Antenna factor+ Insertion loss (cable loss - amplifier gain)

802.11n (HT40) CH6

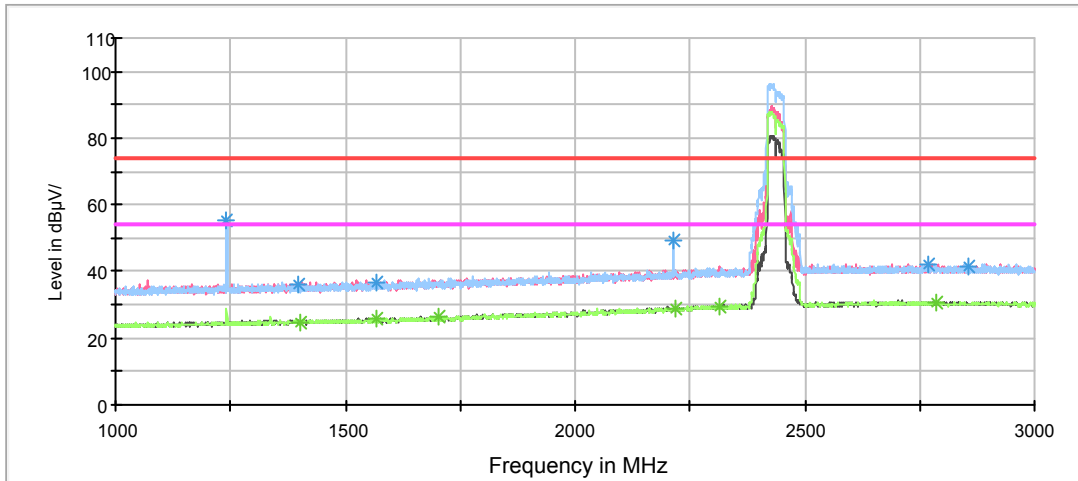

Note: The signal beyond the limit is carrier.  
Radiates Emission from 1GHz to 3GHz

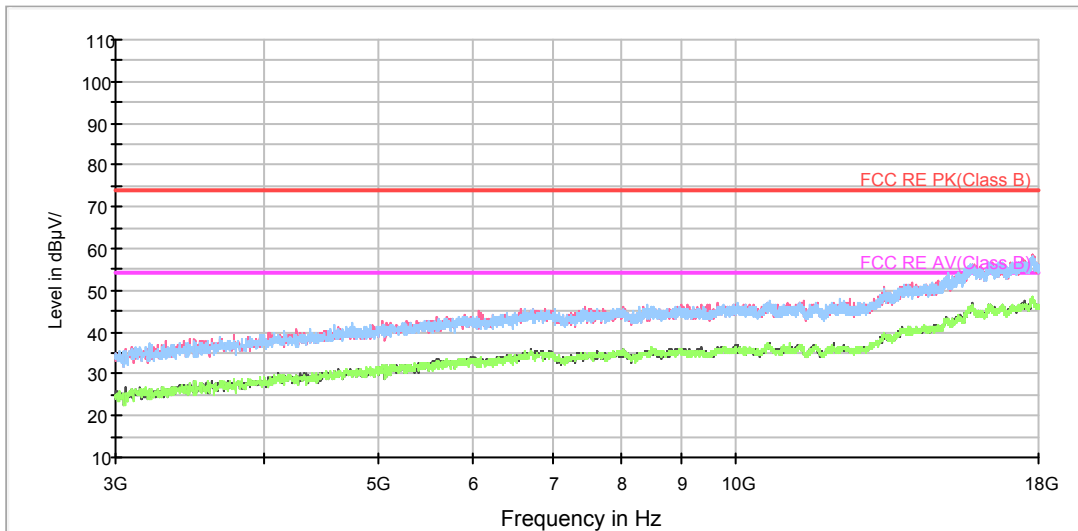

Radiates Emission from 3GHz to 18GHz





Frequency (MHz)	Peak (dBuV/m)	Height (cm)	Polarization	Azimuth (deg)	Reading value (dBuV/m)	Correct Factor (dB)	Margin (dB)	Limit (dBuV/m)
1242.000000	55.1	200.0	H	297.0	65.9	-10.8	18.9	74
1398.000000	36.0	100.0	V	263.0	46.0	-10.0	38.0	74
1569.000000	36.7	100.0	V	76.0	45.8	-9.1	37.3	74
2214.000000	49.0	200.0	H	185.0	54.5	-5.5	25.0	74
2769.500000	42.3	100.0	V	63.0	46.1	-3.8	31.7	74
2854.500000	41.2	200.0	H	260.0	44.9	-3.7	32.8	74

Remark: 1. Correction Factor = Antenna factor+ Insertion loss (cable loss - amplifier gain)

Frequency (MHz)	Average (dBuV/m)	Height (cm)	Polarization	Azimuth (deg)	Reading value (dBuV/m)	Correct Factor (dB)	Margin (dB)	Limit (dBuV/m)
1401.500000	24.9	200.0	V	5.0	34.9	-10.0	29.1	54
1569.000000	25.8	100.0	V	76.0	34.9	-9.1	28.2	54
1704.000000	26.3	200.0	V	81.0	34.6	-8.3	27.7	54
2218.000000	28.9	100.0	V	250.0	34.4	-5.5	25.1	54
2314.500000	29.3	200.0	V	131.0	34.3	-5.0	24.7	54
2784.000000	30.6	200.0	V	32.0	34.4	-3.8	23.4	54

Remark: 1. Correction Factor = Antenna factor+ Insertion loss (cable loss - amplifier gain)



802.11n (HT40) CH9

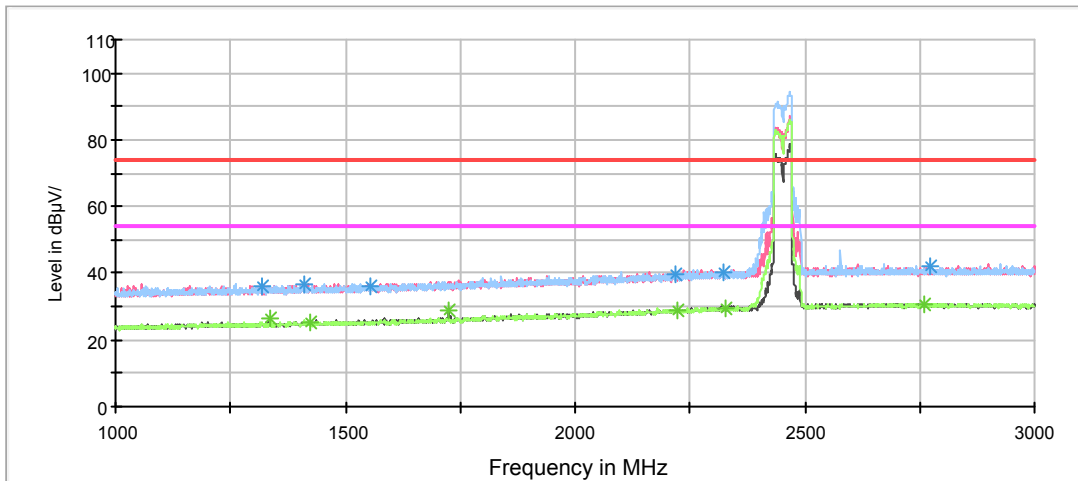

Note: The signal beyond the limit is carrier.  
Radiates Emission from 1GHz to 3GHz

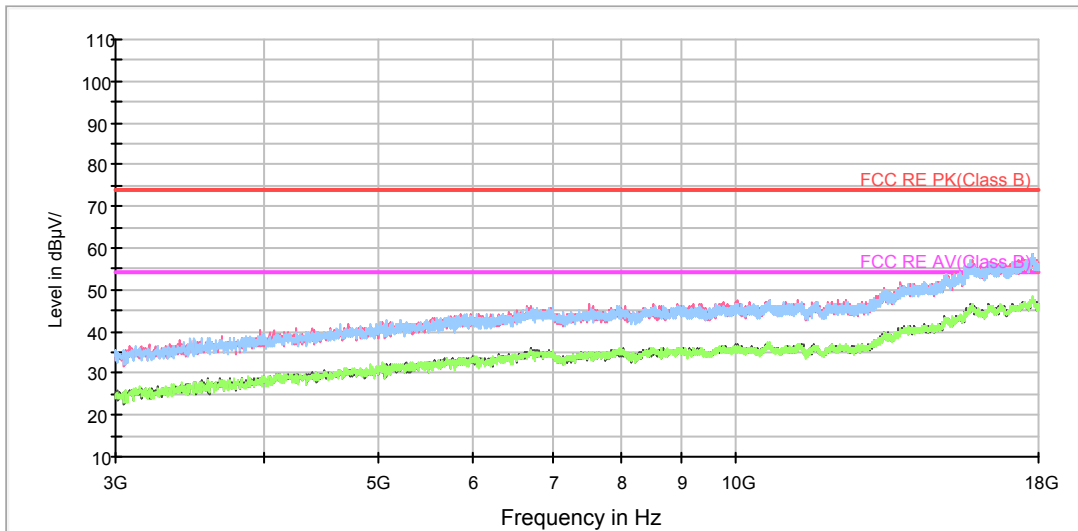

Radiates Emission from 3GHz to 18GHz



Frequency (MHz)	Peak (dBuV/m)	Height (cm)	Polarization	Azimuth (deg)	Reading value (dBuV/m)	Correct Factor (dB)	Margin (dB)	Limit (dBuV/m)
1317.500000	36.0	200.0	V	180.0	46.4	-10.4	38.0	74
1409.500000	36.4	100.0	H	27.0	46.4	-10.0	37.6	74
1553.000000	35.8	200.0	H	68.0	45.0	-9.2	38.2	74
2220.000000	39.5	100.0	V	42.0	45.0	-5.5	34.5	74
2324.000000	40.4	100.0	H	1.0	45.3	-4.9	33.6	74
2773.500000	42.0	100.0	V	149.0	45.8	-3.8	32.0	74

Remark: 1. Correction Factor = Antenna factor+ Insertion loss (cable loss - amplifier gain)

Frequency (MHz)	Average (dBuV/m)	Height (cm)	Polarization	Azimuth (deg)	Reading value (dBuV/m)	Correct Factor (dB)	Margin (dB)	Limit (dBuV/m)
1338.000000	26.3	100.0	H	266.0	36.6	-10.3	27.7	54
1422.000000	25.3	100.0	V	333.0	35.2	-9.9	28.7	54
1725.000000	29.1	100.0	V	60.0	37.3	-8.2	24.9	54
2224.500000	29.0	100.0	H	4.0	34.5	-5.5	25.0	54
2329.000000	29.6	100.0	H	162.0	34.5	-4.9	24.4	54
2760.000000	31.0	200.0	V	117.0	34.8	-3.8	23.0	54

Remark: 1. Correction Factor = Antenna factor+ Insertion loss (cable loss - amplifier gain)

**BLE-Channel 0**

FCC RE 1G-3GHz PK+AV Class B

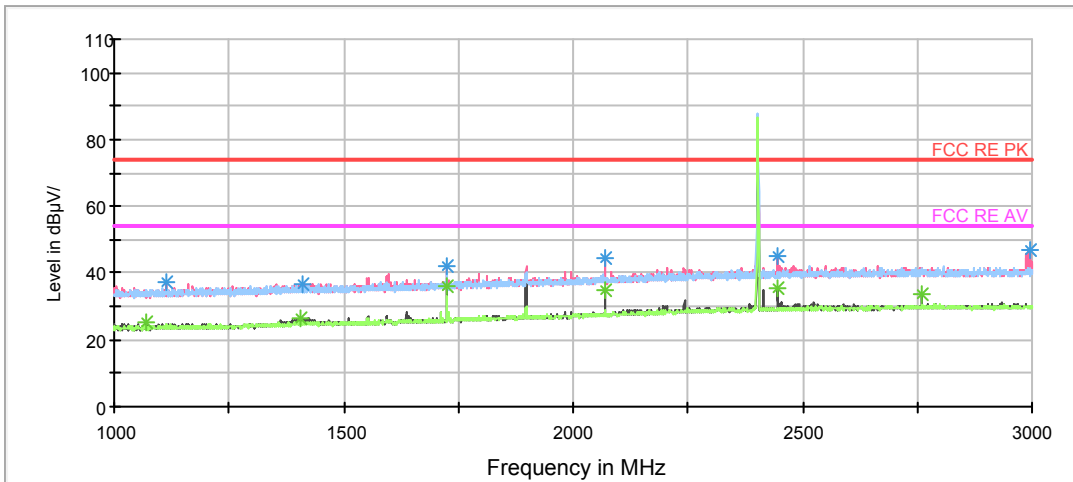

Note: The signal beyond the limit is carrier.  
Radiates Emission from 1GHz to 3GHz

RE 3-18GHz PK+AV

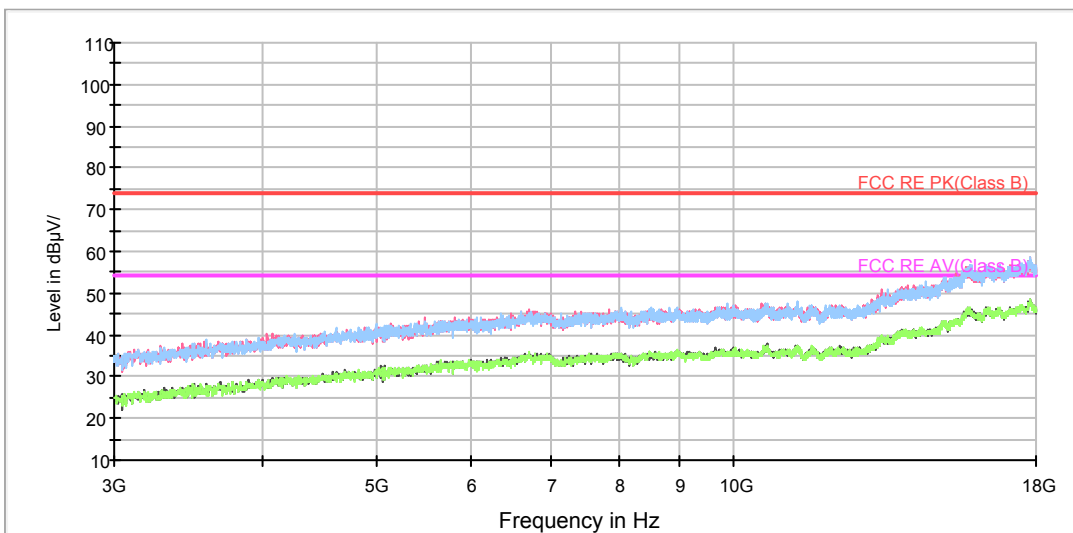

Radiates Emission from 3GHz to 18GHz



Frequency (MHz)	Peak (dBuV/m)	Height (cm)	Polarization	Azimuth (deg)	Reading value (dBuV/m)	Correct Factor (dB)	Margin (dB)	Limit (dBuV/m)
1114.500000	37.1	100.0	V	104.0	48.3	-11.2	36.9	74
1408.500000	36.9	100.0	V	164.0	46.9	-10.0	37.1	74
1725.000000	42.0	100.0	V	95.0	50.2	-8.2	32.0	74
2070.000000	44.4	100.0	V	260.0	50.8	-6.4	29.6	74
2446.500000	45.1	100.0	V	104.0	49.5	-4.4	28.9	74
2994.500000	46.6	200.0	V	45.0	50.2	-3.6	27.4	74

Remark: 1. Correction Factor = Antenna factor+ Insertion loss (cable loss - amplifier gain)

Frequency (MHz)	Average (dBuV/m)	Height (cm)	Polarization	Azimuth (deg)	Reading value (dBuV/m)	Correct Factor (dB)	Margin (dB)	Limit (dBuV/m)
1071.000000	25.1	100.0	V	114.0	36.4	-11.3	28.9	54
1406.500000	26.5	100.0	V	0.0	36.5	-10.0	27.5	54
1725.000000	36.0	100.0	V	95.0	44.2	-8.2	18.0	54
2070.000000	35.2	200.0	V	307.0	41.6	-6.4	18.8	54
2446.500000	35.5	100.0	V	104.0	39.9	-4.4	18.5	54
2760.000000	33.5	200.0	V	94.0	37.3	-3.8	20.5	54

Remark: 1. Correction Factor = Antenna factor+ Insertion loss (cable loss - amplifier gain)

**BLE-Channel 19**

FCC RE 1G-3GHz PK+AV Class B

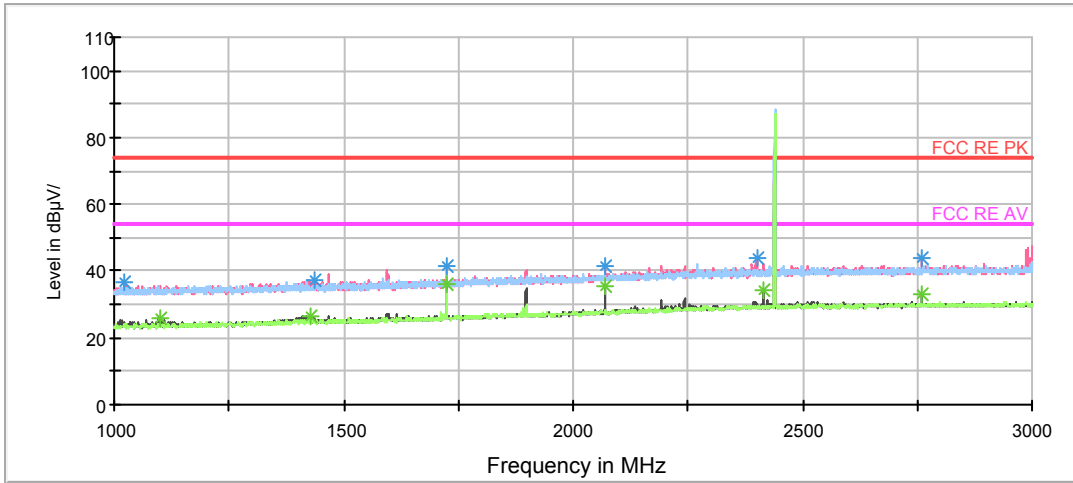

Note: The signal beyond the limit is carrier.  
Radiates Emission from 1GHz to 3GHz

RE 3-18GHz PK+AV

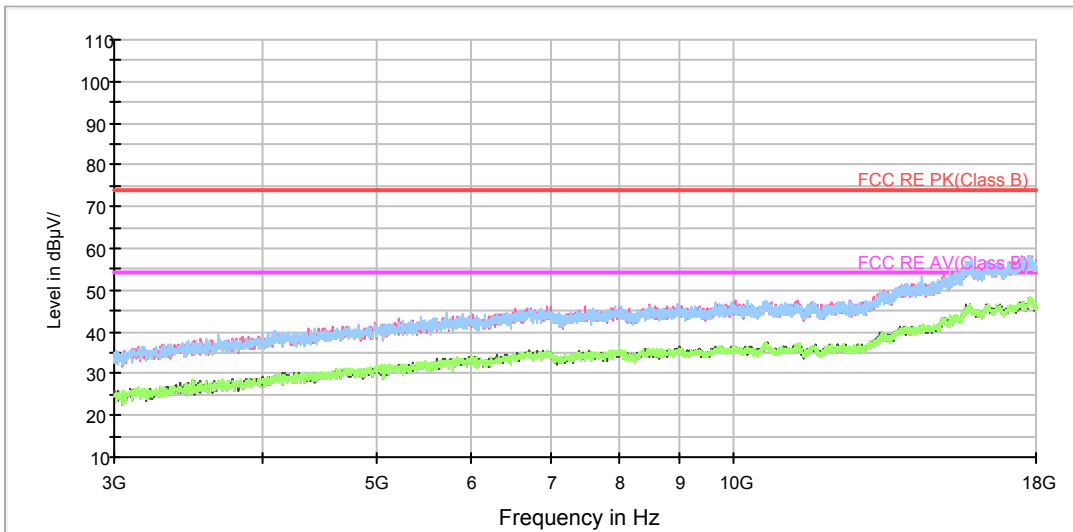

Radiates Emission from 3GHz to 18GHz



Frequency (MHz)	Peak (dBuV/m)	Height (cm)	Polarization	Azimuth (deg)	Reading value (dBuV/m)	Correct Factor (dB)	Margin (dB)	Limit (dBuV/m)
1021.000000	36.5	200.0	V	168.0	48.2	-11.7	37.5	74
1438.500000	37.2	200.0	V	62.0	47.0	-9.8	36.8	74
1725.000000	41.3	200.0	H	144.0	49.5	-8.2	32.7	74
2069.500000	41.4	200.0	V	256.0	47.8	-6.4	32.6	74
2400.000000	43.9	200.0	V	80.0	48.5	-4.6	30.1	74
2760.500000	43.7	100.0	V	112.0	47.5	-3.8	30.3	74

Remark: 1. Correction Factor = Antenna factor+ Insertion loss (cable loss - amplifier gain)

Frequency (MHz)	Average (dBuV/m)	Height (cm)	Polarization	Azimuth (deg)	Reading value (dBuV/m)	Correct Factor (dB)	Margin (dB)	Limit (dBuV/m)
1101.500000	26.1	100.0	V	101.0	37.3	-11.2	27.9	54
1426.000000	26.5	100.0	V	160.0	36.4	-9.9	27.5	54
1725.000000	36.3	200.0	V	148.0	44.5	-8.2	17.7	54
2070.000000	35.2	200.0	V	246.0	41.6	-6.4	18.8	54
2415.000000	34.0	100.0	V	101.0	38.5	-4.5	20.0	54
2760.000000	33.0	200.0	V	100.0	36.8	-3.8	21.0	54

Remark: 1. Correction Factor = Antenna factor+ Insertion loss (cable loss - amplifier gain)

**BLE-Channel 39**

FCC RE 1G-3GHz PK+AV Class B

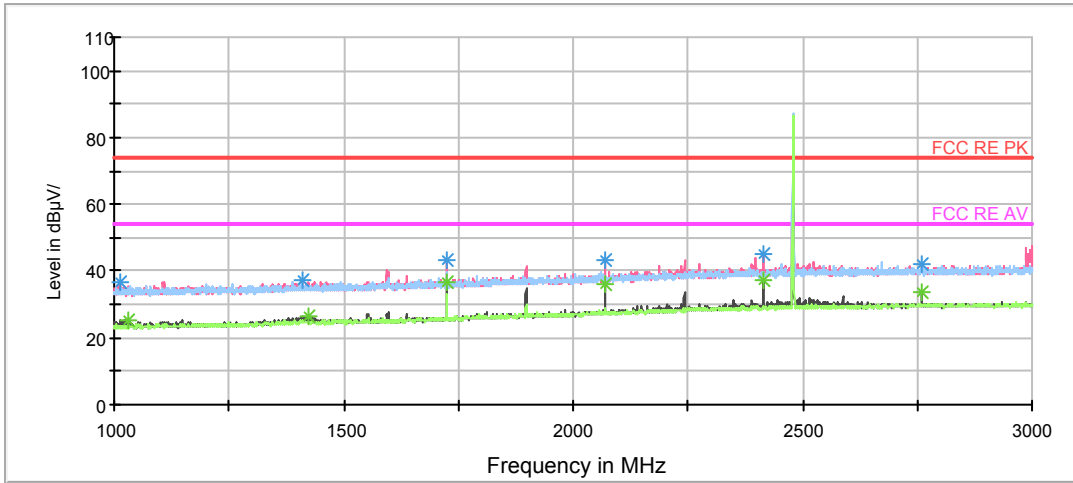

Note: The signal beyond the limit is carrier.  
Radiates Emission from 1GHz to 3GHz

RE 3-18GHz PK+AV

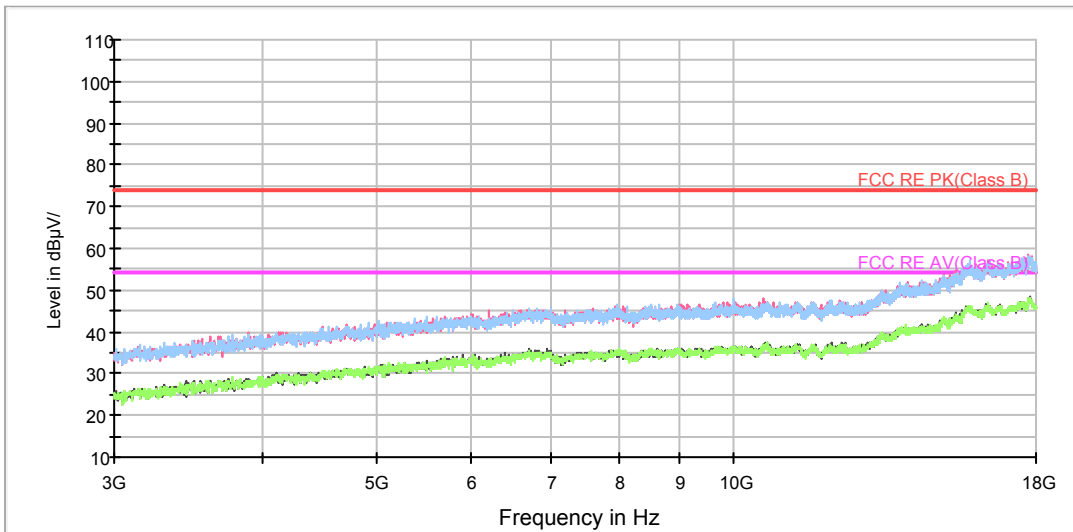

Radiates Emission from 3GHz to 18GHz





Frequency (MHz)	Peak (dBuV/m)	Height (cm)	Polarization	Azimuth (deg)	Reading value (dBuV/m)	Correct Factor (dB)	Margin (dB)	Limit (dBuV/m)
1014.000000	36.5	100.0	V	240.0	48.3	-11.8	37.5	74
1408.500000	37.4	200.0	V	45.0	47.4	-10.0	36.6	74
1725.000000	43.0	100.0	V	84.0	51.2	-8.2	31.0	74
2069.500000	43.1	200.0	V	122.0	49.5	-6.4	30.9	74
2415.000000	44.9	200.0	V	94.0	49.4	-4.5	29.1	74
2760.000000	41.9	200.0	V	84.0	45.7	-3.8	32.1	74

Remark: 1. Correction Factor = Antenna factor+ Insertion loss (cable loss - amplifier gain)

Frequency (MHz)	Average (dBuV/m)	Height (cm)	Polarization	Azimuth (deg)	Reading value (dBuV/m)	Correct Factor (dB)	Margin (dB)	Limit (dBuV/m)
1029.000000	25.2	200.0	V	122.0	36.9	-11.7	28.8	54
1421.500000	26.5	100.0	V	163.0	36.4	-9.9	27.5	54
1725.000000	36.8	200.0	V	247.0	45.0	-8.2	17.2	54
2070.000000	35.8	200.0	V	122.0	42.2	-6.4	18.2	54
2415.000000	37.3	200.0	V	94.0	41.8	-4.5	16.7	54
2760.000000	33.5	100.0	V	104.0	37.3	-3.8	20.5	54

Remark: 1. Correction Factor = Antenna factor+ Insertion loss (cable loss - amplifier gain)



During the test, the Radiates Emission from 18GHz to 26.5GHz was performed in all modes with all channels, BLE-Channel 39 are selected as the worst condition. The test data of the worst-case condition was recorded in this report.

RE 18-26.5GHz PK+AV

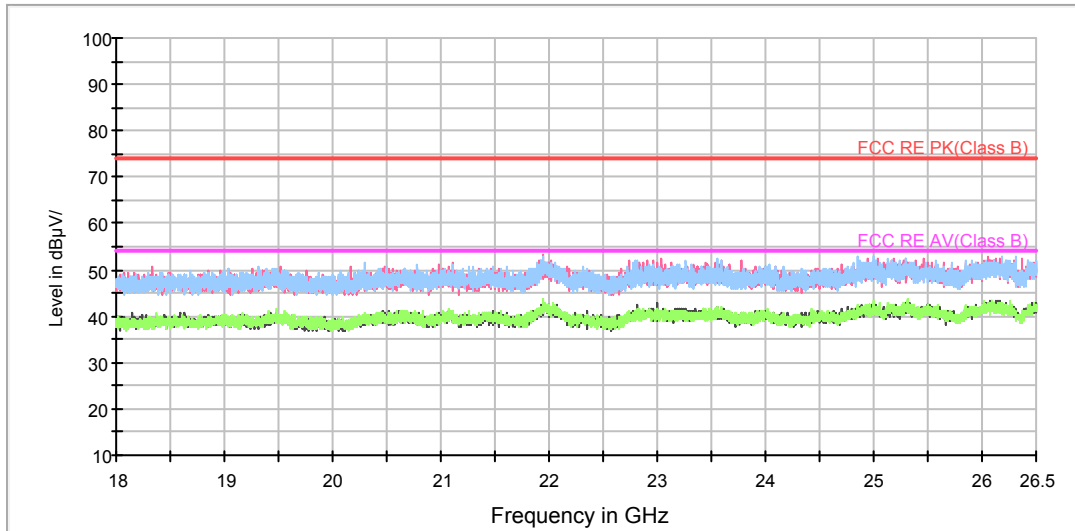

Radiates Emission from 18GHz to 26.5GHz

### 5.7. Conducted Emission

#### Ambient condition

Temperature	Relative humidity	Pressure
23°C ~25°C	45%~50%	101.5kPa

#### Methods of Measurement

The EUT is placed on a non-metallic table of 80cm height above the horizontal metal reference ground plane. During the test, the EUT was operating in its typical mode. The test method is according to ANSI C63.10-2013. Connect the AC power line of the EUT to the L.I.S.N. Use EMI receiver to detect the average and Quasi-peak value. RBW is set to 9 kHz, VBW is set to 30kHz. The measurement result should include both L line and N line.

The test is in transmitting mode.

#### Test Setup

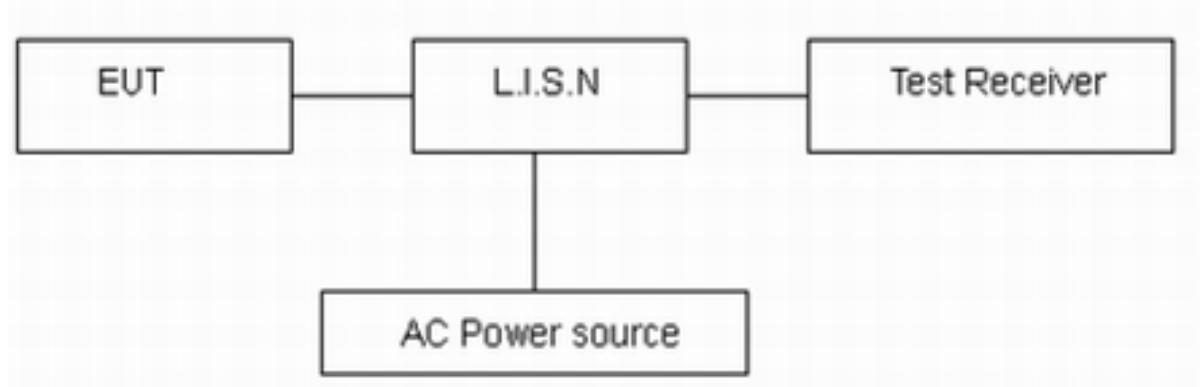

Note: AC Power source is used to change the voltage 110V/60Hz.

#### Limits

Frequency (MHz)	Conducted Limits(dBμV)	
	Quasi-peak	Average
0.15 - 0.5	66 to 56 *	56 to 46*
0.5 - 5	56	46
5 - 30	60	50

\*: Decreases with the logarithm of the frequency.

#### Measurement Uncertainty

The assessed measurement uncertainty to ensure 95% confidence level for the normal distribution is with the coverage factor  $k = 1.96$ ,  $U = 2.69$  dB.

**Test Results:**

Following plots, Blue trace uses the peak detection and Green trace uses the average detection. During the test, the Conducted Emission was performed in all modes (WIFI 2.4G /BLE) with all channels, BLE-Channel 39 are selected as the worst condition. The test data of the worst-case condition was recorded in this report.

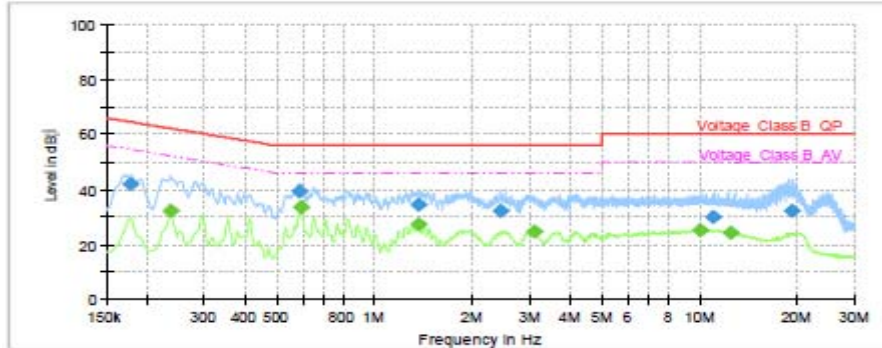

Frequency (MHz)	QuasiPeak (dB   V)	Average (dB   V)	Limit (dB   V)	Margin (dB)	Meas. Time (ms)	Bandwidth (kHz)	Line	Filter	Corr. (dB)
0.177000	41.88	---	64.63	22.75	1000.0	9.000	L1	ON	19.2
0.237750	---	32.25	52.17	19.92	1000.0	9.000	L1	ON	19.1
0.591000	39.19	---	56.00	16.81	1000.0	9.000	L1	ON	19.3
0.593250	---	33.50	46.00	12.50	1000.0	9.000	L1	ON	19.3
1.364750	---	27.41	46.00	18.59	1000.0	9.000	L1	ON	19.2
1.367750	34.55	---	56.00	21.45	1000.0	9.000	L1	ON	19.2
2.459250	32.14	---	56.00	23.86	1000.0	9.000	L1	ON	19.0
3.099750	---	24.96	46.00	21.04	1000.0	9.000	L1	ON	19.1
9.993750	---	25.13	50.00	24.87	1000.0	9.000	L1	ON	19.4
11.028000	30.14	---	60.00	29.86	1000.0	9.000	L1	ON	19.4
12.424000	---	24.36	50.00	25.64	1000.0	9.000	L1	ON	19.4
19.278000	32.28	---	60.00	27.72	1000.0	9.000	L1	ON	19.6

L line

Conducted Emission from 150 KHz to 30 MHz

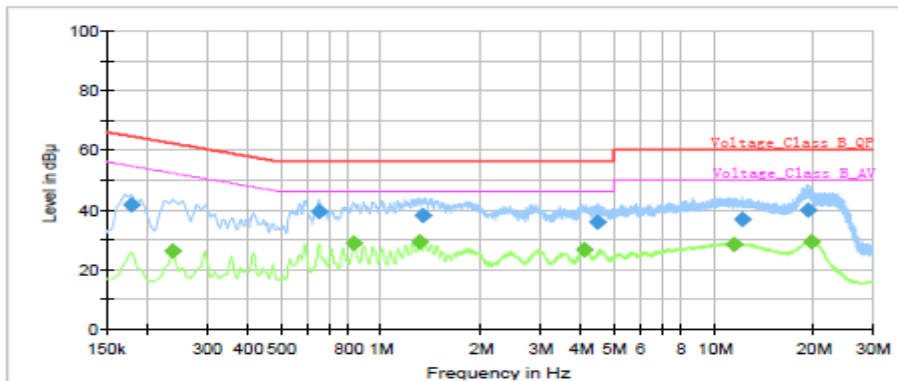

Frequency (MHz)	QuasiPeak (dB $\mu$ V)	Average (dB $\mu$ V)	Limit (dB $\mu$ V)	Margin (dB)	Meas. Time (ms)	Bandwidth (kHz)	Line	Filter	Corr. (dB)
0.177500	41.51	---	64.60	23.09	1000.0	9.000	N	ON	19.2
0.237500	---	26.28	52.18	25.90	1000.0	9.000	N	ON	19.1
0.652000	39.28	---	56.00	16.72	1000.0	9.000	N	ON	19.3
0.827250	---	28.96	46.00	17.04	1000.0	9.000	N	ON	19.2
1.308998	---	29.26	46.00	16.74	1000.0	9.000	N	ON	19.2
1.331750	38.01	---	56.00	17.99	1000.0	9.000	N	ON	19.2
4.096500	---	26.61	46.00	19.39	1000.0	9.000	N	ON	19.1
4.490750	35.64	---	56.00	20.36	1000.0	9.000	N	ON	19.1
11.503746	---	28.49	50.00	21.51	1000.0	9.000	N	ON	19.4
12.217000	36.77	---	60.00	23.23	1000.0	9.000	N	ON	19.4
19.247250	39.96	---	60.00	20.04	1000.0	9.000	N	ON	19.5
19.721972	---	29.38	50.00	20.62	1000.0	9.000	N	ON	19.5

N line

Conducted Emission from 150 KHz to 30 MHz



## 6. Main Test Instruments

Name	Manufacturer	Type	Serial Number	Calibration Date	Expiration Date
Spectrum Analyzer	R&S	FSV30	100815	2017-12-17	2018-12-16
EMI Test Receiver	R&S	ESCI	100948	2018-05-20	2019-05-19
Loop Antenna	SCHWARZBECK	FMZB1519	1519-047	2017-09-26	2019-09-25
TRILOG Broadband Antenna	Schwarzbeck	VULB 9163	9163-201	2017-11-18	2019-11-17
Double Ridged Waveguide Horn Antenna	R&S	HF907	100126	2018-07-07	2020-07-06
Standard Gain Horn	ETS-Lindgren	3160-09	00102643	2018-06-20	2020-06-19
EMI Test Receiver	R&S	ESR	101667	2018-05-20	2019-05-19
LISN	R&S	ENV216	101171	2016-12-16	2019-12-15
Spectrum Analyzer	Agilent	N9010A	MY47191109	2018-05-20	2019-05-19
Power Meter	R&S	NRP	104306	2018-05-20	2019-05-19
Power Sensor	R&S	NRP-Z21	104799	2018-05-20	2019-05-19
Preampfier	R&S	SCU18	102327	2018-05-20	2019-05-19
RF Cable	Agilent	SMA 15cm	0001	/	/
Software	R&S	EMC32	9.26.0	/	/

\*\*\*\*\*END OF REPORT \*\*\*\*\*