

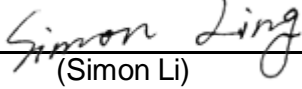

# FCC EMC Test Report

## FCC ID: QISHRY-LX2

**Project No.** : 1809C113  
**Equipment** : Smart Phone  
**Test Model** : HRY-LX2  
**Series Model** : N/A  
**Applicant** : Huawei Technologies Co., Ltd.  
**Address** : Administration Building, Headquarters of Huawei Technologies Co., Ltd., Bantian, Longgang District, Shenzhen, 518129, P.R.C

**Date of Receipt** : Sep. 19, 2018  
**Date of Test** : Sep. 19, 2018 ~ Oct. 09, 2018  
**Issued Date** : Oct. 15, 2018  
**Tested by** : BTL Inc.

**Testing Engineer** :   
(Simon Li)

**Technical Manager** :   
(Bill Zhang)

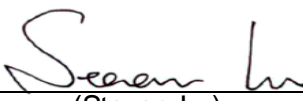
**Authorized Signatory** :   
(Steven Lu)

# **B T L I N C .**

No.3, Jinshagang 1st Road, Shixia, Dalang Town, Dongguan,  
Guangdong, China.

TEL: +86-769-8318-3000 FAX: +86-769-8319-6000



Certificate #5123.02

## Declaration

**BTL** represents to the client that testing is done in accordance with standard procedures as applicable and that test instruments used has been calibrated with standards traceable to international standard(s) and/or national standard(s).

**BTL's** reports apply only to the specific samples tested under conditions. It is manufacture's responsibility to ensure that additional production units of this model are manufactured with the identical electrical and mechanical components. **BTL** shall have no liability for any declarations, inferences or generalizations drawn by the client or others from **BTL** issued reports.

The report must not be used by the client to claim product certification, approval, or endorsement by NVLAP, NIST, or any agency of the U.S. Government.

This report is the confidential property of the client. As a mutual protection to the clients, the public and ourselves, the test report shall not be reproduced, except in full, without our written approval.

**BTL's** laboratory quality assurance procedures are in compliance with the **ISO Guide 17025** requirements, and accredited by the conformity assessment authorities listed in this test report.

**BTL** is not responsible for the sampling stage, so the results only apply to the sample as received.

The information, data and test plan are provided by manufacturer, so it is manufacturer's responsibility to ensure that the apparatus meets the essential requirements in all the possible configurations as representative of its intended use.

## Limitation

For the use of the authority's logo is limited unless the Test Standard(s)/Scope(s)/Item(s) mentioned in this test report is (are) included in the conformity assessment authorities acceptance respective.

<b>Table of Contents</b>	<b>Page</b>
<b>REPORT ISSUED HISTORY</b>	<b>4</b>
<b>1 . CERIFICATION</b>	<b>5</b>
<b>2 . SUMMARY OF TEST RESULTS</b>	<b>6</b>
2.1 TEST FACILITY	7
2.2 MEASUREMENT UNCERTAINTY	7
<b>3 . GENERAL INFORMATION</b>	<b>8</b>
3.1 GENERAL DESCRIPTION OF EUT	8
3.2 DESCRIPTION OF TEST MODES	10
3.3 EUT OPERATING CONDITIONS	12
3.4 BLOCK DIAGRAM SHOWING THE CONFIGURATION OF SYSTEM TESTED	12
3.5 DESCRIPTION OF SUPPORT UNITS	14
<b>4 . EMC EMISSION TEST</b>	<b>15</b>
4.1 CONDUCTED EMISSION MEASUREMENT	15
4.1.1 POWER LINE CONDUCTED EMISSION	15
4.1.2 MEASUREMENT INSTRUMENTS LIST	15
4.1.3 TEST PROCEDURE	16
4.1.4 DEVIATION FROM TEST STANDARD	16
4.1.5 TEST SETUP	16
4.1.6 TEST RESULTS	16
4.2 RADIATED EMISSION MEASUREMENT	29
4.2.1 LIMITS OF RADIATED EMISSION MEASUREMENT	29
4.2.2 MEASUREMENT INSTRUMENTS LIST	30
4.2.3 TEST PROCEDURE	31
4.2.4 DEVIATION FROM TEST STANDARD	31
4.2.5 TEST SETUP	32
4.2.6 TEST RESULTS-BELOW 1 GHZ	32
4.2.7 TEST RESULTS-ABOVE 1 GHZ	45

### REPORT ISSUED HISTORY

Issued No.	Description	Issued Date
BTL-FCCE-1-1809C113	Original Issue.	Oct. 15, 2018

## 1. CERIFICATION

Equipment : Smart Phone  
Brand Name : HUAWEI  
Test Model : HRY-LX2  
Series Model : N/A  
Applicant : Huawei Technologies Co., Ltd.  
Manufacturer : Huawei Technologies Co., Ltd.  
Address : Administration Building, Headquarters of Huawei Technologies Co., Ltd.,  
Bantian, Longgang District, Shenzhen, 518129, P.R.C  
Factory : Huawei Technologies Co., Ltd.  
Address : Administration Building, Headquarters of Huawei Technologies Co., Ltd.,  
Bantian, Longgang District, Shenzhen, 518129, P.R.C  
Date of Test : Sep. 19, 2018 ~ Oct. 09, 2018  
Engineering Sample No.:  
D180908205(IMEI1:868592040012186,IME I2:868592040015833),  
Test Sample : D180908206(IMEI1:868592040011535,IME I2:868592040015189),  
D180908208(IMEI1:868592040012806,IME I2:868592040016450),  
D180908207(IMEI1:868592040012749,IME I2:868592040016393)  
Standard(s) : FCC Part 15, Subpart B  
ANSI C63.4-2014

The above equipment has been tested and found compliance with the requirement of the relative standards by BTL Inc.

The test data, data evaluation, and equipment configuration contained in our test report (Ref No. BTL-FCCE-1-1809C113) were obtained utilizing the test procedures, test instruments, test sites that has been accredited by the Authority of A2LA according to the ISO-17025 quality assessment standard and technical standard(s).

## 2. SUMMARY OF TEST RESULTS

Test procedures according to the technical standard(s):

EMC Emission				
Standard(s)	Test Item	Limit	Judgment	Remark
FCC Part15, Subpart B ANSI C63.4-2014	Conducted Emission	Class B	PASS	
	Radiated emission Below 1 GHz	Class B	PASS	
	Radiated emission Above 1 GHz	Class B	PASS	NOTE(2)

NOTE:

- (1) "N/A" denotes test is not applicable to this device.
- (2) The EUT's max operating frequency exceeds 108 MHz, so the test will be performed.

## 2.1 TEST FACILITY

The test facilities used to collect the test data in this report at the location of No.3, Jinshagang 1st Road, Shixia, Dalang Town, Dongguan, Guangdong, China.

BTL's test firm number for FCC: 854385

BTL's designation number for FCC: CN5020

## 2.2 MEASUREMENT UNCERTAINTY

Where relevant, the following measurement uncertainty levels have been estimated for tests performed on the EUT as specified in CISPR 16-4-2. The BTL measurement uncertainty is less than the CISPR 16-4-2  $U_{\text{CISPR}}$  requirement.

The reported uncertainty of measurement  $y \pm U$ , where expanded uncertainty  $U$  is based on a standard uncertainty multiplied by a coverage factor of  $k=2$ , providing a level of confidence of approximately **95%**.

### A. Conducted Measurement :

Test Site	Method	Measurement Frequency Range	U, (dB)
DG-C02	CISPR	150 kHz ~ 30MHz	2.32

### B. Radiated Measurement

Test Site	Method	Measurement Frequency Range	Ant. H / V	U, (dB)
DG-CB08 (10m)	CISPR	30MHz ~ 200MHz	V	4.66
		30MHz ~ 200MHz	H	4.64
		200MHz ~ 1,000MHz	V	4.88
		200MHz ~ 1,000MHz	H	4.86

Test Site	Method	Measurement Frequency Range	U, (dB)
DG-CB08 (3m)	CISPR	1 ~ 6 GHz	4.26
		6 ~ 18 GHz	5.30

Note: Unless specifically mentioned, the uncertainty of measurement has not been taken into account to declare the compliance or non-compliance to the specification.

### 3. GENERAL INFORMATION

#### 3.1 GENERAL DESCRIPTION OF EUT

Equipment	Smart Phone
Brand Name	HUAWEI
Test Model	HRY-LX2
Series Model	N/A
Model Difference(s)	N/A
Work Frequency	Please refer to Note 2.
Power Source	#1: DC Voltage supplied from AC/DC adapter. Model: HW-050200E02 #2: Battery Supplied. Model: HB396286ECW #3: Supplied from USB Cable
Power Rating	#1: I/P: 100-240V~50/60Hz,0.5A O/P: 5V --- 2A #2: DC 3.82V, 3320mAh #3: DC 5V
Hardware Version	HL1HRYM
Software Version	5.0.1.50(C900E51R1P6)

Note:

1. For a more detailed features description, please refer to the manufacturer's specifications or the user's manual.
- 2.

Mode		Work Frequency	
		Transmitt Frequency (MHz)	Receive Frequency (MHz)
GSM	GSM900	880-915	925-960
	DCS1800	1710-1785	1805-1880
UMTS	WCDMA Band I	1920-1980	2110-2170
	WCDMA Band VIII	880-915	925-960
LTE	LTE B1	1920-1980	2110-2170
	LTE B3	1710-1785	1805-1880
	LTE B7	2500 -2570	2620 -2690
	LTE B8	880-915	925-960
	LTE B28	703-748	758-803
	LTE B38	2570-2620	
	LTE B40	2300-2400	
Bluetooth		2400-2483.5	
2.4GHz Wi-Fi		2400-2483.5	
GPS		N/A	1575.42
BDS		N/A	1561.098
GLONASS		N/A	1597-1607
FM		N/A	87.5 to 108



3 The EUT contains following accessory devices.

Item	Manufacture/ /trademark	Description
Adapter	Salcomp	HW-050200E02
		HW-050200B02
		HW-050200A02
		HW-050200E01
		HW-050200B01
		HW-050200A01
	HUIZHOU BYD ELECTRONIC CO., LTD.	HW-050200E02
		HW-050200B02
		HW-050200A02
	SHENZHEN HUNTKEY ELECTRIC CO., LTD.	HW-050200E02
		HW-050200B02
		HW-050200E01
HW-050200B01		
HW-050200A01		
Dongguan Phitek Electronics Co., Ltd.	HW-050200E02	
	HW-050200B02	
	HW-050200E01	
	HW-050200B01	
Battery	Huawei Technologies Co., Ltd. (Manufacturer: SCUD)	Model: HB396286ECW Rated Voltage: 3320mAh Nominal: Voltage:  +3.82V Charging: Voltage:  +4.40V
	Huawei Technologies Co., Ltd. (Manufacturer: NVT)	
	Huawei Technologies Co., Ltd. (Manufacturer: Sunwoda)	
	Huawei Technologies Co., Ltd. (Manufacturer: Desay)	
USB Cable	NingBo Broad Telecommunication Co., Ltd.	Model Name: WA0001
	HONGLIN TECHNOLOGY CO., LTD.	Model Name: 130-26669
	FOXCONN INTERCONNECT TECHNOLOGY LIMITED	Model Name: CUBB01M-HC304-DH
	LuXshare	Model Name: L99U2017-CS-H
Earphone	Jiangxi Lianchuang Hongsheng Electronic Co.,LTD	MEND1532B528A02
	Boluo County Quancheng Electronic Co.,ltd	1293-3283-3.5mm-322

### 3.2 DESCRIPTION OF TEST MODES

To investigate the maximum EMI emission characteristics generated from EUT, the test system was pre-scanning tested base on the consideration of following EUT operation mode or test configuration mode which possible have effect on EMI emission level. Each of these EUT operation mode(s) or test configuration mode(s) mentioned above was evaluated respectively.

Pretest Mode	Description
Mode 1	Adapter+ Idle+Playing+Speaker
Mode 2	Adapter+ Idle+Playing+earphone
Mode 3	Adapter+Idle+2.4G WIFI+BT+GPS+Camera on(Front)
Mode 4	Adapter+Idle+2.4G WIFI+BT+GPS+Camera on(Rear)
Mode 5	Adapter+Traffic(GSM)
Mode 6	Adapter+Traffic(WCDMA)
Mode 7	Adapter+Traffic(LTE)
Mode 8	FM 88MHz
Mode 9	FM 98MHz
Mode 10	FM 108MHz
Mode 11	USB Copy + Idle

For Conducted Test	
Final Test Mode	Description
Mode 1	Adapter+ Idle+Playing+Speaker
Mode 2	Adapter+ Idle+Playing+earphone
Mode 3	Adapter+Idle+2.4G WIFI+BT+GPS+Camera on(Front)
Mode 7	Adapter+Traffic(LTE)
Mode 9	FM 98MHz
Mode 11	USB Copy + Idle

For Radiated Test	
Final Test Mode	Description
Mode 1	Adapter+ Idle+Playing+Speaker
Mode 2	Adapter+ Idle+Playing+earphone
Mode 3	Adapter+Idle+2.4G WIFI+BT+GPS+Camera on(Front)
Mode 7	Adapter+Traffic(LTE)
Mode 9	FM 98MHz
Mode 11	USB Copy + Idle

Evaluation description:

1. The Mode 1-11 had been pretest, found the Mode 1,2,3,7,9,11 is the worst case and record in this report.
2. Mode1: Test adapter for all parts of different manufacturers and different models. the worst data is :

Adapter	Salcomp
Battery	SCUD
USB Cable	NingBo Broad Telecommunication Co., Ltd.

3. Mode 2: Test the parts of earphone of different manufacturers, and found the Lianchuang is the worst case and record in report.
4. Mode 11: Test the USB Cable of different manufacturers, and found the NingBo Broad Telecommunication Co., Ltd., is the worst case and record in report.

### 3.3 EUT OPERATING CONDITIONS

The EUT exercise program used during radiated and/or conducted emission measurement was designed to exercise the various system components in a manner similar to a typical use. The standard test signals and output signal as following:

1. Mode 1-10:

1. EUT connected to earphone via earphone cable.
2. EUT connected to adapter via DC cable.
3. EUT connected to wireless router via WiFi function.
4. EUT connected to bluetooth earphone via BT function.
5. EUT connected to wireless communication test SET via radio signal.
6. EUT connected to GPS signal generator via radio signal.
7. EUT connected to wideband radio communication tester via radio signal.

Mode 11:

1. Send "H" pattern to video port device (Monitor).
2. Send " H " pattern to parallel port device (Printer).
3. Send " H " pattern to serial port device (Modem).
4. EUT connected to PC via USB cable.
5. EUT connected to wireless router via WiFi function.
6. EUT connected to bluetooth earphone via BT function.
7. Repeated from 1 to 6 continuously.

As the keyboard and mouse are strictly input devices, no data is transmitted to (from) them during test. They are, however, continuously scanned for data input activity.

### 3.4 BLOCK DIAGRAM SHOWING THE CONFIGURATION OF SYSTEM TESTED Mode1-10

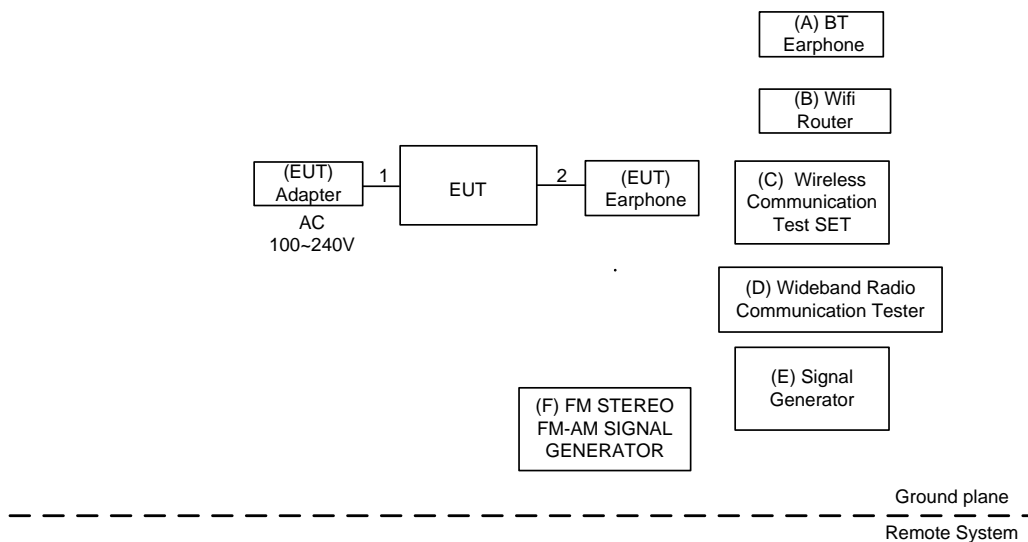

Mode11

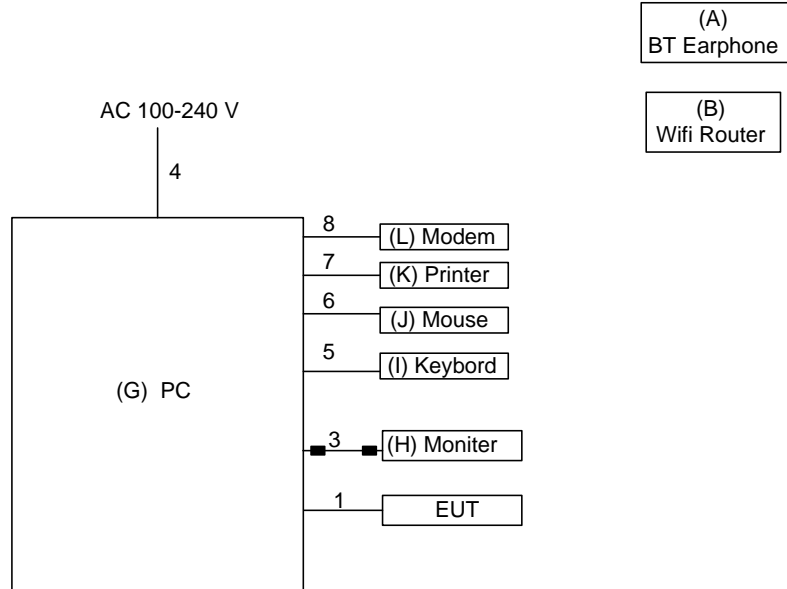

■ Ferrite core

Ground plane  
Remote System

### 3.5 DESCRIPTION OF SUPPORT UNITS

The EUT has been tested as an independent unit together with other necessary accessories or support units. The following support units or accessories were used to form a representative test configuration during the tests.

Item	Equipment	Mfr/Brand	Model/Type No.	FCC ID	Series No.
A	BT earphone	MICROKIA	M9	N/A	N/A
B	wireless router	ASUS	RT-AC66U	MSQ-RTAC66U	E8ICGG000138
C	Wireless Communication Test SET	Agilent	(8960 Series)	N/A	MY48364183
D	Wideband Radio Communication Tester	RS	CMW500	N/A	122125
E	Signal Generator	Agilent	E4438C	N/A	MY49071316
F	FM STEREO FM-AM SIGNAL GENERATOR	KENWOOD	SG-5110	DOC	HR1010099
G	PC	DELL	DCSM	DOC	G7K832X
H	LCD monitor	DELL	E177FPc	DOC	CNOFJ179-64180-6AG-1WNS
I	Keyboard	DELL	L100	DOC	CNORH6596589071T08NE
J	Mouse	DELL	MO56UOA	DOC	FQJ000BS
K	Printer	SII	DPU-414	DOC	3018507 B
L	Modem	ACEEX	DM-1414V	IFAXDM1414	603002131

Item	Shielded Type	Ferrite Core	Length	Note
1	YES	NO	1m	USB Cable
2	NO	NO	1m	Earphone Cable
3	YES	YES	1.8m	D-SUB Cable
4	NO	NO	1.8m	AC Cable
5	YES	NO	1.8m	USB Cable
6	YES	NO	1.8m	USB Cable
7	YES	NO	1.8m	Parallel cable
8	YES	NO	1.8m	RS232 cable

## 4. EMC EMISSION TEST

### 4.1 CONDUCTED EMISSION MEASUREMENT

#### 4.1.1 POWER LINE CONDUCTED EMISSION (FREQUENCY RANGE 150 KHZ-30MHZ)

FREQUENCY (MHz)	Class A (dBuV)		Class B (dBuV)	
	Quasi-peak	Average	Quasi-peak	Average
0.15 - 0.5	79.00	66.00	66 - 56 *	56 - 46 *
0.50 - 5.0	73.00	60.00	56.00	46.00
5.0 - 30.0	73.00	60.00	60.00	50.00

Note:

- (1) The tighter limit applies at the band edges.
- (2) The limit of " \* " marked band means the limitation decreases linearly with the logarithm of the frequency in the range.
- (3) The test result calculated as following:  
 Measurement Value = Reading Level + Correct Factor  
 Correct Factor = Insertion Loss + Cable Loss + Attenuator Factor(if use)  
 Margin Level = Measurement Value - Limit Value

#### 4.1.2 MEASUREMENT INSTRUMENTS LIST

Item	Kind of Equipment	Manufacturer	Type No.	Serial No.	Calibrated until
1	EMI Test Receiver	R&S	ESCI	100382	Mar. 11, 2019
2	LISN	EMCO	3816/2	52765	Mar. 11, 2019
3	50Ω Terminator	SHX	TF2-3G-A	8122901	Mar. 11, 2019
4	TWO-LINE V-NETWORK	R&S	ENV216	101447	Mar. 11, 2019
5	Measurement Software	Farad	EZ-EMC Ver.NB-03A 1-01	N/A	N/A
6	Cable	N/A	RG223	12m	Mar. 23, 2019

Remark: "N/A" denotes no model name, serial no. or calibration specified.

All calibration period of equipment list is one year.

### 4.1.3 TEST PROCEDURE

- a. The EUT was placed 0.8 meters from the horizontal ground plane with EUT being connected to the power mains through a line impedance stabilization network (LISN). All other support equipments powered from additional LISN(s). The LISN provide 50 Ohm/ 50uH of coupling impedance for the measuring instrument.
- b. Interconnecting cables that hang closer than 40 cm to the ground plane shall be folded back and forth in the center forming a bundle 30 to 40 cm long.
- c. I/O cables that are not connected to a peripheral shall be bundled in the center. The end of the cable may be terminated, if required, using the correct terminating impedance. The overall length shall not exceed 1 m.
- d. LISN at least 80 cm from nearest part of EUT chassis.
- e. For the actual test configuration, please refer to the related Item –EUT Test Photos.
- f. First the whole spectrum of emission caused by equipment under test(EUT) is recorded with Detector set to peak. Peak value recorded in table if the margin from QP Limit is larger than 2dB, otherwise, QP value is recorded, Measuring frequency range from 150KHz to 30MHz.

### 4.1.4 DEVIATION FROM TEST STANDARD

No deviation

### 4.1.5 TEST SETUP

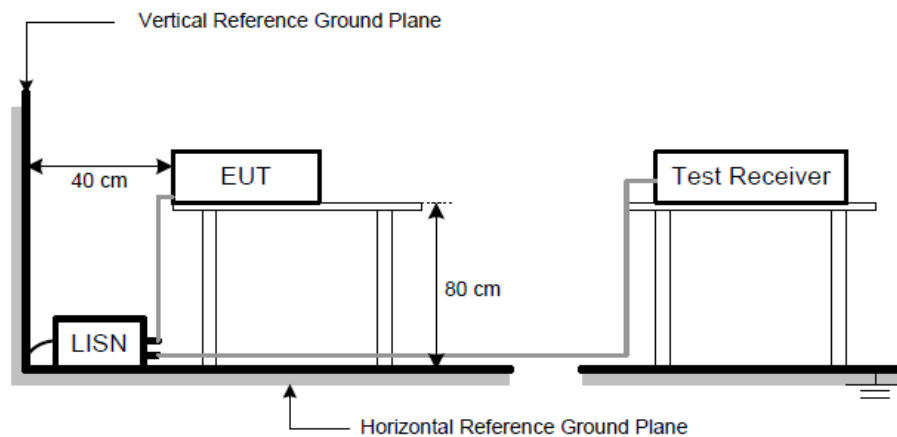

### 4.1.6 TEST RESULTS

Remark

- (1) Reading in which marked as QP means measurements by using are Quasi-Peak Mode with Detector BW=9 kHz; SPA setting in RBW=10 kHz, VBW =10 kHz, Swp. Time = 0.3 sec./MHz. Reading in which marked as AV means measurements by using are Average Mode with instrument setting in RBW=10 kHz, VBW=10 kHz, Swp. Time =0.3 sec./MHz.
- (2) All readings are QP Mode value unless otherwise stated AVG in column of 『Note』. If the QP Mode Measured value compliance with the QP Limits and lower than AVG Limits, the EUT shall be deemed to meet both QP & AVG Limits and then only QP Mode was measured, but AVG Mode didn't perform. In this case, a “ \* ” marked in AVG Mode column of Interference Voltage Measured.



EUT	Smart Phone	Model Name	HRY-LX2
Temperature	25°C	Relative Humidity	53%
Test Voltage	AC 120V/60Hz	Phase	Line
Test Mode	Adapter+ Idle+Playing+Speaker		
Test Engineer	Simon		

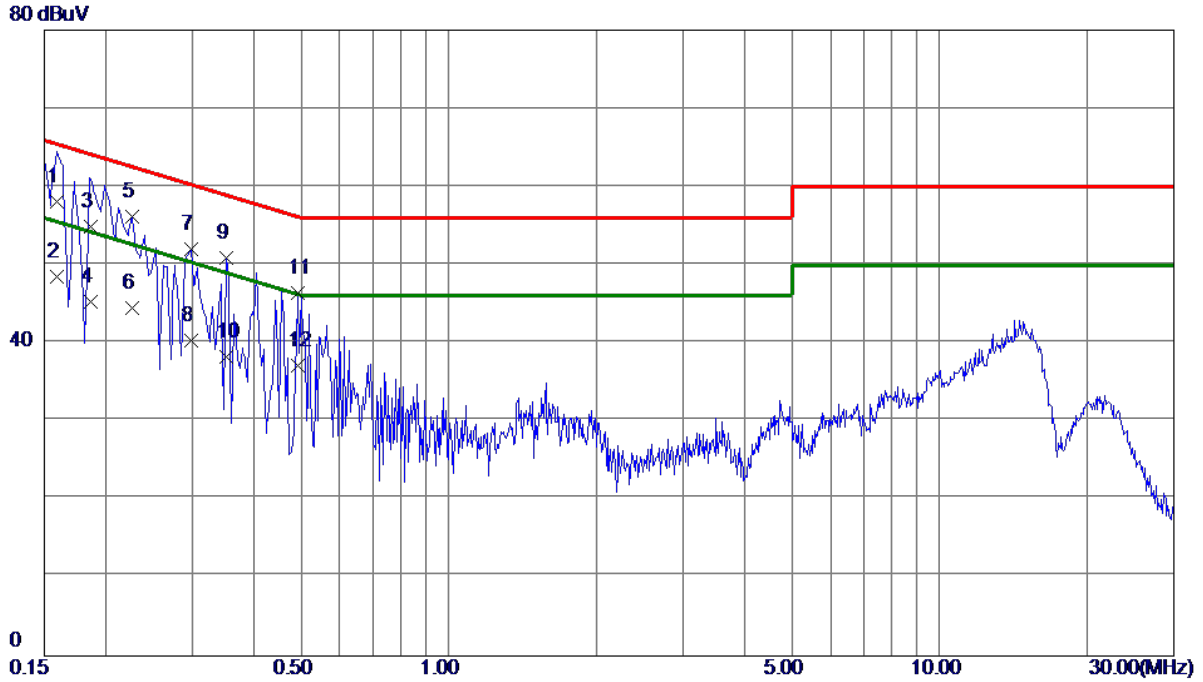

No.	Freq. MHz	Reading Level dBuV	Correct Factor dB	Measure ment dBuV	Limit dBuV	Margin dB	Detector
1	0.1590	48.20	9.82	58.02	65.52	-7.50	QP
2	0.1590	38.60	9.82	48.42	55.52	-7.10	AVG
3	0.1860	45.10	9.82	54.92	64.21	-9.29	QP
4	0.1860	35.40	9.82	45.22	54.21	-8.99	AVG
5 *	0.2265	46.40	9.82	56.22	62.58	-6.36	QP
6	0.2265	34.70	9.82	44.52	52.58	-8.06	AVG
7	0.2983	42.18	9.82	52.00	60.29	-8.29	QP
8	0.2983	30.50	9.82	40.32	50.29	-9.97	AVG
9	0.3524	41.07	9.81	50.88	58.91	-8.03	QP
10	0.3524	28.50	9.81	38.31	48.91	-10.60	AVG
11	0.4920	36.67	9.79	46.46	56.13	-9.67	QP
12	0.4920	27.40	9.79	37.19	46.13	-8.94	AVG

EUT	Smart Phone	Model Name	HRY-LX2
Temperature	25°C	Relative Humidity	53%
Test Voltage	AC 120V/60Hz	Phase	Neutral
Test Mode	Adapter+ Idle+Playing+Speaker		
Test Engineer	Simon		

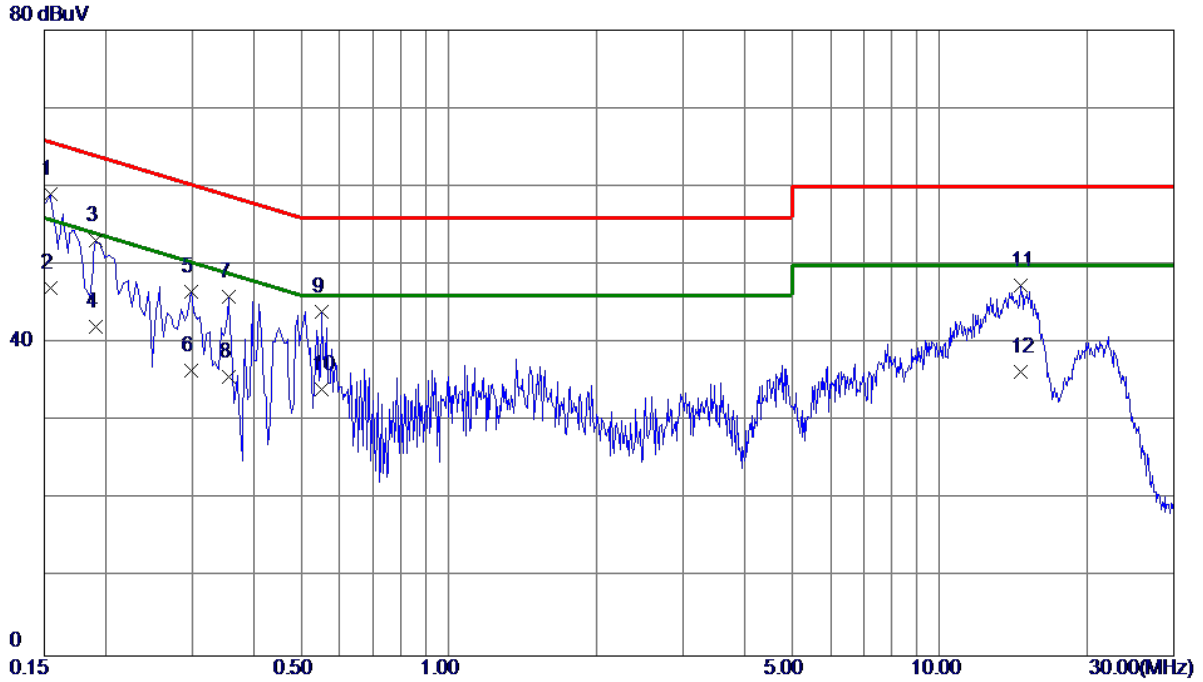

No.	Freq. MHz	Reading Level dBuV	Correct Factor dB	Measure ment dBuV	Limit dBuV	Margin dB	Detector
1 *	0.1544	49.15	9.91	59.06	65.76	-6.70	QP
2	0.1544	37.10	9.91	47.01	55.76	-8.75	AVG
3	0.1905	43.16	9.91	53.07	64.01	-10.94	QP
4	0.1905	32.10	9.91	42.01	54.01	-12.00	AVG
5	0.2985	36.69	9.93	46.62	60.28	-13.66	QP
6	0.2985	26.50	9.93	36.43	50.28	-13.85	AVG
7	0.3570	35.97	9.95	45.92	58.80	-12.88	QP
8	0.3570	25.80	9.95	35.75	48.80	-13.05	AVG
9	0.5503	34.06	9.96	44.02	56.00	-11.98	QP
10	0.5503	24.10	9.96	34.06	46.00	-11.94	AVG
11	14.6130	36.30	11.06	47.36	60.00	-12.64	QP
12	14.6130	25.30	11.06	36.36	50.00	-13.64	AVG

EUT	Smart Phone	Model Name	HRY-LX2
Temperature	25°C	Relative Humidity	53%
Test Voltage	AC 120V/60Hz	Phase	Line
Test Mode	Adapter+ Idle+Playing+earphone		
Test Engineer	Simon		

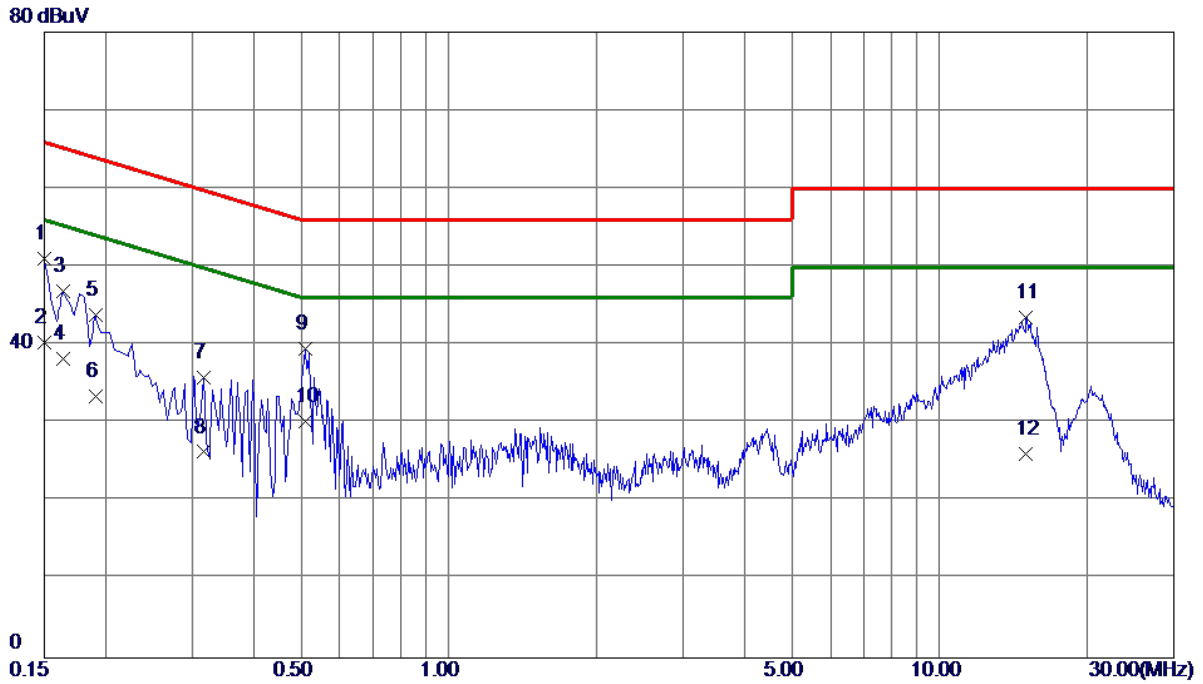

No.	Freq. MHz	Reading Level dBuV	Correct Factor dB	Measure ment dBuV	Limit dBuV	Margin dB	Detector
1 *	0.1500	41.19	9.82	51.01	66.00	-14.99	QP
2	0.1500	30.50	9.82	40.32	56.00	-15.68	AVG
3	0.1635	37.00	9.82	46.82	65.28	-18.46	QP
4	0.1635	28.40	9.82	38.22	55.28	-17.06	AVG
5	0.1905	33.95	9.82	43.77	64.01	-20.24	QP
6	0.1905	23.60	9.82	33.42	54.01	-20.59	AVG
7	0.3165	26.09	9.82	35.91	59.80	-23.89	QP
8	0.3165	16.50	9.82	26.32	49.80	-23.48	AVG
9	0.5100	29.79	9.79	39.58	56.00	-16.42	QP
10	0.5100	20.40	9.79	30.19	46.00	-15.81	AVG
11	14.9865	32.79	10.75	43.54	60.00	-16.46	QP
12	14.9865	15.40	10.75	26.15	50.00	-23.85	AVG

EUT	Smart Phone	Model Name	HRY-LX2
Temperature	25°C	Relative Humidity	53%
Test Voltage	AC 120V/60Hz	Phase	Neutral
Test Mode	Adapter+ Idle+Playing+earphone		
Test Engineer	Simon		

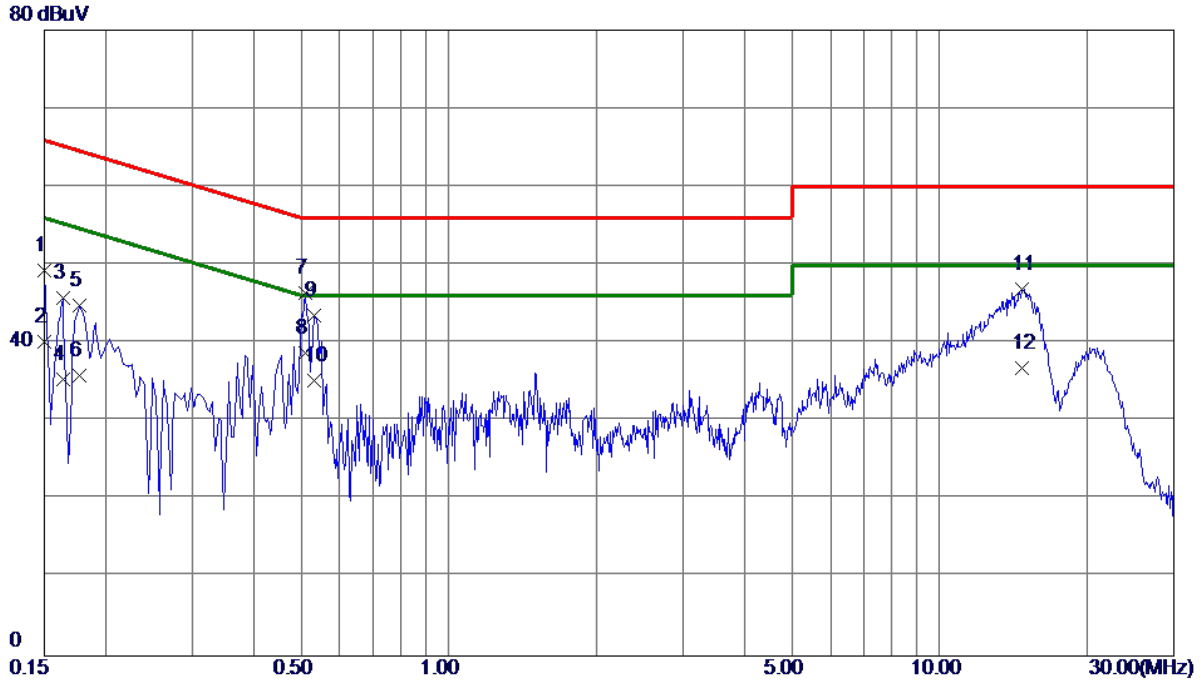

No.	Freq. MHz	Reading Level dBuV	Correct Factor dB	Measure ment dBuV	Limit dBuV	Margin dB	Detector
1	0.1500	39.30	9.91	49.21	66.00	-16.79	QP
2	0.1500	30.20	9.91	40.11	56.00	-15.89	AVG
3	0.1635	35.79	9.91	45.70	65.28	-19.58	QP
4	0.1635	25.40	9.91	35.31	55.28	-19.97	AVG
5	0.1770	34.89	9.91	44.80	64.63	-19.83	QP
6	0.1770	26.01	9.91	35.92	54.63	-18.71	AVG
7	0.5100	36.47	9.94	46.41	56.00	-9.59	QP
8 *	0.5100	28.80	9.94	38.74	46.00	-7.26	AVG
9	0.5325	33.52	9.95	43.47	56.00	-12.53	QP
10	0.5325	25.30	9.95	35.25	46.00	-10.75	AVG
11	14.7390	35.87	11.07	46.94	60.00	-13.06	QP
12	14.7390	25.80	11.07	36.87	50.00	-13.13	AVG

EUT	Smart Phone	Model Name	HRY-LX2
Temperature	25°C	Relative Humidity	53%
Test Voltage	AC 120V/60Hz	Phase	Line
Test Mode	Adapter+Idle+2.4G WIFI+BT+GPS+Camera on(Front)		
Test Engineer	Simon		

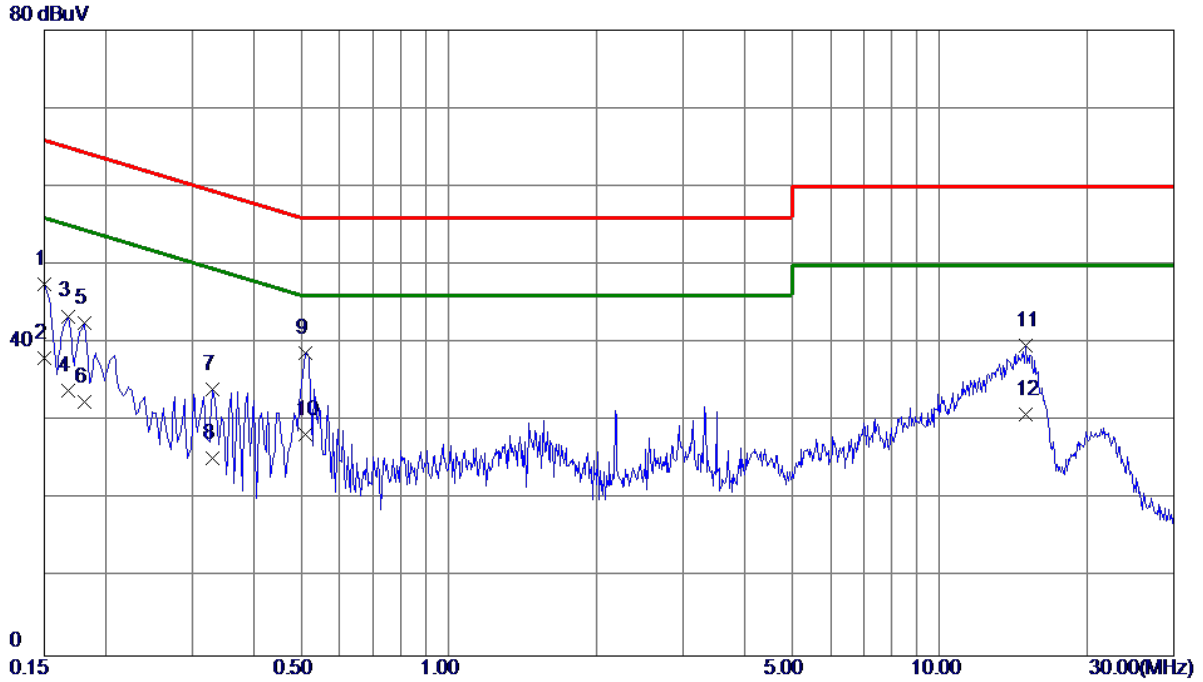

No.	Freq. MHz	Reading Level dBuV	Correct Factor dB	Measure ment dBuV	Limit dBuV	Margin dB	Detector
1	0.1500	37.74	9.82	47.56	66.00	-18.44	QP
2	0.1500	28.30	9.82	38.12	56.00	-17.88	AVG
3	0.1680	33.62	9.82	43.44	65.06	-21.62	QP
4	0.1680	24.10	9.82	33.92	55.06	-21.14	AVG
5	0.1815	32.81	9.82	42.63	64.42	-21.79	QP
6	0.1815	22.61	9.82	32.43	54.42	-21.99	AVG
7	0.3300	24.23	9.81	34.04	59.45	-25.41	QP
8	0.3300	15.40	9.81	25.21	49.45	-24.24	AVG
9 *	0.5100	28.94	9.79	38.73	56.00	-17.27	QP
10	0.5100	18.60	9.79	28.39	46.00	-17.61	AVG
11	14.9730	28.91	10.75	39.66	60.00	-20.34	QP
12	14.9730	20.10	10.75	30.85	50.00	-19.15	AVG

EUT	Smart Phone	Model Name	HRY-LX2
Temperature	25°C	Relative Humidity	53%
Test Voltage	AC 120V/60Hz	Phase	Neutral
Test Mode	Adapter+Idle+2.4G WIFI+BT+GPS+Camera on(Front)		
Test Engineer	Simon		

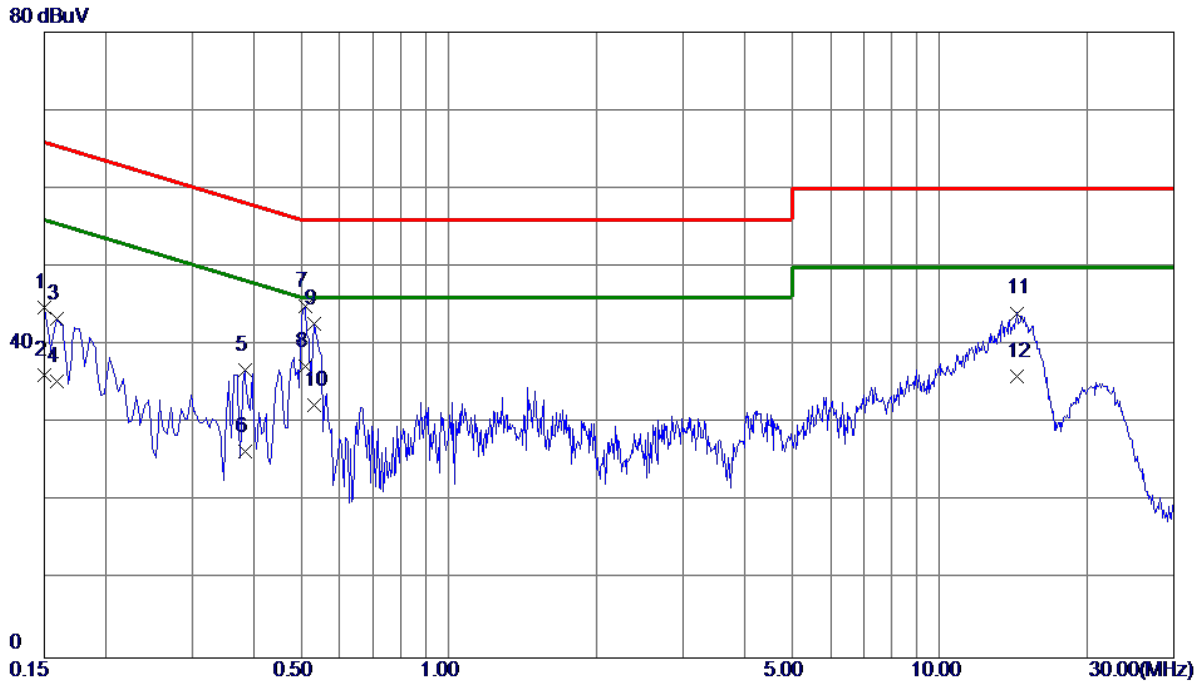

No.	Freq. MHz	Reading Level dBuV	Correct Factor dB	Measure ment dBuV	Limit dBuV	Margin dB	Detector
1	0.1500	34.96	9.91	44.87	66.00	-21.13	QP
2	0.1500	26.30	9.91	36.21	56.00	-19.79	AVG
3	0.1590	33.43	9.91	43.34	65.52	-22.18	QP
4	0.1590	25.40	9.91	35.31	55.52	-20.21	AVG
5	0.3840	26.79	9.95	36.74	58.19	-21.45	QP
6	0.3840	16.50	9.95	26.45	48.19	-21.74	AVG
7	0.5100	35.04	9.94	44.98	56.00	-11.02	QP
8 *	0.5100	27.40	9.94	37.34	46.00	-8.66	AVG
9	0.5325	32.72	9.95	42.67	56.00	-13.33	QP
10	0.5325	22.30	9.95	32.25	46.00	-13.75	AVG
11	14.3790	33.03	11.05	44.08	60.00	-15.92	QP
12	14.3790	24.90	11.05	35.95	50.00	-14.05	AVG

EUT	Smart Phone	Model Name	HRY-LX2
Temperature	25°C	Relative Humidity	53%
Test Voltage	AC 120V/60Hz	Phase	Line
Test Mode	Adapter+Traffic(LTE)		
Test Engineer	Simon		

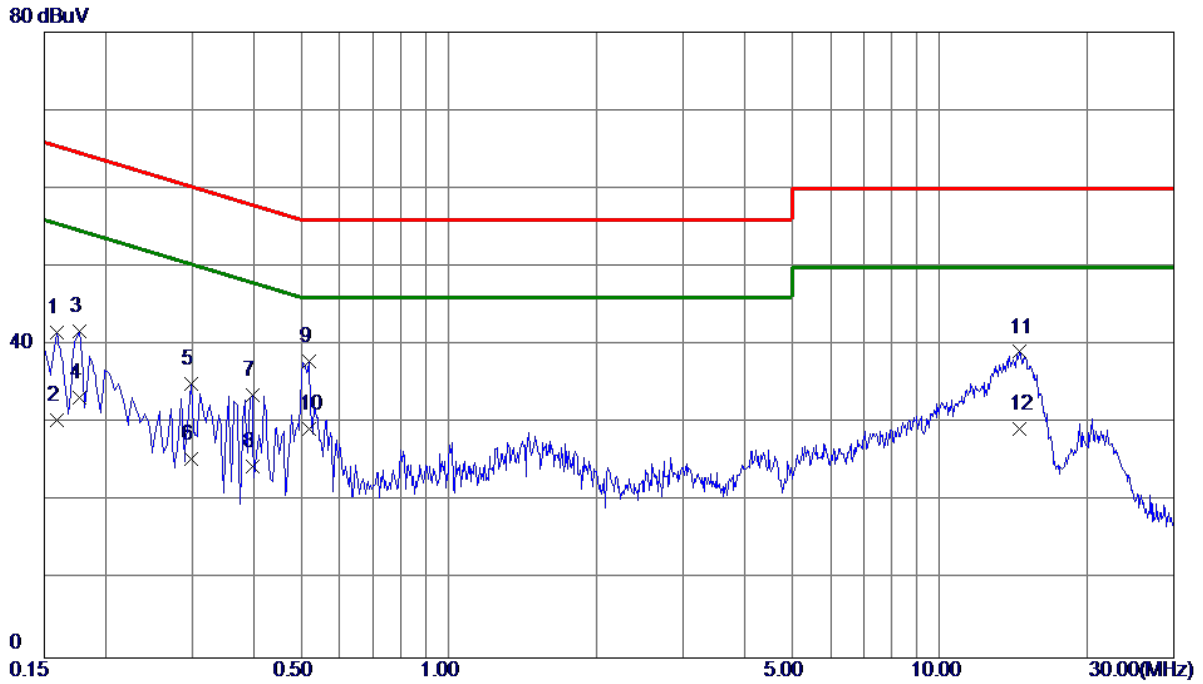

No.	Freq. MHz	Reading Level dBuV	Correct Factor dB	Measure ment dBuV	Limit dBuV	Margin dB	Detector
1	0.1590	31.84	9.82	41.66	65.52	-23.86	QP
2	0.1590	20.60	9.82	30.42	55.52	-25.10	AVG
3	0.1770	32.01	9.82	41.83	64.63	-22.80	QP
4	0.1770	23.41	9.82	33.23	54.63	-21.40	AVG
5	0.2985	25.27	9.82	35.09	60.28	-25.19	QP
6	0.2985	15.60	9.82	25.42	50.28	-24.86	AVG
7	0.3975	23.84	9.81	33.65	57.91	-24.26	QP
8	0.3975	14.70	9.81	24.51	47.91	-23.40	AVG
9	0.5190	28.17	9.80	37.97	56.00	-18.03	QP
10 *	0.5190	19.50	9.80	29.30	46.00	-16.70	AVG
11	14.5590	28.39	10.73	39.12	60.00	-20.88	QP
12	14.5590	18.60	10.73	29.33	50.00	-20.67	AVG

EUT	Smart Phone	Model Name	HRY-LX2
Temperature	25°C	Relative Humidity	53%
Test Voltage	AC 120V/60Hz	Phase	Neutral
Test Mode	Adapter+Traffic(LTE)		
Test Engineer	Simon		

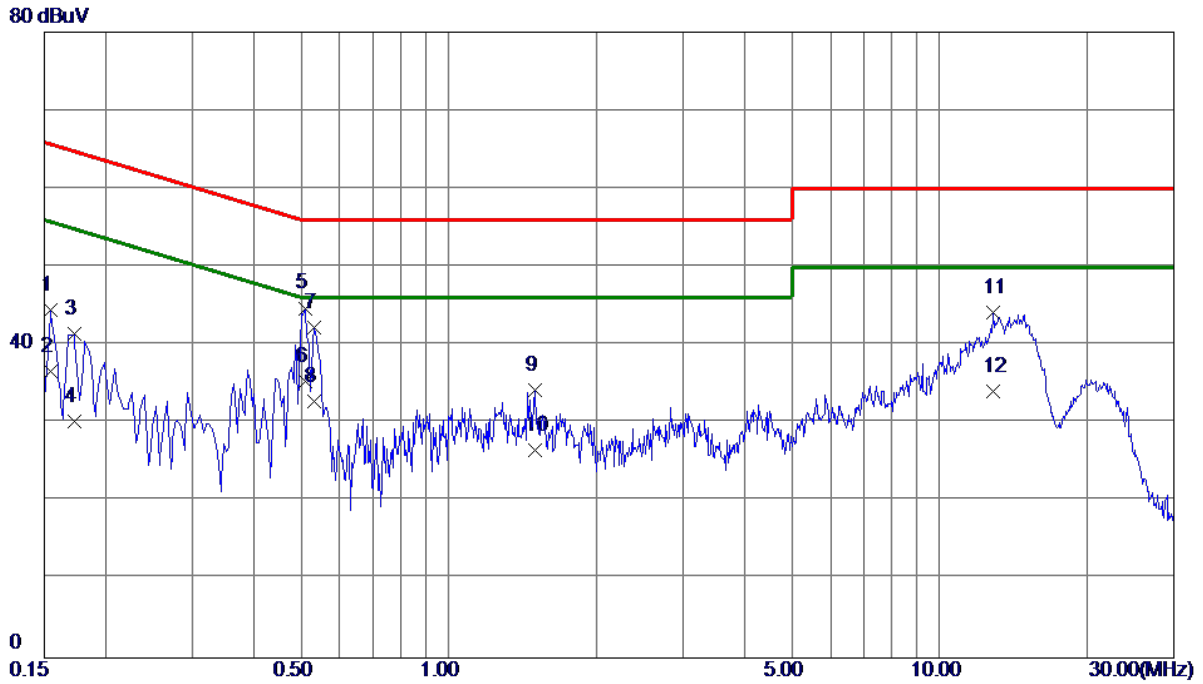

No.	Freq. MHz	Reading Level dBuV	Correct Factor dB	Measure ment dBuV	Limit dBuV	Margin dB	Detector
1	0.1545	34.52	9.91	44.43	65.75	-21.32	QP
2	0.1545	26.80	9.91	36.71	55.75	-19.04	AVG
3	0.1725	31.49	9.91	41.40	64.84	-23.44	QP
4	0.1725	20.40	9.91	30.31	54.84	-24.53	AVG
5	0.5100	34.78	9.94	44.72	56.00	-11.28	QP
6 *	0.5100	25.40	9.94	35.34	46.00	-10.66	AVG
7	0.5325	32.34	9.95	42.29	56.00	-13.71	QP
8	0.5325	22.80	9.95	32.75	46.00	-13.25	AVG
9	1.4955	24.13	10.15	34.28	56.00	-21.72	QP
10	1.4955	16.40	10.15	26.55	46.00	-19.45	AVG
11	12.8535	33.17	10.94	44.11	60.00	-15.89	QP
12	12.8535	23.20	10.94	34.14	50.00	-15.86	AVG



EUT	Smart Phone	Model Name	HRY-LX2
Temperature	25°C	Relative Humidity	53%
Test Voltage	AC 120V/60Hz	Phase	Line
Test Mode	FM 98MHz		
Test Engineer	Simon		

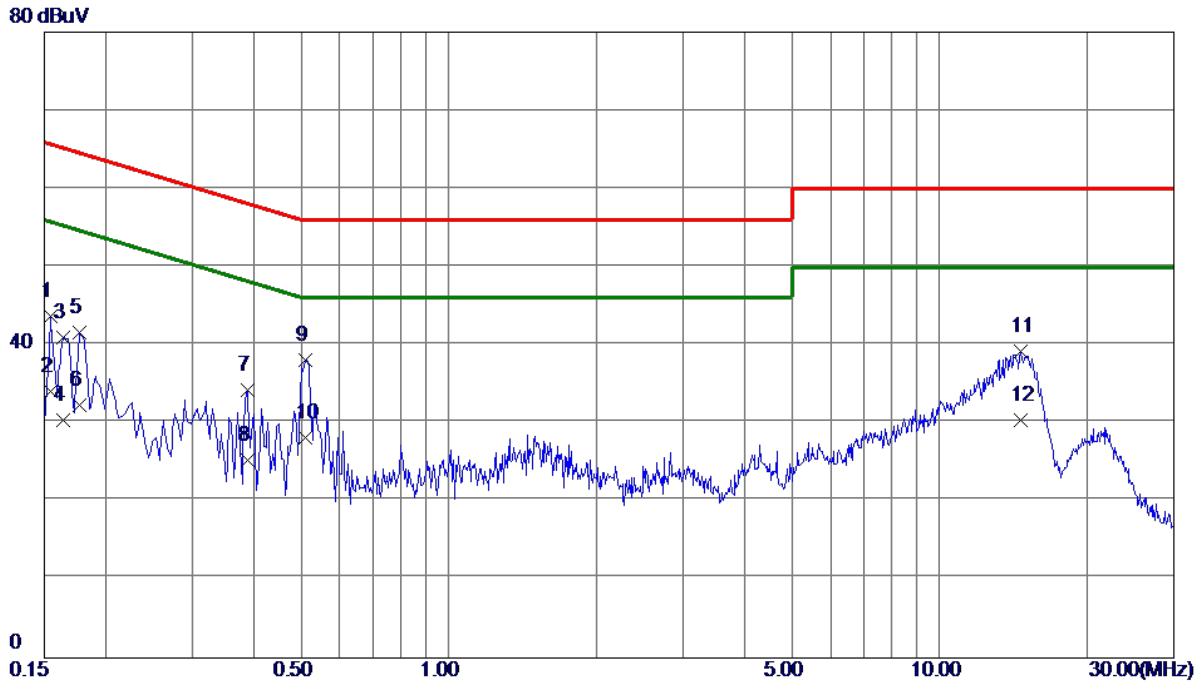

No.	Freq. MHz	Reading Level dBuV	Correct Factor dB	Measure ment dBuV	Limit dBuV	Margin dB	Detector
1	0.1545	33.83	9.82	43.65	65.75	-22.10	QP
2	0.1545	24.30	9.82	34.12	55.75	-21.63	AVG
3	0.1635	31.13	9.82	40.95	65.28	-24.33	QP
4	0.1635	20.60	9.82	30.42	55.28	-24.86	AVG
5	0.1770	31.78	9.82	41.60	64.63	-23.03	QP
6	0.1770	22.51	9.82	32.33	54.63	-22.30	AVG
7	0.3885	24.41	9.81	34.22	58.10	-23.88	QP
8	0.3885	15.40	9.81	25.21	48.10	-22.89	AVG
9	0.5100	28.32	9.79	38.11	56.00	-17.89	QP
10 *	0.5100	18.40	9.79	28.19	46.00	-17.81	AVG
11	14.6715	28.43	10.73	39.16	60.00	-20.84	QP
12	14.6715	19.70	10.73	30.43	50.00	-19.57	AVG

EUT	Smart Phone	Model Name	HRY-LX2
Temperature	25°C	Relative Humidity	53%
Test Voltage	AC 120V/60Hz	Phase	Neutral
Test Mode	FM 98MHz		
Test Engineer	Simon		

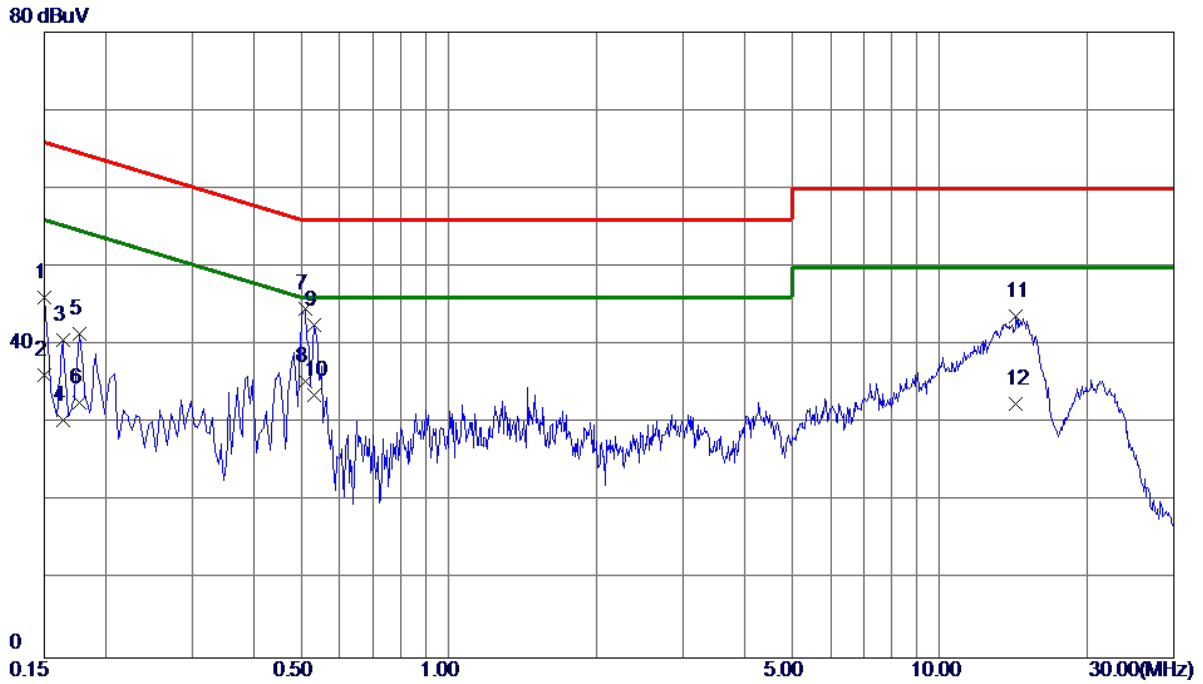

No.	Freq. MHz	Reading Level dBuV	Correct Factor dB	Measure ment dBuV	Limit dBuV	Margin dB	Detector
1	0.1500	36.23	9.91	46.14	66.00	-19.86	QP
2	0.1500	26.30	9.91	36.21	56.00	-19.79	AVG
3	0.1635	30.77	9.91	40.68	65.28	-24.60	QP
4	0.1635	20.50	9.91	30.41	55.28	-24.87	AVG
5	0.1770	31.53	9.91	41.44	64.63	-23.19	QP
6	0.1770	22.71	9.91	32.62	54.63	-22.01	AVG
7	0.5100	34.69	9.94	44.63	56.00	-11.37	QP
8 *	0.5100	25.40	9.94	35.34	46.00	-10.66	AVG
9	0.5325	32.61	9.95	42.56	56.00	-13.44	QP
10	0.5325	23.60	9.95	33.55	46.00	-12.45	AVG
11	14.3115	32.64	11.04	43.68	60.00	-16.32	QP
12	14.3115	21.40	11.04	32.44	50.00	-17.56	AVG

EUT	Smart Phone	Model Name	HRY-LX2
Temperature	25°C	Relative Humidity	53%
Test Voltage	AC 120V/60Hz	Phase	Line
Test Mode	USB Copy + Idle		
Test Engineer	Simon		

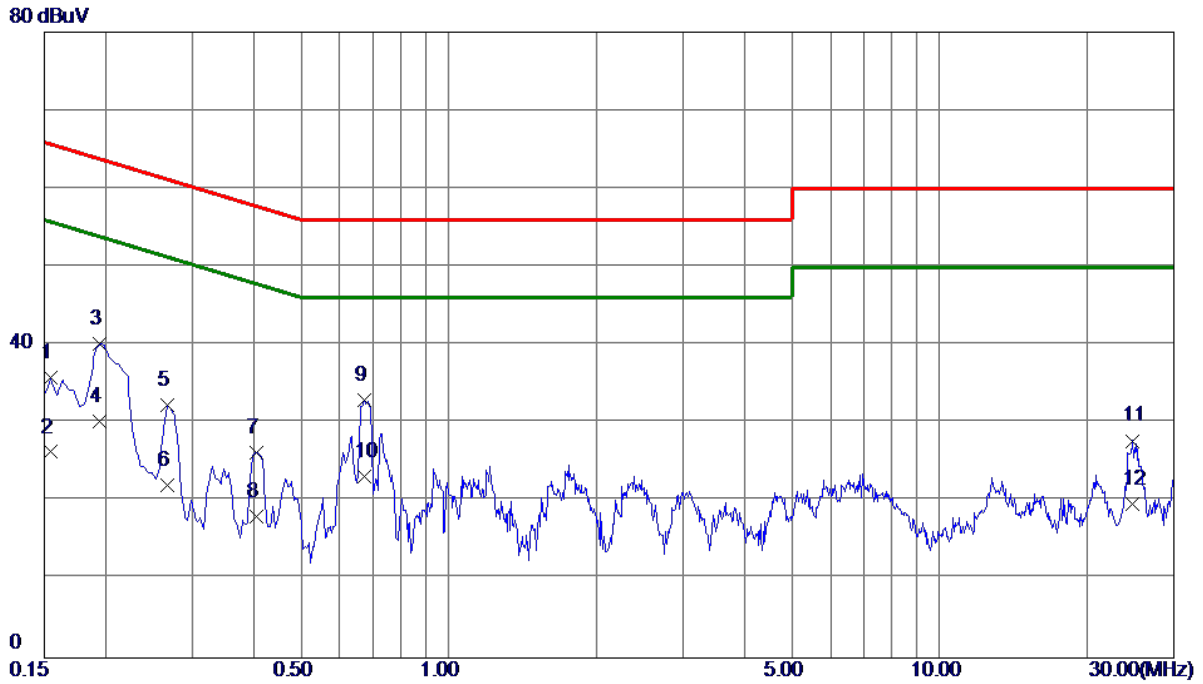

No.	Freq. MHz	Reading Level dBuV	Correct Factor dB	Measure ment dBuV	Limit dBuV	Margin dB	Detector
1	0.1545	25.99	9.82	35.81	65.75	-29.94	QP
2	0.1545	16.50	9.82	26.32	55.75	-29.43	AVG
3	0.1949	30.39	9.82	40.21	63.83	-23.62	QP
4	0.1949	20.40	9.82	30.22	53.83	-23.61	AVG
5	0.2670	22.51	9.82	32.33	61.21	-28.88	QP
6	0.2670	12.30	9.82	22.12	51.21	-29.09	AVG
7	0.4065	16.43	9.81	26.24	57.72	-31.48	QP
8	0.4065	8.20	9.81	18.01	47.72	-29.71	AVG
9	0.6720	23.13	9.86	32.99	56.00	-23.01	QP
10 *	0.6720	13.40	9.86	23.26	46.00	-22.74	AVG
11	24.6795	16.63	11.13	27.76	60.00	-32.24	QP
12	24.6795	8.50	11.13	19.63	50.00	-30.37	AVG

EUT	Smart Phone	Model Name	HRY-LX2
Temperature	25°C	Relative Humidity	53%
Test Voltage	AC 120V/60Hz	Phase	Neutral
Test Mode	USB Copy + Idle		
Test Engineer	Simon		

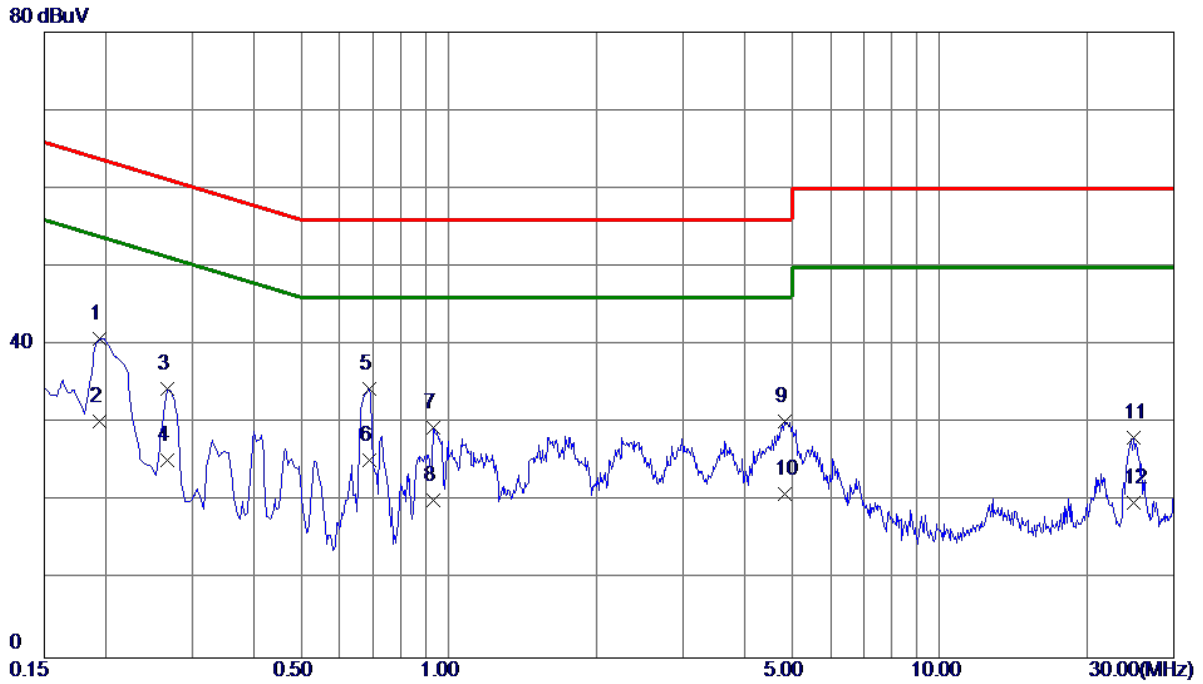

No.	Freq. MHz	Reading Level dBuV	Correct Factor dB	Measure ment dBuV	Limit dBuV	Margin dB	Detector
1	0.1949	30.90	9.91	40.81	63.83	-23.02	QP
2	0.1949	20.30	9.91	30.21	53.83	-23.62	AVG
3	0.2670	24.52	9.92	34.44	61.21	-26.77	QP
4	0.2670	15.41	9.92	25.33	51.21	-25.88	AVG
5	0.6900	24.37	10.03	34.40	56.00	-21.60	QP
6 *	0.6900	15.31	10.03	25.34	46.00	-20.66	AVG
7	0.9330	19.40	10.10	29.50	56.00	-26.50	QP
8	0.9330	10.01	10.10	20.11	46.00	-25.89	AVG
9	4.8255	19.88	10.39	30.27	56.00	-25.73	QP
10	4.8255	10.59	10.39	20.98	46.00	-25.02	AVG
11	24.8595	16.73	11.48	28.21	60.00	-31.79	QP
12	24.8595	8.41	11.48	19.89	50.00	-30.11	AVG

## 4.2 RADIATED EMISSION MEASUREMENT

### 4.2.1 LIMITS OF RADIATED EMISSION MEASUREMENT

#### Below 1 GHz

##### Measurement Method and Applied Limits:

##### ANSI C63.4:

Frequency (MHz)	Class A (at 10m)		Class B (at 3m)	
	(uV/m) Field strength	(dBuV/m) Field strength	(uV/m) Field strength	(dBuV/m) Field strength
30 - 88	90	39	100	40
88 - 216	150	43.5	150	43.5
216 - 960	210	46.4	200	46
Above 960	300	49.5	500	54

#### Above 1 GHz

##### Measurement Method and Applied Limits:

##### ANSI C63.4:

Frequency (MHz)	Class A				Class B	
	(dBuV/m) (at 3m)		(dBuV/m) (at 10m)		(dBuV/m) (at 3m)	
	Peak	Average	Peak	Average	Peak	Average
Above 1000	80	60	69.5	49.5	74	54

### FREQUENCY RANGE OF RADIATED MEASUREMENT (FOR UNINTENTIONAL RADIATORS)

Highest frequency generated or Upper frequency of measurement used in the device or on which the device operates or tunes (MHz)	Range (MHz)
Below 1.705	30
1.705 - 108	1000
108 - 500	2000
500 - 1000	5000
Above 1000	5 <sup>th</sup> harmonic of the highest frequency or 40 GHz, whichever is lower

#### NOTE:

- (1) The limit for radiated test was performed according to as following:  
FCC Part 15, Subpart B
- (2) The tighter limit applies at the band edges.
- (3) Emission level (dBuV/m) = 20log Emission level (uV/m).  
3m Emission level = 10m Emission level + 20log(10m/3m).
- (4) The test result calculated as following:  
Measurement Value = Reading Level + Correct Factor  
Correct Factor = Antenna Factor + Cable Loss - Amplifier Gain(if use)  
Margin Level = Measurement Value - Limit Value

#### 4.2.2 MEASUREMENT INSTRUMENTS LIST

##### Below 1GHz:

Item	Kind of Equipment	Manufacturer	Type No.	Serial No.	Calibrated until
1	Receiver	Keysight	N9038A	MY54450004	Aug. 11, 2019
2	Pre-Amplifier	Mini-Circuits	EMC 9135	980284	Mar. 11, 2019
3	Pre-Amplifier	Mini-Circuits	EMC 9135	980283	Mar. 11, 2019
4	Trilog-Broadband Antenna	Schwarzbeck	VULB9168	586	Nov. 09, 2018
5	Trilog-Broadband Antenna	Schwarzbeck	VULB9168	587	Jan. 04, 2019
6	Cable	emci	LMR-400(5m+11m+15m)	N/A	Jan. 11, 2019
7	Cable	emci	LMR-400(5m+8m+15m)	N/A	Jan. 11, 2019
8	Measurement Software	Farad	EZ-EMC Ver.BTL-2ANT-1	N/A	N/A
9	Multi-Device Controller	ETS-Lindgren	2090	N/A	N/A
10	Attenuator	SHX	TS2-6dB-6G-A	16101101	Nov. 09, 2018
11	Attenuator	SHX	TS2-6dB-6G-A	16101102	Jan. 04, 2019

Remark: "N/A" denotes no model name, no serial no. or no calibration specified.  
All calibration period of equipment list is one year.

##### Above 1GHz:

Item	Kind of Equipment	Manufacturer	Type No.	Serial No.	Calibrated until
1	Horn Antenna	EMCO	3115	9605-4803	Mar. 11, 2019
2	Amplifier	Agilent	8449B	3008A02584	Aug. 11, 2019
3	MXE EMI Receiver	Agilent	N9038A	MY53220133	Mar. 11, 2019
4	Measurement Software	Farad	EZ-EMC Ver.BTL-2ANT-1	N/A	N/A
5	Cable	Mlcable Inc.	B10-01-01-15M (10MHz~26.5GHz)	18047122	May. 25, 2019
6	Multi-Device Controller	ETS-Lindgren	2090	N/A	N/A
7	Controller	MF	MF-7802	MF780208159	N/A
8	Cable	Mlcable Inc.	B10-01-01-5M (10MHz~26.5GHz)	18047123	May. 25, 2019

Remark: "N/A" denotes no model name, no serial no. or no calibration specified.  
All calibration period of equipment list is one year.

#### 4.2.3 TEST PROCEDURE

- a. The measuring distance of 3 m shall be used for measurements. The EUT was placed on the top of a rotating table 0.8 meter above the ground at a 10 meter semi-anechoic chamber. The table was rotated 360 degrees to determine the position of the highest radiation.(below 1 GHz)
- b. The measuring distance of 3 m shall be used for measurements. The EUT was placed on the top of a rotating table 0.8 meter above the ground at a 10 meter semi-anechoic chamber. The table was rotated 360 degrees to determine the position of the highest radiation.(above 1 GHz)
- c. The height of the equipment or of the substitution antenna shall be 0.8 m, the height of the test antenna shall vary between 1 m to 4 m. Both horizontal and vertical polarizations of the antenna are set to make the measurement.
- d. For each suspected emission, the EUT was arranged to its worst case and then the antenna was tuned to heights find the maximum reading (used Bore sight function).
- e. The receiver system was set to peak and average detect function and specified bandwidth with maximum hold mode when the test frequency is above 1 GHz.
- f. The initial step in collecting radiated emission data is a receiver peak detector mode pre-scanning the measurement frequency range. Significant peaks are then marked and then Quasi Peak detector mode re-measured.
- g. All readings are Peak unless otherwise stated QP in column of Note. Peak denotes that the Peak reading compliance with the QP Limits and then QP Mode measurement didn't perform. (below 1GHz)
- h. All readings are Peak Mode value unless otherwise stated AVG in column of Note. If the Peak Mode Measured value compliance with the Peak Limits and lower than AVG Limits, the EUT shall be deemed to meet both Peak & AVG Limits and then only Peak Mode was measured, but AVG Mode didn't perform. (above 1 GHz)
- i. For the actual test configuration, please refer to the related Item - Block Diagram of system tested (please refer to 3.3).

#### 4.2.4 DEVIATION FROM TEST STANDARD

No deviation

### 4.2.5 TEST SETUP

#### (A) Radiated Emission Test Set-Up Frequency Below 1 GHz

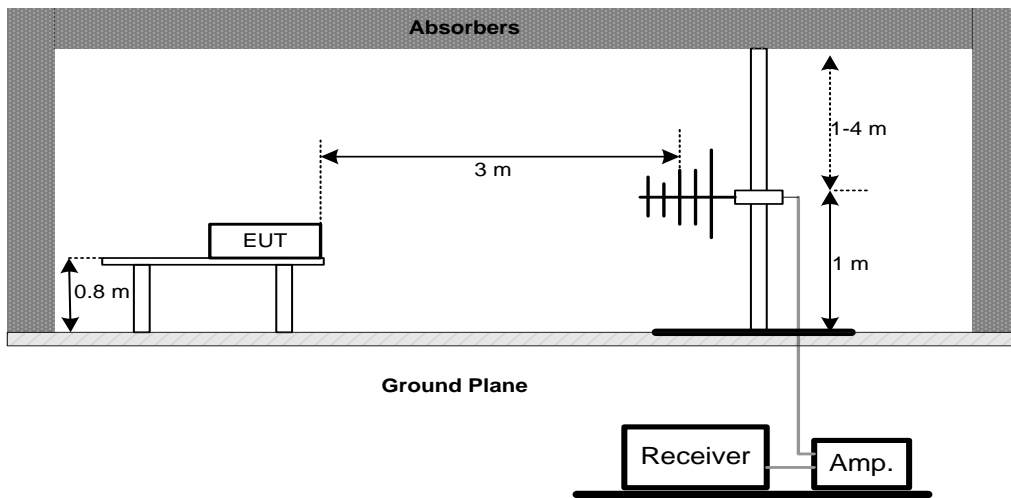

#### (B) Radiated Emission Test Set-Up Frequency 1 - 18 GHz

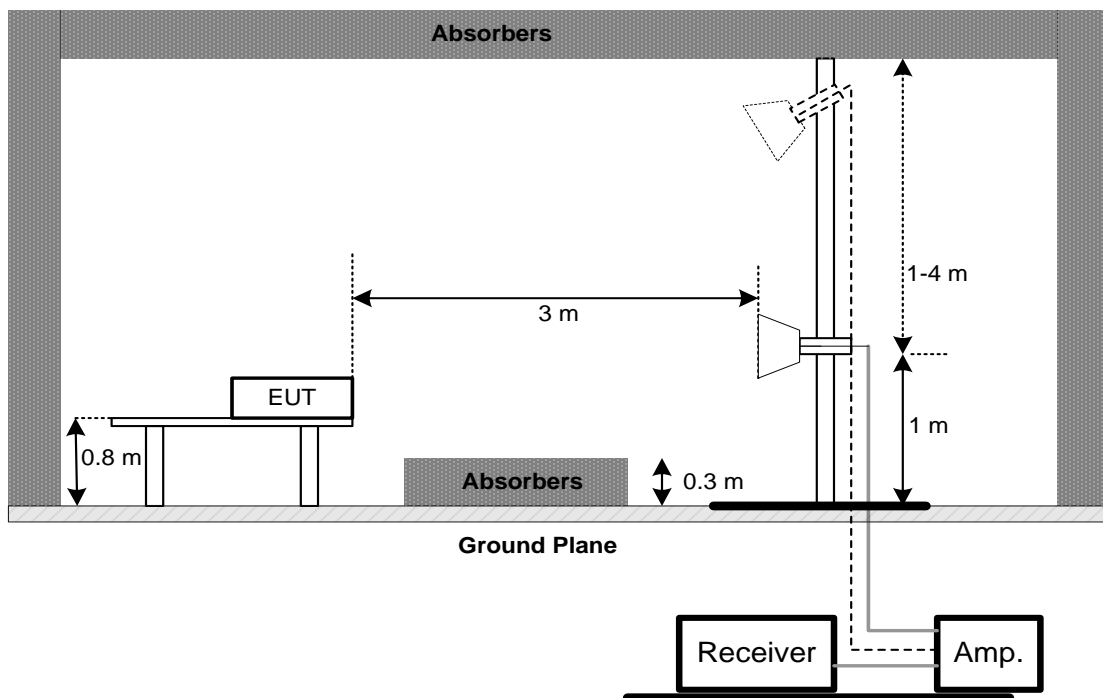

### 4.2.6 TEST RESULTS-BELOW 1 GHZ

Remark :

- (1) All readings are Peak unless otherwise stated QP in column of 『 Note 』 . Peak denotes that the Peak reading compliance with the QP Limits and then QP Mode measurement didn't perform.
- (2) Measuring frequency range from 30 MHz to 1000 MHz
- (3) If the peak scan value lower limit more than 20 dB, then this signal data does not show in table.



EUT	Smart Phone	Model Name	HRY-LX2
Temperature	25°C	Relative Humidity	60%
Test Voltage	AC 120V/60Hz	Polarization	Vertical
Test Mode	Adapter+ Idle+Playing+Speaker		
Test Engineer	Simon		

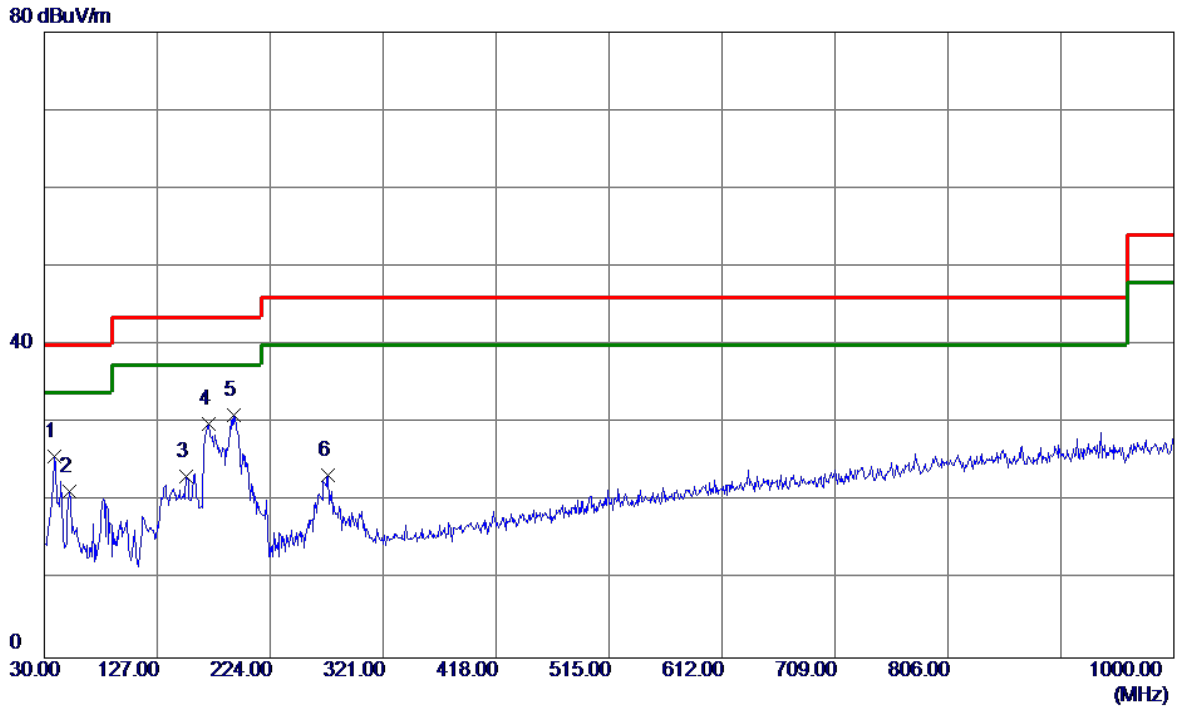

No.	Freq. MHz	Reading Level dBuV/m	Correct Factor dB	Measurement dBuV/m	Limit dBuV/m	Margin dB	Detector
1	38.7300	43.92	-18.10	25.82	40.00	-14.18	QP
2	51.3400	38.32	-17.02	21.30	40.00	-18.70	QP
3	152.2200	39.55	-16.40	23.15	43.50	-20.35	QP
4	171.1350	46.90	-16.91	29.99	43.50	-13.51	QP
5 *	192.4750	49.33	-18.36	30.97	43.50	-12.53	QP
6	273.9549	39.22	-15.81	23.41	46.00	-22.59	QP

EUT	Smart Phone	Model Name	HRY-LX2
Temperature	25°C	Relative Humidity	60%
Test Voltage	AC 120V/60Hz	Polarization	Horizontal
Test Mode	Adapter+ Idle+Playing+Speaker		
Test Engineer	Simon		

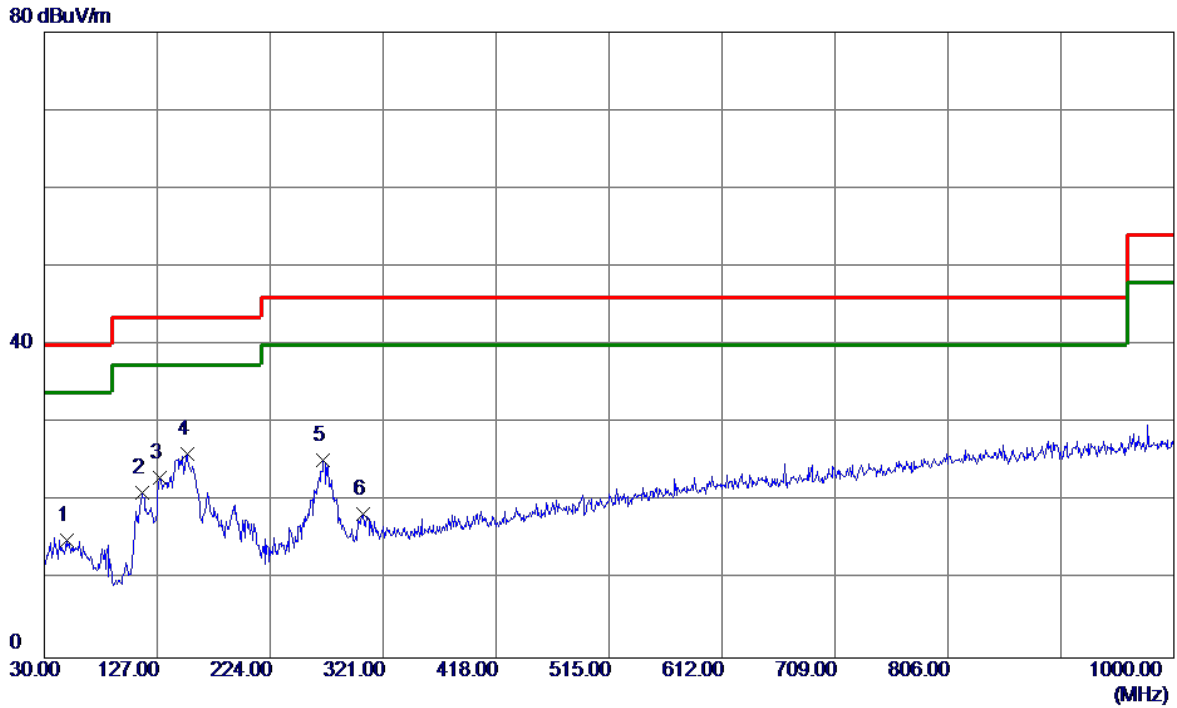

No.	Freq. MHz	Reading Level dBuV/m	Correct Factor dB	Measure ment dBuV/m	Limit dBuV/m	Margin dB	Detector
1	48.9150	32.12	-17.06	15.06	40.00	-24.94	QP
2	113.9050	40.65	-19.53	21.12	43.50	-22.38	QP
3	129.4250	40.82	-17.85	22.97	43.50	-20.53	QP
4 *	152.7050	42.52	-16.39	26.13	43.50	-17.37	QP
5	269.5900	41.36	-16.04	25.32	46.00	-20.68	QP
6	303.5400	33.45	-15.02	18.43	46.00	-27.57	QP

EUT	Smart Phone	Model Name	HRY-LX2
Temperature	25°C	Relative Humidity	60%
Test Voltage	AC 120V/60Hz	Polarization	Vertical
Test Mode	Adapter+ Idle+Playing+earphone		
Test Engineer	Simon		

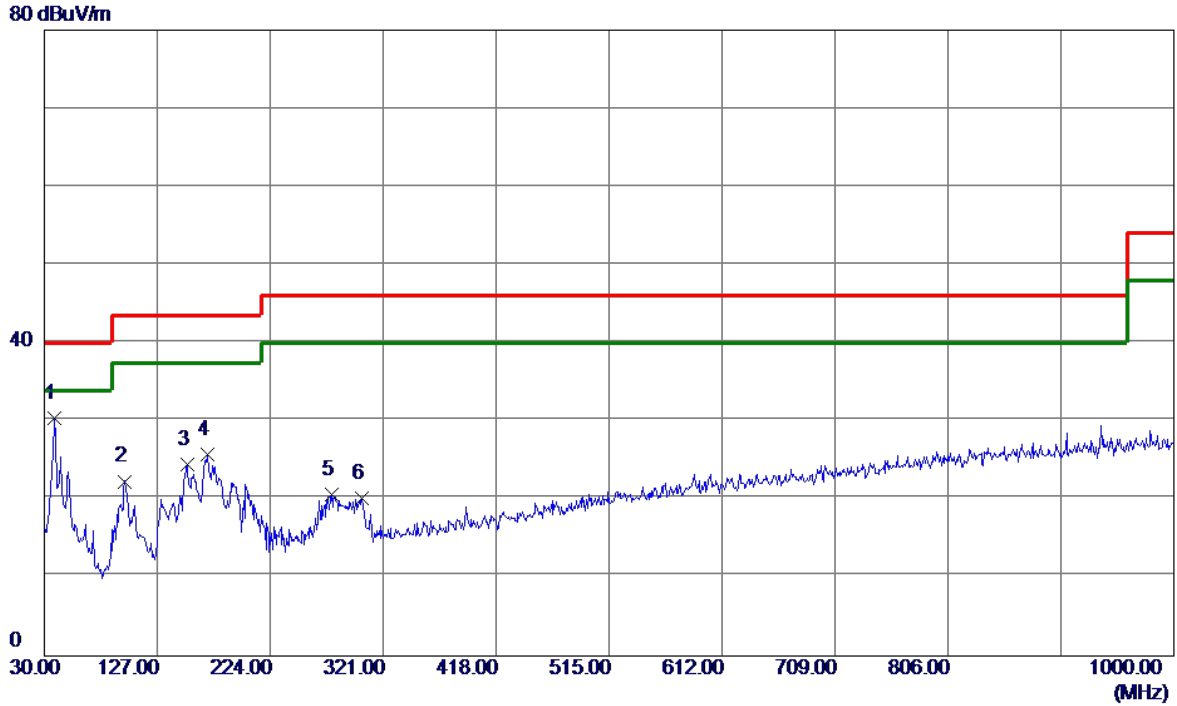

No.	Freq. MHz	Reading Level dBuV/m	Correct Factor dB	Measure ment dBuV/m	Limit dBuV/m	Margin dB	Detector
1 *	38.7300	48.53	-18.10	30.43	40.00	-9.57	QP
2	99.3550	43.44	-21.12	22.32	43.50	-21.18	QP
3	152.7050	40.89	-16.39	24.50	43.50	-19.00	QP
4	169.6799	42.60	-16.82	25.78	43.50	-17.72	QP
5	276.8650	36.35	-15.65	20.70	46.00	-25.30	QP
6	302.5700	35.18	-15.04	20.14	46.00	-25.86	QP

EUT	Smart Phone	Model Name	HRY-LX2
Temperature	25°C	Relative Humidity	60%
Test Voltage	AC 120V/60Hz	Polarization	Horizontal
Test Mode	Adapter+ Idle+Playing+earphone		
Test Engineer	Simon		

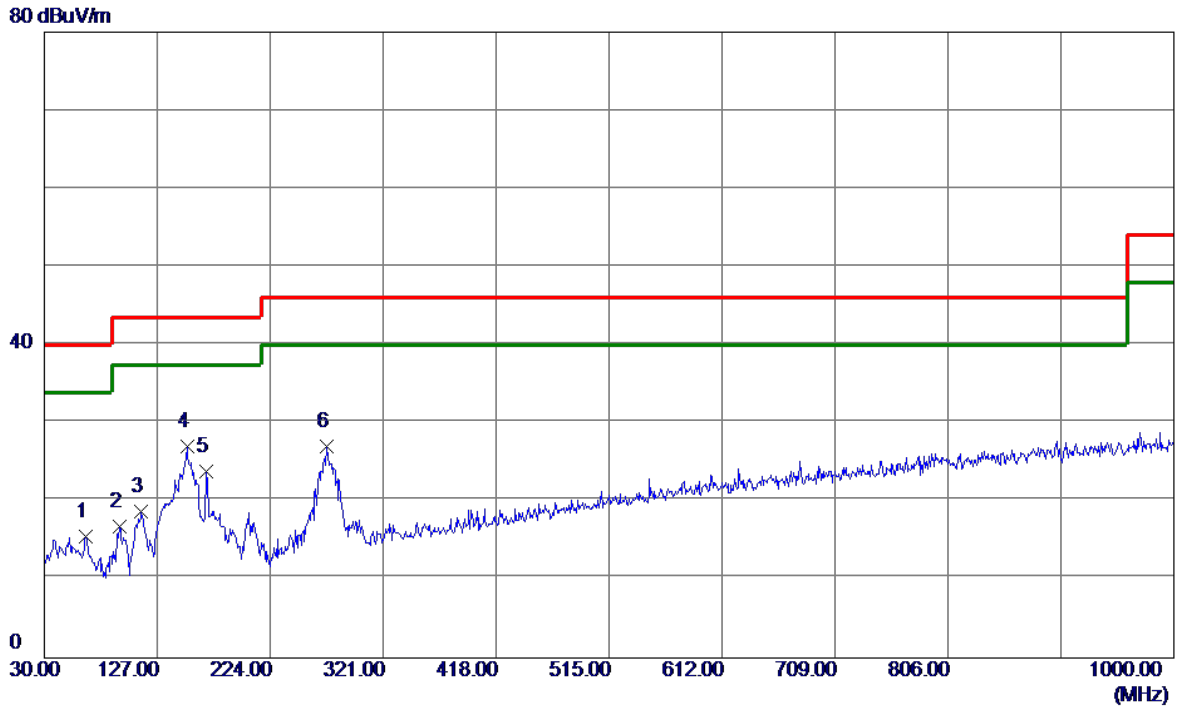

No.	Freq. MHz	Reading Level dBuV/m	Correct Factor dB	Measure ment dBuV/m	Limit dBuV/m	Margin dB	Detector
1	65.8900	33.56	-18.08	15.48	40.00	-24.52	QP
2	94.5050	38.49	-21.62	16.87	43.50	-26.63	QP
3	113.4200	38.37	-19.59	18.78	43.50	-24.72	QP
4 *	152.7050	43.39	-16.39	27.00	43.50	-16.50	QP
5	169.1950	40.60	-16.79	23.81	43.50	-19.69	QP
6	272.5000	42.89	-15.89	27.00	46.00	-19.00	QP

EUT	Smart Phone	Model Name	HRY-LX2
Temperature	25°C	Relative Humidity	60%
Test Voltage	AC 120V/60Hz	Polarization	Vertical
Test Mode	Adapter+Idle+2.4G WIFI+BT+GPS+Camera on(Front)		
Test Engineer	Simon		

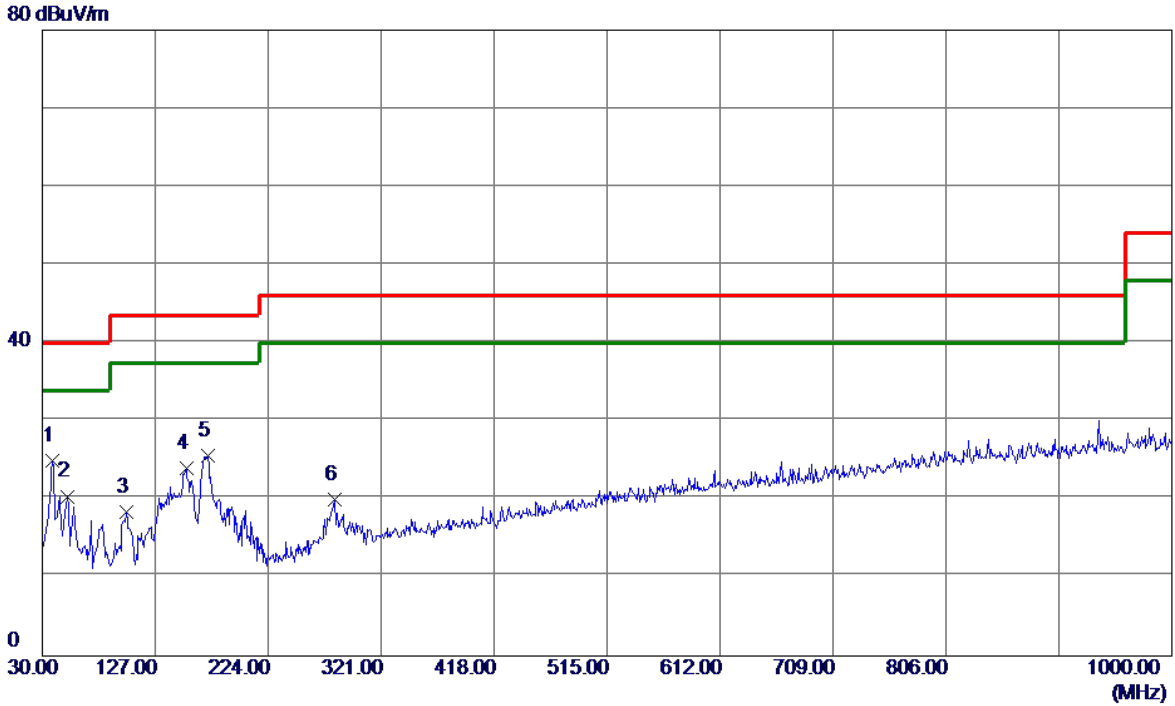

No.	Freq. MHz	Reading Level dBuV/m	Correct Factor dB	Measure ment dBuV/m	Limit dBuV/m	Margin dB	Detector
1 *	38.7300	43.03	-18.10	24.93	40.00	-15.07	QP
2	51.8250	37.44	-17.04	20.40	40.00	-19.60	QP
3	101.7800	39.26	-20.86	18.40	43.50	-25.10	QP
4	153.6750	40.43	-16.37	24.06	43.50	-19.44	QP
5	172.1050	42.53	-16.97	25.56	43.50	-17.94	QP
6	280.7450	35.41	-15.47	19.94	46.00	-26.06	QP

EUT	Smart Phone	Model Name	HRY-LX2
Temperature	25°C	Relative Humidity	60%
Test Voltage	AC 120V/60Hz	Polarization	Horizontal
Test Mode	Adapter+Idle+2.4G WIFI+BT+GPS+Camera on(Front)		
Test Engineer	Simon		

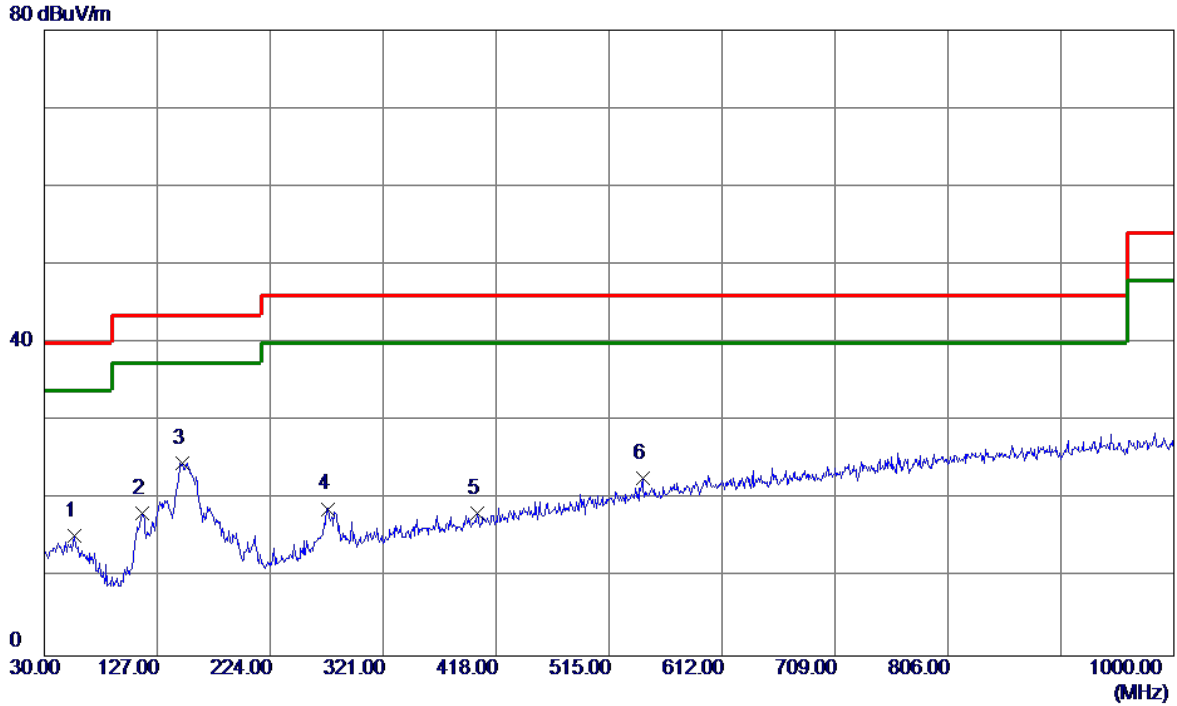

No.	Freq. MHz	Reading Level dBuV/m	Correct Factor dB	Measure ment dBuV/m	Limit dBuV/m	Margin dB	Detector
1	55.7050	32.60	-17.21	15.39	40.00	-24.61	QP
2	114.3900	37.73	-19.48	18.25	43.50	-25.25	QP
3 *	148.8250	41.14	-16.48	24.66	43.50	-18.84	QP
4	273.4700	34.63	-15.83	18.80	46.00	-27.20	QP
5	401.5100	31.09	-12.83	18.26	46.00	-27.74	QP
6	543.6150	32.37	-9.63	22.74	46.00	-23.26	QP

EUT	Smart Phone	Model Name	HRY-LX2
Temperature	25°C	Relative Humidity	60%
Test Voltage	AC 120V/60Hz	Polarization	Vertical
Test Mode	Adapter+Traffic(LTE)		
Test Engineer	Simon		

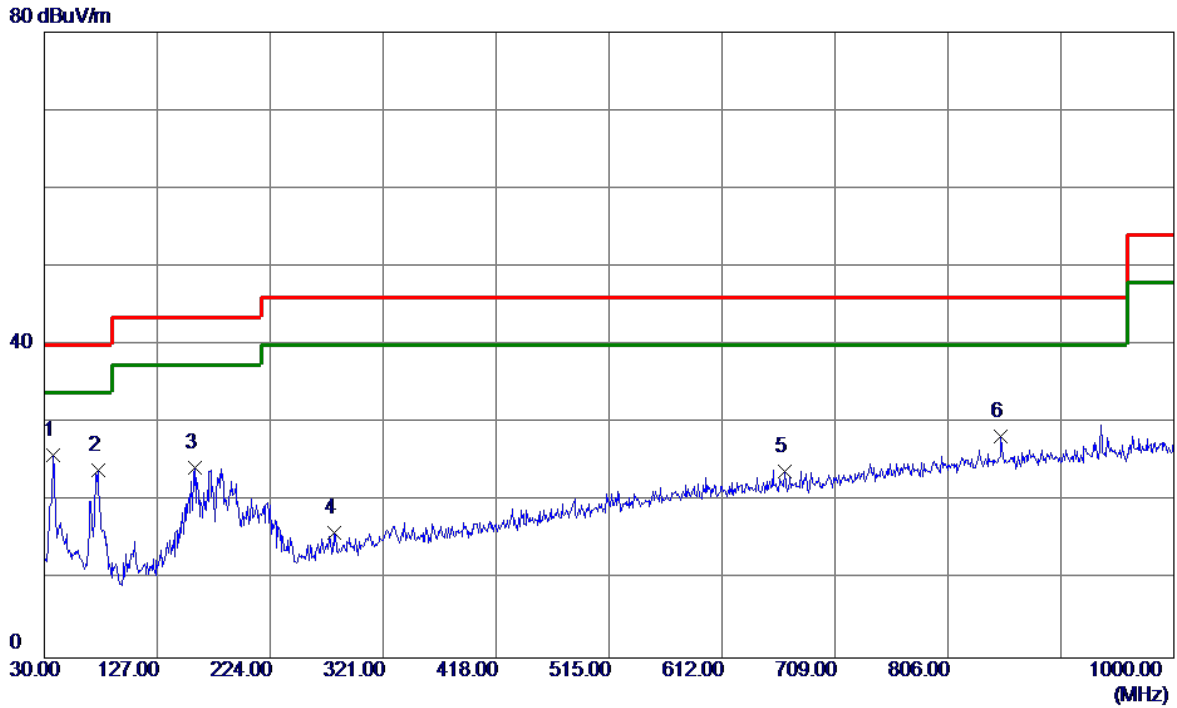

No.	Freq. MHz	Reading Level dBuV/m	Correct Factor dB	Measure ment dBuV/m	Limit dBuV/m	Margin dB	Detector
1 *	37.2750	44.24	-18.28	25.96	40.00	-14.04	QP
2	76.0750	44.06	-20.05	24.01	40.00	-15.99	QP
3	159.4950	40.53	-16.23	24.30	43.50	-19.20	QP
4	278.8050	31.56	-15.54	16.02	46.00	-29.98	QP
5	665.8350	31.59	-7.69	23.90	46.00	-22.10	QP
6	851.5900	33.12	-4.85	28.27	46.00	-17.73	QP

EUT	Smart Phone	Model Name	HRY-LX2
Temperature	25°C	Relative Humidity	60%
Test Voltage	AC 120V/60Hz	Polarization	Horizontal
Test Mode	Adapter+Traffic(LTE)		
Test Engineer	Simon		

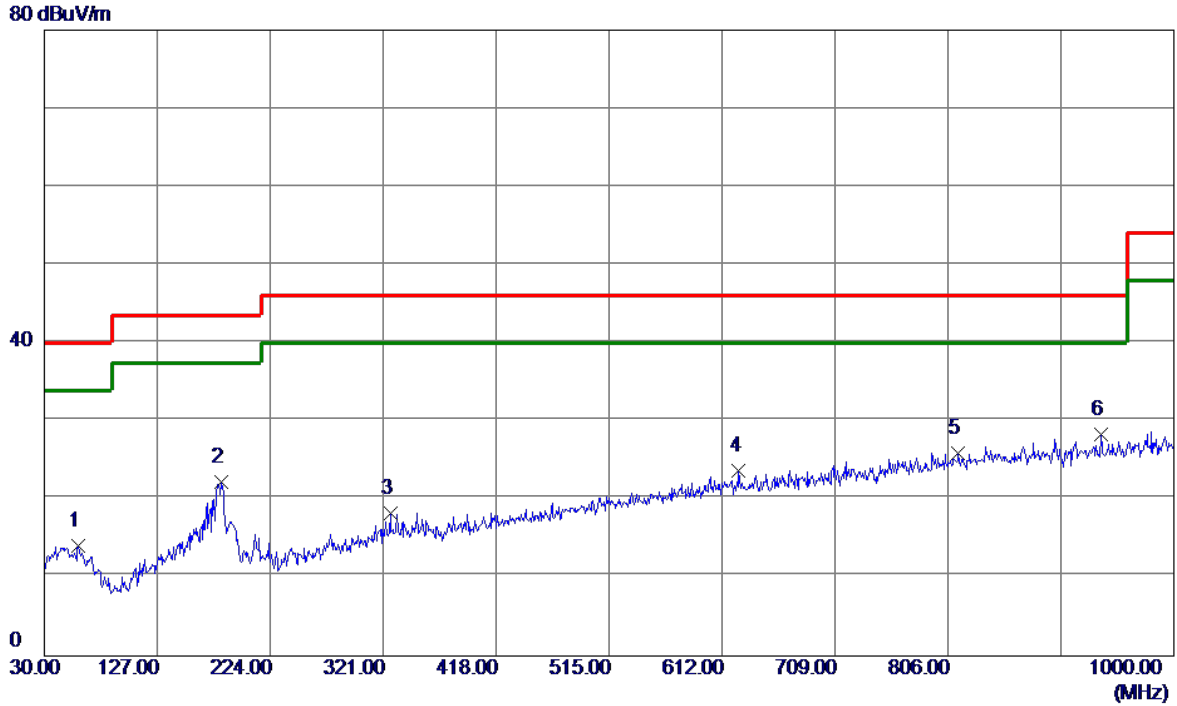

No.	Freq. MHz	Reading Level dBuV/m	Correct Factor dB	Measure ment dBuV/m	Limit dBuV/m	Margin dB	Detector
1	59.1000	31.41	-17.36	14.05	40.00	-25.95	QP
2	182.2899	39.85	-17.62	22.23	43.50	-21.27	QP
3	327.3050	32.73	-14.49	18.24	46.00	-27.76	QP
4	626.5500	31.79	-8.16	23.63	46.00	-22.37	QP
5	814.7300	31.20	-5.27	25.93	46.00	-20.07	QP
6 *	936.9500	32.06	-3.71	28.35	46.00	-17.65	QP



EUT	Smart Phone	Model Name	HRY-LX2
Temperature	25°C	Relative Humidity	60%
Test Voltage	AC 120V/60Hz	Polarization	Vertical
Test Mode	FM 98MHz		
Test Engineer	Simon		

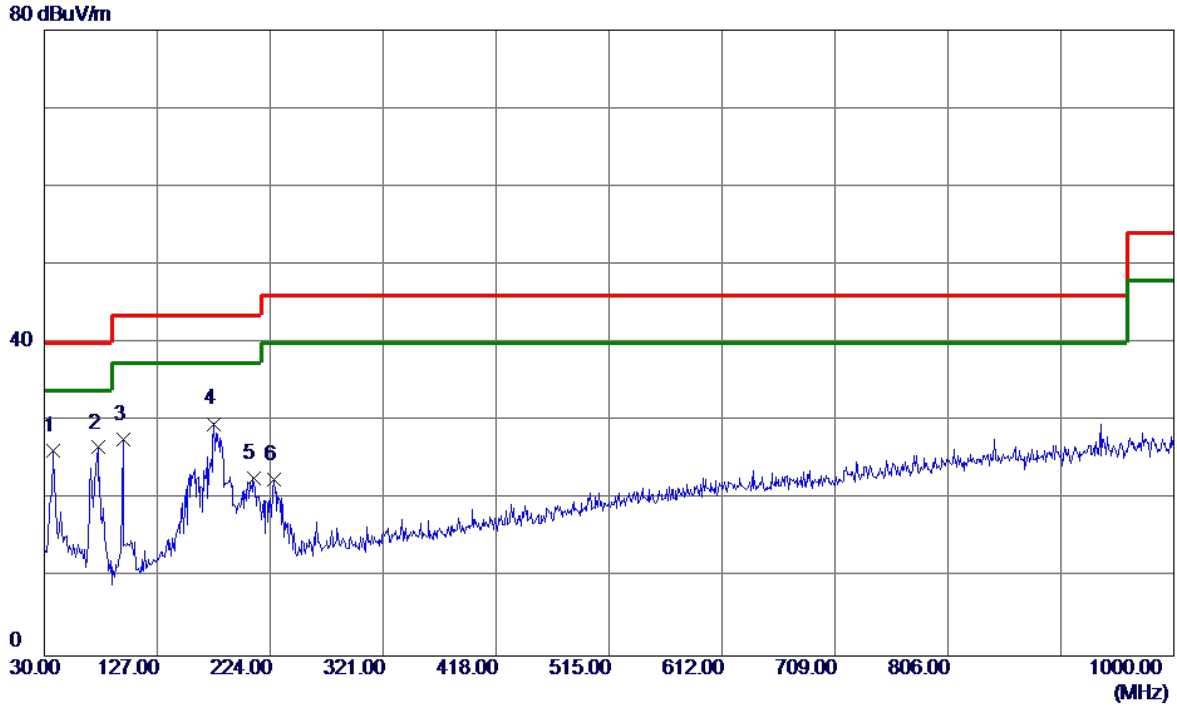

No.	Freq. MHz	Reading Level dBuV/m	Correct Factor dB	Measure ment dBuV/m	Limit dBuV/m	Margin dB	Detector
1	37.2750	44.55	-18.28	26.27	40.00	-13.73	QP
2 *	76.0750	46.69	-20.05	26.64	40.00	-13.36	QP
3	97.4150	49.00	-21.32	27.68	43.50	-15.82	QP
4	175.9850	46.89	-17.21	29.68	43.50	-13.82	QP
5	209.4500	41.63	-18.85	22.78	43.50	-20.72	QP
6	227.3950	40.80	-18.23	22.57	46.00	-23.43	QP

EUT	Smart Phone	Model Name	HRY-LX2
Temperature	25°C	Relative Humidity	60%
Test Voltage	AC 120V/60Hz	Polarization	Horizontal
Test Mode	FM 98MHz		
Test Engineer	Simon		

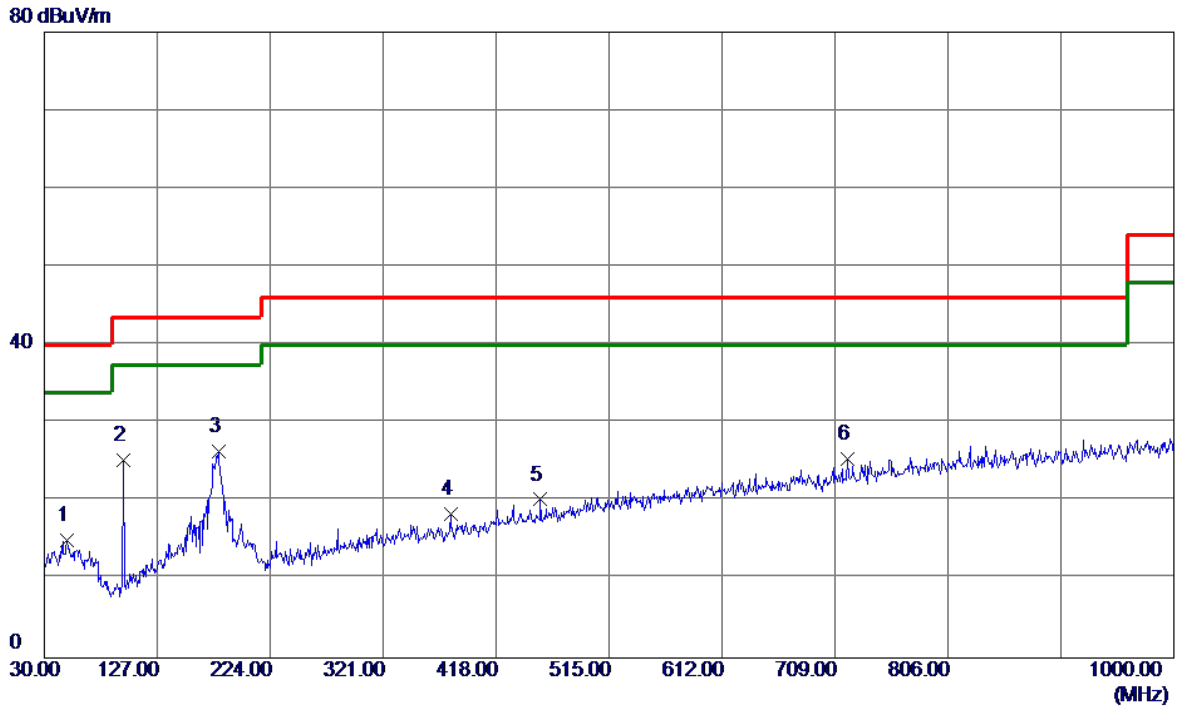

No.	Freq. MHz	Reading Level dBuV/m	Correct Factor dB	Measure ment dBuV/m	Limit dBuV/m	Margin dB	Detector
1	49.8849	32.03	-16.97	15.06	40.00	-24.94	QP
2	98.2400	46.49	-21.23	25.26	43.50	-18.24	QP
3 *	179.3800	43.76	-17.42	26.34	43.50	-17.16	QP
4	378.7150	31.68	-13.34	18.34	46.00	-27.66	QP
5	455.8300	31.80	-11.56	20.24	46.00	-25.76	QP
6	719.6700	32.38	-6.93	25.45	46.00	-20.55	QP

EUT	Smart Phone	Model Name	HRY-LX2
Temperature	25°C	Relative Humidity	60%
Test Voltage	AC 120V/60Hz	Polarization	Vertical
Test Mode	USB Copy + Idle		
Test Engineer	Simon		

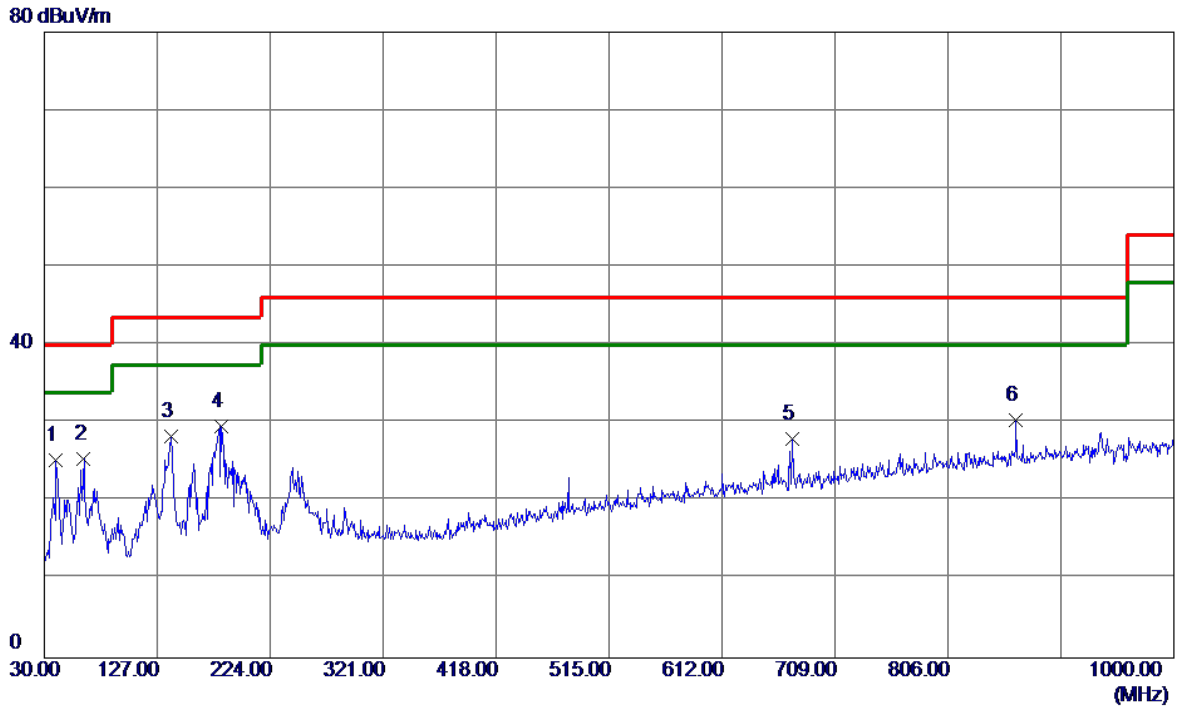

No.	Freq. MHz	Reading Level dBuV/m	Correct Factor dB	Measure ment dBuV/m	Limit dBuV/m	Margin dB	Detector
1	40.1850	43.20	-17.91	25.29	40.00	-14.71	QP
2	63.9500	43.35	-17.86	25.49	40.00	-14.51	QP
3	139.1250	45.08	-16.80	28.28	43.50	-15.22	QP
4 *	182.2899	47.25	-17.62	29.63	43.50	-13.87	QP
5	672.1400	35.55	-7.62	27.93	46.00	-18.07	QP
6	864.2000	35.09	-4.70	30.39	46.00	-15.61	QP

EUT	Smart Phone	Model Name	HRY-LX2
Temperature	25°C	Relative Humidity	60%
Test Voltage	AC 120V/60Hz	Polarization	Horizontal
Test Mode	USB Copy + Idle		
Test Engineer	Simon		

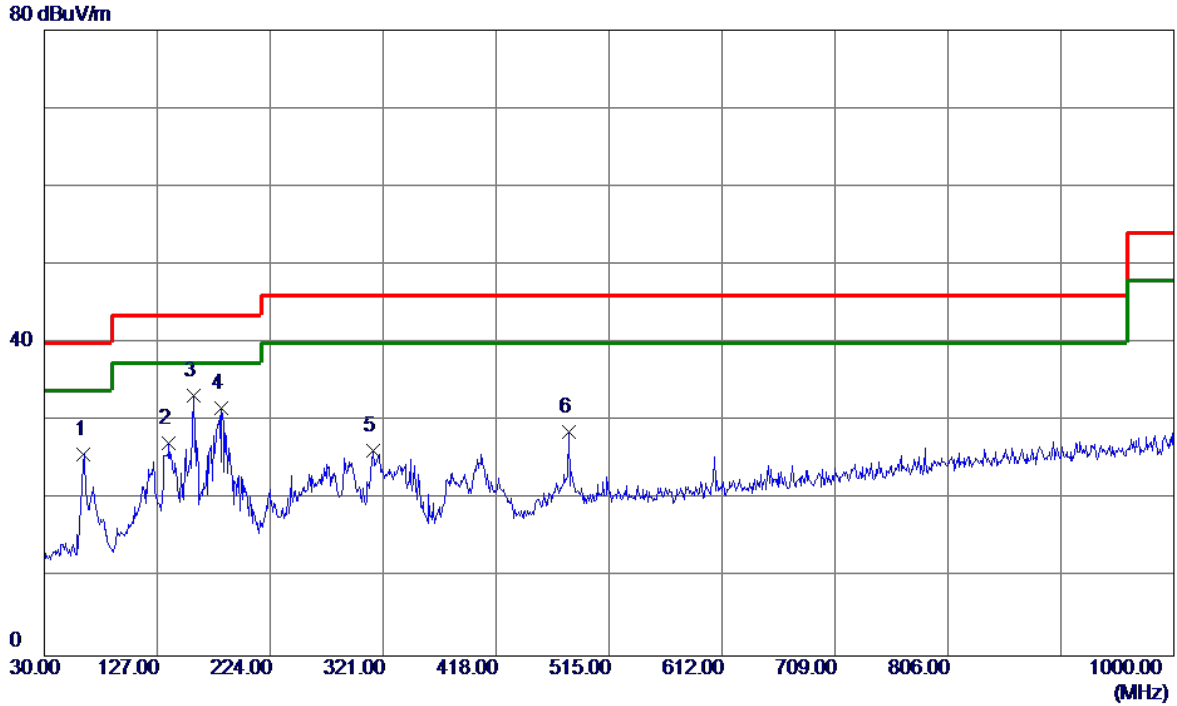

No.	Freq. MHz	Reading Level dBuV/m	Correct Factor dB	Measure ment dBuV/m	Limit dBuV/m	Margin dB	Detector
1	63.9500	43.56	-17.86	25.70	40.00	-14.30	QP
2	136.7000	44.22	-17.06	27.16	43.50	-16.34	QP
3 *	158.0399	49.57	-16.27	33.30	43.50	-10.20	QP
4	182.2899	49.35	-17.62	31.73	43.50	-11.77	QP
5	312.2700	41.13	-14.83	26.30	46.00	-19.70	QP
6	480.0800	39.62	-11.00	28.62	46.00	-17.38	QP

#### 4.2.7 TEST RESULTS-ABOVE 1 GHZ

Remark :

- (1) All readings are Peak unless otherwise stated QP in column of『 Note 』. Peak denotes that the Peak reading compliance with the QP Limits and then QP Mode measurement didn't perform.
- (2) Radiated emissions measured in frequency range above 1000 MHz were made with an instrument using Peak detector mode and AV detector mode of the emission.
- (3) Data of measurement within this frequency range shown “ \* ” in the table above means the reading of emissions are attenuated more than 20 dB below the permissible limits or the field strength is too small to be measured.
- (4) A preamp and high pass filter were used for this test in order to provide sufficient measurement sensitivity.

EUT	Smart Phone	Model Name	HRY-LX2
Temperature	25°C	Relative Humidity	60%
Test Voltage	AC 120V/60Hz	Polarization	Vertical
Test Mode	Adapter+ Idle+Playing+Speaker		
Test Engineer	Simon		

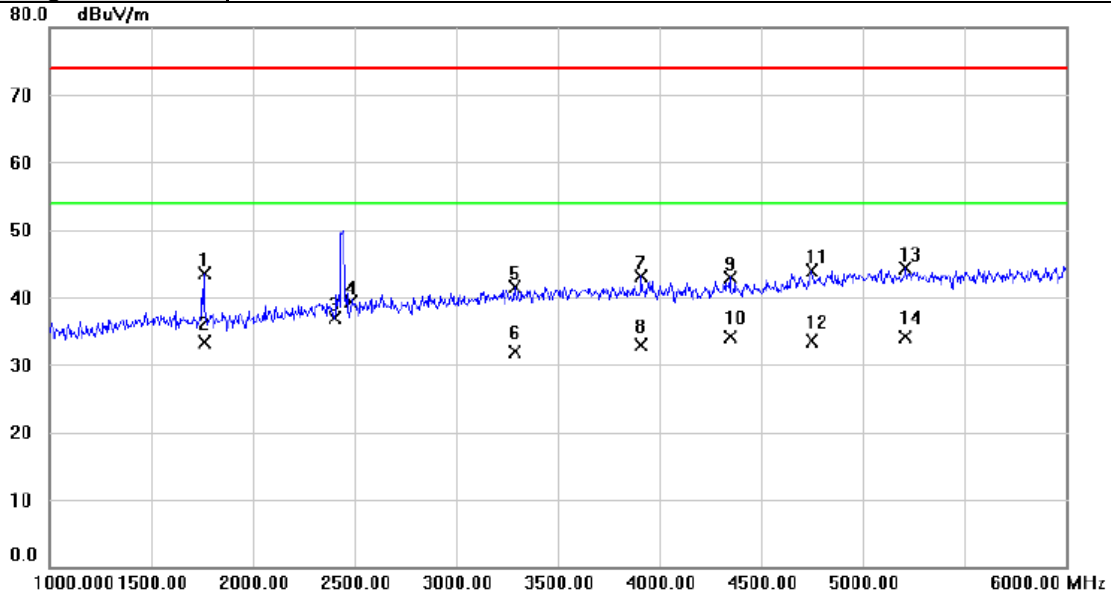

No.	Mk.	Freq. MHz	Reading Level dBuV	Correct Factor dB	Measure- ment dBuV/m	Limit dBuV/m	Margin dB	Detector	Comment
1		1762.500	46.23	-2.65	43.58	74.00	-30.42	peak	
2		1762.500	35.90	-2.65	33.25	54.00	-20.75	AVG	
3		2400.000	37.13	-0.22	36.91	74.00	-37.09	peak	
4		2483.500	39.18	0.12	39.30	74.00	-34.70	peak	
5		3287.500	38.87	2.55	41.42	74.00	-32.58	peak	
6		3287.500	29.41	2.55	31.96	54.00	-22.04	AVG	
7		3912.500	38.56	4.50	43.06	74.00	-30.94	peak	
8		3912.500	28.46	4.50	32.96	54.00	-21.04	AVG	
9		4347.500	37.52	5.38	42.90	74.00	-31.10	peak	
10		4347.500	28.63	5.38	34.01	54.00	-19.99	AVG	
11		4752.500	37.13	6.68	43.81	74.00	-30.19	peak	
12		4752.500	26.90	6.68	33.58	54.00	-20.42	AVG	
13		5210.000	36.44	7.87	44.31	74.00	-29.69	peak	
14	*	5210.000	26.31	7.87	34.18	54.00	-19.82	AVG	

EUT	Smart Phone	Model Name	HRY-LX2
Temperature	25°C	Relative Humidity	60%
Test Voltage	AC 120V/60Hz	Polarization	Horizontal
Test Mode	Adapter+ Idle+Playing+Speaker		
Test Engineer	Simon		

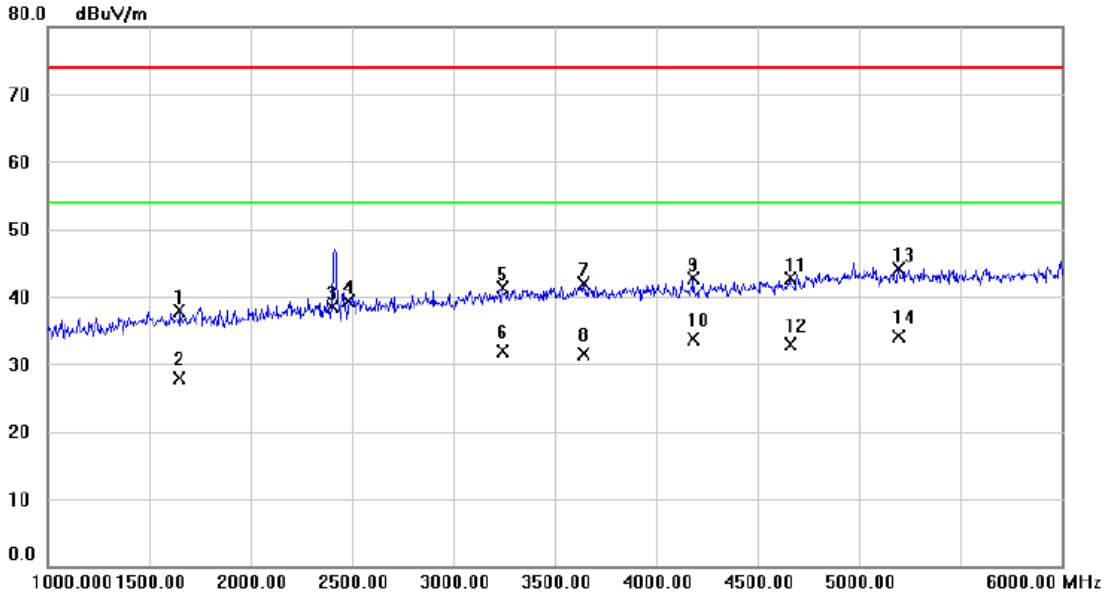

No.	Mk.	Freq. MHz	Reading Level dBuV	Correct Factor dB	Measure- ment dBuV/m	Limit dBuV/m	Margin dB	Detector	Comment
1		1650.000	41.02	-3.05	37.97	74.00	-36.03	peak	
2		1650.000	31.01	-3.05	27.96	54.00	-26.04	AVG	
3		2400.000	38.70	-0.22	38.48	74.00	-35.52	peak	
4		2483.500	39.27	0.12	39.39	74.00	-34.61	peak	
5		3242.500	38.83	2.41	41.24	74.00	-32.76	peak	
6		3242.500	29.44	2.41	31.85	54.00	-22.15	AVG	
7		3640.000	38.17	3.70	41.87	74.00	-32.13	peak	
8		3640.000	27.88	3.70	31.58	54.00	-22.42	AVG	
9		4185.000	37.63	5.09	42.72	74.00	-31.28	peak	
10		4185.000	28.65	5.09	33.74	54.00	-20.26	AVG	
11		4662.500	36.46	6.31	42.77	74.00	-31.23	peak	
12		4662.500	26.54	6.31	32.85	54.00	-21.15	AVG	
13		5197.500	36.31	7.86	44.17	74.00	-29.83	peak	
14	*	5197.500	26.32	7.86	34.18	54.00	-19.82	AVG	

EUT	Smart Phone	Model Name	HRY-LX2
Temperature	25°C	Relative Humidity	60%
Test Voltage	AC 120V/60Hz	Polarization	Vertical
Test Mode	Adapter+ Idle+Playing+earphone		
Test Engineer	Simon		

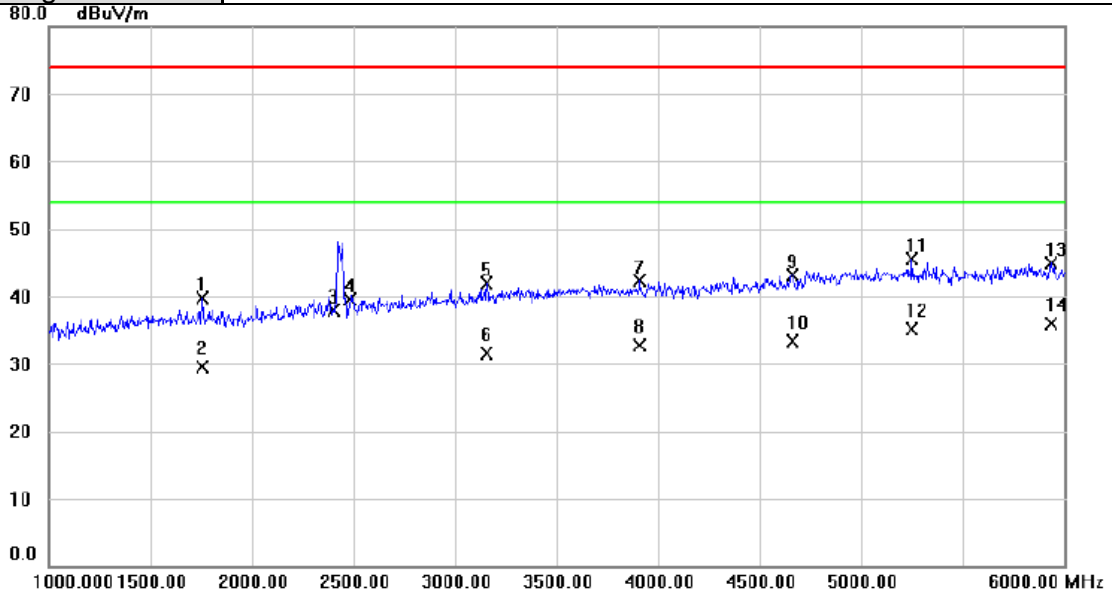

No.	Mk.	Freq. MHz	Reading Level dBuV	Correct Factor dB	Measure- ment dBuV/m	Limit dBuV/m	Margin dB	Detector	Comment
1		1755.000	42.42	-2.68	39.74	74.00	-34.26	peak	
2		1755.000	32.26	-2.68	29.58	54.00	-24.42	AVG	
3		2400.000	38.09	-0.22	37.87	74.00	-36.13	peak	
4		2483.500	39.47	0.12	39.59	74.00	-34.41	peak	
5		3157.500	39.80	2.12	41.92	74.00	-32.08	peak	
6		3157.500	29.40	2.12	31.52	54.00	-22.48	AVG	
7		3912.500	37.90	4.50	42.40	74.00	-31.60	peak	
8		3912.500	28.19	4.50	32.69	54.00	-21.31	AVG	
9		4662.500	36.84	6.31	43.15	74.00	-30.85	peak	
10		4662.500	26.96	6.31	33.27	54.00	-20.73	AVG	
11		5252.500	37.63	7.91	45.54	74.00	-28.46	peak	
12		5252.500	27.27	7.91	35.18	54.00	-18.82	AVG	
13		5937.500	35.95	8.89	44.84	74.00	-29.16	peak	
14	*	5937.500	26.96	8.89	35.85	54.00	-18.15	AVG	



EUT	Smart Phone	Model Name	HRY-LX2
Temperature	25°C	Relative Humidity	60%
Test Voltage	AC 120V/60Hz	Polarization	Horizontal
Test Mode	Adapter+ Idle+Playing+earphone		
Test Engineer	Simon		

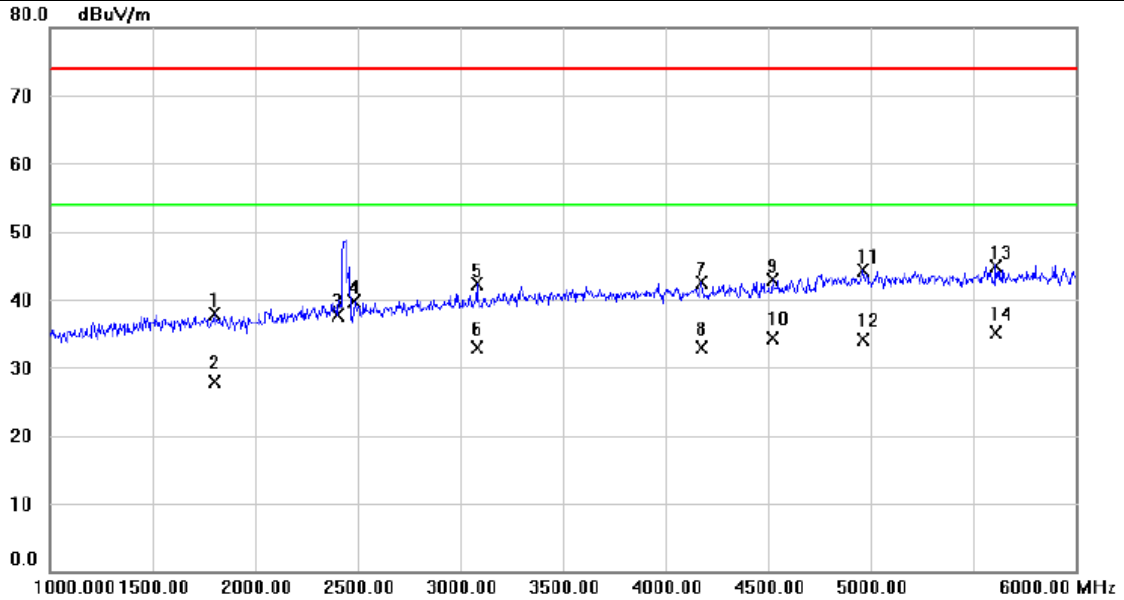

No.	Mk.	Freq. MHz	Reading Level dBuV	Correct Factor dB	Measure- ment dBuV/m	Limit dBuV/m	Margin dB	Detector	Comment
1		1800.000	40.46	-2.53	37.93	74.00	-36.07	peak	
2		1800.000	30.38	-2.53	27.85	54.00	-26.15	AVG	
3		2400.000	38.01	-0.22	37.79	74.00	-36.21	peak	
4		2483.500	39.58	0.12	39.70	74.00	-34.30	peak	
5		3082.500	40.49	1.87	42.36	74.00	-31.64	peak	
6		3082.500	30.98	1.87	32.85	54.00	-21.15	AVG	
7		4175.000	37.48	5.08	42.56	74.00	-31.44	peak	
8		4175.000	27.80	5.08	32.88	54.00	-21.12	AVG	
9		4522.500	37.16	5.75	42.91	74.00	-31.09	peak	
10		4522.500	28.63	5.75	34.38	54.00	-19.62	AVG	
11		4960.000	36.81	7.52	44.33	74.00	-29.67	peak	
12		4960.000	26.66	7.52	34.18	54.00	-19.82	AVG	
13		5612.500	36.67	8.33	45.00	74.00	-29.00	peak	
14	*	5612.500	26.78	8.33	35.11	54.00	-18.89	AVG	

EUT	Smart Phone	Model Name	HRY-LX2
Temperature	25°C	Relative Humidity	60%
Test Voltage	AC 120V/60Hz	Polarization	Vertical
Test Mode	Adapter+Idle+2.4G WIFI+BT+GPS+Camera on(Front)		
Test Engineer	Simon		

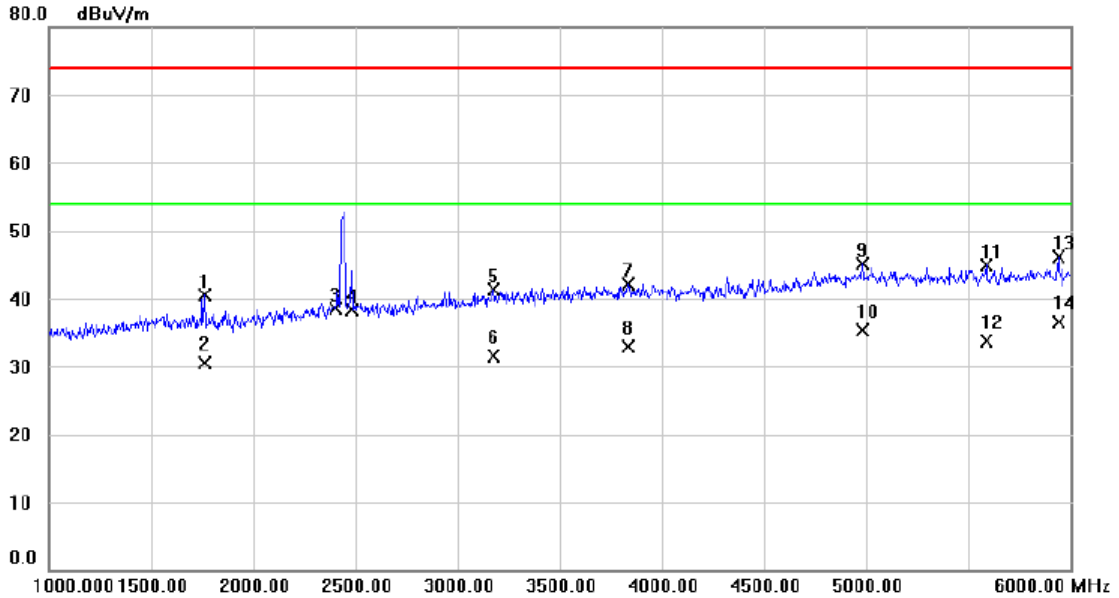

No.	Mk.	Freq. MHz	Reading Level dBuV	Correct Factor dB	Measure- ment dBuV/m	Limit dBuV/m	Margin dB	Detector	Comment
1		1760.000	43.15	-2.68	40.47	74.00	-33.53	peak	
2		1760.000	33.26	-2.68	30.58	54.00	-23.42	AVG	
3		2400.000	38.79	-0.22	38.57	74.00	-35.43	peak	
4		2483.500	38.26	0.12	38.38	74.00	-35.62	peak	
5		3175.000	39.08	2.18	41.26	74.00	-32.74	peak	
6		3175.000	29.30	2.18	31.48	54.00	-22.52	AVG	
7		3835.000	37.76	4.27	42.03	74.00	-31.97	peak	
8		3835.000	28.58	4.27	32.85	54.00	-21.15	AVG	
9		4980.000	37.42	7.59	45.01	74.00	-28.99	peak	
10		4980.000	27.72	7.59	35.31	54.00	-18.69	AVG	
11		5587.500	36.55	8.29	44.84	74.00	-29.16	peak	
12		5587.500	25.46	8.29	33.75	54.00	-20.25	AVG	
13		5940.000	37.16	8.89	46.05	74.00	-27.95	peak	
14	*	5940.000	27.68	8.89	36.57	54.00	-17.43	AVG	

EUT	Smart Phone	Model Name	HRY-LX2
Temperature	25°C	Relative Humidity	60%
Test Voltage	AC 120V/60Hz	Polarization	Horizontal
Test Mode	Adapter+Idle+2.4G WIFI+BT+GPS+Camera on(Front)		
Test Engineer	Simon		

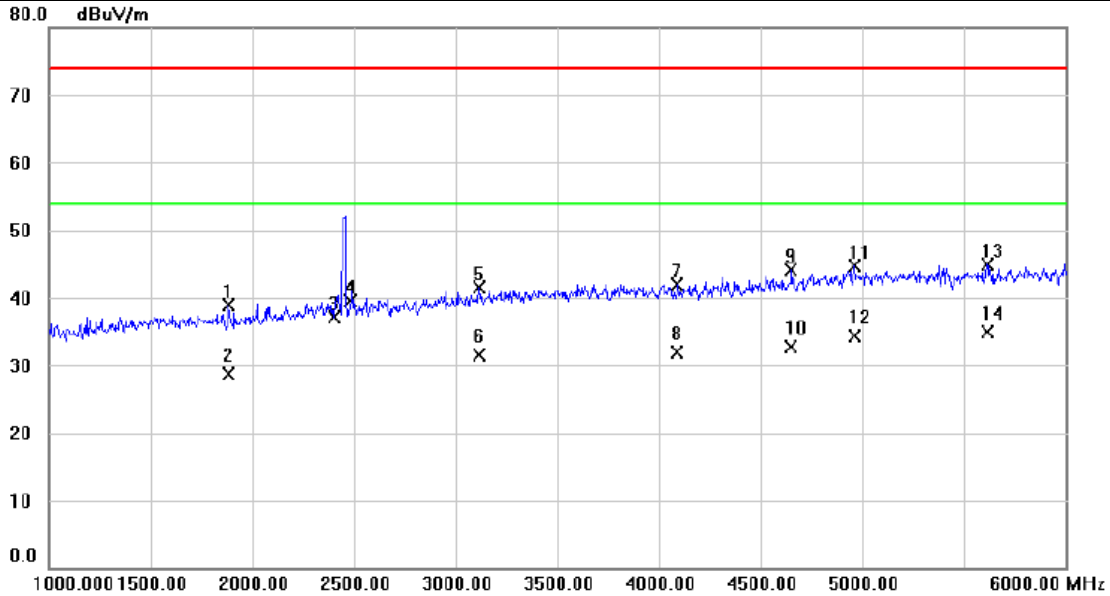

No.	Mk.	Freq. MHz	Reading Level dBuV	Correct Factor dB	Measure- ment dBuV/m	Limit dBuV/m	Margin dB	Detector	Comment
1		1885.000	41.12	-2.24	38.88	74.00	-35.12	peak	
2		1885.000	31.02	-2.24	28.78	54.00	-25.22	AVG	
3		2400.000	37.25	-0.22	37.03	74.00	-36.97	peak	
4		2483.500	39.46	0.12	39.58	74.00	-34.42	peak	
5		3117.500	39.53	1.98	41.51	74.00	-32.49	peak	
6		3117.500	29.49	1.98	31.47	54.00	-22.53	AVG	
7		4090.000	37.07	4.92	41.99	74.00	-32.01	peak	
8		4090.000	26.97	4.92	31.89	54.00	-22.11	AVG	
9		4652.500	37.86	6.28	44.14	74.00	-29.86	peak	
10		4652.500	26.39	6.28	32.67	54.00	-21.33	AVG	
11		4960.000	37.17	7.52	44.69	74.00	-29.31	peak	
12		4960.000	26.76	7.52	34.28	54.00	-19.72	AVG	
13		5615.000	36.47	8.34	44.81	74.00	-29.19	peak	
14	*	5615.000	26.51	8.34	34.85	54.00	-19.15	AVG	

EUT	Smart Phone	Model Name	HRY-LX2
Temperature	25°C	Relative Humidity	60%
Test Voltage	AC 120V/60Hz	Polarization	Vertical
Test Mode	Adapter+Idle+2.4G WIFI+BT+GPS+Camera on(Front)		
Test Engineer	Simon		

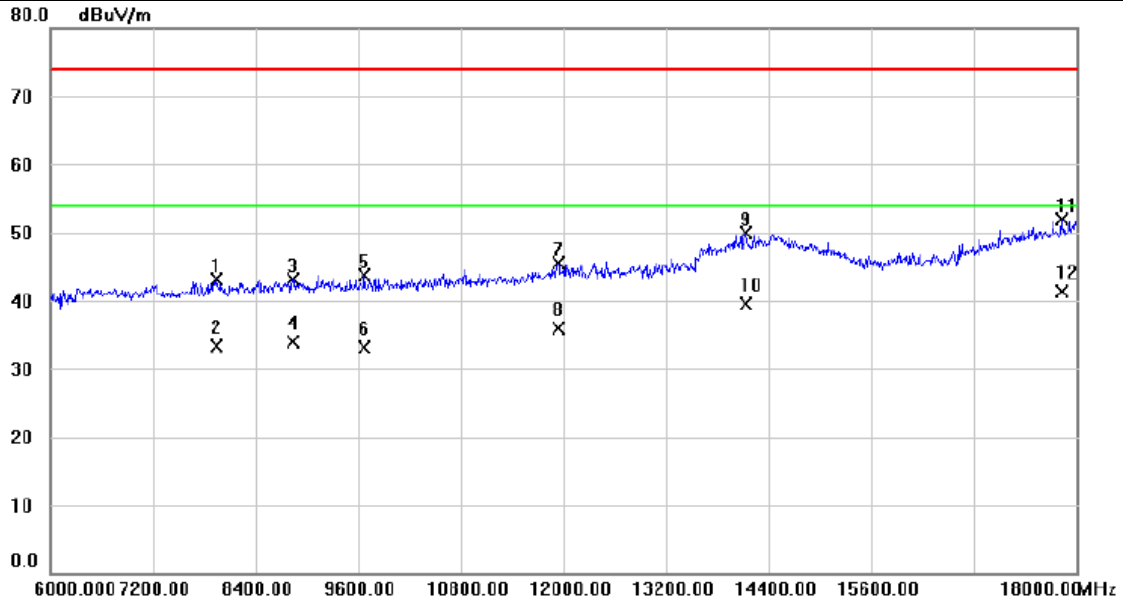

No.	Mk.	Freq. MHz	Reading Level dBuV	Correct Factor dB	Measure- ment dBuV/m	Limit dBuV/m	Margin dB	Detector	Comment
1		7950.000	29.48	13.66	43.14	74.00	-30.86	peak	
2		7950.000	19.62	13.66	33.28	54.00	-20.72	AVG	
3		8832.000	28.85	14.16	43.01	74.00	-30.99	peak	
4		8832.000	19.69	14.16	33.85	54.00	-20.15	AVG	
5		9678.000	28.92	14.75	43.67	74.00	-30.33	peak	
6		9678.000	18.41	14.75	33.16	54.00	-20.84	AVG	
7		11946.00	27.59	17.83	45.42	74.00	-28.58	peak	
8		11946.00	18.13	17.83	35.96	54.00	-18.04	AVG	
9		14142.00	27.14	22.67	49.81	74.00	-24.19	peak	
10		14142.00	16.80	22.67	39.47	54.00	-14.53	AVG	
11		17826.00	27.01	24.86	51.87	74.00	-22.13	peak	
12	*	17826.00	16.42	24.86	41.28	54.00	-12.72	AVG	

EUT	Smart Phone	Model Name	HRY-LX2
Temperature	25°C	Relative Humidity	60%
Test Voltage	AC 120V/60Hz	Polarization	Horizontal
Test Mode	Adapter+Idle+2.4G WIFI+BT+GPS+Camera on(Front)		
Test Engineer	Simon		

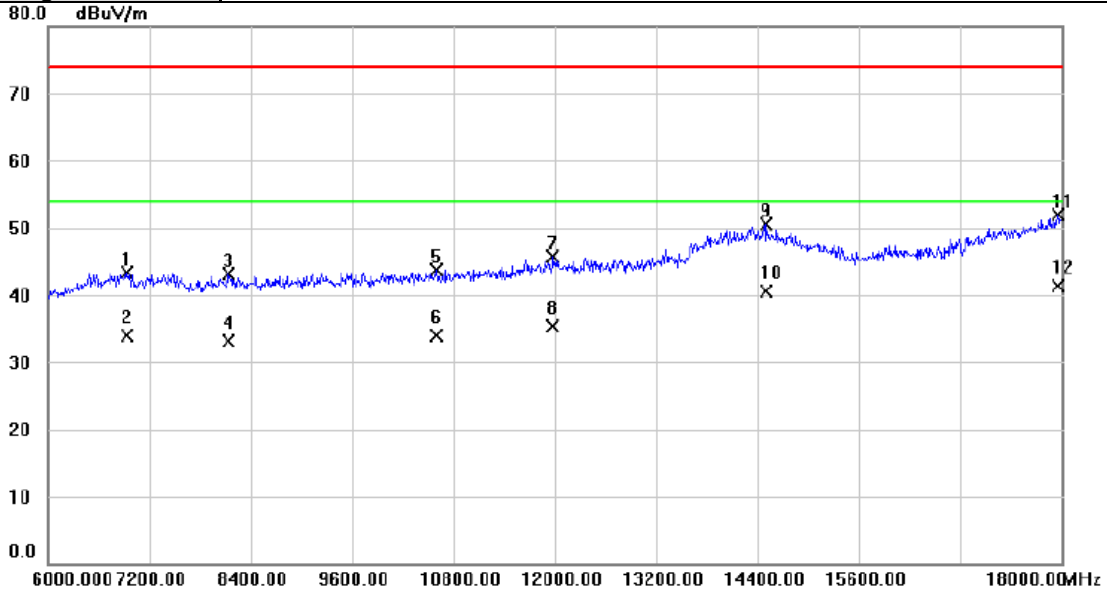

No.	Mk.	Freq. MHz	Reading Level dBuV	Correct Factor dB	Measure- ment dBuV/m	Limit dBuV/m	Margin dB	Detector	Comment
1		6930.000	32.60	10.61	43.21	74.00	-30.79	peak	
2		6930.000	23.35	10.61	33.96	54.00	-20.04	AVG	
3		8130.000	29.39	13.80	43.19	74.00	-30.81	peak	
4		8130.000	19.38	13.80	33.18	54.00	-20.82	AVG	
5		10602.00	27.98	15.63	43.61	74.00	-30.39	peak	
6		10602.00	18.22	15.63	33.85	54.00	-20.15	AVG	
7		11982.00	27.78	17.92	45.70	74.00	-28.30	peak	
8		11982.00	17.36	17.92	35.28	54.00	-18.72	AVG	
9		14496.00	27.45	22.96	50.41	74.00	-23.59	peak	
10		14496.00	17.56	22.96	40.52	54.00	-13.48	AVG	
11		17958.00	26.48	25.35	51.83	74.00	-22.17	peak	
12	*	17958.00	15.92	25.35	41.27	54.00	-12.73	AVG	

EUT	Smart Phone	Model Name	HRY-LX2
Temperature	25°C	Relative Humidity	60%
Test Voltage	AC 120V/60Hz	Polarization	Vertical
Test Mode	Adapter+Traffic(LTE)		
Test Engineer	Simon		

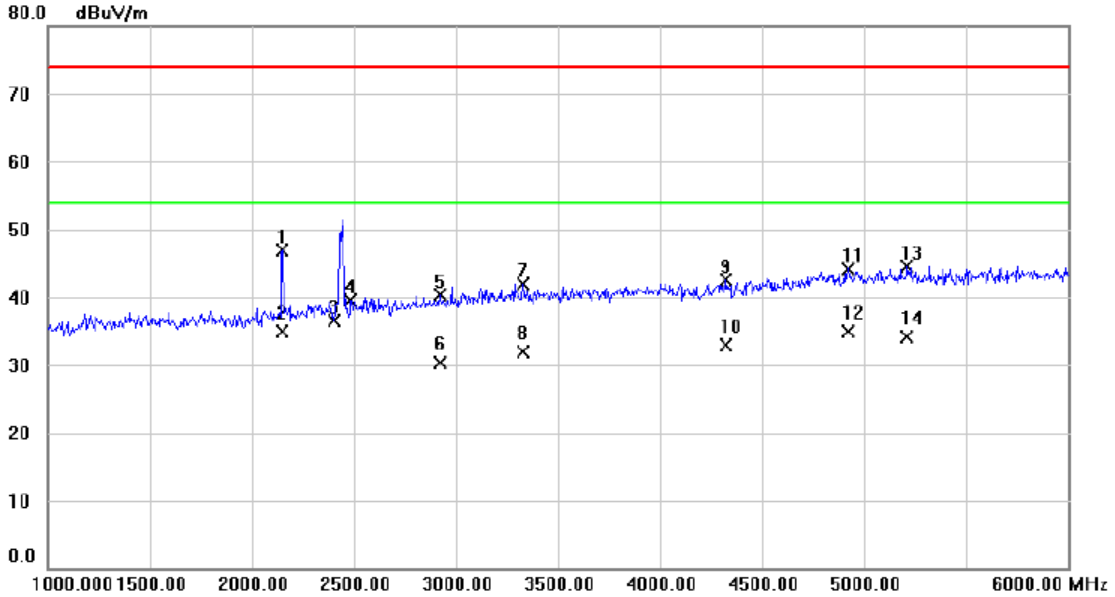

No.	Mk.	Freq. MHz	Reading Level dBuV	Correct Factor dB	Measure- ment dBuV/m	Limit dBuV/m	Margin dB	Detector	Comment
1		2152.500	48.11	-1.23	46.88	74.00	-27.12	peak	
2	*	2152.500	36.23	-1.23	35.00	54.00	-19.00	AVG	
3		2400.000	36.80	-0.22	36.58	74.00	-37.42	peak	
4		2483.500	39.40	0.12	39.52	74.00	-34.48	peak	
5		2922.500	38.94	1.37	40.31	74.00	-33.69	peak	
6		2922.500	28.87	1.37	30.24	54.00	-23.76	AVG	
7		3330.000	39.27	2.70	41.97	74.00	-32.03	peak	
8		3330.000	29.15	2.70	31.85	54.00	-22.15	AVG	
9		4325.000	37.21	5.34	42.55	74.00	-31.45	peak	
10		4325.000	27.51	5.34	32.85	54.00	-21.15	AVG	
11		4922.500	36.84	7.36	44.20	74.00	-29.80	peak	
12		4922.500	27.58	7.36	34.94	54.00	-19.06	AVG	
13		5210.000	36.59	7.87	44.46	74.00	-29.54	peak	
14		5210.000	26.31	7.87	34.18	54.00	-19.82	AVG	

EUT	Smart Phone	Model Name	HRY-LX2
Temperature	25°C	Relative Humidity	60%
Test Voltage	AC 120V/60Hz	Polarization	Horizontal
Test Mode	Adapter+Traffic(LTE)		
Test Engineer	Simon		

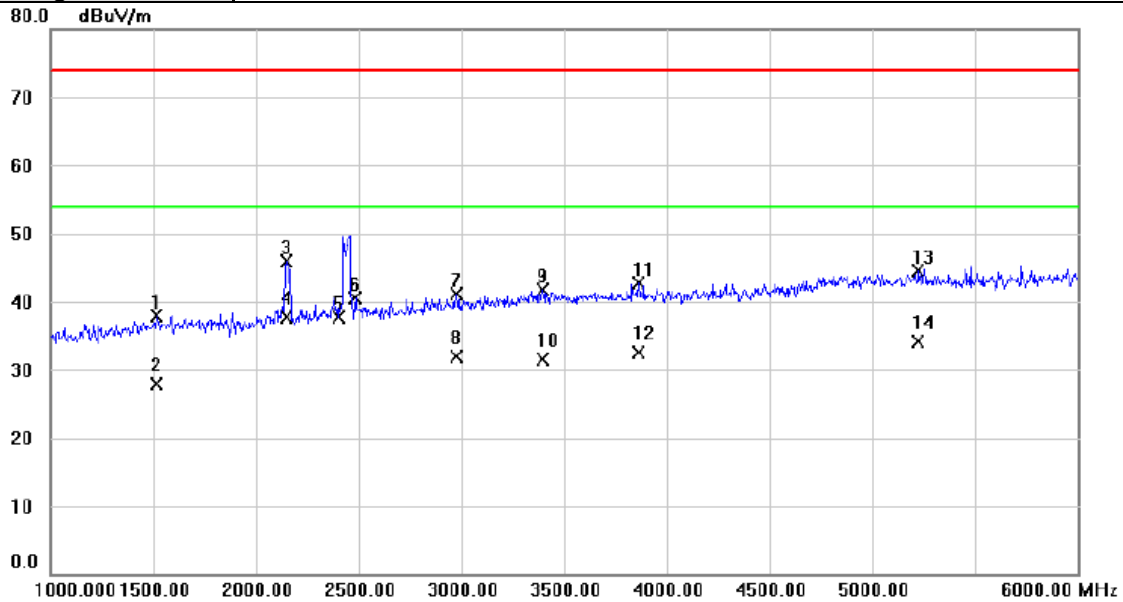

No.	Mk.	Freq. MHz	Reading Level dBuV	Correct Factor dB	Measure- ment dBuV/m	Limit dBuV/m	Margin dB	Detector	Comment
1		1515.000	41.45	-3.51	37.94	74.00	-36.06	peak	
2		1515.000	31.47	-3.51	27.96	54.00	-26.04	AVG	
3		2150.000	47.22	-1.24	45.98	74.00	-28.02	peak	
4	*	2150.000	38.96	-1.24	37.72	54.00	-16.28	AVG	
5		2400.000	37.92	-0.22	37.70	74.00	-36.30	peak	
6		2483.500	40.30	0.12	40.42	74.00	-33.58	peak	
7		2975.000	39.59	1.51	41.10	74.00	-32.90	peak	
8		2975.000	30.34	1.51	31.85	54.00	-22.15	AVG	
9		3397.500	38.73	2.92	41.65	74.00	-32.35	peak	
10		3397.500	28.66	2.92	31.58	54.00	-22.42	AVG	
11		3860.000	38.33	4.33	42.66	74.00	-31.34	peak	
12		3860.000	28.22	4.33	32.55	54.00	-21.45	AVG	
13		5225.000	36.61	7.88	44.49	74.00	-29.51	peak	
14		5225.000	26.31	7.88	34.19	54.00	-19.81	AVG	

EUT	Smart Phone	Model Name	HRY-LX2
Temperature	25°C	Relative Humidity	60%
Test Voltage	AC 120V/60Hz	Polarization	Vertical
Test Mode	Adapter+Traffic(LTE)		
Test Engineer	Simon		

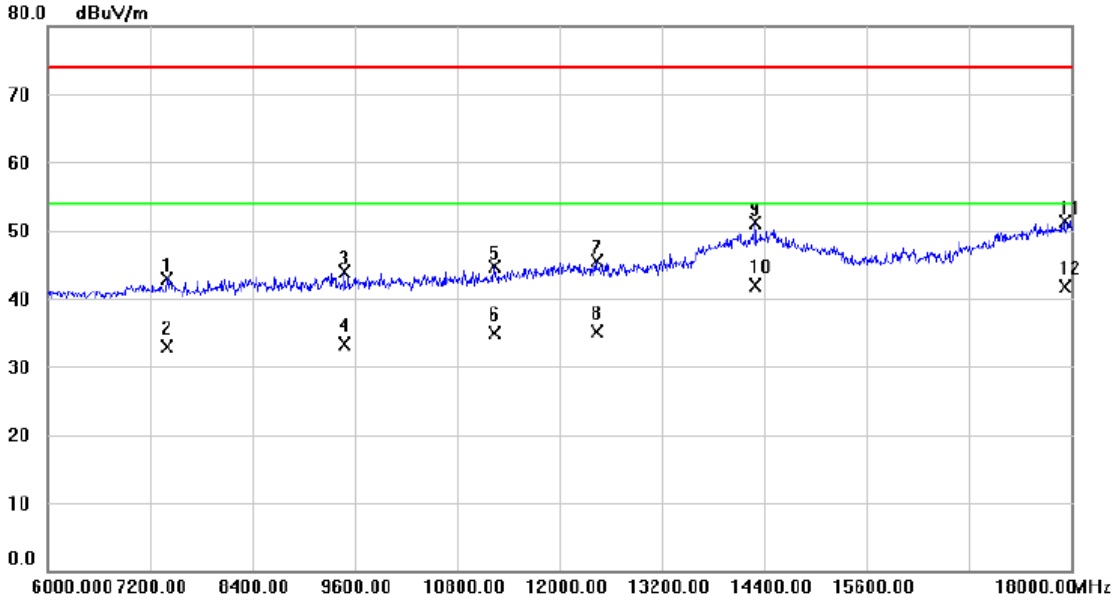

No.	Mk.	Freq. MHz	Reading Level dBuV	Correct Factor dB	Measure- ment dBuV/m	Limit dBuV/m	Margin dB	Detector	Comment
1		7398.000	30.57	12.36	42.93	74.00	-31.07	peak	
2		7398.000	20.59	12.36	32.95	54.00	-21.05	AVG	
3		9486.000	29.23	14.65	43.88	74.00	-30.12	peak	
4		9486.000	18.63	14.65	33.28	54.00	-20.72	AVG	
5		11232.00	28.25	16.38	44.63	74.00	-29.37	peak	
6		11232.00	18.47	16.38	34.85	54.00	-19.15	AVG	
7		12438.00	27.67	17.91	45.58	74.00	-28.42	peak	
8		12438.00	17.24	17.91	35.15	54.00	-18.85	AVG	
9		14292.00	28.36	22.79	51.15	74.00	-22.85	peak	
10	*	14292.00	19.06	22.79	41.85	54.00	-12.15	AVG	
11		17922.00	26.03	25.22	51.25	74.00	-22.75	peak	
12		17922.00	16.45	25.22	41.67	54.00	-12.33	AVG	



EUT	Smart Phone	Model Name	HRY-LX2
Temperature	25°C	Relative Humidity	60%
Test Voltage	AC 120V/60Hz	Polarization	Horizontal
Test Mode	Adapter+Traffic(LTE)		
Test Engineer	Simon		

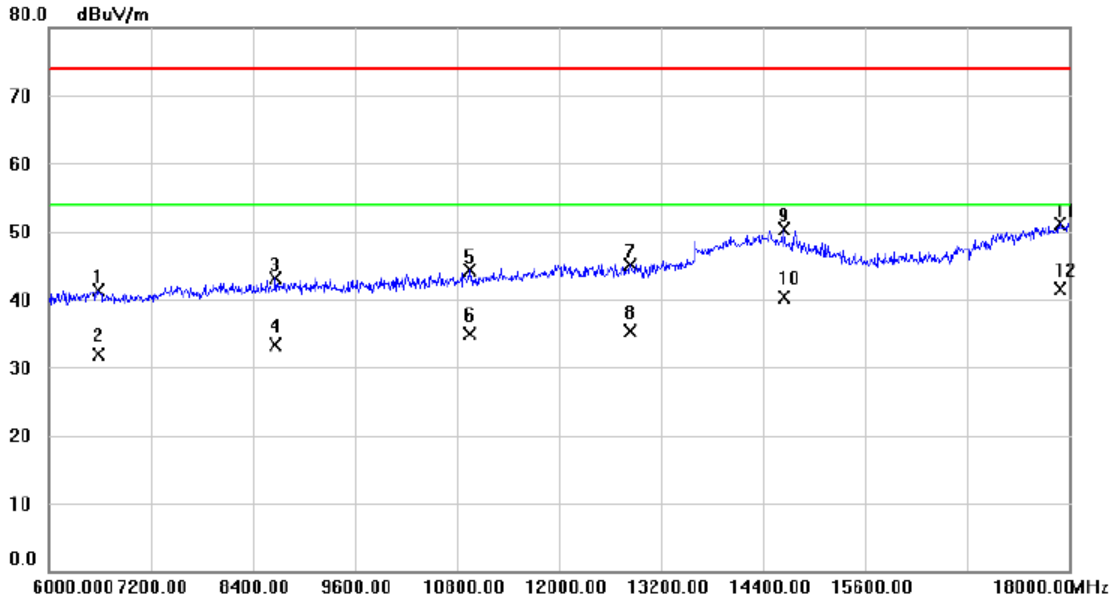

No.	Mk.	Freq. MHz	Reading Level dBuV	Correct Factor dB	Measure- ment dBuV/m	Limit dBuV/m	Margin dB	Detector	Comment
1		6582.000	31.74	9.62	41.36	74.00	-32.64	peak	
2		6582.000	22.23	9.62	31.85	54.00	-22.15	AVG	
3		8670.000	29.08	14.04	43.12	74.00	-30.88	peak	
4		8670.000	19.23	14.04	33.27	54.00	-20.73	AVG	
5		10950.000	28.30	16.01	44.31	74.00	-29.69	peak	
6		10950.000	18.84	16.01	34.85	54.00	-19.15	AVG	
7		12846.000	26.23	18.86	45.09	74.00	-28.91	peak	
8		12846.000	16.40	18.86	35.26	54.00	-18.74	AVG	
9		14640.000	27.62	22.62	50.24	74.00	-23.76	peak	
10		14640.000	17.65	22.62	40.27	54.00	-13.73	AVG	
11		17892.000	26.05	25.10	51.15	74.00	-22.85	peak	
12	*	17892.000	16.45	25.10	41.55	54.00	-12.45	AVG	

EUT	Smart Phone	Model Name	HRY-LX2
Temperature	25°C	Relative Humidity	60%
Test Voltage	AC 120V/60Hz	Polarization	Vertical
Test Mode	FM 98MHz		
Test Engineer	Simon		

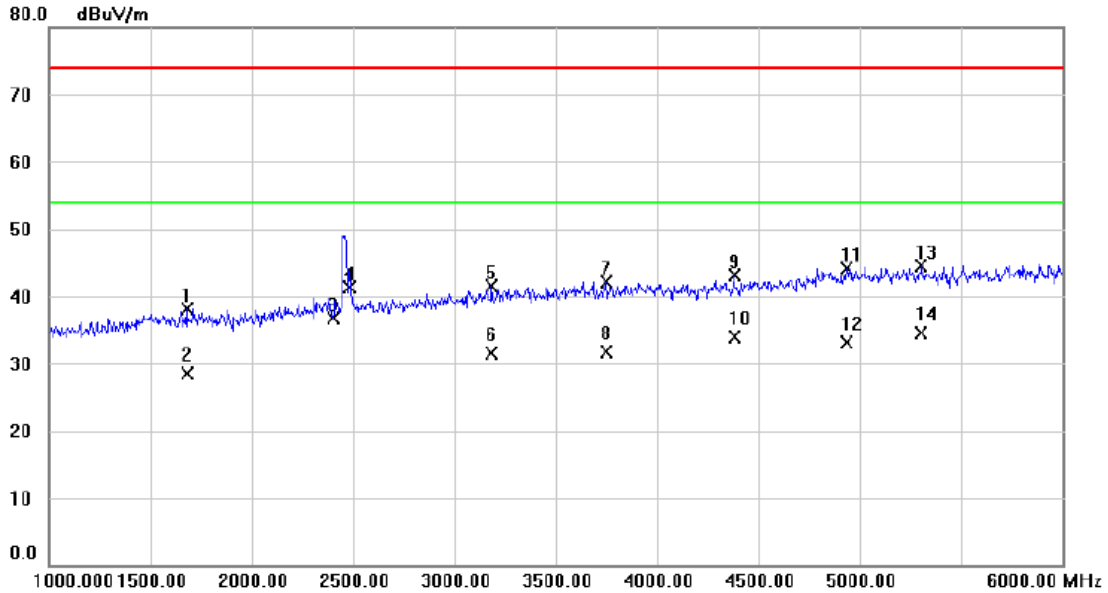

No.	Mk.	Freq. MHz	Reading Level dBuV	Correct Factor dB	Measure- ment dBuV/m	Limit dBuV/m	Margin dB	Detector	Comment
1		1682.500	41.12	-2.94	38.18	74.00	-35.82	peak	
2		1682.500	31.40	-2.94	28.46	54.00	-25.54	AVG	
3		2400.000	36.98	-0.22	36.76	74.00	-37.24	peak	
4		2483.500	41.14	0.12	41.26	74.00	-32.74	peak	
5		3185.000	39.20	2.21	41.41	74.00	-32.59	peak	
6		3185.000	29.26	2.21	31.47	54.00	-22.53	AVG	
7		3750.000	38.10	4.01	42.11	74.00	-31.89	peak	
8		3750.000	27.76	4.01	31.77	54.00	-22.23	AVG	
9		4382.500	37.58	5.45	43.03	74.00	-30.97	peak	
10		4382.500	28.51	5.45	33.96	54.00	-20.04	AVG	
11		4937.500	36.75	7.42	44.17	74.00	-29.83	peak	
12		4937.500	25.68	7.42	33.10	54.00	-20.90	AVG	
13		5305.000	36.47	7.95	44.42	74.00	-29.58	peak	
14	*	5305.000	26.63	7.95	34.58	54.00	-19.42	AVG	

EUT	Smart Phone	Model Name	HRY-LX2
Temperature	25°C	Relative Humidity	60%
Test Voltage	AC 120V/60Hz	Polarization	Horizontal
Test Mode	FM 98MHz		
Test Engineer	Simon		

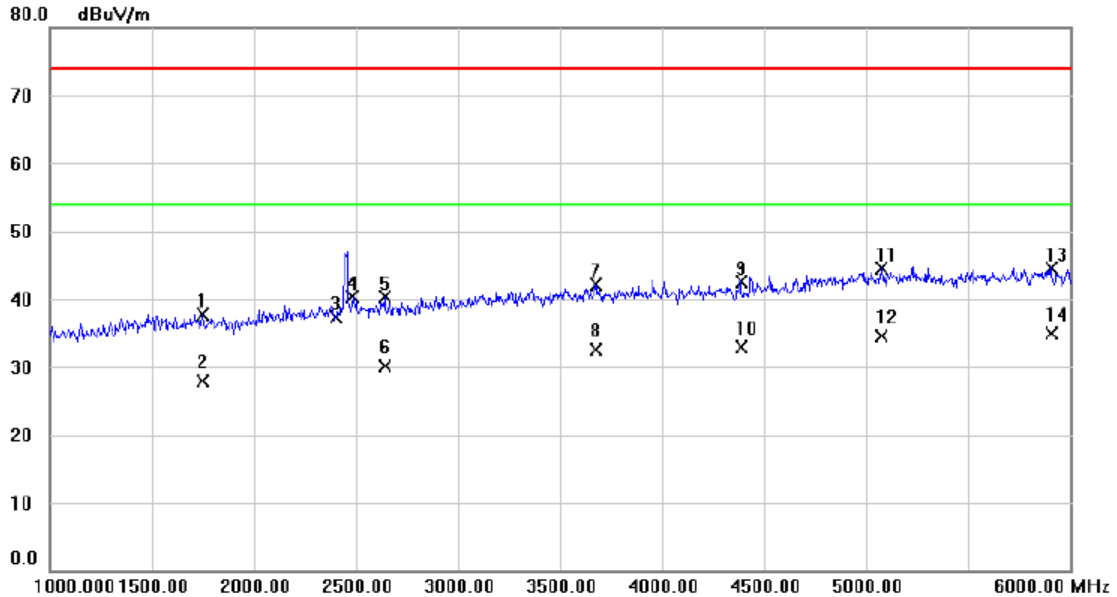

No.	Mk.	Freq. MHz	Reading Level dBuV	Correct Factor dB	Measure- ment dBuV/m	Limit dBuV/m	Margin dB	Detector	Comment
1		1750.000	40.33	-2.71	37.62	74.00	-36.38	peak	
2		1750.000	30.67	-2.71	27.96	54.00	-26.04	AVG	
3		2400.000	37.44	-0.22	37.22	74.00	-36.78	peak	
4		2483.500	40.15	0.12	40.27	74.00	-33.73	peak	
5		2640.000	39.66	0.58	40.24	74.00	-33.76	peak	
6		2640.000	29.60	0.58	30.18	54.00	-23.82	AVG	
7		3677.500	38.30	3.80	42.10	74.00	-31.90	peak	
8		3677.500	28.75	3.80	32.55	54.00	-21.45	AVG	
9		4387.500	37.14	5.46	42.60	74.00	-31.40	peak	
10		4387.500	27.48	5.46	32.94	54.00	-21.06	AVG	
11		5077.500	36.72	7.75	44.47	74.00	-29.53	peak	
12		5077.500	26.69	7.75	34.44	54.00	-19.56	AVG	
13		5907.500	35.76	8.84	44.60	74.00	-29.40	peak	
14	*	5907.500	26.01	8.84	34.85	54.00	-19.15	AVG	

EUT	Smart Phone	Model Name	HRY-LX2
Temperature	25°C	Relative Humidity	60%
Test Voltage	AC 120V/60Hz	Polarization	Vertical
Test Mode	USB Copy + Idle		
Test Engineer	Simon		

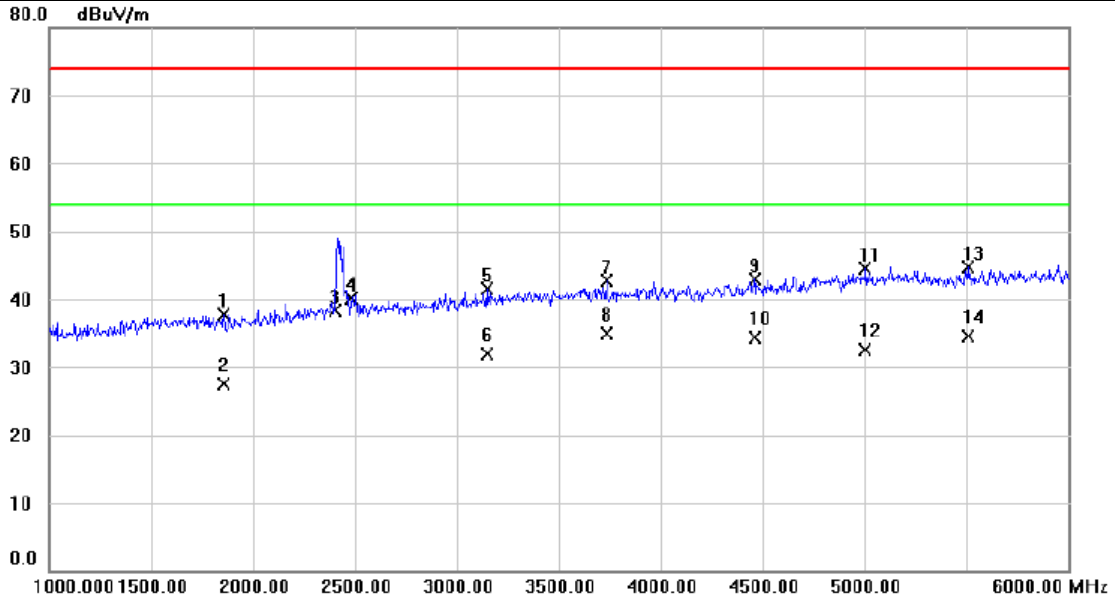

No.	Mk.	Freq. MHz	Reading Level dBuV	Correct Factor dB	Measure- ment dBuV/m	Limit dBuV/m	Margin dB	Detector	Comment
1		1855.000	40.09	-2.34	37.75	74.00	-36.25	peak	
2		1855.000	29.92	-2.34	27.58	54.00	-26.42	AVG	
3		2400.000	38.61	-0.22	38.39	74.00	-35.61	peak	
4		2483.500	40.08	0.12	40.20	74.00	-33.80	peak	
5		3147.500	39.50	2.09	41.59	74.00	-32.41	peak	
6		3147.500	29.85	2.09	31.94	54.00	-22.06	AVG	
7		3735.000	38.74	3.97	42.71	74.00	-31.29	peak	
8	*	3735.000	30.88	3.97	34.85	54.00	-19.15	AVG	
9		4460.000	37.39	5.59	42.98	74.00	-31.02	peak	
10		4460.000	28.69	5.59	34.28	54.00	-19.72	AVG	
11		5005.000	36.74	7.67	44.41	74.00	-29.59	peak	
12		5005.000	24.91	7.67	32.58	54.00	-21.42	AVG	
13		5507.500	36.58	8.15	44.73	74.00	-29.27	peak	
14		5507.500	26.37	8.15	34.52	54.00	-19.48	AVG	

EUT	Smart Phone	Model Name	HRY-LX2
Temperature	25°C	Relative Humidity	60%
Test Voltage	AC 120V/60Hz	Polarization	Horizontal
Test Mode	USB Copy + Idle		
Test Engineer	Simon		

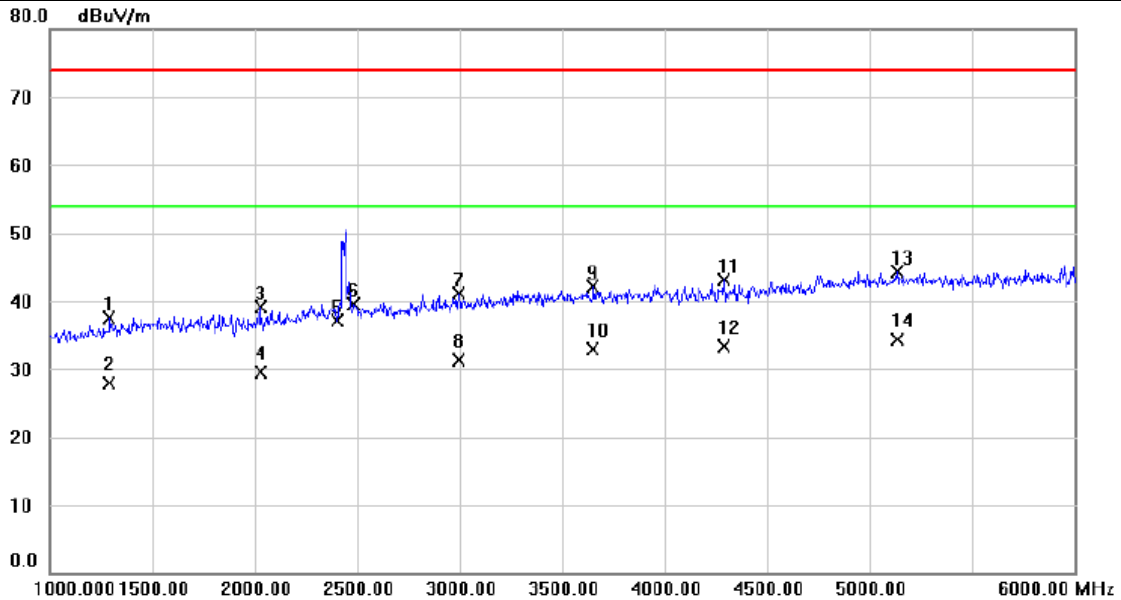

No.	Mk.	Freq. MHz	Reading Level dBuV	Correct Factor dB	Measure- ment dBuV/m	Limit dBuV/m	Margin dB	Detector	Comment
1		1292.500	42.61	-5.01	37.60	74.00	-36.40	peak	
2		1292.500	32.86	-5.01	27.85	54.00	-26.15	AVG	
3		2027.500	40.79	-1.74	39.05	74.00	-34.95	peak	
4		2027.500	31.20	-1.74	29.46	54.00	-24.54	AVG	
5		2400.000	37.33	-0.22	37.11	74.00	-36.89	peak	
6		2483.500	39.40	0.12	39.52	74.00	-34.48	peak	
7		2997.500	39.50	1.59	41.09	74.00	-32.91	peak	
8		2997.500	29.66	1.59	31.25	54.00	-22.75	AVG	
9		3650.000	38.44	3.71	42.15	74.00	-31.85	peak	
10		3650.000	29.14	3.71	32.85	54.00	-21.15	AVG	
11		4290.000	37.74	5.28	43.02	74.00	-30.98	peak	
12		4290.000	28.09	5.28	33.37	54.00	-20.63	AVG	
13		5137.500	36.47	7.79	44.26	74.00	-29.74	peak	
14	*	5137.500	26.48	7.79	34.27	54.00	-19.73	AVG	