

# FCC Radio Test Report

## FCC ID:QISHRY-LX2

This report concerns (check one): Original Grant Class I Change Class II Change

**Project No.** : 1809C113  
**Equipment** : Smart Phone  
**Test Model** : HRY-LX2  
**Series Model** : N/A  
**Applicant** : Huawei Technologies Co., Ltd.  
**Address** : Administration Building, Headquarters of Huawei Technologies Co., Ltd., Bantian, Longgang District, Shenzhen, 518129, P.R.C

**Date of Receipt** : Sep. 14, 2018  
**Date of Test** : Sep. 29, 2018 ~ Nov. 19, 2018  
**Issued Date** : Nov. 23, 2018  
**Tested by** : BTL Inc.

**Testing Engineer** : Treey Chen  
(Treey Chen)

**Technical Manager** : Shawn Xiao  
(Shawn Xiao)

**Authorized Signatory** : Steven Lu  
(Steven Lu)

# **B T L I N C .**

No.3, Jinshagang 1st Road, Shixia, Dalang Town, Dongguan,  
Guangdong, China.

TEL: +86-769-8318-3000 FAX: +86-769-8319-6000



Certificate #5123.02

## Declaration

**BTL** represents to the client that testing is done in accordance with standard procedures as applicable and that test instruments used has been calibrated with standards traceable to international standard(s) and/or national standard(s).

**BTL's** reports apply only to the specific samples tested under conditions. It is manufacture's responsibility to ensure that additional production units of this model are manufactured with the identical electrical and mechanical components. **BTL** shall have no liability for any declarations, inferences or generalizations drawn by the client or others from **BTL** issued reports.

The report must not be used by the client to claim product certification, approval, or endorsement by NVLAP, NIST, or any agency of the U.S. Government.

This report is the confidential property of the client. As a mutual protection to the clients, the public and ourselves, the test report shall not be reproduced, except in full, without our written approval.

**BTL's** laboratory quality assurance procedures are in compliance with the **ISO Guide 17025** requirements, and accredited by the conformity assessment authorities listed in this test report.

**BTL** is not responsible for the sampling stage, so the results only apply to the sample as received.

The information, data and test plan are provided by manufacturer, so it is manufacturer's responsibility to ensure that the apparatus meets the essential requirements in all the possible configurations as representative of its intended use.

## Limitation

For the use of the authority's logo is limited unless the Test Standard(s)/Scope(s)/Item(s) mentioned in this test report is (are) included in the conformity assessment authorities acceptance respective.

<b>Table of Contents</b>	<b>Page</b>
<b>1 . CERTIFICATION</b>	<b>5</b>
<b>2 . SUMMARY OF TEST RESULTS</b>	<b>6</b>
2.1 TEST FACILITY	7
2.2 MEASUREMENT UNCERTAINTY	7
<b>3 . GENERAL INFORMATION</b>	<b>8</b>
3.1 GENERAL DESCRIPTION OF EUT	8
3.2 DESCRIPTION OF TEST MODES	11
3.3 TABLE OF PARAMETERS OF TEXT SOFTWARE SETTING	11
3.4 BLOCK DIAGRAM SHOWING THE CONFIGURATION OF SYSTEM TESTED	12
3.5 DESCRIPTION OF SUPPORT UNITS	12
<b>4 . EMC EMISSION TEST</b>	<b>13</b>
4.1 RADIATED EMISSION MEASUREMENT	13
4.1.1 RADIATED EMISSION LIMITS	13
4.1.2 TEST PROCEDURE	14
4.1.3 DEVIATION FROM TEST STANDARD	14
4.1.4 TEST SETUP	15
4.1.5 EUT OPERATING CONDITIONS	17
4.1.6 EUT TEST CONDITIONS	17
4.1.7 TEST RESULTS (9 KHZ TO 30 MHZ)	17
4.1.8 TEST RESULTS (30 MHZ TO 1000 MHZ)	17
4.1.9 TEST RESULTS (ABOVE 1000 MHZ)	17
<b>5 . MEASUREMENT INSTRUMENTS LIST</b>	<b>18</b>
<b>APPENDIX A - RADIATED EMISSION (9 KHZ-30 MHZ)</b>	<b>19</b>
<b>APPENDIX B - RADIATED EMISSION (30 MHZ TO 1000 MHZ)</b>	<b>24</b>
<b>APPENDIX C - RADIATED EMISSION (ABOVE 1000 MHZ)</b>	<b>27</b>

### REPORT ISSUED HISTORY

Report Version	Description	Issued Date
R00	Original Issue.	Nov. 22, 2018
R01	Changed the brand name to Honor.	Nov. 23, 2018

## 1. CERTIFICATION

Equipment : Smart Phone  
Brand Name : Honor  
Test Model : HRY-LX2  
Series Model : N/A  
Applicant : Huawei Technologies Co., Ltd.  
Manufacturer : Huawei Technologies Co., Ltd.  
Address : Administration Building, Headquarters of Huawei Technologies Co., Ltd.,  
Bantian, Longgang District, Shenzhen, 518129, P.R.C  
Factory : Huawei Technologies Co., Ltd.  
Address : Administration Building, Headquarters of Huawei Technologies Co., Ltd.,  
Bantian, Longgang District, Shenzhen, 518129, P.R.C  
Date of Test : Sep. 29, 2018 ~ Nov. 19, 2018  
Test Sample : Engineering Sample No.: D181110240  
Standard(s) : FCC Part15, Subpart C (15.247)/ ANSI C63.10-2013

The above equipment has been tested and found compliance with the requirement of the relative standards by BTL Inc.

The test data, data evaluation, and equipment configuration contained in our test report (Ref No. BTL-FCCP-1-1809C113) were obtained utilizing the test procedures, test instruments, test sites that has been accredited by the Authority of A2LA according to the ISO-17025 quality assessment standard and technical standard(s).

**Test result included in this report is only for the Bluetooth EDR Radiated Spurious Emissions part.**

## 2. SUMMARY OF TEST RESULTS

Test procedures according to the technical standard(s):

FCC Part15, Subpart C (15.247)			
Standard(s) Section	Test Item	Judgment	Remark
15.247(d) 15.209 15.205	Radiated Spurious Emission	PASS	

Note:

(1) "N/A" denotes test is not applicable in this test report

## 2.1 TEST FACILITY

The test facilities used to collect the test data in this report is at the location of No.3, Jinshagang 1st Road, Shixia, Dalang Town, Dongguan, Guangdong, China  
 BTL's test firm number for FCC: 854385  
 BTL's designation number for FCC: CN5020

## 2.2 MEASUREMENT UNCERTAINTY

The measurement uncertainty figures shall be calculated according the methods described in the ETSI TR 100 028 and shall correspond to an expansion factor (coverage factor)  $k=1.96$  or  $k=2$ (which provide confidence levels of respectively 90% and 95.45% in the case where the distributions characterizing the actual measurement uncertainties are normal (Gaussian)).  
 Measurement Uncertainty for a Level of Confidence of 95 %,  $U=2xUc(y)$ .

The BTL measurement uncertainty as below table:

### A. Radiated Measurement :

Test Site	Method	Measurement Frequency Range	Ant. H / V	U, (dB)
DG-CB03	CISPR	9 kHz ~ 30 MHz	V	3.79
		9 kHz ~ 30 MHz	H	3.57
		30 MHz ~ 200 MHz	V	3.82
		30 MHz ~ 200 MHz	H	3.78
		200 MHz ~ 1,000 MHz	V	4.10
		200 MHz ~ 1,000 MHz	H	4.06
		1 GHz ~ 18 GHz	V	3.12
		1 GHz ~ 18 GHz	H	3.68
		18 GHz ~ 40 GHz	V	4.15
		18 GHz ~ 40 GHz	H	4.14

Note: Unless specifically mentioned, the uncertainty of measurement has not been taken into account to declare the compliance or non-compliance to the specification.

### 3. GENERAL INFORMATION

#### 3.1 GENERAL DESCRIPTION OF EUT

Equipment	Smart Phone	
Brand Name	Honor	
Test Model	HRY-LX2	
Series Model	N/A	
Model Difference(s)	N/A	
Software Version	9.0.1.111(C900E110R1P9)	
Hardware Version	HL1HRYM	
Product Description	Operation Frequency	2402 MHz ~2480 MHz
	Modulation Technology	GFSK(1Mbps) $\pi$ /4-DQPSK(2Mbps)
	Bit Rate of Transmitter	8-DPSK(3Mbps)
Power Source	1# DC voltage supplied from AC/DC adapter. 2# Supplied from battery.	
Power Rating	1# I/P: 100-240V~,50/60Hz,0.5A O/P: 5V <b>===</b> 2A 2# DC 3.82V, 3320mAh	

Note:

1. For a more detailed features description, please refer to the manufacturer's specifications or the user's manual.



2. Channel List:

Channel	Frequency (MHz)	Channel	Frequency (MHz)	Channel	Frequency (MHz)
00	2402	27	2429	54	2456
01	2403	28	2430	55	2457
02	2404	29	2431	56	2458
03	2405	30	2432	57	2459
04	2406	31	2433	58	2460
05	2407	32	2434	59	2461
06	2408	33	2435	60	2462
07	2409	34	2436	61	2463
08	2410	35	2437	62	2464
09	2411	36	2438	63	2465
10	2412	37	2439	64	2466
11	2413	38	2440	65	2467
12	2414	39	2441	66	2468
13	2415	40	2442	67	2469
14	2416	41	2443	68	2470
15	2417	42	2444	69	2471
16	2418	43	2445	70	2472
17	2419	44	2446	71	2473
18	2420	45	2447	72	2474
19	2421	46	2448	73	2475
20	2422	47	2449	74	2476
21	2423	48	2450	75	2477
22	2424	49	2451	76	2478
23	2425	50	2452	77	2479
24	2426	51	2453	78	2480
25	2427	52	2454		
26	2428	53	2455		

3. Table for Filed Antenna:

Ant.	Brand	Model Name	Antenna Type	Connector	Gain (dBi)
1	N/A	N/A	Internal	N/A	-1.81

4. The EUT contains following accessory devices.

Item	Manufacturer	Factory	Model	Description
Adapter	Huawei Technologies Co., Ltd.	Salcomp	HW-050200U02	I/P:100-240V~50/60Hz, 0.5A O/P:5V  2A
		HUIZHOU BYD ELECTRONIC CO., LTD.	HW-050200U02 HW-050200U01	
		SHENZHEN HUNTKEY ELECTRIC CO., LTD.		
		Dongguan Phitek Electronics Co., Ltd.		
Battery	Huawei Technologies Co., Ltd.	SCUD (FUJIAN) Electronics Co., Ltd.	HB396286ECW	DC 3.82V, 3320mAh
		Huizhou Desay Battery Co., Ltd.		
		Sunwoda Electronic Co., Ltd.		
		Dongguan Amperex Technology Limited		
USB Cable	-	NingBo Broad Telecommunication Co., Ltd.	WA0001	-
		HONGLIN TECHNOLOGY CO., LTD.	130-26669	
		FOXCONN INTERCONNECT TECHNOLOGY LIMITED	CUBB01M-HC3 04-DH	
		LuXshare	L99U2017-CS-H	
Earphone	-	Jiangxi Lianchuang Hongsheng Electronic Co., LTD.	MEND1532B528 A02	-
		BOLUO COUNTY QUANCHENG ELECTRONIC CO.,LTD.	1293-3283-3.5m m-322	

### 3.2 DESCRIPTION OF TEST MODES

To investigate the maximum EMI emission characteristics generates from EUT, the test system was pre-scanning tested base on the consideration of following EUT operation mode or test configuration mode which possible have effect on EMI emission level. Each of these EUT operation mode(s) or test configuration mode(s) mentioned above was evaluated respectively.

Pretest Mode	Description
Mode 1	TX Mode

The EUT system operated these modes were found to be the worst case during the pre-scanning test as following:

For Radiated Emission	
Final Test Mode	Description
Mode 1	TX Mode

Note:

- (1) Radiated Emissions of middle channel is performed and Band edge of high and low channels are performed.

### 3.3 TABLE OF PARAMETERS OF TEXT SOFTWARE SETTING

During testing, channel & power controlling software provided by the customer was used to control the operating channel as well as the output power level. The RF output power selection is for the setting of RF output power expected by the customer and is going to be fixed on the firmware of the final end product power parameters of FHSS

Test Software Version	BluetoothRfTest		
Frequency (MHz)	2402	2441	2480
Parameters(1Mbps)	N/A	N/A	N/A
Parameters(3Mbps)	N/A	N/A	N/A

### 3.4 BLOCK DIAGRAM SHOWING THE CONFIGURATION OF SYSTEM TESTED

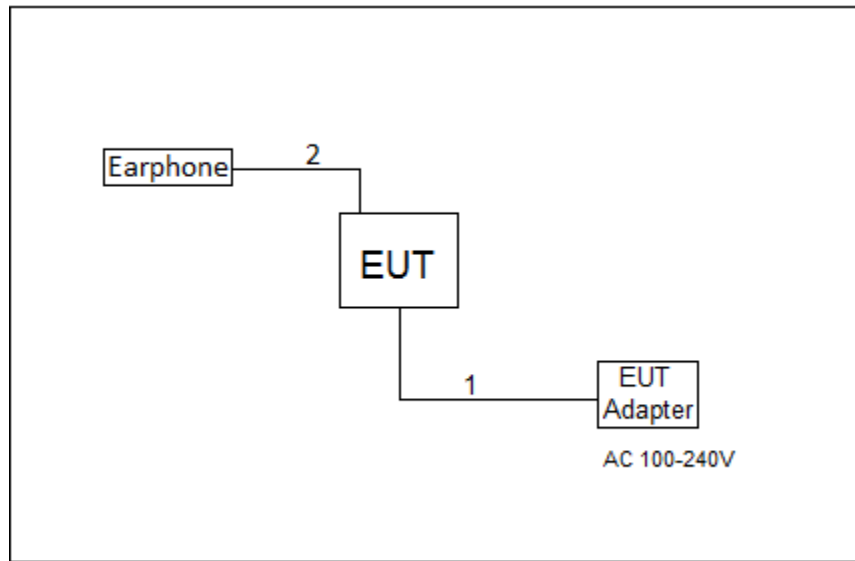

### 3.5 DESCRIPTION OF SUPPORT UNITS

The EUT has been tested as an independent unit together with other necessary accessories or support units. The following support units or accessories were used to form a representative test configuration during the tests.

Item	Equipment	Mfr/Brand	Model/Type No.	FCC ID	Series No.
A	-	-	-	-	-

Item	Shielded Type	Ferrite Core	Length	Note
1	NO	NO	1.2m	DC Cable
2	NO	NO	1m	Audio Cable

## 4. EMC EMISSION TEST

### 4.1 RADIATED EMISSION MEASUREMENT

#### 4.1.1 RADIATED EMISSION LIMITS

In case the emission fall within the restricted band specified on 15.205(a), then the 15.209(a) limit in the table below has to be followed.

LIMITS OF RADIATED EMISSION MEASUREMENT (9 kHz-1000 MHz)

Frequency (MHz)	Field Strength (microvolts/meter)	Measurement Distance (meters)
0.009~0.490	2400/F(kHz)	300
0.490~1.705	24000/F(kHz)	30
1.705~30.0	30	30
30~88	100	3
88~216	150	3
216~960	200	3
960~1000	500	3

LIMITS OF RADIATED EMISSION MEASUREMENT (Above 1000 MHz)

Frequency (MHz)	Band edge at 3m (dBµV/m) / Harmonic at 3m (dBµV/m)		Harmonic at 1.5m (dBµV/m)	
	Peak	Average	Peak	Average
Above 1000	74	54	80 (Note 5)	60 (Note 5)

Note:

- (1) The limit for radiated test was performed according to FCC PART 15C.
- (2) The tighter limit applies at the band edges.
- (3) Emission level (dBuV/m)=20log Emission level (uV/m).
- (4) The test result calculated as following:  
 Measurement Value = Reading Level + Correct Factor  
 Correct Factor = Antenna Factor + Cable Loss - Amplifier Gain(if use)  
 Margin Level = Measurement Value - Limit Value

(5)

$$FS_{\text{limit}} = FS_{\text{max}} - 20 \log \left( \frac{d_{\text{limit}}}{d_{\text{measure}}} \right)$$

$$20 \log d_{\text{limit}}/d_{\text{measure}} = 20 \log 3/1.5 = 6 \text{ dB.}$$

Spectrum Parameter	Setting
Attenuation	Auto
Start Frequency	1000 MHz
Stop Frequency	10th carrier harmonic
RBW / VBW (emission in restricted band)	1 MHz / 1 MHz for Peak, 1 MHz / 10Hz for Average

Spectrum Receiver Parameter	Setting
Attenuation	Auto
Start ~ Stop Frequency	9 kHz~90 kHz for PK/AVG detector
Start ~ Stop Frequency	90 kHz~110 kHz for QP detector
Start ~ Stop Frequency	110 kHz~490 kHz for PK/AVG detector
Start ~ Stop Frequency	490 kHz~30 MHz for QP detector
Start ~ Stop Frequency	30 MHz~1000 MHz for QP detector

#### 4.1.2 TEST PROCEDURE

- a. The measuring distance of 3 m shall be used for measurements. The EUT was placed on the top of a rotating table 0.8 meter above the ground at a 3 meter semi-anechoic chamber. The table was rotated 360 degrees to determine the position of the highest radiation.(below 1 GHz)
- b. The measuring distance of 3 m or 1.5m shall be used for measurements. The EUT was placed on the top of a rotating table 1.5 meter above the ground at a 3 meter semi-anechoic chamber. The table was rotated 360 degrees to determine the position of the highest radiation.(above 1GHz)
- c. The height of the equipment or of the substitution antenna shall be 0.8m or 1.5m; the height of the test antenna shall vary between 1 m to 4 m. Both horizontal and vertical polarizations of the antenna are set to make the measurement.
- d. For each suspected emission, the EUT was arranged to its worst case and then the antenna was tuned to heights find the maximum reading (used Bore sight function).
- e. The receiver system was set to peak and average detect function and specified bandwidth with maximum hold mode when the test frequency is above 1 GHz.
- f. The initial step in collecting radiated emission data is a receiver peak detector mode pre-scanning the measurement frequency range. Significant peaks are then marked and then Quasi Peak detector mode re-measured.
- g. All readings are Peak unless otherwise stated QP in column of Note. Peak denotes that the Peak reading compliance with the QP Limits and then QP Mode measurement didn't perform. (below 1 GHz)
- h. All readings are Peak Mode value unless otherwise stated AVG in column of Note. If the Peak Mode Measured value compliance with the Peak Limits and lower than AVG Limits, the EUT shall be deemed to meet both Peak & AVG Limits and then only Peak Mode was measured, but AVG Mode didn't perform. (above 1 GHz)
- i. For the actual test configuration, please refer to the related Item –EUT Test Photos.

#### 4.1.3 DEVIATION FROM TEST STANDARD

No deviation

**4.1.4 TEST SETUP**

(A) Radiated Emission Test Set-Up Frequency 30 MHz-1000 MHz

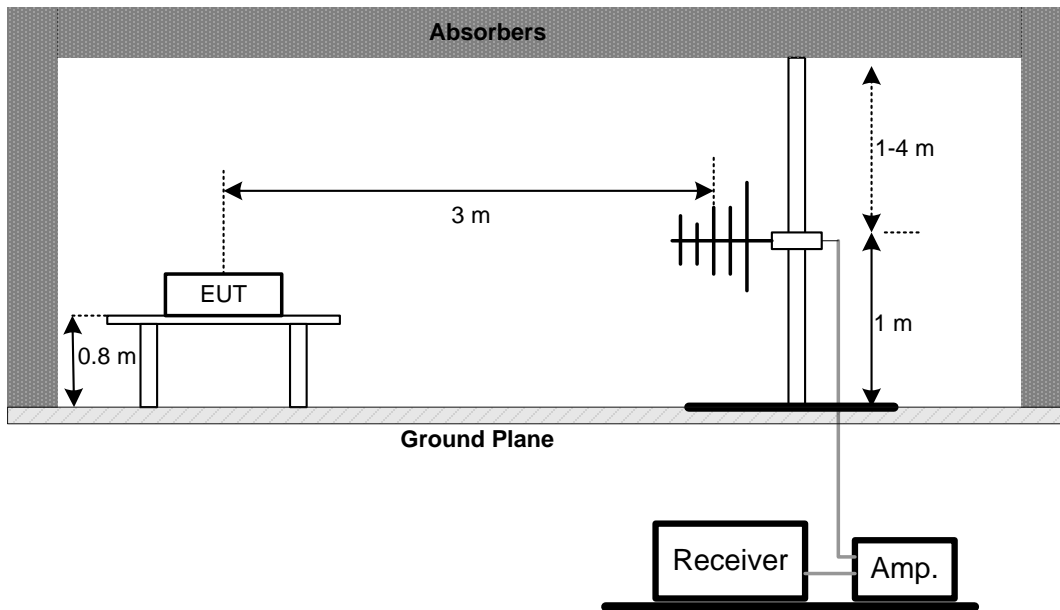

(B) Radiated Emission Test Set-Up Frequency Above 1 GHz  
Band edge

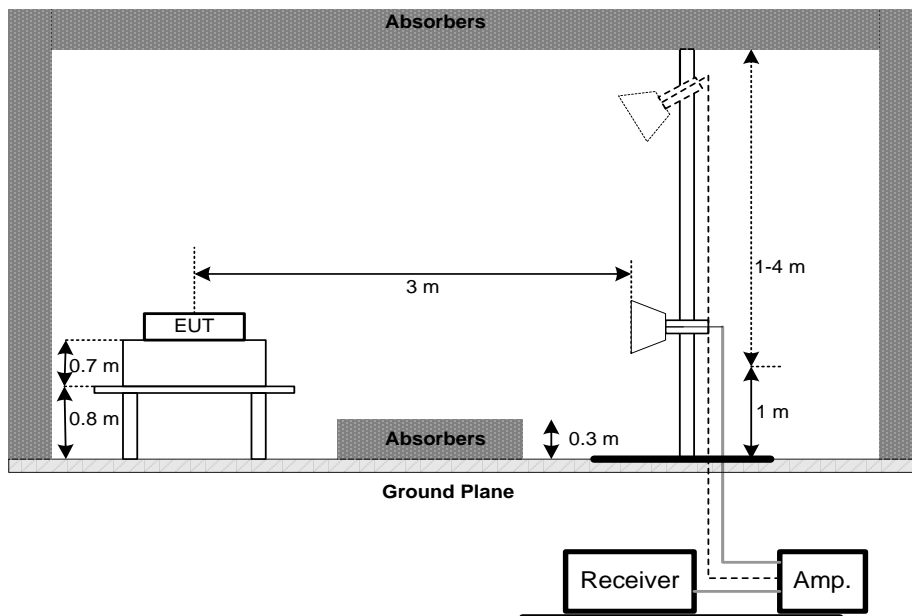

**Harmonic  
1GHz to 18GHz**

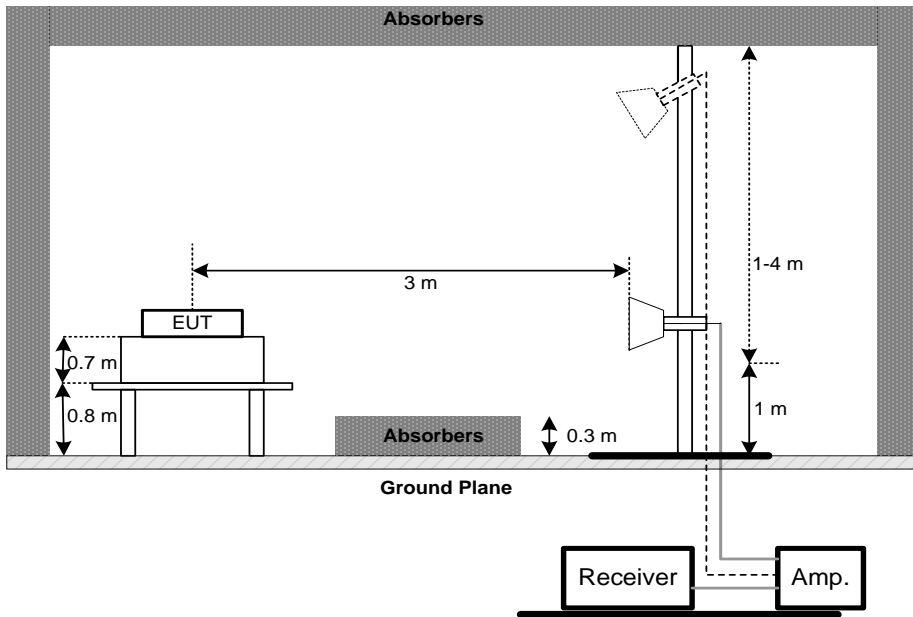

**18GHz to 26.5GHz**

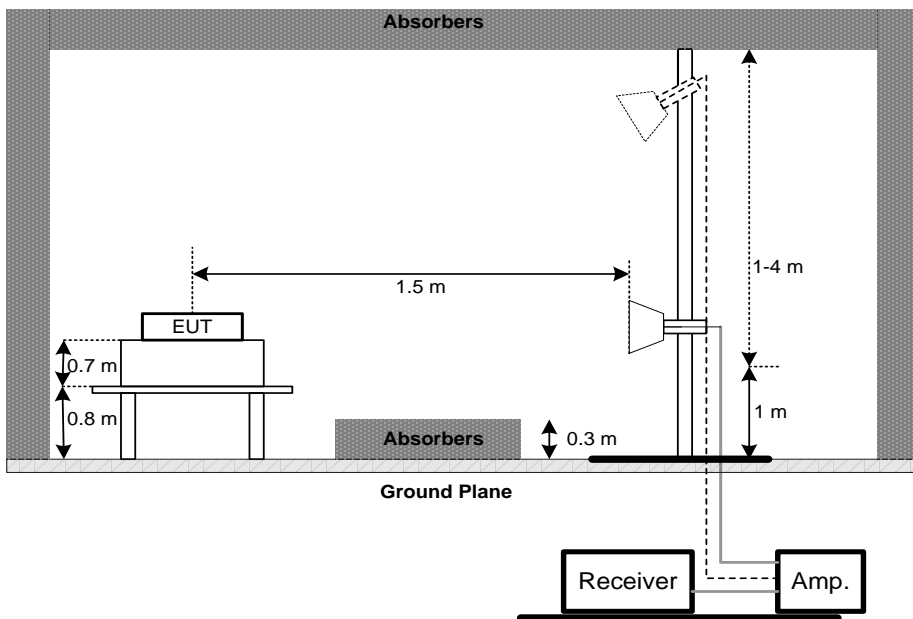



(C) For Radiated Emissions 9 kHz-30 MHz

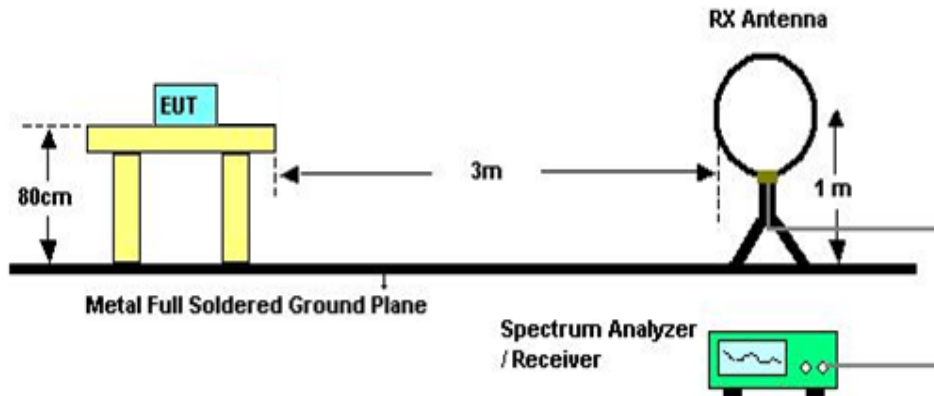

#### 4.1.5 EUT OPERATING CONDITIONS

The EUT was programmed to be in continuously transmitting mode.

#### 4.1.6 EUT TEST CONDITIONS

Temperature: 25°C

Relative Humidity: 60%

Test Voltage: AC 120V/60Hz

#### 4.1.7 TEST RESULTS (9 kHz TO 30 MHz)

Please refer to the Appendix A

Remark:

- (1) The amplitude of spurious emissions which are attenuated by more than 20 dB below the permissible value has no need to be reported.
- (2) Distance extrapolation factor =  $40 \log(\text{specific distance} / \text{test distance})$  (dB).
- (3) Limit line = specific limits (dBuV) + distance extrapolation factor.
- (4) All adapters had been pre-test and in this report only recorded the worst case.

#### 4.1.8 TEST RESULTS (30 MHz TO 1000 MHz)

Please refer to the Appendix B.

Remark:

- (1) All adapters had been pre-test and in this report only recorded the worst case.

#### 4.1.9 TEST RESULTS (ABOVE 1000 MHz)

Please refer to the Appendix C.

Remark:

- (1) No limit: This is fundamental signal, the judgment is not applicable.  
For fundamental signal judgment was referred to Peak output test.

## 5. MEASUREMENT INSTRUMENTS LIST

Radiated Emission Measurement - 9kHz TO 30 MHz					
Item	Kind of Equipment	Manufacturer	Type No.	Serial No.	Calibrated until
1	Loop Antenna	EM	EM-6876-1	230	Feb. 07, 2019
2	Cable	N/A	RG 213/U	C-102	Jun. 01, 2019
3	EMI Test Receiver	R&S	ESCI	100382	Mar. 11, 2019
4	Measurement Software	Farad	EZ-EMC Ver.NB-03A1-01	N/A	N/A

Radiated Emission Measurement – 30 MHz TO 1000 MHz					
Item	Kind of Equipment	Manufacturer	Type No.	Serial No.	Calibrated until
1	Antenna	Schwarbeck	VULB9160	9160-3232	Mar. 11, 2019
2	Amplifier	HP	8447D	2944A09673	Aug. 11, 2019
3	Receiver	Agilent	N9038A	MY52130039	Aug. 11, 2019
4	Cable	emci	LMR-400(30MHz-1 GHz)(8m+5m)	N/A	May 25, 2019
5	Controller	CT	SC100	N/A	N/A
6	Controller	MF	MF-7802	MF780208416	N/A
7	Measurement Software	Farad	EZ-EMC Ver.NB-03A1-01	N/A	N/A

Radiated Emission Measurement - Above 1 GHz					
Item	Kind of Equipment	Manufacturer	Type No.	Serial No.	Calibrated until
1	Double Ridged Guide Antenna	ETS	3115	75789	Mar. 11, 2019
2	Broad-Band Horn Antenna	Schwarzbeck	BBHA 9170	9170319	Jun. 30, 2019
3	Amplifier	Agilent	8449B	3008A02274	Mar. 11, 2019
4	Microwave Preamplifier With Adaptor	EMC INSTRUMENT	EMC2654045	980039 & HA01	Mar. 11, 2019
5	Receiver	Agilent	N9038A	MY52130039	Aug. 11, 2019
6	Controller	CT	SC100	N/A	N/A
7	Controller	MF	MF-7802	MF780208416	N/A
8	Cable	mitron	B10-01-01-12M	18072744	Jul. 30, 2019
9	Measurement Software	Farad	EZ-EMC Ver.NB-03A1-01	N/A	N/A

Remark "N/A" denotes no model name, serial no. or calibration specified.  
All calibration period of equipment list is one year.

## APPENDIX A - RADIATED EMISSION (9 KHZ-30 MHZ)

Test Mode: TX Mode

Ant 0°

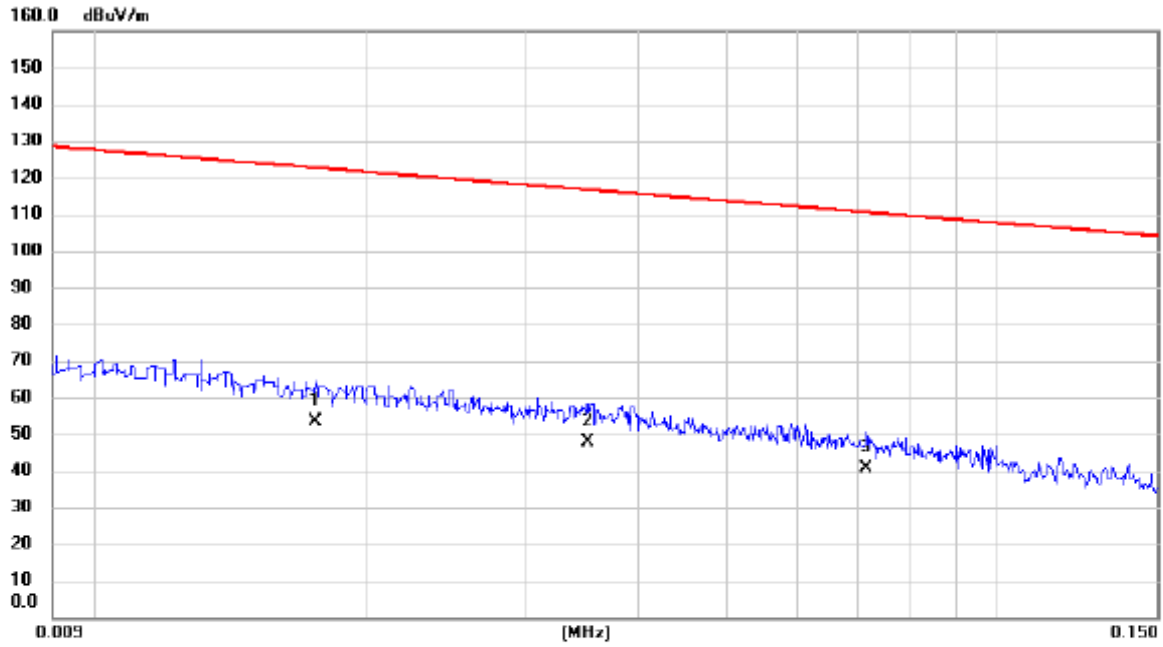

No.	Mk.	Freq. MHz	Reading Level dBuV	Correct Factor dB	Measure- ment dBuV/m	Limit dBuV/m	Margin dB	Detector	Comment
1		0.0176	33.10	20.36	53.46	122.69	-69.23	AVG	
2	*	0.0352	28.20	19.77	47.97	116.67	-68.70	AVG	
3		0.0716	21.40	19.10	40.50	110.51	-70.01	AVG	

Test Mode: TX Mode

Ant 0°

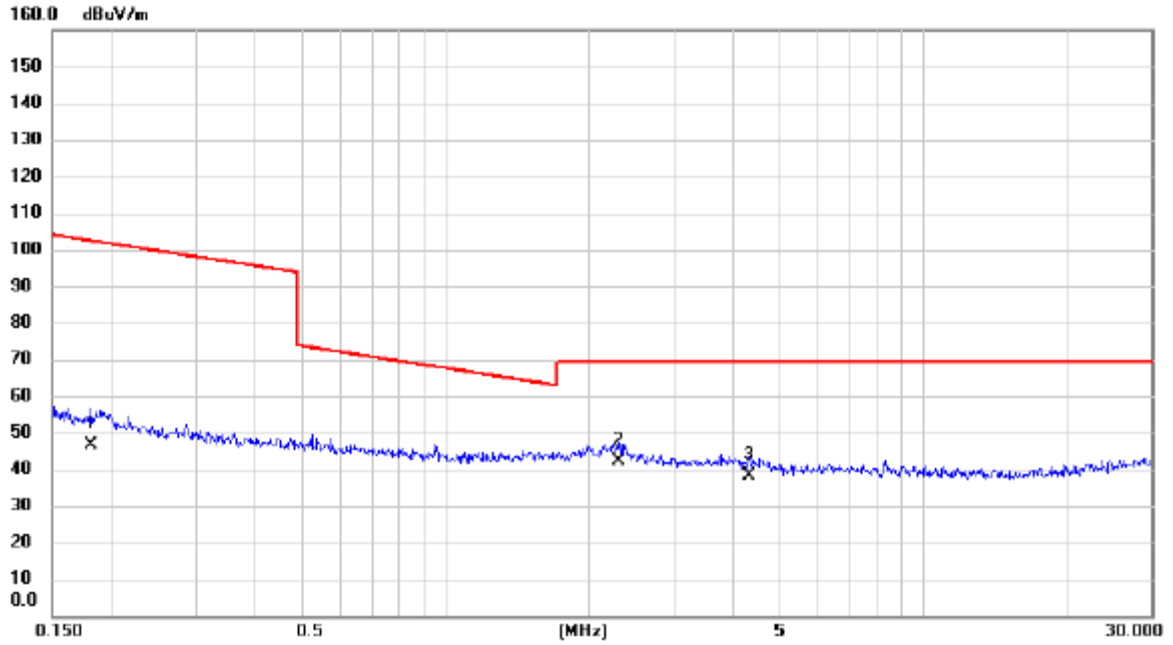

No.	Mk.	Freq. MHz	Reading Level dBuV	Correct Factor dB	Measure- ment dBuV/m	Limit dBuV/m	Margin dB	Detector	Comment
1		0.1806	29.50	17.19	46.69	102.47	-55.78	AVG	
2	*	2.2968	25.40	16.94	42.34	69.54	-27.20	QP	
3		4.3146	22.70	15.57	38.27	69.54	-31.27	QP	

Test Mode: TX Mode

Ant 90°

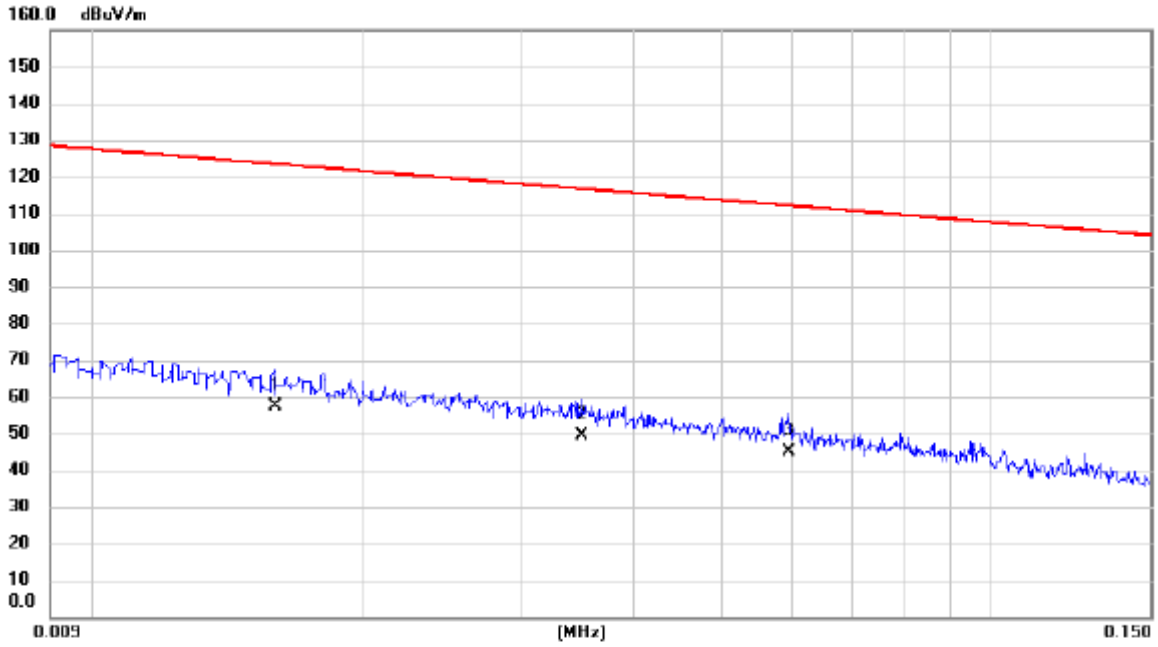

No.	Mk.	Freq. MHz	Reading Level dBuV	Correct Factor dB	Measure- ment dBuV/m	Limit dBuV/m	Margin dB	Detector	Comment
1	*	0.0160	36.71	20.58	57.29	123.52	-66.23	AVG	
2		0.0350	29.70	19.77	49.47	116.72	-67.25	AVG	
3		0.0594	25.80	19.34	45.14	112.13	-66.99	AVG	

Test Mode: TX Mode

Ant 90°

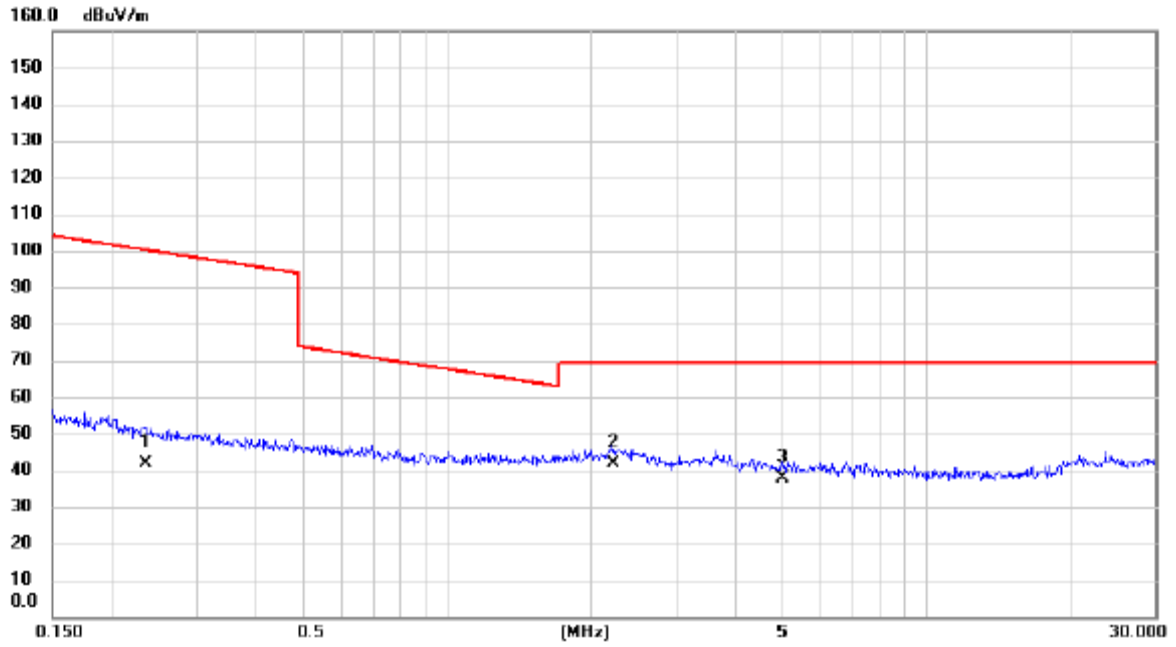

No.	Mk.	Freq. MHz	Reading Level dBuV	Correct Factor dB	Measure- ment dBuV/m	Limit dBuV/m	Margin dB	Detector	Comment
1		0.2341	24.90	17.08	41.98	100.22	-58.24	AVG	
2	*	2.2132	24.70	16.98	41.68	69.54	-27.86	QP	
3		5.0046	22.50	15.17	37.67	69.54	-31.87	QP	

## APPENDIX B - RADIATED EMISSION (30 MHZ TO 1000 MHZ)



Test Mode: TX 2441 MHz \_CH39\_1Mbps

**Vertical**

80 dBuV/m

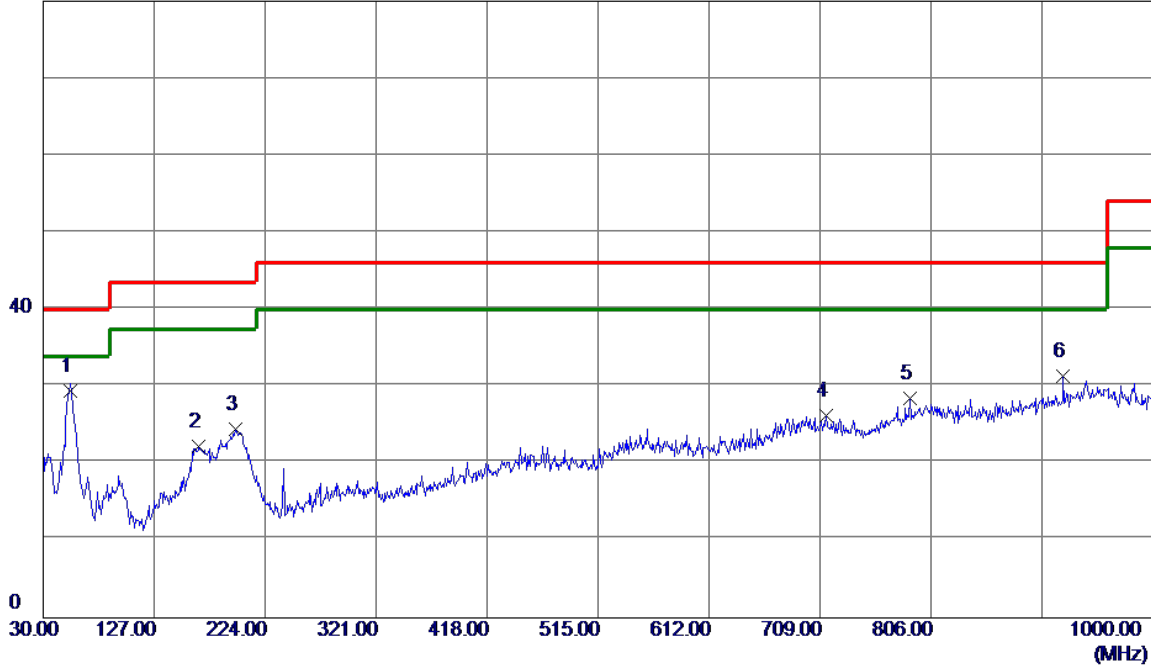

No.	Freq. MHz	Reading Level dBuV/m	Correct Factor dB	Measure ment dBuV/m	Limit dBuV/m	Margin dB	Detector	Comment
1 *	53.2800	44.36	-14.92	29.44	40.00	-10.56	QP	
2	166.2850	33.16	-10.98	22.18	43.50	-21.32	Peak	
3	198.2950	39.49	-15.06	24.43	43.50	-19.07	Peak	
4	714.8200	29.42	-3.13	26.29	46.00	-19.71	Peak	
5	787.5700	30.22	-1.79	28.43	46.00	-17.57	Peak	
6	921.4300	31.03	0.26	31.29	46.00	-14.71	Peak	

Test Mode: TX 2441 MHz \_CH39\_1Mbps

### Horizontal

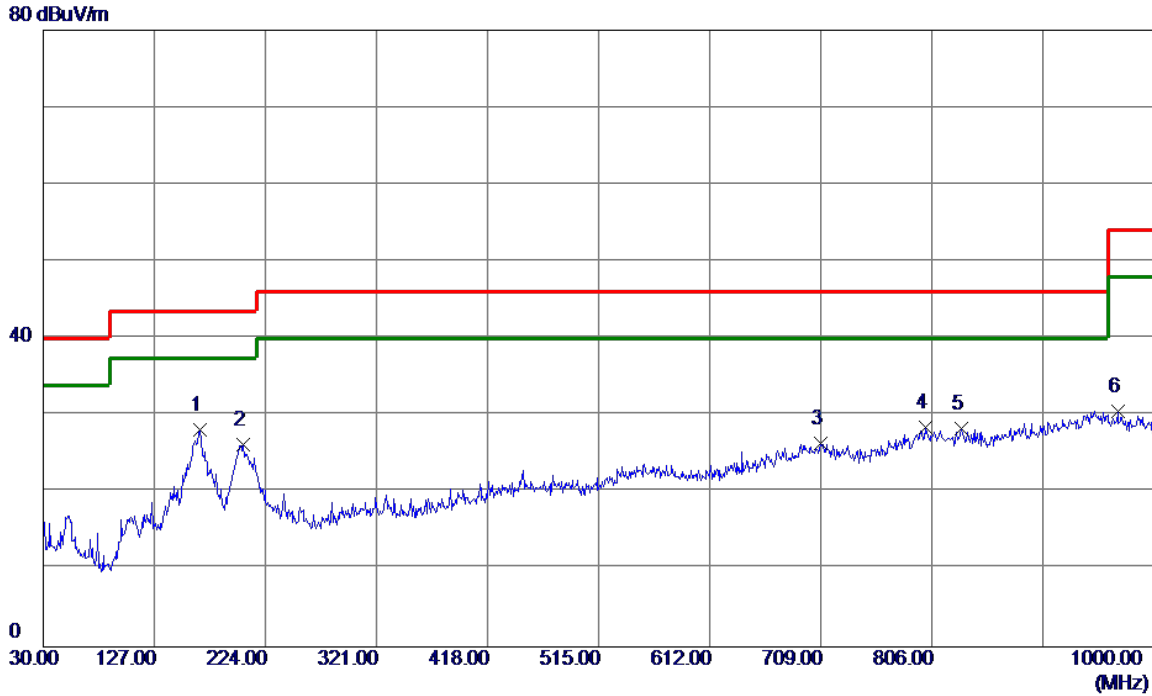

No.	Freq. MHz	Reading Level dBuV/m	Correct Factor dB	Measure ment dBuV/m	Limit dBuV/m	Margin dB	Detector	Comment
1 *	166.7700	39.13	-11.01	28.12	43.50	-15.38	Peak	
2	205.0850	41.48	-15.22	26.26	43.50	-17.24	Peak	
3	709.4850	29.45	-2.99	26.46	46.00	-19.54	Peak	
4	800.6650	29.54	-1.05	28.49	46.00	-17.51	Peak	
5	831.7050	29.78	-1.53	28.25	46.00	-17.75	Peak	
6	968.4750	29.66	0.97	30.63	54.00	-23.37	Peak	

## APPENDIX C - RADIATED EMISSION (ABOVE 1000 MHZ)

Test Mode: TX 2402 MHz \_CH00\_1Mbps

**Vertical**

130 dBuV/m

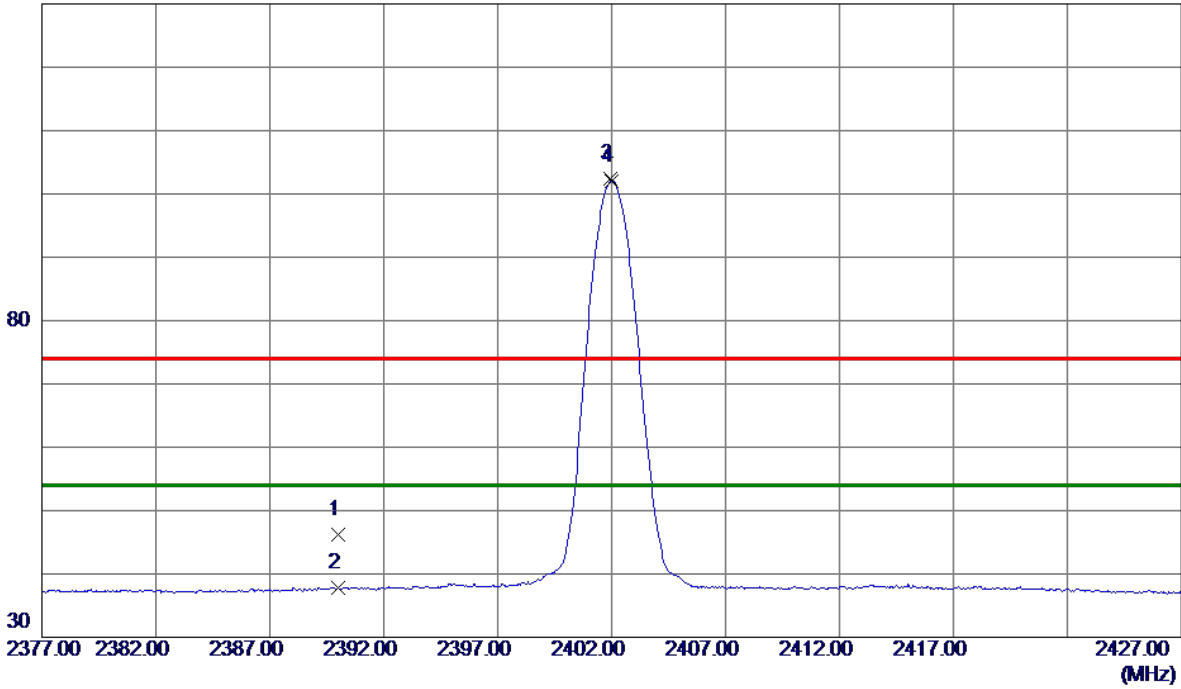

No.	Freq. MHz	Reading Level dBuV/m	Correct Factor dB	Measure ment dBuV/m	Limit dBuV/m	Margin dB	Detector	Comment
1	2390.0000	39.56	6.62	46.18	74.00	-27.82	Peak	
2	2390.0000	31.14	6.62	37.76	54.00	-16.24	AVG	
3	2401.9500	95.72	6.62	102.34	74.00	28.34	Peak	No Limit
4 *	2402.0000	95.46	6.62	102.08	54.00	48.08	AVG	No Limit

Test Mode: TX 2402 MHz \_CH00\_1Mbps

Horizontal

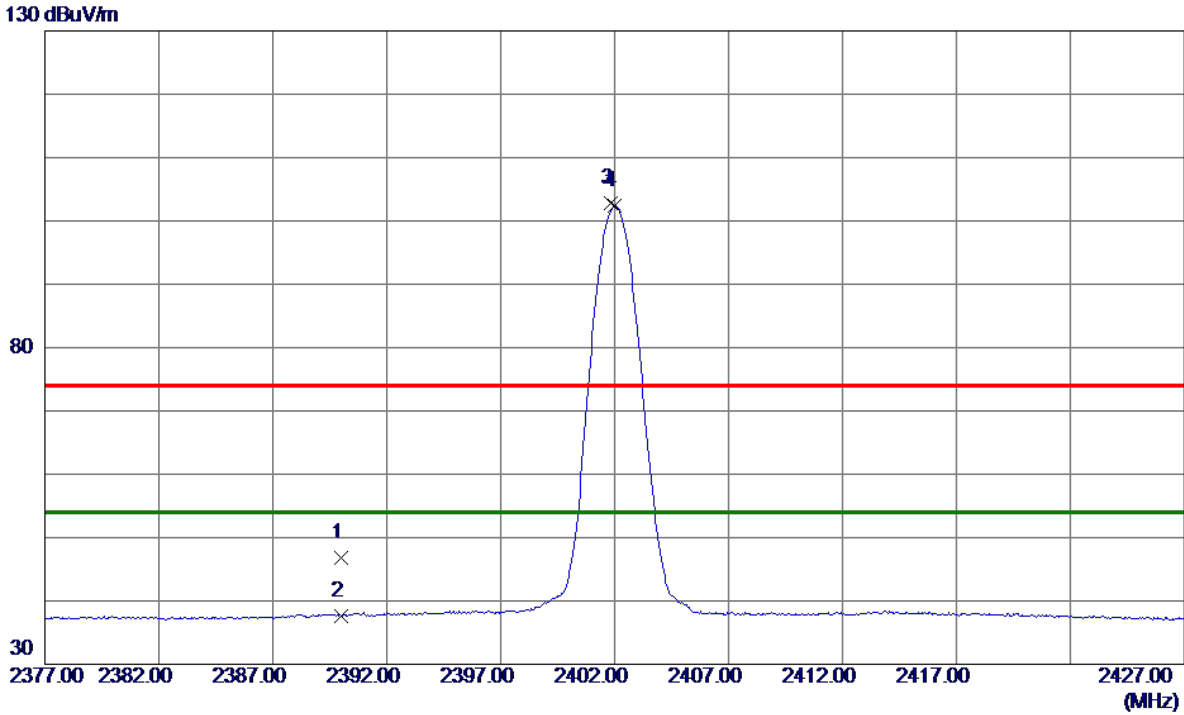

No.	Freq. MHz	Reading Level dBuV/m	Correct Factor dB	Measure ment dBuV/m	Limit dBuV/m	Margin dB	Detector	Comment
1	2390.0000	40.25	6.62	46.87	74.00	-27.13	Peak	
2	2390.0000	30.96	6.62	37.58	54.00	-16.42	AVG	
3	2401.8500	96.21	6.62	102.83	74.00	28.83	Peak	No Limit
4 *	2402.0000	95.76	6.62	102.38	54.00	48.38	AVG	No Limit

Test Mode: TX 2441 MHz \_CH39\_1Mbps

Vertical

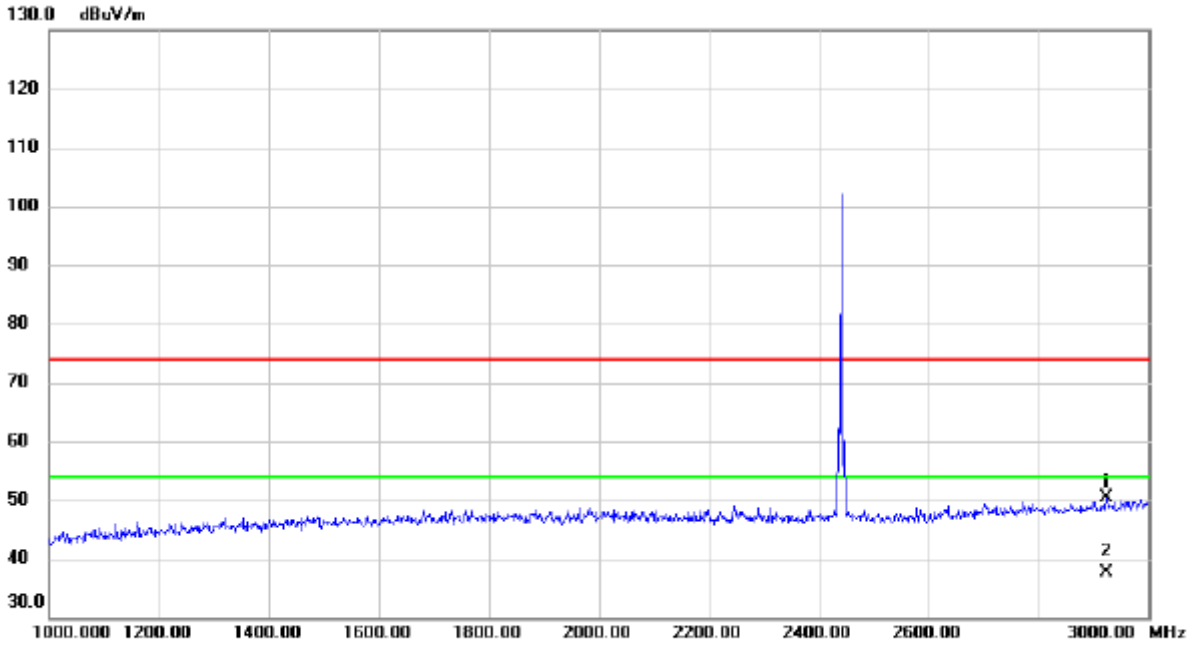

No.	Mk.	Freq.	Reading Level	Correct Factor	Measurement	Limit	Margin	Detector	Comment
		MHz	dBuV	dB	dBuV/m	dBuV/m	dB		
1		2925.000	40.99	9.46	50.45	74.00	-23.55	peak	
2	*	2925.000	28.15	9.46	37.61	54.00	-16.39	AVG	

Test Mode: TX 2441 MHz \_CH39\_1Mbps

Vertical

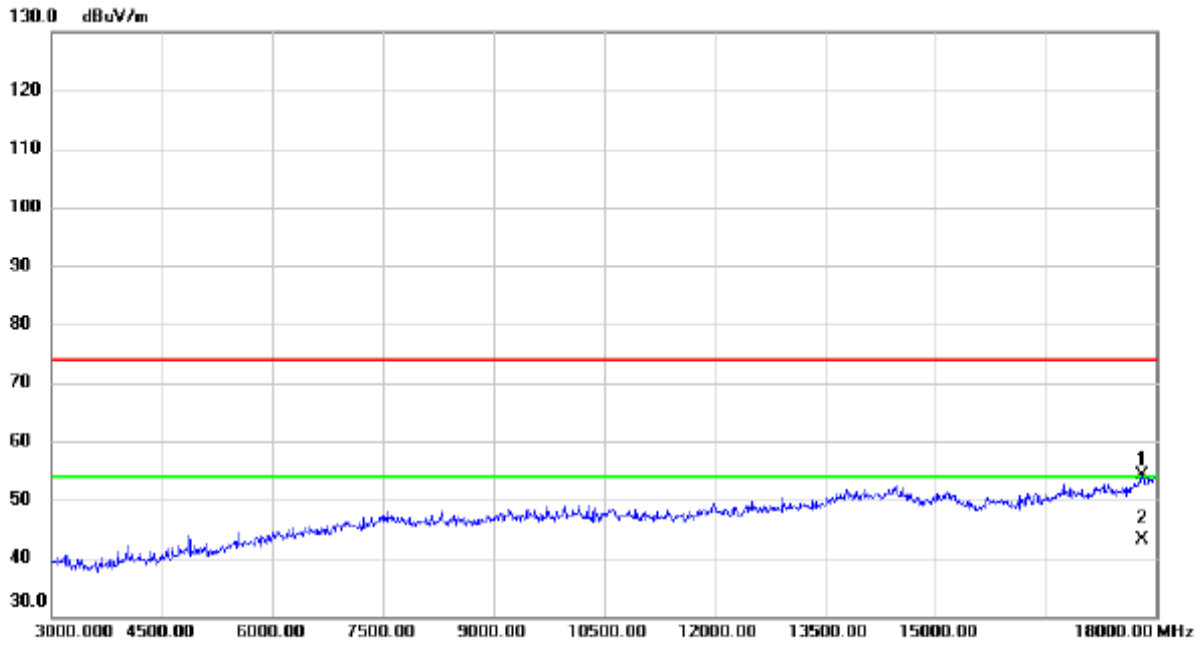

No.	Mk.	Freq. MHz	Reading Level dBuV	Correct Factor dB	Measure- ment dBuV/m	Limit dBuV/m	Margin dB	Detector	Comment
1		17805.000	35.35	18.79	54.14	74.00	-19.86	peak	
2	*	17805.000	24.32	18.79	43.11	54.00	-10.89	AVG	

Test Mode: TX 2441 MHz \_CH39\_1Mbps

Vertical

130 dBuV/m

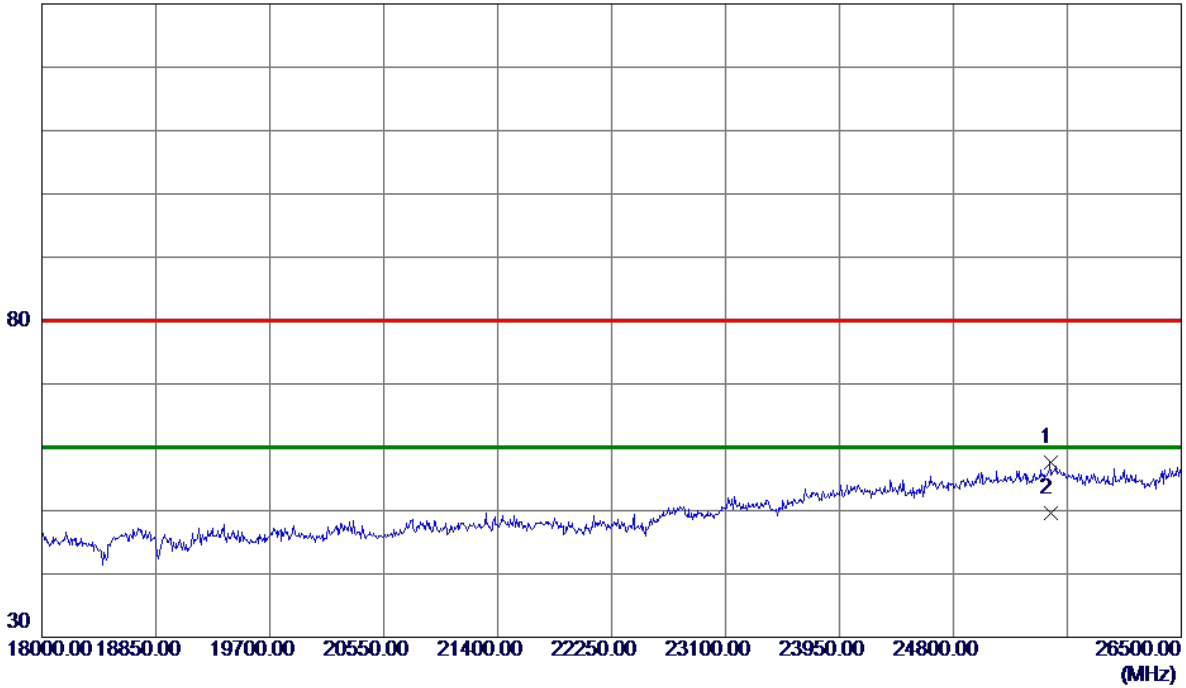

No.	Freq. MHz	Reading Level dBuV/m	Correct Factor dB	Measure ment dBuV/m	Limit dBuV/m	Margin dB	Detector	Comment
1	25522.5000	35.46	22.10	57.56	80.00	-22.44	Peak	
2 *	25522.5000	27.55	22.10	49.65	60.00	-10.35	AVG	



Test Mode: TX 2441 MHz \_CH39\_1Mbps

**Horizontal**

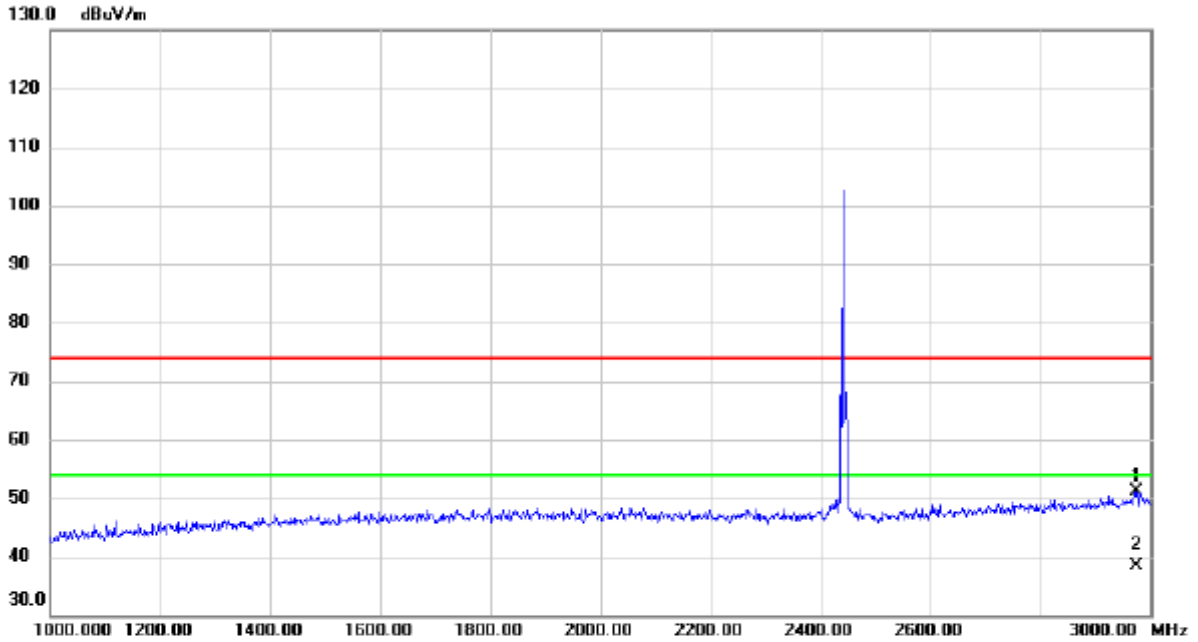

No.	Mk.	Freq. MHz	Reading Level dBuV	Correct Factor dB	Measure- ment dBuV/m	Limit dBuV/m	Margin dB	Detector	Comment
1		2974.000	41.38	9.78	51.16	74.00	-22.84	peak	
2	*	2974.000	28.65	9.78	38.43	54.00	-15.57	AVG	

Test Mode: TX 2441 MHz \_CH39\_1Mbps

Horizontal

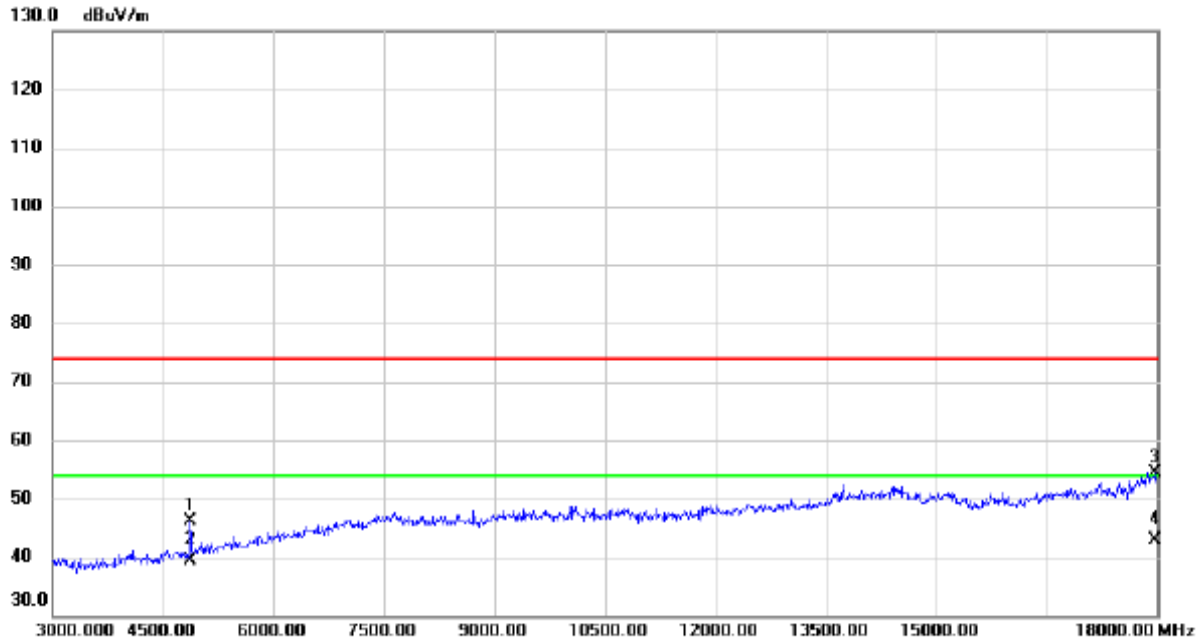

No.	Mk.	Freq. MHz	Reading Level dBuV	Correct Factor dB	Measure- ment dBuV/m	Limit dBuV/m	Margin dB	Detector	Comment
1		4867.500	42.42	3.67	46.09	74.00	-27.91	peak	
2		4867.500	35.67	3.67	39.34	54.00	-14.66	AVG	
3		17977.500	35.08	19.30	54.38	74.00	-19.62	peak	
4	*	17977.500	23.48	19.30	42.78	54.00	-11.22	AVG	

Test Mode: TX 2441 MHz \_CH39\_1Mbps

Horizontal

130 dBuV/m

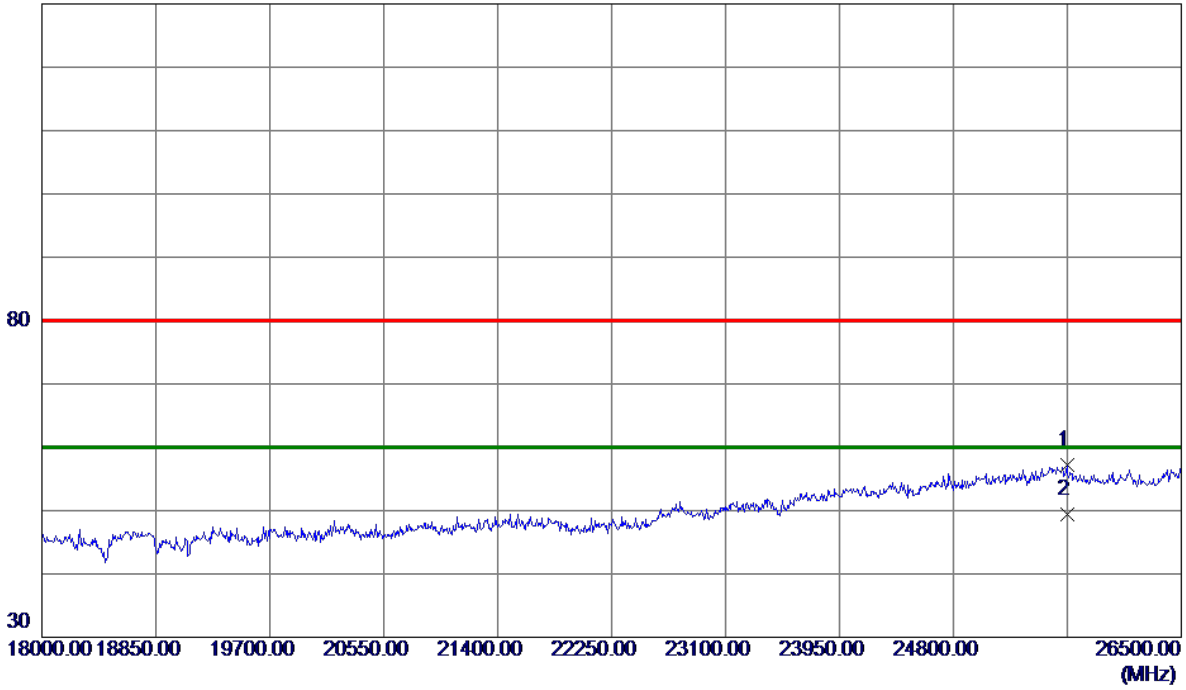

No.	Freq. MHz	Reading Level dBuV/m	Correct Factor dB	Measure ment dBuV/m	Limit dBuV/m	Margin dB	Detector	Comment
1	25645.7500	35.24	21.96	57.20	80.00	-22.80	Peak	
2 *	25645.7500	27.45	21.96	49.41	60.00	-10.59	AVG	

Test Mode: TX 2480 MHz \_CH78\_1Mbps

**Vertical**

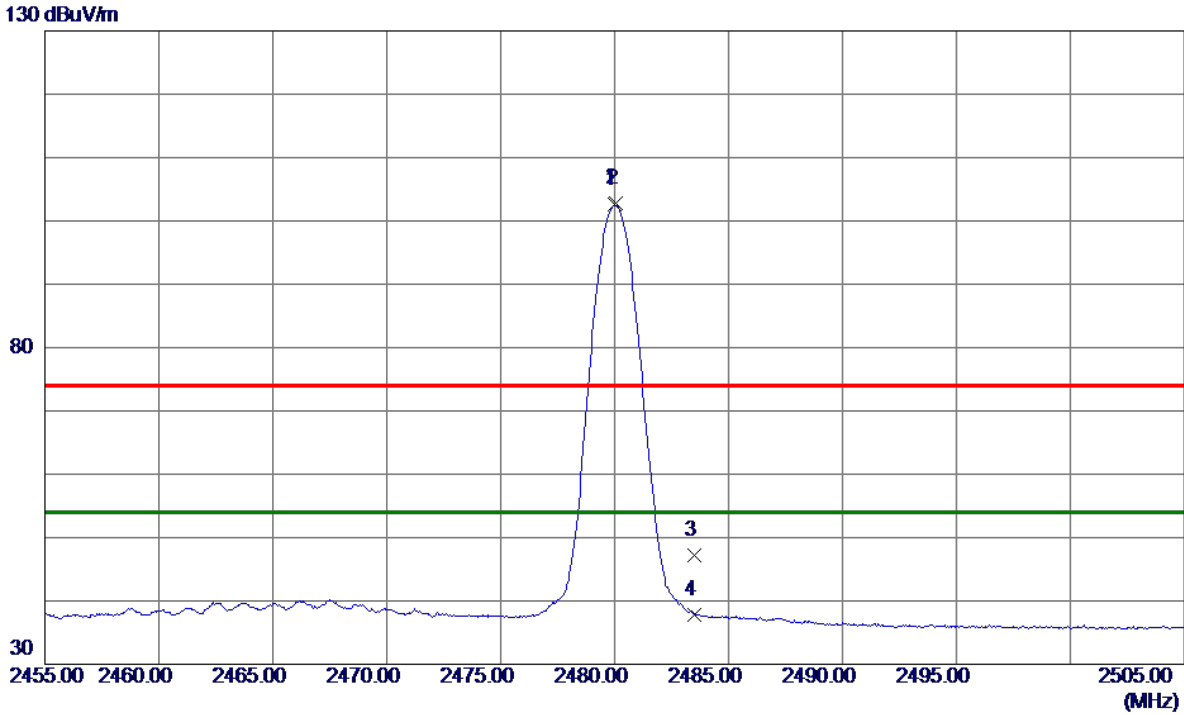

No.	Freq. MHz	Reading Level dBuV/m	Correct Factor dB	Measure ment dBuV/m	Limit dBuV/m	Margin dB	Detector	Comment
1 *	2480.0250	95.91	6.61	102.52	54.00	48.52	AVG	No Limit
2	2480.0750	96.24	6.61	102.85	74.00	28.85	Peak	No Limit
3	2483.5000	40.68	6.61	47.29	74.00	-26.71	Peak	
4	2483.5000	31.25	6.61	37.86	54.00	-16.14	AVG	

Test Mode: TX 2480 MHz \_CH78\_1Mbps

Horizontal

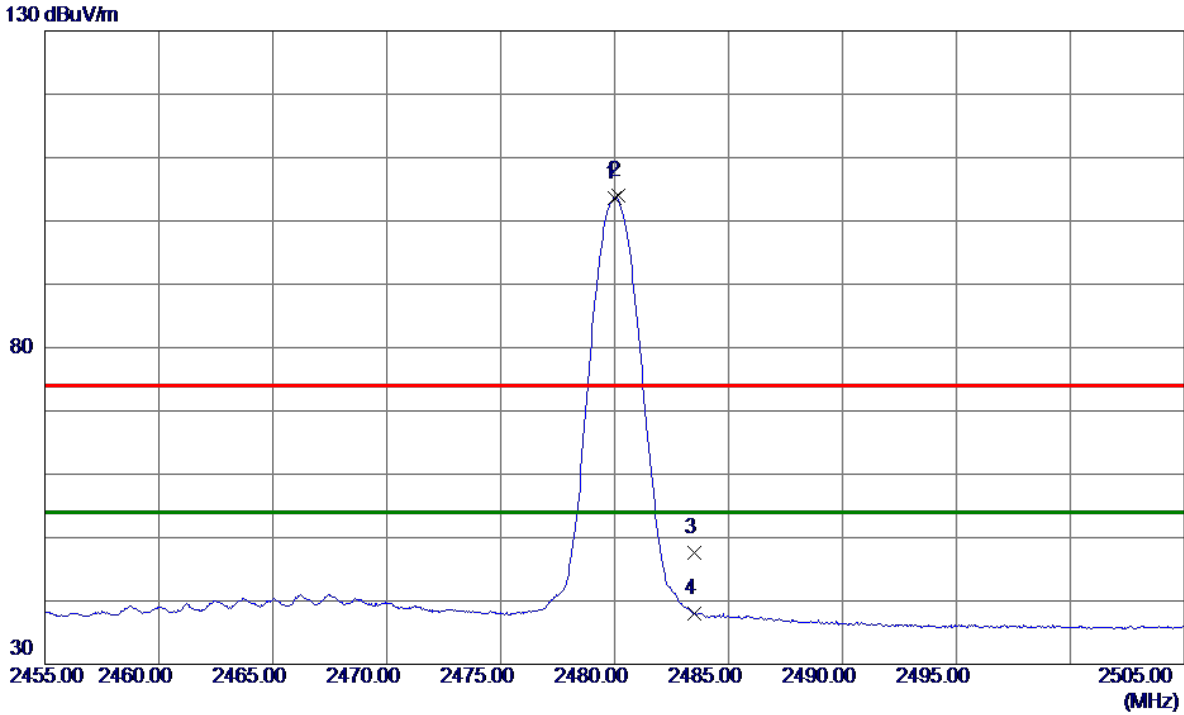

No.	Freq. MHz	Reading Level dBuV/m	Correct Factor dB	Measure ment dBuV/m	Limit dBuV/m	Margin dB	Detector	Comment
1 *	2480.0250	97.06	6.61	103.67	54.00	49.67	AVG	No Limit
2	2480.1500	97.43	6.61	104.04	74.00	30.04	Peak	No Limit
3	2483.5000	41.05	6.61	47.66	74.00	-26.34	Peak	
4	2483.5000	31.41	6.61	38.02	54.00	-15.98	AVG	

Test Mode: TX 2402 MHz \_CH00\_3Mbps

**Vertical**

130 dBuV/m

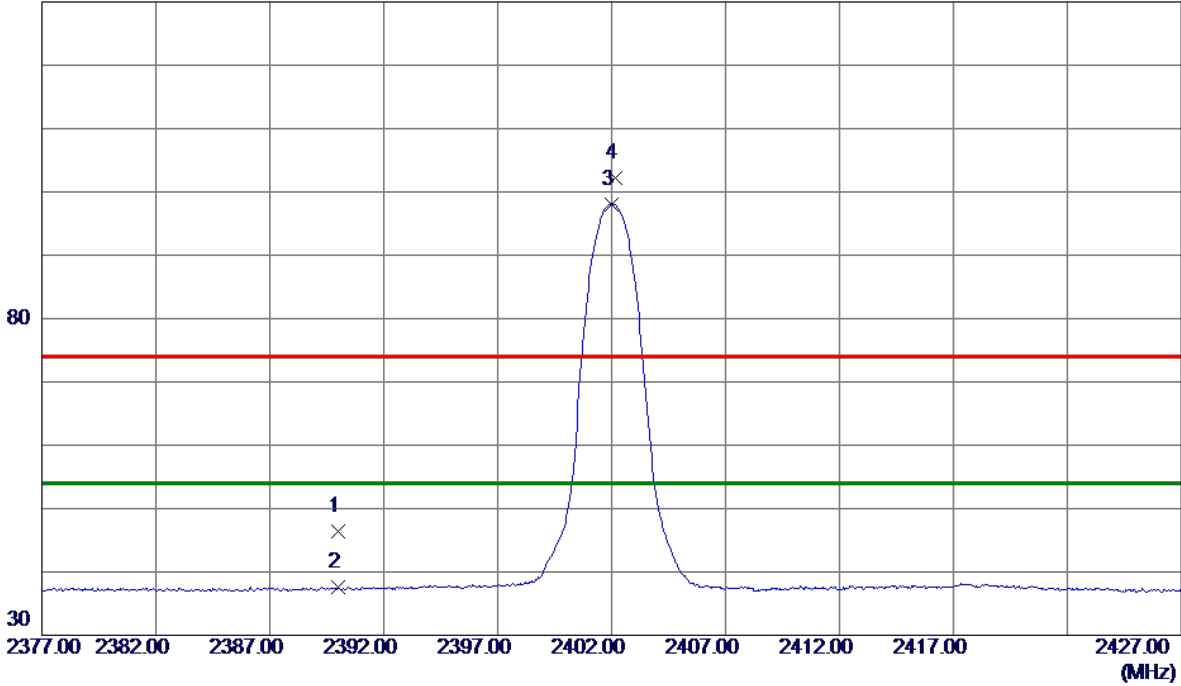

No.	Freq. MHz	Reading Level dBuV/m	Correct Factor dB	Measure ment dBuV/m	Limit dBuV/m	Margin dB	Detector	Comment
1	2390.0000	39.76	6.62	46.38	74.00	-27.62	Peak	
2	2390.0000	31.01	6.62	37.63	54.00	-16.37	AVG	
3 *	2402.0250	91.48	6.62	98.10	54.00	44.10	AVG	No Limit
4	2402.1500	95.50	6.62	102.12	74.00	28.12	Peak	No Limit

Test Mode: TX 2402 MHz \_CH00\_3Mbps

Horizontal

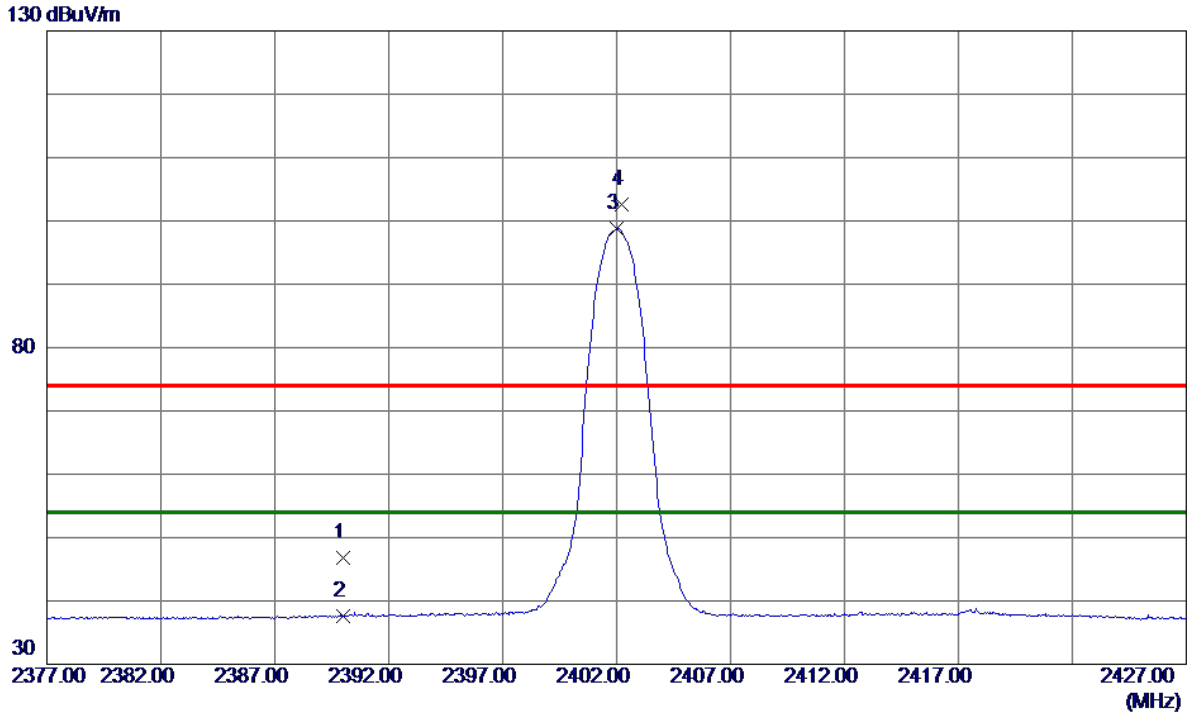

No.	Freq. MHz	Reading Level dBuV/m	Correct Factor dB	Measure ment dBuV/m	Limit dBuV/m	Margin dB	Detector	Comment
1	2390.0000	40.16	6.62	46.78	74.00	-27.22	Peak	
2	2390.0000	30.99	6.62	37.61	54.00	-16.39	AVG	
3 *	2402.0250	92.12	6.62	98.74	54.00	44.74	AVG	No Limit
4	2402.2000	96.02	6.62	102.64	74.00	28.64	Peak	No Limit

Test Mode: TX 2441 MHz \_CH39\_3Mbps

**Vertical**

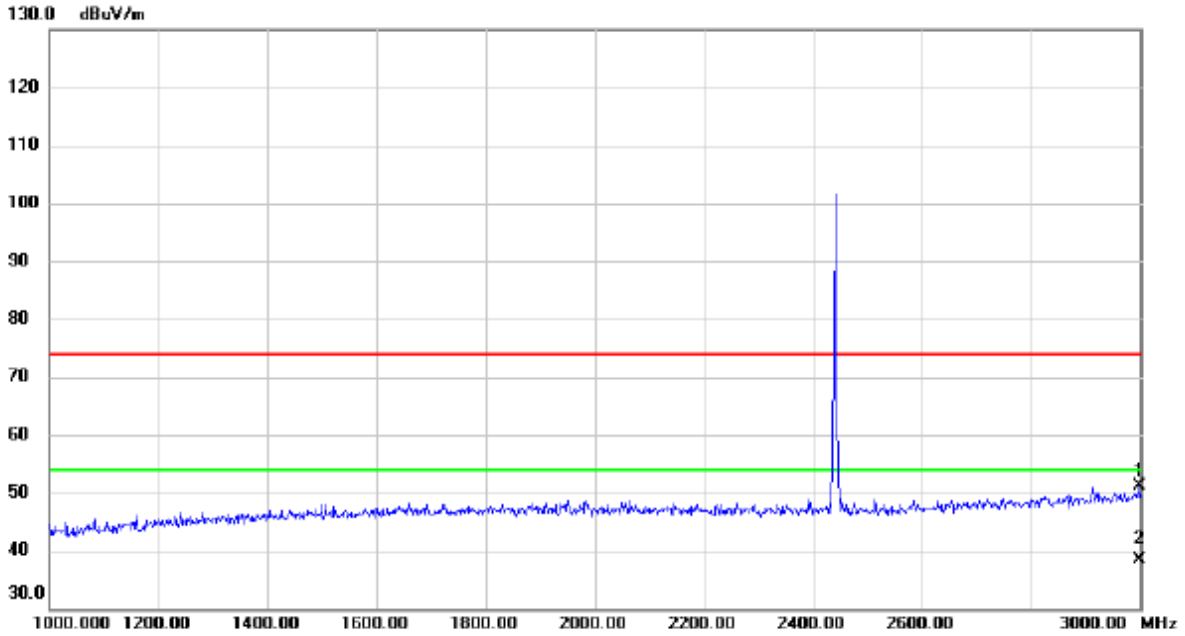

No.	Mk.	Freq. MHz	Reading Level dBuV	Correct Factor dB	Measure- ment dBuV/m	Limit dBuV/m	Margin dB	Detector	Comment
1		2999.000	41.07	9.95	51.02	74.00	-22.98	peak	
2	*	2999.000	28.35	9.95	38.30	54.00	-15.70	AVG	



Test Mode: TX 2441 MHz \_CH39\_3Mbps

Vertical

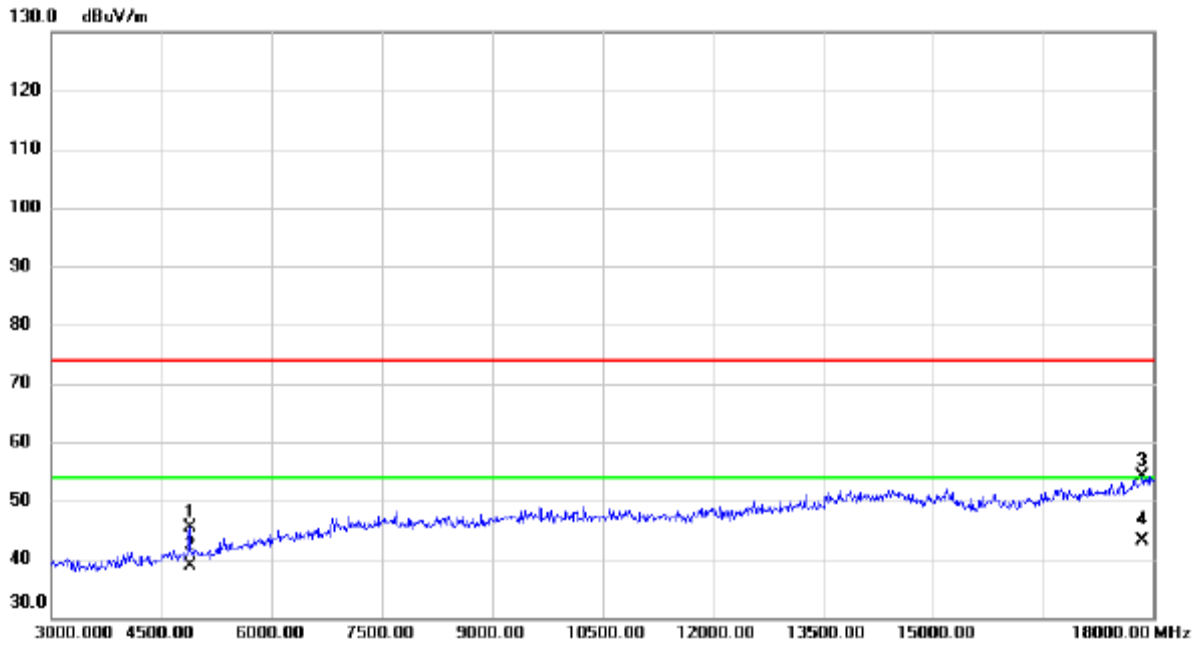

No.	Mk.	Freq. MHz	Reading Level dBuV	Correct Factor dB	Measure- ment dBuV/m	Limit dBuV/m	Margin dB	Detector	Comment
1		4882.500	41.65	3.71	45.36	74.00	-28.64	peak	
2		4882.500	35.15	3.71	38.86	54.00	-15.14	AVG	
3		17850.000	35.25	18.93	54.18	74.00	-19.82	peak	
4 *		17850.000	24.25	18.93	43.18	54.00	-10.82	AVG	

Test Mode: TX 2441 MHz \_CH39\_3Mbps

Vertical

130 dBuV/m

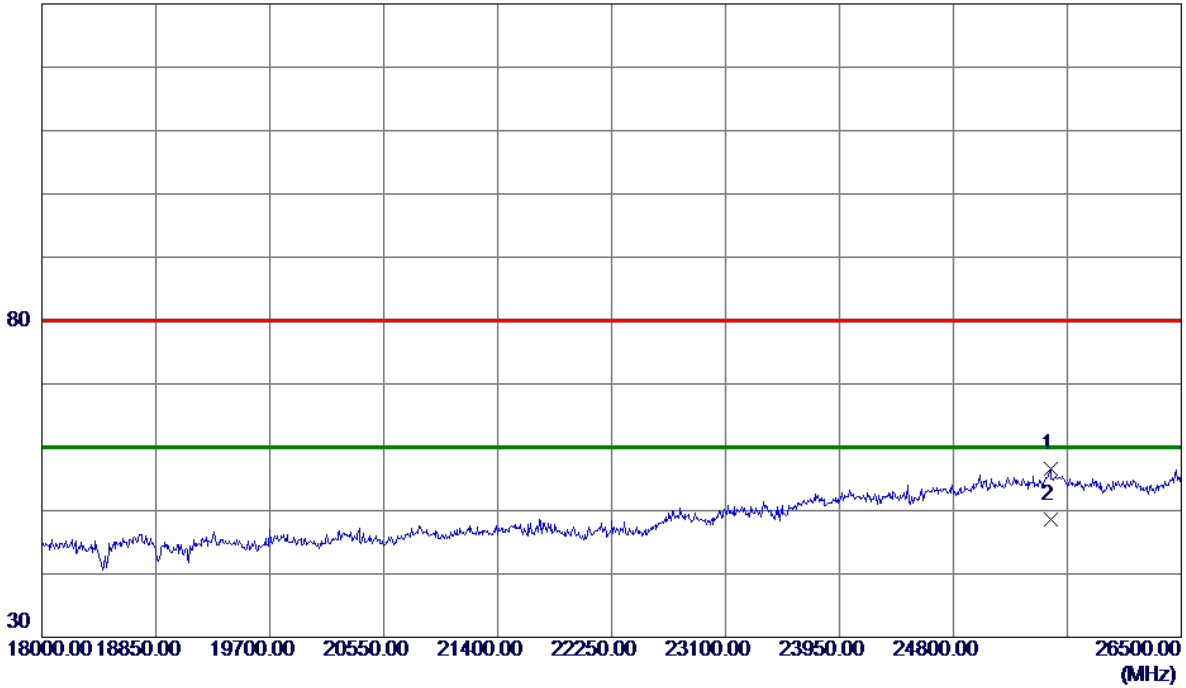

No.	Freq. MHz	Reading Level dBuV/m	Correct Factor dB	Measure ment dBuV/m	Limit dBuV/m	Margin dB	Detector	Comment
1	25526.7500	34.42	22.09	56.51	80.00	-23.49	Peak	
2 *	25526.7500	26.59	22.09	48.68	60.00	-11.32	AVG	

Test Mode: TX 2441 MHz \_CH39\_3Mbps

**Horizontal**

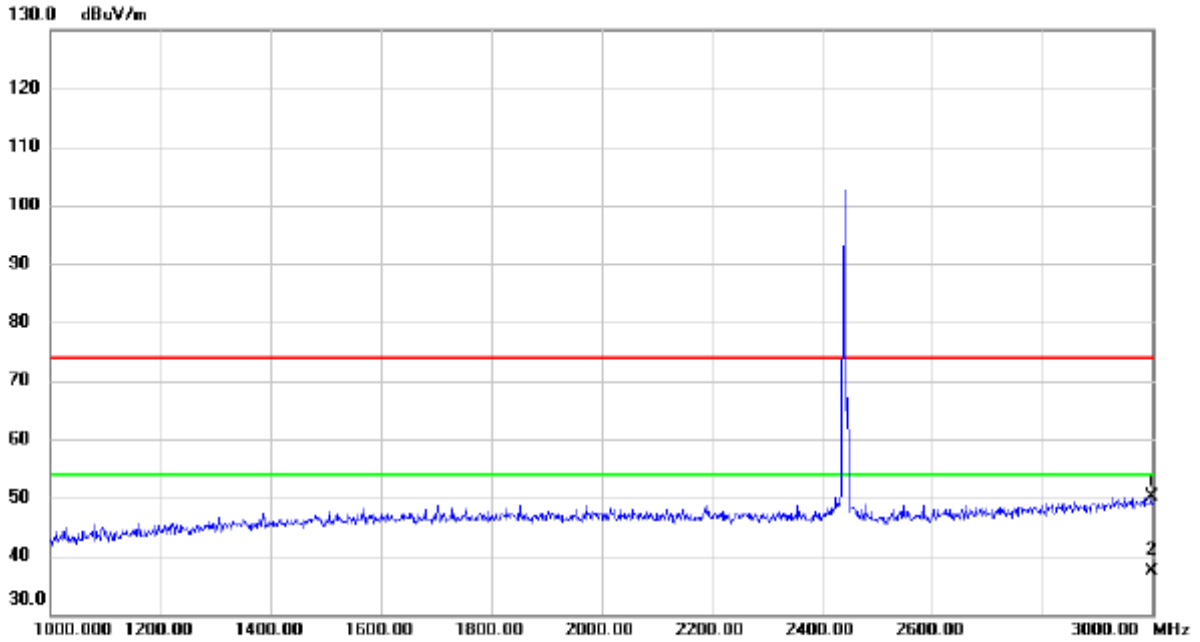

No.	Mk.	Freq. MHz	Reading Level dBuV	Correct Factor dB	Measure- ment dBuV/m	Limit dBuV/m	Margin dB	Detector	Comment
1		2999.000	40.24	9.95	50.19	74.00	-23.81	peak	
2	*	2999.000	27.36	9.95	37.31	54.00	-16.69	AVG	

Test Mode: TX 2441 MHz \_CH39\_3Mbps

Horizontal

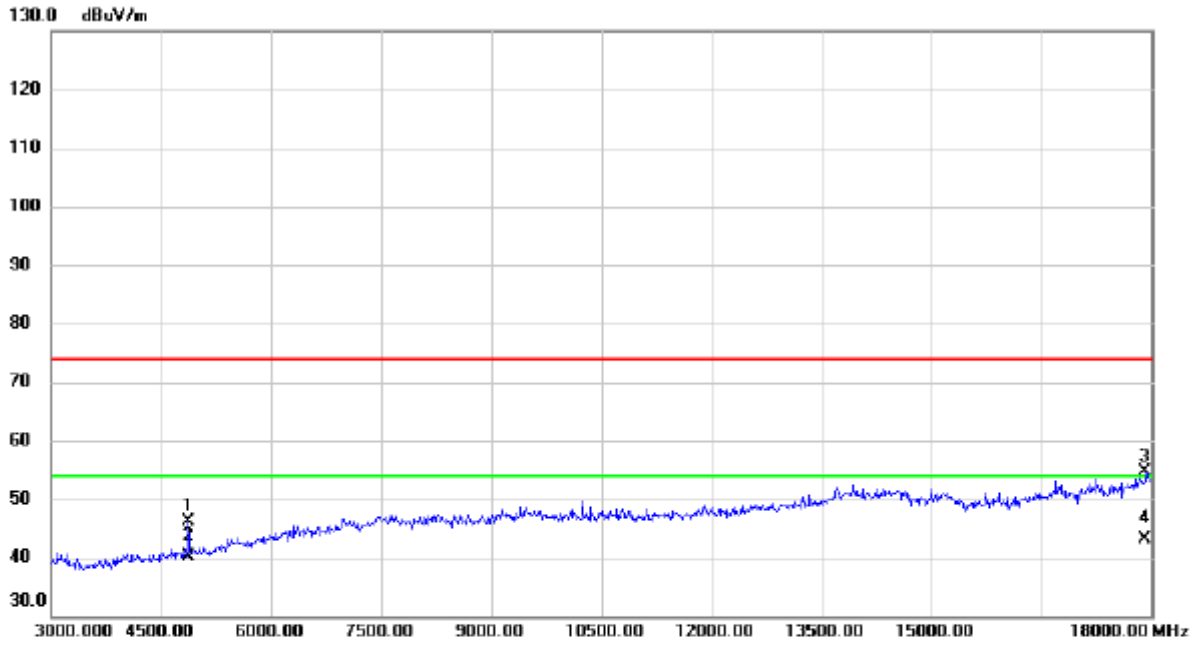

No.	Mk.	Freq. MHz	Reading Level dBuV	Correct Factor dB	Measure- ment dBuV/m	Limit dBuV/m	Margin dB	Detector	Comment
1		4867.500	42.36	3.67	46.03	74.00	-27.97	peak	
2		4867.500	36.58	3.67	40.25	54.00	-13.75	AVG	
3		17910.000	35.43	19.10	54.53	74.00	-19.47	peak	
4	*	17910.000	24.02	19.10	43.12	54.00	-10.88	AVG	

Test Mode: TX 2441 MHz \_CH39\_3Mbps

Horizontal

130 dBuV/m

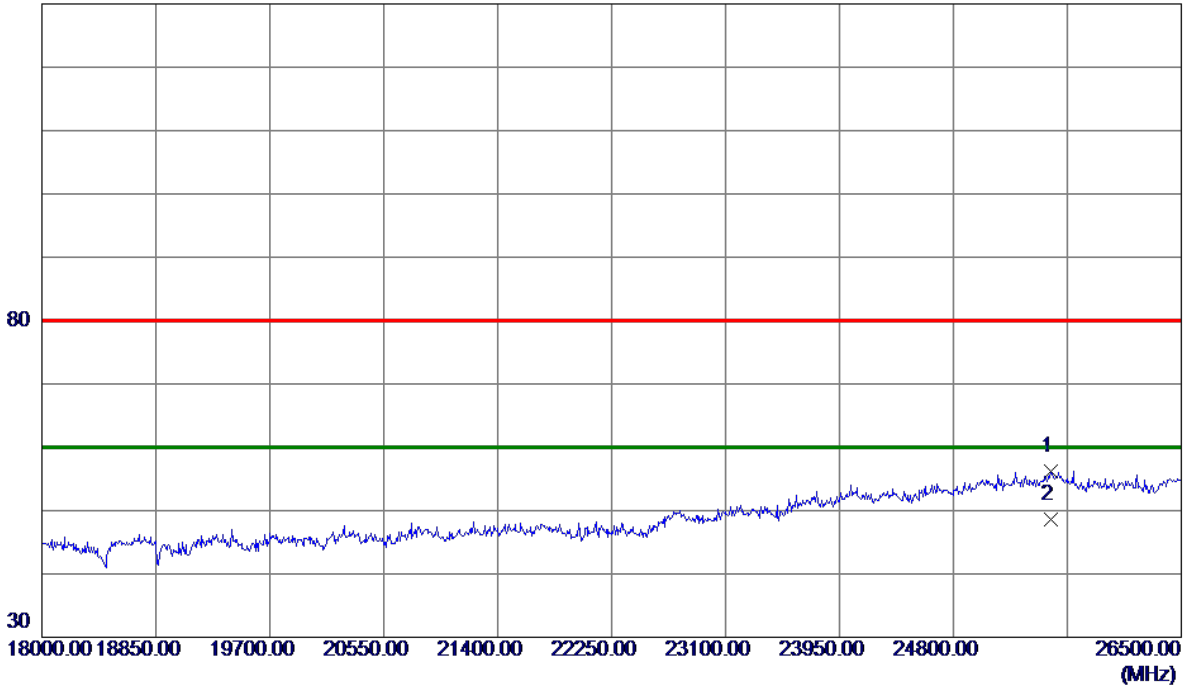

No.	Freq. MHz	Reading Level dBuV/m	Correct Factor dB	Measure ment dBuV/m	Limit dBuV/m	Margin dB	Detector	Comment
1	25531.0000	34.15	22.09	56.24	80.00	-23.76	Peak	
2 *	25531.0000	26.59	22.09	48.68	60.00	-11.32	AVG	

Test Mode: TX 2480 MHz \_CH78\_3Mbps

**Vertical**

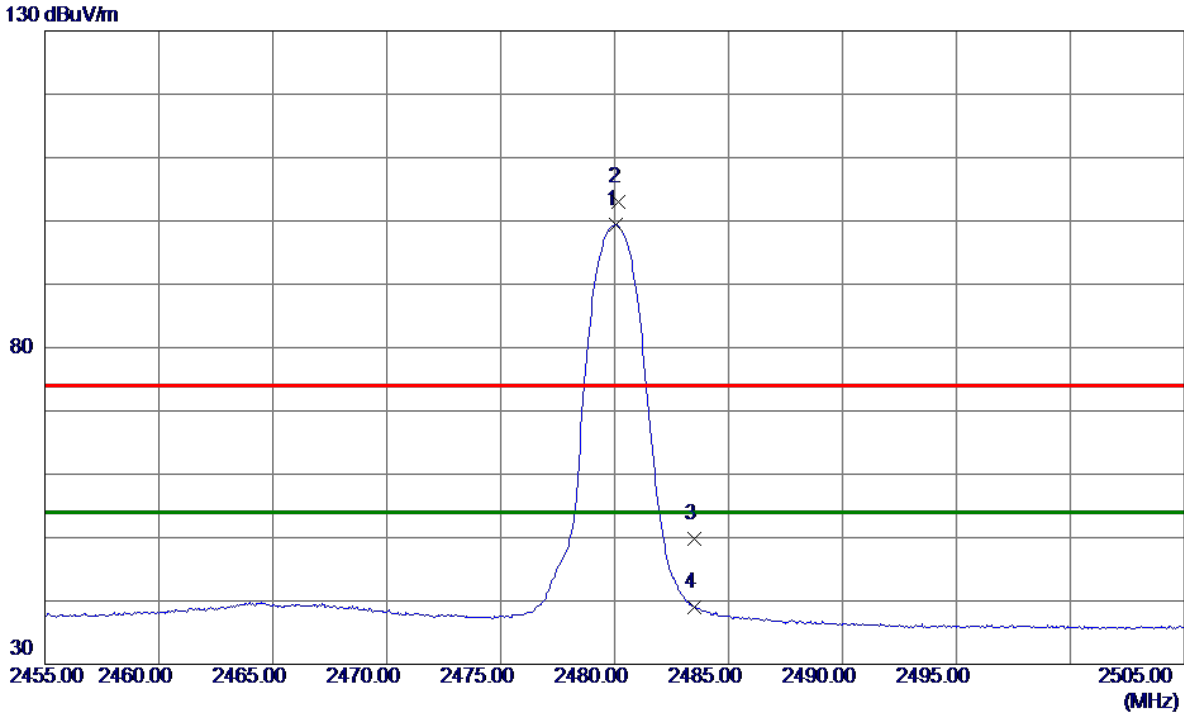

No.	Freq. MHz	Reading Level dBuV/m	Correct Factor dB	Measure ment dBuV/m	Limit dBuV/m	Margin dB	Detector	Comment
1 *	2480.0750	92.76	6.61	99.37	54.00	45.37	AVG	No Limit
2	2480.1750	96.34	6.61	102.95	74.00	28.95	Peak	No Limit
3	2483.5000	43.18	6.61	49.79	74.00	-24.21	Peak	
4	2483.5000	32.45	6.61	39.06	54.00	-14.94	AVG	

Test Mode: TX 2480 MHz \_CH78\_3Mbps

Horizontal

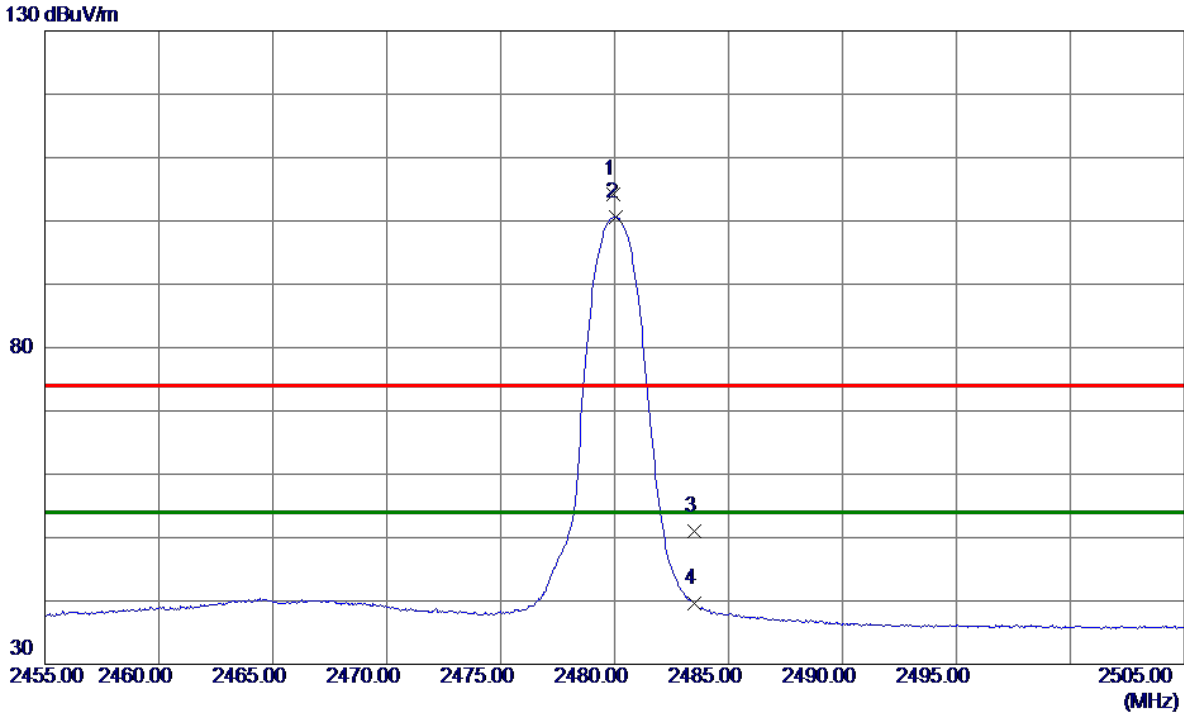

No.	Freq. MHz	Reading Level dBuV/m	Correct Factor dB	Measure ment dBuV/m	Limit dBuV/m	Margin dB	Detector	Comment
1	2479.9250	97.65	6.61	104.26	74.00	30.26	Peak	No Limit
2 *	2480.0500	94.00	6.61	100.61	54.00	46.61	AVG	No Limit
3	2483.5000	44.41	6.61	51.02	74.00	-22.98	Peak	
4	2483.5000	32.94	6.61	39.55	54.00	-14.45	AVG	

End of Test Report