

FCC Radio Test Report

FCC ID:QISHRY-LX2

This report concerns (check one): Original Grant Class I Change Class II Change

Project No. : 1809C113
Equipment : Smart Phone
Model Name : HRY-LX2
Series Model : N/A
Applicant : Huawei Technologies Co., Ltd.
Address : Administration Building, Headquarters of Huawei Technologies Co., Ltd., Bantian, Longgang District, Shenzhen, 518129, P.R.C

Date of Receipt : Sep. 19, 2018
Date of Test : Sep. 29, 2018 ~ Nov. 19, 2018
Issued Date : Nov. 23, 2018
Tested by : BTL Inc.

Technical Manager :

shawn xiao
(Shawn Xiao)

Authorized Signatory :

Steven Lu
(Steven Lu)

B T L I N C .

No.3,Jinshagang 1st Road, Shixia,Dalang Town, Dongguan, Guangdong, China.

TEL: +86-769-8318-3000 FAX: +86-769-8319-6000



Certificate #5123.02

Declaration

BTL represents to the client that testing is done in accordance with standard procedures as applicable and that test instruments used has been calibrated with standards traceable to international standard(s) and/or national standard(s).

BTL's reports apply only to the specific samples tested under conditions. It is manufacture's responsibility to ensure that additional production units of this model are manufactured with the identical electrical and mechanical components. **BTL** shall have no liability for any declarations, inferences or generalizations drawn by the client or others from **BTL** issued reports.

The report must not be used by the client to claim product certification, approval, or endorsement by NVLAP, NIST, or any agency of the U.S. Government.

This report is the confidential property of the client. As a mutual protection to the clients, the public and ourselves, the test report shall not be reproduced, except in full, without our written approval.

BTL's laboratory quality assurance procedures are in compliance with the **ISO Guide 17025** requirements, and accredited by the conformity assessment authorities listed in this test report.

BTL is not responsible for the sampling stage, so the results only apply to the sample as received.

The information, data and test plan are provided by manufacturer, so it is manufacturer's responsibility to ensure that the apparatus meets the essential requirements in all the possible configurations as representative of its intended use.

Limitation

For the use of the authority's logo is limited unless the Test Standard(s)/Scope(s)/Item(s) mentioned in this test report is (are) included in the conformity assessment authorities acceptance respective.

Table of Contents	Page
REPORT ISSUED HISTORY	4
1 . CERTIFICATION	5
2 . SUMMARY OF TEST RESULTS	6
2.1 TEST FACILITY	7
2.2 MEASUREMENT UNCERTAINTY	7
3 . GENERAL INFORMATION	8
3.1 GENERAL DESCRIPTION OF EUT	8
3.2 DESCRIPTION OF TEST MODES AND TEST CONDITION	10
3.3 BLOCKDIAGRAMSHOWINGTHECONFIGURATIONOFSYSTEMTESTED FOR RADIATED	11
3.4 DESCRIPTION OF SUPPORT UNITS	11
4 . TEST RESULT	12
4.1 RADIATED EMISSIONS MEASUREMENT	12
4.1.1 LIMIT	12
4.1.2 TEST PROCEDURES	12
4.1.3 TESTSETUP LAYOUT	13
4.1.4 TESTDEVIATION	14
4.1.5 TEST RESULTS (9KHZ TO 30MHZ)	14
4.1.6 TEST RESULTS (30MHZ TO 1000MHZ)	14
4.1.7 TEST RESULTS (ABOVE 1000MHZ)	14
5. LIST OF MEASUREMENT EQUIPMENTS	15
APPENDIX A - RADIATED EMISSION (9KHZ TO 30MHZ)	16
APPENDIX B - RADIATED EMISSION (30MHZ TO 1GHZ)	21
APPENDIX C - RADIATED EMISSION (ABOVE 1GHZ)	54

REPORT ISSUED HISTORY

Report Version	Description	Issued Date
R00	Original Issue.	Nov. 22, 2018
R01	Changed the brand name to Honor.	Nov. 23, 2018

1. CERTIFICATION

Equipment : Smart Phone
Brand Name : Honor
Model Name : HRY-LX2
Series Model : N/A
Applicant : Huawei Technologies Co., Ltd.
Manufacturer : Huawei Technologies Co., Ltd.
Address : Administration Building, Headquarters of Huawei Technologies Co., Ltd.,
Bantian, Longgang District, Shenzhen, 518129, P.R.C
Factory : Huawei Technologies Co., Ltd.
Address : Administration Building, Headquarters of Huawei Technologies Co., Ltd.,
Bantian, Longgang District, Shenzhen, 518129, P.R.C
Date of Test : Sep. 29, 2018 ~ Nov. 19, 2018
Test Sample : Engineering Sample No.: D181110240
Standard(s) : 47 CFR FCC Part 22 Subpart H
47 CFR FCC Part 2
ANSI/TIA-603-D-2010
FCC KDB 971168 D01 Power Meas License Digital Systems v03

The above equipment has been tested and found compliance with the requirement of the relative standards by BTL Inc.

The test data, data evaluation, and equipment configuration contained in our test report (Ref No. BTL-FCCP-4-1809C113) were obtained utilizing the test procedures, test instruments, test sites that has been accredited by the Authority of A2LA according to the ISO-17025 quality assessment standard and technical standard(s).

Test result included in this report is only for the GSM850, WCDMA Band V, LTE Band 5 Radiated Spurious Emissions part.

2. SUMMARY OF TEST RESULTS

Test procedures according to the technical standard(s):

FCC Part 22 Subpart H & Part 2			
Standard(s) Section	Test Item	Judgment	Tested By
2.1053 22.917(a)	Radiated Spurious Emissions	PASS	Trey Chen

2.1 TEST FACILITY

The test facilities used to collect the test data in this report is at the location of No.3, Jinshagang 1st Road, Shixia, Dalang Town, Dongguan, Guangdong, China.

BTL's test firm number for FCC: 854385

BTL's designation number for FCC: CN5020

2.2 MEASUREMENT UNCERTAINTY

The measurement uncertainty figures shall be calculated according the methods described in the ETSI TR 100 028 and shall correspond to an expansion factor (coverage factor) $k=1.96$ or $k=2$ (which provide confidence levels of respectively 90% and 95.45% in the case where the distributions characterizing the actual measurement uncertainties are normal (Gaussian)).

Measurement Uncertainty for a Level of Confidence of 95 %, $U=2xUc(y)$.

The BTL measurement uncertainty as below table:

A. Radiated Measurement :

Test Site	Method	Measurement Frequency Range	Ant. H / V	U,(dB)
DG-CB03	CISPR	9KHz ~ 30MHz	V	3.79
		9KHz ~ 30MHz	H	3.57
		30MHz ~ 200MHz	V	3.82
		30MHz ~ 200MHz	H	3.78
		200MHz ~ 1,000MHz	V	4.10
		200MHz ~ 1,000MHz	H	4.06

Test Site	Method	Measurement Frequency Range	Ant. H / V	U,(dB)
DG-CB03	CISPR	1GHz ~ 18GHz	V	3.12
		1GHz ~ 18GHz	H	3.68

Note: Unless specifically mentioned, the uncertainty of measurement has not been taken into account to declare the compliance or non-compliance to the specification.

3. GENERAL INFORMATION

3.1 GENERAL DESCRIPTION OF EUT

Equipment	Smart Phone	
Brand Name	Honor	
Model Name	HRY-LX2	
Series Model	N/A	
Model Difference(s)	N/A	
Modulation Type	GSM/GPRS	GMSK
	EDGE	GMSK, 8PSK
	WCDMA	UL: BPSK DL: QPSK
	WCDMA(HSDPA/HSUPA)	16QAM
	LTE	UL: QPSK,16QAM DL: QPSK,16QAM
Operation Frequency	GSM /EDGE/GPRS	824.2 MHz ~ 848.8 MHz
	WCDMA Band V	826.4 MHz ~ 846.6 MHz
	LTE 5 (Channel Bandwidth: 1.4MHz)	824.7 MHz ~ 848.3 MHz
	LTE 5 (Channel Bandwidth: 3MHz)	825.5 MHz ~ 847.5 MHz
	LTE 5 (Channel Bandwidth: 5MHz)	826.5 MHz ~ 846.5 MHz
	LTE 5 (Channel Bandwidth: 10MHz)	829.0 MHz ~ 844.0 MHz
Antenna Type	Internal Antenna	
Antenna Gain	-7.5 dBi(Main Antenna) -2.1 dBi(DIV Antenna)	
Hardware Version	HL1HRYM	
Software Version	9.0.1.111(C900E110R1P9)	
IMEI No.	Radiated	868592040042118
Power Source	1# DC voltage supplied from AC/DC adapter. 2# Supplied from battery.	
Power Rating	1# I/P: 100-240V~,50/60Hz,0.5A O/P: 5V 2A 2# DC 3.82V, 3320mAh	

Note:

1. For a more detailed features description, please refer to the manufacturer's specifications or the user's manual.
2. The EUT contains following accessory devices.

Item	Manufacturer	Factory	Model	Description
Adapter	Huawei Technologies Co., Ltd.	Salcomp	HW-050200U02	I/P:100-240V~ 50/60Hz, 0.5A O/P:5V 2A
		HUIZHOU BYD ELECTRONIC CO., LTD.	HW-050200U02 HW-050200U01	
		SHENZHEN HUNTKEY ELECTRIC CO., LTD.		
		Dongguan Phitek Electronics Co., Ltd.		
Battery	Huawei Technologies Co., Ltd.	SCUD (FUJIAN) Electronics Co., Ltd.	HB396286ECW	DC 3.82V, 3320mAh
		Huizhou Desay Battery Co., Ltd.		
		Sunwoda Electronic Co., Ltd.		
		Dongguan Amperex Technology Limited		
USB Cable	-	NingBo Broad Telecommunication Co., Ltd.	WA0001	-
		HONGLIN TECHNOLOGY CO., LTD.	130-26669	
		FOXCONN INTERCONNECT TECHNOLOGY LIMITED	CUBB01M-HC30 4-DH	
		LuXshare	L99U2017-CS-H	
Earphone	-	Jiangxi Lianchuang Hongsheng Electronic Co., LTD.	MEND1532B528 A02	-
		BOLUO COUNTY QUANCHENG ELECTRONIC CO.,LTD.	1293-3283-3.5m m-322	

3.2 DESCRIPTION OF TEST MODES AND TEST CONDITION

Pre-Scan has been conducted to determine the worst-case mode from all possible combinations between available modulations, data rates, XYZ axis and antenna ports
 The worst case was found when positioned on X-plane for EIRP and X-axis for radiated emission.
 Following channel(s) was (were) selected for the final test as listed below:

GSM MODE			
Test Item	Available Channel	Tested Channel	Mode
Radiated Emission	128 to 251	190	GSM, EDGE

WCDMA BAND V			
Test Item	Available Channel	Tested Channel	Mode
Radiated Emission	4132 to 4233	4182	WCDMA

LTE BAND 5					
Test Item	Available Channel	Tested Channel	Channel Bandwidth	Modulation	Mode
Radiated Emission	20407 to 20643	20525	1.4MHz	QPSK	1 RB / 0 RB Offset
	20425 to 20625	20525	5MHz	QPSK	1 RB / 0 RB Offset
	20450 to 20600	20525	10MHz	QPSK	1 RB / 0 RB Offset

EUT TEST CONDITIONS:

Test Item	Environmental Conditions	Test Voltage
Radiated Emission	25°C, 60%RH	AC 120V/60Hz

3.3 BLOCKDIGRAMSHOWINGTHECONFIGURATIONOFSYSTEMTESTED FOR RADIATED

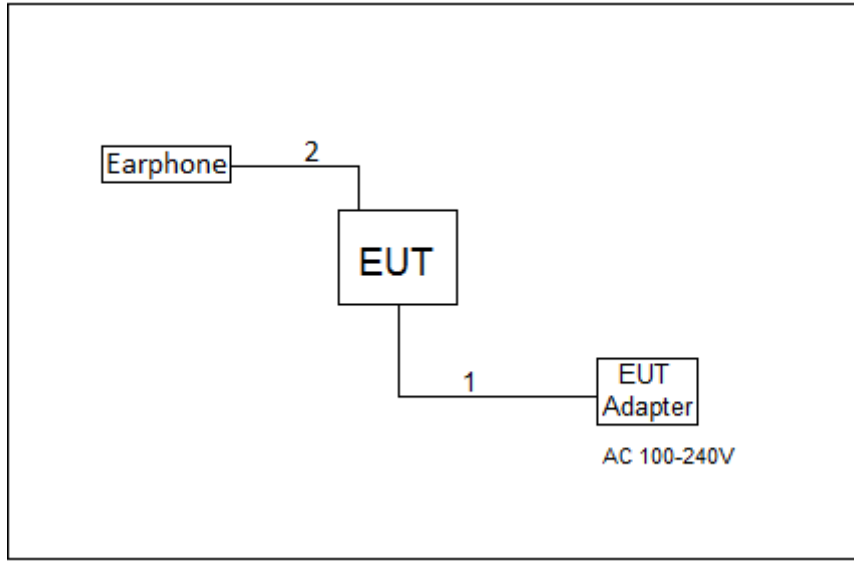

3.4 DESCRIPTION OF SUPPORT UNITS

The EUT has been tested as an independent unit together with other necessary accessories or support units. The following support units or accessories were used to form a representative test configuration during the tests.

Item	Equipment	Mfr/Brand	Model/Type No.	FCC ID	Series No.
-	-	-	-	-	-

Item	Shielded Type	Ferrite Core	Length	Note
1	NO	NO	1.2m	DC Cable
2	NO	NO	1m	Audio Cable

4. TEST RESULT

4.1 RADIATED EMISSIONS MEASUREMENT

4.1.1 LIMIT

The power of any emission outside of the authorized operating frequency ranges must be attenuated below the transmitting power (P) by a factor of at least $43 + 10 \log(P)$ dB. The emission limit equal to -13dBm.

4.1.2 TEST PROCEDURES

1. Substitution method is used for E.I.R.P measurement. In the semi-anechoic chamber, EUT placed on the 0.8m height of Turn Table, rotated the table around 360 degrees to search the maximum radiation power and receiver antenna shall be rotated vertical and horizontal polarization and moved height from 1m to 4m to find the maximum polar radiated power. The "Read Value" is the spectrum reading the maximum power value.
2. The substitution horn antenna is substituted for EUT at the same position and signals generator export the CW signal to the substitution antenna via a TX cable. Rotated the Turn Table and moved receiving antenna to find the maximum radiation power. Adjust output power level of S.G to get a Value of spectrum reading equal to "Read Value " of step a. Record the power level of S.G
3. EIRP = Output power level of S.G – TX cable loss + Antenna gain of substitution horn.
4. E.R.P power can be calculated form E.I.R.P power by subtracting the gain of dipole, E.R.P power = E.I.P.R power - 2.15dBi.
5. The resolution bandwidth and video bandwidth of test receiver/spectrum analyzer is 1MHz/3MHz.

4.1.3 TESTSETUP LAYOUT

Below 30MHz

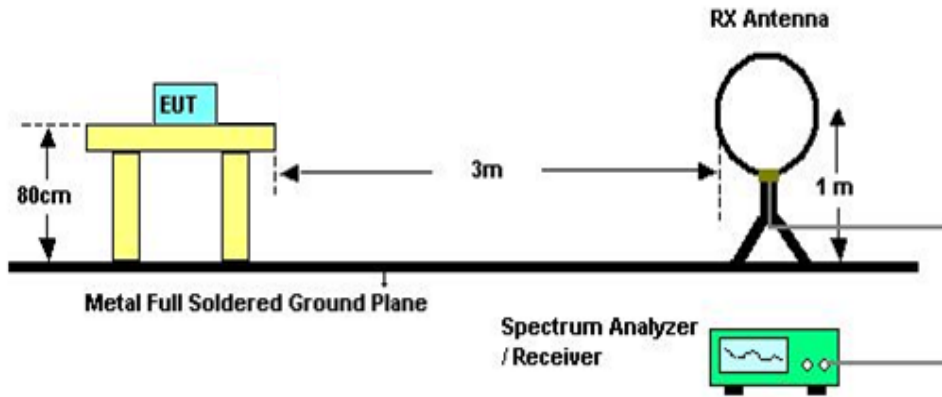

30MHz to 1GHz

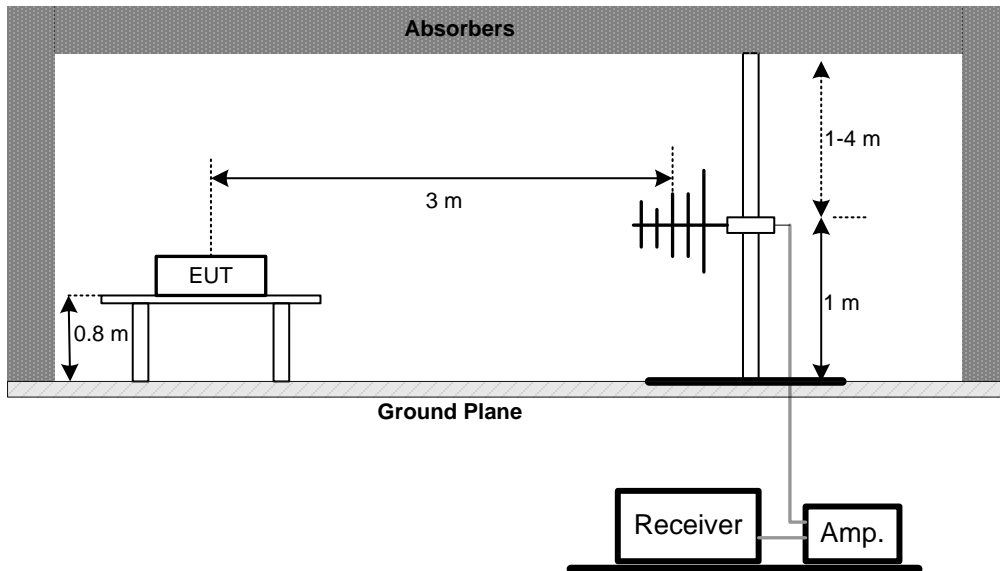

1GHz to 18GHz

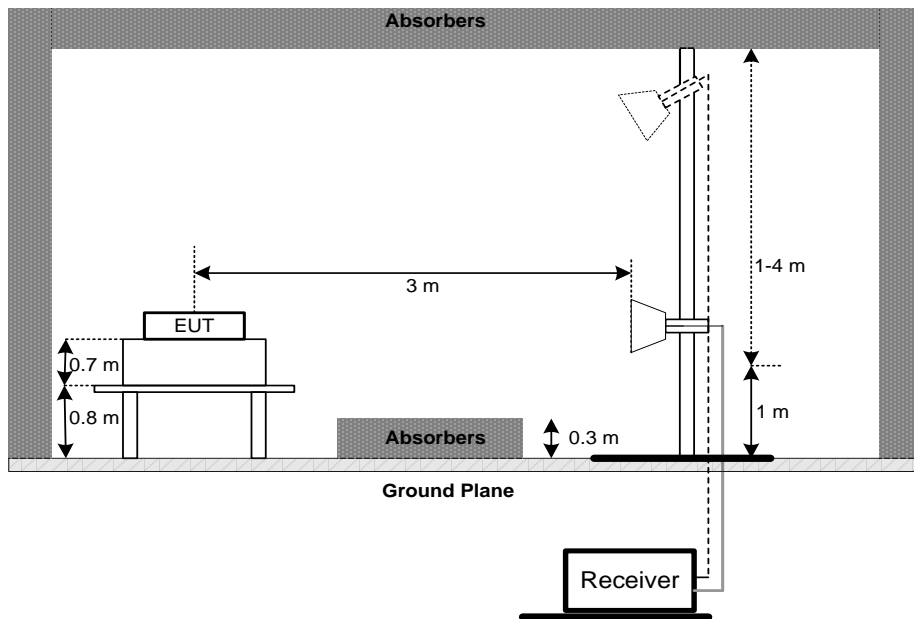

4.1.4 TEST DEVIATION

No deviation

4.1.5 TEST RESULTS (9KHZ TO 30MHZ)

Please refer to the Appendix A.

Remark:

- (1) All adapters had been pre-test and in this report only recorded the worst case.

4.1.6 TEST RESULTS (30MHZ TO 1000MHZ)

Please refer to the Appendix B.

Remark:

- (1) All adapters had been pre-test and in this report only recorded the worst case.

4.1.7 TEST RESULTS (ABOVE 1000MHZ)

Please refer to the Appendix C.

5. LIST OF MEASUREMENT EQUIPMENTS

Radiated Emission Measurement					
Item	Kind of Equipment	Manufacturer	Type No.	Serial No.	Calibrated until
1	Antenna	Schwarbeck	VULB9160	9160-3232	Mar. 11, 2019
2	Amplifier	Agilent	8449B	3008A02274	Mar. 11, 2019
3	Amplifier	HP	8447D	2944A09673	Aug. 11, 2019
4	HighPass Filter	Wairwright Instruments Gmbh	WHK 1.5/15G-10ST	11	Mar. 11, 2019
5	Band Reject Filter	Wairwright Instruments Gmbh	WRCG 1710/1785-1690/180 5-60/12SS	38	Mar. 11, 2019
6	Band Reject Filter	Wairwright Instruments Gmbh	WRCG 824/849-810/863-60/ 9SS	7	Mar. 11, 2019
7	Band Reject Filter	Wairwright Instruments Gmbh	WRCG 880/915-860/935-60/ 9SS	14	Mar. 11, 2019
8	Band Reject Filter	Wairwright Instruments Gmbh	WRCG 1850/1910-1830/193 0-60/10SS	17	Mar. 11, 2019
9	HighPass Filter	Wairwright Instruments Gmbh	WHK3.1/18G-10SS	24	Mar. 11, 2019
10	Wireless Communication Test SET	Agilent	E5515C	MY48364183	Mar. 11, 2019
11	Microwave Preamplifier With Adaptor	EMC INSTRUMENT	EMC2654045	980039 & HA01	Mar. 11, 2019
12	Receiver	Agilent	N9038A	MY52130039	Aug. 11, 2019
13	wideband radio communication tester	R&S	CMW500	152372	Mar. 11, 2019
14	Cable	emci	LMR-400(30MHz-1G Hz)(8m+5m)	N/A	May 25, 2019
15	Cable	mitron	B10-01-01-12M	18072744	Jul. 30, 2019
16	Controller	ETS-Lindgren	2090	N/A	N/A
17	Measurement Software	Farad	EZ-EMC Ver.NB-03A1-01	N/A	N/A
18	Loop Antenna	EM	EM-6876-1	230	Feb. 07, 2019
19	Double Ridged Guide Antenna	ETS	3115	75789	Mar. 11, 2019
20	Broad-Band Horn Antenna	Schwarzbeck	BBHA 9170	9170319	Jun. 30, 2019

Remark: "N/A" denotes no model name, serial no. or calibration specified.

All calibration period of equipment list is one year.

APPENDIX A - RADIATED EMISSION (9KHZ TO 30MHZ)

Test Mode: TX Mode

Ant 0°

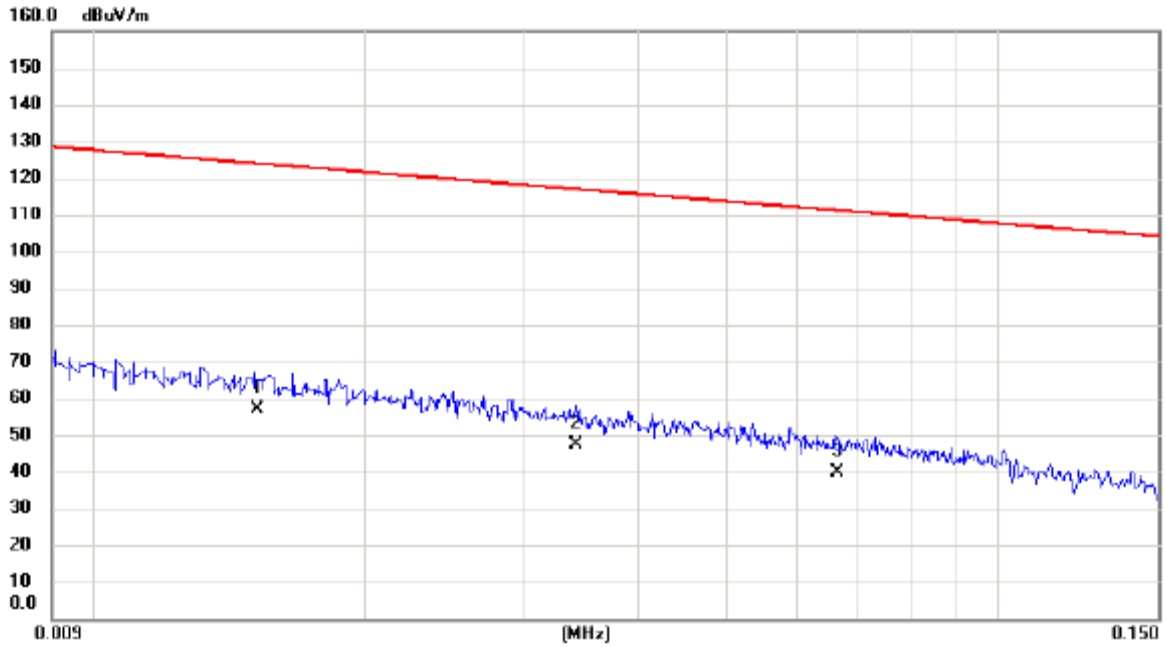

No.	Mk.	Freq.	Reading Level	Correct Factor	Measurement	Limit	Margin	Detector	Comment
		MHz	dBuV	dB	dBuV/m	dBuV/m	dB		
1	*	0.0152	36.20	20.69	56.89	123.97	-67.08	AVG	
2		0.0342	27.80	19.79	47.59	116.92	-69.33	AVG	
3		0.0663	20.50	19.20	39.70	111.17	-71.47	AVG	

Test Mode: TX Mode

Ant 0°

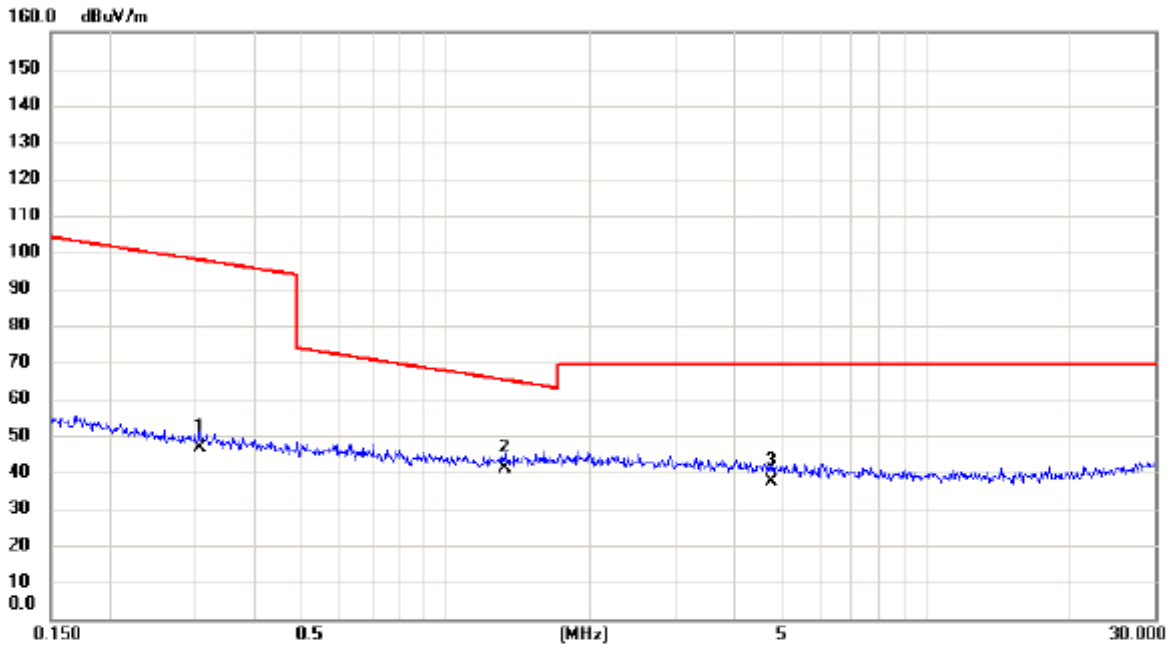

No.	Mk.	Freq. MHz	Reading Level dBuV	Correct Factor dB	Measure- ment dBuV/m	Limit dBuV/m	Margin dB	Detector	Comment
1		0.3067	29.50	17.04	46.54	97.87	-51.33	AVG	
2	*	1.3308	24.20	16.77	40.97	65.12	-24.15	QP	
3		4.7716	22.30	15.30	37.60	69.54	-31.94	QP	

Test Mode: TX Mode

Ant 90°

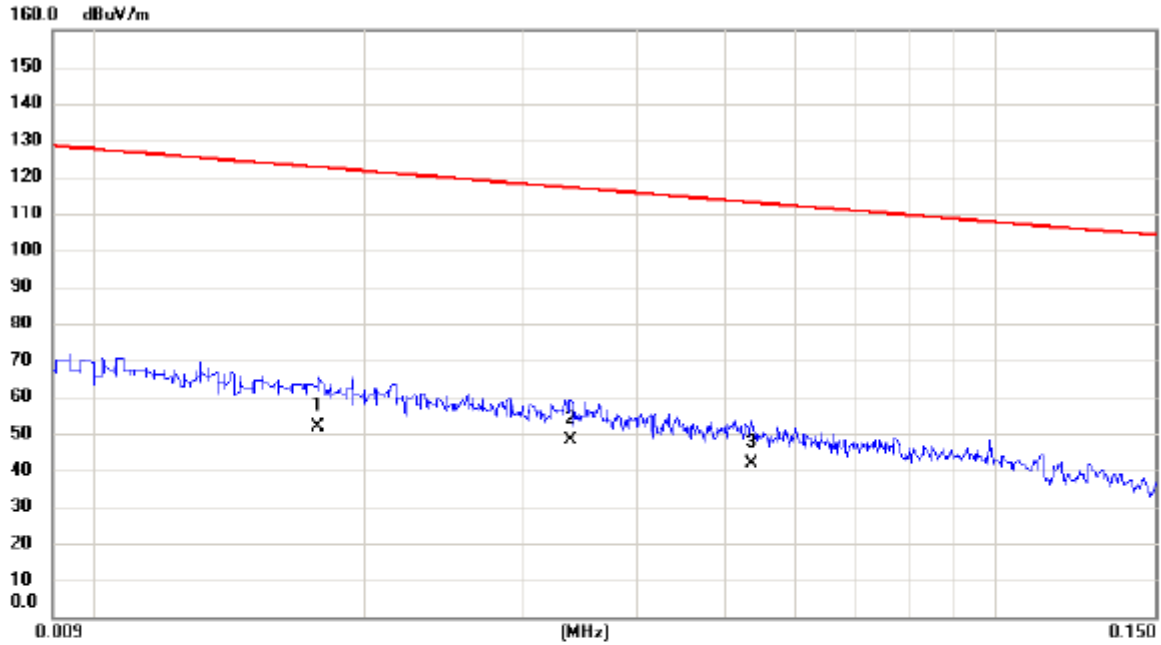

No.	Mk.	Freq.	Reading Level	Correct Factor	Measurement	Limit	Margin	Detector	Comment
		MHz	dBuV	dB	dBuV/m	dBuV/m	dB		
1		0.0177	31.64	20.34	51.98	122.65	-70.67	AVG	
2	*	0.0338	28.46	19.80	48.26	117.03	-68.77	AVG	
3		0.0536	22.47	19.46	41.93	113.02	-71.09	AVG	

Test Mode: TX Mode

Ant 90°

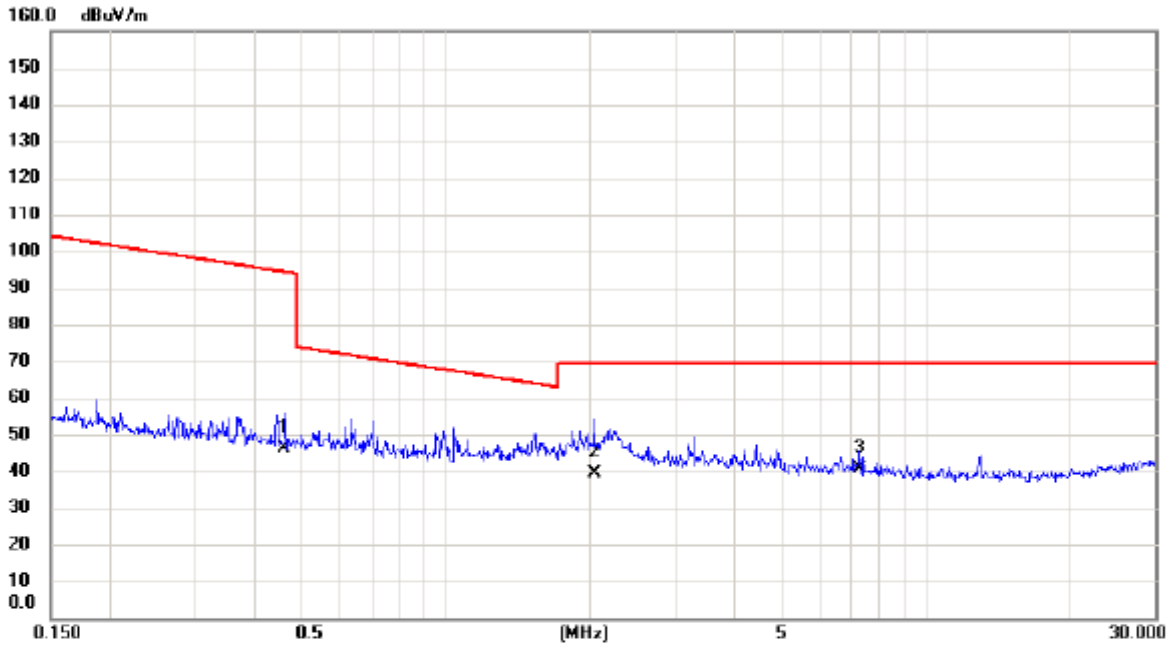

No.	Mk.	Freq. MHz	Reading Level dBuV	Correct Factor dB	Measure- ment dBuV/m	Limit dBuV/m	Margin dB	Detector	Comment
1		0.4612	29.10	16.98	46.08	94.33	-48.25	AVG	
2		2.0441	22.20	17.09	39.29	69.54	-30.25	QP	
3	*	7.2518	25.70	14.78	40.48	69.54	-29.06	QP	

APPENDIX B - RADIATED EMISSION (30MHZ TO 1GHZ)

Test Mode: GSM850_TX CH190_GSM_with Earphone_Main Antenna

Vertical

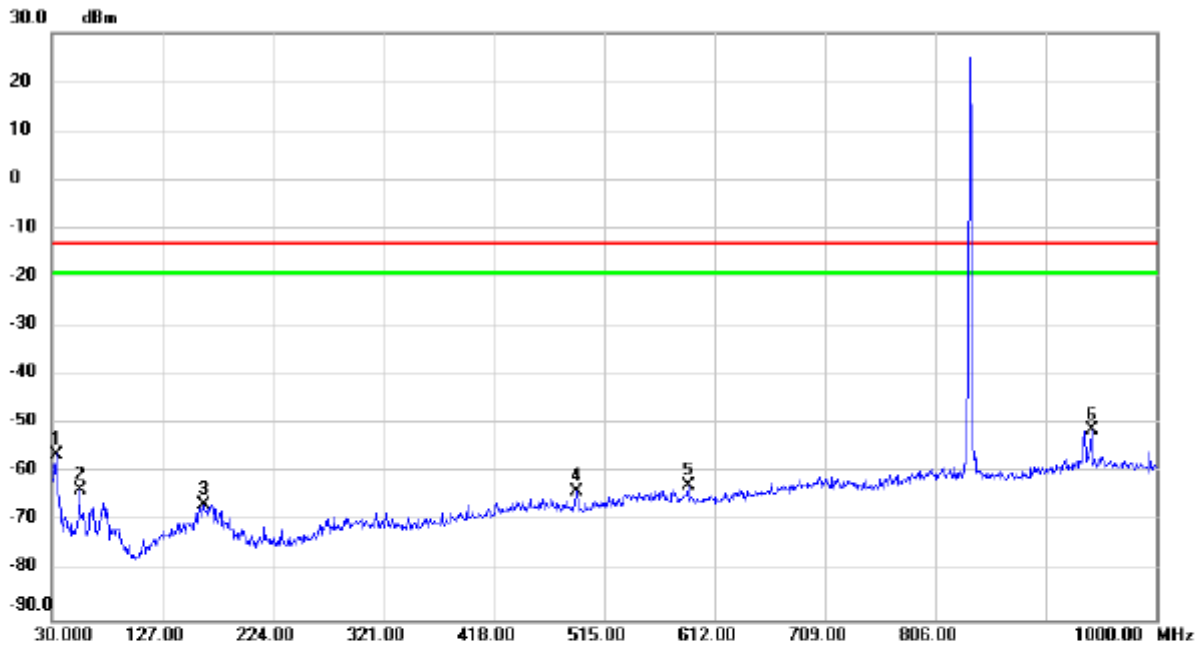

No.	Mk.	Freq. MHz	Reading Level dBm	Correct Factor dB	Measure- ment dBm	Limit dBm	Margin dB	Detector	Comment
1		34.365	-51.25	-4.85	-56.10	-13.00	-43.10	peak	
2		54.735	-58.55	-4.98	-63.53	-13.00	-50.53	peak	
3		163.375	-65.74	-0.81	-66.55	-13.00	-53.55	peak	
4		491.235	-65.49	1.67	-63.82	-13.00	-50.82	peak	
5		588.720	-66.53	3.89	-62.64	-13.00	-49.64	peak	
6	*	943.255	-62.35	11.14	-51.21	-13.00	-38.21	peak	

Test Mode: GSM850_TX CH190_GSM_with Earphone_Main Antenna

Horizontal

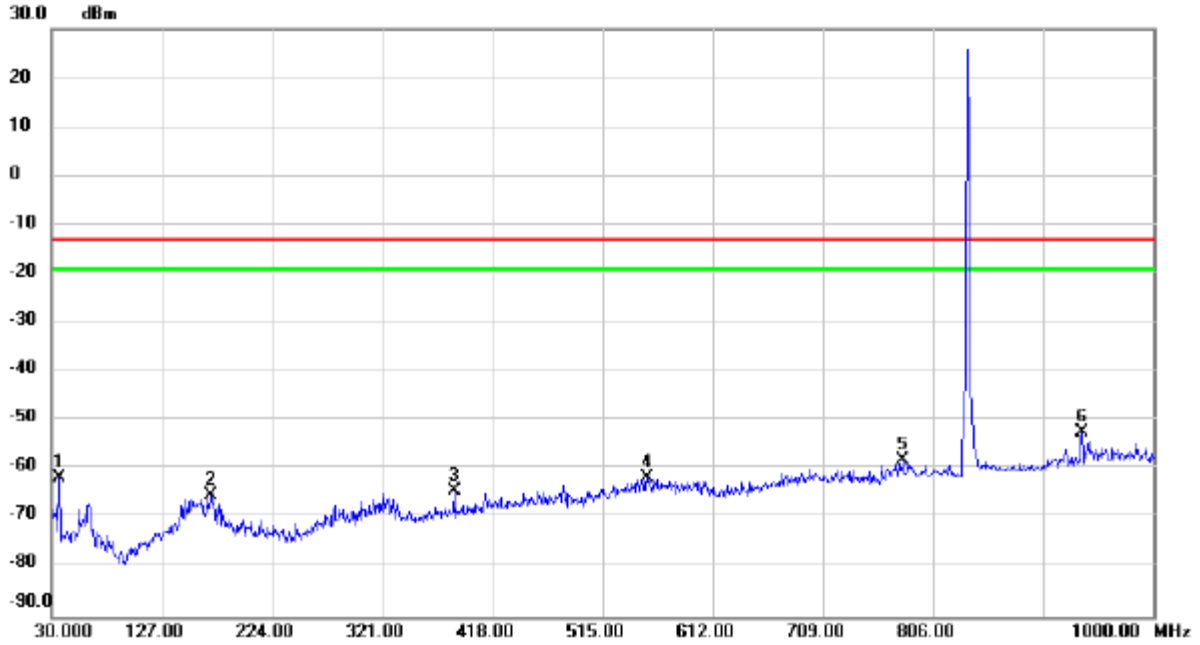

No.	Mk.	Freq. MHz	Reading Level dBm	Correct Factor dB	Measure- ment dBm	Limit dBm	Margin dB	Detector	Comment
1		37.275	-56.80	-4.78	-61.58	-13.00	-48.58	peak	
2		169.680	-63.96	-1.18	-65.14	-13.00	-52.14	peak	
3		384.535	-64.57	0.09	-64.48	-13.00	-51.48	peak	
4		554.770	-66.10	4.45	-61.65	-13.00	-48.65	peak	
5		779.810	-65.71	7.75	-57.96	-13.00	-44.96	peak	
6	*	936.950	-63.28	10.89	-52.39	-13.00	-39.39	peak	

Test Mode: GSM850_TX CH190_EDGE_with Earphone_Main Antenna

Vertical

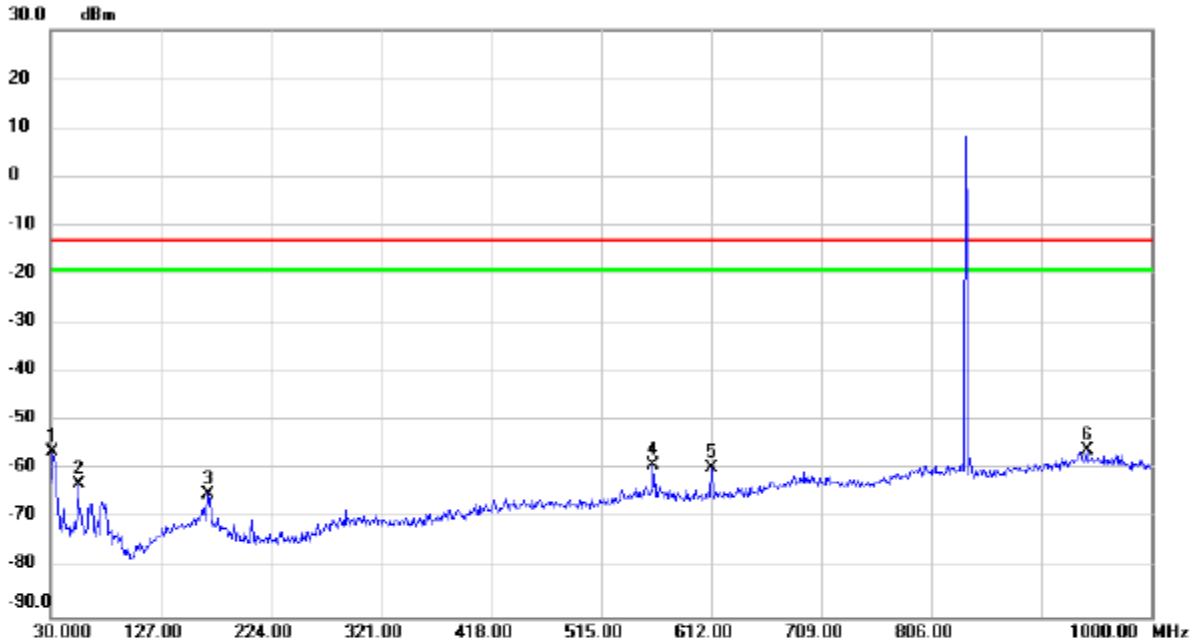

No.	Mk.	Freq. MHz	Reading Level dBm	Correct Factor dB	Measure- ment dBm	Limit dBm	Margin dB	Detector	Comment
1		32.425	-51.11	-5.00	-56.11	-13.00	-43.11	peak	
2		54.735	-57.97	-4.98	-62.95	-13.00	-49.95	peak	
3		169.195	-63.75	-1.15	-64.90	-13.00	-51.90	peak	
4		561.560	-63.42	4.35	-59.07	-13.00	-46.07	peak	
5		612.485	-63.49	3.97	-59.52	-13.00	-46.52	peak	
6 *		943.255	-67.18	11.14	-56.04	-13.00	-43.04	peak	

Test Mode: GSM850_TX CH190_EDGE_with Earphone_Main Antenna

Horizontal



No.	Mk.	Freq. MHz	Reading Level dBm	Correct Factor dB	Measure- ment dBm	Limit dBm	Margin dB	Detector	Comment
1		34.850	-60.66	-4.88	-65.54	-13.00	-52.54	peak	
2		63.950	-60.80	-6.36	-67.16	-13.00	-54.16	peak	
3		170.165	-63.31	-1.23	-64.54	-13.00	-51.54	peak	
4		421.395	-65.83	1.47	-64.36	-13.00	-51.36	peak	
5		561.560	-66.11	4.35	-61.76	-13.00	-48.76	peak	
6	*	936.950	-66.78	10.89	-55.89	-13.00	-42.89	peak	

Test Mode: GSM850_TX CH190_GSM_without Earphone_Main Antenna

Vertical

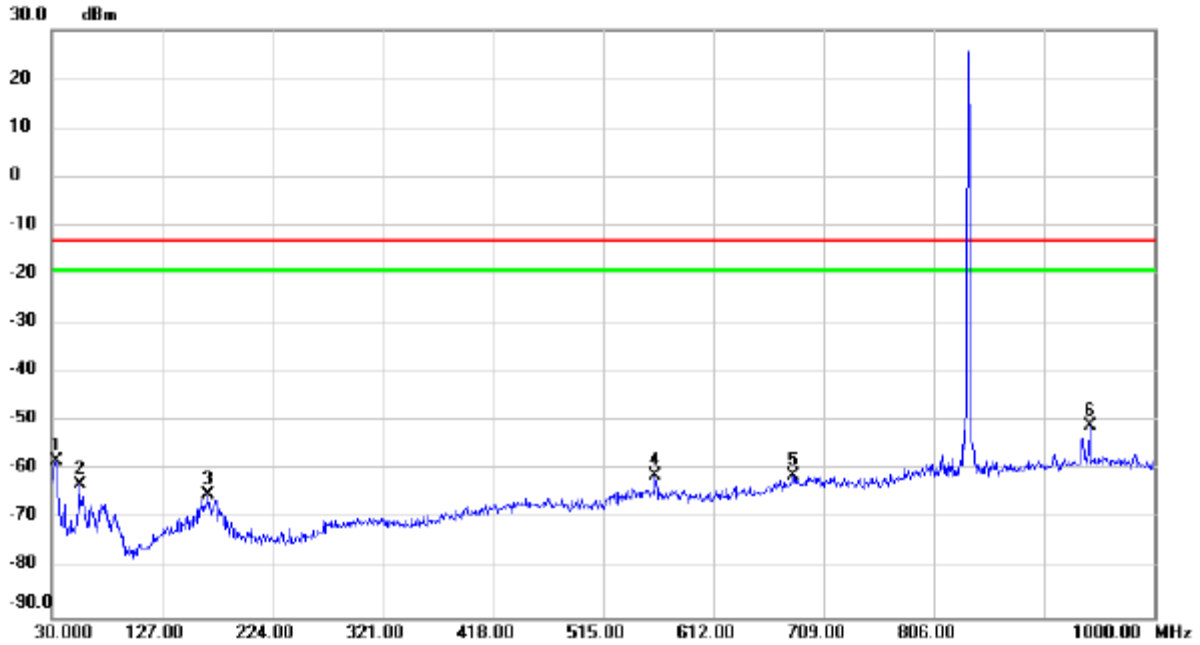

No.	Mk.	Freq. MHz	Reading Level dBm	Correct Factor dB	Measure- ment dBm	Limit dBm	Margin dB	Detector	Comment
1		34.365	-53.10	-4.85	-57.95	-13.00	-44.95	peak	
2		54.735	-57.87	-4.98	-62.85	-13.00	-49.85	peak	
3		168.225	-63.93	-1.10	-65.03	-13.00	-52.03	peak	
4		561.560	-65.31	4.35	-60.96	-13.00	-47.96	peak	
5		682.325	-67.38	6.40	-60.98	-13.00	-47.98	peak	
6	*	943.255	-62.12	11.14	-50.98	-13.00	-37.98	peak	

Test Mode: GSM850_TX CH190_GSM_without Earphone_Main Antenna

Horizontal



No.	Mk.	Freq. MHz	Reading Level dBm	Correct Factor dB	Measure- ment dBm	Limit dBm	Margin dB	Detector	Comment
1		37.275	-55.55	-4.78	-60.33	-13.00	-47.33	peak	
2		149.795	-62.40	-1.51	-63.91	-13.00	-50.91	peak	
3		328.760	-64.05	-0.77	-64.82	-13.00	-51.82	peak	
4		561.075	-64.97	4.35	-60.62	-13.00	-47.62	peak	
5		750.710	-64.56	6.00	-58.56	-13.00	-45.56	peak	
6	*	936.950	-61.98	10.89	-51.09	-13.00	-38.09	peak	

Test Mode: GSM850_TX CH190_EDGE_without Earphone_Main Antenna

Vertical

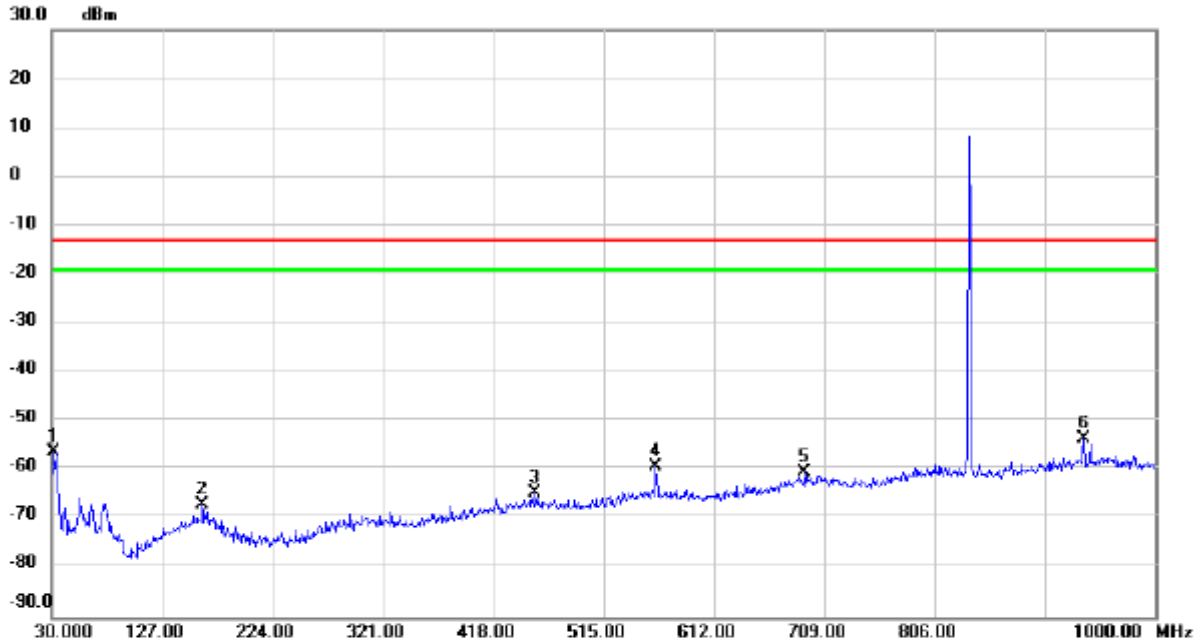

No.	Mk.	Freq. MHz	Reading Level dBm	Correct Factor dB	Measure- ment dBm	Limit dBm	Margin dB	Detector	Comment
1		32.425	-51.28	-5.00	-56.28	-13.00	-43.28	peak	
2		161.920	-66.30	-0.71	-67.01	-13.00	-54.01	peak	
3		454.860	-67.12	2.49	-64.63	-13.00	-51.63	peak	
4		561.560	-63.57	4.35	-59.22	-13.00	-46.22	peak	
5		691.540	-67.27	6.84	-60.43	-13.00	-47.43	peak	
6	*	936.950	-64.42	10.89	-53.53	-13.00	-40.53	peak	

Test Mode: GSM850_TX CH190_EDGE_without Earphone_Main Antenna

Horizontal

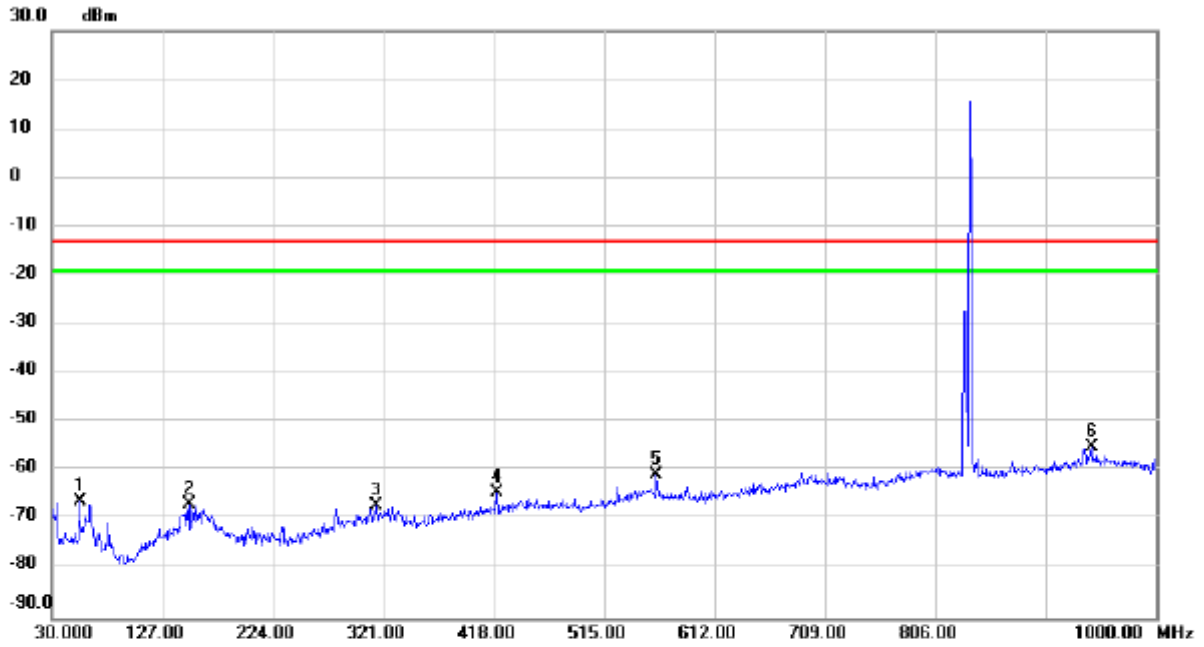

No.	Mk.	Freq. MHz	Reading Level dBm	Correct Factor dB	Measure- ment dBm	Limit dBm	Margin dB	Detector	Comment
1		54.735	-61.02	-4.98	-66.00	-13.00	-53.00	peak	
2		151.250	-65.50	-1.39	-66.89	-13.00	-53.89	peak	
3		314.695	-66.50	-0.58	-67.08	-13.00	-54.08	peak	
4		421.395	-65.83	1.47	-64.36	-13.00	-51.36	peak	
5		561.560	-65.05	4.35	-60.70	-13.00	-47.70	peak	
6	*	943.255	-66.12	11.14	-54.98	-13.00	-41.98	peak	

Test Mode: WCDMA Band V_TX CH4182_Main Antenna

Vertical



No.	Mk.	Freq. MHz	Reading Level dBm	Correct Factor dB	Measure- ment dBm	Limit dBm	Margin dB	Detector	Comment
1		159.495	-66.37	-0.64	-67.01	-13.00	-54.01	peak	
2		301.600	-66.06	-0.39	-66.45	-13.00	-53.45	peak	
3		436.915	-65.22	2.08	-63.14	-13.00	-50.14	peak	
4		562.530	-65.16	4.32	-60.84	-13.00	-47.84	peak	
5		718.700	-64.86	6.77	-58.09	-13.00	-45.09	peak	
6	*	947.135	-65.81	11.29	-54.52	-13.00	-41.52	peak	

Test Mode: WCDMA Band V_TX CH4182_Main Antenna

Horizontal



No.	Mk.	Freq. MHz	Reading Level dBm	Correct Factor dB	Measure- ment dBm	Limit dBm	Margin dB	Detector	Comment
1		156.100	-65.92	-0.94	-66.86	-13.00	-53.86	peak	
2		302.570	-65.82	-0.41	-66.23	-13.00	-53.23	peak	
3		488.810	-65.02	1.73	-63.29	-13.00	-50.29	peak	
4		559.135	-65.10	4.38	-60.72	-13.00	-47.72	peak	
5		702.695	-65.71	7.19	-58.52	-13.00	-45.52	peak	
6	*	936.950	-64.88	10.89	-53.99	-13.00	-40.99	peak	

Test Mode: LTE Band 5_TX CH20525_1.4M_Main Antenna

Vertical

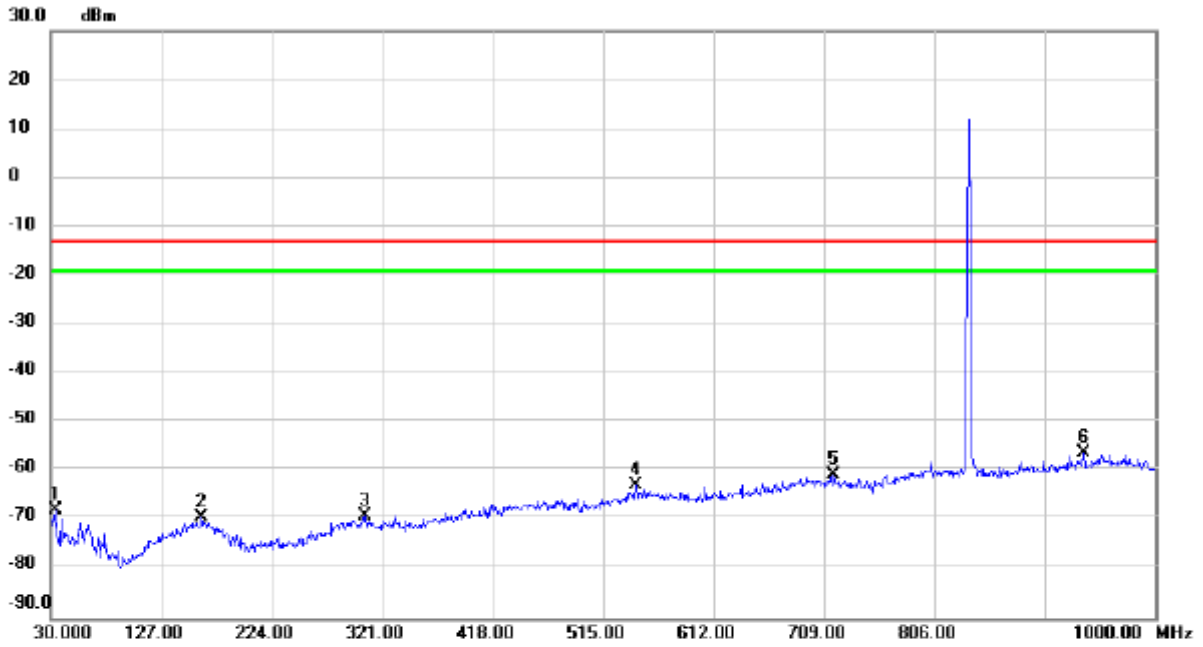

No.	Mk.	Freq. MHz	Reading Level dBm	Correct Factor dB	Measure- ment dBm	Limit dBm	Margin dB	Detector	Comment
1		34.850	-63.00	-4.88	-67.88	-13.00	-54.88	peak	
2		161.920	-68.75	-0.71	-69.46	-13.00	-56.46	peak	
3		306.450	-68.73	-0.46	-69.19	-13.00	-56.19	peak	
4		543.615	-67.00	4.14	-62.86	-13.00	-49.86	peak	
5		716.760	-67.44	6.82	-60.62	-13.00	-47.62	peak	
6	*	936.950	-67.10	10.89	-56.21	-13.00	-43.21	peak	

Test Mode: LTE Band 5_TX CH20525_1.4M_Main Antenna

Horizontal



No.	Mk.	Freq. MHz	Reading Level dBm	Correct Factor dB	Measure- ment dBm	Limit dBm	Margin dB	Detector	Comment
1		149.795	-68.38	-1.51	-69.89	-13.00	-56.89	peak	
2		293.840	-68.91	-0.73	-69.64	-13.00	-56.64	peak	
3		450.495	-68.01	2.59	-65.42	-13.00	-52.42	peak	
4		555.740	-68.10	4.44	-63.66	-13.00	-50.66	peak	
5		694.935	-67.75	7.01	-60.74	-13.00	-47.74	peak	
6	*	930.160	-65.91	10.62	-55.29	-13.00	-42.29	peak	

Test Mode: LTE Band 5_TX CH20525_5M_Main Antenna

Vertical

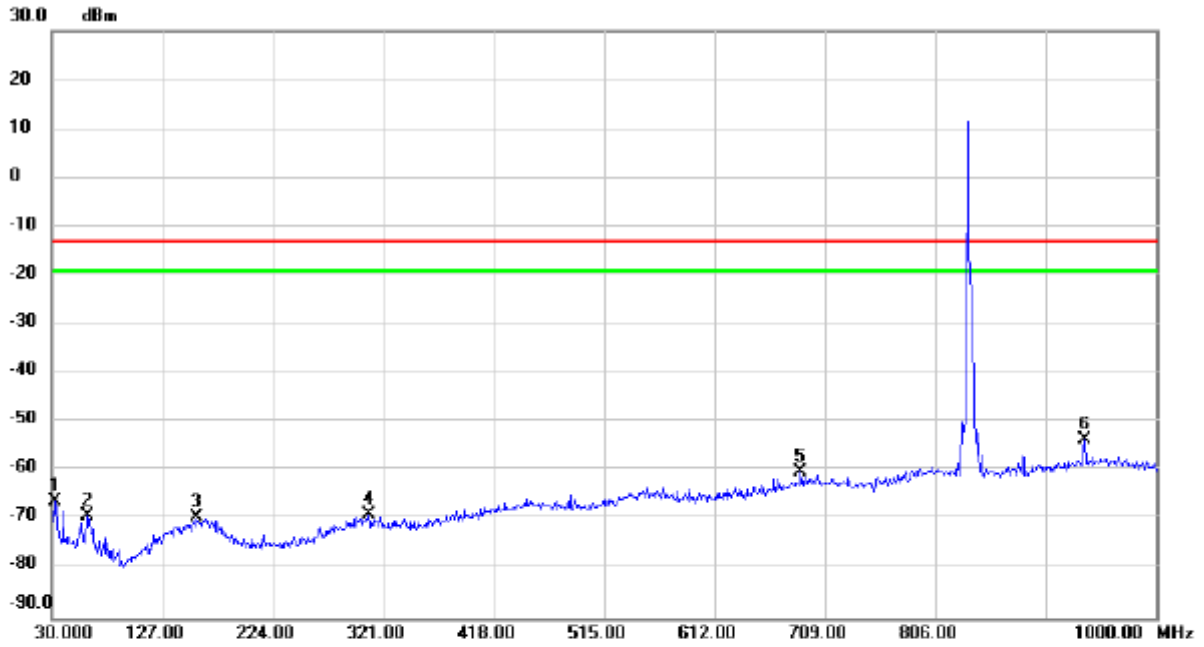

No.	Mk.	Freq. MHz	Reading Level dBm	Correct Factor dB	Measure- ment dBm	Limit dBm	Margin dB	Detector	Comment
1		33.395	-61.39	-4.88	-66.27	-13.00	-53.27	peak	
2		62.010	-63.19	-6.02	-69.21	-13.00	-56.21	peak	
3		157.555	-68.78	-0.82	-69.60	-13.00	-56.60	peak	
4		308.875	-68.28	-0.49	-68.77	-13.00	-55.77	peak	
5		688.145	-66.81	6.68	-60.13	-13.00	-47.13	peak	
6 *		936.950	-64.47	10.89	-53.58	-13.00	-40.58	peak	

Test Mode: LTE Band 5_TX CH20525_5M_Main Antenna

Horizontal

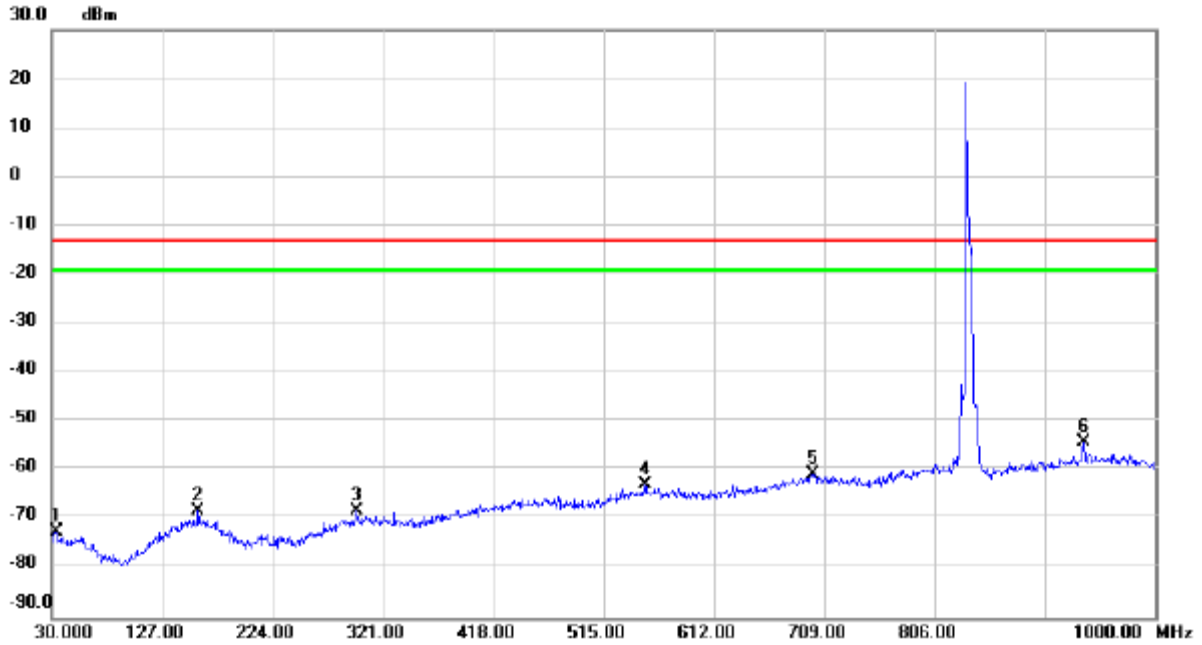

No.	Mk.	Freq. MHz	Reading Level dBm	Correct Factor dB	Measure- ment dBm	Limit dBm	Margin dB	Detector	Comment
1		34.850	-67.48	-4.88	-72.36	-13.00	-59.36	peak	
2		159.010	-67.70	-0.68	-68.38	-13.00	-55.38	peak	
3		298.205	-67.90	-0.48	-68.38	-13.00	-55.38	peak	
4		551.375	-67.34	4.52	-62.82	-13.00	-49.82	peak	
5		699.785	-67.94	7.24	-60.70	-13.00	-47.70	peak	
6	*	936.950	-65.03	10.89	-54.14	-13.00	-41.14	peak	

Test Mode: LTE Band 5_TX CH20525_10M_Main Antenna

Vertical

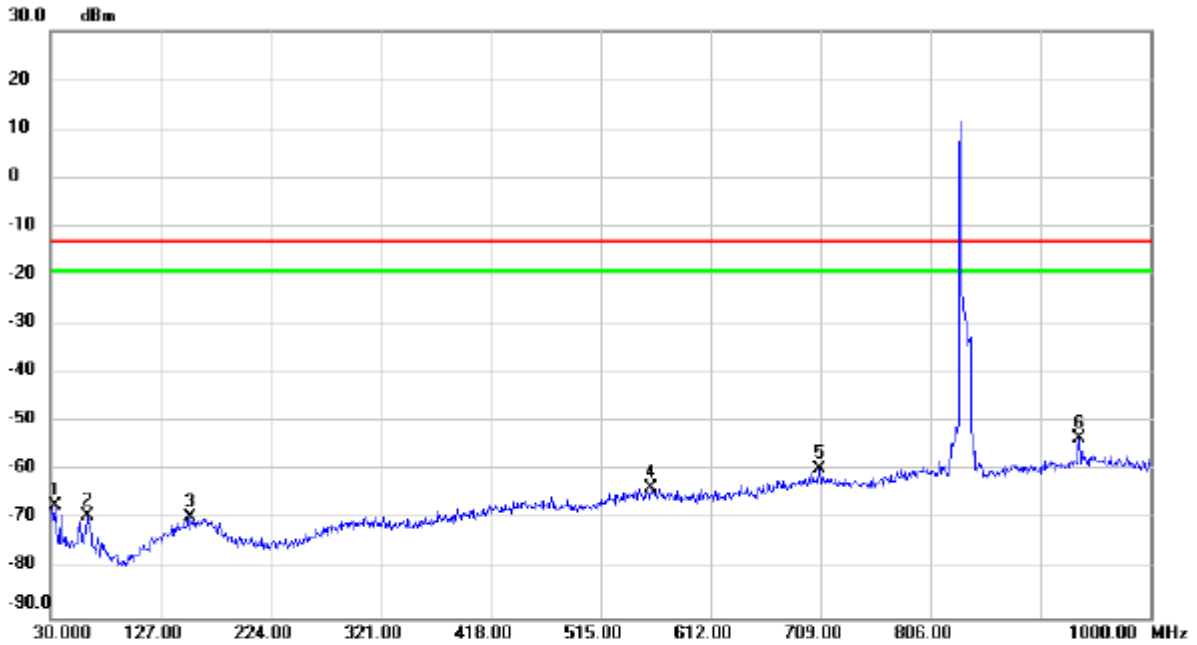

No.	Mk.	Freq. MHz	Reading Level dBm	Correct Factor dB	Measure- ment dBm	Limit dBm	Margin dB	Detector	Comment
1		34.850	-62.15	-4.88	-67.03	-13.00	-54.03	peak	
2		63.465	-63.03	-6.27	-69.30	-13.00	-56.30	peak	
3		153.675	-68.36	-1.17	-69.53	-13.00	-56.53	peak	
4		559.620	-67.97	4.38	-63.59	-13.00	-50.59	peak	
5		708.030	-66.50	7.05	-59.45	-13.00	-46.45	peak	
6	*	936.950	-64.02	10.89	-53.13	-13.00	-40.13	peak	

Test Mode: LTE Band 5_TX CH20525_10M_Main Antenna

Horizontal



No.	Mk.	Freq. MHz	Reading Level dBm	Correct Factor dB	Measure- ment dBm	Limit dBm	Margin dB	Detector	Comment
1		155.615	-68.21	-0.99	-69.20	-13.00	-56.20	peak	
2		305.480	-68.32	-0.45	-68.77	-13.00	-55.77	peak	
3		472.805	-67.53	2.09	-65.44	-13.00	-52.44	peak	
4		564.470	-67.76	4.30	-63.46	-13.00	-50.46	peak	
5		696.875	-67.52	7.10	-60.42	-13.00	-47.42	peak	
6	*	936.950	-65.11	10.89	-54.22	-13.00	-41.22	peak	

Test Mode: GSM850_TX CH190_GSM_with Earphone_DIV Antenna

Vertical



No.	Mk.	Freq. MHz	Reading Level dBm	Correct Factor dB	Measure- ment dBm	Limit dBm	Margin dB	Detector	Comment
1		35.335	-61.91	-4.93	-66.84	-13.00	-53.84	peak	
2		160.465	-68.03	-0.62	-68.65	-13.00	-55.65	peak	
3		594.540	-66.95	3.80	-63.15	-13.00	-50.15	peak	
4		692.025	-67.23	6.87	-60.36	-13.00	-47.36	peak	
5		796.300	-67.56	8.74	-58.82	-13.00	-45.82	peak	
6 *		943.255	-65.93	11.14	-54.79	-13.00	-41.79	peak	

Test Mode: GSM850_TX CH190_GSM_with Earphone_DIV Antenna

Horizontal



No.	Mk.	Freq. MHz	Reading Level dBm	Correct Factor dB	Measure- ment dBm	Limit dBm	Margin dB	Detector	Comment
1		160.465	-68.63	-0.62	-69.25	-13.00	-56.25	peak	
2		447.100	-68.08	2.47	-65.61	-13.00	-52.61	peak	
3		546.040	-67.57	4.29	-63.28	-13.00	-50.28	peak	
4		711.910	-66.67	6.94	-59.73	-13.00	-46.73	peak	
5		798.240	-67.84	8.85	-58.99	-13.00	-45.99	peak	
6	*	950.530	-68.11	11.40	-56.71	-13.00	-43.71	peak	

Test Mode: GSM850_TX CH190_EDGE_with Earphone_DIV Antenna

Vertical



No.	Mk.	Freq. MHz	Reading Level dBm	Correct Factor dB	Measure- ment dBm	Limit dBm	Margin dB	Detector	Comment
1		35.335	-61.34	-4.93	-66.27	-13.00	-53.27	peak	
2		154.645	-68.54	-1.08	-69.62	-13.00	-56.62	peak	
3		545.555	-67.42	4.26	-63.16	-13.00	-50.16	peak	
4		702.210	-67.73	7.20	-60.53	-13.00	-47.53	peak	
5		806.970	-67.66	8.86	-58.80	-13.00	-45.80	peak	
6	*	936.950	-65.91	10.89	-55.02	-13.00	-42.02	peak	

Test Mode: GSM850_TX CH190_EDGE_with Earphone_DIV Antenna

Horizontal



No.	Mk.	Freq. MHz	Reading Level dBm	Correct Factor dB	Measure- ment dBm	Limit dBm	Margin dB	Detector	Comment
1		157.555	-68.53	-0.82	-69.35	-13.00	-56.35	peak	
2		460.195	-67.98	2.37	-65.61	-13.00	-52.61	peak	
3		549.435	-67.85	4.50	-63.35	-13.00	-50.35	peak	
4		686.205	-67.20	6.58	-60.62	-13.00	-47.62	peak	
5		803.090	-67.52	8.91	-58.61	-13.00	-45.61	peak	
6 *		936.950	-64.70	10.89	-53.81	-13.00	-40.81	peak	

Test Mode: GSM850_TX CH190_GSM_without Earphone_DIV Antenna

Vertical

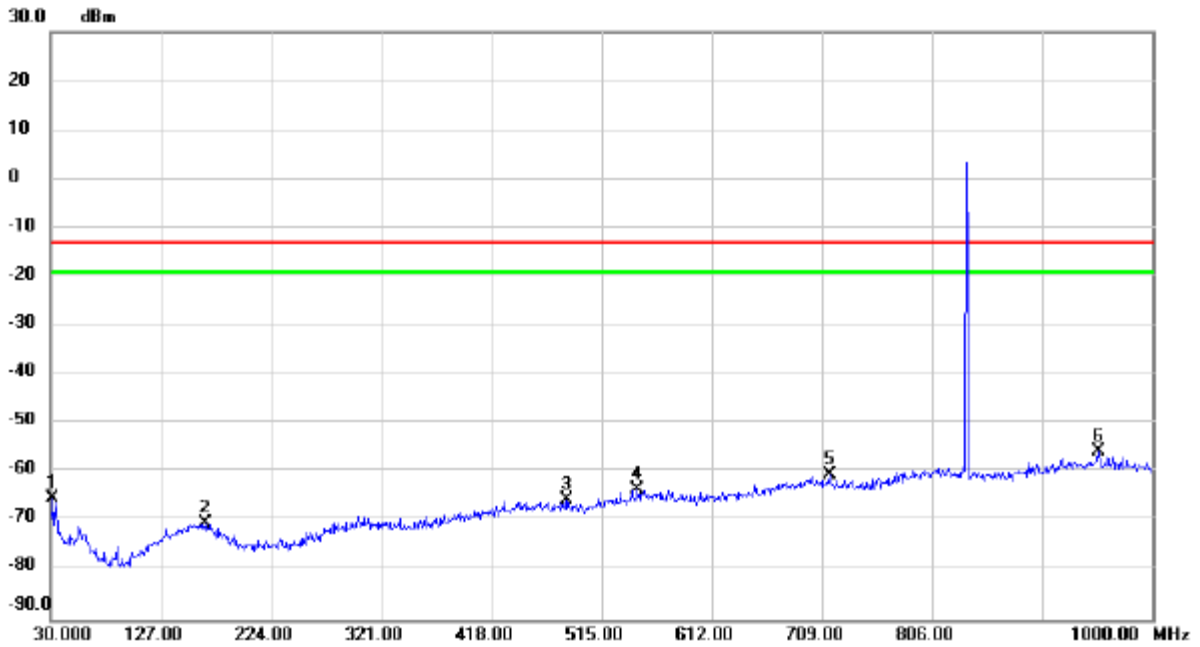

No.	Mk.	Freq. MHz	Reading Level dBm	Correct Factor dB	Measure- ment dBm	Limit dBm	Margin dB	Detector	Comment
1		32.425	-60.29	-5.00	-65.29	-13.00	-52.29	peak	
2		166.770	-69.28	-1.00	-70.28	-13.00	-57.28	peak	
3		484.930	-67.33	1.81	-65.52	-13.00	-52.52	peak	
4		546.040	-67.65	4.29	-63.36	-13.00	-50.36	peak	
5		716.275	-67.37	6.83	-60.54	-13.00	-47.54	peak	
6	*	952.955	-67.00	11.34	-55.66	-13.00	-42.66	peak	

Test Mode: GSM850_TX CH190_GSM_without Earphone_DIV Antenna

Horizontal



No.	Mk.	Freq. MHz	Reading Level dBm	Correct Factor dB	Measure- ment dBm	Limit dBm	Margin dB	Detector	Comment
1		162.405	-68.78	-0.74	-69.52	-13.00	-56.52	peak	
2		306.450	-68.26	-0.46	-68.72	-13.00	-55.72	peak	
3		475.230	-67.08	2.03	-65.05	-13.00	-52.05	peak	
4		542.160	-67.79	4.06	-63.73	-13.00	-50.73	peak	
5		716.760	-67.57	6.82	-60.75	-13.00	-47.75	peak	
6	*	957.320	-68.06	11.23	-56.83	-13.00	-43.83	peak	

Test Mode: GSM850_TX CH190_EDGE_without Earphone_DIV Antenna

Vertical

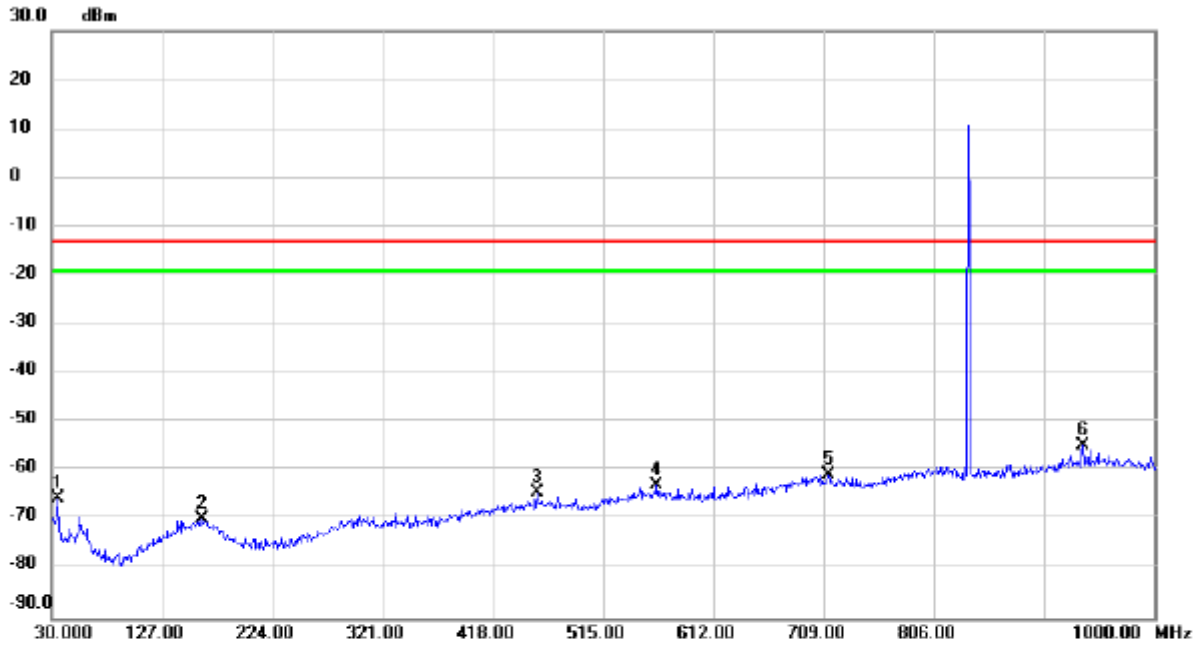

No.	Mk.	Freq. MHz	Reading Level dBm	Correct Factor dB	Measure- ment dBm	Limit dBm	Margin dB	Detector	Comment
1		35.335	-60.50	-4.93	-65.43	-13.00	-52.43	peak	
2		162.890	-69.04	-0.77	-69.81	-13.00	-56.81	peak	
3		457.285	-66.74	2.43	-64.31	-13.00	-51.31	peak	
4		562.530	-67.28	4.32	-62.96	-13.00	-49.96	peak	
5		712.880	-67.63	6.92	-60.71	-13.00	-47.71	peak	
6	*	936.950	-65.67	10.89	-54.78	-13.00	-41.78	peak	

Test Mode: GSM850_TX CH190_EDGE_without Earphone_DIV Antenna

Horizontal

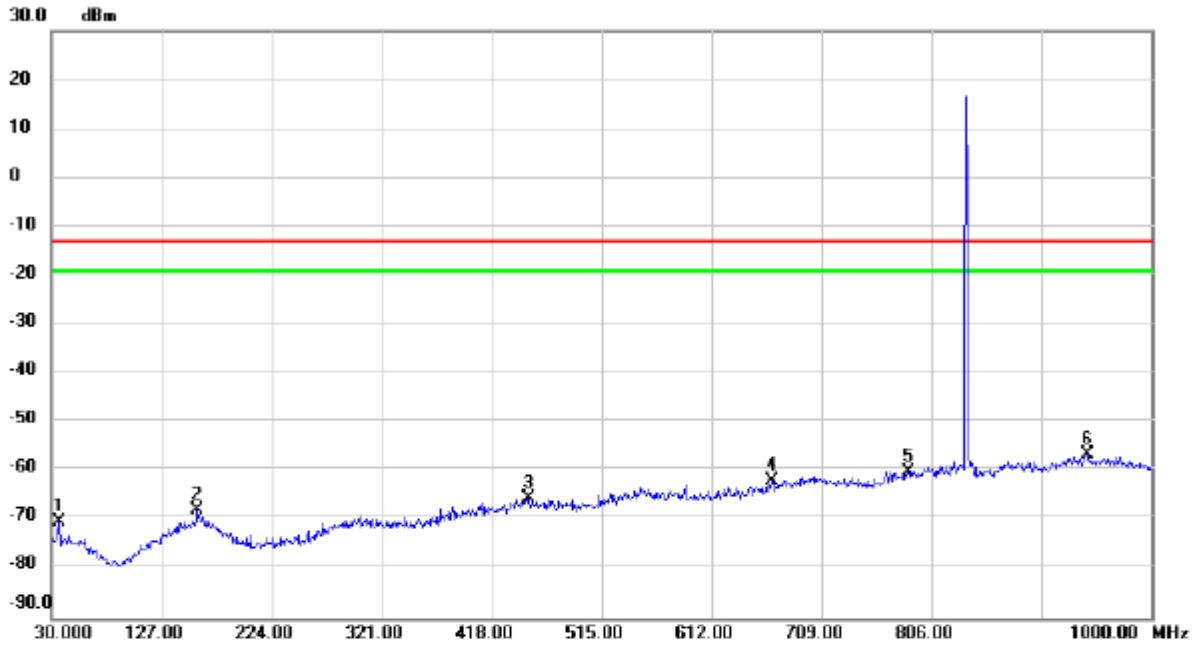

No.	Mk.	Freq. MHz	Reading Level dBm	Correct Factor dB	Measure- ment dBm	Limit dBm	Margin dB	Detector	Comment
1		36.790	-65.50	-4.86	-70.36	-13.00	-57.36	peak	
2		159.010	-67.33	-0.68	-68.01	-13.00	-55.01	peak	
3		451.465	-68.10	2.56	-65.54	-13.00	-52.54	peak	
4		665.350	-67.48	5.57	-61.91	-13.00	-48.91	peak	
5		786.115	-68.17	8.13	-60.04	-13.00	-47.04	peak	
6	*	943.255	-67.69	11.14	-56.55	-13.00	-43.55	peak	

Test Mode: WCDMA Band V_TX CH4182_DIV Antenna

Vertical



No.	Mk.	Freq. MHz	Reading Level dBm	Correct Factor dB	Measure- ment dBm	Limit dBm	Margin dB	Detector	Comment
1		35.335	-50.96	-14.93	-65.89	-13.00	-52.89	peak	
2		163.375	-58.63	-10.81	-69.44	-13.00	-56.44	peak	
3		463.105	-58.18	-7.70	-65.88	-13.00	-52.88	peak	
4		543.130	-59.04	-5.89	-64.93	-13.00	-51.93	peak	
5		682.325	-58.28	-3.60	-61.88	-13.00	-48.88	peak	
6	*	936.950	-55.85	0.89	-54.96	-13.00	-41.96	peak	

Test Mode: WCDMA Band V_TX CH4182_DIV Antenna

Horizontal



No.	Mk.	Freq. MHz	Reading Level dBm	Correct Factor dB	Measure- ment dBm	Limit dBm	Margin dB	Detector	Comment
1		163.375	-59.32	-10.81	-70.13	-13.00	-57.13	peak	
2		321.970	-59.69	-10.68	-70.37	-13.00	-57.37	peak	
3		455.345	-58.30	-7.53	-65.83	-13.00	-52.83	peak	
4		557.195	-58.86	-5.59	-64.45	-13.00	-51.45	peak	
5		712.880	-58.26	-3.08	-61.34	-13.00	-48.34	peak	
6	*	958.290	-58.56	1.22	-57.34	-13.00	-44.34	peak	

Test Mode: LTE Band 5_TX CH20525_1.4M_DIV Antenna

Vertical

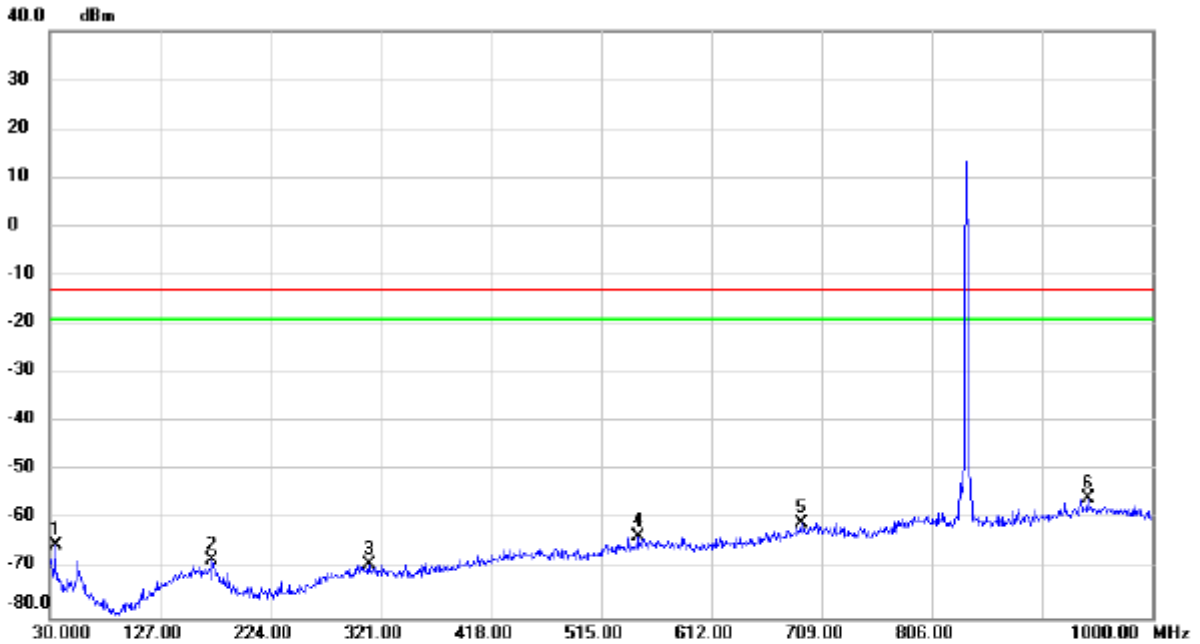

No.	Mk.	Freq. MHz	Reading Level dBm	Correct Factor dB	Measure- ment dBm	Limit dBm	Margin dB	Detector	Comment
1		35.335	-60.08	-4.93	-65.01	-13.00	-52.01	peak	
2		172.590	-66.58	-1.61	-68.19	-13.00	-55.19	peak	
3		310.815	-68.54	-0.52	-69.06	-13.00	-56.06	peak	
4		547.980	-67.84	4.41	-63.43	-13.00	-50.43	peak	
5		692.025	-67.41	6.87	-60.54	-13.00	-47.54	peak	
6 *		943.255	-66.56	11.14	-55.42	-13.00	-42.42	peak	

Test Mode: LTE Band 5_TX CH20525_1.4M_DIV Antenna

Horizontal



No.	Mk.	Freq. MHz	Reading Level dBm	Correct Factor dB	Measure- ment dBm	Limit dBm	Margin dB	Detector	Comment
1		34.850	-66.77	-4.88	-71.65	-13.00	-58.65	peak	
2		156.100	-66.87	-0.94	-67.81	-13.00	-54.81	peak	
3		377.260	-66.70	-0.15	-66.85	-13.00	-53.85	peak	
4		543.130	-67.16	4.11	-63.05	-13.00	-50.05	peak	
5		702.695	-66.60	7.19	-59.41	-13.00	-46.41	peak	
6	*	936.950	-66.22	10.89	-55.33	-13.00	-42.33	peak	

Test Mode: LTE Band 5_TX CH20525_5M_DIV Antenna

Vertical

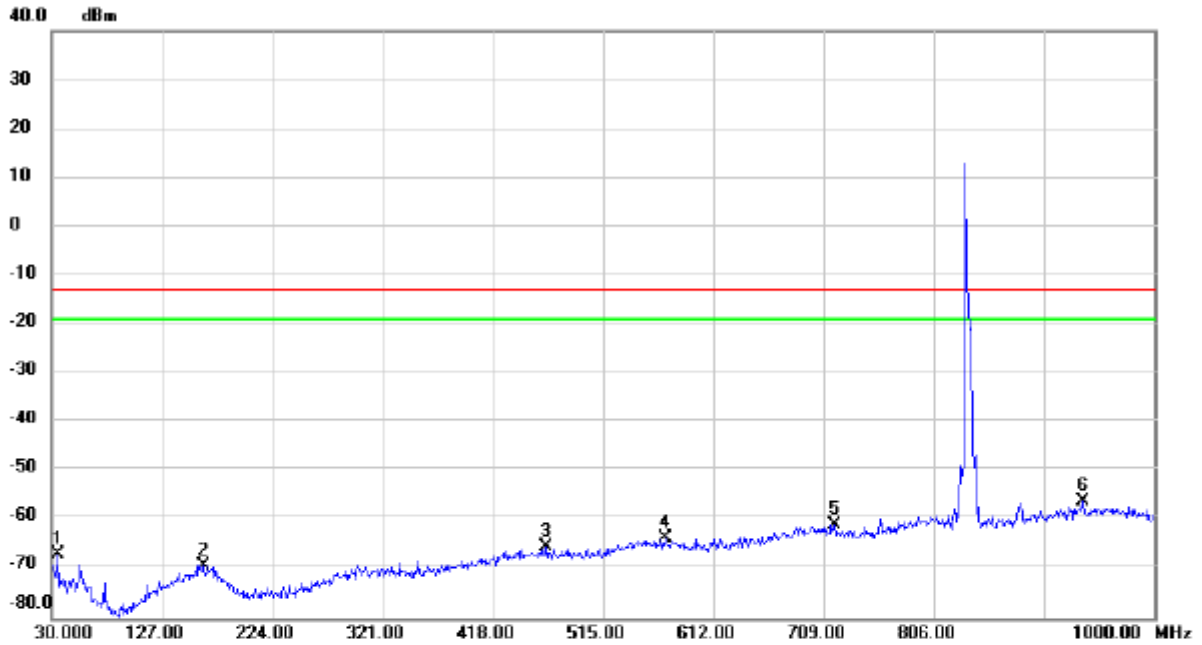

No.	Mk.	Freq. MHz	Reading Level dBm	Correct Factor dB	Measure- ment dBm	Limit dBm	Margin dB	Detector	Comment
1		35.335	-62.14	-4.93	-67.07	-13.00	-54.07	peak	
2		163.375	-68.50	-0.81	-69.31	-13.00	-56.31	peak	
3		465.530	-67.79	2.24	-65.55	-13.00	-52.55	peak	
4		569.320	-68.01	4.21	-63.80	-13.00	-50.80	peak	
5		719.185	-67.77	6.75	-61.02	-13.00	-48.02	peak	
6	*	936.950	-66.94	10.89	-56.05	-13.00	-43.05	peak	

Test Mode: LTE Band 5_TX CH20525_5M_DIV Antenna

Horizontal

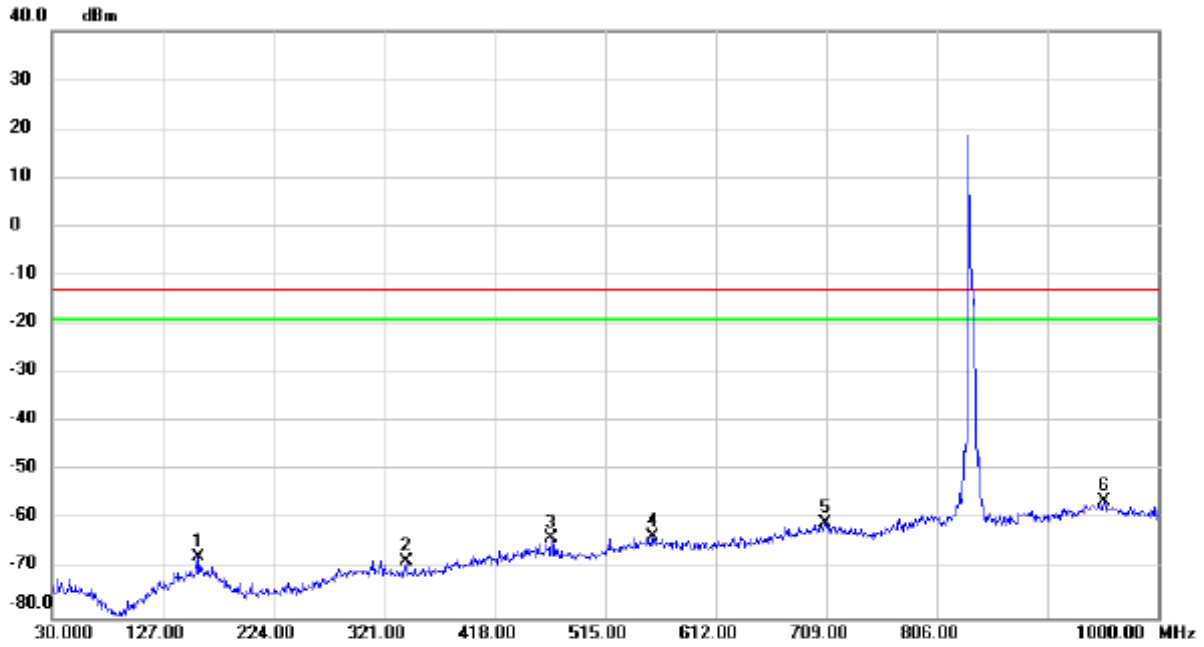

No.	Mk.	Freq. MHz	Reading Level dBm	Correct Factor dB	Measure- ment dBm	Limit dBm	Margin dB	Detector	Comment
1		159.010	-66.91	-0.68	-67.59	-13.00	-54.59	peak	
2		340.885	-67.40	-0.94	-68.34	-13.00	-55.34	peak	
3		467.955	-65.93	2.19	-63.74	-13.00	-50.74	peak	
4		556.710	-67.85	4.42	-63.43	-13.00	-50.43	peak	
5		708.515	-67.55	7.03	-60.52	-13.00	-47.52	peak	
6	*	952.955	-67.62	11.34	-56.28	-13.00	-43.28	peak	

Test Mode: LTE Band 5_TX CH20525_10M_DIV Antenna

Vertical

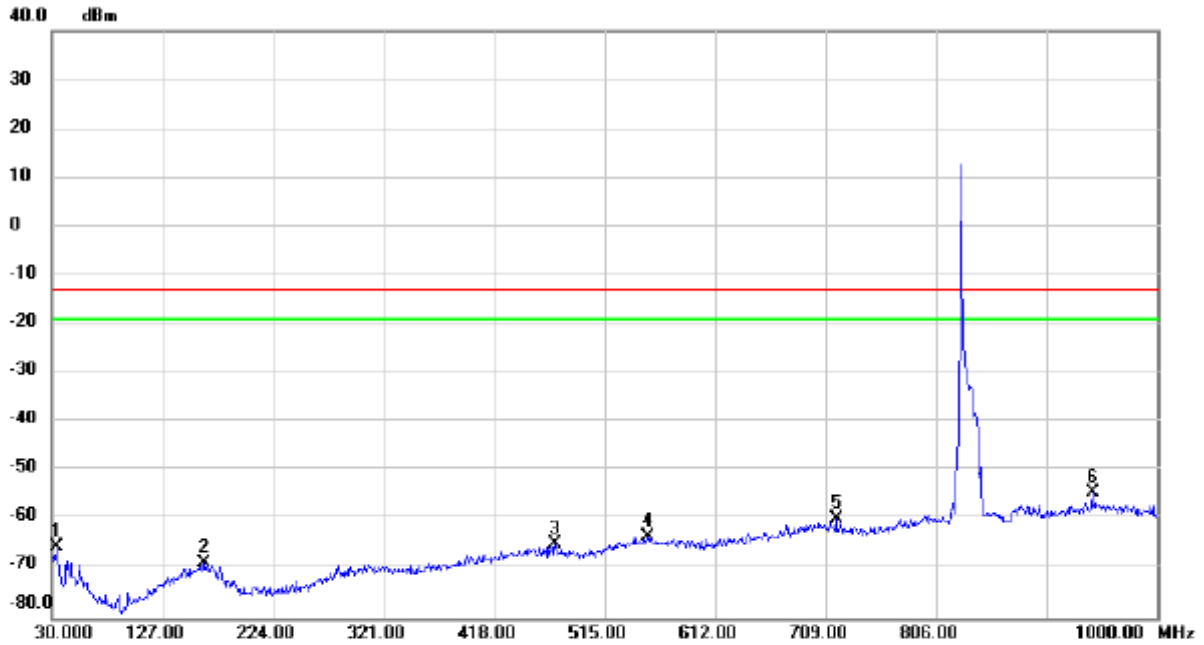

No.	Mk.	Freq. MHz	Reading Level dBm	Correct Factor dB	Measure- ment dBm	Limit dBm	Margin dB	Detector	Comment
1		34.365	-60.75	-4.85	-65.60	-13.00	-52.60	peak	
2		163.860	-67.96	-0.83	-68.79	-13.00	-55.79	peak	
3		471.350	-66.91	2.11	-64.80	-13.00	-51.80	peak	
4		552.830	-67.76	4.48	-63.28	-13.00	-50.28	peak	
5		718.215	-66.62	6.78	-59.84	-13.00	-46.84	peak	
6	*	943.255	-65.34	11.14	-54.20	-13.00	-41.20	peak	

Test Mode: LTE Band 5_TX CH20525_10M_DIV Antenna

Horizontal

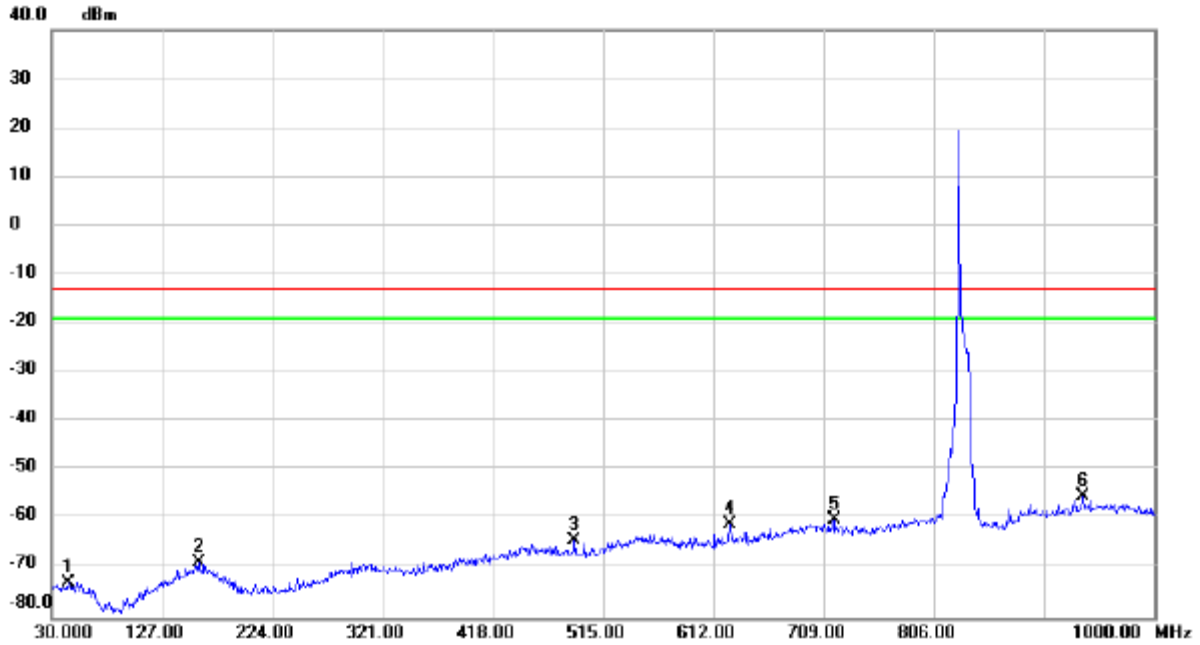

No.	Mk.	Freq. MHz	Reading Level dBm	Correct Factor dB	Measure- ment dBm	Limit dBm	Margin dB	Detector	Comment
1		45.035	-68.23	-4.72	-72.95	-13.00	-59.95	peak	
2		159.495	-68.16	-0.64	-68.80	-13.00	-55.80	peak	
3		490.265	-66.01	1.69	-64.32	-13.00	-51.32	peak	
4		627.035	-65.40	4.31	-61.09	-13.00	-48.09	peak	
5		718.215	-66.70	6.78	-59.92	-13.00	-46.92	peak	
6	*	936.950	-66.10	10.89	-55.21	-13.00	-42.21	peak	

APPENDIX C - RADIATED EMISSION (ABOVE 1GHZ)

Test Mode: GSM850_TX CH190_GSM_with Earphone_Main Antenna

Vertical

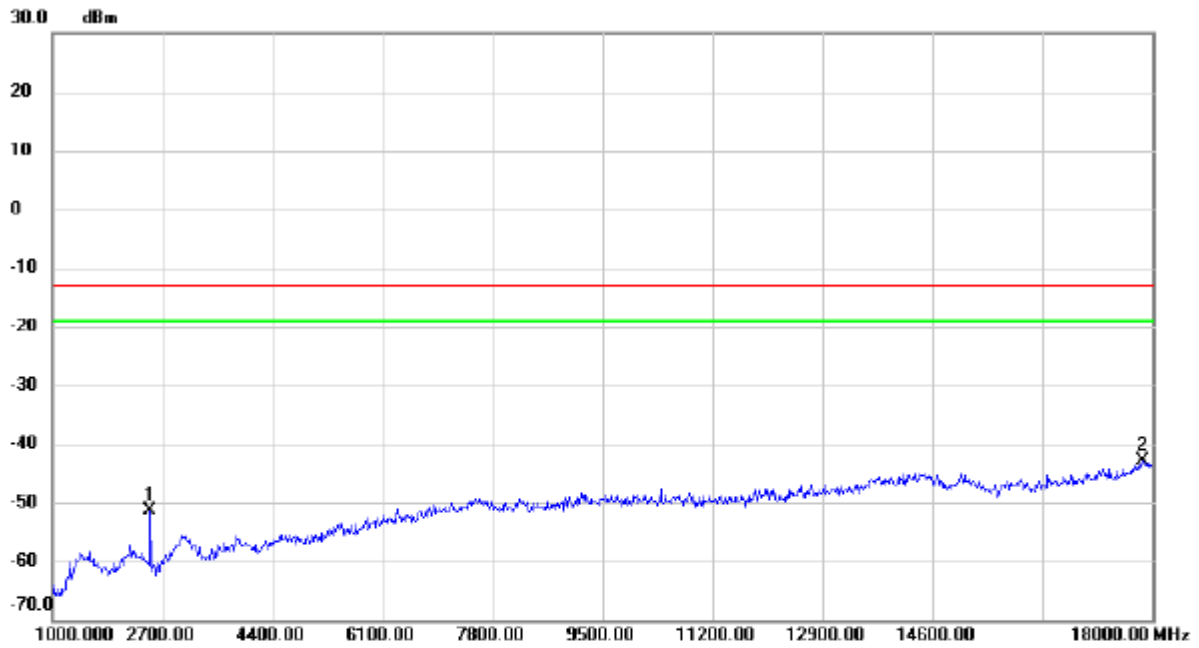

No.	Mk.	Freq. MHz	Reading Level dBm	Correct Factor dB	Measure- ment dBm	Limit dBm	Margin dB	Detector	Comment
1		2513.000	-58.16	6.69	-51.47	-13.00	-38.47	peak	
2	*	17847.000	-71.83	28.91	-42.92	-13.00	-29.92	peak	

Test Mode: GSM850_TX CH190_GSM_with Earphone_Main Antenna

Horizontal

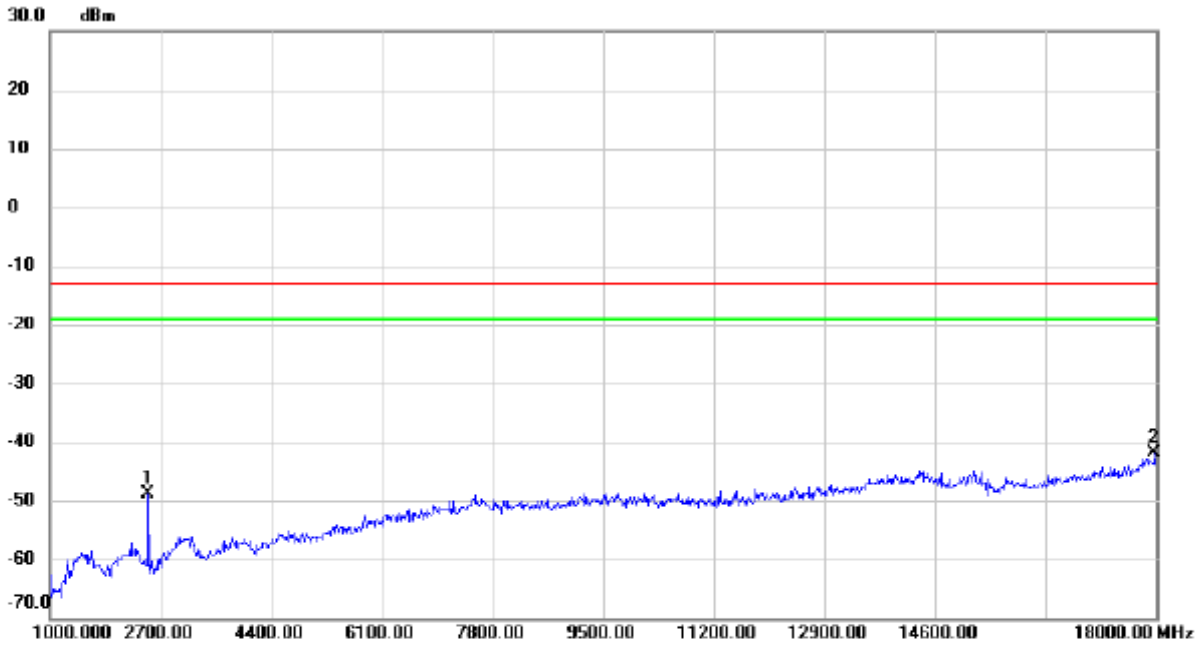

No.	Mk.	Freq. MHz	Reading Level dBm	Correct Factor dB	Measure- ment dBm	Limit dBm	Margin dB	Detector	Comment
1		2513.000	-55.59	6.69	-48.90	-13.00	-35.90	peak	
2	*	17974.500	-71.22	29.29	-41.93	-13.00	-28.93	peak	

Test Mode: GSM850_TX CH190_EDGE_with Earphone_Main Antenna

Vertical

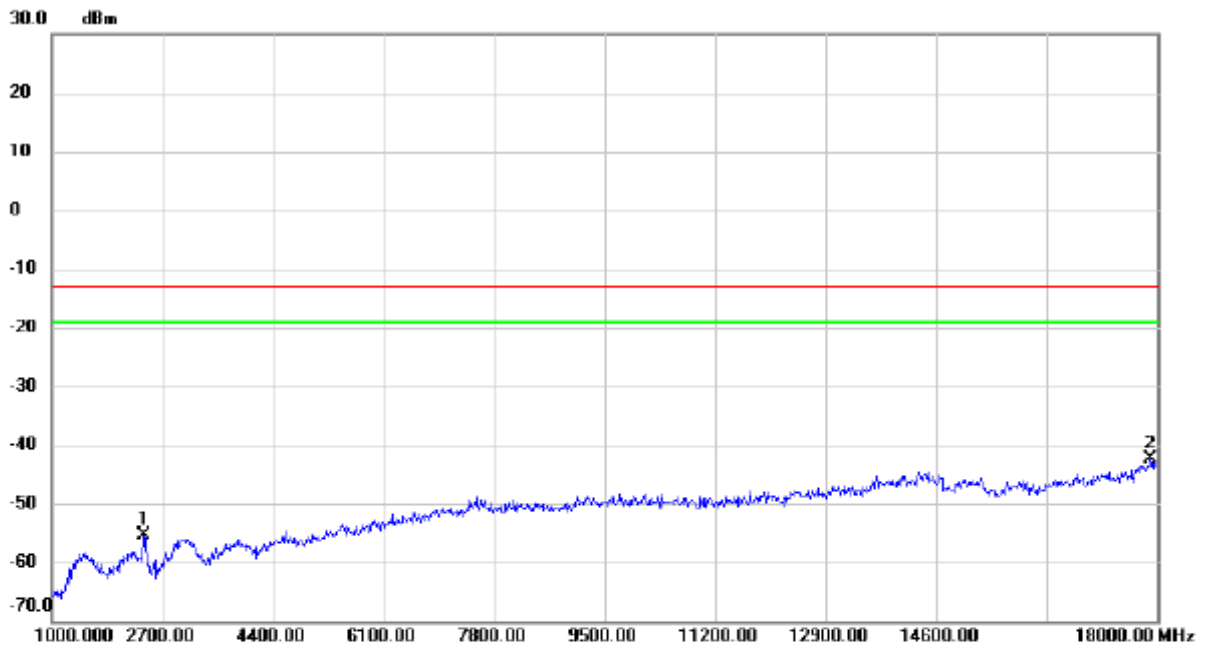

No.	Mk.	Freq. MHz	Reading Level dBm	Correct Factor dB	Measure- ment dBm	Limit dBm	Margin dB	Detector	Comment
1		2419.500	-61.87	6.62	-55.25	-13.00	-42.25	peak	
2	*	17898.000	-71.50	29.07	-42.43	-13.00	-29.43	peak	

Test Mode: GSM850_TX CH190_EDGE_with Earphone_Main Antenna

Horizontal

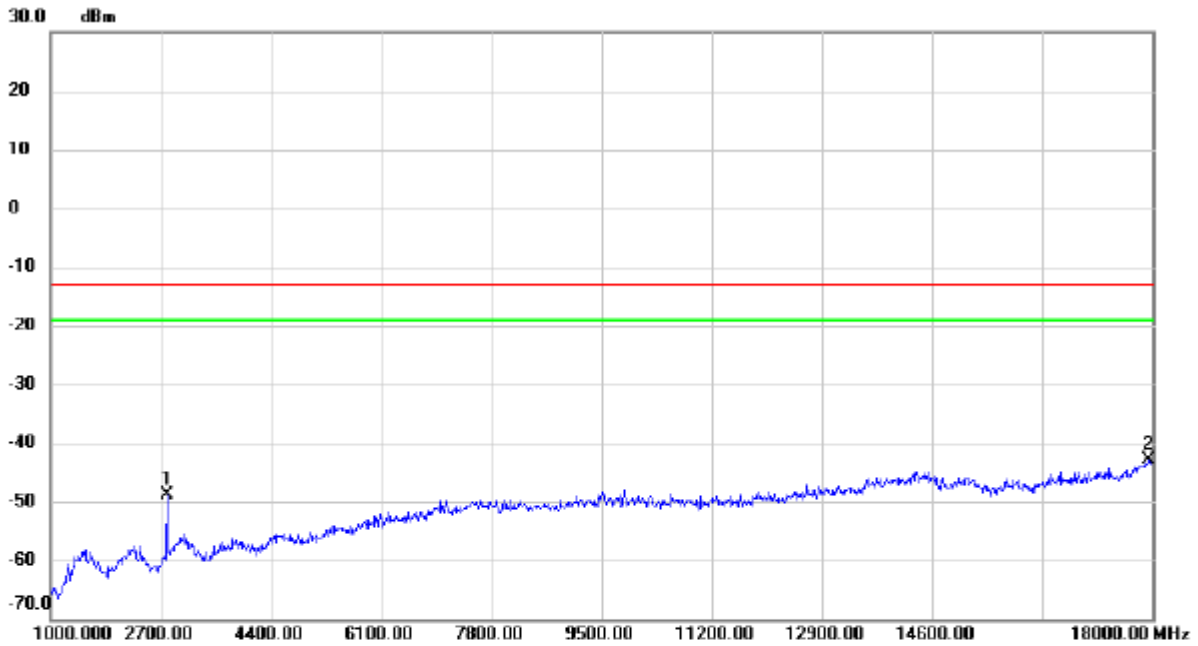

No.	Mk.	Freq. MHz	Reading Level dBm	Correct Factor dB	Measure- ment dBm	Limit dBm	Margin dB	Detector	Comment
1		2802.000	-57.46	8.63	-48.83	-13.00	-35.83	peak	
2	*	17949.000	-72.04	29.22	-42.82	-13.00	-29.82	peak	

Test Mode: GSM850_TX CH190_GSM_without Earphone_Main Antenna

Vertical

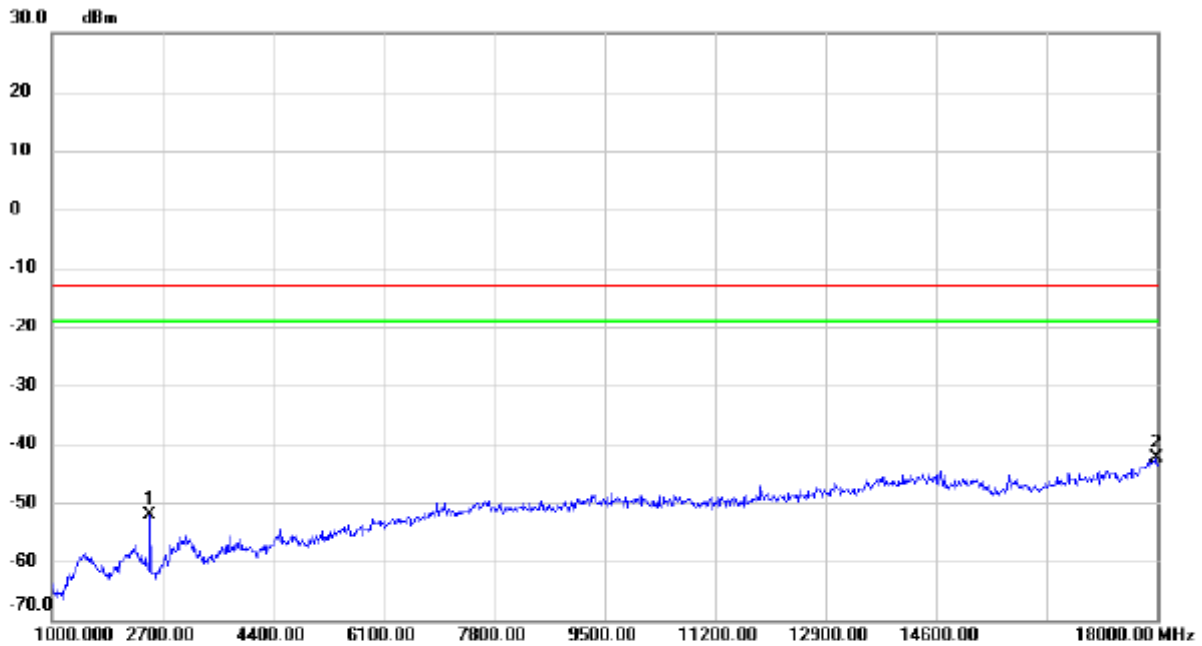

No.	Mk.	Freq. MHz	Reading Level dBm	Correct Factor dB	Measure- ment dBm	Limit dBm	Margin dB	Detector	Comment
1		2513.000	-58.87	6.69	-52.18	-13.00	-39.18	peak	
2	*	17983.000	-71.76	29.32	-42.44	-13.00	-29.44	peak	

Test Mode: GSM850_TX CH190_GSM_without Earphone_Main Antenna

Horizontal

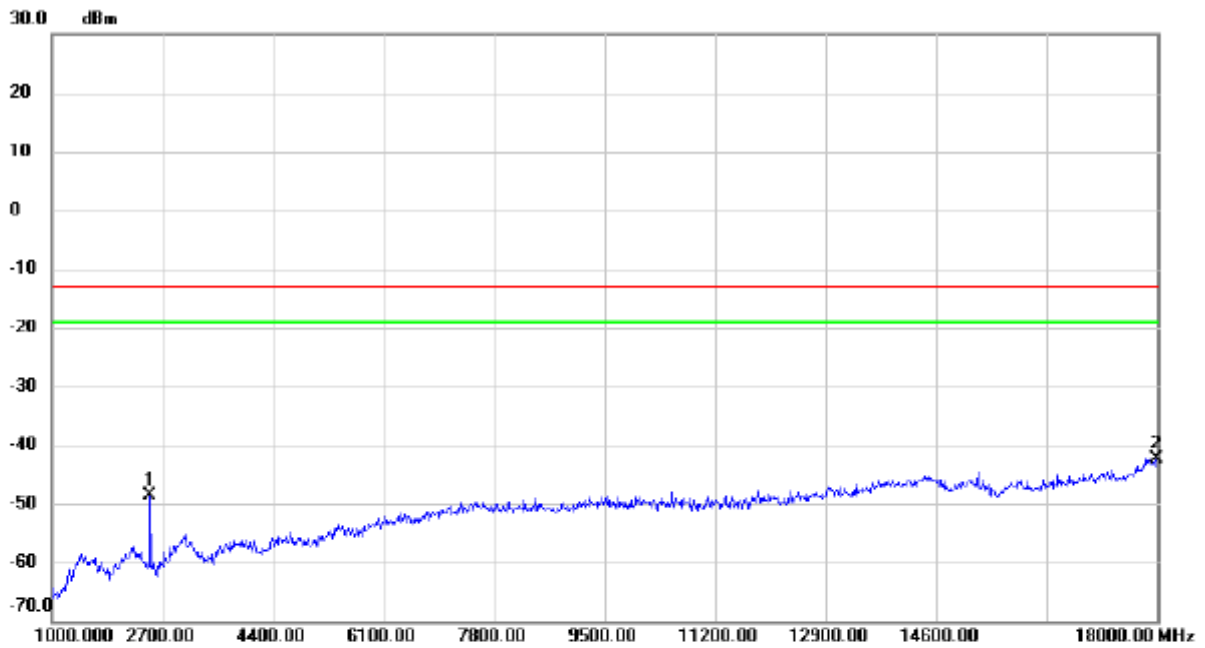

No.	Mk.	Freq. MHz	Reading Level dBm	Correct Factor dB	Measure- ment dBm	Limit dBm	Margin dB	Detector	Comment
1		2513.000	-55.34	6.69	-48.65	-13.00	-35.65	peak	
2	*	17983.000	-71.68	29.32	-42.36	-13.00	-29.36	peak	

Test Mode: GSM850_TX CH190_EDGE_without Earphone_Main Antenna

Vertical

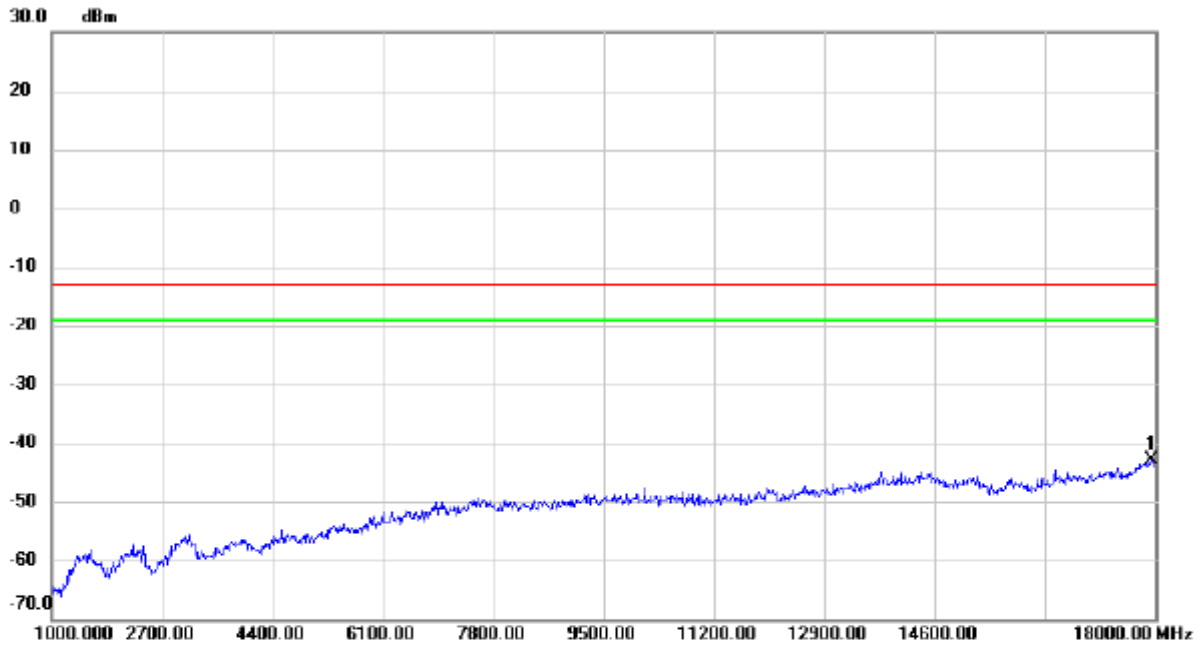

No. Mk.	Freq. MHz	Reading Level dBm	Correct Factor dB	Measure- ment dBm	Limit dBm	Margin dB	Detector	Comment
1 *	17949.000	-72.20	29.22	-42.98	-13.00	-29.98	peak	

Test Mode: GSM850_TX CH190_EDGE_without Earphone_Main Antenna

Horizontal

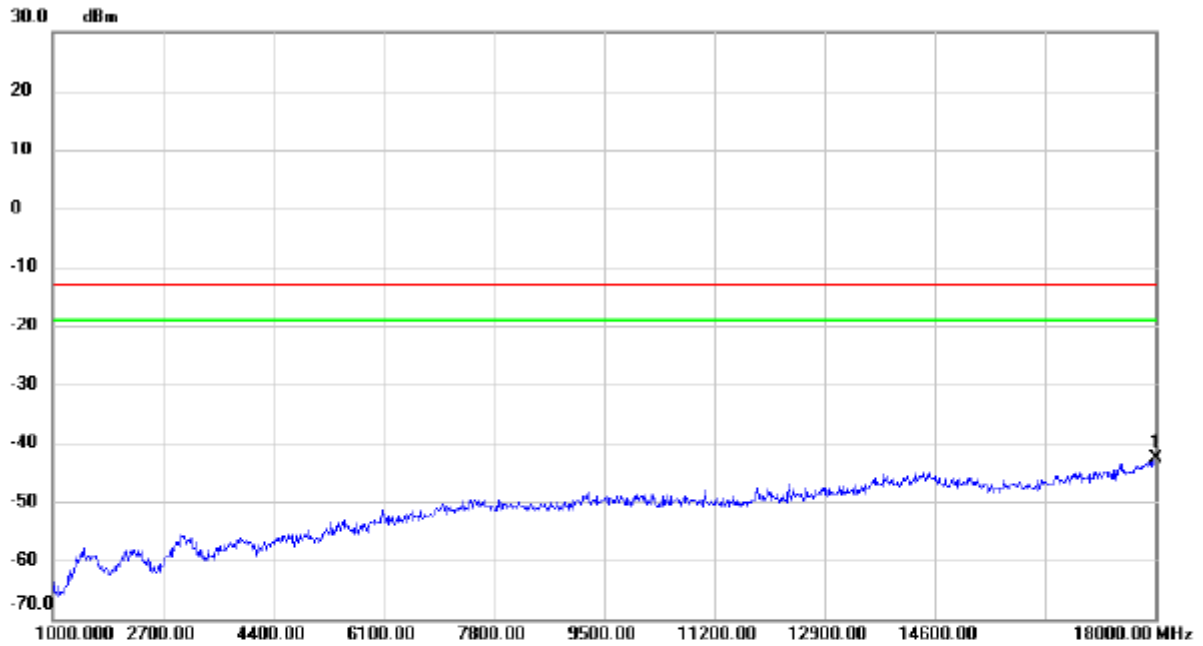

No. Mk.	Freq. MHz	Reading Level dBm	Correct Factor dB	Measure- ment dBm	Limit dBm	Margin dB	Detector	Comment
1 *	18000.000	-72.07	29.37	-42.70	-13.00	-29.70	peak	

Test Mode: WCDMA Band V_TX CH4182_Main Antenna

Vertical

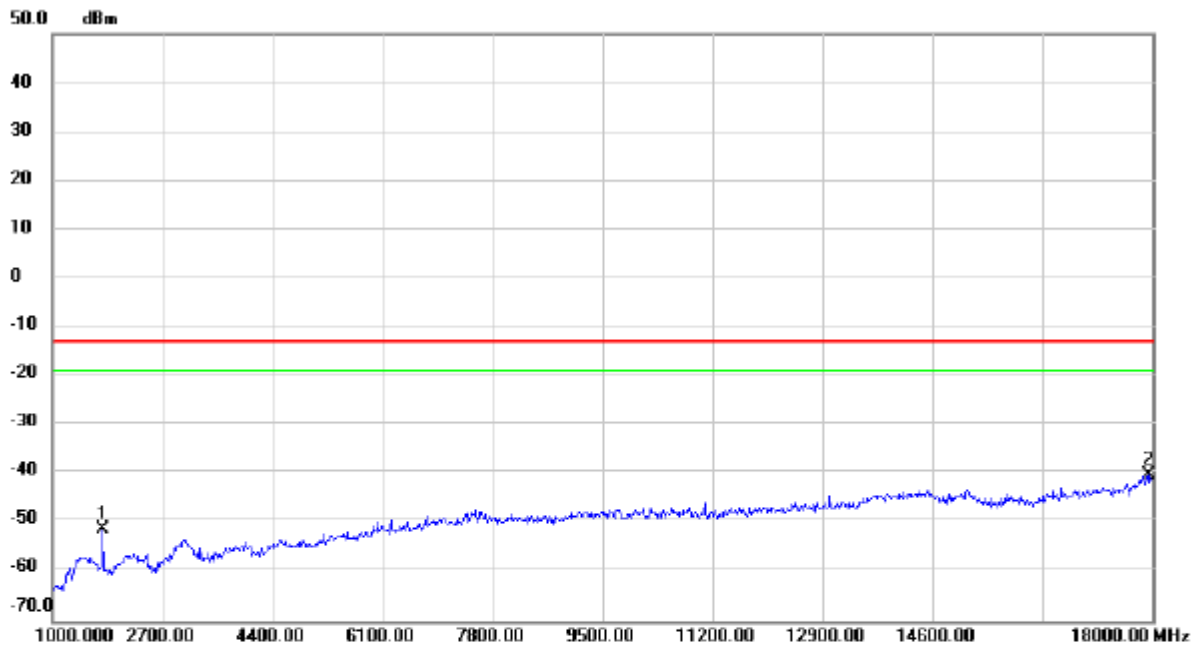

No.	Mk.	Freq. MHz	Reading Level dBm	Correct Factor dB	Measure- ment dBm	Limit dBm	Margin dB	Detector	Comment
1		1782.000	-47.34	-4.06	-51.40	-13.00	-38.40	peak	
2	*	17949.000	-59.27	19.22	-40.05	-13.00	-27.05	peak	

Test Mode: WCDMA Band V_TX CH4182_Main Antenna

Horizontal

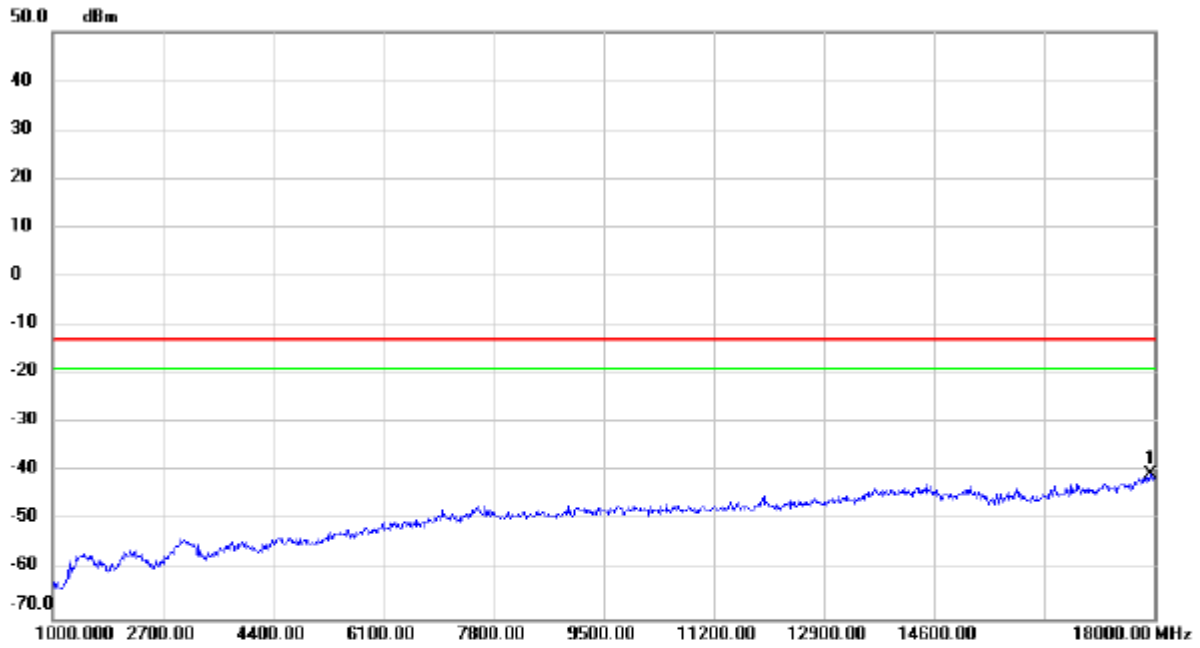

No.	Mk.	Freq.	Reading Level	Correct Factor	Measurement	Limit	Margin	Detector	Comment
		MHz	dBm	dB	dBm	dBm	dB		
1	*	17932.000	-59.53	19.16	-40.37	-13.00	-27.37	peak	

Test Mode: LTE Band 5_TX CH20525_1.4M_Main Antenna

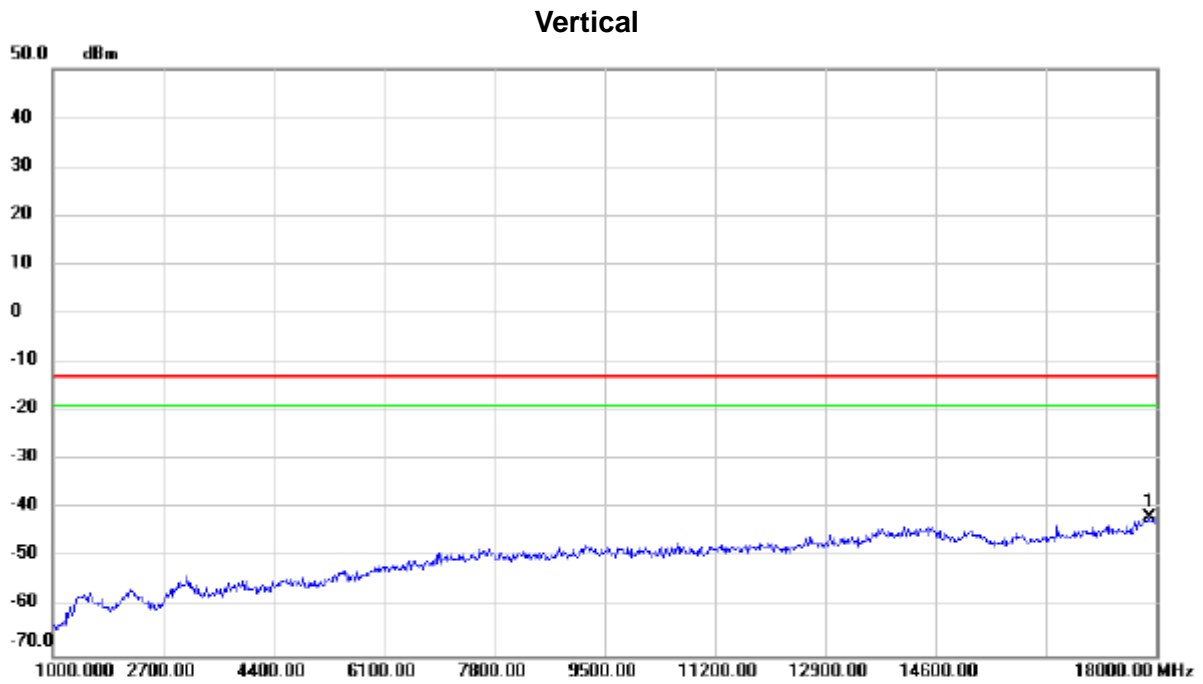

No.	Mk.	Freq. MHz	Reading Level dBm	Correct Factor dB	Measure- ment dBm	Limit dBm	Margin dB	Detector	Comment
1	*	17898.000	-60.67	19.07	-41.60	-13.00	-28.60	peak	

Test Mode: LTE Band 5_TX CH20525_1.4M_Main Antenna

Horizontal

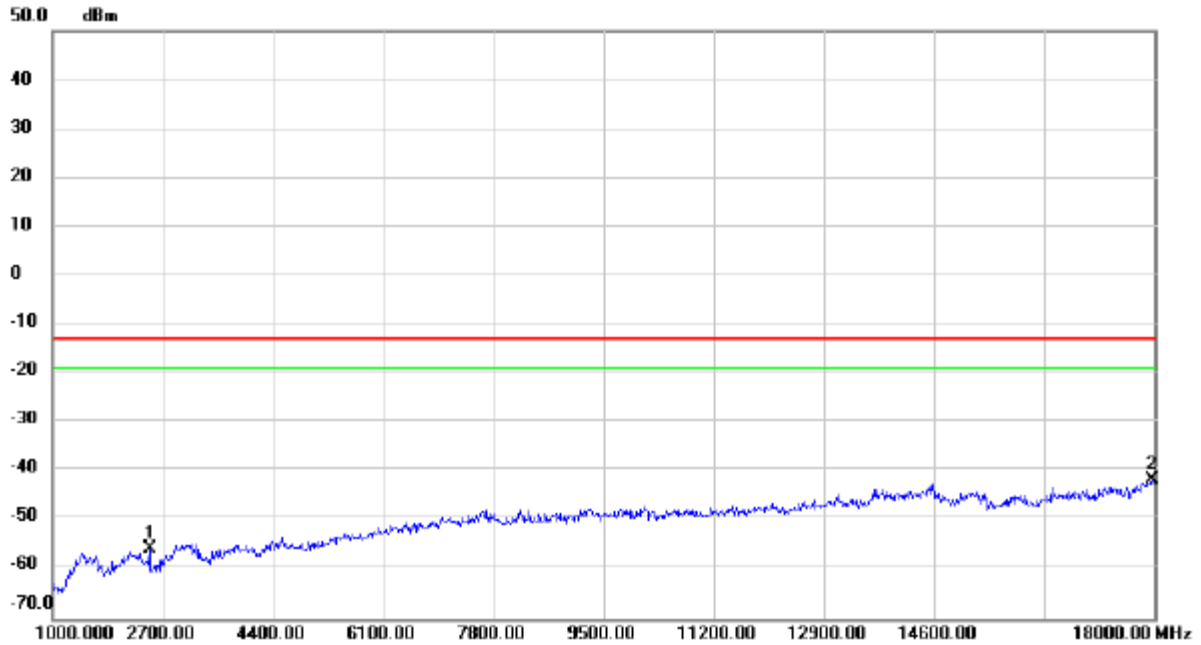

No.	Mk.	Freq. MHz	Reading Level dBm	Correct Factor dB	Measure- ment dBm	Limit dBm	Margin dB	Detector	Comment
1		2504.500	-52.46	-3.36	-55.82	-13.00	-42.82	peak	
2	*	17974.500	-60.95	19.29	-41.66	-13.00	-28.66	peak	

Test Mode: LTE Band 5_TX CH20525_5M_Main Antenna

Vertical

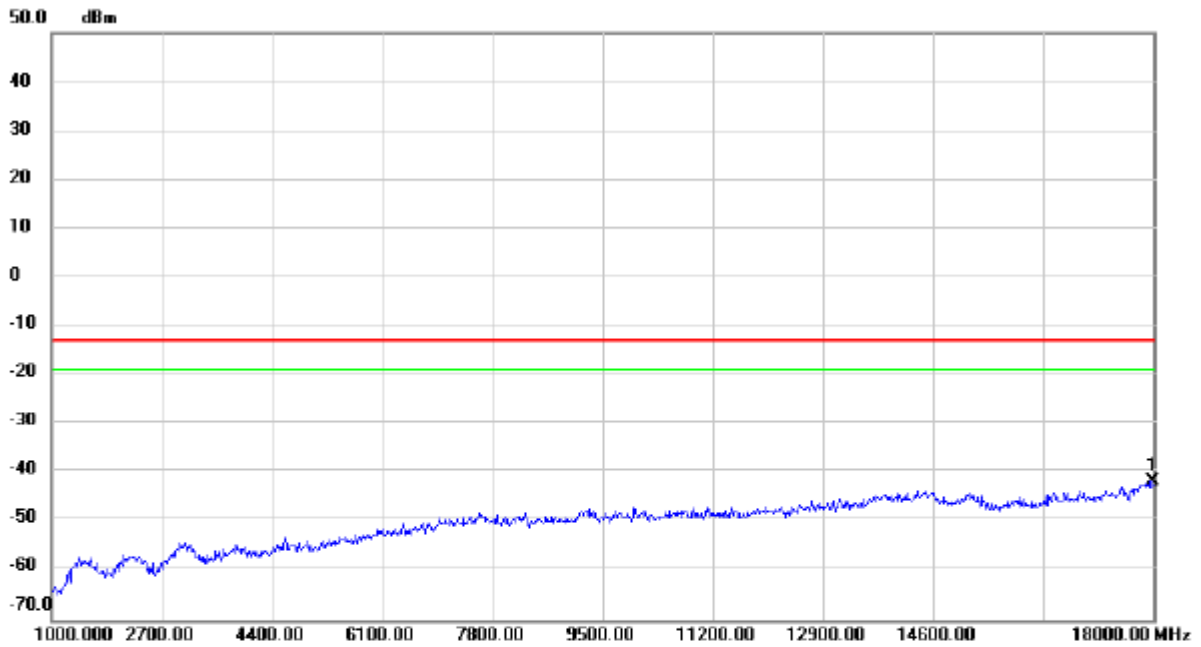

No.	Mk.	Freq. MHz	Reading Level dBm	Correct Factor dB	Measure- ment dBm	Limit dBm	Margin dB	Detector	Comment
1	*	17991.500	-61.02	19.34	-41.68	-13.00	-28.68	peak	

Test Mode: LTE Band 5_TX CH20525_5M_Main Antenna

Horizontal

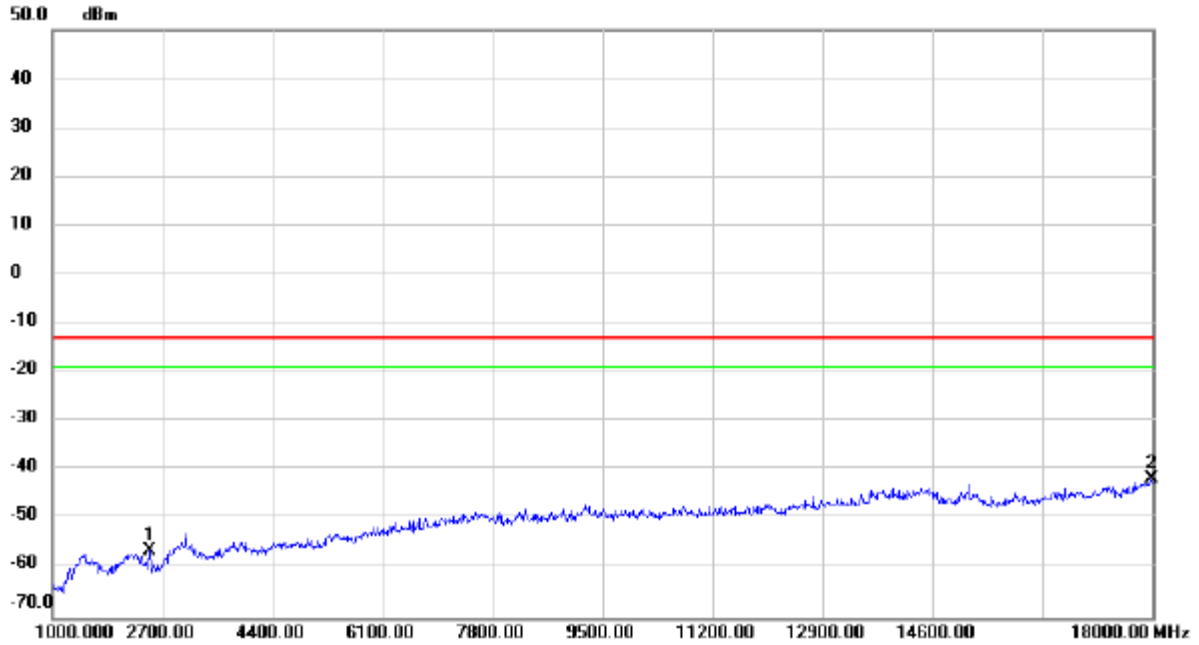

No.	Mk.	Freq. MHz	Reading Level dBm	Correct Factor dB	Measure- ment dBm	Limit dBm	Margin dB	Detector	Comment
1		2504.500	-52.96	-3.36	-56.32	-13.00	-43.32	peak	
2	*	17991.500	-60.90	19.34	-41.56	-13.00	-28.56	peak	

Test Mode: LTE Band 5_TX CH20525_10M_Main Antenna

Vertical

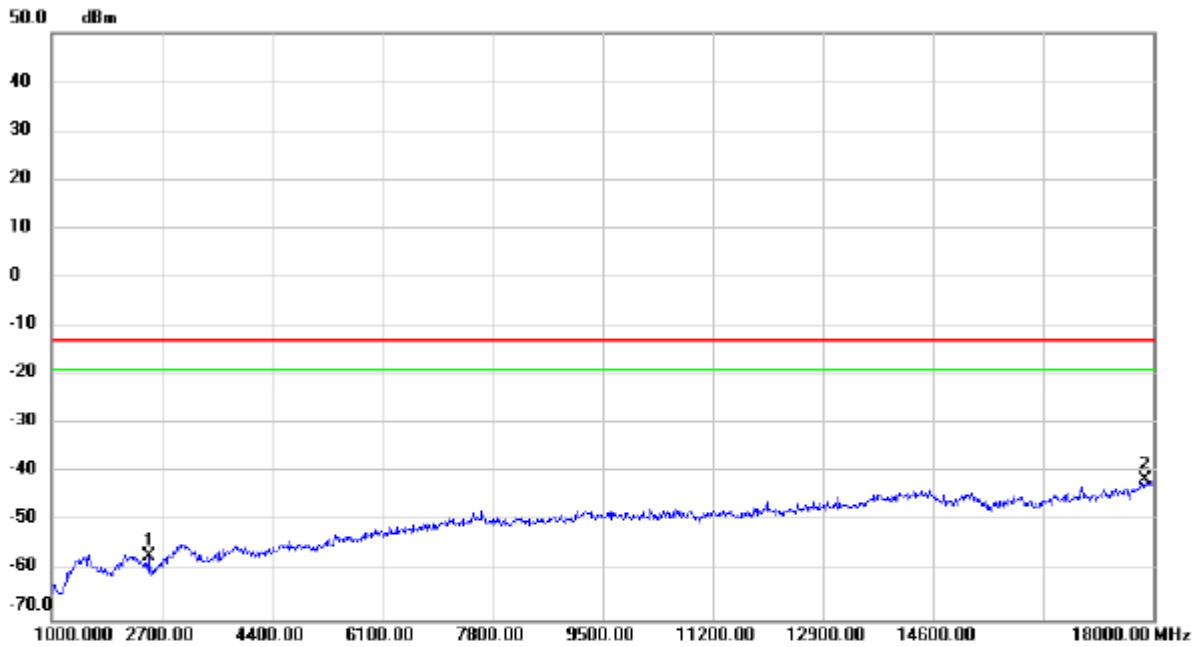

No.	Mk.	Freq. MHz	Reading Level dBm	Correct Factor dB	Measure- ment dBm	Limit dBm	Margin dB	Detector	Comment
1		2496.000	-53.62	-3.39	-57.01	-13.00	-44.01	peak	
2	*	17864.000	-60.32	18.97	-41.35	-13.00	-28.35	peak	

Test Mode: LTE Band 5_TX CH20525_10M_Main Antenna

Horizontal

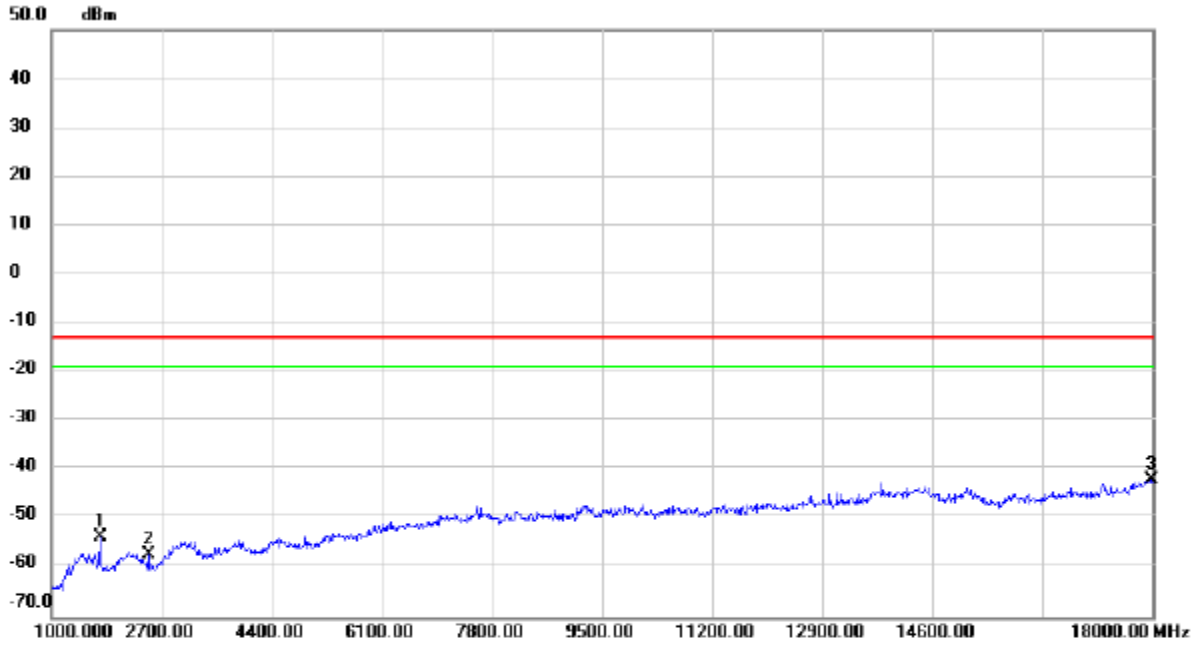

No.	Mk.	Freq. MHz	Reading Level dBm	Correct Factor dB	Measure- ment dBm	Limit dBm	Margin dB	Detector	Comment
1		1756.500	-49.62	-4.15	-53.77	-13.00	-40.77	peak	
2		2496.000	-53.98	-3.39	-57.37	-13.00	-44.37	peak	
3	*	17991.500	-61.26	19.34	-41.92	-13.00	-28.92	peak	

Test Mode: GSM850_TX CH190_GSM_with Earphone_DIV Antenna

Vertical

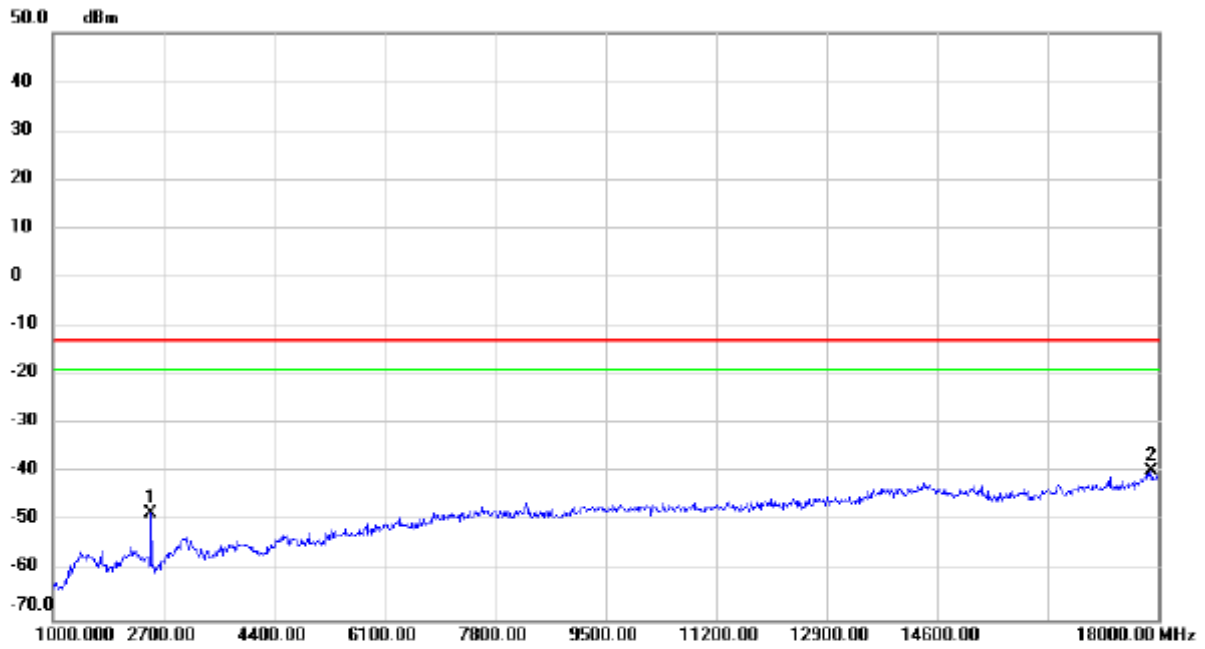

No.	Mk.	Freq. MHz	Reading Level dBm	Correct Factor dB	Measure- ment dBm	Limit dBm	Margin dB	Detector	Comment
1		2513.000	-44.97	-3.31	-48.28	-13.00	-35.28	peak	
2	*	17898.000	-58.56	19.07	-39.49	-13.00	-26.49	peak	

Test Mode: GSM850_TX CH190_GSM_with Earphone_DIV Antenna

Horizontal

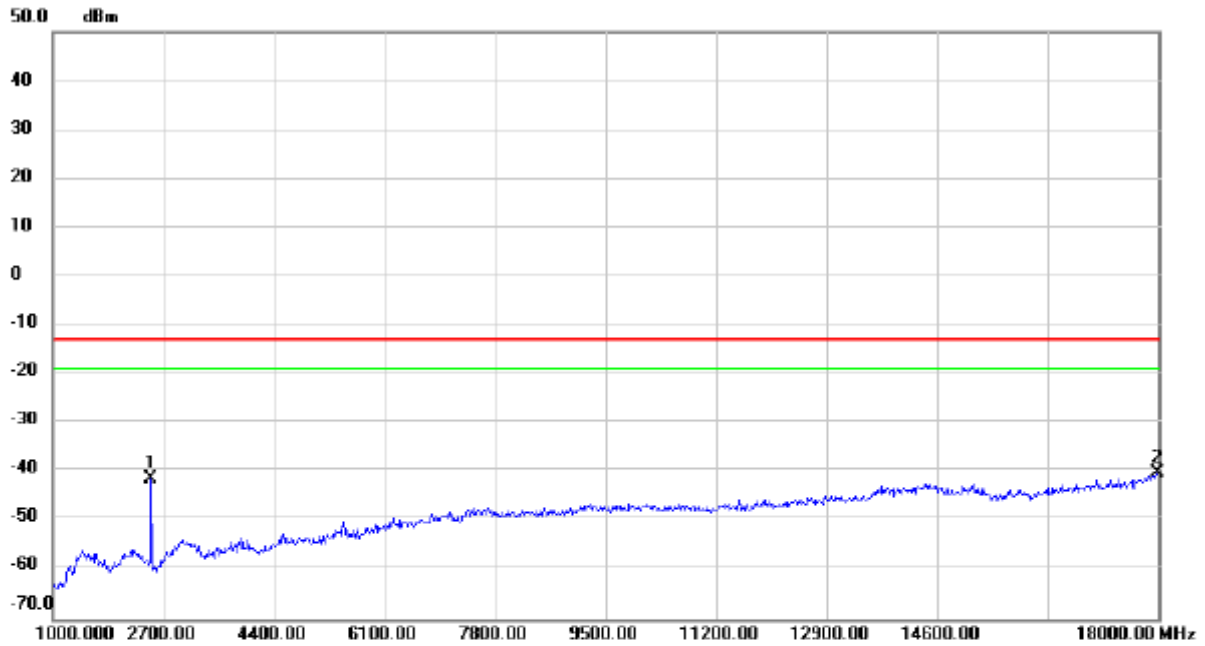

No.	Mk.	Freq. MHz	Reading Level dBm	Correct Factor dB	Measure- ment dBm	Limit dBm	Margin dB	Detector	Comment
1		2513.000	-37.99	-3.31	-41.30	-13.00	-28.30	peak	
2	*	17991.500	-59.62	19.34	-40.28	-13.00	-27.28	peak	

Test Mode: GSM850_ TX CH190_EDGE_with Earphone_DIV Antenna

Vertical

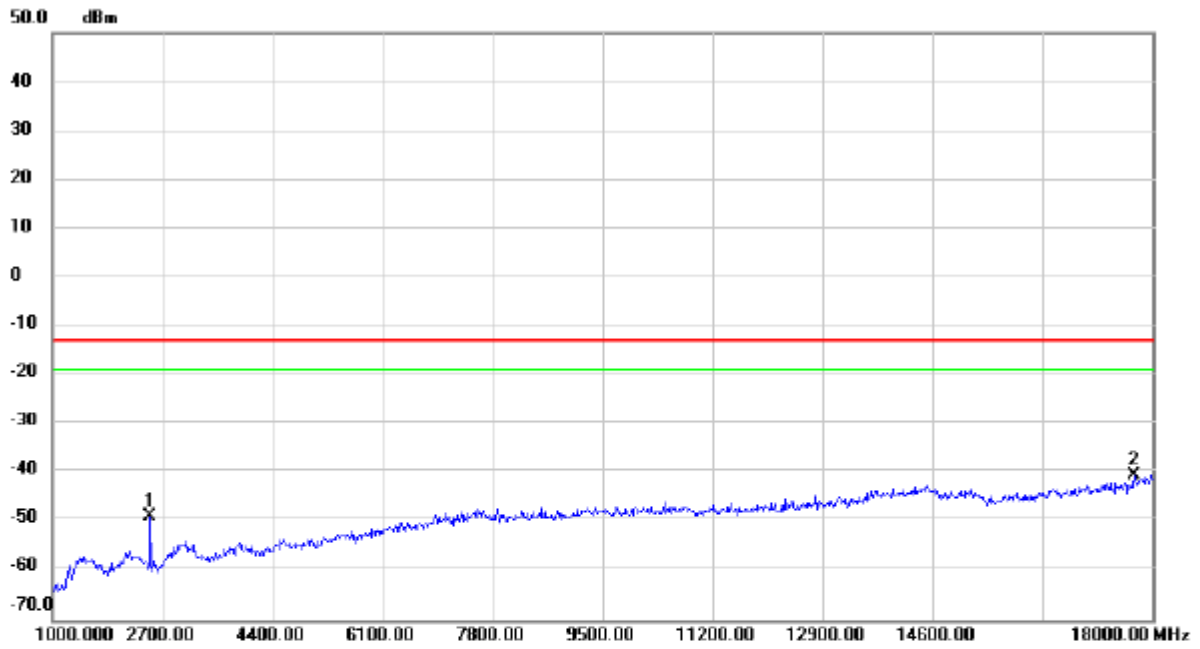

No.	Mk.	Freq. MHz	Reading Level dBm	Correct Factor dB	Measure- ment dBm	Limit dBm	Margin dB	Detector	Comment
1		2513.000	-45.64	-3.31	-48.95	-13.00	-35.95	peak	
2	*	17711.000	-58.91	18.50	-40.41	-13.00	-27.41	peak	

Test Mode: GSM850_TX CH190_EDGE_with Earphone_DIV Antenna

Horizontal

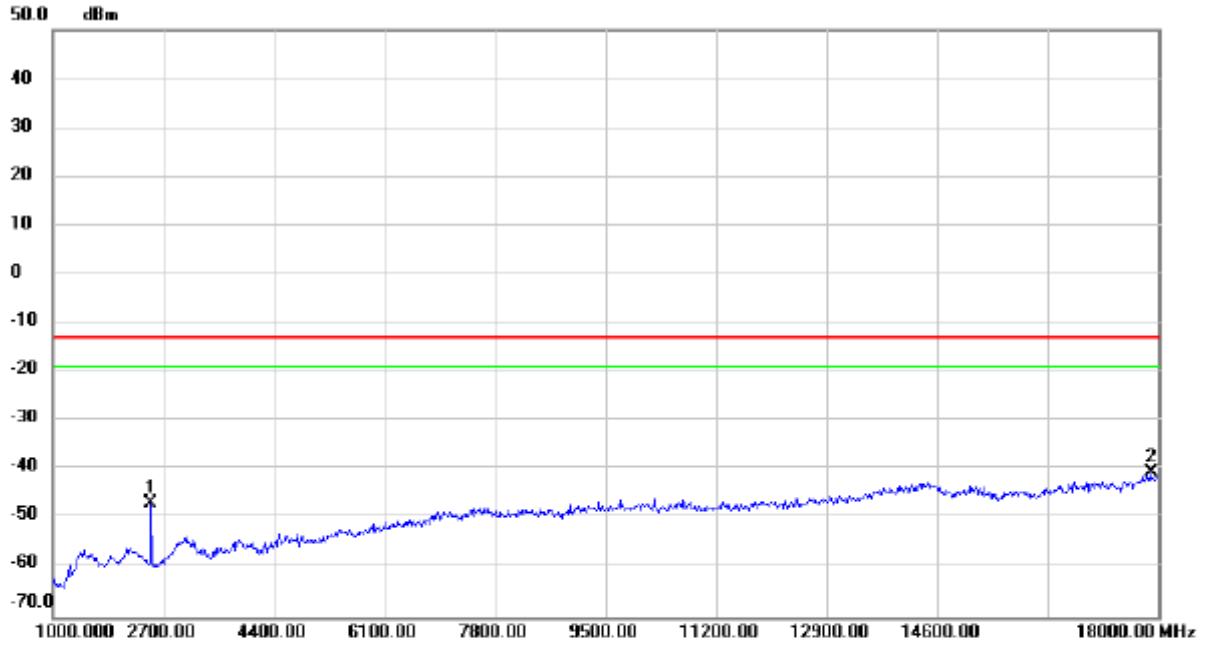

No.	Mk.	Freq. MHz	Reading Level dBm	Correct Factor dB	Measure- ment dBm	Limit dBm	Margin dB	Detector	Comment
1		2513.000	-43.44	-3.31	-46.75	-13.00	-33.75	peak	
2	*	17889.500	-59.63	19.04	-40.59	-13.00	-27.59	peak	

Test Mode: GSM850_TX CH190_GSM_without Earphone_DIV Antenna

Vertical

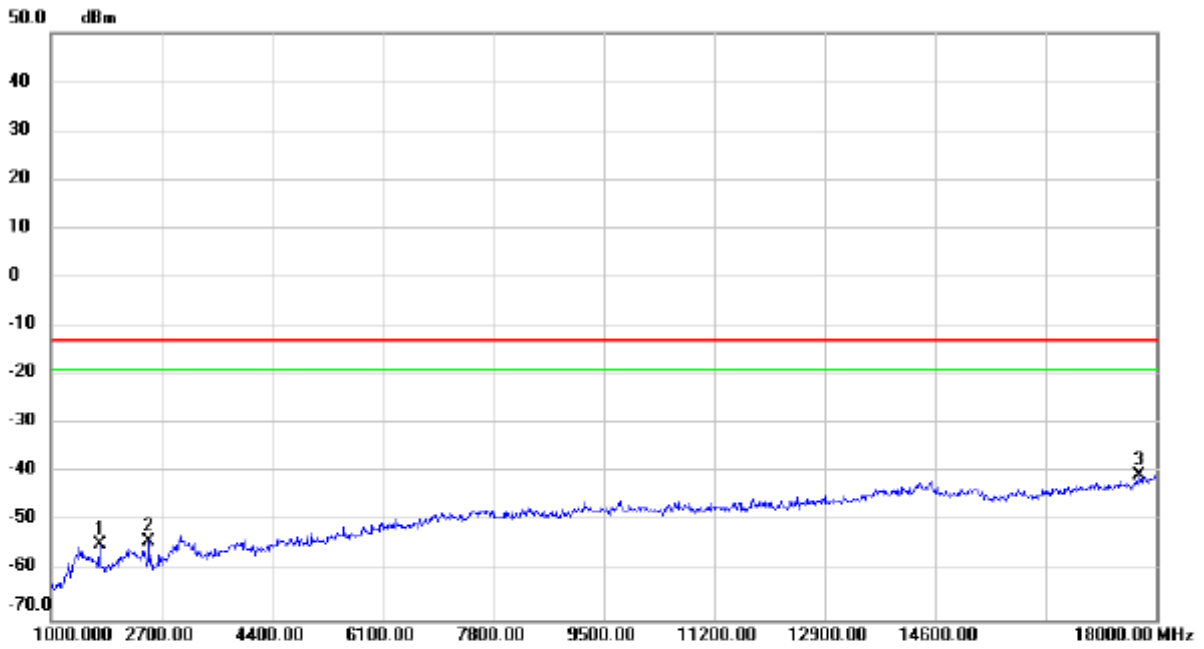

No.	Mk.	Freq. MHz	Reading Level dBm	Correct Factor dB	Measure- ment dBm	Limit dBm	Margin dB	Detector	Comment
1		1748.000	-50.45	-4.19	-54.64	-13.00	-41.64	peak	
2		2513.000	-50.54	-3.31	-53.85	-13.00	-40.85	peak	
3	*	17736.500	-59.14	18.58	-40.56	-13.00	-27.56	peak	

Test Mode: GSM850_ TX CH190_GSM_without Earphone_DIV Antenna

Horizontal

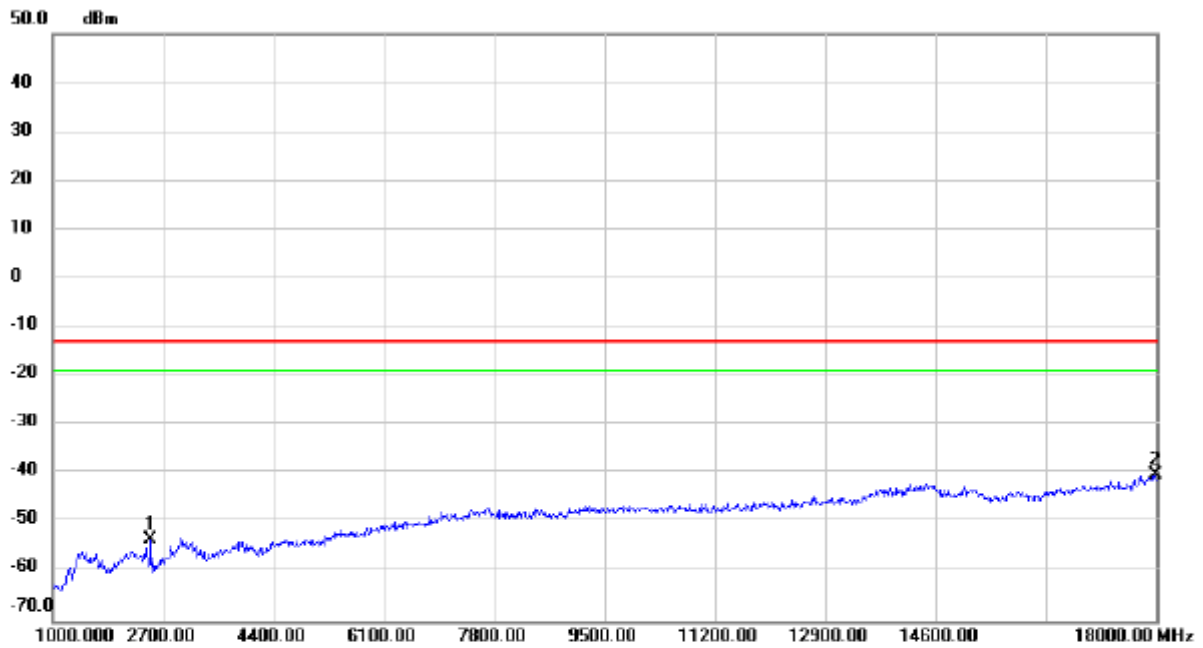

No.	Mk.	Freq. MHz	Reading Level dBm	Correct Factor dB	Measure- ment dBm	Limit dBm	Margin dB	Detector	Comment
1		2513.000	-49.93	-3.31	-53.24	-13.00	-40.24	peak	
2	*	17991.500	-59.61	19.34	-40.27	-13.00	-27.27	peak	

Test Mode: GSM850_TX CH190_EDGE_without Earphone_DIV Antenna

Vertical

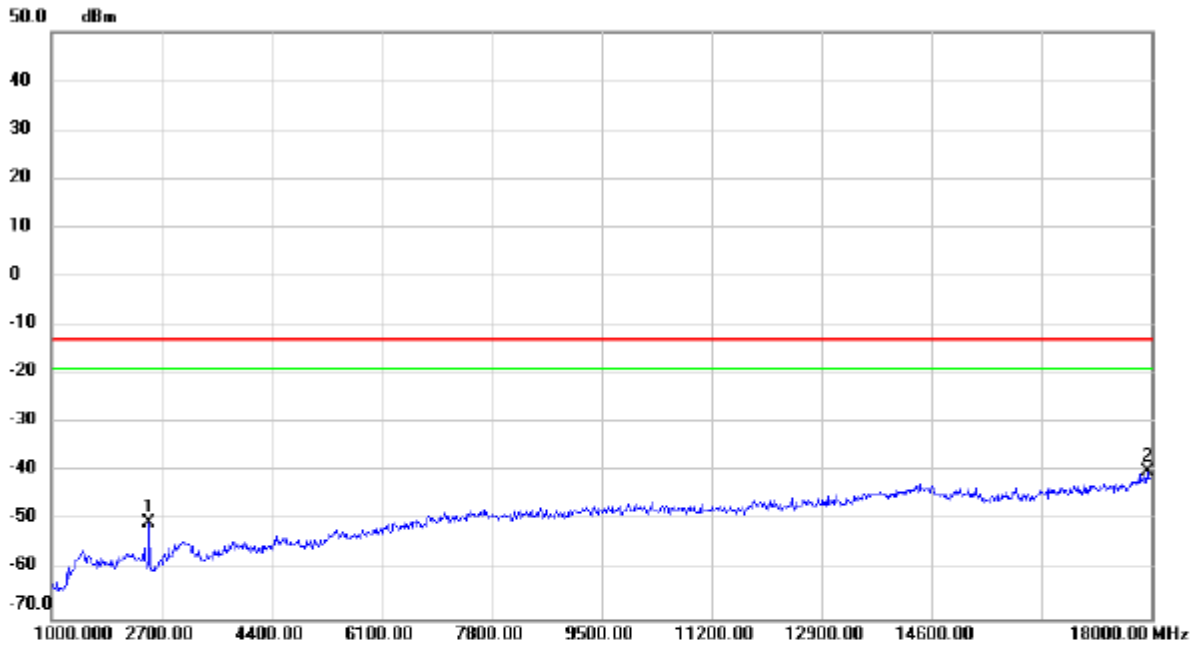

No.	Mk.	Freq. MHz	Reading Level dBm	Correct Factor dB	Measure- ment dBm	Limit dBm	Margin dB	Detector	Comment
1		2513.000	-46.98	-3.31	-50.29	-13.00	-37.29	peak	
2	*	17940.500	-59.03	19.19	-39.84	-13.00	-26.84	peak	

Test Mode: GSM850_TX CH190_EDGE_without Earphone_DIV Antenna

Horizontal

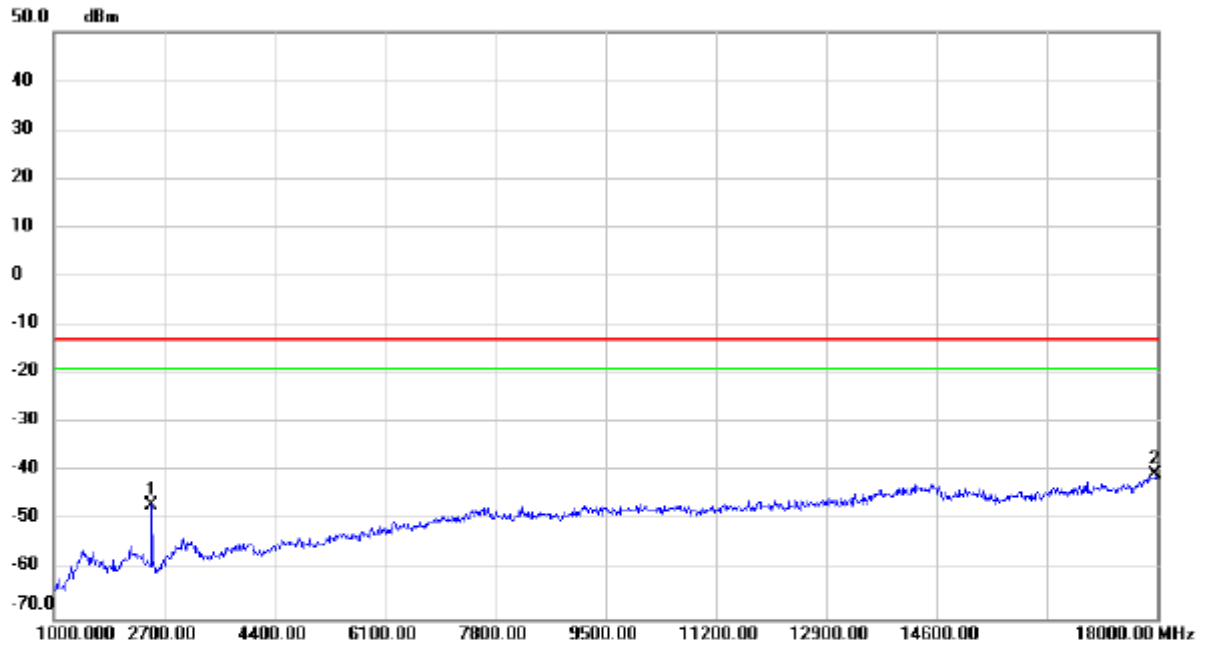

No.	Mk.	Freq. MHz	Reading Level dBm	Correct Factor dB	Measure- ment dBm	Limit dBm	Margin dB	Detector	Comment
1		2513.000	-43.29	-3.31	-46.60	-13.00	-33.60	peak	
2	*	17974.500	-59.62	19.29	-40.33	-13.00	-27.33	peak	

Test Mode: WCDMA Band V_TX CH4182_DIV Antenna

Vertical

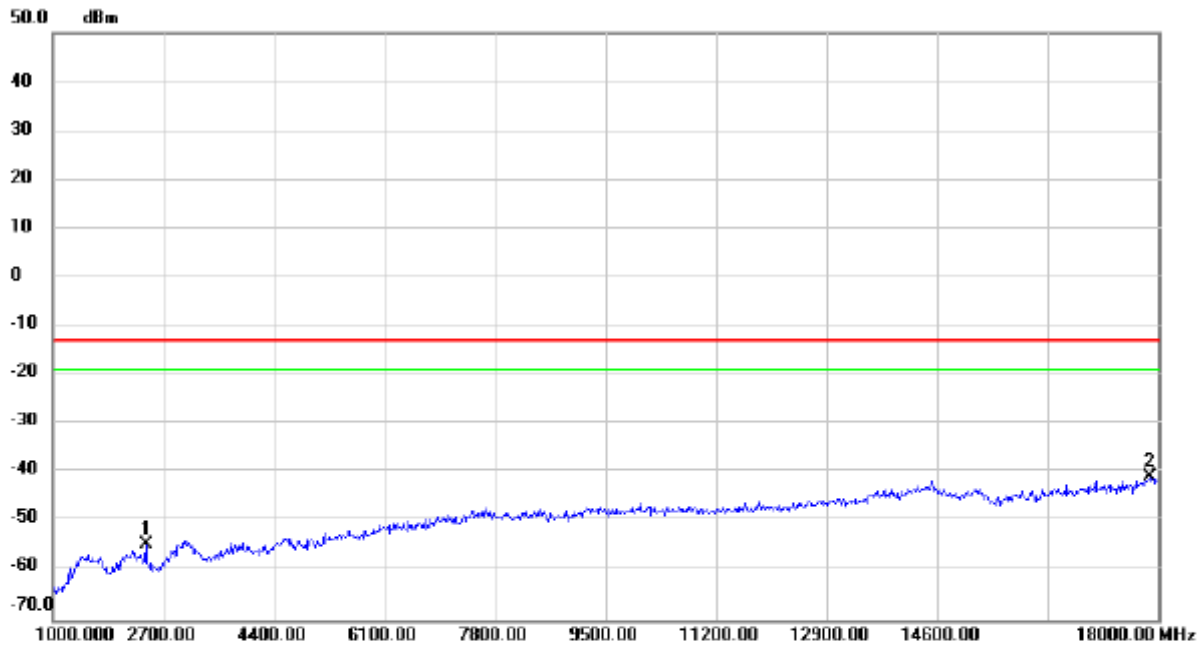

No.	Mk.	Freq. MHz	Reading Level dBm	Correct Factor dB	Measure- ment dBm	Limit dBm	Margin dB	Detector	Comment
1		2436.500	-51.17	-3.38	-54.55	-13.00	-41.55	peak	
2	*	17881.000	-59.67	19.02	-40.65	-13.00	-27.65	peak	

Test Mode: WCDMA Band V_TX CH4182_DIV Antenna

Horizontal

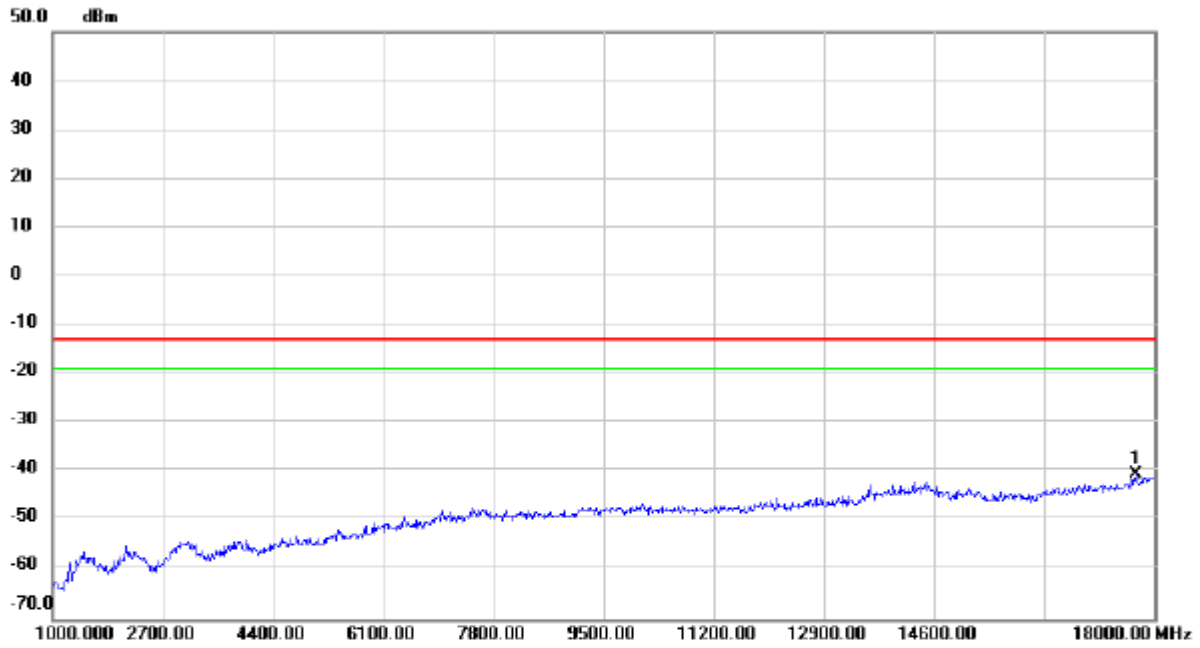

No.	Mk.	Freq. MHz	Reading Level dBm	Correct Factor dB	Measure- ment dBm	Limit dBm	Margin dB	Detector	Comment
1	*	17711.000	-58.89	18.50	-40.39	-13.00	-27.39	peak	

Test Mode: LTE Band 5_TX CH20525_1.4M_DIV Antenna

Vertical

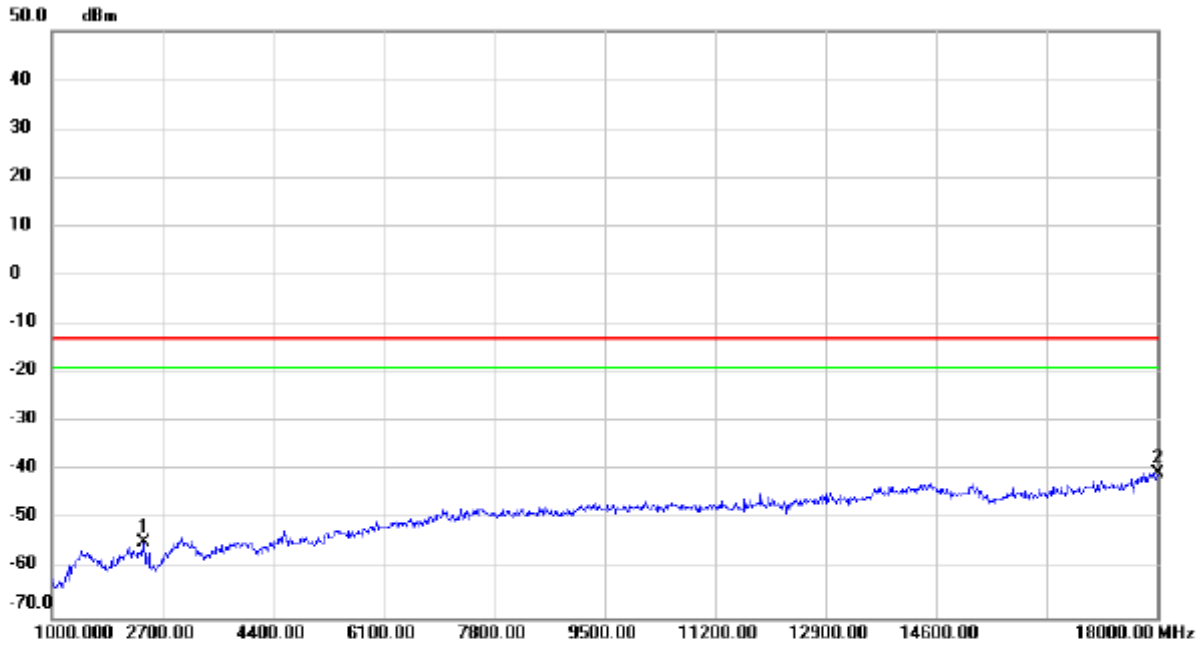

No.	Mk.	Freq. MHz	Reading Level dBm	Correct Factor dB	Measure- ment dBm	Limit dBm	Margin dB	Detector	Comment
1		2411.000	-51.05	-3.39	-54.44	-13.00	-41.44	peak	
2	*	18000.000	-59.82	19.37	-40.45	-13.00	-27.45	peak	

Test Mode: LTE Band 5_TX CH20525_1.4M_DIV Antenna

Horizontal

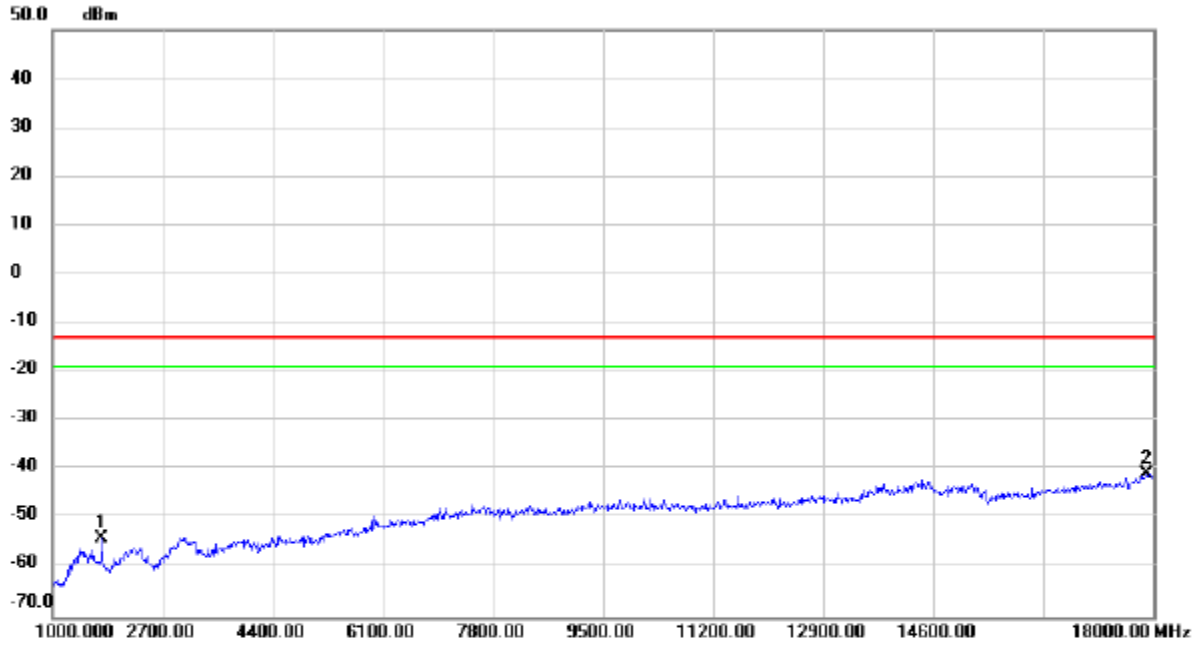

No.	Mk.	Freq. MHz	Reading Level dBm	Correct Factor dB	Measure- ment dBm	Limit dBm	Margin dB	Detector	Comment
1		1765.000	-49.81	-4.13	-53.94	-13.00	-40.94	peak	
2	*	17898.000	-59.77	19.07	-40.70	-13.00	-27.70	peak	

Test Mode: LTE Band 5_TX CH20525_5M_DIV Antenna

Vertical

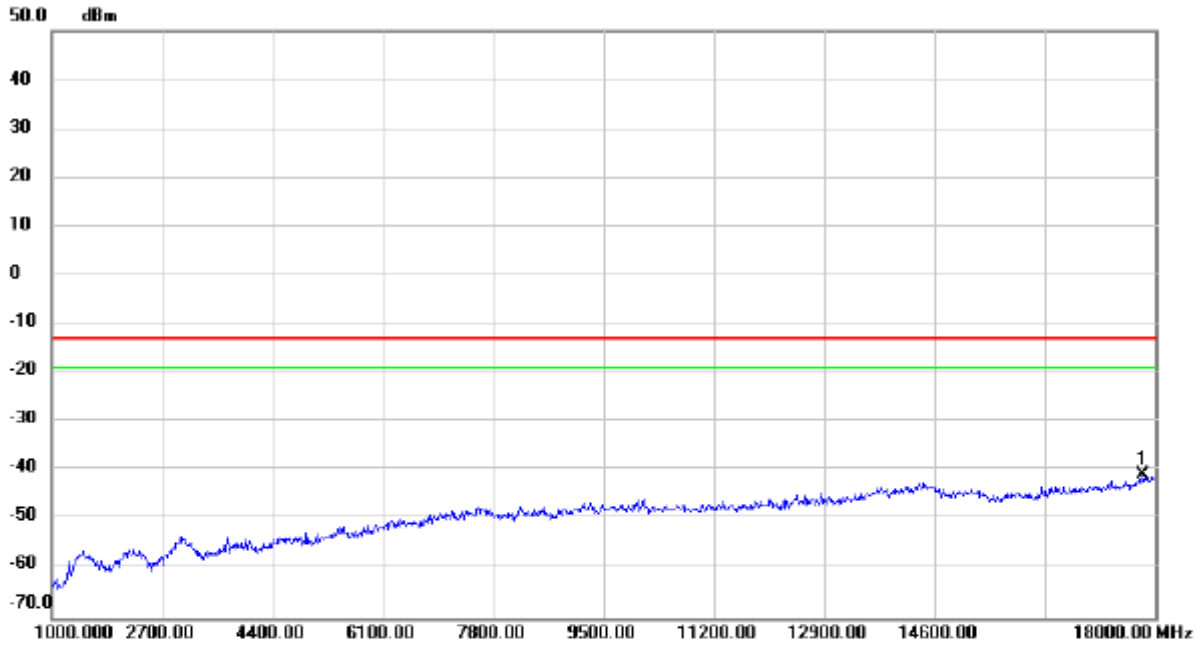

No.	Mk.	Freq. MHz	Reading Level dBm	Correct Factor dB	Measure- ment dBm	Limit dBm	Margin dB	Detector	Comment
1	*	17813.000	-59.69	18.81	-40.88	-13.00	-27.88	peak	

Test Mode: LTE Band 5_TX CH20525_5M_DIV Antenna

Horizontal

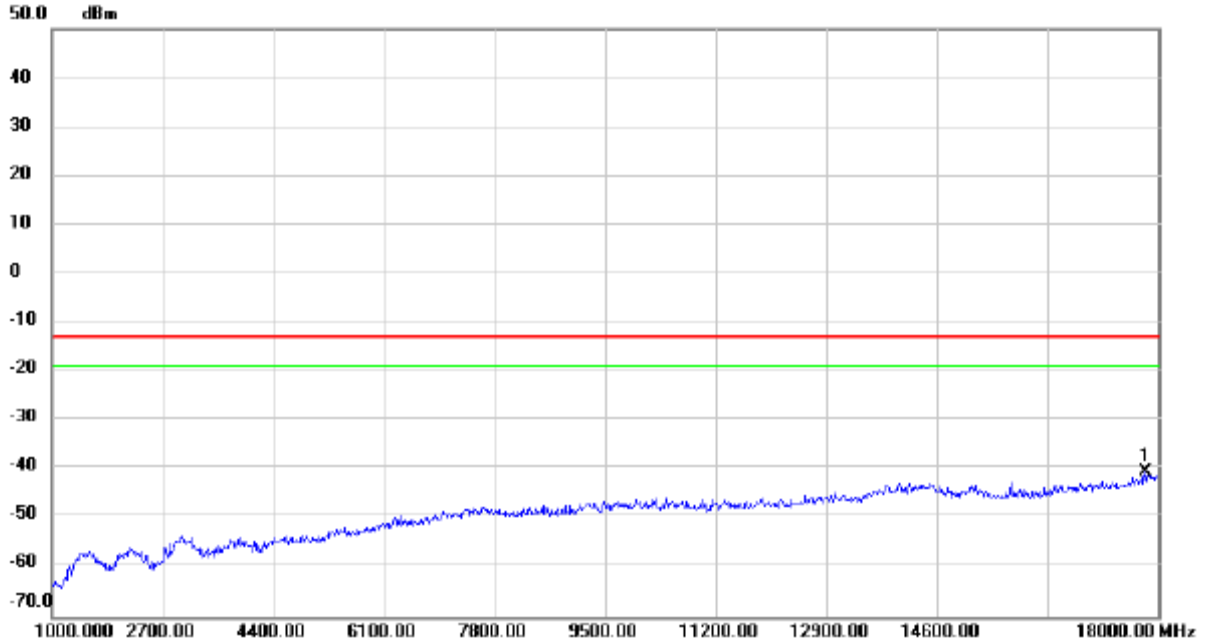

No.	Mk.	Freq. MHz	Reading Level dBm	Correct Factor dB	Measure- ment dBm	Limit dBm	Margin dB	Detector	Comment
1	*	17796.000	-59.31	18.76	-40.55	-13.00	-27.55	peak	

Test Mode: LTE Band 5_TX CH20525_10M_DIV Antenna

Vertical

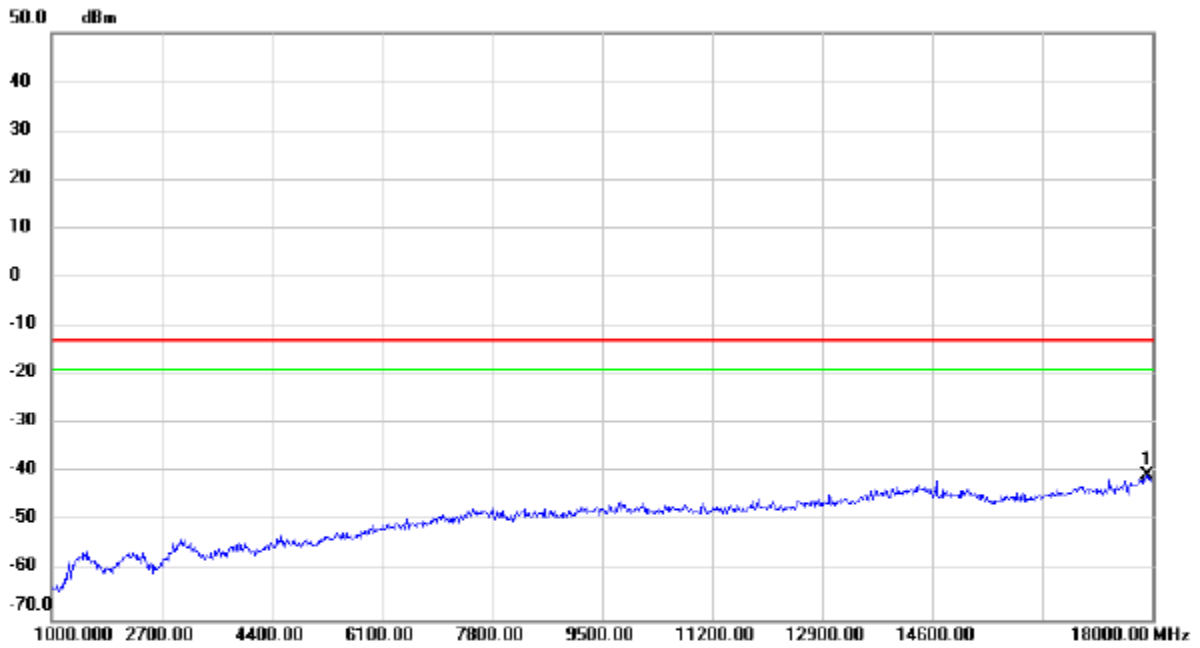

No.	Mk.	Freq. MHz	Reading Level dBm	Correct Factor dB	Measure- ment dBm	Limit dBm	Margin dB	Detector	Comment
1	*	17915.000	-59.66	19.11	-40.55	-13.00	-27.55	peak	

Test Mode: LTE Band 5_TX CH20525_10M_DIV Antenna

Horizontal

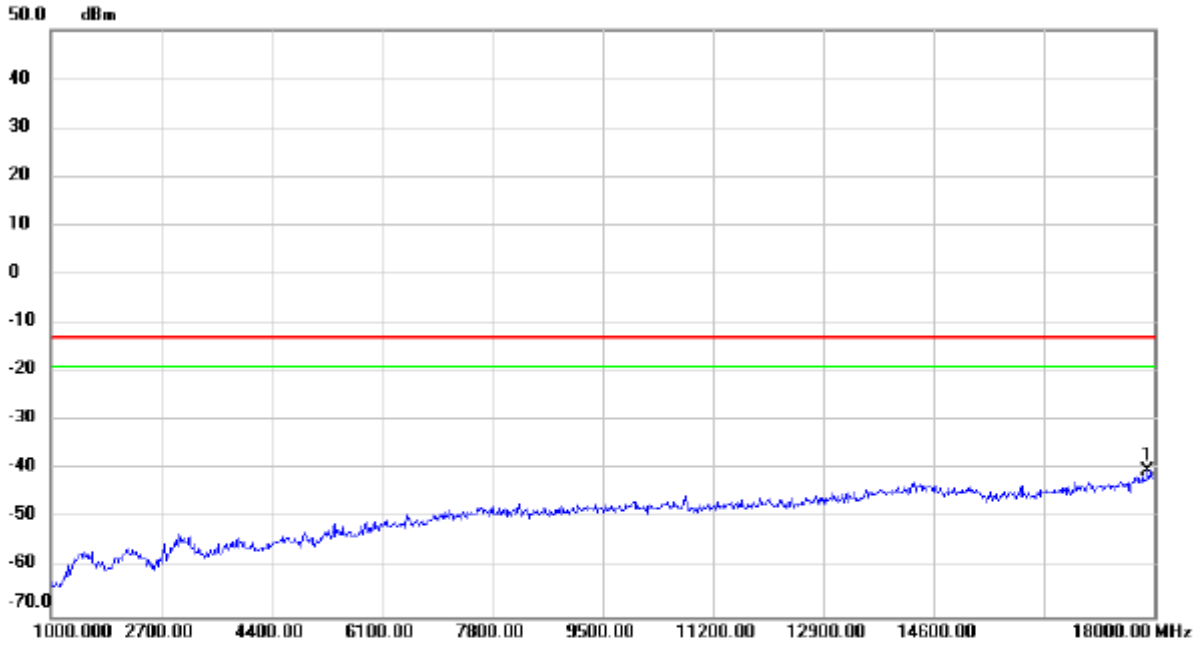

No.	Mk.	Freq. MHz	Reading Level dBm	Correct Factor dB	Measure- ment dBm	Limit dBm	Margin dB	Detector	Comment
1	*	17898.000	-59.12	19.07	-40.05	-13.00	-27.05	peak	

End of Test Report