



中国认可
国际互认
检测
TESTING
CNAS L0310



FCC RF Test Report

Product Name: Smart Phone

Model Number: HRY-LX2

Report No.: SYBH(Z-RF)20180907024002-2001

FCC ID: QISHRY-LX2

Reliability Laboratory of Huawei Technologies Co., Ltd.

(Global Compliance and Testing Center of Huawei Technologies Co., Ltd)

Administration Building, Headquarters of Huawei Technologies Co., Ltd., Bantian, Longgang District,
Shenzhen, 518129, P.R.C

Tel: +86 755 28780808

Fax: +86 755 89652518



Notice

1. The laboratory has passed the accreditation by China National Accreditation Service for Conformity Assessment (CNAS). The accreditation number is L0310.
2. The laboratory has passed the accreditation by The American Association for Laboratory Accreditation (A2LA). The accreditation number is 2174.01
3. The laboratory has been recognized by the US Federal Communications Commission (FCC) to perform compliance testing subject to the Commission's Certification rules. The Designation Number is CN1173, and the Test Firm Registration Number is 294140.
4. The laboratory has been listed by Industry Canada to perform electromagnetic emission measurements. The recognition numbers of test site are 6369A-1.
5. The laboratory (Reliability Lab of Huawei Technologies Co., Ltd) is also named "Global Compliance and Testing Center of Huawei Technologies Co., Ltd", the both names have coexisted since 2009.
6. The test report is invalid if not marked with the signatures of the persons responsible for preparing and approving the test report.
7. The test report is invalid if there is any evidence of erasure and/or falsification.
8. The test report is only valid for the test samples.
9. Content of the test report, in part or in full, cannot be used for publicity and/or promotional purposes without prior written approval from the laboratory.



Applicant: Huawei Technologies Co., Ltd.
Address: Administration Building, Headquarters of Huawei Technologies Co., Ltd.,
 Bantian, Longgang District, Shenzhen, 518129, P.R.C

Date of Receipt Sample: 2018-09-25
Start Date of Test: 2018-10-08
End Date of Test: 2018-11-20

Test Result: Pass

Approved by Senior Engineer:	2018-11-20	He Hao	<i>He Hao</i>
	Date	Name	Signature

Prepared by:	2018-11-20	zhoulingbo	<i>zhoulingbo</i>
	Date	Name	Signature



CONTENT

1 General Information.....5

1.1 Applied Standard.....5

1.2 Test Location5

1.3 Test Environment Condition.....5

2 Test Summary6

2.1 Cellular Band (824-849 MHz paired with 869-894 MHz)6

2.2 PCS Band (1850-1910 MHz paired with 1930-1990 MHz).....7

2.3 AWS Band (1710-1755 MHz paired with 2110-2155 MHz)8

2.4 BRS&EBS Band (2500-2570 MHz paired with 2620-2690 MHz)9

2.5 BRS&EBS Band38 (2570-2620 MHz paired with 2570-2620 MHz)10

2.6 Band41 (2545-2655 MHz paired with 2545-2655 MHz)11

3 Description of the Equipment under Test (EUT).....13

3.1 General Description13

3.2 EUT Identity13

3.3 Technical Specification14

4 General Test Conditions / Configurations17

4.1 Test Modes17

4.2 Test Environment.....17

4.3 Test Frequency.....18

4.4 DESCRIPTION OF TESTS25

4.5 Test Setups.....31

4.6 Test Conditions34

5 Main Test Instruments36

6 Measurement Uncertainty.....38

7 Appendixes.....39



1 General Information

1.1 Applied Standard

Applied Rules: 47 CFR FCC Part 02
 47 CFR FCC Part 22
 47 CFR FCC Part 24
 47 CFR FCC Part 27

Test Method: FCC KDB 971168 D01 Power Meas License Digital Systems v03r01
 ANSI C63.26

1.2 Test Location

Test Location : Reliability Laboratory of Huawei Technologies Co., Ltd.
Address1: No.2 New City Avenue Songshan Lake Sci. &Tech. Industry Park, Dongguan,
 Guangdong, P.R.C

1.3 Test Environment Condition

Ambient Temperature: 19.5 to 25 °C
Ambient Relative Humidity: 40 to 55 %
Atmospheric Pressure: Not applicable



2 Test Summary

2.1 Cellular Band (824-849 MHz paired with 869-894 MHz)

Test Item	FCC Rule No.	Requirements	Test Result	Verdict (Note1)	Test Address
Effective (Isotropic) Radiated Power Output Data	§2.1046, §22.913	FCC: ERP \leq 7 W.	Appendix A	Pass	Address 1
Peak-Average Ratio	---	Limit \leq 13 dB	Appendix B	Pass	Address 1
Modulation Characteristics	§2.1047	Digital modulation	Appendix C	Pass	Address 1
Bandwidth	§2.1049	OBW: No limit. EBW: No limit.	Appendix D	Pass	Address 1
Band Edges Compliance	§2.1051, §22.917	\leq -13 dBm/1%*EBW, in 1 MHz bands immediately outside and adjacent to the frequency block. Note 1): EBW is -26 dBc EBW.	Appendix E	Pass	Address 1
Spurious Emission at Antenna Terminals	§2.1051, §22.917	\leq -13 dBm/RefBW, from max(lowest internal frequency, 9 kHz) to min(10 * highest fundamental frequency, 40 GHz), after 1 MHz bands immediately outside and adjacent to the frequency block. (RefBW: \geq 100 kHz for frequency below 1 GHz, and =1 MHz above 1 GHz)	Appendix F	Pass	Address 1
Frequency Stability	§2.1055, §22.355	\leq \pm 2.5ppm	Appendix G	Pass	Address 1

**2.2 PCS Band (1850-1910 MHz paired with 1930-1990 MHz)**

Test Item	FCC Rule No.	Requirements	Test Result	Verdict (Note1)	Test Address
Effective (Isotropic) Radiated Power Output Data	§2.1046, §24.232	$EIRP \leq 2\text{ W}$	Appendix A	Pass	Address 1
Peak-Average Ratio	§2.1046, §24.232	Limit \leq 13 dB	Appendix B	Pass	Address 1
Modulation Characteristics	§2.1047	Digital modulation	Appendix C	Pass	Address 1
Bandwidth	§2.1049	OBW: No limit. EBW: No limit.	Appendix D	Pass	Address 1
Band Edges Compliance	§2.1051, §24.238	$\leq -13\text{ dBm}/1\%*EBW$, in 1 MHz bands immediately outside and adjacent to the frequency block. Note 1): EBW is -26 dBc EBW.	Appendix E	Pass	Address 1
Spurious Emission at Antenna Terminals	§2.1051, §24.238	$\leq -13\text{ dBm}/1\text{ MHz}$, from max(lowest internal frequency, 9 kHz) to min(10 * highest fundamental frequency, 40 GHz) but outside authorized operating frequency blocks.	Appendix F	Pass	Address 1
Frequency Stability	§2.1055, §24.235	Within authorized bands of operation/frequency block.	Appendix G	Pass	Address 1

**2.3 AWS Band (1710-1755 MHz paired with 2110-2155 MHz)**

Test Item	FCC Rule No.	Requirements	Test Result	Verdict (Note1)	Test Address
Effective (Isotropic) Radiated Power Output Data	§2.1046, §27.50(d)	$EIRP \leq 1\text{ W}$	Appendix A	Pass	Address 1
Peak-Average Ratio	§2.1046, §27.50(d)	Limit \leq 13 dB	Appendix B	Pass	Address 1
Modulation Characteristics	§2.1047	Digital modulation	Appendix C	Pass	Address 1
Bandwidth	§2.1049	OBW: No limit. EBW: No limit.	Appendix D	Pass	Address 1
Band Edges Compliance	§2.1051, §27.53(h)	$\leq -13\text{ dBm}/1\%*EBW$, in 1 MHz bands immediately outside and adjacent to the frequency block. Note 1): EBW is -26 dBc EBW.	Appendix E	Pass	Address 1
Spurious Emission at Antenna Terminals	§2.1051, §27.53(h)	$\leq -13\text{ dBm}/1\text{ MHz}$, from max(lowest internal frequency, 9 kHz) to min(10 * highest fundamental frequency, 40 GHz) but outside authorized operating frequency ranges.	Appendix F	Pass	Address 1
Frequency Stability	§2.1055, §27.54	Within authorized bands of operation/frequency block.	Appendix G	Pass	Address 1

2.4 BRS&EBS Band (2500-2570 MHz paired with 2620-2690 MHz)

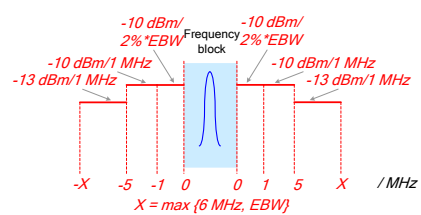
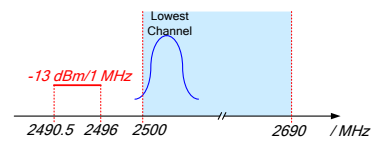
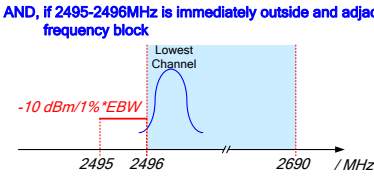
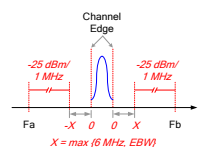
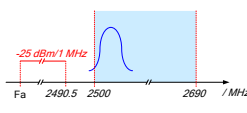
Test Item	FCC Rule No.	Requirements	Test Result	Verdict (Note1)	Test Address
Effective (Isotropic) Radiated Power Output Data	§2.1046, §27.50(h)	EIRP ≤ 2W	Appendix A	Pass	Address 1
Peak-Average Ratio	§27.50(a)	Limits ≤ 13 dB	Appendix B	Pass	Address 1
Modulation Characteristics	§2.1047	Digital modulation	Appendix C	Pass	Address 1
Bandwidth	§2.1049	OBW: No limit. EBW: No limit.	Appendix D	Pass	Address 1
Band Edges Compliance	§2.1051, §27.53(m4)	 <p>Frequency block</p> <p>AND</p>  <p>Lowest Channel</p> <p>AND, if 2495-2496MHz is immediately outside and adjacent to the frequency block</p>  <p>Lowest Channel</p> <p>Note 1): EBW is -26 dBc EBW.</p>	Appendix E	Pass	Address 1
Spurious Emission at Antenna Terminals	§2.1051, §27.53(m)	 <p>Channel Edge</p> <p>AND</p>  <p>Lowest Channel</p> <p>Fa = max(lowest internal frequency, 9 kHz) Fb = min(10 * highest fundamental frequency, 40 GHz)</p> <p>Note 1): EBW is -26 dBc EBW.</p>	Appendix F	Pass	Address 1



Test Item	FCC Rule No.	Requirements	Test Result	Verdict (Note1)	Test Address
		Note 2): MeasFrom: max(lowest internal frequency, 9 kHz). Note 3): MeasTo: min(10 * highest fundamental frequency, 40 GHz).			
Frequency Stability	§2.1055, §27.54	Within authorized bands of operation/frequency block.	Appendix G	Pass	Address 1

2.5 BRS&EBS Band38 (2570-2620 MHz paired with 2570-2620 MHz)

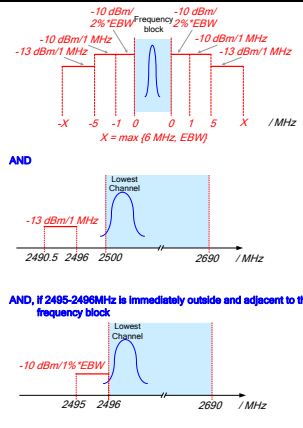
Test Item	FCC Rule No.	Requirements	Test Result	Verdict (Note1)	Test Address
Effective (Isotropic) Radiated Power Output Data	§2.1046, §27.50(h)	EIRP ≤ 2W	Appendix A	Pass	Address 1
Peak-Average Ratio	§27.50(a)	Limits ≤ 13 dB	Appendix B	Pass	Address 1
Modulation Characteristics	§2.1047	Digital modulation	Appendix C	Pass	Address 1
Bandwidth	§2.1049	OBW: No limit. EBW: No limit.	Appendix D	Pass	Address 1
Band Edges Compliance	§2.1051, §27.53(m4)	 <p>Note 1): EBW is -26 dBc EBW.</p>	Appendix E	Pass	Address 1

Test Item	FCC Rule No.	Requirements	Test Result	Verdict (Note1)	Test Address
Spurious Emission at Antenna Terminals	§2.1051, §27.53(m)	<p>Note 1): EBW is -26 dBc EBW. Note 2): MeasFrom: max(lowest internal frequency, 9 kHz). Note 3): MeasTo: min(10 * highest fundamental frequency, 40 GHz).</p>	Appendix F	Pass	Address 1
Frequency Stability	§2.1055, §27.54	Within authorized bands of operation/frequency block.	Appendix G	Pass	Address 1

2.6 Band41 (2545-2655 MHz paired with 2545-2655 MHz)

Test Item	FCC Rule No.	Requirements	Test Result	Verdict (Note1)	Test Address
Effective (Isotropic) Radiated Power Output Data	§2.1046, §27.50(h)	EIRP ≤ 2W	Appendix A	Pass	Address 1
Peak-Average Ratio	§27.50(a)	Limits ≤ 13 dB	Appendix B	Pass	Address 1
Modulation Characteristics	§2.1047	Digital modulation	Appendix C	Pass	Address 1
Bandwidth	§2.1049	OBW: No limit. EBW: No limit.	Appendix D	Pass	Address 1
Band Edges Compliance	§2.1051, §27.53(m4)		Appendix E	Pass	Address 1

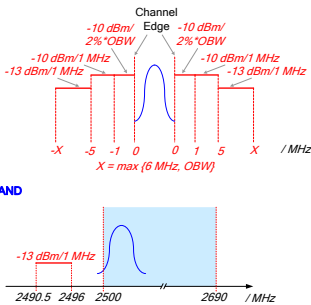
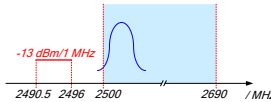
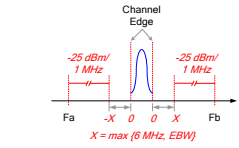
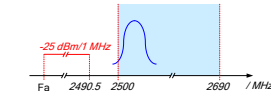
Test Item	FCC Rule No.	Requirements	Test Result	Verdict (Note1)	Test Address
		<p>Note 1): EBW is -26 dBc</p>  <p>AND</p> 			
Spurious Emission at Antenna Terminals	§2.1051, §27.53(m)	 <p>AND</p>  <p>Fa = max(lowest internal frequency, 9 kHz) Fb = min(10 * highest fundamental frequency, 40 GHz)</p> <p>Note 1): EBW is -26 dBc EBW. Note 2): MeasFrom: max(lowest internal frequency, 9 kHz). Note 3): MeasTo: min(10 * highest fundamental frequency, 40 GHz).</p>	Appendix F	Pass	Address 1
Frequency Stability	§2.1055, §27.54	Within authorized bands of operation/frequency block.	Appendix G	Pass	Address 1



3 Description of the Equipment under Test (EUT)

3.1 General Description

HRY-LX2 is subscriber equipment in the GSM/WCDMA/LTE system. The GSM frequency bands include GSM850, GSM900, DCS1800 and PCS1900. The UMTS frequency band includes band I, band II, band IV, band V and band VIII. The LTE frequency bands include band 1, band 2, band 3, band 4, band 5, band 7, band 8, band 28, band 38, band 40 and band 41. The Mobile Phone implements such functions as RF signal receiving/transmitting, LTE/HSPA/UMTS and GSM/GPRS/EDGE protocol processing, voice, video MMS service, GPS, AGPS and WIFI etc. Externally it provides one micro SD card interface, earphone port (to provide voice service) and one and two SIM card interface. HRY-LX2 is dual and single SIM smart phone. It also provides Bluetooth module to synchronize data between a PC and the phone, or to use the built-in modem of the phone to access the Internet with a PC, or to exchange data with other Bluetooth devices.

NOTE1:Only GSM850/1900,UMTS Band II/IV/V,LTE Band 2/4/5/7/38//41 test data included in this report.



3.2 EUT Identity

NOTE: Unless otherwise noted in the report, the functional boards installed in the units shall be selected from the below list, but not means all the functional boards listed below shall be installed in one unit.

3.2.1 Board

Board		
Description	Software version	Hardware version
Main Board	9.0.1.111(C900E110R1P9)	HL1HRYM

3.2.2 Sub-Assembly

Sub-Assembly			
Sub-Assembly Name	Model	Manufacturer	Description
Adapter	HW-050200U02	Huawei Technologies Co.,Ltd.	Input Voltage:100V-240V~50/60Hz, 0.5A Output Voltage: 5V  2A
Adapter	HW-050200U01	Huawei Technologies Co.,Ltd.	nput Voltage:100V-240V~50/60Hz, 0.5A Output Voltage: 5V  2A
Rechargeable Li-ion	HB396286ECW	Huawei Technologies Co.,Ltd.	Rated capacity: 3320mAh Nominal Voltage: +3.82V Charging Voltage: +4.4V



3.3 Technical Specification

Characteristics	Description	
Radio System Type	<input checked="" type="checkbox"/> GSM <input checked="" type="checkbox"/> UMTS <input checked="" type="checkbox"/> LTE	
Supported Frequency Range	GSM850/ WCDMA850	Transmission (TX): 824 to 849 MHz
		Receiving (RX): 869 to 894 MHz
	GSM1900/ WCDMA1900	Transmission (TX): 1850 to 1910 MHz
		Receiving (RX): 1930 to 1990 MHz
	WCDMA1700	Transmission (TX): 1710 to 1755 MHz
		Receiving (RX): 2110 to 2155 MHz
	LTE BAND2	Transmission (TX): 1850 to 1910 MHz
		Receiving (RX): 1930 to 1990 MHz
	LTE BAND4	Transmission (TX): 1710 to 1755 MHz
		Receiving (RX): 2110 to 2155 MHz
	LTE BAND5	Transmission (TX): 824 to 849 MHz
		Receiving (RX): 869 to 894 MHz
	LTE BAND7	Transmission (TX): 2500 to 2570 MHz
		Receiving (RX): 2620 to 2690 MHz
LTE BAND38	Transmission (TX): 2750 to 2620 MHz	
	Receiving (RX): 2570 to 2620 MHz	
LTE BAND41	Transmission (TX): 2455 to 2655MHz	
	Receiving (RX): 2455 to 2655 MHz	
TX and RX Antenna Ports (one band)	TX & RX port:	1
	TX-only port:	0
	RX-only port:	1
Target TX Output Power	GSM850: 32.5dBm GSM1900 24.5dBm UMTS850 24dBm UMTS1900: 23.5dBm UMTS1700 23.5dBm LTE BAND2: 23dBm LTE BAND4: 23dBm LTE BAND5: 23.5dBm LTE BAND7: 22.5dBm LTE BAND38: 23.1dBm LTE BAND41: 23.1dBm	
Supported Channel Bandwidth	GSM system:	<input checked="" type="checkbox"/> 200 kHz
	UMTS system:	<input checked="" type="checkbox"/> 5 MHz
	LTE band 2	<input checked="" type="checkbox"/> 1.4MHz, <input checked="" type="checkbox"/> 3MHz, <input checked="" type="checkbox"/> 5MHz, <input checked="" type="checkbox"/> 10MHz , <input checked="" type="checkbox"/> 15MHz ,



Characteristics	Description	
		<input checked="" type="checkbox"/> 20MHz
	LTE band 4	<input checked="" type="checkbox"/> 1.4MHz, <input checked="" type="checkbox"/> 3MHz, <input checked="" type="checkbox"/> 5MHz, <input checked="" type="checkbox"/> 10MHz, <input checked="" type="checkbox"/> 15MHz, <input checked="" type="checkbox"/> 20MHz
	LTE band 5	<input checked="" type="checkbox"/> 1.4MHz, <input checked="" type="checkbox"/> 3MHz, <input checked="" type="checkbox"/> 5MHz, <input checked="" type="checkbox"/> 10MHz
	LTE band 7	<input checked="" type="checkbox"/> 5MHz, <input checked="" type="checkbox"/> 10MHz, <input checked="" type="checkbox"/> 15MHz, <input checked="" type="checkbox"/> 20MHz
	LTE band 38	<input checked="" type="checkbox"/> 5MHz, <input checked="" type="checkbox"/> 10MHz, <input checked="" type="checkbox"/> 15MHz, <input checked="" type="checkbox"/> 20MHz
	LTE band 41	<input checked="" type="checkbox"/> 5MHz, <input checked="" type="checkbox"/> 10MHz, <input checked="" type="checkbox"/> 15MHz, <input checked="" type="checkbox"/> 20MHz
Designation of Emissions (Note: the necessary bandwidth of which is the worst value from the measured occupied bandwidths for each type of channel bandwidth configuration.)	GSM850:	247KGXW, 251KG7W
	GSM1900:	251KGXW, 254KG7W
	UMTS850:	4M18F9W
	UMTS1900:	4M18F9W
	UMTS1700:	4M18F9W
	LTE BAND2:	1M10G7D (1.4 MHz QPSK modulation), 1M10W7D (1.4 MHz 16QAM modulation) 2M71G7D (3 MHz QPSK modulation), 2M72W7D (3 MHz 16QAM modulation) 4M53G7D (5 MHz QPSK modulation), 4M52W7D (5 MHz 16QAM modulation) 9M01G7D (10 MHz QPSK modulation), 9M03W7D (10 MHz 16QAM modulation) 13M5G7D (15 MHz QPSK modulation), 13M5W7D (15 MHz 16QAM modulation) 18M0G7D (20 MHz QPSK modulation), 18M0W7D (20 MHz 16QAM modulation)
	LTE BAND4:	1M10G7D (1.4 MHz QPSK modulation), 1M10W7D (1.4 MHz 16QAM modulation) 2M71G7D (3 MHz QPSK modulation), 2M72W7D (3 MHz 16QAM modulation) 4M53G7D (5 MHz QPSK modulation), 4M53W7D (5 MHz 16QAM modulation) 9M02G7D (10 MHz QPSK modulation), 9M02W7D (10 MHz 16QAM modulation) 13M5G7D (15 MHz QPSK modulation), 13M5W7D (15 MHz 16QAM modulation) 18M0G7D (20 MHz QPSK modulation), 18M0W7D (20 MHz 16QAM modulation)
LTE BAND5:	1M10G7D (1.4 MHz QPSK modulation), 1M10W7D (1.4 MHz 16QAM modulation) 2M71G7D (3 MHz QPSK modulation), 2M72W7D (3 MHz 16QAM modulation) 4M52G7D (5 MHz QPSK modulation), 4M52W7D (5 MHz 16QAM modulation)	



Characteristics	Description
	9M03G7D (10 MHz QPSK modulation), 9M02W7D (10 MHz 16QAM modulation)
LTE BAND7:	4M52G7D (5 MHz QPSK modulation), 4M53W7D (5 MHz 16QAM modulation) 9M030G7D (10 MHz QPSK modulation), 9M01W7D (10 MHz 16QAM modulation) 13M5G7D (15 MHz QPSK modulation), 13M5W7D (15 MHz 16QAM modulation) 18M0G7D (20 MHz QPSK modulation), 18M0W7D (20 MHz 16QAM modulation)
LTE BAND38:	4M52G7D (5 MHz QPSK modulation), 4M54W7D (5 MHz 16QAM modulation) 9M04G7D (10 MHz QPSK modulation), 9M00W7D (10 MHz 16QAM modulation) 13M5G7D (15 MHz QPSK modulation), 13M5W7D (15 MHz 16QAM modulation) 18M0G7D (20 MHz QPSK modulation), 18M0W7D (20 MHz 16QAM modulation)
LTE BAND41:	4M52G7D (5 MHz QPSK modulation), 4M53W7D (5 MHz 16QAM modulation) 9M00G7D (10 MHz QPSK modulation), 9M04W7D (10 MHz 16QAM modulation) 13M6G7D (15 MHz QPSK modulation), 13M5W7D (15 MHz 16QAM modulation) 18M0G7D (20 MHz QPSK modulation), 18M0W7D (20 MHz 16QAM modulation)



4 General Test Conditions / Configurations

4.1 Test Modes

NOTE: The test mode(s) are selected according to relevant radio technology specifications.

Test Mode	Test Modes Description
GSM/TM1	GSM system, GSM/GPRS, GMSK modulation
GSM/TM2	GSM system, EDGE, 8PSK modulation
UMTS/TM1	WCDMA system, QPSK modulation
UMTS/TM2	HSDPA system, QPSK modulation
UMTS/TM3	HSUPA system, QPSK modulation
LTE/TM1	LTE system, QPSK modulation
LTE/TM2	LTE system, 16QAM modulation

4.2 Test Environment

Environment Parameter	Selected Values During Tests	
Relative Humidity	Ambient	
Temperature	TN	Ambient
Voltage	VL	3.6V
	VN	3.82V
	VH	4.4V

NOTE: VL= lower extreme test voltage
VN= nominal voltage
VH= upper extreme test voltage
TN= normal temperature



4.3 Test Frequency

Test Mode	TX / RX	RF Channel		
		Low (L)	Middle (M)	High (H)
GSM850	TX	Channel 128	Channel 190	Channel 251
		824.2MHz	836.6MHz	848.8MHz
	RX	Channel 128	Channel 190	Channel 251
		869.2MHz	881.6MHz	893.8MHz
WCDMA850	TX	Channel 4132	Channel 4182	Channel 4233
		826.4MHz	836.4MHz	846.6MHz
	RX	Channel 4357	Channel 4407	Channel 4458
		871.4MHz	881.4MHz	891.6MHz
Test Mode	TX / RX	RF Channel		
		Low (L)	Middle (M)	High (H)
GSM1900	TX	Channel 512	Channel 661	Channel 810
		1850.2MHz	1880.0MHz	1909.8MHz
	RX	Channel 512	Channel 661	Channel 810
		1930.2 MHz	1960.0 MHz	1989.8 MHz
WCDMA1900	TX	Channel 9262	Channel9400	Channel9538
		1852.4MHz	1880.0MHz	1907.6MHz
	RX	Channel 9662	Channel 9800	Channel 9938
		1932.4 MHz	1960.0 MHz	1987.6 MHz
Test Mode	TX / RX	RF Channel		
		Low (L)	Middle (M)	High (H)
WCDMA1700	TX	Channel1312	Channel1413	Channel1513
		1712.4MHz	1732.6MHz	1752.6MHz



Test Mode	TX / RX	RF Channel		
		Low (L)	Middle (M)	High (H)
	RX	Channel 1537	Channel 1638	Channel 1738
		2112.4 MHz	2132.6 MHz	2152.6 MHz

Test Mode	TX / RX	RF Channel		
		Low (B)	Middle (M)	High (T)
LTE Band 2	TX(1.4M)	Channel 18607	Channel 18900	Channel 19193
		1850.7 MHz	1880 MHz	1909.3 MHz
	TX(3M)	Channel 18615	Channel 18900	Channel 19185
		1851.5 MHz	1880 MHz	1908.5 MHz
	TX(5M)	Channel 18625	Channel 18900	Channel 19175
		1852.5 MHz	1880 MHz	1907.5 MHz
	TX(10M)	Channel 18650	Channel 18900	Channel 19150
		1855 MHz	1880 MHz	1905 MHz
	TX(15M)	Channel 18675	Channel 18900	Channel 19125
		1857.5 MHz	1880 MHz	1902.5 MHz
	TX(20M)	Channel 18700	Channel 18900	Channel 19100
		1860 MHz	1880 MHz	1900 MHz
	RX(1.4M)	Channel 607	Channel 900	Channel 1193
		1930.7 MHz	1960 MHz	1989.3 MHz
	RX(3M)	Channel 615	Channel 900	Channel 1185
		1931.5 MHz	1960 MHz	1988.5 MHz
	RX(5M)	Channel 625	Channel 900	Channel 1175
		1932.5 MHz	1960 MHz	1987.5 MHz



Test Mode	TX / RX	RF Channel		
		Low (B)	Middle (M)	High (T)
	RX(10M)	Channel 650	Channel 900	Channel 1150
		1935 MHz	1960 MHz	1985 MHz
	RX(15M)	Channel 675	Channel 900	Channel 1125
		1937.5 MHz	1960 MHz	1982.5 MHz
	RX(20M)	Channel 700	Channel 900	Channel 1100
		1940 MHz	1960 MHz	1980 MHz

Test Mode	TX / RX	RF Channel		
		Low (B)	Middle (M)	High (T)
LTE Band 4	TX(1.4M)	Channel 19957	Channel 20175	Channel 20393
		1710.7 MHz	1732.5 MHz	1754.3 MHz
	TX(3M)	Channel 19965	Channel 20175	Channel 20385
		1711.5 MHz	1732.5 MHz	1753.5 MHz
	TX(5M)	Channel 19975	Channel 20175	Channel 20375
		1712.5 MHz	1732.5 MHz	1752.5 MHz
	TX(10M)	Channel 20000	Channel 20175	Channel 20350
		1715 MHz	1732.5 MHz	1750 MHz
	TX(15M)	Channel 20025	Channel 20175	Channel 20325
		1717.5 MHz	1732.5 MHz	1747.5 MHz
	TX(20M)	Channel 20050	Channel 20175	Channel 20300
		1720 MHz	1732.5 MHz	1745 MHz
	RX(1.4M)	Channel 1975	Channel 2175	Channel 2375
		2112.5 MHz	2132.5MHz	2152.5 MHz



Test Mode	TX / RX	RF Channel		
		Low (B)	Middle (M)	High (T)
	RX(3M)	Channel 2000	Channel 2175	Channel 2350
		2115 MHz	2132.5MHz	2150 MHz
	RX(5M)	Channel 1975	Channel 2175	Channel 2375
		2112.5 MHz	2132.5MHz	2152.5 MHz
	RX(10M)	Channel 2000	Channel 2175	Channel 2350
		2115 MHz	2132.5MHz	2150 MHz
	RX(15M)	Channel 2025	Channel 2175	Channel 2325
		2117.5 MHz	2132.5MHz	2147.5 MHz
	RX(20M)	Channel 2050	Channel 2175	Channel 2300
		2120 MHz	2132.5MHz	2145 MHz

Test Mode	TX / RX	RF Channel		
		Low (B)	Middle (M)	High (T)
LTE Band 5	TX(1.4M)	Channel 20407	Channel 20525	Channel 20643
		824.7 MHz	836.5 MHz	848.3 MHz
	TX(3M)	Channel 20415	Channel 20525	Channel 20635
		825.5 MHz	836.5 MHz	847.5 MHz
	TX(5M)	Channel 20425	Channel 20525	Channel 20625
		826.5 MHz	836.5 MHz	846.5 MHz
	TX(10M)	Channel 20450	Channel 20525	Channel 20600
		829 MHz	836.5 MHz	844 MHz
	RX(1.4M)	Channel 2407	Channel 2525	Channel 2643
		869.7 MHz	881.5 MHz	893.3 MHz
	RX (3M)	Channel 2415	Channel 2525	Channel 2635



Test Mode	TX / RX	RF Channel		
		Low (B)	Middle (M)	High (T)
		870.5 MHz	881.5 MHz	892.5 MHz
		Channel 2425	Channel 2525	Channel 2625
	RX(5M)	871.5 MHz	881.5 MHz	891.5 MHz
		Channel 2450	Channel 2525	Channel 2600
	RX (10M)	874 MHz	881.5 MHz	889 MHz

Test Mode	TX / RX	RF Channel		
		Low (B)	Middle (M)	High (T)
LTE Band 7	TX (5M)	Channel 20775	Channel 21100	Channel 21425
		2502.5 MHz	2535 MHz	2567.5 MHz
	TX (10M)	Channel 20800	Channel 21100	Channel 21400
		2505 MHz	2535 MHz	2565 MHz
	TX (15M)	Channel 20825	Channel 21100	Channel 21375
		2507.5 MHz	2535 MHz	2562.5 MHz
	TX (20M)	Channel 20850	Channel 21100	Channel 21350
		2510 MHz	2535 MHz	2560 MHz
	RX (5M)	Channel 2775	Channel 3100	Channel 3425
		2622.5 MHz	2655 MHz	2687.5 MHz
	RX (10M)	Channel 2800	Channel 3100	Channel 3400
		2625 MHz	2655 MHz	2685 MHz
	RX (15M)	Channel 2825	Channel 3100	Channel 3375
		2627.5 MHz	2655 MHz	2682.5 MHz
	RX (20M)	Channel 2850	Channel 3100	Channel 3350



Test Mode	TX / RX	RF Channel		
		Low (B)	Middle (M)	High (T)
		2630 MHz	2655 MHz	2680 MHz

Test Mode	TX / RX	RF Channel		
		Low (B)	Middle (M)	High (T)
LTE Band 38	TX(5M)	Channel 37775	Channel 38000	Channel 38225
		2572.5 MHz	2595 MHz	2617.5 MHz
	TX(10M)	Channel 37800	Channel 38000	Channel 38200
		2575 MHz	2595 MHz	2615 MHz
	TX(15M)	Channel 37825	Channel 38000	Channel 38175
		2577.5 MHz	2595 MHz	2612.5 MHz
	TX(20M)	Channel 37850	Channel 38000	Channel 38150
		2580 MHz	2595 MHz	2610 MHz
	RX(5M)	Channel 37775	Channel 38000	Channel 38225
		2572.5 MHz	2595 MHz	2617.5 MHz
	RX(10M)	Channel 37800	Channel 38000	Channel 38200
		2575 MHz	2595 MHz	2615 MHz
	RX(15M)	Channel 37825	Channel 38000	Channel 38175
		2577.5 MHz	2595 MHz	2612.5 MHz
	RX(20M)	Channel 37850	Channel 38000	Channel 38150
		2580 MHz	2595 MHz	2610 MHz



Test Mode	TX / RX	RF Channel		
		Low (B)	Middle (M)	High (T)
LTE Band 41(2545-2655)	TX(5M)	Channel 40165	Channel 40690	Channel 41215
		2547.5 MHz	2600 MHz	2652.5 MHz
	TX(10M)	Channel 40190	Channel 40690	Channel 41190
		2550 MHz	2600 MHz	2650 MHz
	TX(15M)	Channel 40215	Channel 40690	Channel 41165
		2552.5 MHz	2600 MHz	2647.5 MHz
	TX(20M)	Channel 40240	Channel 40690	Channel 41140
		2555 MHz	2600 MHz	2645 MHz
	RX(5M)	Channel 40165	Channel 40690	Channel 41215
		2547.5 MHz	2600 MHz	2652.5 MHz
	RX(10M)	Channel 40190	Channel 40690	Channel 41190
		2550 MHz	2600 MHz	2650 MHz
	RX(15M)	Channel 40215	Channel 40690	Channel 41165
		2552.5 MHz	2600 MHz	2647.5 MHz
	RX(20M)	Channel 40240	Channel 40690	Channel 41140
		2555 MHz	2600 MHz	2645 MHz



4.4 DESCRIPTION OF TESTS

4.4.1 Radiated Power and Radiated Spurious Emissions

Radiated spurious emissions are investigated indoors in a full-anechoic chamber to determine the frequencies producing the worst case emissions. Final measurements for radiated power and radiated spurious emissions are performed on the 3 meter OATS per the guidelines of ANSI/TIA-603-E-2016. The equipment under test was transmitting while connected to its integral antenna and is placed on a wooden turntable 150cm above the ground plane and 3 meters from the receive antenna. The spectrum is scanned from the lowest frequency generated in the equipment up to a frequency including its 10th harmonic. The receive antenna height is adjusted between 1 and 4 meter height, the turntable is rotated through 360 degrees, and the EUT is manipulated through all orthogonal planes representative of its typical use to achieve the highest reading on the receive spectrum analyzer. Emissions are also investigated with the receive antenna horizontally and vertically polarized.

A portable or small unlicensed wireless device shall be placed on a non-metallic test fixture or other non-metallic support during testing. The supporting fixture shall permit orientation of the EUT in each of three orthogonal (x, y, z) axis positions such that emissions from the EUT are maximized. Measure the EUT maximum RF power and record the result.

A half-wave dipole is then substituted in place of the EUT. For emissions above 3GHz, a horn antenna is substituted in place of the EUT. The substitute antenna is driven by a signal generator with the level of the signal generator being adjusted to obtain the same receive spectrum analyzer level previously recorded from the spurious emission from the EUT.

The power of the emission is calculated using the following formula:

$$P_d [\text{dBm}] = P_g [\text{dBm}] - \text{cable loss} [\text{dB}] + \text{antenna gain} [\text{dBd/dBi}]$$

Where, P_d is the dipole equivalent power, P_g is the generator output into the substitution antenna, and the antenna gain is the gain of the substitute antenna used relative to either a half-wave dipole (dBd) or an isotropic source (dBi). The substitute level is equal to $P_g [\text{dBm}] - \text{cable loss} [\text{dB}]$.

The calculated P_d levels are then compared to the absolute spurious emission limit of -13dBm which is equivalent to the required minimum attenuation of $43 + 10\log_{10}(\text{Power} [\text{Watts}])$.

Test Procedures Used

KDB 971168 D01-Section 5.2.2 / KDB 971168 D01-Section 5.8

ANSI/TIA-603-E-2016-Section 2.2.17 / ANSI/TIA-603-E-2016-Section 2.2.12

Note: Reference test setup 3



4.4.2 Peak-Average Ratio

A peak to average ratio measurement is performed at the conducted port of the EUT. The spectrum analyzers Complementary Cumulative Distribution Function (CCDF) measurement profile is used to determine the largest deviation between the average and the peak power of the EUT in a given bandwidth.

Test Procedures Used

KDB 971168 D01-Section 5.7.2

Test Settings

- 1、 The signal analyzer's CCDF measurement profile enabled
- 2、 Frequency= carrier center frequency
- 3、 Measurement BW > EBW of signal
- 4、 for continuous transmissions, set to 1ms
- 5、 Record the maximum PAPR level associated with a probability of 0.1%.

Note: Reference test setup 1



4.4.3 Occupied Bandwidth

The occupied bandwidth, that is the frequency bandwidth such that, below its lower and above its upper frequency limits, the mean powers radiated are each equal to 0.5 percent of the total mean power radiated by a given emission shall be measured. The span of the analyzer shall be set to capture all products of the modulation process, including the emission skirts. The resolution bandwidth shall be set to as close to 1 percent of the selected span as is possible without being below 1 percent. The video bandwidth shall be set to 3 times the resolution bandwidth. Video averaging is not permitted. Where practical, a sampling detector shall be used since a peak or, peak hold, may produce a wider bandwidth than actual. The trace data points are recovered and are directly summed in linear terms. The recovered amplitude data points, beginning at the lowest frequency, are placed in a running sum until 0.5 percent of the total is reached and that frequency recorded. The process is repeated for the highest frequency data points. This frequency is recorded. The span between the two recorded frequencies is the occupied bandwidth.

Test Procedures Used

KDB 971168 D01-Section 4.3

Test Settings

- 1、 SET RBW=1-5% of OBW
- 2、 SET VBW \geq 3*RBW
- 3、 Detector: Peak
- 4、 Trace mode= max hold.
- 5、 Sweep= auto couple
- 6、 Steps 1-5 were repeated after it is stable

Note: Reference test setup 1.



4.4.4 Band Edge Compliance

The test complies with the requirements in clause 2 of the present report according to test procedures in KDB 971168 D01 -Section 6 with corresponding test settings.

Note: Reference test setup 1.



4.4.5 Spurious and Harmonic Emissions at Antenna Terminal

The test complies with the requirements in clause 2 of the present report according to test procedures in KDB 971168 D01-Section 6 with corresponding test settings.

Note: Reference test setup 1.



4.4.6 Frequency Stability / Temperature Variation

Frequency stability testing is performed in accordance with the guidelines of ANSI/TIA-603-E-2016. The frequency stability of the transmitter is measured by:

- a.) **Temperature:** The temperature is varied from -30°C to +50°C in 10°C increments using an environmental chamber.
- b.) **Primary Supply Voltage:** The primary supply voltage is varied from 85% to 115% of the nominal value for non hand-carried battery and AC powered equipment. For hand-carried, battery-powered equipment, primary supply voltage is reduced to the battery operating end point which shall be specified by the manufacturer.

Specification – The frequency stability shall be sufficient to ensure that the fundamental emission stays within the authorized frequency block. The frequency stability of the transmitter shall be maintained within $\pm 0.00025\%$ (± 2.5 ppm) of the center frequency.

Time Period and Procedure:

1. The carrier frequency of the transmitter is measured at room temperature (20°C to provide a reference).
2. The equipment is turned on in a “standby” condition for fifteen minutes before applying power to the transmitter. Measurement of the carrier frequency of the transmitter is made within one minute after applying power to the transmitter.
3. Frequency measurements are made at 10°C intervals ranging from -30°C to +50°C. A period of at least one half-hour is provided to allow stabilization of the equipment at each temperature level.

Test Procedures Used

ANSI/TIA-603-E-2016

Note: Reference test setup 2.

4.5 Test Setups

4.5.1 Test Setup 1

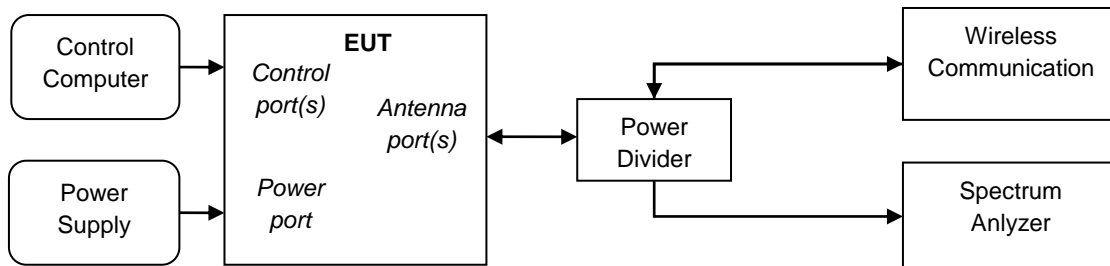

4.5.2 Test Setup 2

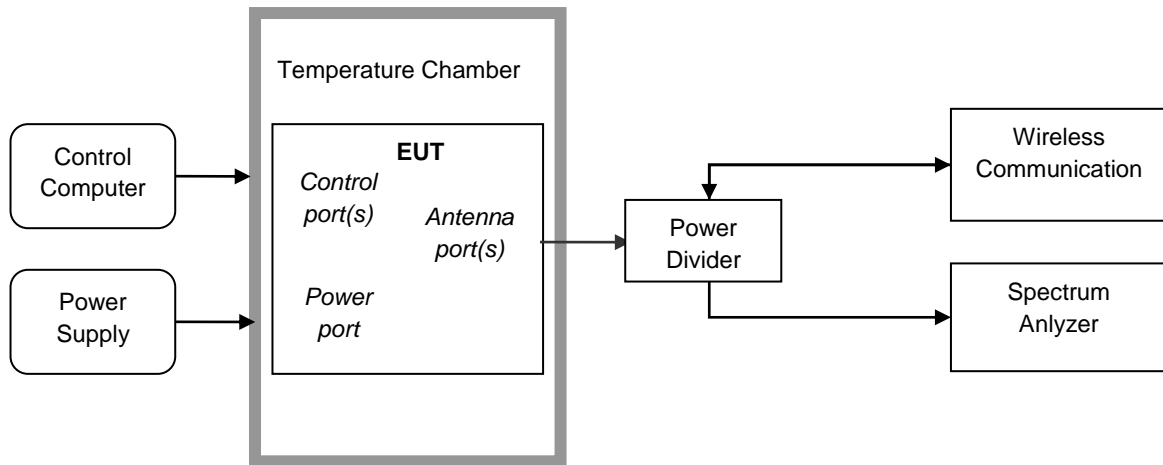

4.5.3 Test Setup 3

NOTE: Effective radiated power (ERP) and Equivalent Isotropic Radiated Power(EIRP) refers to the radiation power output of the EUT, assuming all emissions are radiated from half-wave dipole antennas.

4.5.3.1 Step 1: Pre-test

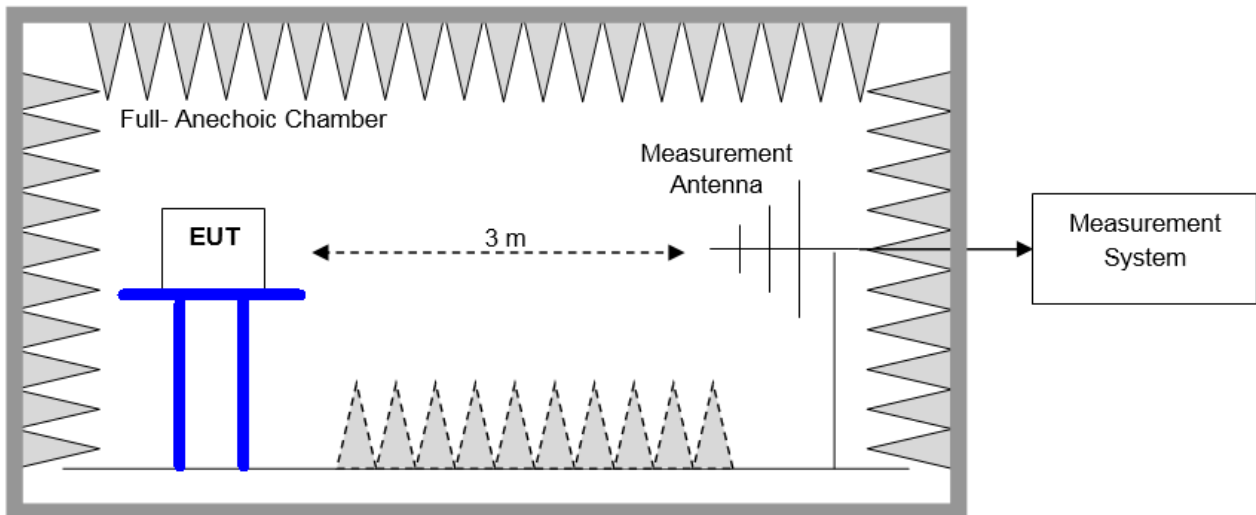

4.5.3.2 Step 2: Substitution method to verify the maximum ERP/EIRP

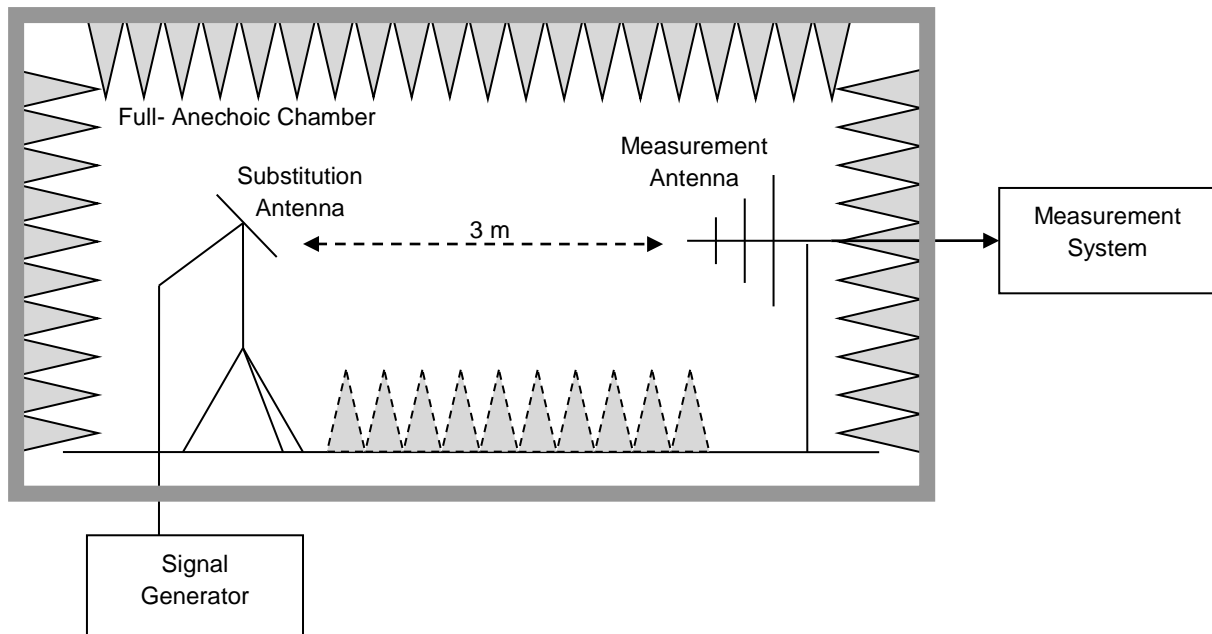

4.6 Test Conditions

Test Case		Test Conditions	
Transmit Output Power Data	Average Power, Total	Test Env.	Ambient Climate & Rated Voltage
		Test Setup	Test Setup 1
		RF Channels (TX)	L, M, H (L= low channel, M= middle channel, H= high channel)
		Test Mode	GSM/TM1,GSM/TM2,UMTS/TM1,LTE/TM1,LTE/TM2
	Average Power, Spectral Density (if required)	Test Env.	Ambient Climate & Rated Voltage
		Test Setup	Test Setup 1
		RF Channels (TX)	L, M, H (L= low channel, M= middle channel, H= high channel)
		Test Mode	GSM/TM1,GSM/TM2,UMTS/TM1,LTE/TM1,LTE/TM2
Peak-to-Average Ratio (if required)		Test Env.	Ambient Climate & Rated Voltage
		Test Setup	Test Setup 1
		RF Channels (TX)	L, M, H (L= low channel, M= middle channel, H= high channel)
		Test Mode	GSM/TM1,GSM/TM2,UMTS/TM1,LTE/TM1,LTE/TM2
Modulation Characteristics		Test Env.	Ambient Climate & Rated Voltage
		Test Setup	Test Setup 1
		RF Channels (TX)	M (L= low channel, M= middle channel, H= high channel)
		Test Mode	GSM/TM1,GSM/TM2,UMTS/TM1,LTE/TM1,LTE/TM2
Bandwidth	Occupied Bandwidth	Test Env.	Ambient Climate & Rated Voltage
		Test Setup	Test Setup 1
		RF Channels (TX)	L, M, H (L= low channel, M= middle channel, H= high channel)
		Test Mode	GSM/TM1,GSM/TM2,UMTS/TM1,LTE/TM1,LTE/TM2
	Emission Bandwidth (if required)	Test Env.	Ambient Climate & Rated Voltage
		Test Setup	Test Setup 1
		RF Channels (TX)	L, M, H (L= low channel, M= middle channel, H= high channel)
		Test Mode	GSM/TM1,GSM/TM2,UMTS/TM1,LTE/TM1,LTE/TM2
Band Edges Compliance		Test Env.	Ambient Climate & Rated Voltage
		Test Setup	Test Setup 1
		RF Channels (TX)	L, H (L= low channel, M= middle channel, H= high channel)
		Test Mode	GSM/TM1,GSM/TM2,UMTS/TM1,LTE/TM1,LTE/TM2
Spurious Emission at Antenna Terminals		Test Env.	Ambient Climate & Rated Voltage
		Test Setup	Test Setup 1
		RF Channels (TX)	L, M, H (L= low channel, M= middle channel, H= high channel)



Test Case	Test Conditions	
	Test Mode	GSM/TM1,GSM/TM2,UMTS/TM1,LTE/TM1,LTE/TM2
Frequency Stability	Test Env.	(1) -30 °C to +50 °C with step 10 °C at Rated Voltage; (2) VL, VN and VH of Rated Voltage at Ambient Climate.
	Test Setup	Test Setup 2
	RF Channels (TX)	L, M, H (L= low channel, M= middle channel, H= high channel)
	Test Mode	GSM/TM1,GSM/TM2,UMTS/TM1,LTE/TM1,LTE/TM2



5 Main Test Instruments

Conducted:

Main Test Equipments					
Equipment Name	Manufacturer	Model	Serial Number	Cal Date	Cal- Due
Power supply	KEITHLEY	2303	000381E	2018/05/21	2019/05/21
Universal Radio Communication Tester	R&S	CMU200	110932	2018/4/27	2019/4/27
Universal Radio Communication Tester	R & S	CMW500	159302	2018/7/23	2019/7/23
Signal Analyzer	R&S	FSQ31	200021	2018/7/23	2019/7/23
Spectrum Analyzer	Agilent	N9030A	MY49431698	2018/7/23	2019/7/23
Temperature Chamber	WEISS	WKL64	56246002940010	2017/12/13	2018/12/13
Signal generator	Agilent	E8257D	MY49281095	2018/7/23	2019/7/23
Vector Signal Generator	R&S	SMU200A	104162	2018/7/23	2019/7/23
Power Detecting & Samplig Unit	R&S	OSP-B157	101429	2018/7/23	2019/7/23
Spectrum Analyzer	Keysight	N9040B	MY57212529	2018/6/28	2019/6/28

Radiation:

Main Test Equipments					
Equipment Name	Manufacturer	Model	Serial Number	Cal Date	Cal- Due
Universal Radio Communication Tester	R&S	CMU200	117385	2018/05/08	2019/05/07
Universal Radio Communication Tester	R&S	MT8821C	6261760791	2018/04/02	2019/04/01
Test receiver	R&S	ESU26	100387	2018/1/20	2019/1/19
Test receiver	R&S	ESCI	101163	2018/1/20	2019/1/19
Test receiver	R&S	ESU26	100150	2018/1/20	2019/1/19
Spectrum analyzer	R&S	FSU3	200474	2018/1/20	2019/1/19
Spectrum analyzer	R&S	FSU43	100144	2018/1/20	2019/1/19
LOOP Antennas(9kHz-30MHz)	R&S	HFH2-Z2	100262	2017/6/15	2019/6/14
LOOP Antennas(9kHz-30MHz)	R&S	HFH2-Z2	100263	2017/8/21	2019/8/20
Trilog Broadband Antenna (30M~3GHz)	SCHWARZBECK	VULB 9163	9163-490	2017/3/29	2019/3/28
Trilog Broadband Antenna (30M~3GHz)	SCHWARZBECK	VULB 9163	9163-521	2018/4/9	2020/4/8
Trilog Broadband Antenna (30M~3GHz)	SCHWARZBECK	VULB 9163	9163-357	2017/4/21	2019/4/20



Double-Ridged Waveguide Horn Antenna (1G~18GHz)	R&S	HF907	100304	2017/5/27	2019/5/26
double ridged horn antenna (0.8G-18GHz)	R&S	HF907	100305	2017/4/21	2019/4/20
Pyramidal Horn Antenna(18GHz-26.5GHz)	ETS-Lindgren	3160-09	5140299	2017/7/20	2019/7/19
Pyramidal Horn Antenna(26.5GHz-40GHz)	ETS-Lindgren	3160-10	00205695	2018/4/20	2020/4/19
Pyramidal Horn Antenna(26.5GHz-40GHz)	ETS-Lindgren	3160-10	LM5947	2017/7/20	2019/7/19
Artificial Main Network	R&S	ENV4200	100134	2018/5/8	2019/5/7
Line Impedance Stabilization Network	R&S	ENV216	100382	2018/5/8	2019/5/7
Software Information					
Test Item	Software Name		Manufacturer		Version
RSE	EMC32		R&S		V8.40.0



6 Measurement Uncertainty

For a 95% confidence level ($k = 2$), the measurement expanded uncertainties for defined systems, in accordance with the recommendations of ISO 17025 as following:

Test Item		Extended Uncertainty
Transmit Output Power Conducted	Power [dBm]	U = 0.64 dB
RF Power Density, Conducted	Power [dBm]	U = 0.64 dB
Bandwidth	Magnitude [kHz]	200kHz: U=9.06kHz 1.4MHz: U=9.48kHz 3MHz: U= 10.86kHz 5MHz: U=13.84kHz 10MHz: U=22.32kHz 15MHz: U=31.9kHz 20MHz: U=41.78kHz
Band Edge Compliance	Disturbance Power [dBm]	U = 0.9 dB
Spurious Emissions, Conducted	Disturbance Power [dBm]	20MHz~3.6GHz: U=0.88dB 3.6GHz~8.4GHz: U=1.08dB 8.4GHz~13.6GHz: U=1.24dB 13.6GHz~22GHz: U=1.34dB 22GHz~26.5GHz: U=1.36dB
Field Strength of Spurious Radiation	ERP/EIRP [dBm]	For 3 m Chamber: U = 5.94 dB (30 MHz to 3GHz) U = 5.54 dB (3GHz to 18GHz) U = 4.94 dB (18GHz to 26.5GHz)
Frequency Stability	Frequency Accuracy [Hz]	800MHz: U=24.08Hz 900MHz: U=24.54Hz 1900MHz: U=34.7Hz 2100MHz: U=36.96Hz 2300MHz: U=39.24Hz 2500MHz: U=41.58Hz 2600MHz: U=42.74Hz



7 Appendixes

Appendix No.	Description
SYBH(Z-RF)20180907024002-2001-A	Appendix_for_GSM
SYBH(Z-RF)20180907024002-2001-B	Appendix_for_WCDMA
SYBH(Z-RF)20180907024002-2001-C	Appendix_for_LTE Band2
SYBH(Z-RF)20180907024002-2001-D	Appendix_for_LTE Band4
SYBH(Z-RF)20180907024002-2001-E	Appendix_for_LTE Band5
SYBH(Z-RF)20180907024002-2001-F	Appendix_for_LTE Band7
SYBH(Z-RF)20180907024002-2001-G	Appendix_for_LTE Band38
SYBH(Z-RF)20180907024002-2001-H	Appendix_for_LTE Band41

Appendix	Description
Appendix A	Effective (Isotropic) Radiated Power Output Data
Appendix B	Peak-Average Ratio
Appendix C	Modulation Characteristics
Appendix D	Bandwidth
Appendix E	Band Edges Compliance
Appendix F	Spurious Emission at Antenna Terminals
Appendix G	Frequency Stability

END