



RF TEST REPORT

Applicant Huawei Technologies Co., Ltd
FCC ID QISHIKEY970
Product Hikey970
Brand Hikey
Model Hikey970
Report No. R1809A0409-R1V2
Issue Date October 18, 2018

TA Technology (Shanghai) Co., Ltd. tested the above equipment in accordance with the requirements in **FCC CFR47 Part 15C (2018)**. The test results show that the equipment tested is capable of demonstrating compliance with the requirements as documented in this report.

Performed by: Peng Tao

Approved by: Kai Xu

TA Technology (Shanghai) Co., Ltd.

No.145, Jintang Rd, Tangzhen Industry Park, Pudong Shanghai, China

TEL: +86-021-50791141/2/3

FAX: +86-021-50791141/2/3-8000



TABLE OF CONTENT

- 1. Test Laboratory 4
 - 1.1. Notes of the test report..... 4
 - 1.2. Test facility 4
 - 1.3. Testing Location..... 5
- 2. General Description of Equipment under Test..... 6
- 3. Applied Standards 7
- 4. Test Configuration 8
- 5. Test Case Results 9
 - 5.1. Unwanted Emission 9
 - 5.2. Conducted Emission 41
- 6. Main Test Instruments 44

Summary of measurement results

Number	Summary of measurements of results	Clause in FCC rules	Verdict
1	Maximum conducted output power	15.247(b)(3)	Refer to Report No.: FR4O0971C
2	6 dB bandwidth	15.247(a)(2)	Refer to Report No.: FR4O0971C
3	Power spectral density	15.247(e)	Refer to Report No.: FR4O0971C
4	Band Edge	15.247(d)	Refer to Report No.: FR4O0971C
5	Spurious RF Conducted Emissions	15.247(d)	Refer to Report No.: FR4O0971C
6	Unwanted Emissions	15.247(d),15.205,15.209	PASS
7	Conducted Emissions	15.207	PASS
Date of Testing: September 15, 2018 ~ September 30, 2018			

Only Unwanted Emission and Conducted Emission are tested for Hikey970 in this report. Other test items refer to the WiFi and Bluetooth Module report (Report No.: FR4O0971C; FCC ID: Z64-WL18DBMOD).



1. Test Laboratory

1.1. Notes of the test report

This report shall not be reproduced in full or partial, without the written approval of **TA technology (shanghai) co., Ltd.** The results documented in this report apply only to the tested sample, under the conditions and modes of operation as described herein .Measurement Uncertainties were not taken into account and are published for informational purposes only. This report is written to support regulatory compliance of the applicable standards stated above.

1.2. Test facility

CNAS (accreditation number: L2264)

TA Technology (Shanghai) Co., Ltd. has obtained the accreditation of China National Accreditation Service for Conformity Assessment (CNAS).

FCC (Designation number: CN1179, Test Firm Registration Number: 446626)

TA Technology (Shanghai) Co., Ltd. has been listed on the US Federal Communications Commission list of test facilities recognized to perform electromagnetic emissions measurements.

IC (recognition number is 8510A)

TA Technology (Shanghai) Co., Ltd. has been listed by industry Canada to perform electromagnetic emission measurement.

VCCI (recognition number is C-4595, T-2154, R-4113, G-10766)

TA Technology (Shanghai) Co., Ltd. has been listed by industry Japan to perform electromagnetic emission measurement.

A2LA (Certificate Number: 3857.01)

TA Technology (Shanghai) Co., Ltd. has been listed by American Association for Laboratory Accreditation to perform electromagnetic emission measurement.



1.3. Testing Location

Company: TA Technology (Shanghai) Co., Ltd.
Address: No.145, Jintang Rd, Tangzhen Industry Park, Pudong
City: Shanghai
Post code: 201201
Country: P. R. China
Contact: Xu Kai
Telephone: +86-021-50791141/2/3
Fax: +86-021-50791141/2/3-8000
Website: <http://www.ta-shanghai.com>
E-mail: xukai@ta-shanghai.com

2. General Description of Equipment under Test

Client Information

Applicant	Huawei Technologies Co., Ltd
Applicant address	Administration Building, Headquarters of Huawei Technologies Co., Ltd., Bantian, Longgang District, Shenzhen, China
Manufacturer	HiSilicon Technologies Co., Ltd.
Manufacturer address	D3, Huawei Base, Bantian, Longgang District, Shenzhen, China

General information

EUT Description	
Model	Hikey970
IMEI	/
Hardware Version	Hikey970_VB
Software Version	android Q
Power Supply	External Power Supply
Antenna Type	Chip Antenna
Antenna Connector	A permanently attached antenna (meet with the standard FCC Part 15.203 requirement)
Antenna Gain	Antenna 1: 2.2 dBi Antenna 2: 2.2 dBi
additional beamforming gain	NA
Test Mode	802.11b 802.11g, 802.11n(HT20/HT40);
Modulation Type	802.11b: DSSS; 802.11g/n(HT20/HT40): OFDM
Operating Frequency Range(s)	802.11b/g/n(HT20): 2412 ~ 2462 MHz 802.11n(HT40): 2422 ~ 2452 MHz
Note: The information of the EUT is declared by the manufacturer.	

3. Applied Standards

According to the specifications of the manufacturer, it must comply with the requirements of the following standards:

Test standards

- **FCC CFR47 Part 15C (2018) Radio Frequency Devices**
- **ANSI C63.10 (2013)**
- **KDB 558074 D01 DTS Meas Guidance v05**
- **KDB 662911 D01 Multiple Transmitter Output v02r01**

4. Test Configuration

Test Mode

The EUT has been associated with peripherals and configuration operated in a manner tended to maximize its emission characteristics in a typical application.

The radiated emission was measured in the following position: EUT stand-up position (Z axis), lie-down position (X, Y axis). The worst emission was found in lie-down position (X axis) and the worst case was recorded.

In order to find the worst case condition, Pre-tests are needed at the presence of different data rate. Preliminary tests have been done on all the configuration for confirming worst case. Data rate below means worst-case rate of each test item.

Worst-case data rates are shown as following table.

Band	Data Rate	
	Antenna 1	MIMO
802.11b	1 Mbps	/
802.11g	6 Mbps	/
802.11n HT20	MCS0	MCS12-15
802.11n HT40	MCS0	/

The worst case Antenna mode for each of the following tests for Wi-Fi:

Test Cases	Antenna 1	MIMO
Unwanted Emissions	802.11b/g 802.11n HT40	802.11n HT20
Conducted Emission	802.11b/g 802.11n HT40	802.11n HT20
Note: "O": test all bands		

5. Test Case Results

5.1. Unwanted Emission

Ambient condition

Temperature	Relative humidity	Pressure
23°C ~25°C	45%~50%	102.5kPa

Method of Measurement

The test set-up was made in accordance to the general provisions of ANSI C63.10-2013.

The Equipment Under Test (EUT) was set up on a non-conductive table in the semi-anechoic chamber. The test was performed at the distance of 3 m between the EUT and the receiving antenna.

The turntable shall be rotated from 0 to 360 degrees for detecting the maximum of radiated spurious signal level. The measurements shall be repeated with orthogonal polarization of the test antenna. The data of cable loss and antenna factor has been calibrated in full testing frequency range before the testing. Sweep the Restricted Band and the emissions less than 20 dB below the permissible value are reported.

The radiated emissions measurements were made in a typical installation configuration.

Sweep the whole frequency band through the range from 9 kHz to the 10th harmonic of the carrier, and the emissions less than 20 dB below the permissible value are reported.

This method refer to ANSI C63.10-2013.

The procedure for peak unwanted emissions measurements above 1000 MHz is as follows:

I) Peak emission levels are measured by setting the instrument as follows:

- 1) RBW = 1 MHz.
- 2) VBW \geq [3 × RBW]
- 3) Detector = peak.
- 4) Sweep time = auto.
- 5) Trace mode = max hold.
- 6) Allow sweeps to continue until the trace stabilizes. Note that if the transmission is not continuous, then the time required for the trace to stabilize will increase by a factor of approximately 1 / D, where D is the duty cycle.

II) Average emission levels are measured by setting the instrument as follows:

- a) RBW = 1 MHz.
- b) VBW \geq [3 × RBW].
- c) Detector = RMS (power averaging), if [span / (# of points in sweep)] \leq RBW / 2. Satisfying this condition can require increasing the number of points in the sweep or reducing the span. If the

condition is not satisfied, then the detector mode shall be set to peak.

d) Averaging type = power (i.e., rms) (As an alternative, the detector and averaging type may be set for linear voltage averaging. Some instruments require linear display mode to use linear voltage averaging. Log or dB averaging shall not be used.)

e) Sweep time = auto.

f) Perform a trace average of at least 100 traces if the transmission is continuous. If the transmission is not continuous, then the number of traces shall be increased by a factor of $1 / D$, where D is the duty cycle. For example, with 50% duty cycle, at least 200 traces shall be averaged. (If a specific emission is demonstrated to be continuous—i.e., 100% duty cycle—then rather than turning ON and OFF with the transmit cycle, at least 100 traces shall be averaged.)

g) If tests are performed with the EUT transmitting at a duty cycle less than 98%, then a correction factor shall be added to the measurement results prior to comparing with the emission limit, to compute the emission level that would have been measured had the test been performed at 100% duty cycle. The correction factor is computed as follows:

1) If power averaging (rms) mode was used in the preceding step e), then the correction factor is $[10 \log (1 / D)]$, where D is the duty cycle. For example, if the transmit duty cycle was 50%, then 3 dB shall be added to the measured emission levels.

2) If linear voltage averaging mode was used in the preceding step e), then the correction factor is $[20 \log (1 / D)]$, where D is the duty cycle. For example, if the transmit duty cycle was 50%, then 6 dB shall be added to the measured emission levels.

3) If a specific emission is demonstrated to be continuous (100% duty cycle) rather than turning ON and OFF with the transmit cycle, then no duty cycle correction is required for that emission.

The field strength of spurious emission was measured in the following position: EUT stand-up position (Z axis), lie-down position (X, Y axis). The worst emission was found in lie-down position (Xaxis) and the antenna is vertical.

The test is in transmitting mode.

Test setup

9KHz ~ 30MHz

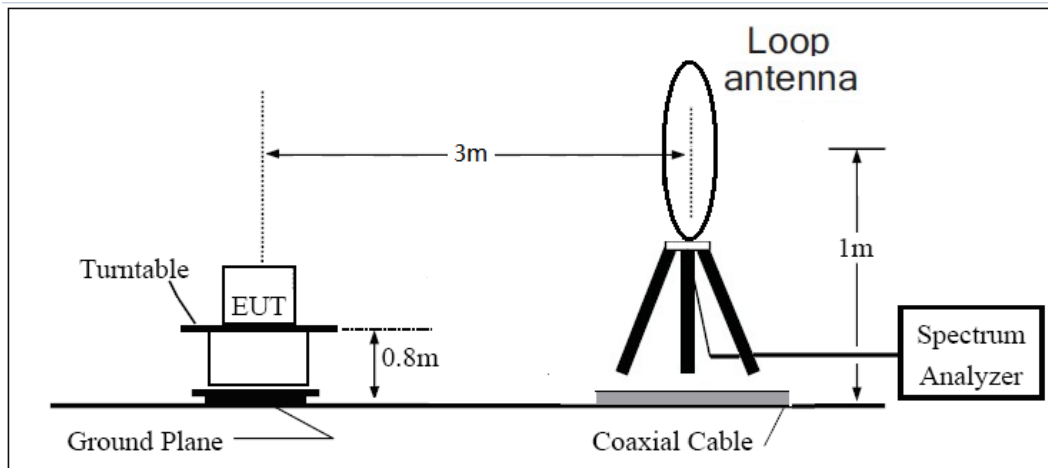

30MHz ~ 1GHz

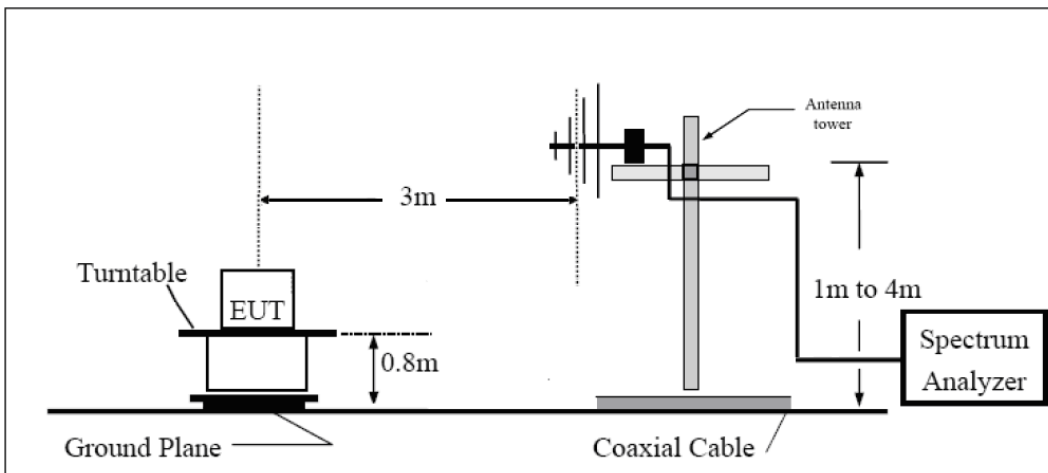

Above 1GHz

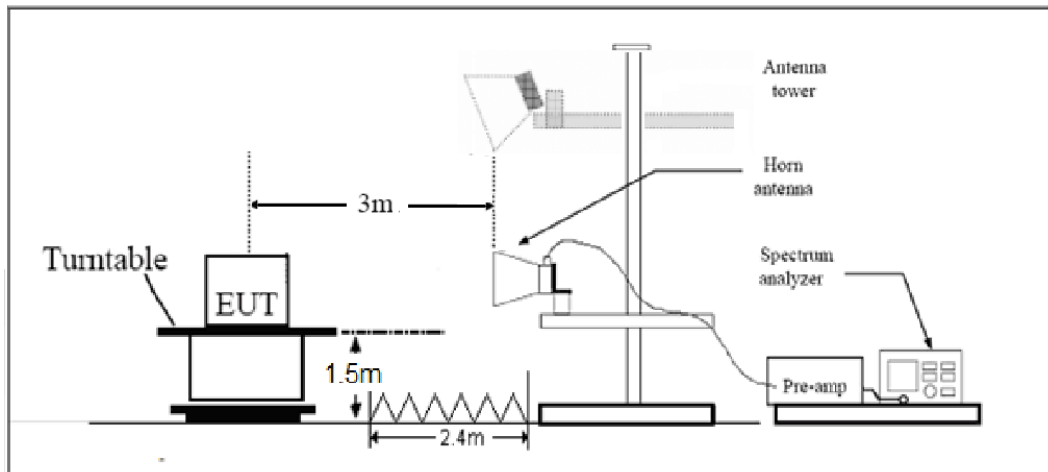

Note: Area side:2.4mX3.6m

**Limits**

Rule Part 15.247(d) specifies that "In addition, radiated emissions which fall in the restricted bands, as defined in § 15.205(a), must also comply with the radiated emission limits specified in § 15.209(a) (see § 15.205(c))."

Limit in restricted band

Frequency of emission (MHz)	Field strength(uV/m)	Field strength(dBuV/m)
0.009–0.490	2400/F(kHz)	/
0.490–1.705	24000/F(kHz)	/
1.705–30.0	30	/
30-88	100	40
88-216	150	43.5
216-960	200	46
Above960	500	54

§15.35(b)

There is also a limit on the radio frequency emissions, as measured using instrumentation with a peak detector function, corresponding to 20 dB above the maximum permitted average limit.

Peak Limit=74 dBuV/m

Average Limit=54 dBuV/m

Spurious Radiated Emissions are permitted in any of the frequency bands listed below:

MHz	MHz	MHz	GHz
0.090 - 0.110	16.42 - 16.423	399.9 - 410	4.5 - 5.15
¹ 0.495 - 0.505	16.69475 - 16.69525	608 - 614	5.35 - 5.46
2.1735 - 2.1905	16.80425 - 16.80475	960 - 1240	7.25 - 7.75
4.125 - 4.128	25.5 - 25.67	1300 - 1427	8.025 - 8.5
4.17725 - 4.17775	37.5 - 38.25	1435 - 1626.5	9.0 - 9.2
4.20725 - 4.20775	73 - 74.6	1645.5 - 1646.5	9.3 - 9.5
6.215 - 6.218	74.8 - 75.2	1660 - 1710	10.6 - 12.7
6.26775 - 6.26825	108 - 121.94	1718.8 - 1722.2	13.25 - 13.4
6.31175 - 6.31225	123 - 138	2200 - 2300	14.47 - 14.5
8.291 - 8.294	149.9 - 150.05	2310 - 2390	15.35 - 16.2
8.362 - 8.366	156.52475 - 156.52525	2483.5 - 2500	17.7 - 21.4
8.37625 - 8.38675	156.7 - 156.9	2690 - 2900	22.01 - 23.12
8.41425 - 8.41475	162.0125 - 167.17	3260 - 3267	23.6 - 24.0
12.29 - 12.293	167.72 - 173.2	3332 - 3339	31.2 - 31.8
12.51975 - 12.52025	240 - 285	3345.8 - 3358	36.43 - 36.5
12.57675 - 12.57725	322 - 335.4	3600 - 4400	(²)
13.36 - 13.41			

**Measurement Uncertainty**

The assessed measurement uncertainty to ensure 95% confidence level for the normal distribution is with the coverage factor $k = 1.96$.

Frequency	Uncertainty
9KHz-30MHz	3.55 dB
30MHz-200MHz	4.19 dB
200MHz-1GHz	3.63 dB
Above 1GHz	3.68 dB



Test Results:

SISO Antenna 1

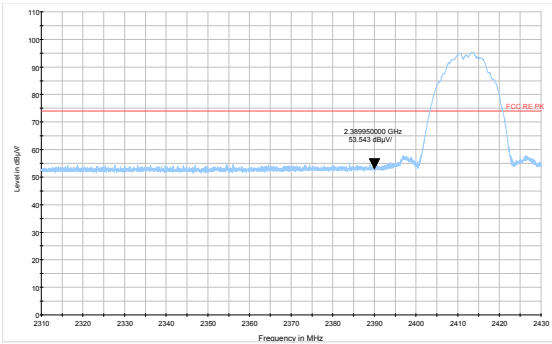

802.11b-Channel 1 Peak

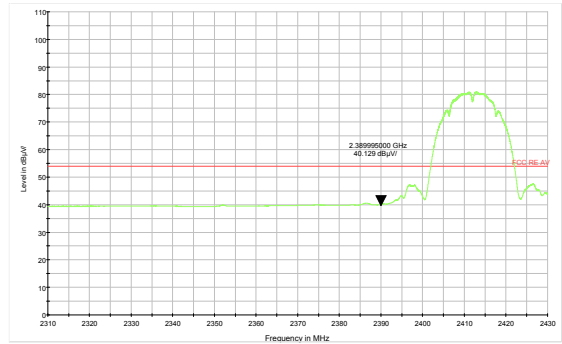

802.11b-Channel 1 Average

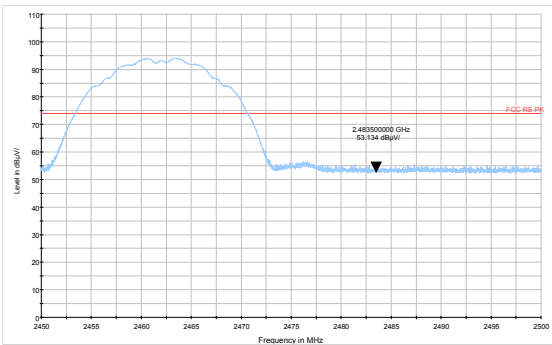

802.11b-Channel 11 Peak

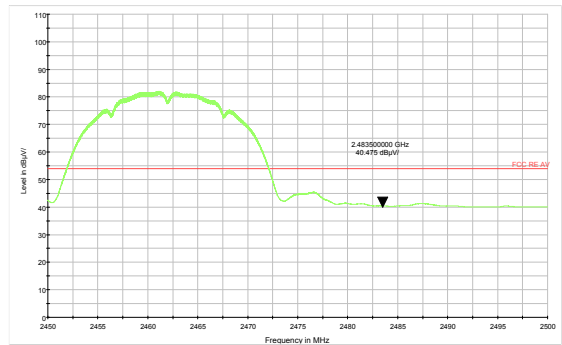

802.11b-Channel 11 Average

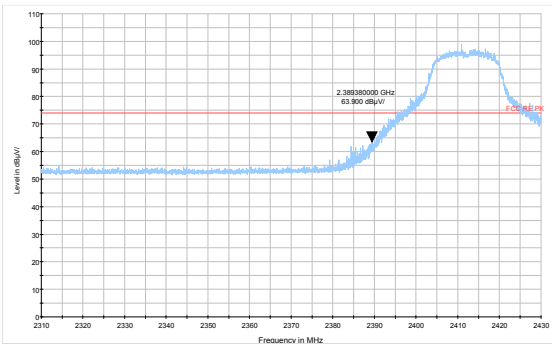

802.11g-Channel 1 Peak

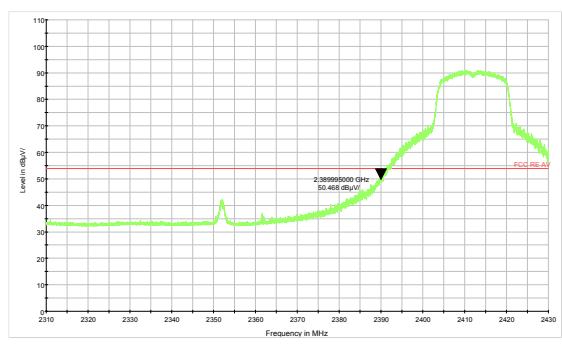

802.11g-Channel 1 Average

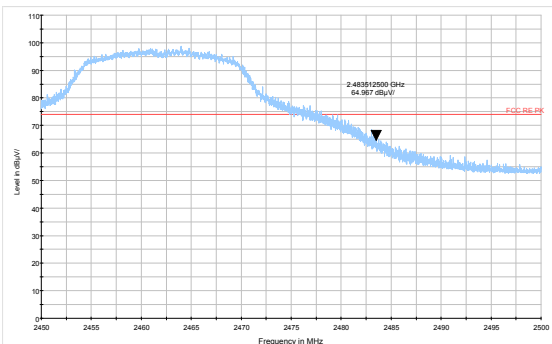

802.11g-Channel 11 Peak

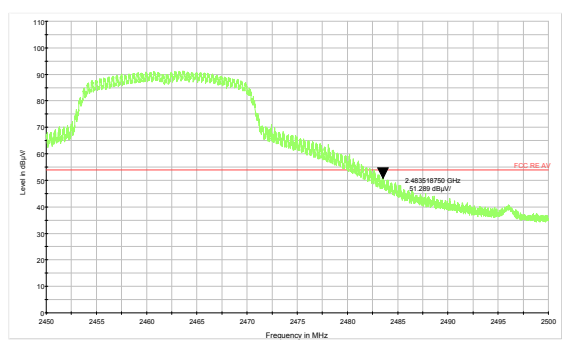

802.11g-Channel 11 Average



MIMO

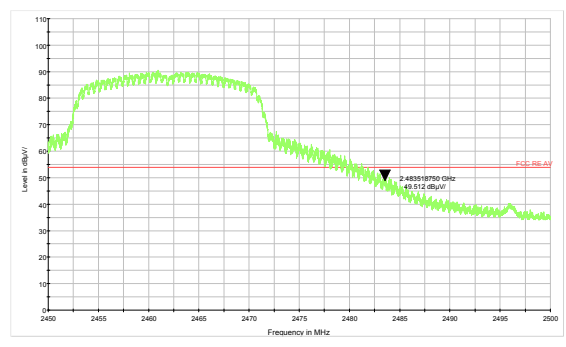
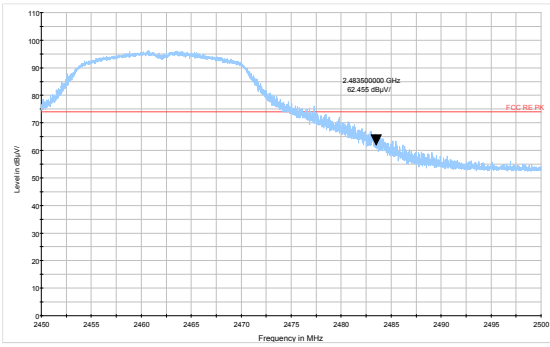
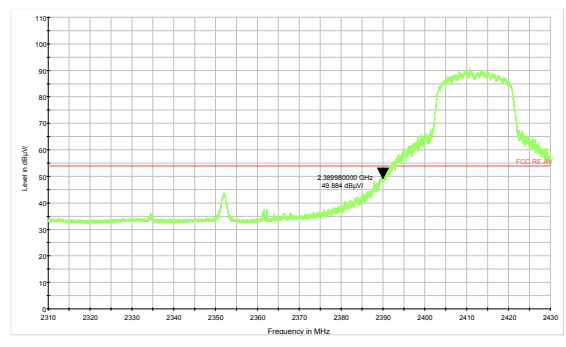
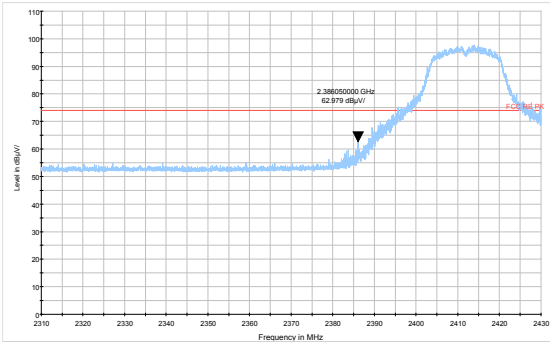

SISO Antenna 1

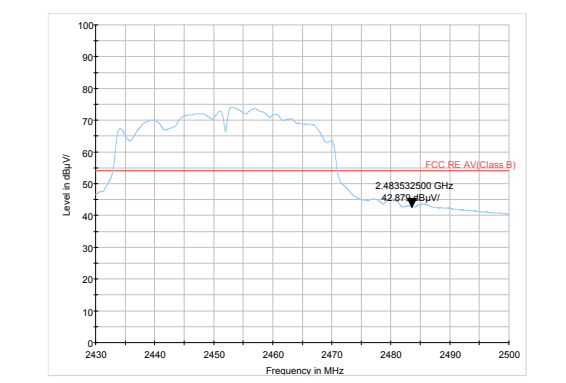
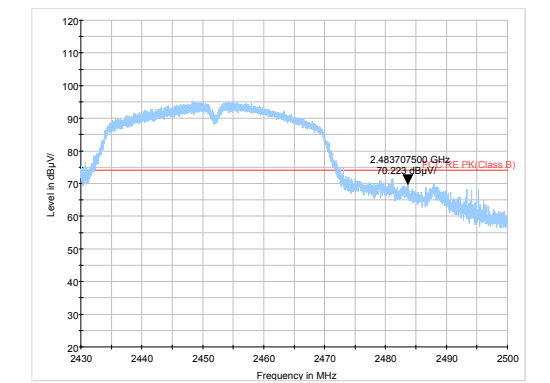
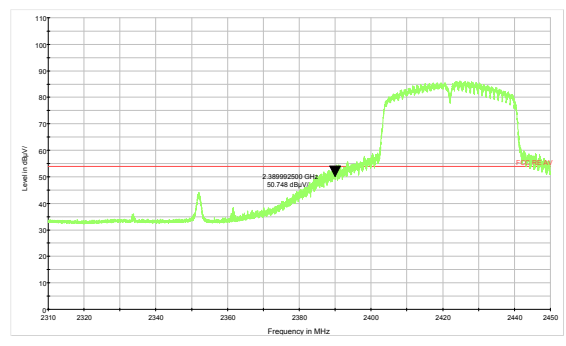
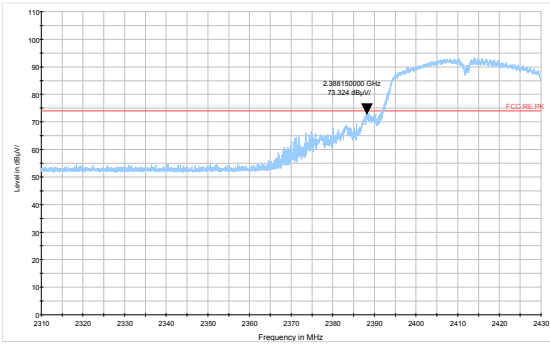

Result of RE

Test result

Sweep the whole frequency band through the range from 9kHz to the 10th harmonic of the carrier, the Emissions in the frequency band 9kHz-30MHz and 18GHz-26.5GHz are more than 20dB below the limit are not reported.

The following graphs display the maximum values of horizontal and vertical by software. For above 1GHz, Blue trace uses the peak detection, Green trace uses the average detection.

After the pretest, MIMO was selected as the worst antenna for 802.11n HT20.

During the test, the Radiates Emission from 30MHz to 1GHz was performed in all modes with all channels, 802.11b, Channel 11 are selected as the worst condition. The test data of the worst-case condition was recorded in this report.

Continuous TX mode:

FCC RE 0.03-1GHz QP Class B

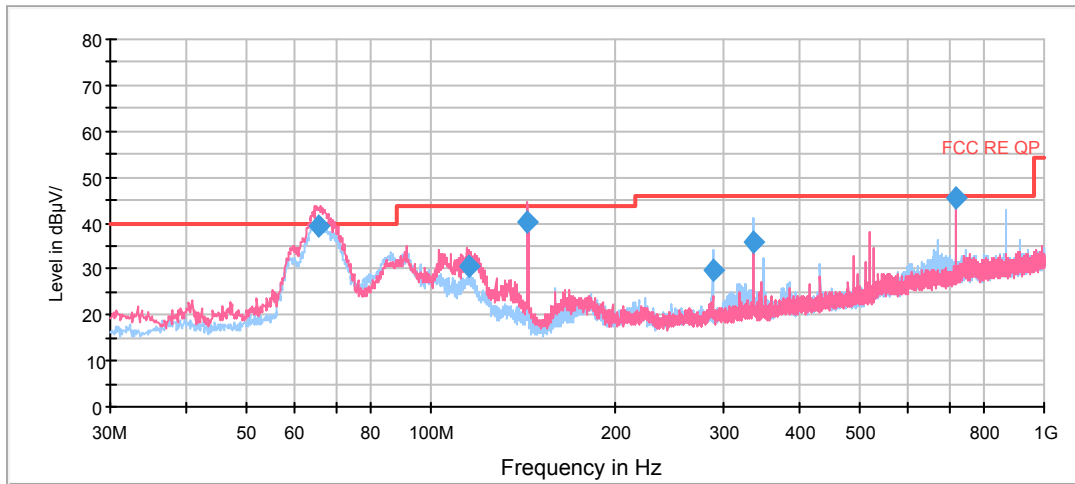

Radiates Emission from 30MHz to 1GHz

Frequency (MHz)	Quasi-Peak (dBuV/m)	Reading value (dBuV/m)	Height (cm)	Polarization	Azimuth (deg)	Correct Factor (dB)	Margin (dB)	Limit (dBuV/m)
65.772500	39.2	29.0	100.0	V	24.0	10.2	0.8	40.0
114.990000	30.6	19.1	100.0	V	68.0	11.5	12.9	43.5
144.015000	40.3	31.2	100.0	V	328.0	9.1	3.2	43.5
288.020000	29.6	14.2	114.0	H	35.0	15.4	16.4	46.0
335.993750	35.7	19.0	100.0	H	42.0	16.7	10.3	46.0
719.993750	45.7	21.5	114.0	H	104.0	24.2	0.3	46.0

- Remark: 1. Quasi-Peak = Reading value + Correction factor
- 2. Correction Factor = Antenna factor+ Insertion loss(cable loss+amplifier gain)
- 3. Margin = Limit – Quasi-Peak

SISO Antenna 1
802.11b CH1

FCC RE 1G-3GHz PK+AV Class B

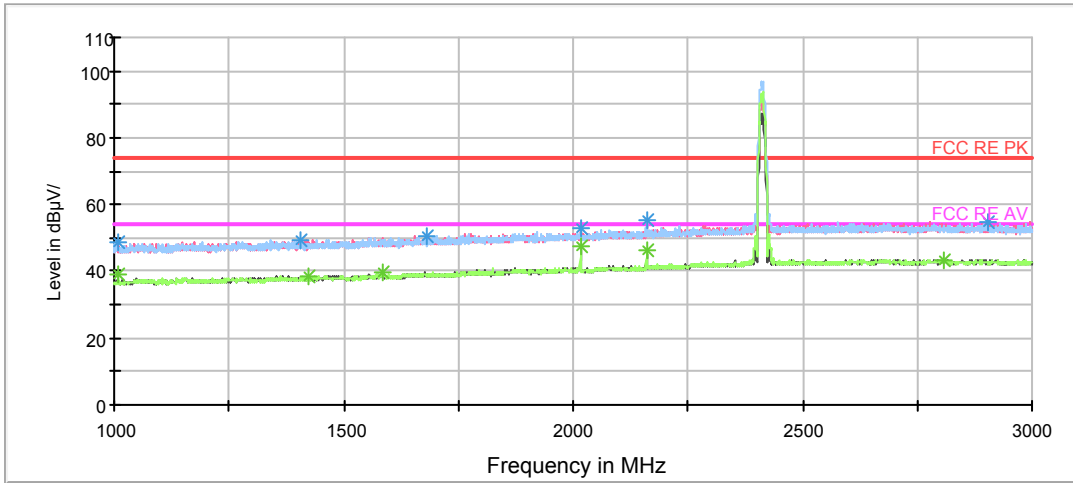

Note: The signal beyond the limit is carrier.
Radiates Emission from 1GHz to 3GHz

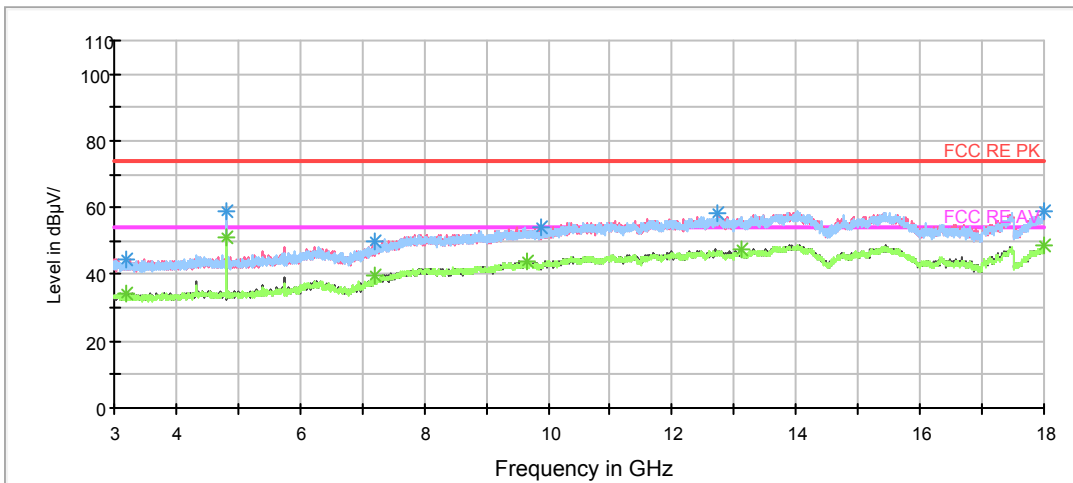

Radiates Emission from 3GHz to 18GHz



Frequency (MHz)	Peak (dBuV/m)	Height (cm)	Polarization	Azimuth (deg)	Reading value (dBuV/m)	Correct Factor (dB)	Margin (dB)	Limit (dBuV/m)
1008.500000	48.7	200.0	V	157.0	50.8	-2.1	25.3	74
1408.000000	49.6	200.0	H	358.0	50.2	-0.6	24.4	74
1680.000000	50.5	100.0	V	97.0	49.3	1.2	23.5	74
2016.000000	53.2	200.0	V	357.0	50.6	2.6	20.8	74
2160.500000	55.3	100.0	H	143.0	51.7	3.6	18.7	74
2902.500000	54.8	100.0	H	72.0	49.1	5.7	19.2	74

Remark: 1. Correction Factor = Antenna factor+ Insertion loss (cable loss + amplifier gain)

Frequency (MHz)	Average (dBuV/m)	Height (cm)	Polarization	Azimuth (deg)	Reading value (dBuV/m)	Correct Factor (dB)	Margin (dB)	Limit (dBuV/m)
1008.000000	39.4	200.0	H	231.0	41.5	-2.1	14.6	54
1425.500000	38.5	200.0	V	1.0	38.9	-0.4	15.5	54
1584.000000	39.6	200.0	H	337.0	38.9	0.7	14.4	54
2016.000000	47.3	200.0	H	310.0	44.7	2.6	6.7	54
2160.000000	46.4	200.0	H	344.0	42.8	3.6	7.6	54
2810.000000	43.5	200.0	V	78.0	37.8	5.7	10.5	54

Remark: 1. Correction Factor = Antenna factor+ Insertion loss (cable loss + amplifier gain)

802.11b CH6

FCC RE 1G-3GHz PK+AV Class B

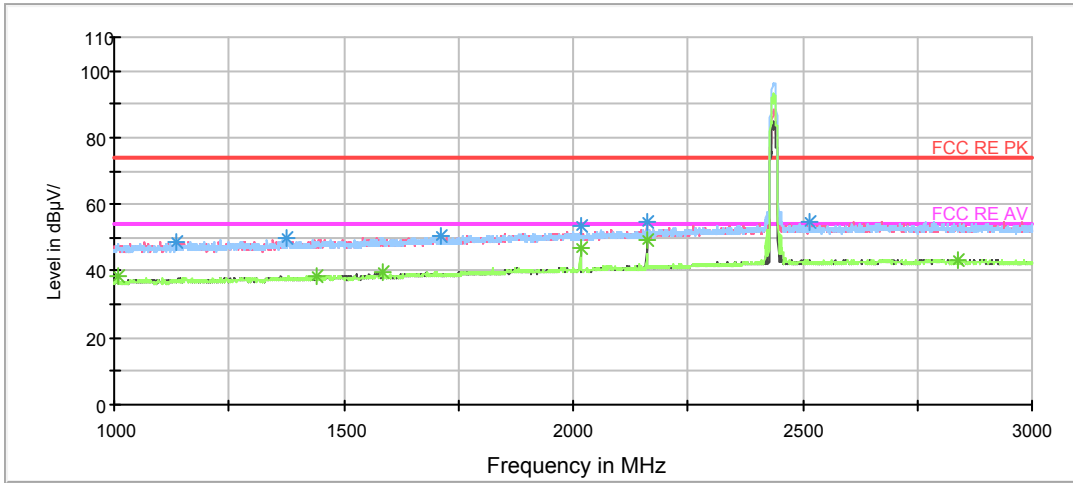

Note: The signal beyond the limit is carrier.
Radiates Emission from 1GHz to 3GHz

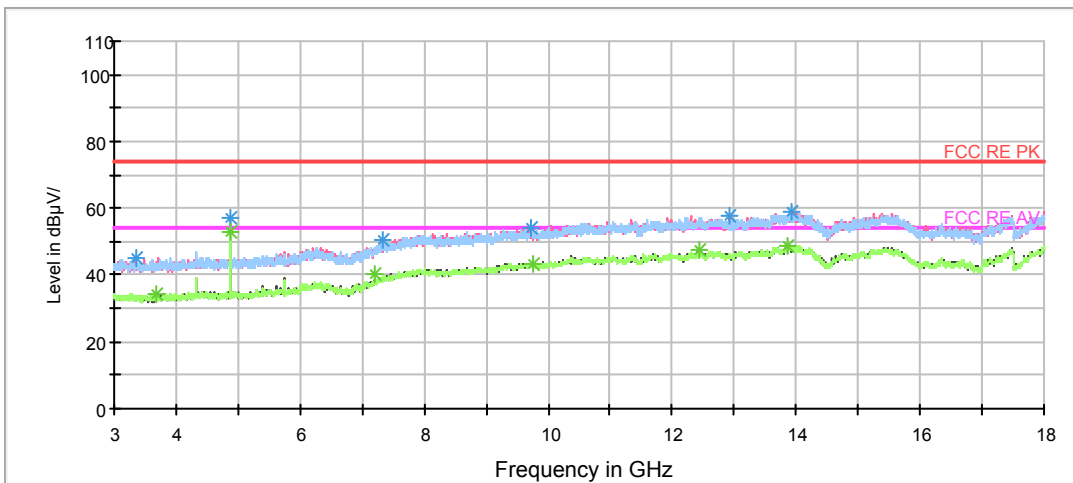

Radiates Emission from 3GHz to 18GHz



Frequency (MHz)	Peak (dBuV/m)	Height (cm)	Polarization	Azimuth (deg)	Reading value (dBuV/m)	Correct Factor (dB)	Margin (dB)	Limit (dBuV/m)
1133.500000	48.9	100.0	H	29.0	50.5	-1.6	25.1	74
1376.500000	49.6	100.0	H	0.0	50.0	-0.4	24.4	74
1710.500000	50.6	100.0	V	234.0	49.6	1.0	23.4	74
2016.000000	53.5	200.0	H	212.0	50.9	2.6	20.5	74
2160.000000	54.5	100.0	V	184.0	50.9	3.6	19.5	74
2514.000000	54.8	100.0	H	64.0	49.5	5.3	19.2	74

Remark: 1. Correction Factor = Antenna factor+ Insertion loss (cable loss + amplifier gain)

Frequency (MHz)	Average (dBuV/m)	Height (cm)	Polarization	Azimuth (deg)	Reading value (dBuV/m)	Correct Factor (dB)	Margin (dB)	Limit (dBuV/m)
1007.500000	38.7	200.0	H	21.0	40.8	-2.1	15.3	54
1441.000000	38.4	100.0	H	143.0	38.7	-0.3	15.6	54
1584.000000	39.6	100.0	V	243.0	38.9	0.7	14.4	54
2016.000000	46.9	100.0	H	29.0	44.3	2.6	7.1	54
2160.000000	49.3	100.0	V	184.0	45.7	3.6	4.7	54
2840.000000	43.5	200.0	H	114.0	37.9	5.6	10.5	54

Remark: 1. Correction Factor = Antenna factor+ Insertion loss (cable loss + amplifier gain)

802.11b CH11

FCC RE 1G-3GHz PK+AV Class B

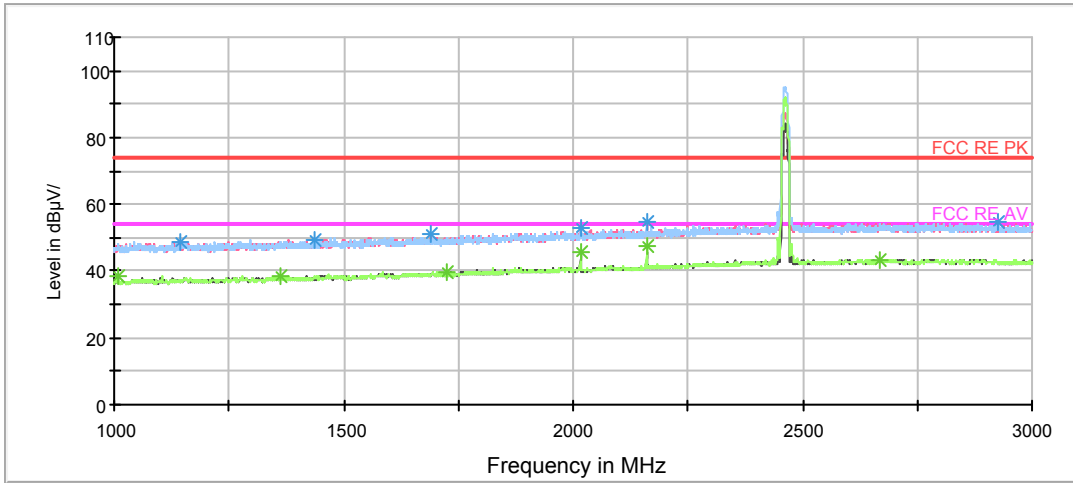

Note: The signal beyond the limit is carrier.
Radiates Emission from 1GHz to 3GHz

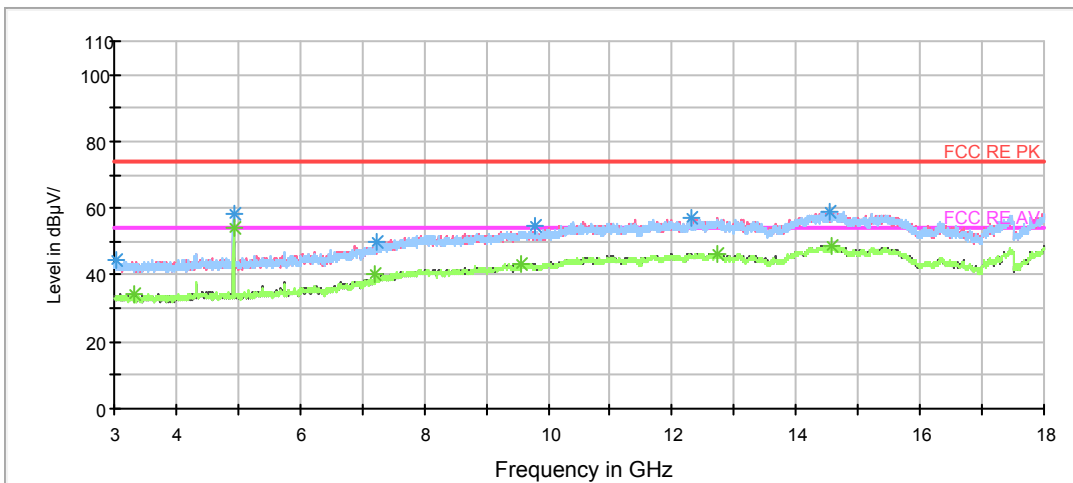

Radiates Emission from 3GHz to 18GHz



Frequency (MHz)	Peak (dBuV/m)	Height (cm)	Polarization	Azimuth (deg)	Reading value (dBuV/m)	Correct Factor (dB)	Margin (dB)	Limit (dBuV/m)
1144.500000	48.6	100.0	V	0.0	50.1	-1.5	25.4	74
1434.500000	49.2	200.0	H	223.0	49.5	-0.3	24.8	74
1691.500000	50.9	200.0	V	0.0	49.7	1.2	23.1	74
2016.000000	53.1	100.0	V	260.0	50.5	2.6	20.9	74
2160.000000	54.9	100.0	V	181.0	51.3	3.6	19.1	74
2927.500000	54.6	100.0	H	339.0	48.9	5.7	19.4	74

Remark: 1. Correction Factor = Antenna factor+ Insertion loss (cable loss + amplifier gain)

Frequency (MHz)	Average (dBuV/m)	Height (cm)	Polarization	Azimuth (deg)	Reading value (dBuV/m)	Correct Factor (dB)	Margin (dB)	Limit (dBuV/m)
1008.000000	38.6	200.0	H	78.0	40.7	-2.1	15.4	54
1360.500000	38.6	200.0	H	250.0	39.0	-0.4	15.4	54
1725.500000	39.7	200.0	H	329.0	38.6	1.1	14.3	54
2016.000000	45.8	200.0	V	3.0	43.2	2.6	8.2	54
2160.000000	47.7	200.0	H	345.0	44.1	3.6	6.3	54
2669.000000	43.4	200.0	H	69.0	37.8	5.6	10.6	54

Remark: 1. Correction Factor = Antenna factor+ Insertion loss (cable loss + amplifier gain)

802.11g CH1

FCC RE 1G-3GHz PK+AV Class B

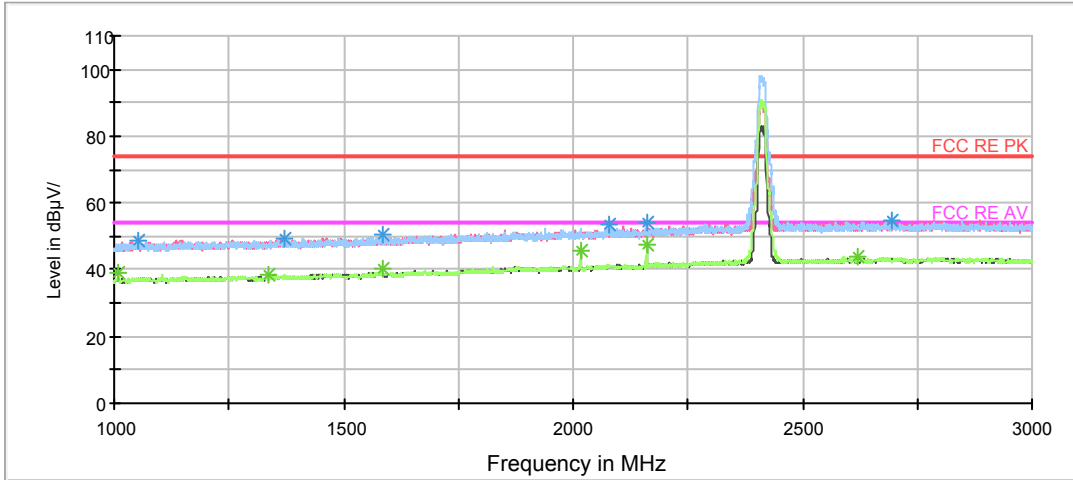

Note: The signal beyond the limit is carrier.
Radiates Emission from 1GHz to 3GHz

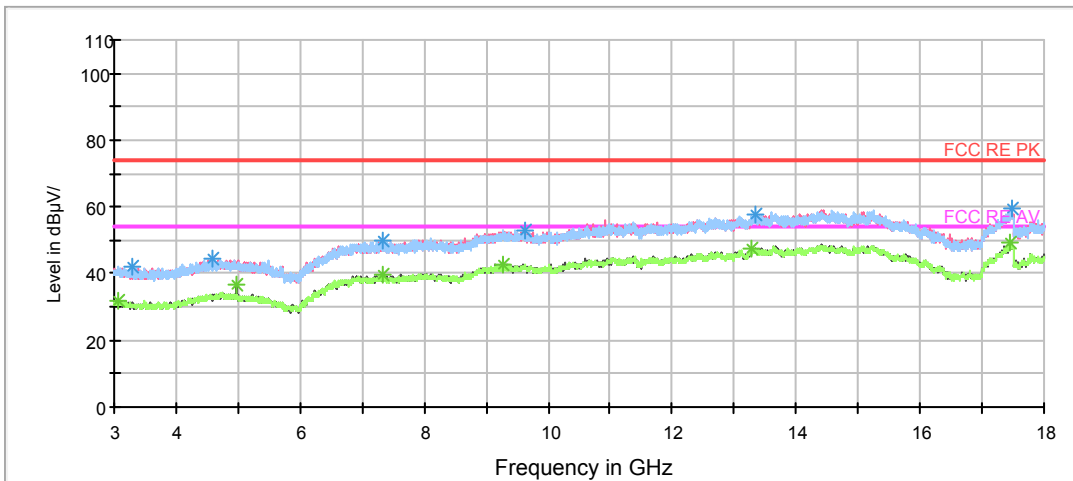

Radiates Emission from 3GHz to 18GHz



Frequency (MHz)	Peak (dBuV/m)	Height (cm)	Polarization	Azimuth (deg)	Reading value (dBuV/m)	Correct Factor (dB)	Margin (dB)	Limit (dBuV/m)
1054.500000	48.7	200.0	H	358.0	50.4	-1.7	25.3	74
1371.500000	49.5	100.0	H	23.0	49.8	-0.3	24.5	74
1584.000000	50.2	200.0	H	177.0	49.5	0.7	23.8	74
2077.500000	53.5	200.0	H	97.0	50.1	3.4	20.5	74
2160.000000	54.1	200.0	H	344.0	50.5	3.6	19.9	74
2693.500000	54.9	200.0	V	76.0	49.3	5.6	19.1	74

Remark: 1. Correction Factor = Antenna factor+ Insertion loss (cable loss + amplifier gain)

Frequency (MHz)	Average (dBuV/m)	Height (cm)	Polarization	Azimuth (deg)	Reading value (dBuV/m)	Correct Factor (dB)	Margin (dB)	Limit (dBuV/m)
1007.500000	39.1	200.0	H	239.0	41.2	-2.1	14.9	54
1337.000000	38.5	100.0	V	358.0	39.2	-0.7	15.5	54
1584.000000	40.0	100.0	H	173.0	39.3	0.7	14.0	54
2016.000000	45.6	200.0	H	301.0	43.0	2.6	8.4	54
2160.000000	47.3	200.0	H	344.0	43.7	3.6	6.7	54
2618.500000	43.8	200.0	V	4.0	38.3	5.5	10.2	54

Remark: 1. Correction Factor = Antenna factor+ Insertion loss (cable loss + amplifier gain)

802.11g CH6

FCC RE 1G-3GHz PK+AV Class B

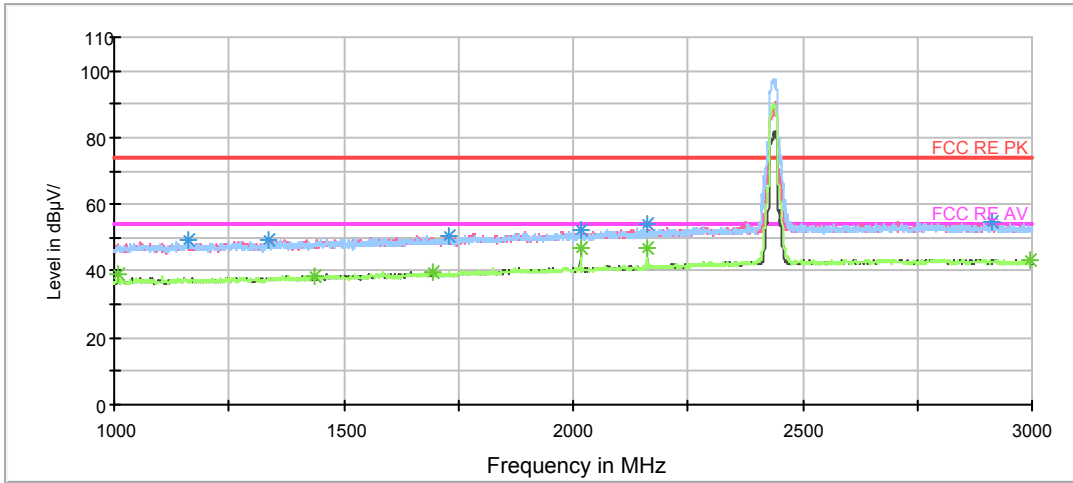

Note: The signal beyond the limit is carrier.
Radiates Emission from 1GHz to 3GHz

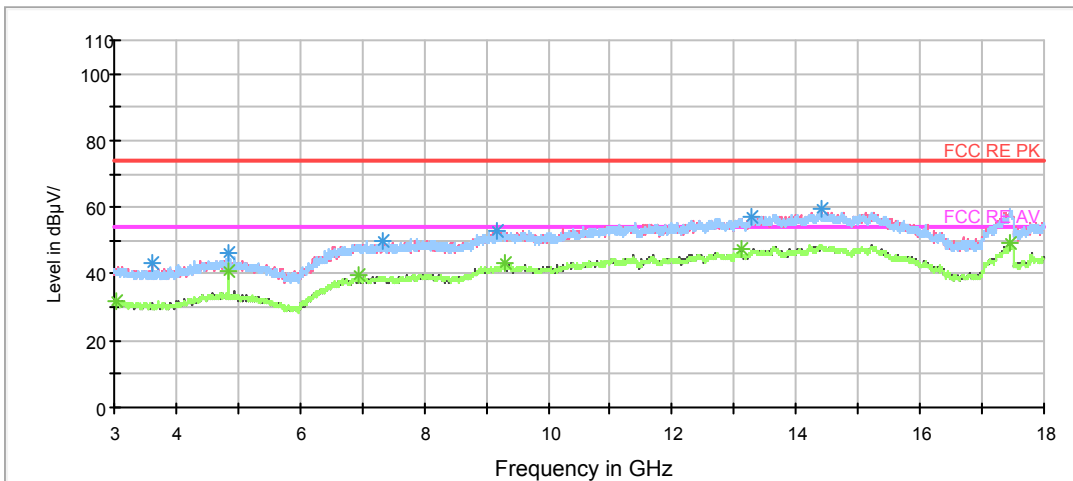

Radiates Emission from 3GHz to 18GHz



Frequency (MHz)	Peak (dBuV/m)	Height (cm)	Polarization	Azimuth (deg)	Reading value (dBuV/m)	Correct Factor (dB)	Margin (dB)	Limit (dBuV/m)
1161.000000	49.0	200.0	H	220.0	50.4	-1.4	25.0	74
1338.000000	49.5	100.0	V	0.0	50.2	-0.7	24.5	74
1728.500000	50.5	200.0	H	325.0	49.4	1.1	23.5	74
2016.000000	52.6	100.0	H	61.0	50.0	2.6	21.4	74
2160.500000	54.2	200.0	H	139.0	50.6	3.6	19.8	74
2912.000000	54.7	200.0	H	202.0	49.0	5.7	19.3	74

Remark: 1. Correction Factor = Antenna factor+ Insertion loss (cable loss + amplifier gain)

Frequency (MHz)	Average (dBuV/m)	Height (cm)	Polarization	Azimuth (deg)	Reading value (dBuV/m)	Correct Factor (dB)	Margin (dB)	Limit (dBuV/m)
1008.000000	38.9	200.0	H	220.0	41.0	-2.1	15.1	54
1436.000000	38.4	100.0	V	357.0	38.7	-0.3	15.6	54
1693.000000	39.6	100.0	H	242.0	38.4	1.2	14.4	54
2016.000000	46.8	200.0	V	0.0	44.2	2.6	7.2	54
2160.000000	46.9	100.0	H	145.0	43.3	3.6	7.1	54
2996.500000	43.5	200.0	V	273.0	37.7	5.8	10.5	54

Remark: 1. Correction Factor = Antenna factor+ Insertion loss (cable loss + amplifier gain)

802.11g CH11

FCC RE 1G-3GHz PK+AV Class B

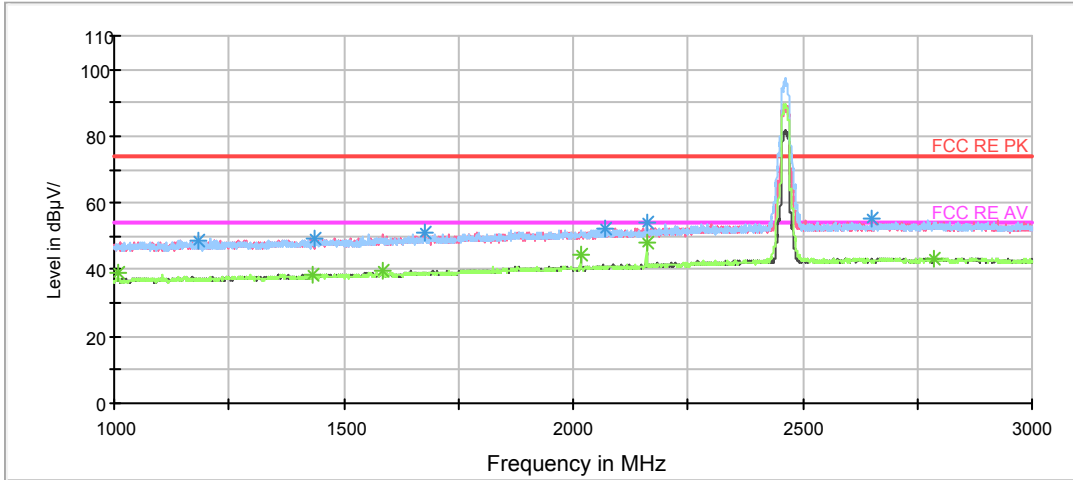

Note: The signal beyond the limit is carrier.
Radiates Emission from 1GHz to 3GHz

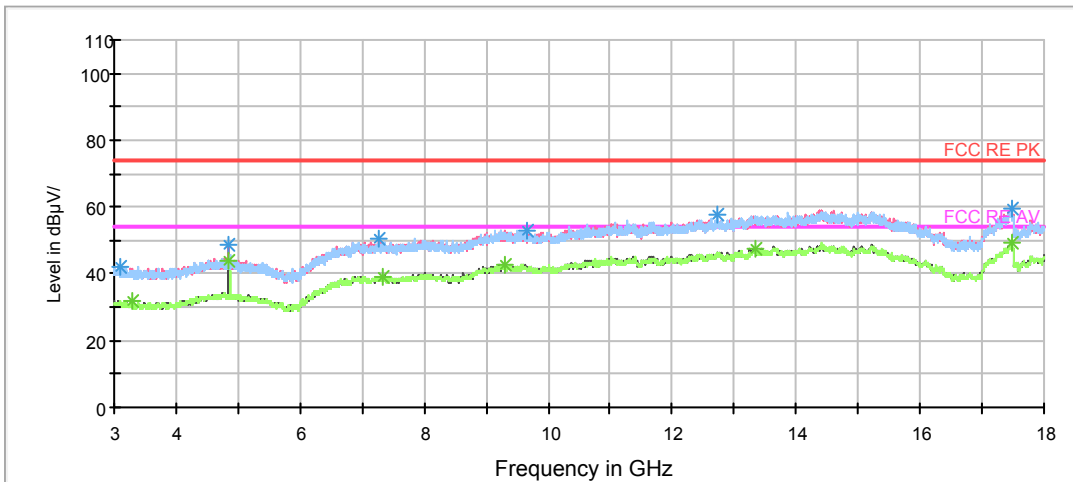

Radiates Emission from 3GHz to 18GHz



Frequency (MHz)	Peak (dBuV/m)	Height (cm)	Polarization	Azimuth (deg)	Reading value (dBuV/m)	Correct Factor (dB)	Margin (dB)	Limit (dBuV/m)
1185.000000	48.7	200.0	H	354.0	50.1	-1.4	25.3	74
1436.500000	49.6	100.0	V	280.0	49.9	-0.3	24.4	74
1676.500000	51.1	100.0	V	314.0	50.0	1.1	22.9	74
2071.500000	52.3	100.0	V	0.0	49.0	3.3	21.7	74
2159.500000	53.8	100.0	H	137.0	50.2	3.6	20.2	74
2650.000000	55.1	200.0	V	143.0	49.7	5.4	18.9	74

Remark: 1. Correction Factor = Antenna factor+ Insertion loss (cable loss + amplifier gain)

Frequency (MHz)	Average (dBuV/m)	Height (cm)	Polarization	Azimuth (deg)	Reading value (dBuV/m)	Correct Factor (dB)	Margin (dB)	Limit (dBuV/m)
1008.000000	39.0	200.0	H	225.0	41.1	-2.1	15.0	54
1430.500000	38.4	100.0	V	120.0	38.7	-0.3	15.6	54
1584.000000	40.0	100.0	H	40.0	39.3	0.7	14.0	54
2016.000000	44.4	200.0	V	174.0	41.8	2.6	9.6	54
2160.000000	48.3	100.0	H	137.0	44.7	3.6	5.7	54
2784.500000	43.6	200.0	H	172.0	37.9	5.7	10.4	54

Remark: 1. Correction Factor = Antenna factor+ Insertion loss (cable loss + amplifier gain)

MIMO

802.11n (HT20) CH1

FCC RE 1G-3GHz PK+AV Class B

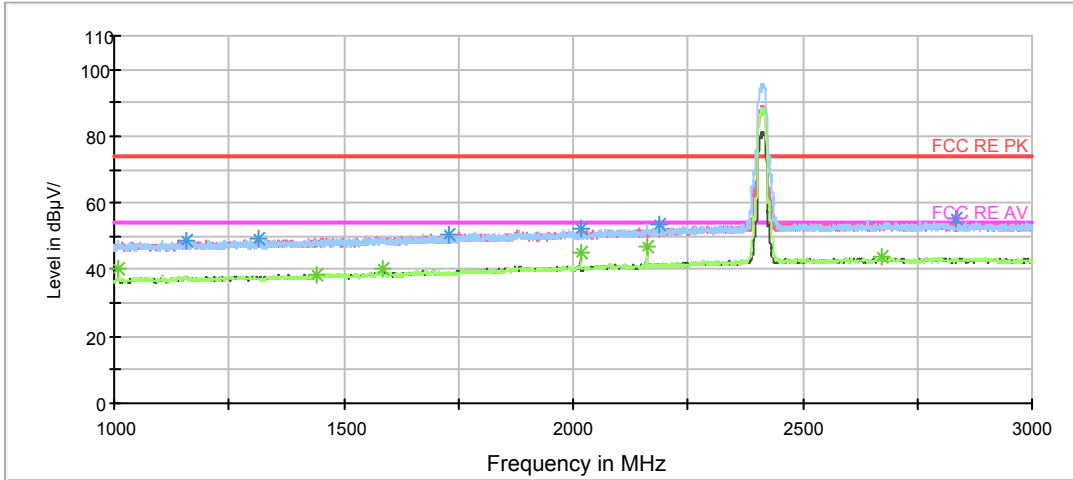

Note: The signal beyond the limit is carrier.
Radiates Emission from 1GHz to 3GHz

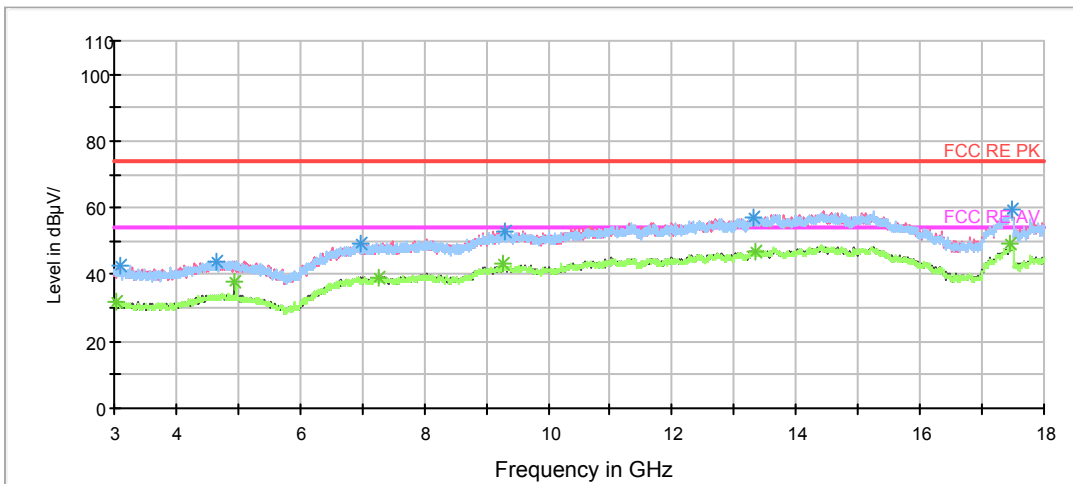

Radiates Emission from 3GHz to 18GHz



Frequency (MHz)	Peak (dBuV/m)	Height (cm)	Polarization	Azimuth (deg)	Reading value (dBuV/m)	Correct Factor (dB)	Margin (dB)	Limit (dBuV/m)
1155.500000	48.9	100.0	H	0.0	50.0	-1.1	25.1	74
1315.500000	49.3	100.0	V	0.0	50.2	-0.9	24.7	74
1731.000000	50.5	200.0	H	313.0	49.4	1.1	23.5	74
2015.500000	52.0	100.0	H	113.0	49.4	2.6	22.0	74
2187.000000	53.7	100.0	V	252.0	49.8	3.9	20.3	74
2832.500000	55.1	100.0	V	121.0	49.5	5.6	18.9	74

Remark: 1. Correction Factor = Antenna factor+ Insertion loss (cable loss + amplifier gain)

Frequency (MHz)	Average (dBuV/m)	Height (cm)	Polarization	Azimuth (deg)	Reading value (dBuV/m)	Correct Factor (dB)	Margin (dB)	Limit (dBuV/m)
1007.500000	40.6	200.0	H	58.0	42.7	-2.1	13.4	54
1440.000000	38.6	200.0	H	0.0	38.9	-0.3	15.4	54
1584.000000	40.5	200.0	H	217.0	39.8	0.7	13.5	54
2016.000000	44.8	200.0	H	112.0	42.2	2.6	9.2	54
2160.000000	47.0	200.0	H	321.0	43.4	3.6	7.0	54
2671.500000	43.7	100.0	H	228.0	38.1	5.6	10.3	54

Remark: 1. Correction Factor = Antenna factor+ Insertion loss (cable loss + amplifier gain)

802.11n (HT20) CH6

FCC RE 1G-3GHz PK+AV Class B

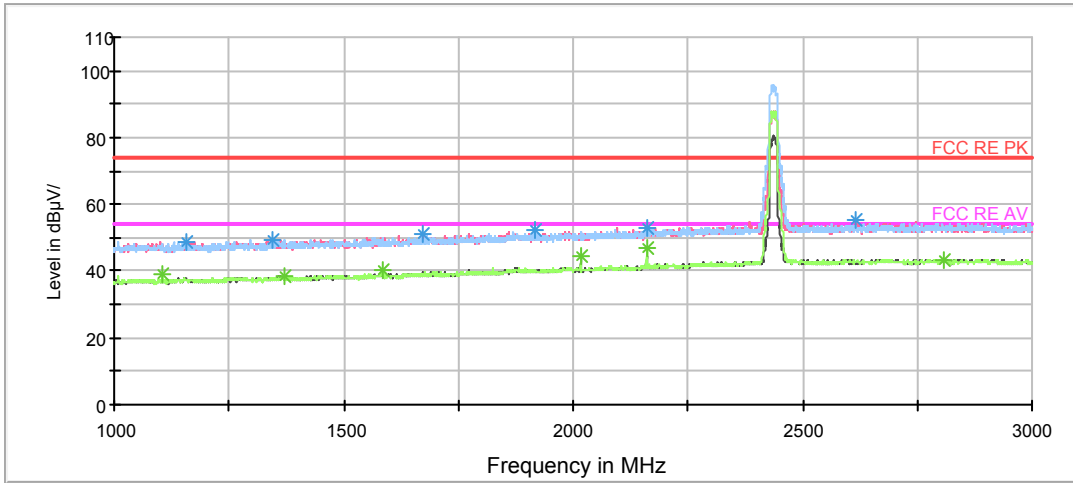

Note: The signal beyond the limit is carrier.
Radiates Emission from 1GHz to 3GHz

FCC RE 1G-18GHz PK+AV Class B

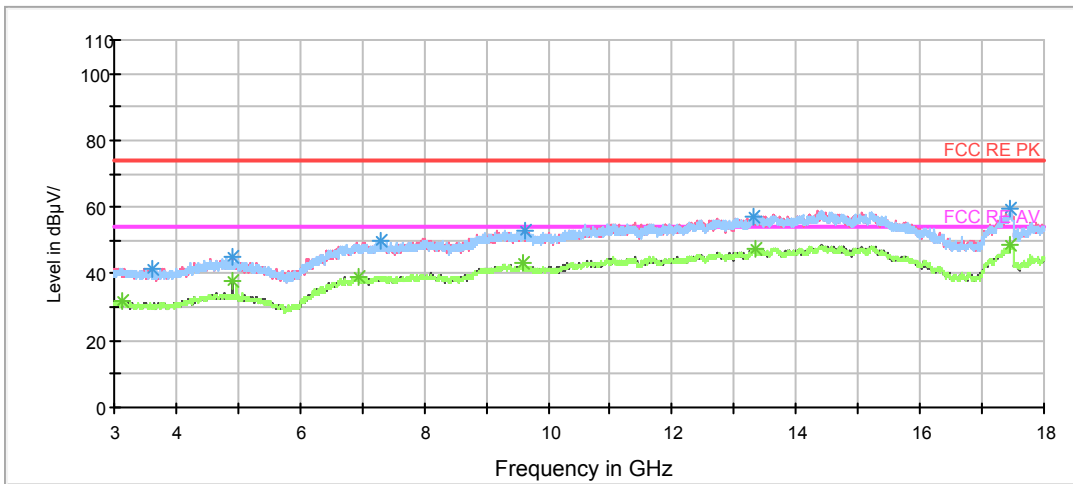

Radiates Emission from 3GHz to 18GHz



Frequency (MHz)	Peak (dBuV/m)	Height (cm)	Polarization	Azimuth (deg)	Reading value (dBuV/m)	Correct Factor (dB)	Margin (dB)	Limit (dBuV/m)
1158.000000	48.9	100.0	V	93.0	50.1	-1.2	25.1	74
1346.000000	49.5	100.0	V	330.0	50.1	-0.6	24.5	74
1673.500000	51.0	100.0	V	0.0	49.9	1.1	23.0	74
1915.000000	52.2	200.0	H	199.0	50.0	2.2	21.8	74
2163.000000	53.0	200.0	V	321.0	49.3	3.7	21.0	74
2615.000000	55.5	200.0	V	106.0	50.1	5.4	18.5	74

Remark: 1. Correction Factor = Antenna factor+ Insertion loss (cable loss + amplifier gain)

Frequency (MHz)	Average (dBuV/m)	Height (cm)	Polarization	Azimuth (deg)	Reading value (dBuV/m)	Correct Factor (dB)	Margin (dB)	Limit (dBuV/m)
1104.000000	38.9	200.0	H	102.0	40.6	-1.7	15.1	54
1371.000000	38.5	200.0	V	176.0	38.8	-0.3	15.5	54
1584.000000	40.3	200.0	H	182.0	39.6	0.7	13.7	54
2016.000000	44.2	100.0	H	97.0	41.6	2.6	9.8	54
2160.000000	46.9	200.0	H	330.0	43.3	3.6	7.1	54
2806.500000	43.5	100.0	V	296.0	37.7	5.8	10.5	54

Remark: 1. Correction Factor = Antenna factor+ Insertion loss (cable loss + amplifier gain)

802.11n (HT20) CH11

FCC RE 1G-3GHz PK+AV Class B

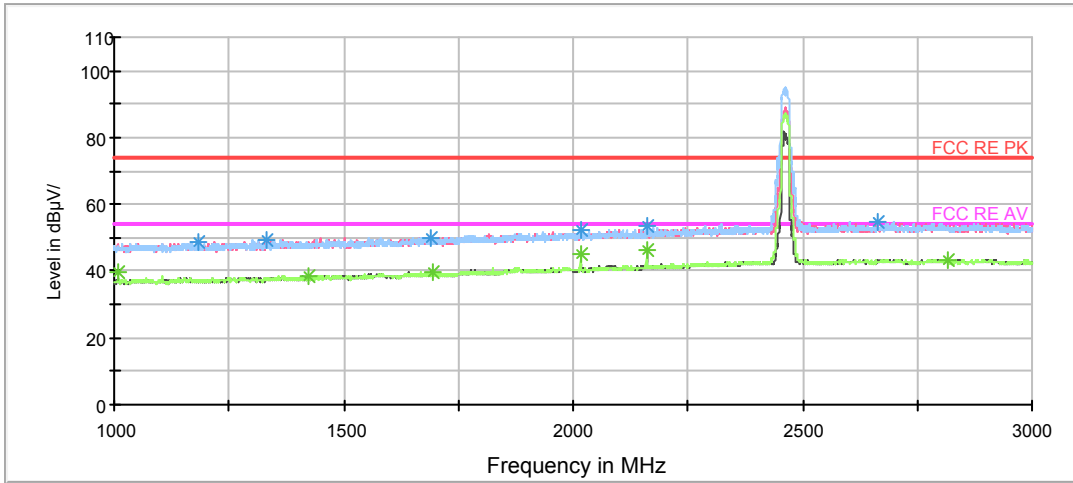

Note: The signal beyond the limit is carrier.
Radiates Emission from 1GHz to 3GHz

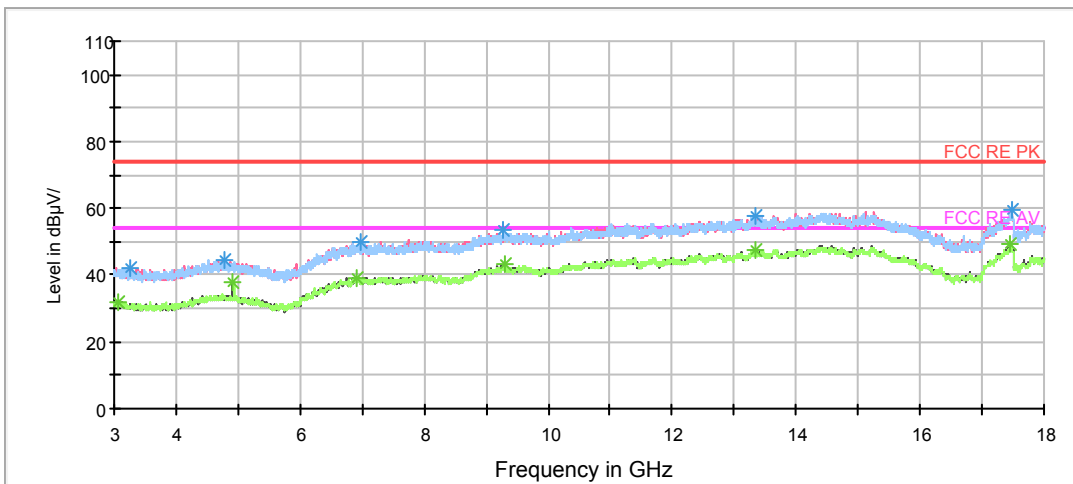

Radiates Emission from 3GHz to 18GHz



Frequency (MHz)	Peak (dBuV/m)	Height (cm)	Polarization	Azimuth (deg)	Reading value (dBuV/m)	Correct Factor (dB)	Margin (dB)	Limit (dBuV/m)
1185.500000	48.6	200.0	V	26.0	50.0	-1.4	25.4	74
1334.000000	49.5	200.0	V	115.0	50.3	-0.8	24.5	74
1688.000000	50.2	200.0	H	281.0	49.1	1.1	23.8	74
2016.000000	52.1	100.0	V	173.0	49.5	2.6	21.9	74
2160.000000	53.5	200.0	H	228.0	49.9	3.6	20.5	74
2664.500000	54.7	100.0	H	185.0	49.2	5.5	19.3	74

Remark: 1. Correction Factor = Antenna factor+ Insertion loss (cable loss + amplifier gain)

Frequency (MHz)	Average (dBuV/m)	Height (cm)	Polarization	Azimuth (deg)	Reading value (dBuV/m)	Correct Factor (dB)	Margin (dB)	Limit (dBuV/m)
1008.000000	39.9	200.0	H	220.0	42.0	-2.1	14.1	54
1424.000000	38.5	200.0	H	105.0	39.0	-0.5	15.5	54
1696.000000	39.8	200.0	V	80.0	38.5	1.3	14.2	54
2016.000000	45.3	200.0	H	299.0	42.7	2.6	8.7	54
2160.000000	46.4	100.0	H	115.0	42.8	3.6	7.6	54
2815.500000	43.4	100.0	V	0.0	37.8	5.6	10.6	54

Remark: 1. Correction Factor = Antenna factor+ Insertion loss (cable loss + amplifier gain)

SISO Antenna 1
802.11n (HT40) CH3

FCC RE 1G-3GHz PK+AV Class B

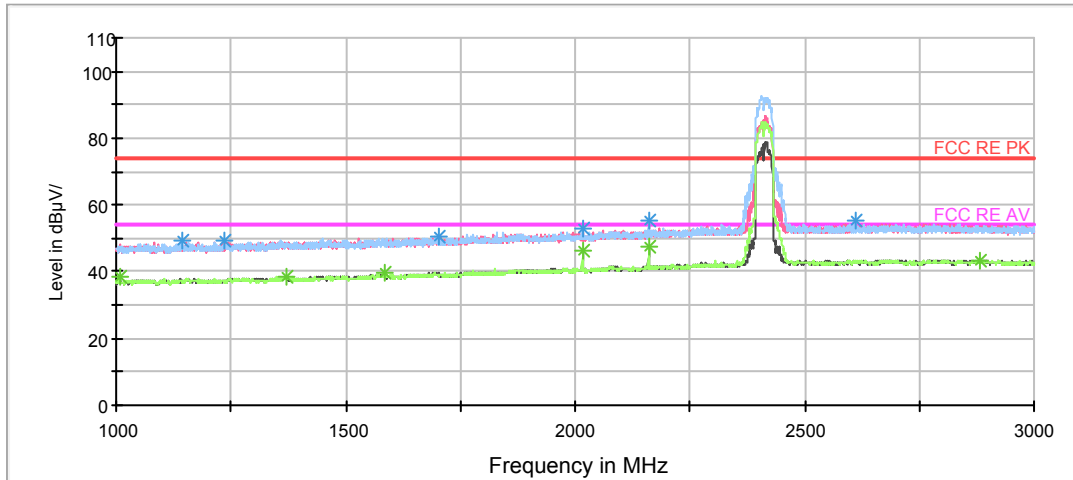

Note: The signal beyond the limit is carrier.
Radiates Emission from 1GHz to 3GHz

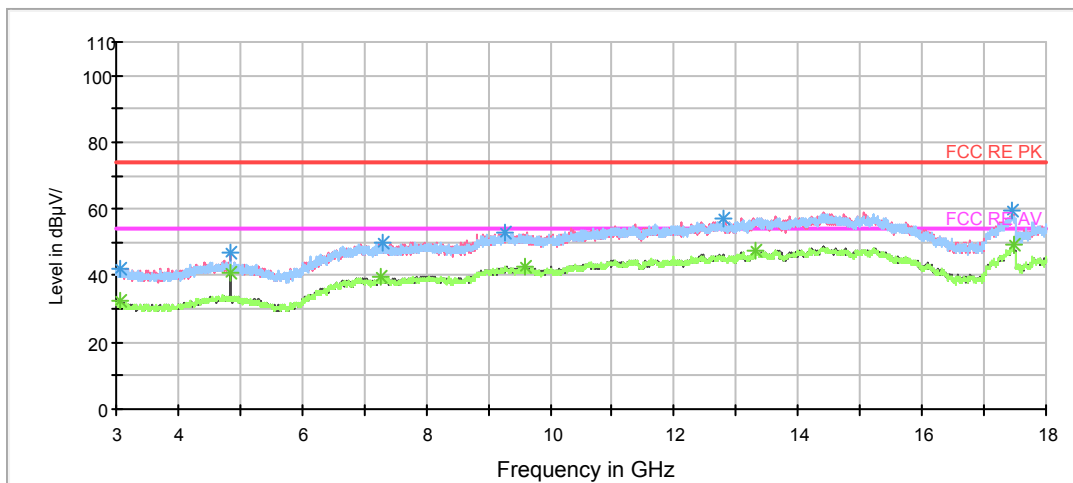

Radiates Emission from 3GHz to 18GHz



Frequency (MHz)	Peak (dBuV/m)	Height (cm)	Polarization	Azimuth (deg)	Reading value (dBuV/m)	Correct Factor (dB)	Margin (dB)	Limit (dBuV/m)
1143.500000	49.5	200.0	H	356.0	51.0	-1.5	24.5	74
1237.500000	49.1	200.0	V	0.0	50.3	-1.2	24.9	74
1702.500000	50.8	200.0	V	125.0	49.6	1.2	23.2	74
2016.000000	52.6	100.0	H	66.0	50.0	2.6	21.4	74
2160.500000	55.2	100.0	H	145.0	51.6	3.6	18.8	74
2611.500000	55.4	200.0	H	315.0	50.0	5.4	18.6	74

Remark: 1. Correction Factor = Antenna factor+ Insertion loss (cable loss + amplifier gain)

Frequency (MHz)	Average (dBuV/m)	Height (cm)	Polarization	Azimuth (deg)	Reading value (dBuV/m)	Correct Factor (dB)	Margin (dB)	Limit (dBuV/m)
1007.500000	38.6	100.0	H	58.0	40.7	-2.1	15.4	54
1371.500000	38.4	200.0	H	68.0	38.7	-0.3	15.6	54
1583.500000	39.8	100.0	H	172.0	39.1	0.7	14.2	54
2016.000000	46.5	100.0	H	66.0	43.9	2.6	7.5	54
2160.000000	47.3	100.0	V	158.0	43.7	3.6	6.7	54
2880.500000	43.6	200.0	V	178.0	37.8	5.8	10.4	54

Remark: 1. Correction Factor = Antenna factor+ Insertion loss (cable loss + amplifier gain)

802.11n (HT40) CH6

FCC RE 1G-3GHz PK+AV Class B

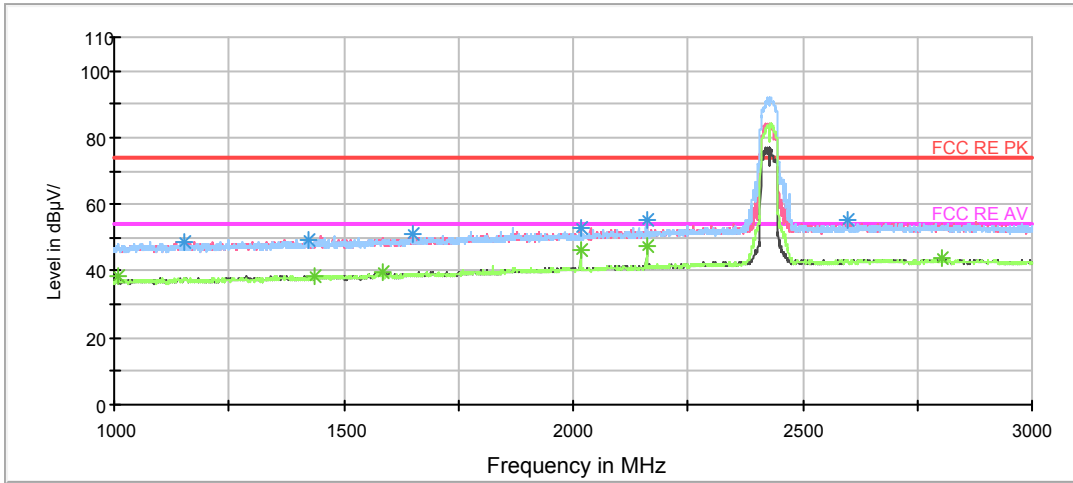

Note: The signal beyond the limit is carrier.
Radiates Emission from 1GHz to 3GHz

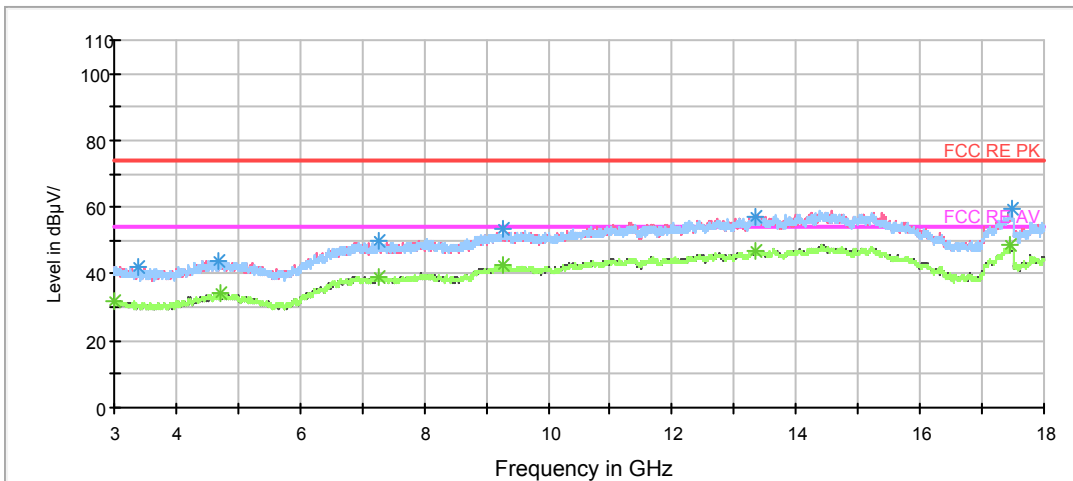

Radiates Emission from 3GHz to 18GHz



Frequency (MHz)	Peak (dBuV/m)	Height (cm)	Polarization	Azimuth (deg)	Reading value (dBuV/m)	Correct Factor (dB)	Margin (dB)	Limit (dBuV/m)
1152.000000	48.6	200.0	H	228.0	49.9	-1.3	25.4	74
1424.500000	49.3	100.0	H	148.0	49.8	-0.5	24.7	74
1649.500000	50.8	200.0	H	148.0	49.8	1.0	23.2	74
2016.000000	53.1	100.0	H	60.0	50.5	2.6	20.9	74
2160.000000	55.2	100.0	H	130.0	51.6	3.6	18.8	74
2599.000000	55.1	100.0	H	210.0	49.6	5.5	18.9	74

Remark: 1. Correction Factor = Antenna factor+ Insertion loss (cable loss + amplifier gain)

Frequency (MHz)	Average (dBuV/m)	Height (cm)	Polarization	Azimuth (deg)	Reading value (dBuV/m)	Correct Factor (dB)	Margin (dB)	Limit (dBuV/m)
1007.500000	38.3	200.0	H	148.0	40.4	-2.1	15.7	54
1436.500000	38.5	100.0	H	78.0	38.8	-0.3	15.5	54
1584.000000	39.6	100.0	H	5.0	38.9	0.7	14.4	54
2016.000000	46.1	200.0	V	3.0	43.5	2.6	7.9	54
2160.000000	47.4	200.0	V	183.0	43.8	3.6	6.6	54
2802.000000	43.6	200.0	H	291.0	37.8	5.8	10.4	54

Remark: 1. Correction Factor = Antenna factor+ Insertion loss (cable loss + amplifier gain)

802.11n (HT40) CH9

FCC RE 1G-3GHz PK+AV Class B

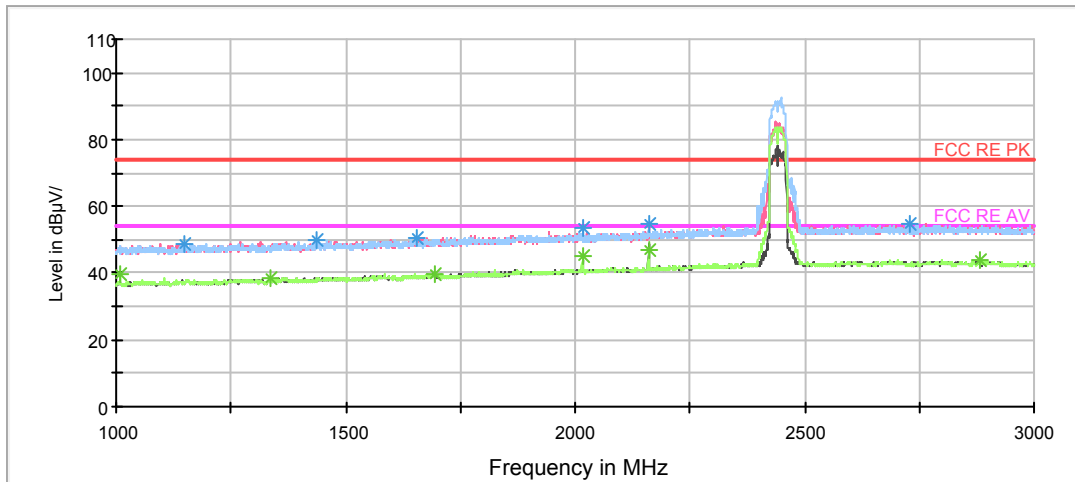

Note: The signal beyond the limit is carrier.
Radiates Emission from 1GHz to 3GHz

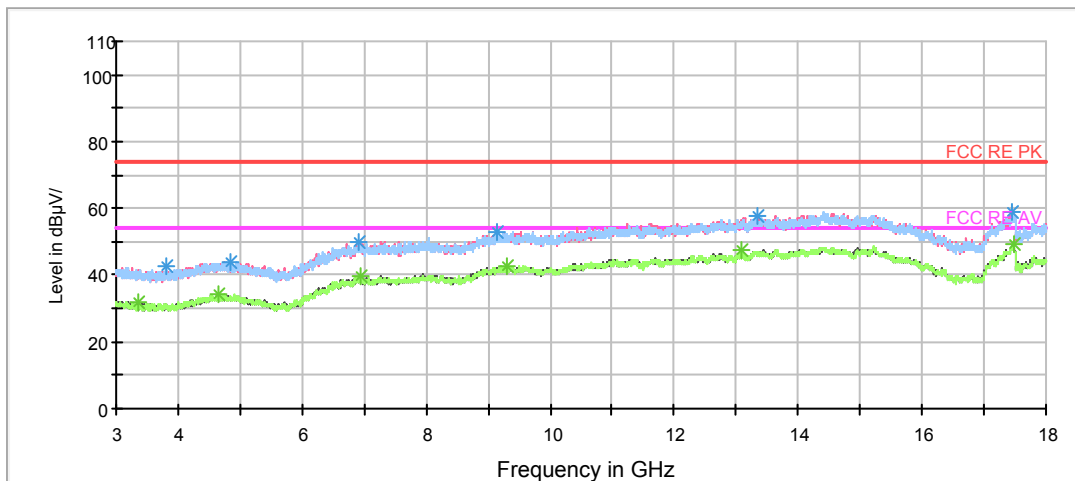

Radiates Emission from 3GHz to 18GHz



Frequency (MHz)	Peak (dBuV/m)	Height (cm)	Polarization	Azimuth (deg)	Reading value (dBuV/m)	Correct Factor (dB)	Margin (dB)	Limit (dBuV/m)
1149.500000	48.6	100.0	V	147.0	50.0	-1.4	25.4	74
1436.000000	50.1	100.0	H	131.0	50.4	-0.3	23.9	74
1654.000000	50.8	100.0	H	0.0	49.8	1.0	23.2	74
2016.500000	53.5	200.0	H	298.0	50.9	2.6	20.5	74
2160.500000	54.5	100.0	V	183.0	50.9	3.6	19.5	74
2728.000000	54.6	100.0	H	140.0	49.2	5.4	19.4	74

Remark: 1. Correction Factor = Antenna factor+ Insertion loss (cable loss + amplifier gain)

Frequency (MHz)	Average (dBuV/m)	Height (cm)	Polarization	Azimuth (deg)	Reading value (dBuV/m)	Correct Factor (dB)	Margin (dB)	Limit (dBuV/m)
1008.000000	39.5	200.0	H	219.0	41.6	-2.1	14.5	54
1335.500000	38.6	200.0	V	6.0	39.4	-0.8	15.4	54
1696.000000	39.7	100.0	H	158.0	38.4	1.3	14.3	54
2016.000000	45.2	200.0	H	298.0	42.6	2.6	8.8	54
2160.500000	47.0	100.0	V	183.0	43.4	3.6	7.0	54
2880.500000	43.8	200.0	H	307.0	38.0	5.8	10.2	54

Remark: 1. Correction Factor = Antenna factor+ Insertion loss (cable loss + amplifier gain)

5.2. Conducted Emission

Ambient condition

Temperature	Relative humidity	Pressure
23°C ~25°C	45%~50%	101.5kPa

Methods of Measurement

The EUT is placed on a non-metallic table of 80cm height above the horizontal metal reference ground plane. During the test, the EUT was operating in its typical mode. The test method is according to ANSI C63.10-2013. Connect the AC power line of the EUT to the L.I.S.N. Use EMI receiver to detect the average and Quasi-peak value. RBW is set to 9 kHz, VBW is set to 30kHz. The measurement result should include both L line and N line.

The test is in transmitting mode.

Test Setup

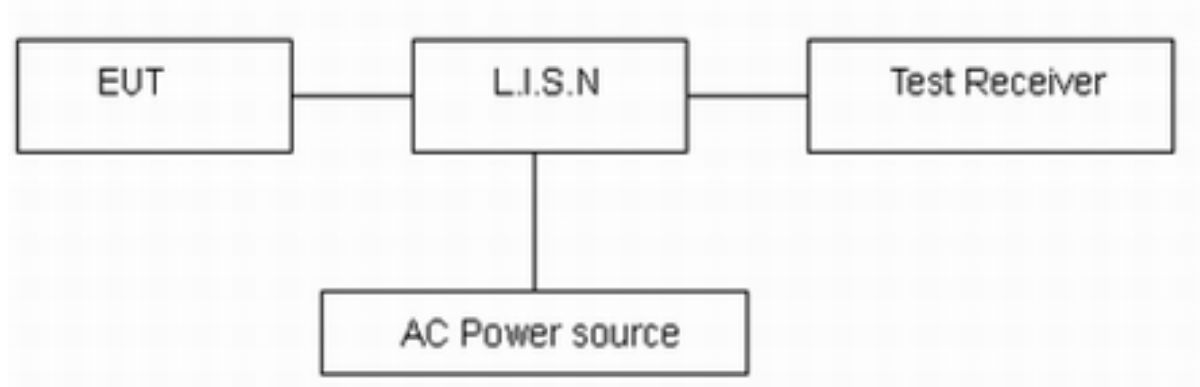

Note: AC Power source is used to change the voltage 110V/60Hz.

Limits

Frequency (MHz)	Conducted Limits(dBμV)	
	Quasi-peak	Average
0.15 - 0.5	66 to 56 *	56 to 46 *
0.5 - 5	56	46
5 - 30	60	50

*: Decreases with the logarithm of the frequency.

Measurement Uncertainty

The assessed measurement uncertainty to ensure 95% confidence level for the normal distribution is with the coverage factor $k = 1.96$, $U = 2.69$ dB.

Test Results:

Following plots, Blue trace uses the peak detection and Green trace uses the average detection. During the test, the Conducted Emission was performed in all channels, 802.11b, Channel 11 are selected as the worst condition. The test data of the worst-case condition was recorded in this report.

Full Spectrum

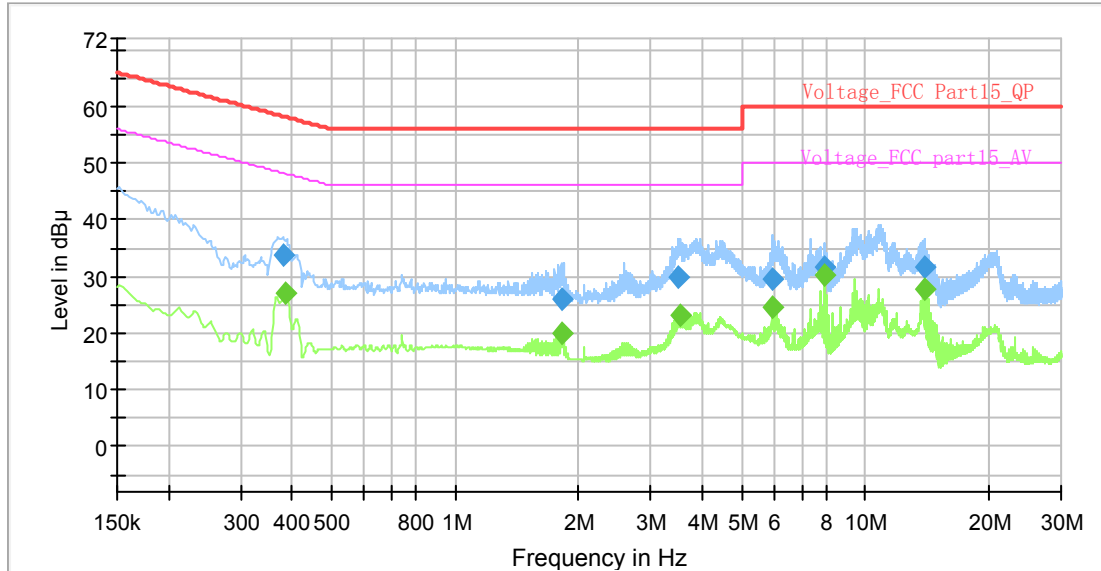

Final Result

Frequency (MHz)	QuasiPeak (dB μV)	Average (dB μV)	Limit (dB μV)	Margin (dB)	Meas. Time (ms)	Bandwidth (kHz)	Line	Filter	Corr. (dB)
0.379500	33.68	---	58.29	24.61	1000.0	9.000	L1	ON	19.2
0.386250	---	27.11	48.14	21.04	1000.0	9.000	L1	ON	19.2
1.812750	---	20.10	46.00	25.90	1000.0	9.000	L1	ON	19.2
1.812750	25.89	---	56.00	30.11	1000.0	9.000	L1	ON	19.2
3.486750	30.03	---	56.00	25.97	1000.0	9.000	L1	ON	19.1
3.536250	---	23.16	46.00	22.84	1000.0	9.000	L1	ON	19.1
5.946000	29.54	---	60.00	30.46	1000.0	9.000	L1	ON	19.1
5.946000	---	24.59	50.00	25.41	1000.0	9.000	L1	ON	19.1
7.923750	31.65	---	60.00	28.35	1000.0	9.000	L1	ON	19.2
7.923750	---	30.32	50.00	19.68	1000.0	9.000	L1	ON	19.2
13.908750	---	27.90	50.00	22.10	1000.0	9.000	L1	ON	19.4
13.911000	31.65	---	60.00	28.35	1000.0	9.000	L1	ON	19.4

L line

Conducted Emission from 150 KHz to 30 MHz

Full Spectrum

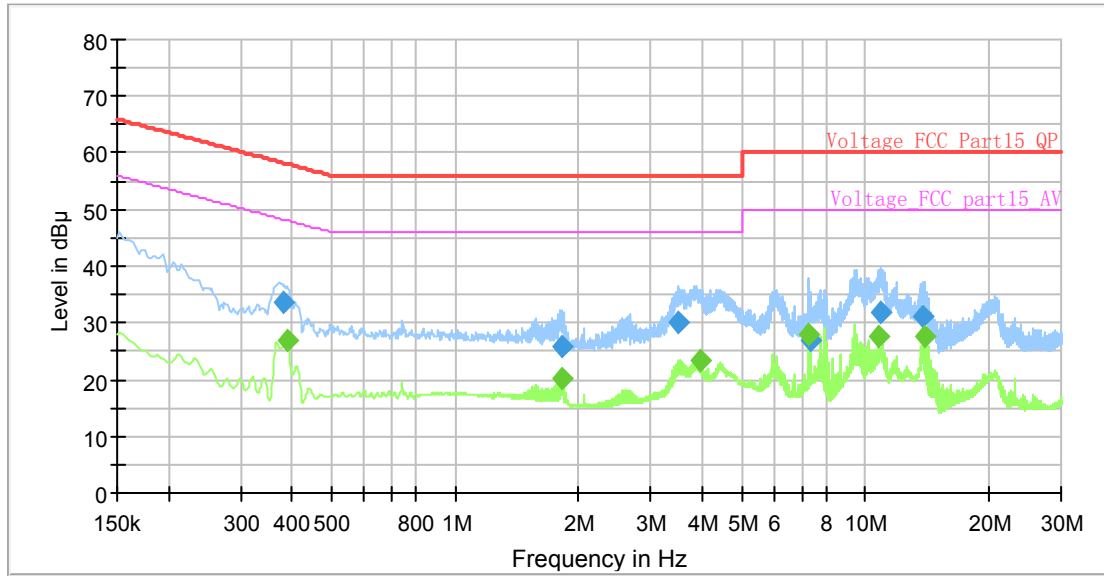

Final Result

Frequency (MHz)	QuasiPeak (dB μV)	Average (dB μV)	Limit (dB μV)	Margin (dB)	Meas. Time (ms)	Bandwidth (kHz)	Line	Filter	Corr. (dB)
0.379500	33.71	---	58.29	24.58	1000.0	9.000	N	ON	19.2
0.388500	---	27.06	48.10	21.04	1000.0	9.000	N	ON	19.2
1.812750	25.87	---	56.00	30.13	1000.0	9.000	N	ON	19.2
1.815000	---	20.17	46.00	25.83	1000.0	9.000	N	ON	19.2
3.486750	30.01	---	56.00	25.99	1000.0	9.000	N	ON	19.1
3.952500	---	23.39	46.00	22.61	1000.0	9.000	N	ON	19.0
7.300500	---	28.05	50.00	21.95	1000.0	9.000	N	ON	19.2
7.325250	26.74	---	60.00	33.26	1000.0	9.000	N	ON	19.2
10.792500	---	27.76	50.00	22.24	1000.0	9.000	N	ON	19.4
10.920750	31.95	---	60.00	28.05	1000.0	9.000	N	ON	19.4
13.807500	31.10	---	60.00	28.90	1000.0	9.000	N	ON	19.4
13.911000	---	27.78	50.00	22.22	1000.0	9.000	N	ON	19.4

N line

Conducted Emission from 150 KHz to 30 MHz



6. Main Test Instruments

Name	Manufacturer	Type	Serial Number	Calibration Date	Expiration Date
Spectrum Analyzer	R&S	FSV30	100815	2017-12-17	2018-12-16
EMI Test Receiver	R&S	ESCI	100948	2018-05-20	2019-05-19
Loop Antenna	SCHWARZBECK	FMZB1519	1519-047	2017-09-26	2019-09-25
TRILOG Broadband Antenna	Schwarzbeck	VULB 9163	9163-201	2017-11-18	2019-11-17
Double Ridged Waveguide Horn Antenna	R&S	HF907	100126	2018-07-07	2020-07-06
Standard Gain Horn	ETS-Lindgren	3160-09	00102643	2018-06-20	2020-06-19
EMI Test Receiver	R&S	ESR	101667	2018-05-20	2019-05-19
LISN	R&S	ENV216	101171	2016-12-16	2019-12-15
Spectrum Analyzer	Agilent	N9010A	MY47191109	2018-05-20	2019-05-19
RF Cable	Agilent	SMA 15cm	0001	/	/
Software	R&S	EMC32	9.26.0	/	/

*****END OF REPORT *****